



Aalborg Universitet

AALBORG UNIVERSITY
DENMARK

Model predictive control for a thermostatic controlled system

Shafiei, Seyed Ehsan; Rasmussen, Henrik; Stoustrup, Jakob

Published in:
Proceedings of the European Control Conference

Publication date:
2013

Document Version
Early version, also known as pre-print

[Link to publication from Aalborg University](#)

Citation for published version (APA):
Shafiei, S. E., Rasmussen, H., & Stoustrup, J. (2013). Model predictive control for a thermostatic controlled system. In *Proceedings of the European Control Conference* (pp. 1559-1564). IEEE Press.
<http://ieeexplore.ieee.org/xpl/articleDetails.jsp?tp=&arnumber=6669414&queryText%3DModel+predictive+contro+l+for+a+thermostatic+controlled+system>

General rights

Copyright and moral rights for the publications made accessible in the public portal are retained by the authors and/or other copyright owners and it is a condition of accessing publications that users recognise and abide by the legal requirements associated with these rights.

- ? Users may download and print one copy of any publication from the public portal for the purpose of private study or research.
- ? You may not further distribute the material or use it for any profit-making activity or commercial gain
- ? You may freely distribute the URL identifying the publication in the public portal ?

Take down policy

If you believe that this document breaches copyright please contact us at vbn@aub.aau.dk providing details, and we will remove access to the work immediately and investigate your claim.

Model Predictive Control for a Thermostatic Controlled System*

Seyed Ehsan Shafiei, Henrik Rasmussen and Jakob Stoustrup

Abstract—This paper proposes a model predictive control scheme to provide temperature set-points to thermostatic controlled cooling units in refrigeration systems. The control problem is formulated as a convex programming problem to minimize the overall operating cost of the system. The foodstuff temperatures are estimated by reduced order observers and evaporation temperature is regulated by an algorithmic suction pressure control scheme. The method is applied to a validated simulation benchmark. The results show that even with the thermostatic control valves, there exists significant potential to reduce the operating cost.

I. INTRODUCTION

Increasing the energy demand, on one hand, and penetration of the intermittent renewable recourses into the electricity grid, on the other hand, enforce a lot of researches to cope with the current and the future challenges. Control theory has been proven to be able to offer strong solutions for various problems regarding from the production units to the end-point consumers.

To be able to implement advanced cost efficient control algorithms, some systems need significant redesigns like hardware replacements, system reconfiguration, software changes, etc. Hysteresis controllers that regulate the controllable variables within hysteresis bounds can be found in various process systems like a thermostatic controller that regulate the temperature in a cooling unit. So, it would be more cost effective if we can implement the advanced control methods without replacing these simple local controllers by more expensive ones. This paper proposes a solution for such a control problem in refrigeration systems.

Model predictive control (MPC) has successfully been applied to refrigeration systems for intending different kinds of improvements. With hybrid system formulation, MPC was employed in [1], [2] and [3] to solve the synchronization problem in display cases that causes wearing of the compressors. Fallahsohi, *et al* in [4] applied predictive functional control to minimize the superheat in an evaporator. For multi-evaporator systems, a decentralized MPC was proposed to control the cooling capacity of each evaporator [5].

There are also valuable researches that use MPC to reduce the energy consumption and/or electricity cost. A nonlinear predictive control scheme was designed in [6] to reduce the total power consumption of the compressor in a vapor compression cycle. The cooling capacity is regulated by a variable speed compressor. But this method cannot be applied

directly to the refrigeration systems with different cooling units in which the cooling capacity is regulated by expansion valves as well. As a thorough study that proposes a MPC to reduce the operating cost of such systems, we can point to [7]. But it replaced the hysteresis control valves with the floating point control ones for implementation. Moreover, the nonlinear optimization tool employed to handle a nonconvex cost function imposes a heavy computation burden into the control system.

This paper proposes a MPC for thermostatic controlled cooling units in commercial refrigeration systems. To deal with nonlinear dynamics of the cooling units, the cooling capacity is treated as a fictitious manipulated variable by which we can formulate the standard linear system dynamics for each cooling unit. A simple efficient algorithm, proposed by the authors in [8], is slightly modified and employed for set-point control of the suction pressures. The predictions of the electricity price and the outdoor temperature are used in the MPC formulation. In order to preserve food temperatures within the permissible range, a reduced order observer is designed to estimate those temperatures for each cooling unit. Finally, the formulated MPC is implemented using a convex programming on a validated simulation benchmark including several fridge and freezer display cases.

II. REFRIGERATION SYSTEM

Fig. 1 shows a typical refrigeration system with a booster configuration. The cooling section consists of a low temperature (LT) section including display cases and low stage compressor racks (COMP_LO), and a medium temperature section including freezing rooms and high stage compressor racks (COMP_HI). The air temperatures at the evaporator outlets are considered as controllable variables regulated by ON/OFF thermostatic control valves (EV_MT and EV_LT). A detailed thermodynamic analysis of such a booster configuration is explained in [9].

A. Display Case Dynamics

Considering energy balances, the heat transfers in display cases are described by the following equations based on a lumped temperature model.

$$MCp_{foods} \frac{dT_{foods}}{dt} = -\dot{Q}_{foods/cr} \quad (1)$$

$$MCp_{cr} \frac{dT_{cr}}{dt} = \dot{Q}_{load} + \dot{Q}_{foods/cr} - \dot{Q}_e \quad (2)$$

Where MCp denotes the corresponding mass multiplied by the heat capacity, and T_{cr} is the controllable air temperature

*This work is supported by the Southern Denmark Growth Forum and the European Regional Development Fund under the Project Smart & Cool.

Authors are with Section for Automation and Control, Department of Electronic Systems, Aalborg University, Aalborg, Denmark {ses, hr, jakob} at es.aau.dk

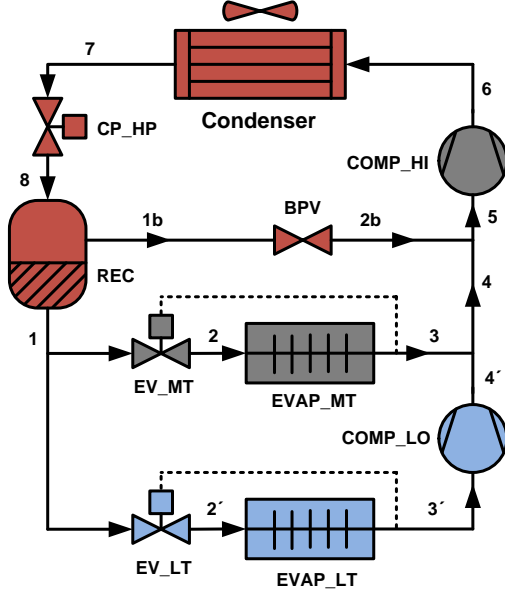

Fig. 1. Basic layout of a typical supermarket refrigeration system with booster configuration.

inside the cooling unit. $\dot{Q}_{foods/cr}$ is the heat transfer from food to cooled air,

$$\dot{Q}_{foods/cr} = UA_{foods/cr}(T_{foods} - T_{cr}), \quad (3)$$

\dot{Q}_{load} is the heat load due to indoor temperature, T_{indoor} ,

$$\dot{Q}_{load} = UA_{load}(T_{indoor} - T_{cr}), \quad (4)$$

and \dot{Q}_e is the heat transfer from cooled air to the circulated refrigerant,

$$\dot{Q}_e = \dot{m}_r(h_{oe} - h_{ie}), \quad (5)$$

where UA is the overall heat transfer coefficient, h_{oe} and h_{ie} are enthalpies at the outlet and the inlet of the evaporators which are nonlinear functions of the evaporation temperature (or equivalently suction pressure). The term \dot{m}_r denotes the mass flow of refrigerant into the evaporator described by the following equation:

$$\dot{m}_r = OD \text{ KvA} \sqrt{2\rho_{suc}(P_{rec} - P_{suc})10^5} \quad (6)$$

where OD stands for the opening degree of the valve with value between 0 (closed) to 1 (fully opened), P_{rec} and P_{suc} are receiver and suction pressures in [bar], ρ_{suc} is the density of the circulating refrigerant, and KvA denotes a constant characterizing the valve [10]. However, in case of thermostatic control, OD is only 0 or 1.

There is also a superheat controller operating on the valve when the valve state is ON ($OD = 1$). From the energy consumption point of view, and also regarding the control design in a supervisory level, the superheat control dynamics are negligible. So, here we have assumed a constant superheat degree for the model as explained by the authors in [11].

B. Power Consumption and COP

The electrical power consumption of each compressor bank is calculated by

$$\dot{W}_c = \frac{1}{\eta_{me}} \dot{m}_{ref}(h_{o,c} - h_{i,c}), \quad (7)$$

where \dot{m}_{ref} is the total mass flows into the compressor, and $h_{o,c}$ and $h_{i,c}$ are the enthalpies at the outlet and inlet of the compressor bank. These enthalpies are nonlinear functions of the refrigerant pressure and temperature at the calculation point. The constant η_{me} indicates overall mechanical/electrical efficiency considering mechanical friction losses and electrical losses [12]. The outlet enthalpy is computed by

$$h_{o,c} = h_{i,c} + \frac{1}{\eta_{is}}(h_{is} - h_{i,c}), \quad (8)$$

in which h_{is} is the outlet enthalpy when the compression process is isentropic, and η_{is} is the related isentropic efficiency given by [13] (neglecting higher order terms),

$$\eta_{is} = c_0 + c_1(f_c/100) + c_2(P_{c,o}/P_{suc}), \quad (9)$$

where f_c is the virtual compressor frequency (total capacity) of the compressor rack in percentage, $P_{c,o}$ is the pressure at compressor outlet, and c_i are constant coefficients.

The total coefficient of performance (COP) is defined as the ratio of total cooling capacity over the total power consumption of the compressors.

$$COP = \frac{\dot{Q}_{e,tot}}{\dot{W}_{c,tot}} \quad (10)$$

The COP is calculated by

$$COP = \frac{x_{MT}(h_{oe,MT} - h_{ie,MT}) + x_{LT}(h_{oe,LT} - h_{ie,LT})}{\frac{1}{\eta_{MT}}(h_{is,MT} - h_{i,c,MT}) + \frac{x_{LT}}{\eta_{LT}}(h_{is,LT} - h_{i,c,LT})}, \quad (11)$$

where indices MT and LT relate the calculated values to the medium and low temperature sections, respectively. Parameters x_{MT} and x_{LT} are the ratio of refrigerant mass flow of MT and LT evaporators to the total flow rate, and $\eta_{MT} = \eta_{me,MT} \eta_{is,MT}$ and $\eta_{LT} = \eta_{me,LT} \eta_{is,LT}$.

III. SET-POINT CONTROL

In the control structure illustrated in Fig. 2, the distributed controllers are responsible for regulating controllable variables to the values provided by the set-point control unit. Distributed controllers consist of thermostatic and PI controllers regulating the temperatures and compressors speeds, respectively. So, the desired set-points are the air temperatures of display cases and the suction pressures of LT and MT sections.

In general, providing optimal set-points for both the suction pressure and the display cases temperatures leads to solve a nonconvex optimization problem which imposes a heavy computational burden. To avoid this nonconvexity, we use a simple algorithm presented in [8] for the pressure set-points, and a new MPC scheme using convex programming for the temperature set-points. This leads to a nearly optimal solution.

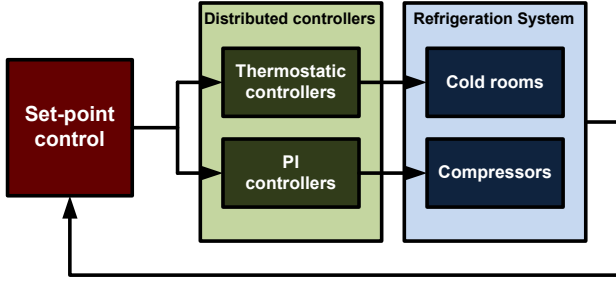

Fig. 2. Set-point control structure for refrigeration systems.

A. Algorithmic Pressure Control

The authors proposed a heuristic algorithm for the pressure set-point control using the fact that the near optimal pressure value will be achieved by increasing the suction pressure until one of the expansion valves is kept almost fully open [8]. Because of the ON and OFF states of the valves, we slightly modified the algorithm by taking the moving average of the opening degree for calculation of the maximum state between the valves.

A sampling time equal to one minute (for implementing this static control algorithm) ensures that the compressor speed is regulated to its steady-state value. Thus, the static model for the compressors are considered for the simulations [11]. The upper limit $P_{suc,max}$ gives a safety margin for the pressure difference required for circulating the refrigerant. The lower limit $P_{suc,min}$ is due to the limitations of the compressor total capacities, and also the safety issues regarding the high pressure difference.

Algorithm 1 Calculate the set-point value for each suction pressure

```

if  $P_{suc} < P_{suc,max}$  and  $\max(\mathbf{OD}_{avr}) < \delta_{max}$  then
  Increase the pressure set-point
else if  $P_{suc} > P_{suc,min}$  and  $\max(\mathbf{OD}_{avr}) > \delta_{min}$  then
  Decrease the pressure set-point
else
  Keep the previous set-point
end

```

In the above algorithm, \mathbf{OD}_{avr} is the moving average vector of opening degree of the expansion valves, and δ_{max} and δ_{min} are design parameter.

B. Model Predictive Control

Here, the control objective is to minimize the operating cost while respecting the imposed constraints. The economic objective function is simply formulated by the instantaneous energy cost as multiplication of the real-time electricity price $e_p(t)$ by the power consumption $\dot{W}_{c,tot}$ at given time t . So, the energy cost, J_{ec} is computed over the specified time interval $[T_0 \ T_N]$ as

$$J_{ec} = \int_{T_0}^{T_N} e_p \dot{W}_{c,tot} dt. \quad (12)$$

1) *Linear Model and Constraints:* Considering \dot{Q}_e in (2) as a fictitious input manipulated variable, we will have a linear system with the standard form,

$$\dot{x} = Ax + B_1u + B_2d \quad (13)$$

with the states $x = [T_{foods} \ T_{cr}]^T$, the input $u = \dot{Q}_e$, and the disturbance $d = T_{indoor}$. The parameters are

$$A = \begin{bmatrix} -\frac{UA_{foods/cr}}{MCP_{foods}} & \frac{UA_{foods/cr}}{MCP_{foods}} \\ \frac{UA_{foods/cr}}{MCP_{cr}} & -\frac{UA_{foods/cr} + UA_{load}}{MCP_{cr}} \end{bmatrix}, \quad (14)$$

and

$$B_1 = \begin{bmatrix} 0 \\ -\frac{1}{MCP_{cr}} \end{bmatrix}, \quad B_2 = \begin{bmatrix} 0 \\ \frac{UA_{load}}{MCP_{cr}} \end{bmatrix}. \quad (15)$$

System (13) is subjected to the constraints

$$T_{foods,min} \leq T_{foods} \leq T_{foods,max}, \quad (16)$$

and

$$0 \leq \dot{Q}_e \leq \dot{Q}_{e,max}, \quad (17)$$

where $T_{foods,min}$ and $T_{foods,max}$ are defined based on the type of foods in the display cases, and $\dot{Q}_{e,max}$ is calculated from (5) and (6) by putting $OD = 1$.

Note that the \dot{Q}_e in (17) is not directly applicable to the system. In [8], a supervisory MPC was formulated by incorporating the local controllers dynamics in the predictive model. Here, due the nonlinearity of the thermostatic action, we cannot formulate the same supervisory MPC. Instead, we propose a new MPC scheme for this purpose, where the fictitious input is used to one step prediction of the next temperature value, and then it is applied as the temperature set-point to the cooling unit. This practical point will be addressed in section III-B.3.

2) *Estimator Design:* In order to estimate the food temperature in each cooling unit, we design a reduced order observer [14, Ch. 8]. We rewrite (13) as

$$\begin{bmatrix} \dot{x}_1 \\ \dot{x}_2 \end{bmatrix} = \begin{bmatrix} a_{11} & a_{12} \\ a_{21} & a_{22} \end{bmatrix} \begin{bmatrix} x_1 \\ x_2 \end{bmatrix} + \begin{bmatrix} b_{11} & b_{12} \\ b_{21} & b_{22} \end{bmatrix} \begin{bmatrix} u \\ d \end{bmatrix}. \quad (18)$$

The reduced order observer is designed to estimate $x_1 = T_{foods}$ with the following estimator equation,

$$\dot{\hat{x}}_1 = A_o \hat{x}_1 + B_{o,1}u_o + B_{o,2}d + L(y_o - C_o \hat{x}_1), \quad (19)$$

where $A_o = a_{11}$, $B_{o,1} = [a_{12} \ b_{11}]$, $u_o = [x_2 \ u]^T$, $B_{o,2} = b_{12}$, $C_o = a_{21}$, and

$$y_o = \dot{x}_2 - a_{22}x_2 - b_{21}u - b_{22}d. \quad (20)$$

The observer gain L is defined based on the classical pole placement method. Implementation of the above estimator needs further considerations explained in [14, Ch. 8].

3) *MPC Design*: We use a discrete-time receding horizon approach, in which at each time step, an optimization problem is solved over a N -step prediction horizon. The result consists of the N moves of manipulated variables where the first one is applied as the MPC control law. So, for this MPC formulation, we should discretize the multivariable extension of system (13) with sampling time T_s which results in

$$x[k+1] = A_d x[k] + B_{d,1} u[k] + B_{d,2} d[k]. \quad (21)$$

with the discrete-time system matrices A_d , $B_{d,1}$ and $B_{d,2}$. The states are $x = [\hat{x}_1^T \ x_2^T]^T$ where \hat{x}_1 is the vector of estimated food temperatures and x_2 is the vector of air temperature.

To keep the optimization problem feasible in case of uncertain loads, the state constraint (22) is changed to the set of soft constraints

$$\begin{aligned} T_{min} - \varepsilon \Delta T_{foods} &\leq \hat{x}_1 \leq T_{max} + \varepsilon \Delta T_{foods} \\ \varepsilon &\geq 0 \end{aligned} \quad (22)$$

where the violations from temperature limits are penalized by adding the term $\rho_\varepsilon \varepsilon$ to the objective function. ΔT_{foods} and ρ_ε should be defined such that the violation occurs rarely. To avoid the temperature violation caused by state estimation error, a safety margin is imposed by defining $T_{min} = T_{foods,min} + T_{safe}$ and $T_{max} = T_{foods,max} - T_{safe}$.

The cost function (12) is rewritten using (10) as

$$J_{ec} = \sum_{k=0}^{N-1} \left\| e_p \frac{\dot{Q}_{e,tot}}{COP} \right\|_2^2, \quad (23)$$

where COP is given by (11), and $\dot{Q}_{e,tot} = \sum_{i=1}^m \dot{Q}_e^i$ with m indicating the number of display cases. In the next section, we will show how we can predict the COP by estimating it as a linear function depending on outdoor temperature. Now, the optimization problem is defined as

$$\begin{aligned} \underset{\dot{Q}_e, \varepsilon}{\text{minimize}} \quad & J_{ec} + J_{\Delta u} + \rho_\varepsilon \varepsilon \\ \text{subject to} \quad & \text{system dynamics (21)}, \\ & \text{state constraints (22)}, \\ & \text{input constraints (17)} \end{aligned} \quad (24)$$

with

$$J_{\Delta u} = \sum_{k=1}^{N-1} \left\| R_{\Delta u} (\dot{Q}_e[k] - \dot{Q}_e[k-1]) \right\|_2^2, \quad (25)$$

where $R_{\Delta u}$ is a diagonal matrix of tuning weights. The above objective function penalizes the rate of change of cooling capacity to avoid the oscillatory behavior in set-point commands. The tuning parameters are defined by considering two opposing objectives: cost and stability. From the cost point of view, the units (e.g. display cases) with larger costs of storing energy should be more penalized, and from the stability point of view, the units with faster dynamics should be assigned larger values for their corresponding weights in $R_{\Delta u}$.

At each time step a new set of control commands \dot{Q}_e are given by the above MPC. But as mention in section III-B.1, these commands are not directly applicable to the cooling units. So we use a predicted states ($T_{ref,cr} = x_2[k+1]$) by

updating (21) using the obtained \dot{Q}_e , and then apply them as temperature set-points to the corresponding cold rooms. The ON/OFF limits of thermostatic controllers are also set to the small values around the set-point. The proposed supervisory MPC is summed up in Algorithm 2.

Algorithm 2 Supervisory MPC including the economic cost in its objective function

Prediction

Load

COP and $T_{outdoor}$ from previous horizon
 e_p and $T_{outdoor}$ predictions

Compute

COP prediction based on its previous horizon values and $T_{outdoor}$

Solve

minimize $J_{ec} + J_{\Delta u} + \rho_\varepsilon \varepsilon$ (over the horizon)
 u, ε
subject to $x[k+1] = A_d x[k] + B_{d,1} u[k] + B_{d,2} d[k]$
 $\hat{x}_1 \geq T_{min} - \varepsilon \Delta T_{foods}$
 $\hat{x}_1 \leq T_{max} + \varepsilon \Delta T_{foods}$
 $\varepsilon \geq 0$
 $0 \leq u \leq \dot{Q}_{e,max}$

Update

$u[k]$ = first move in obtained u
 $x[k+1] = A_d x[k] + B_{d,1} u[k] + B_{d,2} d[k]$
 $T_{ref,cr} = x_2[k+1]$ where $x = [\hat{x}_1 \ x_2]^T$

IV. SIMULATION STUDY

In this section, the proposed method is applied to a high-fidelity simulation benchmark including 7 fridge display cases, 4 freezer display cases and cold room, and the two-stage compressor racks. The details of the model validation against real data are found in [11]. At first, we apply a traditional scenario in which the thermostat action occurs between the upper and the lower temperature limits. For a fair comparison, the pressure set-points are fixed to the maximum values. The designed MPC together with algorithmic pressure control are applied to the system.

A. Simulation Set-up

The outdoor temperature is obtained from an hourly measurement with linear interpolation between hours. The temperature prediction can for example be provided by the national meteorological institute, sometimes on a commercial basis. One week period of hourly el-spot price was downloaded from NordPool spot market [15]. Fig. 3 shows the $T_{outdoor}$ and e_p for 24 hours related to the upcoming results. In the simulations, we used a normalized version of the electricity prices and evaluate the results based on the percentage in reduction of the operating cost.

The estimator is designed as a digital observer with sampling time of 1 min where the observer poles are selected as follows.

$$P_o = [0.99, 0.995, 0.99, 0.99, 0.99, 0.99, 0.9, \dots, 0.999, 0.5, 0.999, 0.1]$$

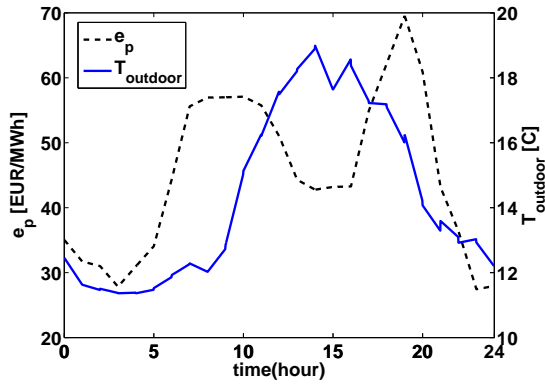

Fig. 3. Outdoor temperature (top) and electricity price (bottom).

Because of the slow dynamics of the cooling parts, the MPC sampling time is set to 15 min. A 24 h prediction horizon is considered which needs $N = 96$ samples for implementation. The tuning parameters are $\rho_e = 5$ and

$$R_{\Delta u} = \text{diag}(0.1, 0.1, 0.1, 0.1, 0.1, 0.05, 0.1, \dots, 0.0025, 0.01, 0.0025, 0.01),$$

with the first 7 elements for the fridge and the last 4 for the freezer units. The safety temperatures are chosen as $T_{safe} = 0.5^\circ\text{C}$ for display cases and $T_{safe} = 1^\circ\text{C}$ for freezing rooms. A 5 min moving average as well as $\gamma_{OD} = 0.9$ are used for the implementation of Algorithm 1. To solve the optimization problem (24) we used CVX, a package for specifying and solving convex programs [16], [17].

B. Simulation Results

Power consumption of the compressors, resulted from applying the traditional scenario explained before, is depicted in Fig. 4. The total energy consumption and corresponding electricity cost are $E_{tot} = 64$ [kWh] and $e_c = 32.5$. The air and food temperatures of the first and third fridge display cases are provided in Fig. 5 for a 6 h period. The trends are similar for the other units.

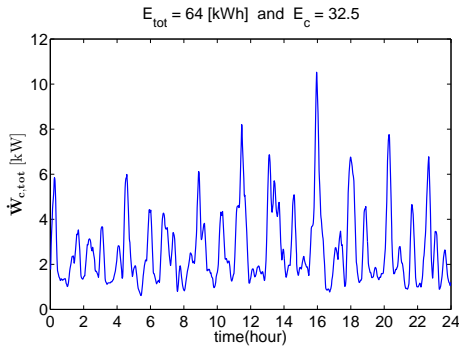

Fig. 4. Power consumption in case of traditional fixed set-point control.

Fig. 6 shows the power consumption after applying the designed MPC together with Algorithm 1. The energy consumption and operating cost are $E_{tot} = 50$ [kWh] and $e_c = 21.4$ (34% reduction) which are considerable reductions.

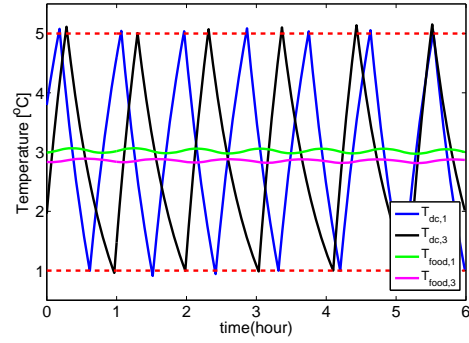

Fig. 5. Air temperatures of the first and third fridge display cases, T_{dc} , and the corresponding food temperatures. Dashed red lines indicate the temperature limits.

The actual food temperatures for fridge units are illustrated in Fig. 7. The details of the COP prediction with correlation to the outdoor temperature are explained in [8]. As can be seen from Fig. 3, around 3 h both e_p and $T_{outdoor}$ are low (the COP is high), so the supervisory control starts storing energy by lowering the temperatures while respecting the imposed constraints. Around 15 h, e_p is low but $T_{outdoor}$ is high (the COP is low), but the proposed control can handle this trade-off very well by storing some amount of energy in an optimal fashion.

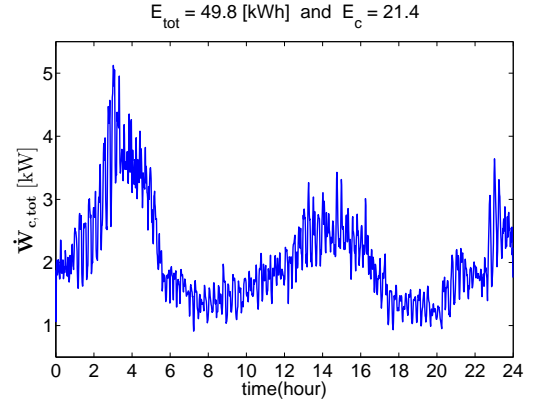

Fig. 6. Power consumption after applying MPC (Algorithm 2) together with algorithmic suction pressure control (Algorithm 1).

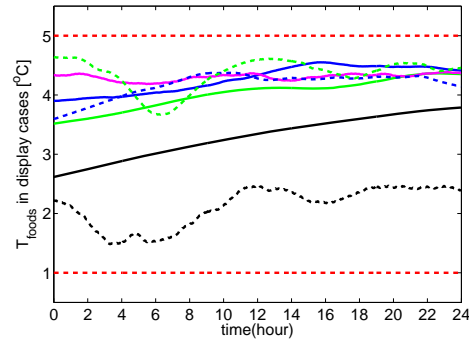

Fig. 7. Actual food temperatures in fridge display cases. The temperature limits for are [1, 5] except the lower one which is [1, 3].

The suction pressures for both low and medium temperature sections regulated by low and high stage compressor banks are shown in Fig. 8. The pressure related to MT

units is kept at the maximum level. It is because there is not a quick change in display case set-points that causes a quick variation in cooling capacity. Thus, the moving average of opening degree of the related valves do not exceed the decision value ($\gamma_{OD} = 0.9$). On the other hand, the pressure related to LT units is decreased by quickly increasing the request for cooling capacity due to quickly lowering the freezing room temperatures by MPC.

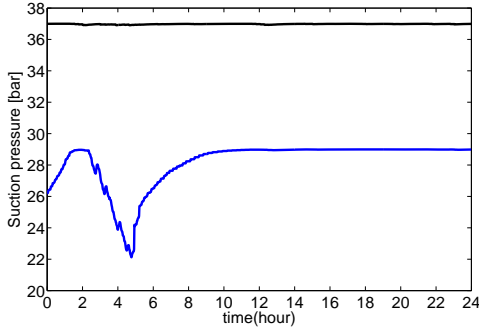

Fig. 8. Suction pressures of two LT and MT sections resulted from applying Algorithm 1.

The state estimation results given by the reduced order observer are provided in Fig. 9 for display cases 1, 3 and 7, and freezing rooms 1, 2 and 4. Some temperature plots show perfect estimations and a small ($0.5\text{ }^{\circ}\text{C}$) estimation error is seen in the second freezing room. The imposed safety margin in MPC state constraints can very well prevent the constraint violation in the presence of such estimation errors.

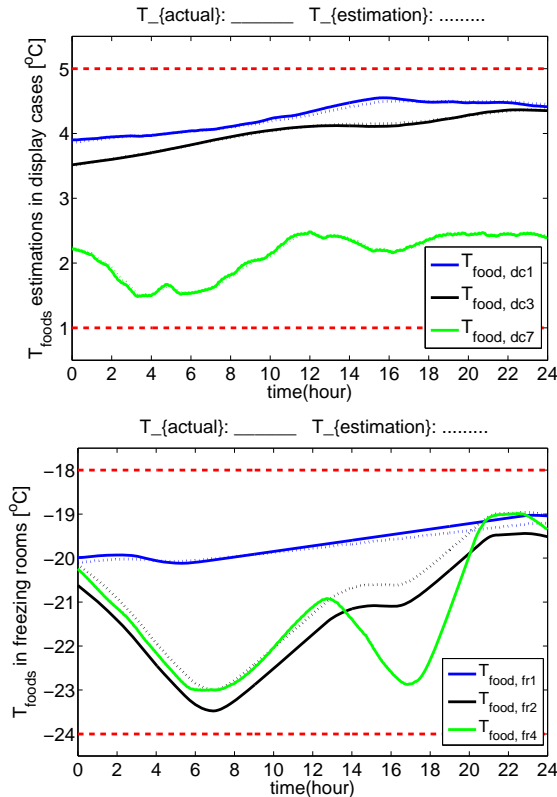

Fig. 9. Estimation of the food temperatures by reduced order observer. The imposed safety margin prevent the violation of temperature constraints due to the estimation error.

V. CONCLUSIONS

This paper presented a set-point control method for reducing the overall operating cost of a refrigeration system. A model predictive control algorithm was proposed to set-point control of the thermostatic controlled cooling units. In order to preserve food temperatures within the permissible range, a reduced order estimator was designed to estimate those temperatures. The formulated MPC was implemented by convex programming. Moreover, a simple and efficient algorithm was used for set-point control of the suction pressures. A considerable 34% cost reduction was obtained by applying the designed algorithms to a large scale refrigeration system including several display cases and freezing rooms.

REFERENCES

- [1] N. Ricker, "Predictive hybrid control of the supermarket process," *Control Engineering Practice*, vol. 18, pp. 608–617, 2010.
- [2] D. Sarabia, F. Capraro, L. Larsen, and C. Prada, "Hybrid nmpe of supermarket display cases," *Control Engineering Practice*, vol. 17, pp. 428–441, 2009.
- [3] C. Sonntag, A. Devanathan, S. Engell, and O. Stursberg, "Hybrid nonlinear model-predictive control of a supermarket refrigeration system," in *Proceedings of the 16th IEEE International Conference on Control Applications*, Singapore, Oct. 2007, pp. 1432–1437.
- [4] H. Fallahsohi, C. Changenet, and S. Placé, "Predictive functional control of an expansion valve for minimizing the superheat of an evaporator," *International journal of Refrigeration*, vol. 33, pp. 409–418, 2010.
- [5] M. Elliott and B. Rasmussen, "Model-based predictive control of a multi-evaporator vapor compression cooling cycle," in *proceeding of the 2008 American Control Conference*, Seattle, Washington, USA, Jun. 2008.
- [6] D. Leducq, J. Guilpart, and G. Trystram, "Non-linear predictive control of a vapor compression cycle," *International journal of Refrigeration*, vol. 29, pp. 761–772, 2006.
- [7] T. Hovgaard, L. Larsen, K. Edlund, and J. Jørgensen, "Model predictive control, technologies for efficient and flexible power consumption in refrigeration systems," *Energy*, vol. 44, pp. 105–116, 2012.
- [8] S. E. Shafiei, J. Stoustrup, and H. Rasmussen, "A supervisory control approach in economic mpc design for refrigeration systems," in *European Control Conference*, Zürich, Switzerland, Jul. 2013.
- [9] Y. T. Ge and S. A. Tassou, "Thermodynamic analysis of transcritical CO_2 booster refrigeration systems in supermarket," *Energy Conversion and Management*, vol. 52, pp. 1868–1875, 2011.
- [10] L. N. Petersen, H. Madsen, and C. Heerup, "Eso2 optimization of supermarket refrigeration systems," Technical University of Denmark, Department of Informatics and Mathematical Modeling, Tech. Rep., 2012.
- [11] S. E. Shafiei, H. Rasmussen, and J. Stoustrup, "Modeling supermarket refrigeration systems for supervisory control in smart grid," in *American Control Conference*, Washington DC, USA, Jun. 2013.
- [12] C. Pérez-Segarra, J. Rigola, M. Sòria, and A. Oliva, "Detailed thermodynamic characterization of hermetic reciprocating compressors," *International Journal of Refrigeration*, vol. 28, pp. 579–593, 2005.
- [13] R. Zhou and *et al.*, "The steady-state modeling and optimization of a refrigeration system for high heat flux removal," *Applied Thermal Engineering*, vol. 30, pp. 2347–2356, 2010.
- [14] G. Franklin, J. Powell, and M. Workman, *Digital Control of Dynamic Systems*. Ellis-Kagle Press, 1998.
- [15] "Nord pool spot," <http://www.nordpoolspot.com>.
- [16] I. CVX Research, "CVX: Matlab software for disciplined convex programming, version 2.0 beta," <http://cvxr.com/cvx>, Sep. 2012.
- [17] M. Grant and S. Boyd, "Graph implementations for nonsmooth convex programs," in *Recent Advances in Learning and Control*, ser. Lecture Notes in Control and Information Sciences, V. Blondel, S. Boyd, and H. Kimura, Eds. Springer-Verlag Limited, 2008, pp. 95–110, <http://stanford.edu/~boyd/graph.dcp.html>.