



Aalborg Universitet

AALBORG UNIVERSITY
DENMARK

Placement of Road Side Units for Floating Car Data Collection in Highway Scenario

Rashidi, Maryam; Batros, Iulian; Madsen, Tatiana Kozlova; Riaz, Tahir; Paulin, Thomas

Published in:

Proceedings of IV International Congress on Ultra Modern Telecommunications and Control Systems 2012

DOI (link to publication from Publisher):

[10.1109/ICUMT.2012.6459649](https://doi.org/10.1109/ICUMT.2012.6459649)

Publication date:

2012

Document Version

Accepted author manuscript, peer reviewed version

[Link to publication from Aalborg University](#)

Citation for published version (APA):

Rashidi, M., Batros, I., Madsen, T. K., Riaz, T., & Paulin, T. (2012). Placement of Road Side Units for Floating Car Data Collection in Highway Scenario. In *Proceedings of IV International Congress on Ultra Modern Telecommunications and Control Systems 2012* (pp. 114-118). IEEE Press.
<https://doi.org/10.1109/ICUMT.2012.6459649>

General rights

Copyright and moral rights for the publications made accessible in the public portal are retained by the authors and/or other copyright owners and it is a condition of accessing publications that users recognise and abide by the legal requirements associated with these rights.

- ? Users may download and print one copy of any publication from the public portal for the purpose of private study or research.
- ? You may not further distribute the material or use it for any profit-making activity or commercial gain
- ? You may freely distribute the URL identifying the publication in the public portal ?

Take down policy

If you believe that this document breaches copyright please contact us at vbn@aub.aau.dk providing details, and we will remove access to the work immediately and investigate your claim.

Placement of Road Side Units for Floating Car Data Collection in Highway Scenario

Maryam Rashidi*, Iulian Batros*, Tatiana K. Madsen*, Muhammad T. Riaz*, and Thomas Paulin[†]
{mrashi10, ibatro10}@student.aau.dk, {tatiana, tahir}@es.aau.dk, paulin@ftw.at

*Networking and Security, Department of Electronic Systems, Aalborg University, Denmark

[†]FTW Telecommunications Research Center, Vienna, Austria

Abstract—Floating car data (FCD) has been used to collect traffic state information from a set of individual vehicles. Vehicles are equipped with On Board Units (OBU) that collect different measurements and the vehicle position and transmit the data to a remote control center. In current implementations of FCD systems, vehicle fleets use cellular connections for data transmission. In this paper we consider an IEEE 802.11p-based Road Side Unit (RSU) infrastructure for FCD collection. Installing RSUs in order to acquire perfect coverage may prove to be a costly solution, while gaps between the coverage areas will force data buffering at OBUs. This might be a viable solution for delay-tolerant, but not for safety-critical applications that require high data delivery ratio. The goal of this paper is to study the trade-offs between the size of the gaps between RSUs and other system parameters such as data delivery ratio, data collection update interval and size of measured data. We have proposed some heuristics that can be used while deciding on the distance between neighboring RSUs.

I. INTRODUCTION

It is envisioned that Intelligent Transportation Systems (ITS) will support a wide range of applications and services targeting to improve the quality and the utilization of the transportation infrastructure, safety of the drivers as well as assisting drivers, bicyclists and pedestrians with relevant travel information [1]. Some of these applications rely on the availability of Floating Car Data (FCD): Vehicles will collect data about their drive parameters and their environment, e.g. speed, acceleration and any other out-car and in-car sensor readings. The measurements can be done periodically, either in time or space, or be triggered by an event, e.g. turning. Readings are tagged with a time-stamp and geographical coordinates that can be obtained e.g. by a GPS receiver.

FCD technology allows for central data collection where measured data is presented with a location tag. It gives possibilities for estimation of statistical vehicles flows, travel time estimation, differentiated road pricing and tolling and many other applications. E.g. traffic statistics used by road authorities for deriving maps with congestion levels, delays and average speeds can be obtained by post-processing collected

FCD. Generally, in this paper we would like to focus on delay-tolerant, not safety-critical applications of FCD where delay requirements are of an order of minutes.

Even though many systems for FCD collection are already implemented and are in use, it is far from having high penetration among vehicles. It requires installation of On Board Unit (OBU) for data collection purposes. Automotive manufactures are also interested in development of the technology as OBUs have a potential to become a standard in-car component [2]. Currently, only a few fleets, typically taxis or truck fleets, are equipped with OBUs that are typically based on proprietary solutions. An example of such installations is ITS platform project in Denmark [3]. Within this project OBU equipment is installed in 500 private cars providing good geographical coverage for the main areas of interest within North Jutland region. In this project OBU implementation has multiple communication interfaces, however GPRS is used for data collection. Overview of other FCD projects can be found in [4].

Using cellular connection as a last hop to a vehicle for massive data collection is a commonly used solution. Despite limited data-rates and costly subscriptions for cellular data, good coverage and well developed infrastructure are the main advantages of this approach. Another approach is to store all the collected measurements at an OBU and retrieve it only occasionally, e.g. once a day when a car is parked at a garage or a dedicated hot spot. The limitation of these solutions is the fact that only historical data is available and applications with more stringent delay requirements as traffic jam detection can not be applied. The last option is to use short-range communication technologies for data extraction. With the current development of IEEE 802.11p standard, it becomes another attractive solution. An infrastructure with Road Side Units (RSU) with WLAN communication interface can be used to offload collected data.

In the future ITS systems will be heavily inter-networked: We do not have to choose only a single communication technology for data transmission between a vehicle and an infrastructure or among vehicles. Multiple heterogeneous technologies can be used simultaneously to serve applications with different Quality of Service (QoS) requirements. In our work the focus is on WLAN-based RSUs solution. Trials and performance studies have indicated that it is a promising approach

This work has been performed in the framework of ITS platform project, which is in done in collaboration with North jutland Region, Denmark.

The Telecommunications Research Center Vienna (ftw.) is supported by the Austrian Government and by the City of Vienna within the competence center program COMET.

for Vehicle to Infrastructure (V2I), e.g. see [5]. However it will take some time until a dense net of RSUs is installed along the main roads. In a transition period RSU might be installed sporadically and will only provide intermittent connectivity.

This paper considers a case when RSUs' coverage is not continuous and gives gaps in connectivity. Our goal is to investigate if the RSUs placement with coverage gaps can still be used for FCD collection. We consider delay-tolerant applications and therefore we do not put delay as an optimization parameter. RSUs are placed as far as possible from each other, however vehicles still should be able to offload the collected data. The main focus is on reliability of data delivery. Here the limiting factors are OBU buffer size, transmission capacity of a RSU and the frequency of data recording. We also demonstrate that in a case when multiple cars are in a coverage area of a RSU, collisions between data packets reduces performance. As this is the first attempt to find an optimal distance between RSUs for FCD collection scenario, we limit ourselves to the case study of a highway environment where a road is modeled as a straight line and RSUs are placed along the road with equal distance between neighboring RSUs.

The problem of disruption tolerant communication for ITS applications is also considered in [6], where a reliable communication platform is introduced, capable of coping with intermittent connectivity. The approach works by in-node caching, on either the OBU or the RSU depending on whether the OBU is sending or receiving data, while the OBU is out of coverage. An announced service RSU is used to provide a well-known anchor point connecting the OBU with service, independent on the location and mobility of the OBU.

The remaining parts of this paper are organized as follows. Section II describes the details of the considered scenario. In Section III derivations of the upper bound on the distance between RSUs are given for the case of a single car. In Section IV simulation studies are used to approach a case of multiple cars and to take into account possibilities of packet collisions. Concluding remarks are given in Section V.

II. SCENARIO

The vehicles have installed an OBU which is capable of recording different in-car components and sensor readings and has communication possibilities with an infrastructure and other vehicles. We limit our consideration only to an IEEE 802.11p -based communication interface to connect to a RSU. RSUs have connections with a backbone network infrastructure. Within the coverage area of a RSU a connection between RSU and OBU is possible. The regions where there is no coverage at all are referred to as *gaps*.

An OBU typically contains transceivers, a GPS receiver, storage capacity, processors, and power management units. The main logical blocks considered in this work are (see Fig. 1):

- Data collection module regulates the frequency of sensor data updates, and the information which is included in a measurement. It receives information from GPS and different car sensors.

- Buffering module handles all buffering activities, buffer overloads and queuing related actions.
- Data transmission scheduler is responsible for data delivery to a RSU, including bundling of packets.

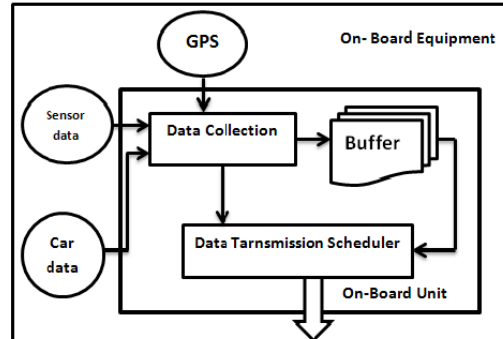

Fig. 1. Structure of OBU.

In the following we will elaborate on the design choices for each of the blocks.

For data collection an OBU can either record the data at a certain time update interval or at a traveled distance. It basically depends on the subsequent use of data which of the methods is preferred. If an OBU records the data based on a time interval update (e.g. 3s), the car would travel about 90 meters between data collection updates if its average speed is 30m/s (108km/h). If for some reason there is a congestion and the car does not move, the transmitted messages will contain a lot of redundant information. If we were to select a distance update, the data collected would only be buffered at pre-specified traveled distance marks. This approach would make it more difficult to distinguish between the cases when a car is moving slowly and a case when OBU packets are lost. Therefore, a combined approach might be preferable or a more intelligent solution can be applied when filtering and pre-processing of the recorded data is done at the OBU to remove redundant information, and thus reduce the amount of data to be transmitted to a RSU. In our studies we limit ourselves to the case when data is collected based on a predefined time interval, that we refer to as *data collection interval*. The OBU message (packet) contains the sensor data recorded at the data collection interval. These packets are aggregated (bundled), in this way overall overall amount of data is reduced by avoiding individual headers.

In the considered scenario a buffering block is necessary since data collection is done continuously, while connectivity to a RSU is only sporadically. When an OBU cannot send the recorded data packets, these data packets are stored in the OBU buffer and sent when a connection would be available. Thus, the buffer size sets a limitation on how far away the RSUs can be located as buffer overflow results in packet drops. However, memory is relatively inexpensive and storage capacity at an OBU can be easily extended. But all the stored data should be delivered to the remote control center and it is the capacity limitations of an access network that becomes a bottleneck. In

our work we apply an assumption of unlimited buffer size at an OBU.

Data transmission block is first of all responsible for bundling of packets. Frame aggregation, or bundling, puts two or more frames together into a single transmission. The maximum number of packets which can be aggregated together, is defined by a size of Maximum Transmission Unit (MTU). Bundling of the OBU messages into MTUs and their transmission is done as long as there are stored messages in the buffer. While within a coverage area and having finished with transmission of all "old" packets, no bundling will be done and OBU messages will be sent as long as they are generated by the Data Collection module. Additionally, Data Transmission module is responsible for deciding when data is scheduled for a transmission, i.e. forwarded to a communication interface. Simplest approach is to transmit all data as soon as a vehicle detects presence of a RSU. In this case it is fully up to a MAC protocol to regulate channel access and to resolve potential collisions. More intelligent solutions can be developed distributing data transmissions over whole connectivity interval. We have chosen to define a fixed *data transmission interval*, i.e. individual measurement bundled in a packet are forwarded to a communication interface periodically. A periodical data transmission approach is employed in order to provide fair medium access. Additionally, as we will see in the next section, this assumption allows us to derive a simple analytical model for RSU distance estimation.

To simplify the modeling approach of the described system, we consider a highway scenario: Vehicles are moving along a straight infinite road with a predefined constant speed. Movement in one direction is considered. RSUs are placed along the road equidistantly. This set up is illustrated on Fig. 2.

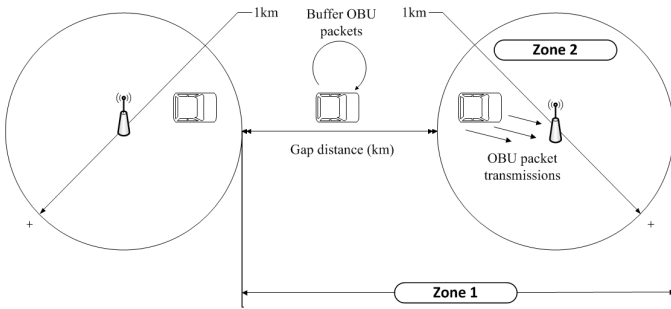

Fig. 2. Scenario.

III. THEORETICAL UPPER BOUND ON THE DISTANCE BETWEEN RSUS

Let us consider a situation when a single car is moving along a highway. In our idealized settings the distance between all RSUs are equal. It means that if the accumulated data that is collected by an OBU between two neighboring RSUs can not be transmitted while being in a coverage area, then some data will be left in the buffer and the amount of the buffered data will increase as a car drives forward and at some point it

will result in a buffer overflow. It can potentially lead to data loss and the fact that some data would never be delivered to a remote central server without noticing it. Using the condition that all data collected in zone 1 should be transmitted while in zone 2, we can derive an upper bound on the distance between RSUs (see Fig. 2).

Let d be the diameter of the coverage area of a RSU (total distance for the vehicle to send buffered data), v be a speed of a car, Δt_t be the data transmission interval, M is MTU size. Then the amount of data that can be transmitted by a car while it is within zone 2 is:

$$\frac{d \times M}{v \times \Delta t_t} \quad (1)$$

Let d_G be a distance between two neighboring RSUs, Δt_d be the data collection interval, l_p be the size of a single measurement. Then the amount of data generated while a car is within zone 1 is:

$$\frac{d_G \times l_p}{v \times \Delta t_d} \quad (2)$$

Considering that expressions in (1) and (2) are equal and letting p be a number of single measurements bundled together on one MTU (i.e. $l_p \times p = M$), we obtain

$$d_G = \frac{d}{\Delta t_t} \times \Delta t_d \times p \quad (3)$$

One should note that speed variable is canceled out in the equation, and thus the maximum distance between RSUs does not depend on the speed of vehicle.

Fig. 3 illustrates how the maximum distance between RSUs depends on the update time interval: The higher the frequency of data collection, the smaller the distance should be between RSUs.

If multiple vehicles are in the coverage area of a RSU, the available bandwidth is divided between the cars that are trying to offload the data. If we assume that an idealized MAC scheme is employed that allows for the fair bandwidth sharing avoiding collisions, then each car gets a $1/n$ th part of the bandwidth, where n is a number of cars. Then formula (3) can be modified as

$$d_G = \frac{d}{\Delta t_t \times n} \times \Delta t_d \times p \quad (4)$$

IV. EVALUATION VIA SIMULATION STUDIES

The main goal of this section is to make performance evaluation of the considered system under more realistic settings. We will take into consideration effect of channel contention and resulting data packet collisions and see how this will affect the performance.

A. Simulation environment

In order to simulate the system OMNeT++ is used, a modular and event driven simulation environment for building networks simulators. The proposed system in this paper is a vehicular wireless network in which two main elements are working together, vehicles and RSUs. Free space path loss

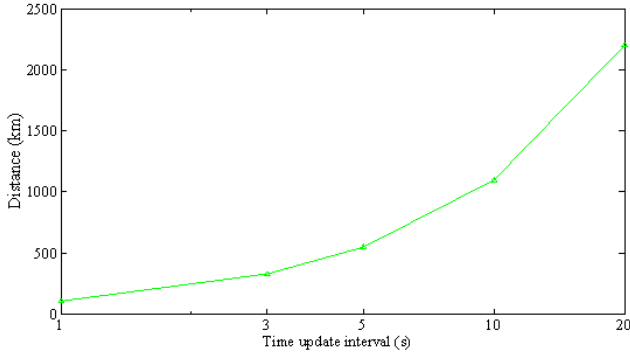

Fig. 3. Distance thresholds for one vehicle for $\Delta t_t = 100\text{ms}$, $l_p = 128\text{B}$, $d = 1\text{km}$.

model is used with path loss factor of 2.2 to simulate minor attenuations of a highway setup. The information of a wireless network consists of Basic Service Set, in terms of 802.11p called WAVE BSS and can be initiated by a RSU in V2I communications or by a vehicle in V2V communications. A beacon, also called WAVE Service Announcement (WSA), is initiated by a WBSS leader [7]. A vehicle that receives a WSA can decide to join the provided service on the specified channel. Since authentication and association is removed in 802.11p, the vehicle can send data to the RSU immediately. If it decides to join, the OBU buffer queue of the host will be checked to see if there is any buffered data or no. Bundling of the OBU messages into MTUs and their transmission continues until there is no more OBU data in the buffer of the vehicle. After that no bundling will be performed and packets of smaller size will be transmitted.

B. Verification of previous results

We would like to verify if the theoretical results derived in the previous section under somewhat idealistic assumptions can be used for real system parameters estimation. Using the set-up described in Section 4.A, we simulate the system with one car and measure delays experienced by packets. The packet delay is the sum of the following delays: OBU buffering delay, processing delay, queuing delay, channel access delay and propagation delay. In case of a single vehicle, no packet collision will happen.

Fig. 4 presents the average delays measured for different RSUs placement (5 km, 10 km, 11 km and 11.25 km distance between neighboring RSUs) where the used data rate is 3Mb/s. At the distance of approx. 11.25 km the first packet drop has been recorded and it is shown on the figure as an infinite delay. One should note that the actual values of the average delay depend on the speed, however the packet drops start to occur at the same distance regardless the vehicle's speed. Using the same numerical values for the parameters and formula (3), the maximum distance between RSUs is estimated to be 11 km that is close to the obtained simulation results. If we apply formula (4) to the case of e.g. 10 cars and the collection rate of 10 sec, we again get 11 km as the distance estimation.

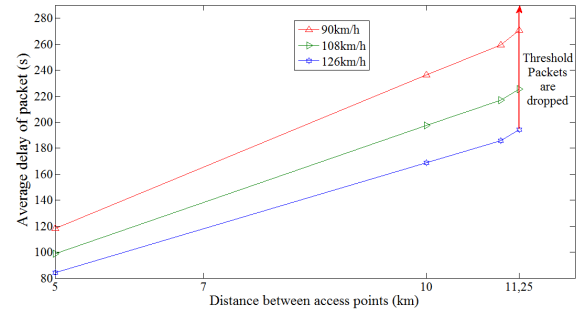

Fig. 4. Threshold for one vehicle for different speeds for $\Delta t_t = 1\text{s}$, $\Delta t_d = 1\text{s}$, $l_p = 128\text{B}$, $d = 1\text{km}$.

C. Results for the case of multiple cars

Packet collisions and delay in the system appear when the vehicles simultaneously transmit the data in the coverage area. The setup is shown in Fig. 5:

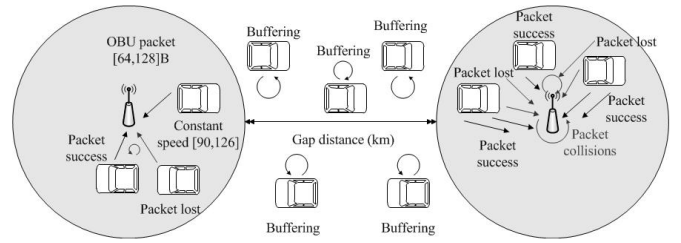

Fig. 5. Multiple cars setup.

Packet collision can be one of the main aspects of packet losses in 802.11 communications, even though solutions such as CSMA are tailored to counter such issues [8]. Even in the simplistic settings there are a number of parameters that influences the overall system performance:

- Data collection interval and data transmission interval
- The speed and number of vehicles,
- The OBU message size.

In order to understand the effect of collisions on the system performance, we have simulated a scenario with 10 cars that start driving approx. at the same time from the same point with approx. the same speeds. Choosing this configuration allows us to stress the system and at the same time avoid simulating many vehicles. Group mobility model helps us to realize a situation when all cars are in a vicinity of the same RSU.

Fig. 6 presents the average packet success rate (amount of buffered packets which are successfully delivered) measured for different distances between RSUs. Here packet losses are mainly due to collisions. If we are interested in that 95% of sent data is received at the remote control center, then according to the simulation results, the RSUs should be placed every 5 km.

Theoretically this distance was estimated to be 11 km. As collisions degrade system performance, RSUs should be

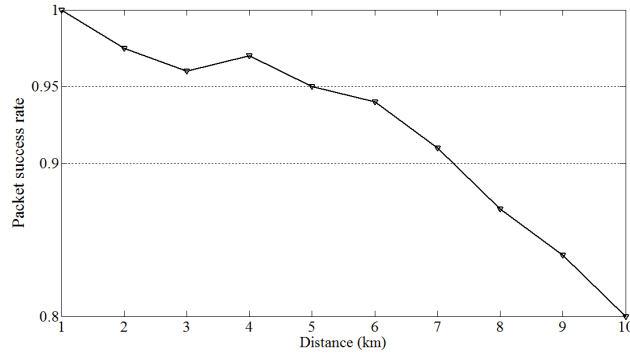

Fig. 6. Packet success rate vs. distance for $\Delta t_t = 100\text{ms}$, $\Delta t_d = 1\text{s}$, $l_p = 128\text{B}$, $d = 1\text{km}$.

placed closer to each other. This trend can be also observed on Fig. 7. RSUs distance estimation is provided for different time update intervals. Three lines correspond to the case of theoretically estimated distance, and simulated results for 90% and 95% success of data delivery.

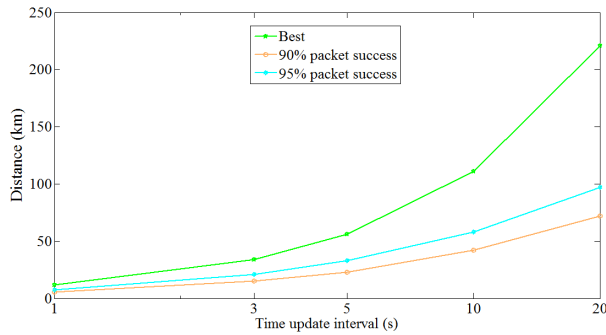

Fig. 7. Distance thresholds for 90% and 95% packet success rate.

The requirements of ITS applications can influence the size of the packet which is used by OBUs. Therefore it makes sense to show how the packet success rate changes with the packet size variation. This is shown in Fig. 8 for the aforementioned threshold of 5km. At this distance packet losses sharply increase after 256B, due to incapacity of sending the buffered data using the defined transmission update interval.

V. CONCLUSIONS

The paper considers vehicular networks in a highway scenario where 802.11p-based RSUs are used to let the cars send FCD to a remote control center. The system would be too costly if RSUs are placed in such a way that cars can get connected to the infrastructure in any given point and the coverage areas of the RSUs have overlapping areas. Therefore we consider a situation when there is a gap between every two successive RSUs and the vehicles buffer their OBU data until they reach the coverage area of the next RSU. Placement of RSUs with gaps unavoidably increases delay of data delivery as the time for a vehicle to reach the next coverage area should be taken into account. This approach would be suitable for

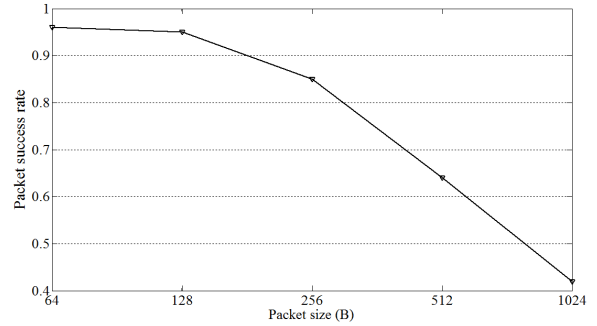

Fig. 8. Packet success rate vs. packet size for distance=5km, $\Delta t_t = 100\text{ms}$, $\Delta t_d = 1\text{s}$.

delay-tolerant applications. There is a trade-off between the size of the gap, delay to retrieve FCD and the acceptable packet loss. Simulation results indicate that the density of cars should also be taken into account as it affects collision probabilities among packets transmitted by different OBUs. More work in this direction is needed.

REFERENCES

- [1] Kashif Dar, Mohamed Bakhouya, Jaafar Gaber, Maxime Wack, University of Technology of Belfort-Montbliard and Pascal Lorenz, University of Haute-Alsace, Wireless Communication Technologies for ITS Applications, Topics in Automotive Networking, IEEE Communications Magazine, May 2010.
- [2] S. Beitenberger, B. Grueber, M. Neuherz, R. Kates. Traffic Information Potential and Necessary Penetration Rates. In Traffic Engineering and Control. Vol 45, No. 11. 2004.
- [3] H. Lahrman, N. Agerholm, J. Juhl, B. Aragho, K. H. Hansen, A.-G. Bloch, S. Tofing. ITS Platform North Denmark: Idea, Content and Status. In Proc. of the 19th ITS World Congress, 2012.
- [4] R. Bishop. Intelligent Vehicle Technologies and Trends. Artech House, 2005.
- [5] Hannes Hartenstein, Kenneth Laberteaux, Vehicular Applications and Inter-Networking Technologies, John Wiley and Sons, 2010.
- [6] T. Paulin, S. Bessler. A Disruption Tolerant Connectivity service for ITS Applications Using 802.11p. In Proc. of the 17th European Wireless Conference, 2011.
- [7] IEEE 1609 - Family of Standards for Wireless Access in Vehicular Environments (WAVE).
- [8] Der-Jiunn Deng, Hsin-Chin Chen, Han-Chieh Chao, Yueh-Min Huang, A Collision Avoidance Scheme for IEEE 802.11p VANETs, Wireless Personal Communications 56:371383, Springer Science, 2011.