



AALBORG UNIVERSITY
DENMARK

Aalborg Universitet

The Intelligent Ventilator (INVENT) project

the role of mathematical models in translating physiological knowledge into clinical practice

Rees, Stephen Edward

Publication date:
2011

Document Version
Accepted author manuscript, peer reviewed version

[Link to publication from Aalborg University](#)

Citation for published version (APA):

Rees, S. E. (2011). *The Intelligent Ventilator (INVENT) project: the role of mathematical models in translating physiological knowledge into clinical practice*. Center for Model-based Medical Decision Support. Department of Health Science and Technology. Aalborg University.

General rights

Copyright and moral rights for the publications made accessible in the public portal are retained by the authors and/or other copyright owners and it is a condition of accessing publications that users recognise and abide by the legal requirements associated with these rights.

- ? Users may download and print one copy of any publication from the public portal for the purpose of private study or research.
- ? You may not further distribute the material or use it for any profit-making activity or commercial gain
- ? You may freely distribute the URL identifying the publication in the public portal ?

Take down policy

If you believe that this document breaches copyright please contact us at vbn@aub.aau.dk providing details, and we will remove access to the work immediately and investigate your claim.

**The Intelligent Ventilator (INVENT) project: The role of
mathematical models in translating physiological
knowledge into clinical practice.**

Stephen E. Rees

**Center for Model-based Medical Decision Support, Department of
Health Science and Technology, Aalborg University.**

This thesis has been accepted by the Academy Council at the Faculty of Medicine, Aalborg University for public defence in fulfillment of the requirements for the doctoral degree in technology. The defence will take place at Aalborg University in the Auditorium B3-104 on December 2, 2011 at 1.00 p.m. punctually.

Denne afhandling er af Akademisk Råd ved Det Sundhedsvidenskabelige Fakultet, Aalborg Universitet antaget til forsvar for doktorgraden teknik. Forsvaret finder sted på Aalborg Universitet, Auditorium B3-104 , fredag den 2. december 2011, kl. 13.00 præcis.

Aalborg, Egon Toft, Dean

This dissertation is based upon the following articles:

- 1) Rees S.E, Kjærgaard S, Andreassen S. Mathematical Modelling of Pulmonary Gas Exchange. In: **Modelling Methodology for Physiology and Medicine**. eds. E.R Carson and C.Cobelli, Academic Press, 2001, pp 253-277.
- 2) Rees S.E, Kjærgaard S, Thorgaard P, Malczynski J, Toft E, Andreassen S. The Automatic Lung Parameter Estimator (ALPE) system: Non-invasive estimation of pulmonary gas exchange parameters in 10-15 minutes. **Journal of Clinical Monitoring and Computing**, 2002, Vol 17, No.1, pp 43-52.
- 3) Rees S.E, Andreassen S. Mathematical models of oxygen and carbon dioxide storage and transport: The acid-base chemistry of blood. **Critical Reviews in Biomedical Engineering**, 2005; 33(3):209-64.
- 4) Andreassen S, Rees S.E. Mathematical models of oxygen and carbon dioxide storage and transport: Interstitial fluid and tissue stores and whole body transport. **Critical Reviews in Biomedical Engineering**, 2005; 33(3): 265-98.
- 5) Rees S.E, Toftegaard M, Andreassen S. A method for calculation of arterial acid-base and blood gas status from measurements in the peripheral venous blood. **Computer Methods and Programs in Biomedicine** 2006; 81(1):18-25.
- 6) Rees S.E, Kjærgaard S, Andreassen S, Hedenstierna G. Reproduction of MIGET retention and excretion data using a simple model of gas exchange in lung damage caused by oleic acid infusion. **Journal of Applied Physiology**, 2006; 101(3):826-32.
- 7) Rees S.E, Allerød C, Murley D, Zhao Y, Smith B.W, Kjærgaard S, Thorgaard P, Andreassen S. Using physiological models and decision theory for selecting appropriate ventilator settings. **Journal of Clinical Monitoring and Computing**, 2006; 20(6):421-429.
- 8) Rees S.E, Hansen A, Toftegaard M, Pedersen J, Kristensen S.R, Harving H. Converting venous acid-base and oxygen status to arterial in patients with lung disease. **European Respiratory Journal**, 2009; 33(5):1141-7.
- 9) Rees S.E , Klæstrup E, Handy J, Andreassen S, Kristensen S.R. Mathematical modelling of the acid-base chemistry and oxygenation of blood – A mass balance, mass action approach including plasma and red blood cells. **European Journal of Applied Physiology**, 2010; 108:483-494.
- 10) Matousek S, Handy J, Rees S.E. Modeling the acid-base chemistry of plasma: Consolidation of the traditional and modern approaches from a mathematical and clinical perspective. **Journal of Clinical Monitoring and Computing**. 2011 Feb;25(1):57-70.
- 11) Rees S.E, Kjærgaard S, Andreassen S, Hedenstierna G. Reproduction of oxygenation data in oleic acid induced lung damage – a comparison of the MIGET and a simple model of pulmonary gas exchange. **Intensive Care Medicine**. 2010 Dec;36(12):2117-24

Content

List of papers included in dissertation	i
Contents	ii
Preface	iii
1. Introduction	1
2. Pulmonary gas exchange	4
2.1 Introduction	4
2.2 Mathematical modeling of oxygen transport	5
2.3 Model validation	8
2.3.1 Comparison of the simple model of pulmonary gas Exchange with the MIGET	9
2.4 ALPE- systems development and clinical application	13
2.5 Summary of chapter	14
3. The acid-base and oxygen status of blood	15
3.1 Introduction	15
3.2 Mathematical models of acid-base and oxygen status	17
3.3 Model validation	21
3.3.1 Evaluation against previously measured data	21
3.3.2 Evaluation with studies designed specifically to test relevant functionality	23
3.4 ARTY- Systems development and clinical application	27
3.4.1 Mathematical arterialisation method	28
3.4.2 Evaluation of the ARTY method in patients residing in the department of pulmonary medicine	29
3.4.3 Sensitivity of the ARTY method to assumptions and measurement errors	31
3.5 Summary of chapter	33
4. Decision support for mechanical ventilation	34
4.1 Introduction	34
4.2 The Intelligent Ventilator (INVENT) system	35
4.3 Using the INVENT system	38
4.4 Evaluation of the INVENT system	40
4.5 Summary of chapter	43
5. Discussion and Conclusions	44
5.1 Pulmonary gas exchange	44
5.2 Acid-base chemistry	47
5.3 The INVENT system	50
5.4 Conclusions	52
6. References	53
7. Summary	66
8. Dansk Resumé	68

Preface

The work presented in this dissertation was carried out at the Center for Model-based Medical Decision Support (MMDS), the Department of Health Science and Technology, Aalborg University, between 1997 and 2010.

Studies 1, 2, 5, 6, 7, 8 and 11 were performed in collaboration with the Department of Anaesthesia and Intensive Care Medicine, Region North Denmark, Denmark. Study 2 was performed with additional collaboration from the Department of Cardiology, Aalborg Hospital, Århus University Hospital, Denmark. Studies 6 and 11 were performed with additional collaboration from the Department of Clinical Physiology, Uppsala University, Uppsala, Sweden. Study 8 was performed with additional collaboration from the Departments of Respiratory Diseases and Clinical Biochemistry, Aalborg Hospital, Århus University Denmark. Study 9 was performed in collaboration with the Department of Clinical Biochemistry, Aalborg Hospital, Århus University Denmark, and with the Department Anaesthesia Intensive Care Medicine and Pain, The Chelsea and Westminster Hospital, United Kingdom. Study 10 was performed in collaboration with the Department of Pathological Physiology, Prague University, Czech Republic, and the Department of Anaesthesia, Intensive Care Medicine and Pain, The Chelsea and Westminster Hospital, United Kingdom.

I would like to thank all co-authors and those responsible for generating positive research environments within our, and collaborating institutions. In this regard, a special thanks goes to the leadership of the Department of Health Science and Technology, for providing a stable base for these activities within MMDS. A special thanks also goes to Steen Andreassen for sharing his friendship and expertise in all my years in Aalborg. I would also like to thank all of my colleagues, past and present, at the Center for Model-Based Medical Decision support and all of those, technicians and clinicians alike, who have felt part of the INVENT team. Within that team, special thanks goes to Søren Kjærgaard, for many years of friendship and work, to Charlotte Allerød, Marianne Toftegaard and Bodil Rasmussen for fruitful clinical discussions, to Dan Karbing for his new energy in this project and for helping translate my Dansk Resumé, and to Per Thorgaard and Egon Toft for providing clinical drive and encouraging others to be part of the team. Thanks also to all of the staff at Department 1, Department of Anaesthesia and

Intensive Care Medicine, Region North Denmark, for always providing a friendly place for our studies. I would also like to thank newer collaborative partners at the Departments of Respiratory Diseases and Clinical Biochemistry at Aalborg Hospital, the Department Anaesthesia Intensive Care Medicine and Pain at the Chelsea and Westminster Hospital, those at Mermaid Care A/S, and those at Radiometer Medical A/S, for their energy and positive attitude. I look forward to many more years' collaboration with you all. Thanks also to Ewart Carson, for being kind enough to read a draft of this dissertation. My greatest thanks goes to Nicolas, Morgan and all my family and friends.

This work is based on the papers numbered 1-11 above. Publication 5 has been submitted as part of a PhD dissertation which is currently under submission (M. Toftegaard - A mathematical model based method for converting venous values of acid-base and oxygenation status to arterial values – description and evaluation). The other publications have not previously been submitted for an academic degree.

The papers on which this dissertation is based have received financial support from the Danish Heart Foundation, the Danish Research Academy under the DANVIS program, the Research Foundation for Northern Jutland County, and by the IT-committee under the Danish Technical Research Council, for which I would like to express my gratitude.

1. Introduction

Providing computerized decision support for clinical decisions can be seen as a challenging task. Systems need to integrate and interpret large amounts of clinical data, providing rational advice that can be easily understood. In addition, systems need to be easily maintained and transferable between clinical institutions where the prevalence of disease or the culture of treatment may be quite different.

Approaches for providing computerized decision support range from: focusing on data, i.e. building statistical models to describe measurements; modeling the physiological and pathophysiological processes; to building systems representing the heuristic reasoning of clinicians, often structured as sets of rules. In the intensive Care unit, and in particular in the control of mechanical ventilation, representation of heuristic reasoning can be seen currently as the most successful approach to providing decision support. This approach has produced systems which have both been tested in multi-center randomized control trials [1,2,3,4], and commercialized [1,4].

Each of these approaches can be seen as having contrasting advantages and disadvantages. Approaches based on data may be most appropriate where a large number of measurements are taken and little is known about physiological processes. Systems based on heuristic reasoning do not require a detailed understanding of physiology or large amounts of data, but suffer from the nature of heuristic knowledge, in that the knowledge contained in these systems implicitly includes that related to both physiological mechanisms and clinical preference. The lack of explicit, independent representation of these could be postulated as a cause of transferability problems, particularly in situations where clinical preference changes due to regional or cultural variation.

Physiological model based systems enable separation between physiological knowledge and clinical preference, the latter of which being expressed using decision theory [5], in the form of utility functions. It can be argued that this makes such systems inherently maintainable and transferable, as preferences can be modified to local situations or clinical practice, with

physiological models remaining stable. The disadvantage of such systems can be seen as the relative expense of model building. Systems such as these require not only a thorough understanding of the physiology and pathophysiology, but also building of models which have the property of parsimony [6, p32]. ‘Parsimony’ in this context, relates to the necessary complexity of the physiological models. Models that are too simple will not adequately describe the patient data or produce accurate simulations. Models that are too complex are typically over-parameterised or un-identifiable, meaning that there is not a unique set of parameter values which characterize the patient data, or that additional data collection is required. To effectively use physiological models in decision support, the balance between complexity and parameterization is crucial. Models both need to be tuned to the individual patient from routinely available data, and model parameters should be sufficient to have physiological meaning. The concept of building ‘minimal’ models, of separating the relevant from the irrelevant, is the ‘art’ of the modeling process for those working in model-based decision support.

It is the philosophy of the work undertaken as part of this dissertation, that building models is a good thing to do, for several reasons. As mentioned, from a decision support system (DSS) perspective they provide the natural division between physiology and preference. Perhaps equally as important, is that models built tend to raise interesting questions relating to our understanding of physiology, of how to help integrate existing measurements, and lead to new ideas for research, and for clinical and commercial applications.

This dissertation describes work undertaken between 1997-2009 at the Center for Model-based Medical Decision Support (MMDS), Aalborg University. It describes work on the project known as the INtelligent VENTilator project (INVENT), the structure of which is illustrated in figure 1. The original, and existing, goal of this project is to build a model based DSS to suggest appropriate settings from mechanical ventilation of patients residing in the ICU. To do so has required building several physiological models (layer 1, figure 1). These include: a model of pulmonary gas exchange focusing on oxygen transport and a model of the acid-base and oxygenation status of the blood, interstitial fluid and tissues focusing on carbon dioxide transport. Models require validation (layer 2, figure 1), and studies have been performed comparing the model of pulmonary gas exchange against the reference technique [7]; and to compare the model of acid-base chemistry with literature and experimental data including the

mixing of blood at different gas partial pressures. During the project period these models have raised interesting scientific and clinical questions (layer 3, figure 1). Answering some of these questions has led to the development of two further systems, the Automatic Lung Parameter Estimator (ALPE) system, and a system for arterialisation of venous blood (ARTY) (layer 4, figure 1). In turn development of these systems has led to the writing of patents, formation of start-up companies and product development.

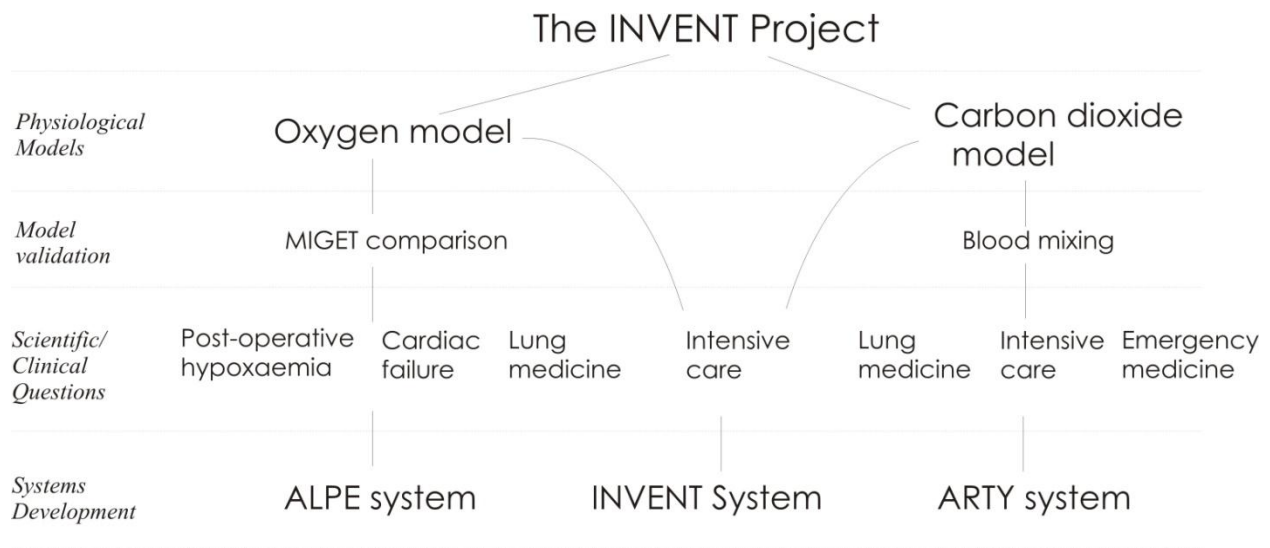

Figure 1 – The Intelligent Ventilator (INVENT) project

This dissertation is structured so as to review the branches of the INVENT project illustrated in figure 1. Section 2 describes the modeling of pulmonary gas exchange focusing on the transport of oxygen. The section describes comparison of this model with the reference MIGET technique. In addition the section describes the ALPE system and the clinical problems addressed using ALPE. Section 3 describes the modeling of acid-base chemistry of the blood, and the validation of this model including experiments involving the mixing of blood. The section also describes the ARTY system and the clinical problems addressed using ARTY. Section 4 describes the integration of these models into the INVENT system. The discussion returns to the theme of this dissertation, i.e. the benefits of building models when constructing DSS systems, reflecting on the contribution of this work and the need for further research.

2. Pulmonary gas exchange

2.1 Introduction.

To simulate changes of mechanical ventilation strategy on patient state requires a model of pulmonary gas exchange, i.e. the exchange of oxygen and carbon dioxide between the alveolar gas and blood phases within the lungs. Abnormalities in pulmonary gas exchange can be due to a mismatch in the distribution of ventilation and perfusion in the lungs, or due to diffusion limitation, all of which can be described by applying only five well known equations: the alveolar air equation; an equation describing venous admixture; Fick's first law of diffusion; the Fick principle of blood flow; and the Bohr equation for estimation of dead space [8]. The extremes of V/Q mismatch range from pulmonary shunt, where collapsed or edema filled alveoli are perfused giving a V/Q ratio of zero; to alveolar deadspace, where ventilated regions of the lungs are not perfused giving an infinite value for the V/Q ratio. The lungs can therefore be thought of as a continuum, with V/Q ratios ranging from shunt to alveolar dead space. The role of diffusion limitation in pulmonary gas exchange was largely settled by the development of the multiple inert gas elimination technique (MIGET) [7]. The use of this technique has shown in numerous studies, that it is possible to describe the gas exchange properties of six inert gasses with very different solubility in blood, plus oxygen, using only models of V/Q mismatch, as summarized in [9-13]. The exceptions to this being in cases of pulmonary fibrosis [14] and exercise [15,16]. In general then, the conclusion that diffusion abnormalities are not the major cause of alveolar-arterial oxygen pressure differences has been acknowledged, even by those typically associated with the study of these effects [17].

In the clinical setting, few techniques exist to appropriately assess pulmonary gas exchange in mechanically ventilated patients residing in the ICU. Oxygenation problems are typically only assessed via arterial blood gas values or the ratio of arterial oxygen partial pressure to inspiratory oxygen fraction ($P_{A}O_2/F_{I}O_2$ ratio). The $P_{A}O_2/F_{I}O_2$ ratio has been shown by our group [18] to be a poor description of oxygenation problems, varying dramatically with $F_{I}O_2$ levels, and causing misclassification of patients with acute lung injury (ALI) and acute respiratory distress syndrome (ARDS).

In the experimental setting, MIGET is the reference technique for describing pulmonary gas exchange [7]. In this technique six tracer gasses are infused intravenously for a period of about 45 minutes to enable equilibrium. Simultaneous measurements are then taken of inert gas values in the mixed venous, arterial and mixed expired gasses, and these used to calculate the measured retention and excretion for each inert gas. Retention is the ratio of partial pressures of the inert gasses in the arterial and mixed venous blood, i.e. P_a/P_v . This varies from zero, for a gas that is completely excreted from the blood, to one for a gas that is completely retained. Excretion is similarly defined as the ratio of partial pressures in the expired and mixed venous gasses. Measured values of retention and excretion are then used with a compartmental model of the lung to calculate shunt, alveolar deadspace, and the ventilation and perfusion distributions over a range of pre-set V/Q values dividing the lungs into 50 compartments. The mathematical description of these compartments is described by the combination of only two equations: the Fick principle of blood flow and the alveolar air equation. These two equations for each of the 50 compartments are linearly combined to describe the retention and excretion of each gas over the whole lung [7,19]. Whilst MIGET remains the reference technique for understanding pulmonary gas exchange its application in the clinic has been somewhat limited [20], even in its less invasive form [21].

2.2 Mathematical modeling of oxygen transport

Given the large discrepancy between the clinical and experimental measurement of pulmonary gas exchange, a large focus of this work and of the INVENT team has been to describe a mathematical model of gas exchange which is both physiologically sound and identifiable from data easily collected in the clinic. The focus of this work has been on describing oxygen transport, and the resulting model is illustrated in figure 2. This model is that included in the Automatic Lung Parameter Estimator (ALPE) system, and will therefore be referred to as the ALPE model. This model is a three compartment model of the lungs representing two ventilated and perfused compartments, and pulmonary shunt. Two parameters are used to describe V/Q abnormalities: shunt, i.e. the percentage of cardiac output which passes through the lung without being involved in gas exchange, and fA2, the fraction of ventilation to a compartment receiving 90% of the non-shunted perfusion. Interestingly, fA2 can be used to calculate the drop in O₂

partial pressure from the expired gas to the end capillary blood, i.e. ΔPO_2 , (equation 8, figure 2). This drop is the necessary increase in O_2 partial pressure required to fully saturate the non-shunted pulmonary blood and as such can be called the oxygen normalization pressure (ONP). If ONP is 10 kPa then the patient requires an $F_I O_2$ of $21\%+10\%= 31\%$. A further increase in $F_I O_2$ only marginally increases the oxygen concentration of capillary blood by increasing O_2 in solution. As the solubility coefficient for O_2 in blood is small (0.01 (mmol/l)/kPa) this extra oxygen transported is small for O_2 delivered at atmospheric pressure.

The equations included in figure 2 have been described in detail previously [22]. In summary, the equations represent steady state conditions of oxygen transport in the whole body. Equations 1-4 describe oxygen flow into the alveoli and blood (VO_2) from each of the compartments. Eq. 5 describes the expired oxygen fraction ($F_E O_2$) as a sum of that from alveolar compartments. Eqs. 6 and 7 calculate the partial pressure of oxygen in the two lung capillary compartments ($P_{cO_{2(1)}}$, $P_{cO_{2(2)}}$). Equation 8 describes the calculation of ΔPO_2 , and equation 9 the concentration of oxygen in arterial blood ($C_a O_2$) by mixing the capillary compartments. Equations 10-14 describe the relationship between partial pressure (PO_2), saturation (SO_2) and concentration (CO_2) of oxygen in the blood capillary compartments as a function of other variables in blood and the oxygen dissociation curve (ODC). Eqs. 15 and 16 describe the concentration of oxygen in the lung capillary compartments ($C_{cO_{2(1)}}$, $C_{cO_{2(2)}}$) as the venous concentration ($C_v O_2$) plus the increase in oxygen concentration due to alveolar equilibration. Eq. 17 calculates the venous oxygen concentration ($C_v O_2$) as the arterial oxygen concentration ($C_a O_2$) minus the drop in oxygen concentration due to tissue consumption.

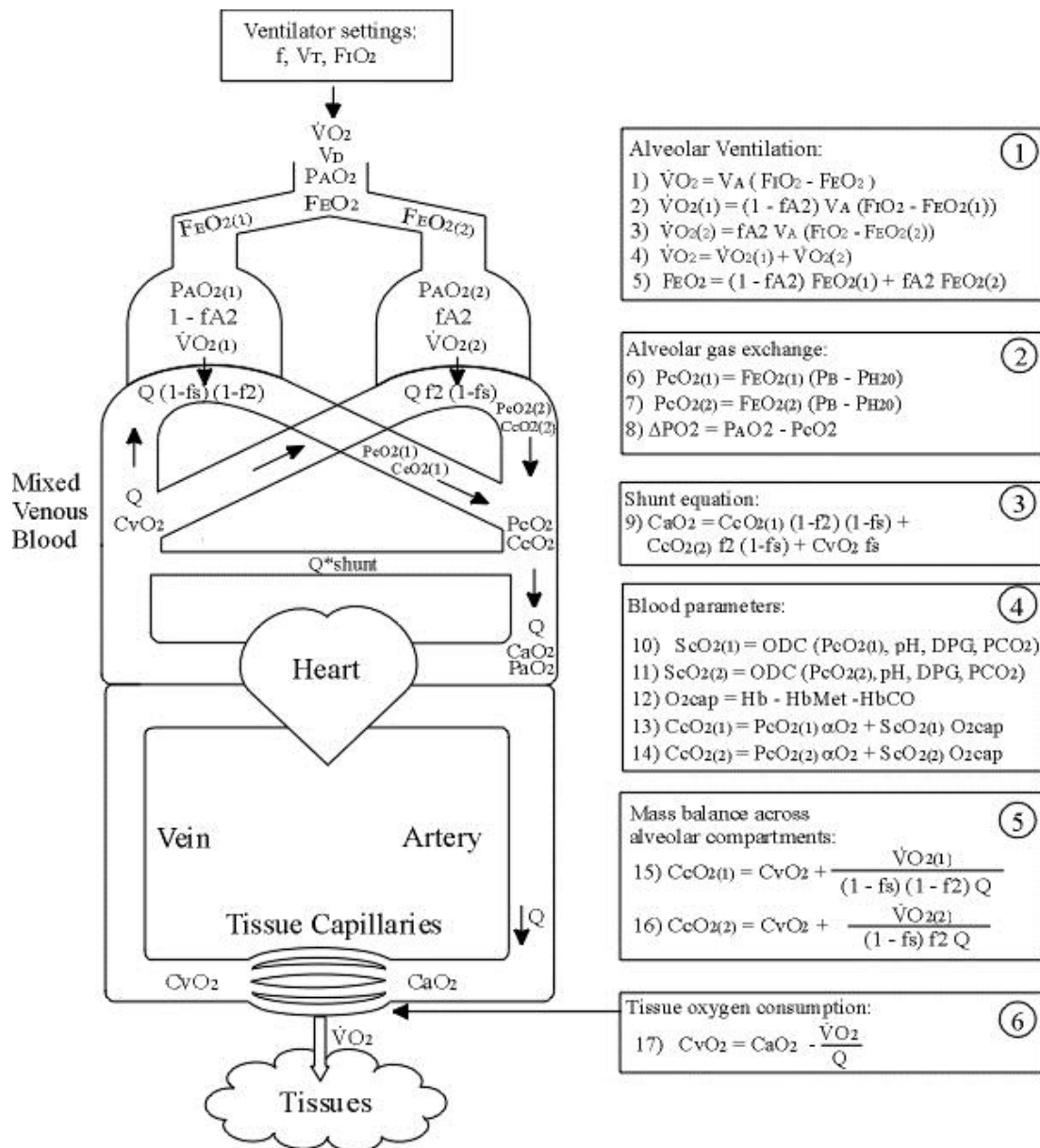

Figure 2 – The mathematical model of oxygen transport [22] (With kind permission from Springer Science+Business Media: Intensive Care Med., Non-invasive estimation of shunt and ventilation-perfusion mismatch, 29, 2003, electronic supplement, Kjærgaard S, Rees S, Malczynski J, Nielsen JA, Thorgaard P, Toft E, Andreassen S.)

Simulations of end tidal oxygen fraction versus arterial oxygenation, performed using this model, illustrated in figure 3, show the physiological effects of change in shunt and ΔP_{O_2} on

oxygenation. Shunt is not responsive to increases in alveolar oxygen partial pressure and as a result the curve shown in figure 3 for increased shunt is quite flat. Areas of the lung with low V/Q ratio, as characterized by fA_2 or ΔP_{O_2} , are by definition responsive to changes in alveolar oxygenation, and as such the slope of the curve is steep. It is clear from these simulations that changes in $F_{I_{O_2}}$ and measurement of Sp_{O_2} , possible in the clinic, can be used to determine the degree of the two abnormalities, shunt and low V/Q ratio, as shown by our group [22] and that of Jones and colleagues [23].

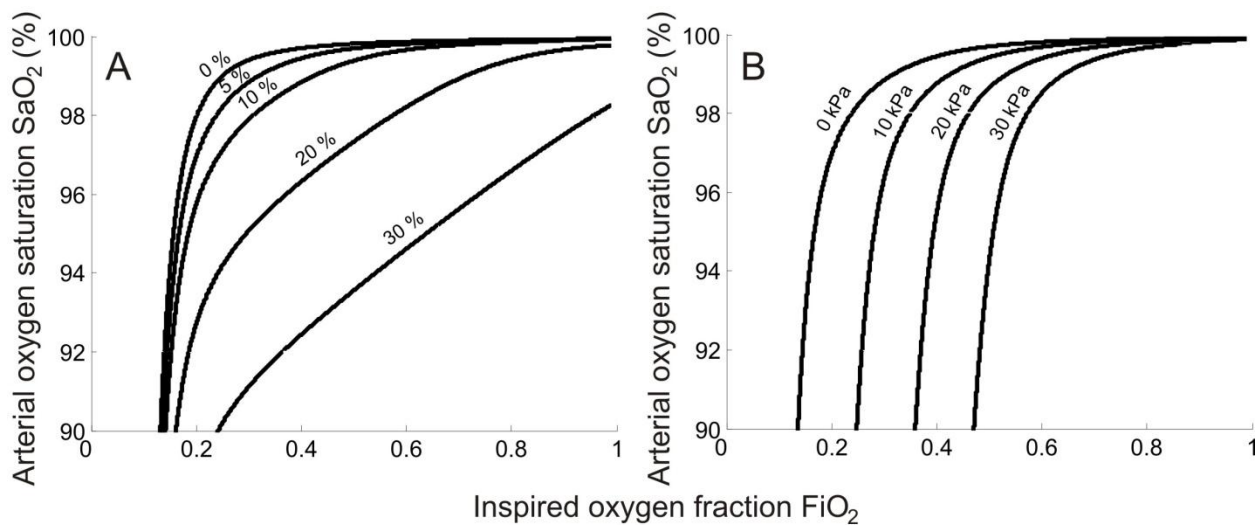

Figure 3 – Simulations of variation in arterial oxygenation with inspired oxygen fraction (F_{iO_2}) at different values of pulmonary shunt (A) and ΔP_{O_2} (B). Reproduced, and slightly modified, from [18].

2.3 Model Validation

To explore whether the ALPE model has appropriate physiological complexity, it has been compared with the reference technique for estimating pulmonary gas exchange, i.e. the multiple inert gas elimination technique (MIGET) [7]. This comparison has been performed in two phases: first to see if the ALPE model could fit the experimental data provided by MIGET in health and disease, i.e. data describing the retention and excretion of inert gasses [24]; second, to

determine whether the models could simulate changes in arterial oxygenation seen in health and disease in a form comparable to MIGET [25]. A summary of these studies follows:

2.3.1 Comparison of the simple model of pulmonary gas exchange with the MIGET.

Seven pigs were anesthetized, muscle relaxed, and mechanically ventilated (volume controlled mode), and following infusion of MIGET tracer gasses and an equilibration period of 45 min, baseline measurements of hemodynamic and ventilatory parameters were taken and a determination of ventilation-perfusion distribution was performed using MIGET. In addition $F_{I}O_2$ levels were varied at baseline in 4-5 steps, with an equilibration period of 5 minutes between each step, with measurement of: ventilation volumes, inspired and end-expired oxygen, end-expired carbon dioxide ($F_{E}O_2$), mixed expired O_2 and CO_2 and cardiac output. Lung injury was subsequently induced using infusion of oleic acid. After allowing for stabilization of the lung injury for 90 min, a series of determinations of ventilation-perfusion distributions were performed at different levels of PEEP and inspiratory-to-expiratory (I:E) ratio. Values of PEEP and I:E ration were selected so as to be compatible with clinical treatment of acute lung injury these being: PEEP= 5, 10 and 18 cmH₂O, at I:E = 1:2; and PEEP = 10 cmH₂O, at I:E 2:1. These series of ventilation-perfusion determinations were obtained both using the MIGET technique and from variation of $F_{I}O_2$ levels, as for baseline conditions. Thirty minutes were allowed between each change in PEEP and I:E ratio.

MIGET data were used to obtain the measured retention (R_m) and excretion (E_m) in the usual way [7]. The 50-compartment MIGET model and the ALPE model figure 2, were fitted to measured retention and excretion data obtained from each pig on each of the five different occasions. For the ALPE model values of anatomical dead-space volume (V_D), pulmonary shunt (shunt), and fA_2 , were uniquely identified from retention and excretion data as described in [24]. For the 50-compartment MIGET model values of model parameters describing the ventilation and perfusion of the 50 compartments were calculated using the standard MIGET computer software [19]. MIGET parameters were used to calculate summary statistics describing the mean and log standard deviation (log SD) of the ventilation (log SDV) and perfusion (log SDQ) of the compartments.

Calculation of the parameters of both the MIGET and the ALPE model were performed by fitting inert gas data at a single $F_{I}O_2$ level. The recovered V/Q distributions of the MIGET and ALPE model were then used to simulate arterial oxygen partial pressure (P_aO_2) when $F_{I}O_2$ was varied and these values compared to measured values.

These data were then used to answer the following questions [24,25]

- 1) Can the ALPE model adequately describe MIGET data in a physiological situation analogous to acute lung injury, and does it give similar parameter values to the MIGET model? [24]
- 2) Can the MIGET and simple model give accurate and comparable predictions of P_aO_2 across a range of PEEP, Inspiratory : Expiratory (IE) ratio, and $F_{I}O_2$ settings compatible with clinical treatment of acute lung injury? [25]

The results of question 1 are illustrated in table 1, taken from [24]. Table 1 gives the values of ALPE parameters when fitted to inert gas data, plus the weighted residual sum of squares (WRSS) of the fitting. The ALPE model was a good fit to the data, having an average WRSS equal to 9.2, not significantly different (χ^2 test) from the expected value due to measurement error of 9.0. This was the case in all but 4 of the 34 cases, which represented the most severe gas exchange abnormalities, suggesting that at extremes of abnormality the ALPE model is not sufficiently complex.

	<i>Pig 1</i>	<i>Pig 2</i>	<i>Pig 3</i>	<i>Pig 4</i>	<i>Pig 5</i>	<i>Pig 6</i>	<i>Pig 7</i>	Average, Over All Pigs	<i>P</i> Values of χ^2 Test
<i>Baseline</i>									
Shunt, %	4.4	1.6	2.5	1.6	1.2	1.9	1.9	2.16	
V _D , l	0.13	0.11	0.13	0.12	0.10	0.12	0.13	0.12	
fA ₂	0.62	0.73	0.57	0.69	0.71	0.79	0.77	0.70	
WRSS	6.2	1.7	5.1	6.7	7.7	3.2	3.2	4.8	>0.2
<i>PEEP = 5 cmH₂O</i>									
Shunt, %	49.3	19.8	22.3	7.8	19.2	*	28.3	24.5	
V _D , l	0.16	0.13	0.14	0.14	0.12	*	0.15	0.14	
fA ₂	0.54	0.48	0.64	0.60	0.57	*	0.67	0.58	
WRSS	21.5	11.8	9.4	6.9	12.6	*	18.6	13.5	>0.1
<i>PEEP = 10 cmH₂O</i>									
Shunt, %	24.7	16.5	16.2	4.7	6.7	41.8	37.3	21.1	
V _D , l	0.16	0.13	0.14	0.14	0.12	0.14	0.15	0.14	
fA ₂	0.63	0.55	0.59	0.64	0.70	0.67	0.72	0.64	
WRSS	8.8	7.7	11.7	8.5	12.1	17.3	17.8	12.0	>0.2
<i>PEEP = 18 cmH₂O</i>									
Shunt, %	5.7	4.93	2.14	2.06	1.21	22.9	10.0	7.0	
V _D , l	0.17	0.12	0.15	0.15	0.13	0.14	0.16	0.15	
fA ₂	0.63	0.61	0.59	0.57	0.75	0.66	0.65	0.64	
WRSS	8.5	5.5	9.1	8.5	10.2	1.7	7.4	7.3	>0.2
<i>PEEP = 10 cmH₂O, IE 1:2</i>									
Shunt, %	25.9	24.0	13.5	4.0	10.9	41.5	42.4	23.1	
V _D , l	0.14	0.11	0.12	0.12	0.12	0.14	0.12	0.12	
fA ₂	0.63	0.68	0.58	0.67	0.60	0.65	0.56	0.63	
WRSS	7.6	2.6	12.0	1.9	11.7	9.9	14.8	8.6	>0.2
Average WRSS, over all pigs and all time points								9.2	>0.2

**Pig 6*, PEEP 5: due to the critical state of the pig, this measurement was not taken.

Table 1- Values of parameters and WRSS when the simple model is fitted to inert-gas data.

Reproduced from [24]

Calculated values of anatomical dead space were almost identical for the MIGET and simple models, with a bias and standard deviation of the difference between these values equal to 0.002 ± 0.002 liter. For shunt the simple model overestimated shunt by only 7%, meaning that a shunt value of 40.0% would be estimated as 42.8%. Values of fA₂ correlated well with both log SDV and log SDQ, with the correlation coefficients of linear correlations between log SDV and fA₂ and log SDQ and fA₂ being $r^2 = 0.92$ and $r^2 = 0.86$, respectively.

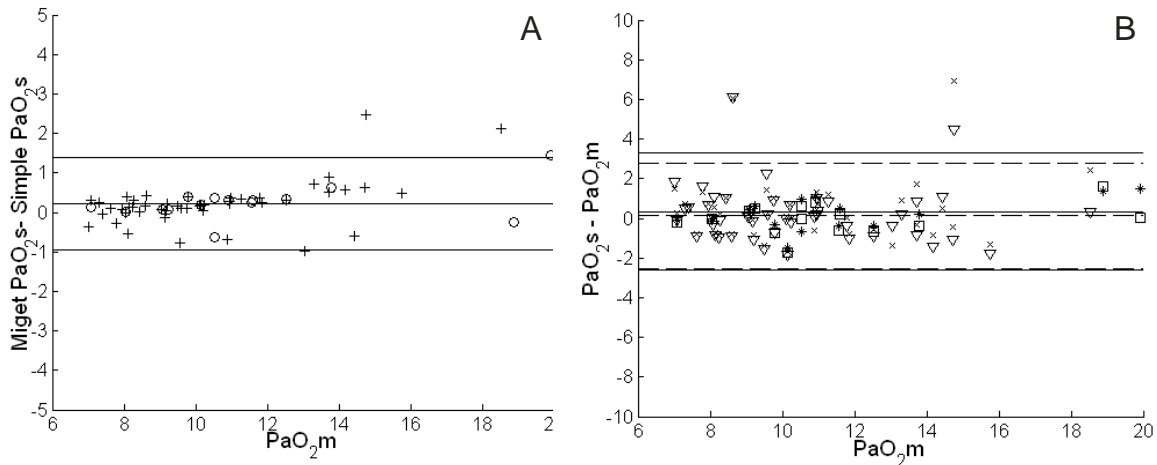

Figure 4 – The comparability (fig 4A) and accuracy (fig 4B) of MIGET and simple model predictions of PaO₂ over a clinically interesting range of PaO₂ (Reproduced and modified from [25])

The results of question 2 are illustrated in figure 4, taken from [25]. Figure 4 shows that the simple model provides a description of arterial oxygenation at different values of F_IO₂ which is both comparable to the MIGET and accurate. Figure 4a illustrates the comparability of simulations of P_aO₂ performed using the two models over all ventilator settings with 62 measurements included in this plot, one for each F_IO₂ level at each ventilator setting, where 7 kPa ≤ P_aO₂ ≤ 20 kPa. This range of P_aO₂ was selected to be compatible with that usually seen in the management of acute lung injury. The MIGET model simulates values of P_aO₂ on average 0.22 kPa + 0.59(SD) higher than the ALPE model for all cases. Figure 4b illustrates the accuracy of simulations performed using the two models over all ventilator settings, i.e. the same 62 measurements. The difference between model predicted and measured values of P_aO₂ was almost the same for the two models, 0.33 kPa + 1.48(SD) (MIGET model) and 0.12 kPa + 1.33(SD) (ALPE model). The ALPE model's ability to compare well with MIGET and simulate P_aO₂ accurately might mean that it is interchangeable with the MIGET model in a clinical setting where only a limited amount of data are readily accessible.

The answer to both these research questions seems therefore positive, but some care should be taken when interpreting the results. Oleic acid induces a quite homogeneous lung damage, and as such it is possible that more complex models are required to describe heterogeneous lung damage such as occurs in ARDS. However, the simple model still represents a significant

improvement to the usual clinical standard describing oxygenation problems, i.e. using the $\text{PaO}_2/\text{FIO}_2$ ratio, and may therefore have application in clinical situations where the MIGET technique is not practical.

2.4 ALPE - systems development and clinical application.

An automated system combining the ALPE model of pulmonary gas exchange with a technique for varying FIO_2 to achieve SpO_2 over the range 90-100% has been developed [26] and is known as the Automated Lung Parameter Estimator (ALPE). In the research version of 2002 [26], the system consisted of a ventilator, a gas analyser with pulse oximeter, and a computer. The computer programs controlled the experimental procedure, collecting data from the ventilator and gas analyser, and estimating pulmonary gas exchange parameters. A Bayesian technique has been developed to for recursive parameter estimation during FIO_2 variation [27] which can be used to guide the selection of appropriate FIO_2 levels. Figure 4 illustrates ALPE in its research form from 2002, and its current commercial form ALPEessential™ as developed by Mermaid Care A/S. ALPE is patented [28] and ALPEessential™ is CE approved for medical use.

The ALPE technique has been applied in a large number of patients primarily to assess whether it can be used to describe changes in the status of the lungs in the clinic. This question has, and continues to be, addressed by a series of clinical PhD projects [29, 30], and is not therefore the focus of this dissertation. To date, these have focused upon the post-operative effects of surgical interventions on gas exchange and the time course of changes thereafter [31-35]. The major finding of these studies, from the perspective of gas exchange, has been the peak in gas exchange abnormalities seen in the late post operative period, i.e. 2-3 days, consistent with the reported large numbers of cases of episodic night time hypoxaemia during this same period [36].

Studies have also been performed illustrating that ALPE can characterize gas exchange in a range of ICU patients [18, 22], and in those presenting at cardiology departments [37, 38]. In cardiology patient ALPE may be a useful tool for evaluating the degree of edema and monitoring the effects of therapeutic intervention in patients with left sided heart failure resulting in decompensation [38].



Figure 4 – The Automatic Lung Parameter Estimator (ALPE) system, in its research [26], and commercial (ALPEessential™) forms. (The research version is printed with kind permission from Springer Science+Business Media: J Clin Monit Comput, The Automatic Lung Parameter Estimator (ALPE) system: Non-invasive estimation of pulmonary gas exchange parameters in 10-15 minutes, 17, 2002, page 44, Rees SE, Kjærgaard S, Thorgaard P, Malczynski J, Toft E, Andreassen S, figure 1. The commercial picture is with kind permission of Mermaid Care A/S)

2.5 Summary of chapter.

This chapter has discussed the state of the art for describing pulmonary gas exchange in the clinical and experimental settings, illustrating the large difference between that understood and that systematically used in the clinic. A mathematical model has been developed which, in combination of variation in inspired oxygen fraction, can describe pulmonary gas exchange more accurately than current clinical techniques. This technique and model have been developed into research and commercial tools, and evaluated both in the clinical setting and when compared to the reference technique (MIGET) for experimental measurement of pulmonary gas exchange.

3.The acid-base and oxygen status of blood

3.1 Introduction

To simulate changes in mechanical ventilation strategy on patient state requires a model of the acid-base and oxygen status of the blood. The mathematical modeling and clinical interpretation of acid-base status remains an area of fierce debate in the literature. In the 1970's, this debate focused around the clinical use of the mathematical models of Siggaard-Andersen [39]. In a large series of papers he and co-workers formulate models of acid-base chemistry which for many remain the basis of clinical interpretation. In short, these include the Henderson-Hasselbach equation, the Van Slyke equation for calculating the buffering properties of the blood [40], and a formulation of the oxygen dissociation curve including the Bohr-Haldane effects [41]. Graphical solution of these equations can be viewed as two nomograms [42,43,44], the latter of which provides clinical interpretation of patient state and is included in some commercial blood gas analysers.

The models of Siggaard-Andersen and co-workers were criticized during the 1970's, in what has become known as the Great Trans-Atlantic debate [45]. This criticism was initiated by the work of Schwartz and co-workers [46,47] who in showing bicarbonate distribution to interstitial fluid illustrated the lack of agreement between the in vitro and in vivo buffering curves of blood. They argued therefore that base excess (BE) was unstable, and suggested that pH and bicarbonate (HCO_3) be the primary variables used to quantify acid-base status. This led to a new formulation of BE in the extra-cellular fluid (ECF), by Siggaard-Andersen, a value which then remained stable regardless of the distribution of bicarbonate across different extra cellular fluid compartments. Despite this, the two schools persist and the clinical interpretation including BE has never readily been adopted in North America.

In the 1980's the literature debate changed focus somewhat following the work of Peter Stewart [48] which has received much focus recently [49]. Stewart formulated mathematical models for the acid-base chemistry of any body fluid based on strong ion theory, where link between electrolyte and acid-base status was explicitly modeled, through the strong ion difference (SID), i.e. the difference between strong cations and anions. This point was in itself not new, being recognized much earlier by Singer and Hastings [50]. Indeed, the Siggaard-Andersen models

including anion gap in its corrected form [51], can be seen as approximately mathematically equivalent [52]. The fact that the approaches can be considered complementary has been recognized by a few authors [52,53,54], and studies have been performed comparing the clinical use of parameters calculated using either approach [55]. However, as discussed by Matousek et al [52], great care should be taken when interpreting these studies to make sure that parameters compared from each approach are indeed comparable. Parameters such as BE and strong ion gap (SIG) are not, the former is a measure of buffering the latter a measure of unmeasured anions.

The main contribution of Stewart has probably been twofold. First, he has focused attention on the causes of metabolic acidosis, in particular in disorders like hyperchloraemic acidosis, where changes in strong ion difference or buffer base can be due to electrolyte disturbances [56]. In this context it is important to realize that Siggaard-Andersen and co-workers never suggested that acid-base changes occurred in isolation of electrolytes. Stewart has however focused the research community on this link, and some authors have proposed that Stewart's approach is a revolution in our understanding of acid-base balance [55,56].

The other major advantage seen in the strong ion approach concerns the simplicity, or perhaps transparency, of the modeling methodology adopted. Stewart formulated his model from mass balance and mass action equations, with state variables describing the necessary components of the body fluid, e.g. for plasma, protein/phosphate (Atot), carbon dioxide (PCO_2) and buffer base (SID). This simplicity is beneficial in that the mathematical equations are similar to the reaction equations, improving their understanding. In addition, the state variables have an additive property such that common physiological processes, like the mixing of body fluids, are easily simulated using conservation of mass principles. Typically, Stewart's equations have been used to describe cell free fluids, e.g. cerebrospinal fluid [54,57], however more recent work has applied Stewart's approach to muscle cells [58] and blood [59].

When looking at the necessary modeling complexity required to represent acid-base and oxygenation transport in a ventilator management system, several requirements are clear. First, the models of blood should be convenient to use in a compartment modeling approach. For example, it should be possible to simply and accurately simulate the situation where blood coming from different regions of the lungs mixes before entering the arterial compartment. In this sense, Stewart's mass-balance mass-action representation of plasma is a convenient

mathematical formulation. A second requirement is that the models be covering. This means representation of all the relevant components of blood, and their relation to oxygen transport and acid-base chemistry. This includes incorporation of modeling of the red blood cells, available only in the newest Stewart type models [59], and representation of Bohr-Haldane effects, i.e. the oxygen binding to haemoglobin or the competitive binding of oxygen, hydrogen ions and carbon dioxide on haemoglobin. The Bohr-Haldane effects have not previously been included in any of the models formulated using the Stewart approach, but have been experimentally determined and mathematically described by Siggaard-Andersen and colleagues [60, 61].

3.2 Mathematical models of acid-base and oxygen status.

The approach taken here to modeling the acid-base of blood has been to formulate models with the approach of Stewart but the coverage of Siggaard-Andersen. In doing so Stewart's 3 components of extracellular fluid, in this case plasma, i.e. non-bicarbonate buffers (A_{tot}), SID/BB and CO₂ are extended to include the components of red blood cells, i.e. haemoglobin (Hb(RH)_bNH₃⁺), oxygen (O₂) and 2,3-diphosphoglycerate (DPG). The model formulated with these components, as illustrated in figure 5, has been described in detail previously [62,63], a brief summary follows.

For plasma, lumped bicarbonate and non-bicarbonate buffer reactions (R1r, R2r) are included. For the erythrocyte fraction of blood, haemoglobin is written as Hb(RH)_bNH₃⁺ to reflect the side chain (RH)_b and amino end (-NH₃⁺) buffering sites. Haemoglobin binding to H⁺, O₂ and CO₂ is drawn as three blocks of reaction equations A-C. Blocks A and B represent the binding of H⁺ to the amino end of the haemoglobin molecules protein chains and the oxygenated and deoxygenated forms of these. Block C represents the binding of H⁺ to the side chains of the amino acids.

In principle, 6 mass balance equations are required, one to describe each of the components of blood. Equation 1r accounts for the total CO₂ in plasma and red blood cells. Equation 2r accounts for the total non-bicarbonate buffers. Equation 3r accounts for the total haemoglobin in blood (Hb) and can be written in two ways: by counting the different chemical forms of the amino end of the haemoglobin chains; or by counting the different chemical forms of the amino side chain buffers (RH, R⁻) (equation 3br). Equation 4cr, accounts for the total buffer base in whole blood (BB), defined as the total concentration of weak base in blood which is written as a weighted

sum of that due to plasma buffers (equation 4ar) and that due to erythrocyte buffers (BB_e) (equation 4br). Equation 5r accounts for the total oxygen. No mass balance equation is included in the model for 2,3 DPG, assuming its value remains constant.

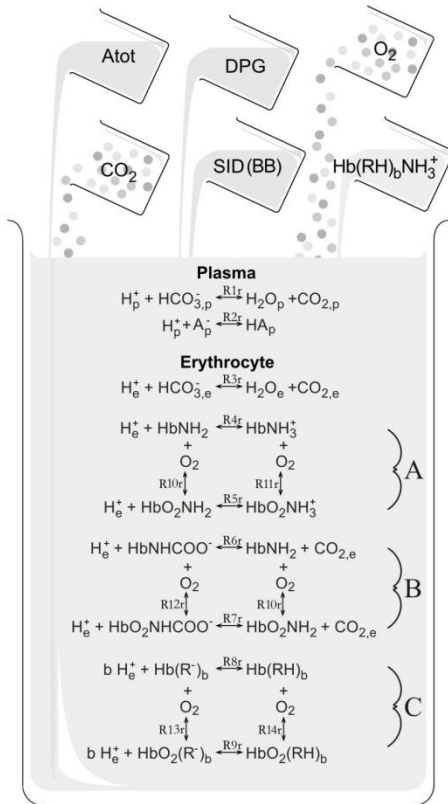

Mass balance equations

- 1r $tCO_2 = (CO_{2,p} + HCO_{3,p}^-) f_p + (CO_{2,e} + HCO_{3,e}^- + HbNHCOO^- + HbO_2NHCOO^-) f_e$
- 2r $Atot_p = A_p^- + HA_p$
- 3ar) $Hb = (HbNH_3^+ + HbNH_2 + HbNHCOO^- + HbO_2NH_3^+ + HbO_2NH_2 + HbO_2NHCOO^-) f_e$
- 3br) $Hb = (Hb(RH)_b + Hb(R^-)_b + HbO_2(RH)_b + HbO_2(R^-)_b) f_e$
- 4ar) $SID = BB_p = HCO_{3,p}^- + A_p^-$
- 4br) $SID_e = BB_e = HCO_{3,e}^- + b Hb(R^-)_b + b HbO_2(R^-)_b + HbNH_2 + HbO_2NH_2 + 2 HbNHCOO^- + 2 HbO_2NHCOO^-$
- 4cr) $BB = BB_p f_p + BB_e f_e$
- 5r) $tO_2 = O_{2,p} f_p + (O_{2,e} + HbO_2NH_3^+ + HbO_2NH_2 + HbO_2NHCOO^-) f_e$

Mass action equations

- 6r) $pH_p = pKHCO_{3,p} + \log_{10}(HCO_{3,p}^- / CO_{2,p})$
- 7r) $pH_p = pKa_p + \log_{10}(A_p^- / HA_p)$
- 8r) $pH_e = pKHCO_{3,e} + \log_{10}(HCO_{3,e}^- / CO_{2,e})$
- 9r) $pH_e = pKzd + \log_{10}(HbNH_2 / HbNH_3^+)$
- 10r) $pH_e = pKzo + \log_{10}(HbO_2NH_2 / HbO_2NH_3)$
- 11r) $pH_e = pKcd + \log_{10}(HbNHCOO^- / (HbNH_2 \cdot CO_{2,e}))$
- 12r) $pH_e = pKco + \log_{10}(HbO_2NHCOO^- / (HbO_2NH_2 \cdot CO_{2,e}))$
- 13r) $pH_e = pKzd_R + \log_{10}(Hb(R^-)_b / Hb(RH)_b)$
- 14r) $pH_e = pKzO_R + \log_{10}(HbO_2(R^-)_b / HbO_2(RH)_b)$
- 15r) $SO_2 = ODC(PO_2, pH, PCO_2, DPG)$
- 16r) $SO_2 = (HbO_2NH_3^+ + HbO_2NH_2 + HbO_2NHCOO^-) / Hb_e$
- 17r) $SO_2 = (HbO_2(RH)_b + HbO_2(R^-)_b) / Hb_e$

Physico-chemical properties

- 18r) $O_{2,p} = \alpha_{O_2} PO_2$
- 19r) $O_{2,e} = \alpha_{O_2} PO_2$
- 20r) $CO_{2,p} = \alpha_p PCO_2$
- 21r) $CO_{2,e} = \alpha_e PCO_2$
- 22r) $f_p = 1 - f_e$
- 23r) $f_e = Hb/21$
- 24r) $pH_e = 7.19 + 0.77 (pH_p - 7.4) + 0.031 \delta sO_2$

Siggaard-Andersen (BE and anion gap)

- 25r) $BE = BB - nBB$
- 26ar) $A_p^- - X^- = Na_p^+ + K_p^+ + 2Ca_p^{++} + 2Mg_p^{++} - Cl_p^- - HCO_{3,p}^-$

Stewart (SID)

- 26br) $SID = BB_p = Na_p^+ + K_p^+ + 2Ca_p^{++} + 2Mg_p^{++} - Cl_p^- - X^-$

Figure 5 – A mathematical model of the acid-base chemistry in blood [63]. (With kind permission from Springer Science+Business Media: Eur J Appl Physiol, Mathematical modelling of the acid-base chemistry and oxygenation of blood – A mass balance, mass action approach including plasma and red blood cells, 108, 2010, page 485, S.E Rees, E.Klæstrup, J. Handy, S. Andreassen, S.R. Kristensen, Figure 1B)

In addition 9 mass action equations (6r-14r) are required to account for the 9 reactions buffering H⁺ (R1r – R9r). Mass action equations could be formulated representing the remaining 5 reaction equations (R10r-R14r) representing the oxygen binding to haemoglobin. Instead, a

published model of the oxygen dissociation curve (ODC) [41,64] is included (equation 15r), and equations are included which define SO_2 from the other model variables, by counting either the amino ends (equation 16r) or the side chains (equation 17r).

Other equations describe the physico-chemical properties of blood. Equations 18r-21r describe the solubility of O_2 and CO_2 in plasma and red blood cells. Equation 22r states that the plasma and erythrocyte fractions sum to 1. Equation 23 states that the haemoglobin concentration in erythrocyte is a constant value of 21 mmol/l, such that the fraction of erythrocyte can be calculated as the haemoglobin concentration in blood divided by 21. A modified form [39] of the empirical relationship relating pH in the plasma and red blood cells derived by Funder and Weith [65], is used to describe the link between plasma and red blood cells acid-base status without the need to represent electrolyte transport across cell membranes. This simplification means that the model cannot calculate values of electrolytes in the plasma and red blood cells.

Equation 25r, the calculation of base excess (BE) as the concentration of buffer base above normal (nBB). Equations 26ar and 26br, represent the two approaches to catering for electrical neutrality as either anion gap (A_p^-), or strong ion difference (SID).

The parameterization of this model is described in detail in Rees and Andreassen [62]. The parameter describing bicarbonate buffering (pKHCO_3) in the plasma and erythrocyte was fixed at the well know value. The parameter describing non-bicarbonate buffering in plasma (pK_{a_p}) was estimated from only two data points, with measured values of pH_p and PCO_2 . The parameters describing haemoglobin buffering in fully oxygenated blood (pK_{z_o} , pK_{c_o}) were estimated from only three data points with measured values of pH_p and PCO_2 , and a value of the normal buffer base in erythrocyte (BB_e). The parameters describing haemoglobin buffering in fully deoxygenated blood (pK_{z_d} , pK_{c_d}) were estimated from only two data points, the Haldane coefficient at $\text{pH}_e = 7.2$ in the absence of CO_2 and the Haldane coefficient at $\text{pH}_e = 7.2$, at $\text{PCO}_2 = 5.33 \text{ kPa}$ [60,61].

Applying this model in a ventilator management system required including the blood model as part of a whole body model including circulation, respiration and other body stores of the components of blood related to acid-base and oxygen status. This model, described in detail in Andreassen and Rees [66], is illustrated in figure 6.

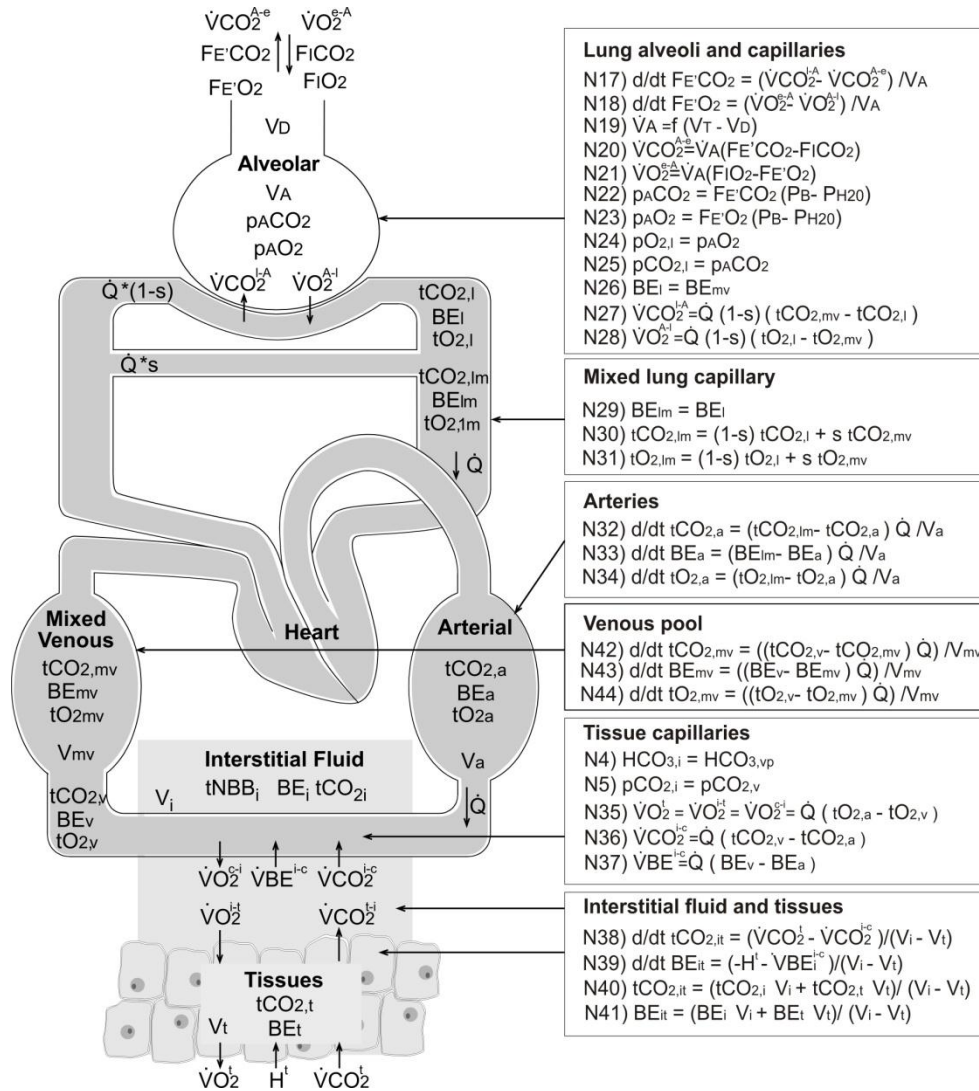

Figure 6 – the mathematical model of whole-body O₂ and CO₂ transport. Reproduced from [66] with kind permission of Begell House inc.

This model includes the model of blood, plus additional equations describing the acid-base chemistry of interstitial fluid and tissues. The model also includes differential and other equations describing transport of O₂ and CO₂ between compartments representing tissues, interstitial fluid, arterial and venous blood, and lungs as illustrated in figure 6. These equations have been described in detail previously [66]. Briefly, equations N17 and N18 are differential equations for updating the state variables of the lung compartment, i.e. the fraction of O₂ and CO₂ in the alveoli; equation N19 describes alveolar ventilation; equations N20-N21 and N27-

N28 describe the transport of O_2 and CO_2 between the lungs(l), environment(e) and alveoli(A); equations N22 and N23 calculate alveolar gas pressures from end tidal fractions accounting for the partial pressure of saturated water vapour; equations N24 and N25 describe equilibration between alveolar air and capillary blood; equations N26 and N29 described the assumption of no strong acid production in the lungs, i.e. equivalence in BE between lung capillary, mixed lung capillary and mixed venous blood; equations N30 and N31 describe mixing of lung capillary and pulmonary shunted blood; equations N32-N34 are differential equations for updating state variables in the arterial compartment, i.e. total CO_2 concentration, base excess, and total O_2 concentration; equations N42-N44 are similar differential equations for the venous blood compartment; equations N4 and N5 describe the assumption of equilibrium of bicarbonate and CO_2 between venous blood and interstitial fluid; equation N35 expresses the assumption of steady state for O_2 between tissue, interstitial fluid and tissue capillary blood with equivalence of flows between these, all of which may be calculated from the Fick equation; equation N36 describes the transport of CO_2 between interstitial fluid and capillary blood; equation N37 describes the change in BE between arterial and venous blood; equations N38 and N39 are differential equations for updating state variables in the combined interstitial fluid and tissue compartment, i.e. total CO_2 concentration and BE; equations N40 and N41 describe total CO_2 and BE in the combined interstitial fluid and tissue compartment as the weighted sum of the individual concentrations.

3.3 Model validation.

The models of blood and whole body transport have been evaluated to see if they can simulate correctly data describing plasma, red blood cells, whole blood and whole body transport of O_2 and CO_2 . In addition the model of acid-base has been evaluated to see whether it has sufficient complexity to be useful in the INVENT system. These evaluations were performed in two phases: an evaluation of the models against previously published data; and evaluation of the models against studies specifically designed to test relevant functionality. These two evaluation phases are now discussed in turn.

3.3.1 Evaluation against previously measured data

This evaluation was reported in Rees and Andreassen [62] and Andreassen and Rees [66]. In Rees and Andreassen [62] the model of blood was shown to accurately reproduce data obtained from Siggaard-Andersens curve nomogram [42, 43], as exemplified in figure 7A. These

simulations accurately described: the addition or removal of CO₂ or strong acid to plasma; the addition or removal of CO₂, strong acid, or haemoglobin to blood; and the effects of deoxygenating erythrocyte or blood at a wide range of values of pH and PCO₂. In addition the model was shown to be able to simulate data [60,61] describing values of the Haldane coefficient and Base Excess coefficient over a wide range of values of pH and PCO₂, as exemplified in figure 7b. This evaluation illustrates the generality of the model in that substantial functionality can be validated in a model which includes relatively few parameters, identified from very little data.

In Andreassen and Rees [66] the model of whole body CO₂ and O₂ transport was shown to reproduce the results of published experiments when used to simulate: normal conditions in the lungs, arterial and venous blood, interstitial fluid, and tissues during normal ventilation and the characteristic two-exponential response to changes in minute ventilation [67]. In addition, a steady state version of the model could reproduce the relationship between arterial blood values of PCO₂ and HCO₃ during inspiration of different fractions of CO₂, as illustrated in figure 8. This latter data set is the characteristic distribution of HCO₃ between blood and interstitial fluid [47], which was the basis for the criticism of BE leading to the Great-Transatlantic debate.

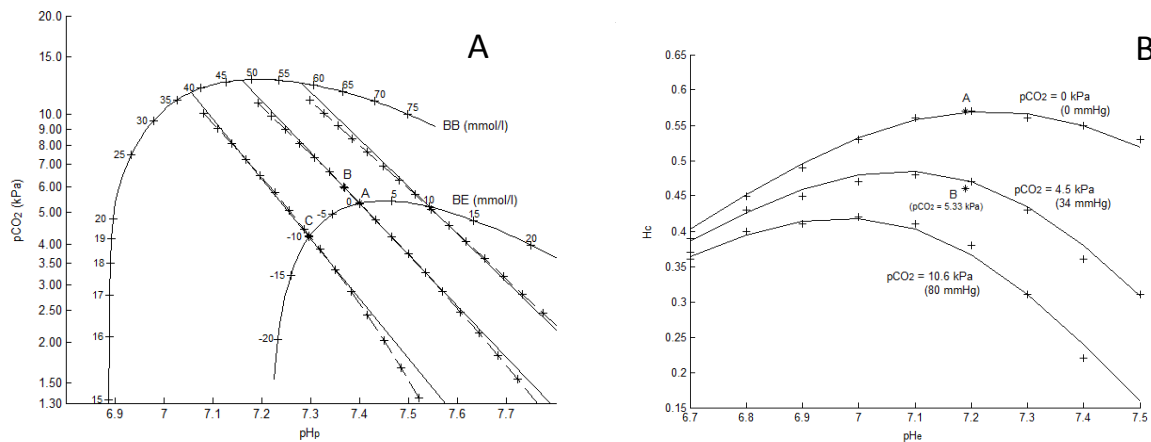

Figure 7 – Validation of the model of acid-base chemistry – A) reproduction of buffer curves on the Siggaard-Andersen curve nomogram [43,44] (crosses: model simulations, solid lines: nomogram buffer lines), and B) reproduction of Haldane coefficients (Hc) [60] at varying pH (crosses: data from [60], curves: model simulations. Both figures are reproduced from [62] with kind permission of Begell House inc. Details of models simulations can be found in [62].

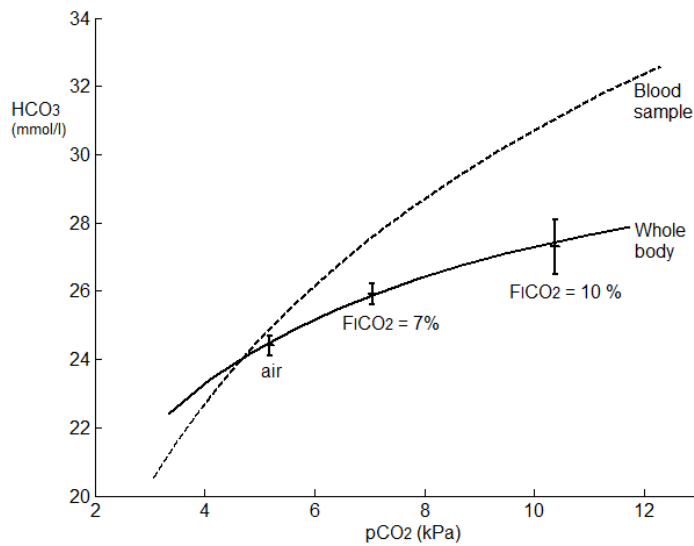

Figure 8 – Validation of the model of acid-base chemistry – reproduction of in whole body PCO_2 versus HCO_3^- curves plotted against the data of [47]. Reproduced from [66] with kind permission of Begell House inc. Details of models simulations can be found in [66].

3.3.2 Evaluation with studies designed specifically to test relevant functionality

The purpose of the model of acid-base chemistry described in [62] was to both have the functionality of the models of Siggaard-Andersen, i.e. including red blood cells and Bohr-Haldane effects; with the formulation of Stewart, i.e. the mass-action mass balance formulation. The formulation of Stewart was necessary to enable the easy use of the model in a whole body compartmental model, where simulations such as the mixing of blood are necessary.

To evaluate whether the acid-base model could accurately and precisely describe blood mixing a series of studies was designed in which blood samples at different gas partial pressures are mixed, and the model evaluated to see if it can simulate this mixing process. Three studies were designed

- 1) Mixing of blood with different PCO_2 and PO_2 levels, but where all other factors, i.e. plasma protein concentration, haemoglobin concentration, electrolyte concentrations and metabolite concentrations were normal.

- 2) A similar study to 1), but using the blood from acutely admitted patients presenting at departments of lung medicine, such that this blood may have abnormal levels of other variables.
- 3) A similar study to 1), but using the blood from patients residing at the intensive care unit, such that this blood may have severely abnormal levels of other variables.

These three studies are underway with, at the time of writing this dissertation, only the first having reached publication [63]. A short summary of the methods and results of that study now follows.

Peripheral venous blood was sampled from 21 normal subjects into a 9 ml venous blood collection tube. A 1-2 ml sample of blood was drawn from the 9 ml syringe into a syringe which was labeled 'd' for deoxygenated (i.e. venous blood), and analysed immediately to obtain standard acid-base electrolyte and metabolite values. A further 1 ml sample was drawn from the same 9 ml syringe into a syringe and labeled 'm' for mixed. The remaining approximately 6 ml was then poured into a beaker open to the air for 15 minutes. A 1-2 ml sample was then drawn from the beaker into a syringe labeled 'o' for oxygenated. A further 1 ml was then drawn into the syringe marked 'm'. The blood samples marked 'o' and 'm' were then analysed to obtain values of acid-base, oxygenation, metabolite and electrolyte status.

In order to estimate the fractions of "d" and "o" in the mixed sample 30 μ l of physiological saline containing creatinine at a concentration of 120 mmol/L, was added to the beaker at the start of the period where blood was exposed to room air. Creatinine was measured in all samples as part of acid-base, oxygenation, metabolite and electrolyte status.

The model was used to simulate this mixing process as illustrated in figure 8, according to the steps described in the legend.

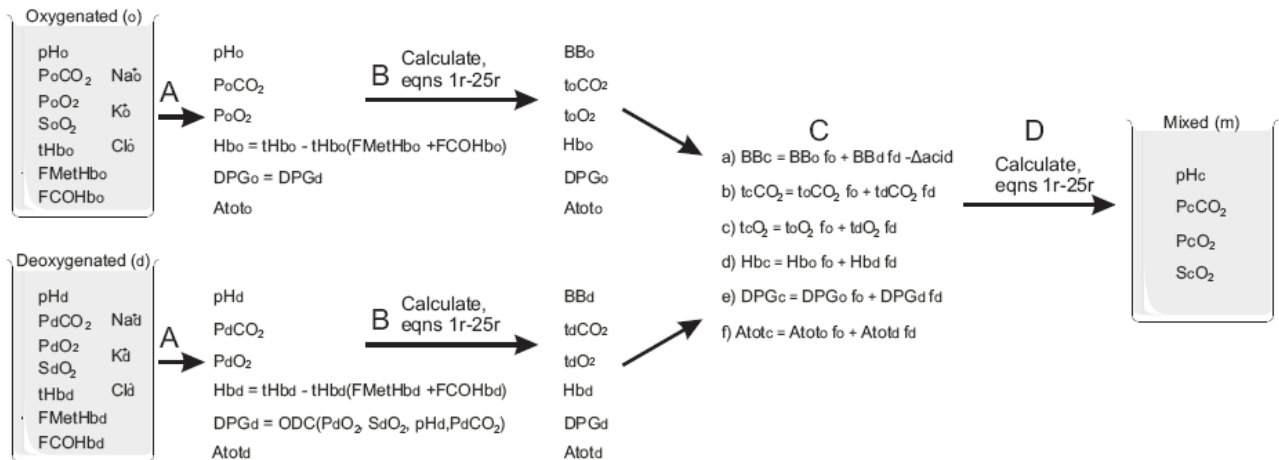

Figure 9 – Use of the mathematical model of acid-base [62] to simulate the mixing of blood. Step A represents determination of the values of variables (pH, PCO₂, PO₂, Hb, DPG and Atot) necessary for solution of the acid-base model [62, 63]. In Step B the acid base model [62,63] is used to calculate the concentration of blood components. Step C simulates mixing as a weighted sum of concentrations in the two samples; In Step D variables representing the mixed sample (BB_c, t_cCO₂, t_cO₂, Hbc, DPG_c, Atot_c) are used to solve the acid-base models for all variables.

(With kind permission from Springer Science+Business Media: Eur J Appl Physiol, Mathematical modelling of the acid-base chemistry and oxygenation of blood – A mass balance, mass action approach including plasma and red blood cells, 108, 2010, page 489, S.E Rees, E.Klæstrup, J. Handy, S. Andreassen, S.R. Kristensen, Figure 2)

Figure 10 illustrates the Bland-Altman plots from Rees et al. [63] comparing values of pH, PCO₂, PO₂ and SO₂ in measured (m) and calculated (c) values of mixed blood samples using the model of Rees and Andreassen [62]. For all variables, model calculated values are close to those measured with very little bias and a precision similar to that for direct measurement of blood in routine clinical practice. This shows the ability of the model to simulate the mixing of blood samples with the same electrolyte and metabolite status, but with different partial pressures of O₂ and CO₂. Correct mixing of these samples therefore evaluates the ability of the model to account for the effects on acid-base status of respiratory disturbances which simultaneously change O₂ and CO₂. Studies 2 and 3 are required to perform the same evaluation in situations of abnormal

plasma protein concentration where the fixed values of A_{tot} used here ($A_{tot} = 23.5$ meq/l) may not be appropriate and where electrolyte or metabolite values may be disturbed.

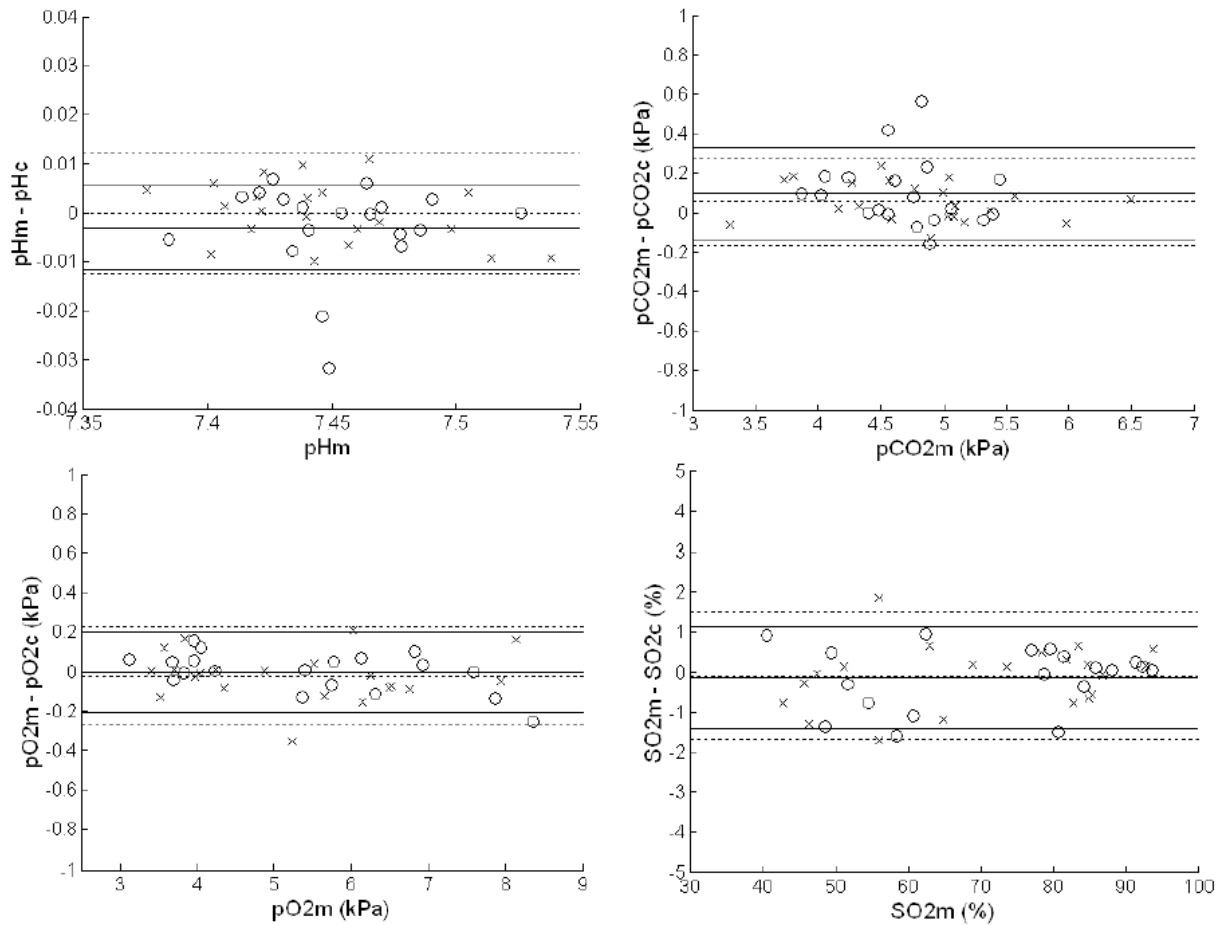

Figure 10 – Bland-Altman plots comparing measured (m) and calculated values in mixed blood samples. Two blood samples were taken for each subject and are plotted as crosses and circles, respectively. Dashed lines represent the mean bias ± 2 SD for crosses, and solid lines for circles [63]. (With kind permission from Springer Science+Business Media: Eur J Appl Physiol, Mathematical modelling of the acid-base chemistry and oxygenation of blood – A mass balance, mass action approach including plasma and red blood cells, 108, 2010, page 491, S.E Rees, E.Klæstrup, J. Handy, S. Andreassen, S.R. Kristensen, Figure 3)

3.4 ARTY – System development and clinical application.

As postulated in the introduction to this dissertation, development of physiological models tends to raise new interesting questions relating to our understanding of physiology and to potential clinical and commercial applications of the models.

One such idea is presented in this section of the dissertation, the idea being that blood taken from peripheral venous measurements and analysed for acid-base and oxygenation status can be mathematically arterialized to calculate the equivalent variables in arterial blood. This idea, and the associated method, has been patented [68] and hopefully will be available commercially in the near future.

The idea has several possibilities for improving patient care: Patients residing in Departments of lung medicine typically do not have indwelling catheters. Evaluation of acid-base and oxygenation status therefore typically involves painful arterial puncture with the associated risks of complications. Typically these patients are admitted for a period of 4-5 days, and during that time have repeated arterial samples. Replacement of these with mathematically arterialized venous samples therefore represents a real potential benefit to the patient. In addition, patients acutely admitted to the emergency medical department have arterial punctures made only if suffering from dyspnea. For these patients painful arterial punctures might be eliminated by the technique. If admitted to the emergency medical department without dyspnea no quantification of acid-base and oxygenation status is performed, this being despite the fact that peripheral venous blood samples are typically taken in all patients. Analysis of acid-base and oxygenation status using the technique may provide useful screening in these patients.

The arterialisation technique is described in the next section, with focus on how the mathematical model of acid-base and oxygenation status is applied. The evaluation of the method has until now followed a two stage process

- 1) Evaluation in a broad range of intensive care patients.
- 2) Evaluate in patients residing in the department of pulmonary medicine.

The first of these has been the focus of a PhD project [69, 70, 71]. Since the results of these stages are similar only the latter will be discussed in this dissertation.

3.4.1 Mathematical arterialisation method

Figure 11 illustrates the method for calculating values of arterial acid–base status from values in the peripheral venous blood, plus arterial oxygen saturation measured with a pulse oximeter. The principle of the method is that venous values can be mathematically transformed into arterial values by simulating the transport of blood back through the tissue.

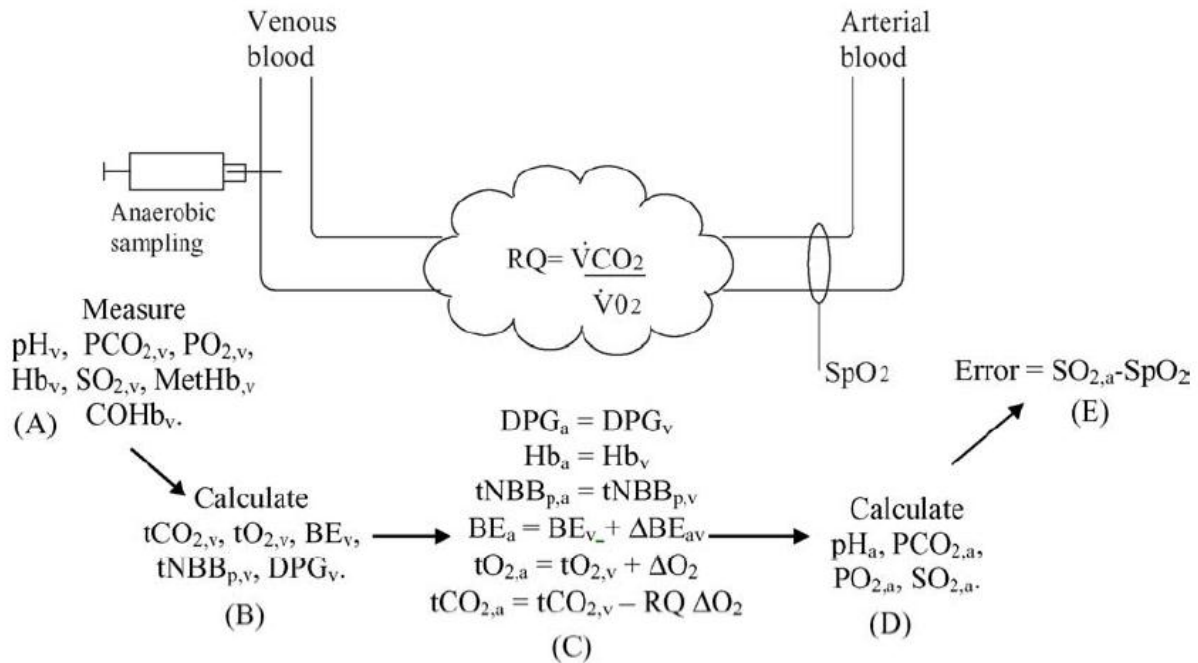

Figure 11 – Mathematical arterialisation [72]. (Reprinted from: *Comput Methods Programs Biomed.*, 81(1), Rees S.E, Toftegaard M, Andreassen S., A method for calculation of arterial acid-base and blood gas status from measurements in the peripheral venous blood, page 19, 2006, with kind permission from Elsevier.

The steps included in the method are presented in detail in Rees et al [72] with a brief summary given here. Step A: An anaerobic venous blood sample is drawn and measurements of pH_v , $PCO_{2,v}$, $SO_{2,v}$, $PO_{2,v}$, Hb_v , Methaemoglobin ($MethHb_v$), and carboxyhaemoglobin ($COHb_v$) are taken. Step B: Venous measurements are entered into the acid base model to calculate the total CO_2 concentration ($tCO_{2,v}$), total O_2 concentration ($tO_{2,v}$), base excess (BE_v), and the concentration of 2,3-diphosphoglycerate (DPG_v) in venous blood. The units of all these variables are concentration, as for the blood mixing experiments described in the previous section, these

variables are therefore convenient to perform simulations of the addition or removal of gasses. Using the variables describing venous blood ($t\text{CO}_{2,v}$, $t\text{O}_{2,v}$, Hb_v , BE_v , DPG_v , $t\text{NBB}_{p,v}$) calculation of the respective variables in arterial blood can now be performed (Step C). Concentrations of haemoglobin, the plasma nonbicarbonate buffer, and 2,3-DPG are assumed to be the same in arterial and venous blood. The amount of strong base added to the blood during its passage through the tissue is assumed to be zero, i.e. $\text{BE}_{av} = 0$ mmol/l and therefore $\text{BE}_a = \text{BE}_v$. Calculation of the total concentration of O_2 and CO_2 in arterial blood is performed by simulating addition of a concentration of O_2 (ΔO_2), to the venous blood and removing a concentration of CO_2 (ΔCO_2 , where $\Delta\text{CO}_2 = \text{RQ} * \Delta\text{O}_2$) from the venous blood. The acid-base model is then used to calculate the remaining variables describing arterialised blood, i.e. pH_a , $\text{PCO}_{2,a}$, $\text{PO}_{2,a}$, and $\text{SO}_{2,a}$ (Step D). Calculated arterialised oxygen saturation $\text{SO}_{2,a}$ is then compared with that measured by the pulse oximeter (SpO_2) (Step E), the difference between the two giving an error = $\text{SO}_{2,a} - \text{SpO}_2$. By varying the value of ΔO_2 and repeating steps C–E (Fig. 1), a value of ΔO_2 can be found for which the error is zero. At this point, the ΔO_2 represents the concentration of O_2 added, and RQ multiplied by ΔO_2 the concentration of CO_2 removed, so as to transform venous to arterialised blood. For this value of ΔO_2 , calculated values of all variables describing arterialised blood (pH_a , $\text{PCO}_{2,a}$, $\text{PO}_{2,a}$, and $\text{SO}_{2,a}$) should be equal to measured arterial values.

3.4.2 Evaluation of the ARTY method in patients residing in the department of pulmonary medicine.

This section describes a summary of the study published in [73]. Arterial and peripheral venous blood was sampled from 40 patients previously diagnosed with chronic lung disease, and either acutely admitted or visiting the Department of Respiratory Diseases for their biannual clinical assessment. Patients' acid base status was described by median (range) values as follows: pH 7.418 (7.237–7.508), PCO_2 6.26 (3.92–11.2) kPa, PO_2 8.97 (6.11–15.70) kPa. Peripheral venous and arterial blood samples were taken along with pulse oximetry measurement of SpO_2 . The ARTY method was then used to calculate arterial values from peripheral venous values and calculated arterial values (ca) compared with measured (a) using Bland-Altman plots, and scatter plots of measured versus calculated. Values of bias and standard deviation between measured and calculated arterial values were calculated along with values of correlation coefficients (r^2) and parameters for regression lines. The results of this comparison can be seen in figure 12.

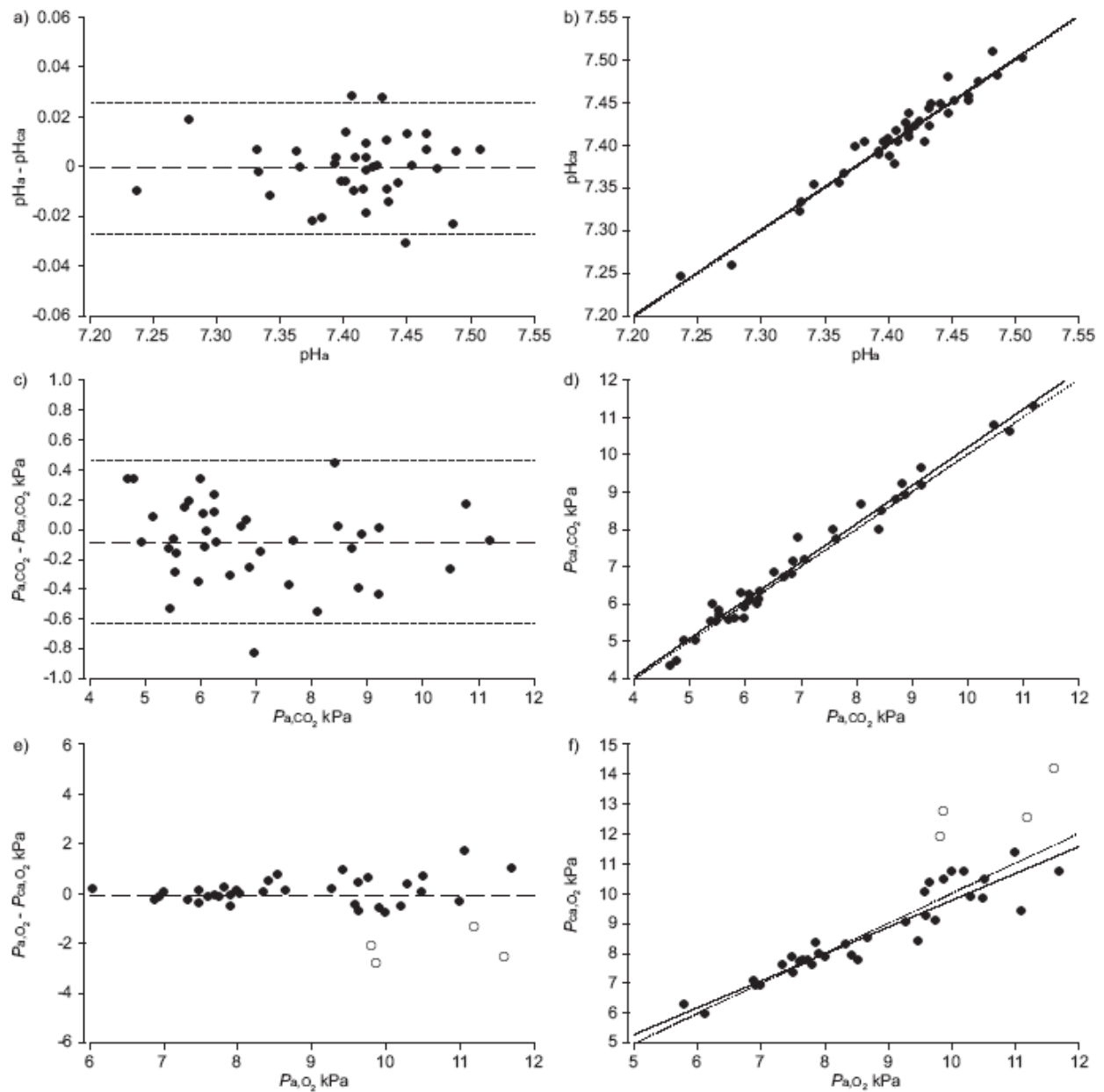

Figure 12 – Evaluation of the arterialisation method in patients residing in pulmonary medicine.

a, c and e) Bland–Altman and b, d and f) scatter plots comparing measured arterial (a) and calculated arterial (ca) values. Reproduced from [73], with kind permission of the European Respiratory Society Journals Ltd.

Measured and calculated values of pH and PCO_2 correlated well, with the difference between them having a very small bias and standard deviation ($pH -0.001 \pm 0.013$, $PCO_2 -0.09 \pm 0.28$ kPa).

The method was also shown to calculate PO_2 sufficiently accurately for clinical use (PO_2 0.11 ± 0.53 kPa), in situations where $SpO_2 \leq 96\%$, i.e. in all but 4 of the patients. Calculated correlation coefficients were (r^2 for pH= 0.95, r^2 for $PCO_2 = 0.98$, r^2 for $PO_2 = 0.86$).

3.4.3 Sensitivity of the ARTY method to assumptions and measurement error.

The results of this study were very similar to those published describing, primarily, patients residing in the ICU [71]. However, to understand whether these results reflect in a broader population, it was necessary to consider the sensitivity of calculations to measurement error and to the assumptions contained in the method. This sensitivity analysis was published in [72,73], and a summary follows.

Two major assumptions exist in the method: first that the amount of strong acid added to the blood as it passes the tissues is a very small or zero, i.e. that (ΔBE_{av}) is approximately zero; and that the respiratory quotient over the sampling site may be assumed constant and approximated as an average value (RQ= 0.8). These assumptions are justified by the usual clinical practice of taking peripheral blood samples in only warm well perfused sites, where anaerobic metabolism is probably not substantial, and transient acid-base disturbances are unlikely.

Sensitivity analysis [72] has shown that variation in ΔBE_{av} of 0.2 mmol/L gives rise to quite small errors in calculated pH, PCO_2 and PO_2 of 0.006, 0.08 kPa and 0.07 kPa, respectively. In addition, the results presented in our studies [71,72] are inconsistent with large changes in base excess across the peripheral sampling site. Sensitivity analysis has also shown [72] that the literature reported variation in RQ variation of 0.08 gives rise to only small errors in pH, PCO_2 and PO_2 of 0.005, 0.10 kPa and 0.06 kPa, respectively.

Measurement errors can be present in the measurement of venous blood and in pulse oximetry SpO_2 . Rees et al [72] showed that calculations performed using the method are insensitive to errors in measurement of venous blood gases. The standard deviation of measurement in SpO_2 reported by large European studies is quite large, i.e. 2%. To be useful, it is therefore important that the method is tolerant to pulse oximetry errors as much as $\pm 4\%$, i.e. the 95% confidence interval. Errors in SpO_2 of $\pm 4\%$ have been shown to give only small variation in calculated arterial pH and PCO_2 , these errors being fairly constant over the range of SpO_2 values [73].

The errors in calculation of arterial PO₂ due to pulse oximetry are illustrated in figure 13, for the clinically interesting range of PO₂. As discussed previously [73], a pulse oximeter that reads too low, as represented by the bottom dashed line on the figure, potentially results in unnecessary supplementary oxygen, fluids or other intervention, i.e. there is no risk of hypoxaemia due to the pulse oximeter reading too low. For a pulse oximeter that overestimates oxygen saturation, maximal errors exist when the true value is $\geq 96\%$. These errors are clinically unimportant, as at these levels the patient does not require oxygen therapy. The effects of error in SpO₂ on the assessment of low arterial PO₂ is seen figure 13. Conveniently, errors in predicted PO₂ reduce at lower oxygen levels, i.e. the error is least important where the information is most useful. To illustrate this, three points were drawn on this figure and the following conclusions drawn: if the calculated PO₂ is ≥ 12.5 kPa, then the true PO₂ is >9 kPa (point A); if the calculated PO₂ is ≥ 10 kPa, then the true PO₂ is >8 kPa (point B); if the calculated PO₂ is ≥ 8 kPa, then the true PO₂ is >7 kPa (point C).

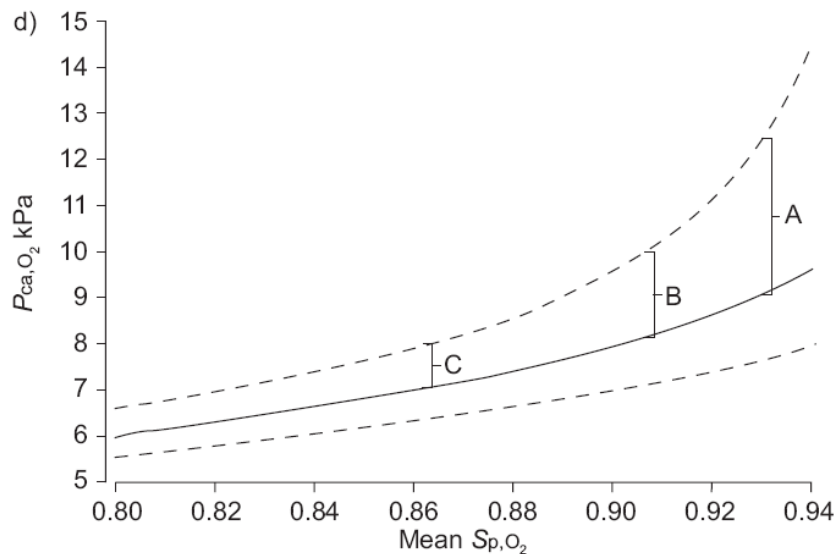

Figure 13 – ARTY simulations illustrating the sensitivity of calculated arterial PaO₂ (P_{ca,O₂}) to variation in peripheral oxygen saturation (Sp,O₂) Plots are drawn for mean Sp,O₂ (solid curve) and mean Sp,O₂ $\pm 4\%$ (dashed line). Reproduced from [73] with kind permission of the

European Respiratory Society Journals Ltd.

3.5 Summary of chapter.

This chapter has discussed the contrasting approaches to modeling of acid-base chemistry present in the literature. In doing so it has highlighted the need for models of a mass-action mass-balance nature, which have sufficient complexity to simulate change in any of the components of blood related to the respiratory gas and acid-base status. A mathematical model has been developed of the acid-base chemistry of blood using this mass-balance mass action approach and including the necessary functionality. This model has been included in a whole body model of O₂ and CO₂ transport, and these models have been validated against literature data, and from experiments involving the mixing of blood samples at different gas levels. The mathematical model of the acid-base chemistry of blood has been included in a system for converting the acid-base and oxygen status of peripheral venous gas to values in arterial blood. This technique has been described, as has its sensitivity to measurement error and assumptions, and its validation in patients with chronic lung disease.

4. Decision support for mechanical ventilation

4.1 Introduction

As reviewed recently [74,75], there currently exist numerous systems designed to either automatically control or provide decision support for the process of selecting mechanical ventilator settings. The most successful of these, evaluated in randomized controlled trials [1,2,3,4], and commercialized [1,4], are based on automating the heuristic reasoning of the clinician, through sets of rules. Those commercialized (SmartCare, ASV), focus on patients ventilated in support modes. SmartCare [76] is used to keep the patients with a “zone of comfort” for levels of CO₂ and the patients work of breathing (SmartCare); whilst adaptive support ventilation (ASV) [77] aims to optimize the balance between respiratory rate, tidal volume and inspiratory pressure from a specified required minute volume. For SmartCare, a strategy of regularly reducing pressure support, whilst keeping the patient within normal CO₂ levels and preventing exhaustion has been shown to reduce the time spent on mechanical ventilation, and reduce the number of unnecessary re-intubations following extubation [1]. Use of ASV has been shown to maintain PaCO₂ levels at clinical values with reduced peak airway pressure [78]. Development of intelligent systems for mechanical ventilation has therefore proved profitable. However, in general these systems have been applied to patients in support ventilator modes where the main clinical issues are the time to wean patient balanced against CO₂ levels and the potential to exhaust the patient. In these patients serious abnormalities in gas exchange or lung mechanics are not the primary consideration for selecting ventilator settings. In patients with ALI or ARDS, selection of appropriate mechanical ventilation has been associated with reduction in mortality [80]. In these patients a deeper understanding of the patient’s abnormalities may be necessary to provide correct therapy. Currently no commercial DSS are available which target this patient group, and it can be argued that systems providing a deeper understanding, such as model-based systems, are required.

Few DSS for mechanical ventilation, based upon physiological models, have been developed [80, 81, 82], with currently these systems having been evaluated by only simulation studies [80], via retrospective evaluation [81], or in small prospective studies [80,83]. Apart from the system

described in this dissertation, of the systems based upon physiological models, only the Sheffield Intelligent Ventilator Advisor (SIVA) system [82] remains under development.

This section describes the structure and function of the intelligent ventilator (INVENT) system, plus the current status in its evaluation and integration in intensive care. This system includes physiological models which are simple enough to be parameterized from clinical data, providing a deeper understanding of the patient state, and enabling predictions of “what if” scenarios; and utility functions to enable quantification of the ‘goodness’ of simulated outcomes, enabling selection of ventilator settings which maximize expected utility in a decision theoretic approach. This system is designed for controlled ventilator modes, focusing on the situations where a deeper understanding of the patient may be most profitable.

4.2 The Intelligent Ventilator (INVENT) system.

Figure 1 illustrates the structure of INVENT described previously [84]. The model of pulmonary gas exchange included in ALPE is integrated with the acid-base model, the whole body O₂ and CO₂ transport model and a rudimentary model of lung mechanics. These models are tuned to the individual via parameter estimation, this being possible by measures of ventilatory pressures and volumes, and by performing an ALPE experiment. The models can then be used to simulate the effects of changes in ventilator settings on both pressures and volumes in the lung, and the oxygenation and acid–base status of the blood. A steady state version of the whole body model of O₂ and CO₂ transport is included in the system allowing instantaneous predictions of steady state conditions. Also represented in the system are mathematical penalty functions which quantify clinical preference to the goals and side effects of ventilator therapy including: sufficient oxygenation; minimizing the risk of acidosis and alkalosis, and minimizing the risk of ventilator induced lung injury. An optimization algorithm is included to automate the process of finding the ventilator strategy which minimizes the total penalty, this then being regarded as the best setting.

The models of gas exchange, acid-base and oxygen status and whole body gas transport have already been described as part of this dissertation. For completeness, this section describes the model of lung mechanics used in the system and the penalty functions.

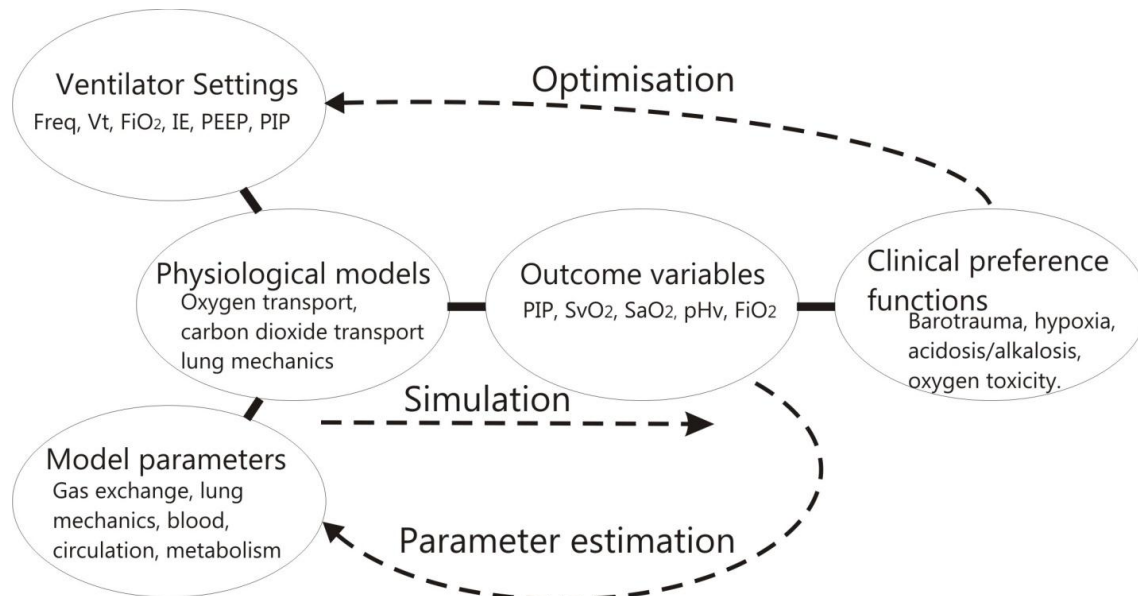

Figure 14 - The structure of the decision support system, illustrating the components of the system (ovals), and the functionality (dashed lines) [84]. (With kind permission from Springer Science+Business Media: J Clin Monit Comput, Using physiological models and decision theory for selecting appropriate ventilator settings, 20, 2006, page 423, Rees S.E, Allerød C, Murley D, Zhao Y, Smith B.W, Kjærgaard S, Thorgaard P, Andreassen S, figure 1)

The INVENT system is currently developed for controlled ventilator modes, i.e. where the patient does not have any spontaneous ventilation. This means that the system is intended for application in the most severely ill of intensive care patients. The current model of lung mechanics included in the system is very simple, and analogous to those used in mechanical ventilators. This model describes the relationship between peak inspiratory pressure (PIP) and tidal volume as a one compartmental model with a value of dynamic compliance (ml/cm H₂O) representing the whole lung, calculated as the change in volume, i.e., VT, divided by the corresponding change in pressure, i.e. PIP minus positive end expiratory pressure (PEEP). The assumption of constant dynamic compliance during controlled ventilation is only true for constant inspiratory flow, pressure and volume. Techniques exist for separating the effects of flow, volume and pressure changes on lung mechanics and these broadly fall into two types; those which identify characteristics from the routine ventilator cycle of the patient, e.g.

Spirodynamics [85,86], and those which perform long inflations and deflations techniques, often at low flows, to separate resistance and compliance and understand the changes in these variables at different flows, pressures and volumes [87,88,89]. The INVENT team has been involved in developing a technique which falls into the latter group [90]. This can identify the mechanical properties of the respiratory system rapidly in a pulsed inflation-deflation procedure. However, like all long inflation-deflation techniques, it suffers from the limitations of perturbing the patient outside their normal ventilator strategy, increasing ventilator pressures and the risk of the need for extra muscle relaxation to prevent the patient fighting the maneuver. Although involved in the development of such techniques, the INVENT team has not then incorporated them into the INVENT system.

The use of constant dynamic compliance places constraints on the simulations performed using the system. One possible solution is to vary inspiratory volumes or pressures over small enough ranges so that the pressure volume curve of the lungs can be considered linear and the compliance constant. In practice the ‘optimal’ settings obtained from the system might be seen as targets and small steps in ventilation taken toward these targets with checks for constant parameter values along the way.

The system includes mathematical functions of clinical preference, expressed as penalties associated with certain of the models variables, in a decision theoretic approach [5]. Penalty functions, illustrated in figure 15, are associated with: SaO_2 and SvO_2 , to represent local and global hypoxaemia; arterial pH, to represent acidosis and alkalosis; inspiratory oxygen level, to represent the risk of oxygen toxicity and absorption atelectasis; and positive inspiratory pressure, to represent the risk of barotrauma. The penalty associated with the risk of barotrauma is scaled with respiratory frequency (f), such that higher frequencies at the same pressure incur a greater penalty. The shape of the functions has been derived from input provided by a domain expert and the functions scaled, such that the total penalty can be represented as a sum of the individual functions. Scaling was performed by modifying the functions such that the system behaved similarly to an expert over 20 test case patients. It is important to note that these functions are extremely subjective and that different functions may be defined for different clinicians or intensive care specialties. This can be seen as strength of the approach, as explicit formulation of such functions may promote discussion of rational strategy toward ventilator management.

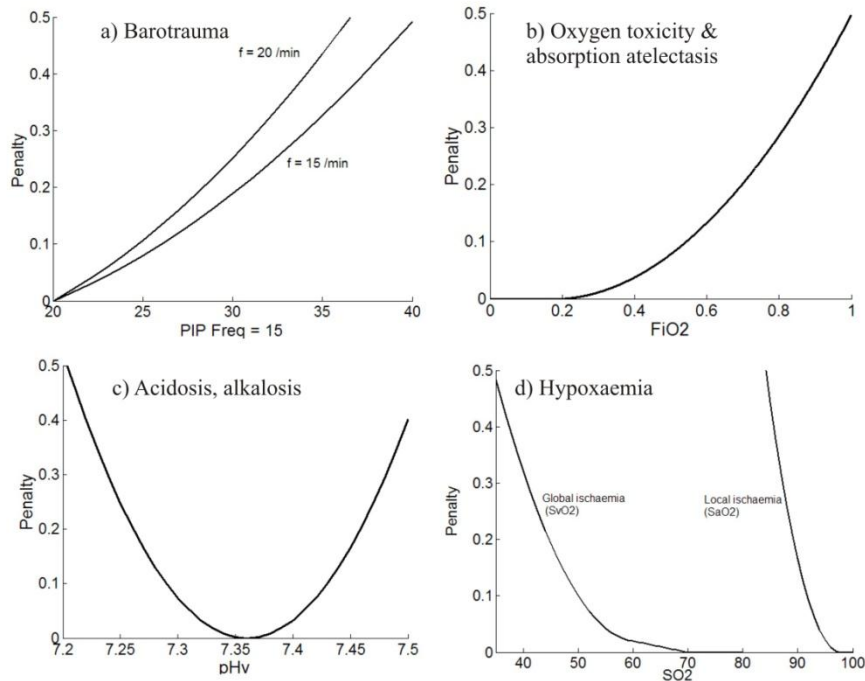

Figure 15. The penalty functions included in the DSS. Reproduced from [84] with permission. .
 (With kind permission from Springer Science+Business Media: J Clin Monit Comput, Using physiological models and decision theory for selecting appropriate ventilator settings, 20, 2006, page 425, Rees S.E, Allerød C, Murley D, Zhao Y, Smith B.W, Kjærgaard S, Thorgaard P, Andreassen S, figure 3)

4.3 Using the INVENT system.

Figure 16 illustrates the user interface for INVENT III including a patient. INVENT III is that version of INVENT which provides advice on three settings: inspired oxygen fraction, tidal volume and respiratory frequency. As described in [84], the interface is divided up into three sections, the left hand side (LHS), right hand side (RHS) and bottom of the screen. In the LHS and RHS variables have three different values in 3 columns, which represent respectively the measured (Current), inputs or outputs from model simulations (Simulated), and the results of optimisation (Optimal). The LHS contains the ventilator settings, penalties and function buttons of the system. The RHS contains data describing the lung, arterial blood and venous blood. The bottom of the screen includes the patient specific parameters. These are organized according to organ system and include parameters describing lung gas exchange and mechanics (shunt, fA_2 ,

Vd, compliance); blood (2,3 diphosphoglycerate (DPG), haemoglobin (Hb), carboxyhaemoglobin(COHb), methaemoglobin (MetHb), temperature(Temp)); circulatory status (cardiac output(Q); and metabolic status (oxygen consumption (VO_2), carbon dioxide production (VCO_2)).

The system is used in three steps. First, the physiological models are fitted to the patient data, so as to estimate patient specific values of the physiological models' parameters. Second quality of the model fit to the data can be evaluated. Third the clinician can perform simulations to test various ventilator strategies, and ask INVENT for the optimal ventilator settings. The details of these steps are described in [84]. For the patient illustrated in Figure 16 the DSS suggests optimal ventilator settings reducing FIO_2 from 38.0% to 30.6%, with an almost negligible increase in tidal volume. These settings gives an 'optimal' SaO_2 of 96.7%, and hence reduction in the total penalty from 0.054 to 0.040, primarily due to a lower oxygen toxicity penalty, which outweighed the increased penalty on hypoxia.

To enable integration of INVENT into the intensive care a system has been developed (ICARE) [91], which includes software for communication with standard ICU devices and a database. ICARE also includes functionality for ranking the stored data, depending on its source, and to automatically perform physiological calculations as new data present.

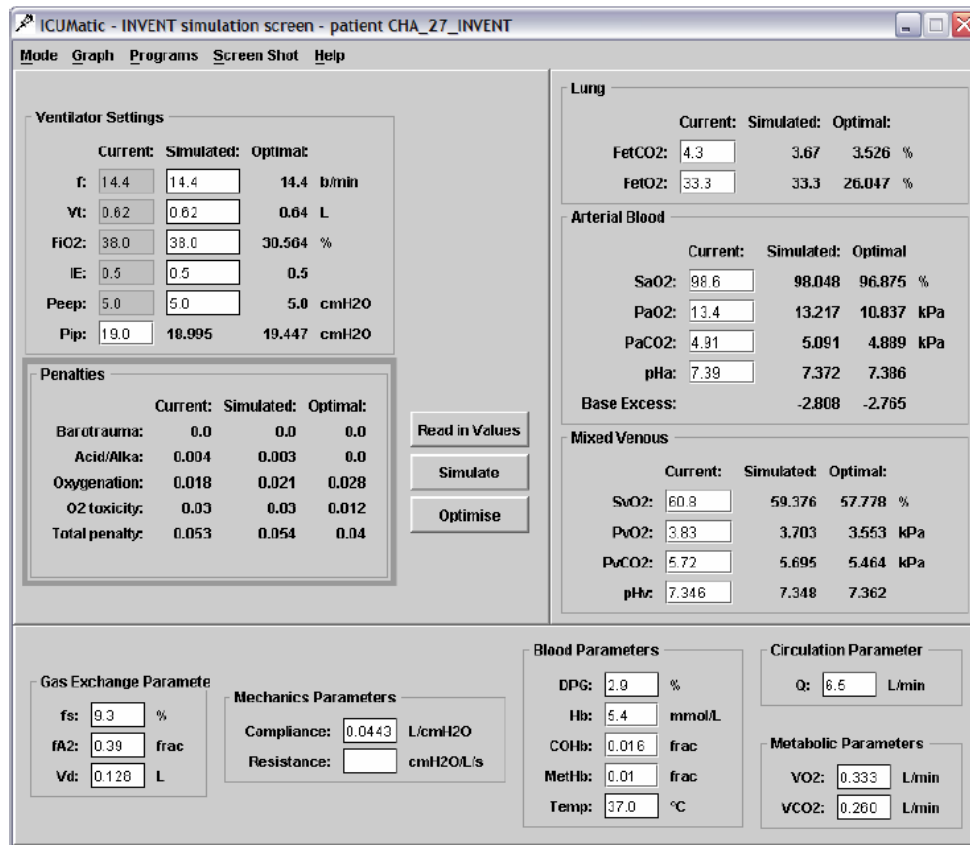

Figure 16 – The user interface for INVENT III. Reproduced from [84] with permission. ("With kind permission from Springer Science+Business Media: J Clin Monit Comput, Using physiological models and decision theory for selecting appropriate ventilator settings, 20, 2006, page 426, Rees S.E, Allerød C, Murley D, Zhao Y, Smith B.W, Kjærgaard S, Thorgaard P, Andreassen S, figure 4)

4.4 Evaluation of the INVENT system.

To evaluate the INVENT system requires validation of the physiological models and preference functions included in INVENT, and evaluation of the advice provided by the INVENT system.

The validation of the physiological models included in INVENT has been described in the previous chapters of this dissertation, apart from the validation of the representation of lung mechanics. The limitations of the simple model of lung mechanics used here are well known, and it remains to be seen whether we have selected a useful clinical approximation to reality.

A systematic study is currently underway, as part of a PhD project, to evaluate the utility functions included in INVENT [94]. In this study a set of 10 patient cases are presented, via INVENT's physiological models, to 10 expert clinicians. The clinicians select the ventilator setting which, via simulation, give the patient state they regard as optimal. From the 10 clinicians and INVENT a set of 110 optimal suggestions are then generated. These are then returned to the clinicians for ranking. In doing so a quantitative picture can be obtained as to current clinical preference and the ability of the INVENT utility functions to capture this. In addition, this process gives an interesting insight into the consensus, or lack of it, in current clinical opinion toward ventilator management.

Evaluation of the advice provided by the INVENT system has been structured in a series of investigations, illustrated in figure 17.

Three different versions of INVENT are currently under development and evaluation: INVENT I optimizes only for FiO_2 . It includes physiological models of ALPE plus the utility functions for oxygenation and oxygen toxicity illustrated in figure 15. INVENT III optimizes for inspiratory oxygen, respiratory frequency and tidal volume. INVENT V, is planned to optimize over the settings of INVENT III plus PEEP and I:E ratio.

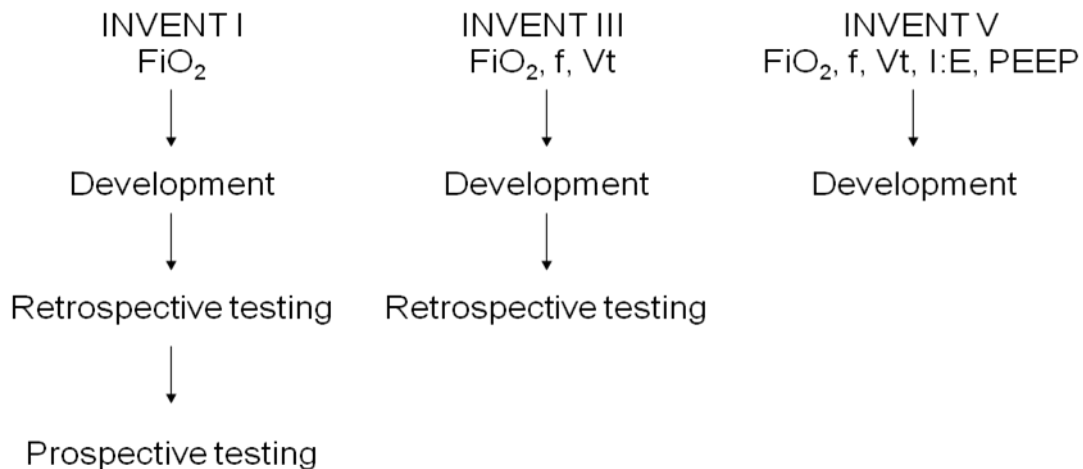

Figure 17 – Development and evaluation of the INVENT system.

For each of the three systems a process of development, retrospective evaluation and prospective evaluation is being undertaken. The current status of each of the systems progress being shown in figure 17. INVENT I has been the subject of a PhD study [93], the system having been developed, retrospectively [94], and prospectively [95] evaluated. Retrospective and prospective evaluation has given similar results, with the results of prospective evaluation being illustrated in figure 18

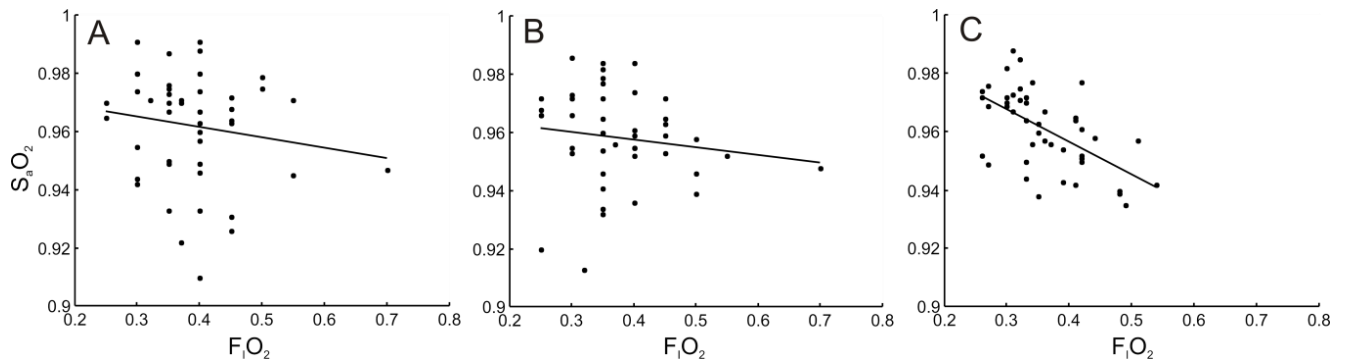

Figure 18 – Prospective evaluation of INVENT I. Reproduced from [95], with kind permission from Elsevier.

Figure 18 illustrates the levels of FiO_2 and resulting SaO_2 at baseline (A), selected by the clinician (B) and selected by INVENT I (C). INVENT achieved narrower ranges of FiO_2 and SaO_2 values than baseline or attending clinicians, suggesting standardized more effective use of FiO_2 . In addition this study showed that INVENT was more responsive over time to changes in the individual patient state than clinical practice.

INVENT III has been retrospectively evaluated as part of a current PhD project. Retrospective evaluation has taken place in a group of patients mechanically ventilated following coronary arterial bypass surgery [96]. In these patients the INVENT models were shown to fit well to the patient data, giving parameter values consistent with this homogenous patient group. The system suggested values of ventilator settings which can be considered clinically reasonable: suggesting lowering of FiO_2 in situations of high SpO_2 and increasing FiO_2 in situations of low SpO_2 , whilst maintaining simulated SpO_2 in the range 94.6 – 97.4 %; and suggesting lowering ventilation in

situations of high pHa and increasing ventilation in situations of low pHa these being achieved whilst maintaining simulated pH in the range 7.368-7.404, simulated values of PIP \leq 22.9cmH₂O, and $f \leq 18$ breaths min⁻¹.

4.5 Summary of chapter.

This chapter has described the type and focus of current decision support systems for aiding in mechanical ventilation, highlighting the need for systems which are based on a deeper description of the individual patient state, possible with the use of physiological models. The structure and function of the INtelligent VENTilator (INVENT) system has been described including its application of physiological models and utility/penalty functions in optimization of ventilator settings. An example of the use of INVENT has been presented, and the current status of development and evaluation summarized.

5 Discussion and Conclusions

This dissertation is presented for the degree of Doctor of Technology. It is not intended to describe novel understanding of physiological or biochemical mechanisms, with much of the knowledge on these aspects included in this dissertation having been known for many decades. Similarly, it is not purely clinical, concentrating on the optimization of current therapy rather than the development of new. The focus of this work is therefore in the use of mathematical models to transfer physiological knowledge into clinical practice. This process is in many respects no more than scientific tidying-up, repackaging and formulating others understanding in a form which can be effectively included into useful clinical systems. However this process is both important and non-trivial. As commented by Burton on the subject of review articles “Cheaply extracting new meaning from costly, hard-won data is surely to be encouraged” [97], and mathematical models provide a mechanism of ensuring that this extraction is performed systematically and in a way which can be clinically applied. This is a non-trivial task as systems reaching commercialization and use, based on physiological models, require expertise in many scientific disciplines, e.g. physiology, biochemistry, biomedical engineering, medical informatics and clinical practice, as well as requiring researchers to be at least familiar with the practices of patent applications and starting up spin-off companies. Such research requires both broad teams of specialists, but also that each specialist is familiar and to some degree competent in many of these fields. The positive result is a challenging and multi-disciplinary environment, the negative is the risk of the researcher becoming a jack of all trades.

Given then that the physiological and many of the clinical aspects of this dissertation are not novel, it is important then to highlight the novelty and contribution of this work. The following section reviews each of the chapters highlighting the contribution of this work, its relation to the literature and the potential for future research.

5.1 Pulmonary gas exchange

The basis of our understanding of pulmonary gas exchange was developed in the 1950s-1970s. During that period Riley and co-workers illustrated that information about some of the

components of gas exchange could be determined with systematic measurement of oxygen and CO₂ in respiratory gasses and blood [98,99,100]. The limitations of the use of O₂ and CO₂ as tracers gasses to help understand gas exchange became increasingly well known and resulted in a leap in our understanding of pulmonary gas exchange with the development of MIGET [7]. Whilst physiological understanding of the pulmonary gas exchange in different lung disease is now well known, the systematic clinical application of this knowledge can be seen as poor, with the PaO₂/FIO₂ measurement, a measurement worse than those proposed by Riley and co-workers, being the reference technique in the ICU.

One of the contributions of this dissertation, and of the INVENT team, has therefore been to look again at the use of O₂ and CO₂ as tracer gasses, aiming at incorporating physiological knowledge into clinical practice by finding a compromise between the complexity of MIGET and the over simplification of the current clinical practice. In addition the aim has been to use technology not available to Riley and co-workers, to extend the application of O₂ and CO₂ measurements, not as a tool for understanding physiology but as tools to aid in clinical practice.

In doing so we believe we have identified the most parsimonious model, describing pulmonary shunt, low V/Q and high V/Q from measurements routinely available in the clinic, along with a readily automatable variation in FIO₂. This ALPE system has been developed, evaluated clinically in a range of patients, evaluated experimentally against MIGET, patented and commercialized.

Whilst the clinical use of O₂ in describing pulmonary gas exchange has been largely limited to the PaO₂/FIO₂ ratio, other technologies for describing pulmonary gas exchange at the bedside are beginning to enter clinical practice. Electrical impedance tomography is showing promising results in non-invasively characterizing tidal changes in ventilation and perfusion for individual regions of the lungs [101,102,103]. Vibration response imaging has also been shown to be able to non-invasively characterize regional ventilation in a range of patients on or off mechanical ventilation [104, 105].

Development of these new techniques raises the question as to whether the use of O₂ and CO₂ to describe pulmonary gas exchange has been superseded. The answer is probably not. Faster mainstream oxygen gas analysers are entering the market [106] meaning that an increasing

number of ventilator manufacturers are likely to combine O_2 and CO_2 measurements for metabolic monitoring, as is currently present in GE ventilators. In addition measurement of functional residual capacity can be made from variation in FIO_2 and measurement of respiratory gasses [107], and this technology has reached product in GE ventilators (FRC INview) and research publications by Dräger Medical [108]. ALPE estimates could be obtained as a by-product of FiO_2 variation to obtain FRC, meaning that there is potential for a combined understanding of lung volume and gas exchange from a simple clinical maneuver.

The aspects related to pulmonary gas exchange included in this dissertation have focused on the use of oxygen as a tracer. The difference between oxygen in end expired and arterial gas is greatest when pulmonary shunt or low V/Q is present, meaning that as a tracer O_2 gives most information about these compartments. In contrast CO_2 is known to give most information about high V/Q regions. Karbing et al. [109], have shown that by using end tidal and arterial CO_2 measurements integrated into ALPE, the fractional perfusion distribution parameter (f_2) of figure 2 (chapter 2) can also be estimated and high V/Q effectively characterized, as well as low V/Q and shunt. This finding raises new interesting clinical possibilities for ALPE. In patients with ALI or ARDS shunt and low V/Q are the primary problems of gas exchange. In contrast for patients presenting in departments of lung medicine with chronic obstructive pulmonary disease (COPD), high V/Q is often the predominant problem. The gas exchange of such patients is usually measured using carbon monoxide breathing techniques to calculate DL_{CO} , the transfer factor. Once again, clinical practice therefore uses a single parameter to describe a ventilation perfusion distribution. This lack of complexity is clinically relevant amongst a heterogeneous population of COPD patients. MIGET has taught us that patients with chronic bronchitis present with both high and low V/Q abnormalities, whereas patients with emphysema typically have pure high V/Q [9]. The complexity of ALPE may therefore help in stratifying the heterogeneity of COPD, and ethical approval has been obtained to investigate this.

In the ICU the incorporation of CO_2 into ALPE and the identification of high V/Q may help in the monitoring of the effects of elevated ventilatory pressures, e.g. increasing PEEP or performing recruitment. An increase in pressure should shift the whole V/Q distribution to the right, with some of the shunt becoming low V/Q , low V/Q normalizing and normal V/Q becoming high V/Q . It is interesting therefore to see if ALPE can accurately describe the effects

of pressure changes, and as such explain the patient specific response to changes in PEEP or recruitment. Ethical approval has been obtained to investigate this.

5.2 Acid-base chemistry

The biochemical and mathematical basis of the acid-base chemistry of blood has been well described for several decades. Both experimentally and in terms of mathematical formulation, Siggaard-Andersen and colleagues have accounted for a very large proportion of our current understanding.

In his formulation Siggaard-Andersen used equations which are algebraically solvable, e.g. the van Slyke equation, and coefficients such as the buffer capacity to describe piecewise linearity. This formulation has the advantage of mathematical simplicity, but the disadvantage that the transparency of the link between the reaction equations and the mathematical equations is lost. This can lead to misunderstanding of the meaning of the mathematical equations. In part, Stewart's formulation has remained close to the initial reaction equations. Whilst his equations do not therefore have the coverage of Siggaard-Andersen's in describing blood, it can be argued that they are more transparent and therefore accessible to the non-mathematically inclined. This type of formulation also has the benefit that appropriate, additive, state variables can be selected, a requirement which has been important for the development of INVENT

From an acid-base perspective the major contribution of this work has been to illustrate the similarity between the approaches of Siggaard-Andersen and Stewart [52] and to develop a model with the coverage of Siggaard-Andersen and the structure of Stewart [62, 63]. This model has been validated against literature data illustrating that it could simulate the addition and removal of CO_2 strong acid/base, and haemoglobin; and the effects of oxygenation or deoxygenation, including reproduction of values of the Haldane and BE coefficients. The model has also been validated in new data and shown to simulate accurately and precisely the mixing of blood samples at different PCO_2 and PO_2 levels [63], necessary for the INVENT system. New studies are underway to perform similar mixing in the blood from patients with disturbed electrolyte and acid-base status.

Like all models it includes approximations and assumptions which may not be correct. A detailed description of these assumptions is included in [62], and not discussed further here. Probably the major limitation of the model, in its current form, is the only remaining empirical equation (equation 24r, figure 5, chapter 3), which describes the relation between the pH in the plasma and red blood cells. This equation is used to eliminate the need to represent the transport of electrolytes and water over the red blood cell membrane when describing acid-base chemistry. For the purposes described in this dissertation this is not a limitation, however the intra- and extra-cellular fluid acid-base and electrolyte interaction is an interesting field where extension of the existing model could be helpful.

The acid-base model was also included in a whole body model of O₂ and CO₂ transport [62] and shown to reproduce normal conditions in all compartments, the typical dynamic response to changes in ventilation, and the measured distribution of bicarbonate between blood and interstitial fluid Schwartz [47]

The acid-base model has also been used in the ARTY system [72]. ARTY has been shown to calculate arterial values both accurately and precisely in patients residing in the ICU and departments of lung medicine. These data indicate a role for ARTY converted values of peripheral venous blood in clinical practice. In considering the role of ARTY it is important however, to ask the question as to whether ARTY is necessary or whether peripheral venous or indeed capillary blood could not be used to assess the patient's acid-base status without the use of ARTY [110,111]. For pH and PCO₂ it has been shown that the use of ARTY halves the standard deviation of the precision in which arterial values can be estimated [70, 71], and for calculation of PO₂ no reasonable values can be obtained without ARTY [70]. These improvements are obtained cheaply, with the only overhead being the measurement of pulse oximetry SpO₂. For pH and PCO₂ it is possible that venous blood would nevertheless, be a reasonable method of classifying patients. Whilst some authors are addressing this issue [111, 112] and clinical opinion is changing, there has previously been little clinical culture for interpretation of peripheral venous values of acid-base. Indeed, as recently as 2006, Radiometer Medical's stated that "Venous samples are not recommended for whole-blood analysis, because venous PO₂ and SO₂ do not provide good diagnostic information on oxygen transport and oxygen uptake" [114]. Translating peripheral venous into arterial values can therefore be seen

as both a way to maximize the precision of its use, and as a valuable tool to promote the uptake of the use peripheral venous blood, enabling clinicians to view the results of venous measurement as more familiar arterial values.

It has been argued that ARTY conversions of peripheral venous blood are no better than direct measurement of capillary samples [110]. However as commented in [111], these capillary samples are taken from sites either warmed or after application of vasodilatation cream, i.e. where the site has been *mechanically* arterialized. ARTY's *mathematical* arterialisation does not require warming or the application of vasodilators making it a much simpler tool for clinical practice.

The major assumption included in the ARTY method is that peripheral blood is sampled from well-perfused, warm tissue such that metabolism in that tissue is primarily aerobic. This means that the RQ over the sampling site would be between 0.7 and 1.0 and that the change in BE between arterial and venous blood would approximate zero. The quality of perfusion of a limb can be simply assessed in the clinic, and little difference in arterial-venous BE was seen in studied patients, even when no control was made to ensure normal perfusion [73].

ARTY has currently been shown to calculate arterial values in patients from intensive care and departments of lung medicine at a single time point. Typically patients with COPD are admitted departments of lung medicine for a period of 4-5 days during exacerbation. It is important therefore that the method be evaluated over the duration of this period to see if peripheral venous blood can replace arterial in this context. Ethical approval has been obtained to investigate this.

In addition, patients acutely admitted to the emergency medical department have arterial punctures made only if suffering from dyspnea. For these patients painful arterial punctures might be eliminated by the technique. If admitted to the emergency medical department without dyspnea no quantification of acid-base and oxygenation status is performed, this being despite the fact that peripheral venous blood samples are typically taken in all patients. Analysis of acid-base and oxygenation status using the technique may provide useful screening in these patients. Ethical approval has been obtained to investigate these potential applications.

In the intensive care unit it is unlikely that ARTY calculated arterial values will replace direct arterial sampling in the majority of patients. Patients typically have indwelling arterial catheters for continuous measurement of blood pressure and for taking arterial blood for blood gas and acid-base. However, in patients without critical circulatory problems, or perhaps those presenting in high dependency environments, blood pressure could be monitored non-invasively with a cuff placed on the forearm or finger [115]. In this case, venous blood could be sampled from a central venous catheter, typically used for administration of fluid or medication. Use of ARTY to calculate arterial values from central venous blood may then eliminate the need for an arterial catheter in these patients.

5.3 The INVENT system

The contributions of this work, related to mechanical ventilation, have been in the design development and evaluation of a system for selecting appropriate ventilator settings. In doing so, the mathematical models of the previous chapters have been integrated with models of utility/penalty, hence separating physiological knowledge from clinical preference. The models can be tuned to the individual patient via parameter estimation, providing patient specific advice. The INVENT system has been integrated into a research based data collection system enabling prospective clinical evaluation. The INVENT team has shown prospectively that the system provides advice on FIO_2 which is as good as clinical practice, and retrospectively that the physiological models fit well to clinical data and that the system provides reasonable suggestions of tidal volume, respiratory frequency and FIO_2 .

Only one previous system has incorporated this level of physiology into a ventilator decision support system [81] and this system is no longer under development. This does not however, mean that the field has not moved forward in the past decade. Indeed, interest for intelligent ventilator type systems is growing, with many manufacturers having some variant. These range from new modes with increased intelligence or rule based systems, e.g. BIPAP, ASV or SmartCare, or even black box models of ventilator support based upon neurological drive measured from diaphragm electrical activity (NAVA). Interest in such systems is such that Hamilton Medical, one of the major manufacturers, markets its ASV mode under the slogan “Intelligent Ventilation”.

These advances raise the question as to whether INVENT has been superseded? Once again the answer is probably not. Systems such as SmartCare and ASV are focused on the less challenging patients balancing the speed of weaning against the CO₂ level and potential exhaustion of the patient. Unlike INVENT they do not consider the appropriate balance of high or low volume strategy or FIO₂ level. In addition the lack of models in these systems means that they do not learn about the patient during the process of management. Changes in pressure support and the resulting CO₂ and ventilation profile ought to be sufficient to parameterize the patient's response and learn about their net respiratory drive. In this respect the recent developments in neurological adjusted ventilation (Neurally adjusted ventilator assist (NAVA)) are very exciting [116]. In the NAVA system the electrical activity of the diaphragm is measured on a breath by breath basis, and the pressure support delivered to the patient is then proportional to this activity. In doing so the system aims to ensure synchronization between the ventilator and the patient, and that most support is provided to the patient when demand is greatest. A clinically adjusted gain factor is set as the proportionality constant between the electrical signal and the average support delivered. This gain factor can be seen to represent two different aspects. It can be used to represent a parameterization of the net respiratory drive, including the muscular, neurological, and chemical control components. As such it may well reflect changes in the patient's state over time and be a useful monitoring parameter, with a lower gain meaning a lower average support necessary for the same electrical activity. However, it also represents the clinician's preference toward high or low volume ventilation strategy with different values of the gain effectively selecting different balance points of the compromise between the risks of baro/volu-trauma and acidosis/alkalosis. The major assumption underlying the use of NAVA is that variability in support on a breath by breath basis adjusted according to diaphragm activity and clinical selection of the gain factor improves patient care. Clinical studies applying NAVA in critically ill patients are only now beginning to be published [117], and whether this presents a real improvement in patient care remains unknown.

The further success of INVENT depends upon a number of factors. INVENT III requires prospective evaluation. For development of INVENT V, models are required which adequately describe the effects of PEEP and inspiratory:expiratory ratio, and models are required of the various components of respiratory drive if INVENT is to be used in support modes. Work is currently underway in all these aspects, with some promising results [118, 119]. Probably the

most important factor is collaboration with an industrial partner. Eventual success of the system requires integration with standard ventilators enabling closed loop control of ventilator settings.

5.4 Conclusions

This dissertation has addressed the broad hypothesis as to whether building mathematical models is useful. In doing so it has illustrated a further example of the role of modeling in describing and understanding complex systems. The dissertation has shown that when dealing with complexity the goal of the model must be in focus if a correct balance is to be maintained between system complexity and model parameterization.

The original goal of the INVENT team, i.e. to build, evaluate and integrate a DSS for control of mechanical ventilation has not as yet been completed. However the broader hypothesis that building models generates new and interesting questions has been successfully demonstrated. The ALPE model and system has been applied in ICU, post operative care and cardiology and is currently being applied in new clinical domains. ARTY has been shown to have potential benefit in eliminating the need for painful arterial punctures, and may also be useful as a screening tool. These systems illustrate the benefits of investing in models as a mechanism for transferring scientific knowledge to clinical practice.

6. References (* Co-authored)

- 1) Lellouche F, Mancebo J, Jolliet P, Roeseler J, Schortgen F, Dojat M, Cabello B, Bouadma L, Rodriguez P, Maggiore S, Reynaert M, Mersmann S, Brochard L. A multicenter randomized trial of computer-driven protocolized weaning from mechanical ventilation. *Am J Respir Crit Care Med* 2006, 15;174(8):894-900.
- 2) McKinley BA, Moore FA, Sailors RM, Cocanour CS, Marquez A, Wright RK, Tonnesen AS, Wallace CJ, Morris AH, East TD. Computerized decision support for mechanical ventilation of trauma induced ARDS: results of a randomized clinical trial. *J Trauma* 2001, 50(3):415-24.
- 3) East TD, Heermann LK, Bradshaw RL, Lugo A, Sailors M, Ershler L, Wallace CJ, Morris AH, McKinley B, Marquez A, Tonnesen A, Parmley L, Shoemaker W, Meade P, Thaut P, Hill T, Young M, Baughmann J, Olterman M, Gooder V, Quinn B, Summer W, Valentine V, Carlson J, Bonnell B, deBoisblanc B, McClarity Z, Cachere J, Kovitz K, Callagher E, Pinsky M, Angus D, Cohen M, Hudson L, Steinberg L. Efficacy of computerized decision support for mechanical ventilation: results of a prospective multi-center trial. *Proc AMIA Symp* 1999, 251-255.
- 4) Sulemanji D, Marchese A, Garbarini P, Wysocki M, Kacmarek RM. Adaptive Support Ventilation: An Appropriate Mechanical Ventilation Strategy for Acute Respiratory Distress Syndrome? *Anesthesiology* 2009, 111(4):863-70.
- 5) Keeney RL, Raiffa H. Decisions with multiple objectives. Cambridge University Press. 1993.
- 6) Cobelli C, Carson ER. Introduction to Modeling in Physiology and Medicine. Academic Press. 2008.
- 7) Wagner PD, Saltzman HA, West JB. Measurement of continuous distributions of ventilation-perfusion ratios: theory. *J Appl Physiol* 1974, 36:588-99.

- 8) *Rees SE, Kjærgaard S, Andreassen S. Mathematical Modelling of Pulmonary Gas Exchange. In: *Modelling Methodology for Physiology and Medicine*. eds. E.R Carson and C.Cobelli, Academic Press, 2001, pp 253-277.
- 9) Agustí AG, Barberà JA. Contribution of multiple inert gas elimination technique to pulmonary medicine. 2. Chronic pulmonary diseases: chronic obstructive pulmonary disease and idiopathic pulmonary fibrosis. *Thorax* 1994, 49(9):924-32.
- 10) Rodriguez-Roisin R, Roca J. Contributions of multiple inert gas elimination technique to pulmonary medicine. 3. Bronchial asthma. *Thorax* 1994, 49(10):1027-33.
- 11) Manier G, Castaing Y. Contribution of multiple inert gas elimination technique to pulmonary medicine. 4. Gas exchange abnormalities in pulmonary vascular and cardiac disease. *Thorax* 1994, 49(11):1169-74.
- 12) Mélot C. Contribution of multiple inert gas elimination technique to pulmonary medicine. 5. Ventilation-perfusion relationships in acute respiratory failure. *Thorax* 1994, 49(12):1251-8.
- 13) Hedenstierna G. Contribution of multiple inert gas elimination technique to pulmonary medicine. 6. Ventilation-perfusion relationships during anaesthesia. *Thorax* 1995, 50(1):85-91.
- 14) Agusti, A.G.N., J. Roca, J. Gea, P.D. Wagner, A. Xaubet and R. Rodriguez-Roisin. Mechanisms of gas exchange impairment in idiopathic pulmonary fibrosis. *Am. Rev. Respir. Dis.* 1991, 143:219-225.
- 15) Torre-Bueno, J.R., Wagner, P.D., Saltzman H.A., Gale, G.E., Moon, R.E. Diffusion limitation in normal humans during exercise at sea level and simulated altitude. *J Appl. Physiol* 1985, 58:989-995.
- 16) Wagner, P.D., Gale, G.E., Moon, R.E., Torre-Bueno, J.R., Stolp, B.W., Saltzman, H.A. Pulmonary gas exchange in humans exercising at sea level and simulated altitude. *J Appl Physiol* 1986, 61:260-270.

- 17) Piiper J. Search for diffusion limitation in pulmonary gas exchange. In Wagner WW and Weir EK: The pulmonary circulation and gas exchange, 1994. Futura publishing co inc, Armonk NY.
- 18) * Karbing D.S, Kjaergaard S, Smith B.W, Espersen K, Allerod C, Andreassen S, Rees S.E. Variation in the PaO₂/FiO₂ ratio with FiO₂: Mathematical and experimental description, and clinical relevance. *Critical Care* 2007, 11(6):R118.
- 19) West J.B, Wagner PD. Pulmonary gas exchange. In, West JB. Bioengineering aspects of the lung, 1977. Marcel Dekker Inc, New York.
- 20) Wagner, P.D, Hedenstierna, G, Bylin, G. Ventilation-perfusion inequality in chronic asthma. *Am. Rev. Respir. Dis.* 1987, 136:605-612.
- 21) Roca, J., Wagner P.D. Contribution of multiple inert gas elimination technique to pulmonary medicine.1. Principles and information content of the multiple inert gas elimination technique. *Thorax* 1993, 49:815-824.
- 22) *Kjærgaard S, Rees S, Malczynski J, Nielsen JA, Thorgaard P, Toft E, Andreassen S. Non-invasive estimation of shunt and ventilation-perfusion mismatch. *Intensive Care Med.* 2003, 29(5):727-34.
- 23) Jones JG, Jones SE. Discriminating between the effect of shunt and reduced VA/Q on arterial oxygen saturation is particularly useful in clinical practice. *J Clin Monit Comput.* 2000, 16: 337-350.
- 24) *Rees S.E, Kjærgaard S, Andreassen S, Hedenstierna G. Reproduction of MIGET retention and excretion data using a simple model of gas exchange in lung damage caused by oleic acid infusion. *J Appl Physiol.* 2006,101(3):826-32.
- 25) *Rees S.E, Kjærgaard S, Andreassen S, Hedenstierna G. Reproduction of oxygenation data in oleic acid induced lung damage – a comparison of the MIGET and a simple model of pulmonary gas exchange. *Intensive Care Medicine.* 2010, 36(12):2117-24.
- 26) *Rees SE, Kjærgaard S, Thorgaard P, Malczynski J, Toft E, Andreassen S. The Automatic Lung Parameter Estimator (ALPE) system: Non-invasive estimation of

pulmonary gas exchange parameters in 10-15 minutes. *J Clin Monit Comput.* 2002, 17: 43-52.

- 27) *Murley D, Rees S, Rasmussen B, Andreassen S. Decision support of inspired oxygen fraction based on Bayesian learning of pulmonary gas exchange parameters. *Artif Intell Med.* 2005 May; 34(1):53-63.
- 28) *Rees S.E, Toft E.S, Thorgaard P, Kjærgaard S.C, Andreassen S. Automatic lung parameter estimator. US Patent 7008380, European Patent EP1152690.
- 29) Kjærgaard S. Mathematical models of pulmonary gas exchange – validation and application to postoperative hypoxaemia. PhD thesis, 2003, Aalborg University.
- 30) Rasmussen B.S. The influences of body temperature and cardiopulmonary bypass on oxygenation and on inflammatory response after coronary artery bypass. PhD thesis, 2006, Aalborg University.
- 31) *Andreassen S, Rees S.E, Kjærgaard S, Thorgaard P, Winter S.M, and Morgan C.J, Alstrup P, and Toft E. Hypoxemia after coronary bypass surgery modeled by resistance to oxygen diffusion. *Crit Care Med* 1999, 27(1): 2445-53.
- 32) *Kjærgaard S, Rees S.E, Grønlund, J.S, Malte E.M, Lambert P, Thorgaard P, Toft E, Andreassen S. Hypoxaemia after cardiac surgery: Clinical application of a model of pulmonary gas exchange. *Eur J Anaesthesiol* 2004, 21(4):296-301.
- 33) *Kjærgaard S, Rees S.E, Nielsen J.A, Freundlich M, Thorgaard P, Andreassen S. Modelling of hypoxaemia after gynaecological laparotomy. *Acta Anaesthesiol Scand.* 2001, 45(3):349-356.
- 34) *Rasmussen B.S, Laugesen H, Sollid J, Grønlund J, Rees SE, Toft E, Gjedsted J, Dethlefsen C, Tønnesen E. Oxygenation and release of inflammatory mediators after off-pump compared to after on-pump coronary artery bypass surgery. *Acta Anaesthesiol Scand.* 2007, 51(9):1202-10.
- 35) *Rasmussen B.S, Sollid J, Rees S.E, Kjærgaard S, Murley D, Toft E. Oxygenation within the first 120 h following coronary artery bypass grafting. Influence of systemic

- hypothermia (32 degrees C) or normothermia (36 degrees C) during the cardiopulmonary bypass: a randomized clinical trial. *Acta Anaesthesiol Scand.* 2006, 50(1):64-71.
- 36) Rosenberg J, Ullstad T, Rasmussen J, Hjørne F.P, Poulsen N.J, Goldman M.D. Time course of postoperative hypoxaemia. *Eur J Surg.* 1994, 160(3):137-43.
- 37) *Rees S.E, Malczynski J, Korup E, Kjærgaard S, Thorgaard P, Andersen S, Toft E. Assessing pulmonary congestion in left sided heart failure using pulmonary gas exchange parameters. 25th Conference of the IEEE Engineering in Medicine and Biology Society (EMBS), 2003, 435-438. ISBN 0-7803-7790-7.
- 38) *Moesgaard J, Kristensen J.H, Malczynski J, Holst-Hansen C, Rees S.E, Murley D, Andreassen S, Frokjaer J.B, Toft E. Can new pulmonary gas exchange parameters contribute to evaluation of pulmonary congestion in left-sided heart failure? *Can J Cardiol.* 2009, 25(3):149-55.
- 39) Siggaard-Andersen O. The Acid-Base Status of the Blood, 1974. Munksgaard, Copenhagen.
- 40) Siggaard-Andersen O. The van Slyke equation. *Scand J Clin Lab Invest.* 1977 37:15-20.
- 41) Siggaard-Andersen O, Wimberley P.D, Gothgen I, Siggaard-Andersen M. A mathematical model of the hemoglobin-oxygen dissociation curve of human blood and of the oxygen partial pressure as a function of temperature. *Clin Chem.* 1984, 30:1646-1651.
- 42) Siggaard-Andersen O, Engel K. A new acid-base nomogram- an improved method for the calculation of the relevant blood acid-base data. *Scand J Clin Lab Invest.* 1960, 12:177-186.
- 43) Siggaard-Andersen O. The pH-log PCO₂ blood acid-base nomogram revised. *Scand J Clin Lab Invest.* 1962, 14:598-604.
- 44) Siggaard-Andersen O. An acid-base chart for arterial blood with normal and pathophysiological reference areas. *Scand J Clin Lab Invest.* 1971, 27(3):239-45.

- 45) Severinghaus J.W. Siggaard-Andersen and the "Great Trans-Atlantic Acid-Base Debate". *Scand J Clin Lab Invest.* 1993, 214:99-104.
- 46) Schwartz W.B, Relman AS. A critique of the parameters used in the evaluation of acid–base disorders “whole-blood buffer base” and “standard bicarbonate” compared with blood pH and plasma bicarbonate concentration. *N Engl J Med.* 1963, 268:1382–1388
- 47) Brackett NC, Cohen JJ, Schwartz WB. Carbon dioxide titration curve of normal man: effects of increasing degrees of acute hypercapnia on acid–base equilibrium. *N Engl J Med.* 1965, 272(1):6–12.
- 48) Stewart PA. Modern quantitative acid–base chemistry. *Can J Physiol Pharmacol* 1983, 61:1444–1461.
- 49) Kellum J.A, Elbers P.W.G. Stewart's Textbook of Acid-Base, 2009. AcidBase.org, The Netherlands.
- 50) Singer R.B, Hastings A.B. An improved clinical method for the estimation of disturbances of the acid–base balance of human blood. *Medicine* 1948, 27:223–242
- 51) Figge J, Jabor A, Kazda A, Fencel V. Anion gap and hypoalbuminemia. *Crit Care Med* 1998, 26:1807–1810.
- 52) *Matousek S, Handy J, Rees S.E. Modeling the acid-base chemistry of plasma: Consolidation of the traditional and modern approaches from a mathematical and clinical perspective. *Journal of Clinical Monitoring and Computing.* 2011; 25(1):57-70..
- 53) Kellum J.A: Clinical review: Reunification of acid-base physiology. *Critical Care* 2005, 9:500-507
- 54) Wooten E.W: Analytic calculation of physiological acid-base parameters in plasma. *J Appl Physiol.* 1999, 86(1):326-34
- 55) Honore P.M, Joannes-Boyau O, Boer W. Strong ion gap and outcome after cardiac arrest: another nail in the coffin of traditional acid–base quantification. *Intensive Care Med* 2009, 35:189–191.

- 56) Constable P.D. Hyperchloremic acidosis: the classic example of strong ion acidosis. *Anesth Analg*. 2003, 96:919–922.
- 57) Duffin J. The role of acid–base balance in the chemoreflex control of breathing. *J Appl Physiol*. 2005, 99:2255–2265.
- 58) Lindinger M.I, Kowalchuk J.M, Heigenhauser G.J.F. Applying physiochemical principles to skeletal muscle acid–base status. *Am J Physiol Regul Integr Comp Physiol*. 2005, 289:R891–R894.
- 59) Wooten E.W. Calculation of physiological acid–base parameters in multicompartiment systems with application to human blood. *J Appl Physiol*. 2003, 95:2333–2344.
- 60) Siggaard–Andersen O. Oxygen-linked hydrogen ion binding of human haemoglobin. Effects of carbon dioxide and 2,3,-Diphosphoglycerate: I. Studies on erythrolysate. *Scand J Clin Lab Invest*. 1971, 27:351–360.
- 61) Siggaard–Andersen O, Salling N. Oxygen-linked hydrogen ion binding of human haemoglobin. Effects of Carbon dioxide and 2,3,-Diphosphoglycerate: II studies on whole blood. *Scand J Clin Lab Invest*. 1971, 27:361–366.
- 62) *Rees S.E, Andreassen S. Mathematical models of oxygen and carbon dioxide storage and transport: The acid-base chemistry of blood. *Crit Rev Biomed Eng*. 2005, 33(3):209-64.
- 63) *Rees S.E, Klæstrup E, Handy J, Andreassen S, Kristensen S.R. Mathematical modelling of the acid-base chemistry and oxygenation of blood – A mass balance, mass action approach including plasma and red blood cells. *Eur J Appl Physiol*. 2010, 108:483-494.
- 64) Siggaard–Andersen M, Siggaard–Andersen O. Oxygen status algorithm, version 3, with some applications. *Acta Anaesthesiol Scand*. 1995. 39(Suppl. 107):13–20.
- 65) Funder J, Weith J.O. Chloride and hydrogen ion distribution between human red cells and plasma. *Acta Physiol Scand*. 1966, 68:234–235.

- 66) *Andreassen S, Rees S.E. Mathematical models of oxygen and carbon dioxide storage and transport: Interstitial fluid and tissue stores and whole body transport. *Crit Rev Biomed Eng.* 2005. 33(3): 265-98.
- 67) Ivanov S.D, Nunn J.F. Influence of duration of hyperventilation on rise time of PCO₂ after step reduction of ventilation. *Respir Physiol.* 1968, 5:243–249.
- 68) *Rees SE, Andreassen S. Method for converting venous blood values to arterial blood values, system for utilising said method and devices for such system. US patent US2006105319.
- 69) Toftegaard M. A mathematical model based method for converting venous values of acid-base and oxygenation status to arterial values – description and evaluation. PhD thesis, Aalborg University, in submission.
- 70) *Toftegaard M, Rees S.E, Andreassen S. Correlation between acid-base parameters measured in arterial blood and venous blood sampled peripherally, from vena cavae superior, and from the pulmonary artery. *Eur J Emerg Med.* 2008, 15(2):86-91.
- 71) *Toftegaard M, Rees S.E, Andreassen S. Evaluation of a method for converting venous values of acid-base and oxygenation status to arterial values. *Emerg Med J.* 2009, 26(4):268-72.
- 72) * Rees S.E, Toftegaard M, Andreassen S. A method for calculation of arterial acid-base and blood gas status from measurements in the peripheral venous blood. *Comput Methods Programs Biomed.* 2006, 81(1):18-25.
- 73) *Rees S.E, Hansen A, Toftegaard M, Pedersen J, Kristiansen SR, Harving H. Converting venous acid-base and oxygen status to arterial in patients with lung disease. *Eur Respir J.* 2009, 33(5):1141-7.
- 74) Tehrani F.T, Roum J.H. Intelligent decision support systems for mechanical ventilation. *Artif Intell Med.* 2008, 44(3):171-82.
- 75) Lellouche F, Brochard. Advanced closed loops during mechanical ventilation (PAV, NAVA, ASV and SmartCare). *Best Pract Res Clin Anaesthesiol.* 2009, 23:81-93.

- 76) Mersmann S. [SmartCare: automatizing clinical guidelines]. *Biomed Tech (Berl)*. 2009, 54(5):283-8. German.
- 77) Brunner J.X, Iotti G.A. Adaptive support ventilation (ASV). *Minerva Anesthesiol* 2002; 68: 365-8.
- 78) Iotti G, Belliato M, Polito A, Pasero D, Beduneau G, Brochard L, Mancebo J, Ranieri M.V. Safety and effectiveness of adaptive support ventilation (ASV) in acute respiratory failure. *Intensive Care Med*. 2005, 31:S168.
- 79) Amato M.B, Barbas C.S, Medeiros D.M, Magaldi R.B, Schettino G.P, Lorenzi-Hilho G, Kairalla R.A, Deheinzelin D, Munoz C, Oliveira R, Takagaki T.Y, Carvalho C.R. Effect of a protective-ventilation strategy on mortality in the acute respiratory distress syndrome. *N Engl J Med*. 1998, 338:347-54.
- 80) Rudowski R, Bokliden A, Carstensen A, Gill H, Ludwigs U, Matell G. Multivariable optimization of mechanical ventilation. A linear programming approach. *Int J Clin Monit Comput*. 1991, 8:107-15.
- 81) Rutledge G.W, Thomsen G.E, Farr B.R, Tovar M.A, Polaschek J.X, Beinlich I.A, Sheiner L.B, Fagan L.M. The design and implementation of a ventilator-management advisor. *Artif Intell Med*. 1993, 5:67-82.
- 82) Kwok H.F, Linkens D.A, Mahfouf M, Mills G.H. SIVA: A hybrid knowledge-and-model-based advisory system for intensive care ventilators. *IEEE Trans Inf Technol Biomed*. 2004, 8:161-72.
- 83) Rudowski R, Kaye W, Garner C.V, Greenburg A.G. Clinical investigation of a computerized decision support of mechanical ventilation with coronary artery bypass graft patients. *Biocyb and Biomed Eng*. 1995; 15:81-92.
- 84) *Rees S.E, Allerød C, Murley D, Zhao Y, Smith B.W, Kjærgaard S, Thorgaard P, Andreassen S. Using physiological models and decision theory for selecting appropriate ventilator settings. *J Clin Monit Comput*. 2006; 20:421-9.

- 85) Káráson S, Søndergaard S, Lundin S, Wiklund J, Stenqvist O. Evaluation of pressure/volume loops based on intratracheal pressure measurements during dynamic conditions. *Acta Anaesthesiol Scand.* 2000, 44:517-577.
- 86) Káráson S. Spirodynamics, new methods for continuous monitoring of respiratory mechanics in ventilator-treated patients. PhD thesis, Göteborg University.
- 87) Mankikian B, Lemaire F, Benito S, Brun-Buisson C, Harf A, Maillot J P and Becker J. A new device for measurement of pulmonary pressure-volume curves in patients on mechanical ventilation. *Crit. Care Med.* 1983, 11:897–901
- 88) Lu Q, Vieira S.R, Richecoeur J, Puybasset L, Kalfon P, Coriat P and Rouby J.J. A simple automated method for measuring pressure–volume curves during mechanical ventilation *Am. J. Respir. Crit. Care Med.* 1999, 159 275–82
- 89) Servillo G, Svantesson C, Beydon L, Roupie E, Brochard L, Lemaire F and Jonson B. Pressure-volume curves in acute respiratory failure: automated low flow inflation versus occlusion. *Am. J. Respir. Crit. Care Med.* 1997, 155:1629–36
- 90) *Zhao Y, Rees S.E, Kjærgaard S, Smith B.W, Larsson A, Andreassen S. An automated method for measuring static pressure–volume curves of the respiratory system and its application in healthy lungs and after lung damage by oleic acid infusion. *Physiol. Meas.* 2007, 28:235–247.
- 91) *Smith B.W, Rees S.E, Christensen T.F, Karbing D.S, Andreassen S. Getting the most from clinical data through physiological modeling and medical decision support. In: European society for computing and technology in anaesthesia and intensive care (ESCTAIC) – Aalborg (Denmark), September 7-10, 2005. *J Clin Monit Comput* 2006; 20:117-44.
- 92) *Allerød C, Karbing D.S, Thorgaard P, Andreassen S, Kjærgaard S, Rees S.E. Variability of preference towards mechanical ventilator settings: a quantitative analysis. In submission.

- 93) Karbing D.S. Physiological models of gas exchange in decision support of mechanical ventilation: Prospective evaluation in an intensive care unit. 2009, PhD thesis, Aalborg University.
- 94) *Karbing D.S, Kjærgaard S, Smith B.W, Allerød C, Espersen K, Andreassen S, Rees S.E. Decision support of inspired oxygen fraction using a model of oxygen transport. IFAC PapersOnLine, Proceedings of the 2008 Congress of the International Federation of Automatic Control, Seoul, Korea, July 6 – 11, Vol. 17(1) (doi: 10.3182/20080706-5-KR-1001.2130).
- 95) *Karbing D.S, Allerød C, Thorgaard P, Carius A, Frilev L, Andreassen S, Kjærgaard S, Rees SE. Prospective evaluation of a decision support system for setting inspired oxygen fraction in intensive care patients. *J Crit Care*. In press, DOI: 10.1016/j.jcrc.2009.12.013.
- 96) *Allerød C, Rees S.E, Rasmussen B.S, Karbing D.S, Kjærgaard S, Thorgaard P, Andreassen S. A decision support system for suggesting ventilator settings: Retrospective evaluation in cardiac surgery patients ventilated in the ICU. *Comput Methods Programs Biomed*. 2008, 92:205–212.
- 97) Burton R.F. “Original work” and creative reviews. *Medical Hypotheses* 2009,73:1072-1080.
- 98) Riley R.L, Cournand A. Ideal alveolar air and the analysis of ventilation-perfusion relationships in the lungs. *J Appl Physiol*. 1949, 1(12):825-47.
- 99) Riley R.L, Cournand A. Analysis of factors affecting partial pressures of oxygen and carbon dioxide in gas and blood of lungs; theory. *J Appl Physiol*. 1951, 4(2):77-101.
- 100) Riley R.L, Cournand A, Donald KW. Analysis of factors affecting partial pressures of oxygen and carbon dioxide in gas and blood of lungs; methods. *J Appl Physiol*. 1951, 4(2):102-20.
- 101) Frerichs I, Dargaville P.A, Dudykevych T, Rimensberger P.C. Electrical impedance tomography: a method for monitoring regional lung aeration and tidal volume distribution? *Intensive Care Med*. 2003, 29(12):2312-6.

- 102) Meier T, Luepschen H, Karsten J, Leibecke T, Grossherr M, Gehring H, Leonhardt S. Assessment of regional lung recruitment and derecruitment during a PEEP trial based on electrical impedance tomography. *Intensive Care Med.* 2008, 34(3):543-50.
- 103) Fagerberg A, Stenqvist O, Aneman A. Electrical impedance tomography applied to assess matching of pulmonary ventilation and perfusion in a porcine experimental model. *Crit Care.* 2009, 13(2):R34.
- 104) Dellinger R.P, Parrillo J.E, Kushnir A, Rossi M, Kushnir I. Dynamic visualization of lung sounds with a vibration response device: a case series. *Respiration.* 2008, 75(1):60-72
- 105) Dellinger R.P, Jean S, Cinel I, Tay C, Rajanala S, Glickman Y.A, Parrillo J.E. Regional distribution of acoustic-based lung vibration as a function of mechanical ventilation mode. *Crit Care.* 2007, 11(1):R26.
- 106) Berggren M, Hosseini N, Nilsson K, Stenqvist O. Improved response time with a new miniaturised main-stream multigas monitor. *J Clin Monit Comput.* 2009, Oct 10. [Epub ahead of print].
- 107) Olegard C, Sondergaard S, Houltz E, Lundin S, Stenqvist O. "Estimation of functional residual capacity at the bedside using standard monitoring equipment: a modified nitrogen washout/ washin technique requiring a small change of the inspired oxygen fraction. *Anesth Analg.* 2005, 101(1):206-12.
- 108) Weismann D, Reissmann H, Maisch S, Füllekrug B, Schulte am Esch J. Monitoring of functional residual capacity by an oxygen washin/washout; technical description and evaluation. *J Clin Monit Comput.* 2006, 20:251–260.
- 109) *Karbing D.S, Kjærgaard S, Andreassen S, Espersen K, Rees S.E. The minimal model approach to quantification of pulmonary gas exchange of oxygen and carbon dioxide. In submission.
- 110) Zavorsky G.S. Accuracy of venous blood oxygen pressure depends on arterial blood oxygen pressure. *Eur Respir J,* 2009, 34:1207-1208

- 111) *Rees S.E. From the author: Accuracy of venous blood oxygen pressure depends on arterial blood oxygen pressure. *Eur Respir J*, 2009, 34:1208
- 112) Bilan N, Afshin G, Behbahan G, Khosroshahi A.J. Validity of venous blood gas analysis for diagnosis of acid-base imbalance in children admitted to pediatric intensive care unit. *World J Pediatr* 2008, 4(2):114-117.
- 113) Kelly A.M, McAlpine R, Kyle E. Venous pH can safely replace arterial pH in the initial evaluation of patients in the emergency department. *Emerg Med J*. 2001, 18:340-342.
- 114) Radiometer Medical ApS. The whole-blood sampling handbook, 2006.
- 115) Langewouters G.J, Settels J.J, Roelandt R, Wesseling K.H. Why use Finapres or Portapres rather than intra-arterial or intermittent non-invasive techniques of blood pressure measurement. *J Med Eng Technol*. 1998 Jan-Feb;22(1):37-43.
- 116) Sinderby C, Navalesi P, Beck J, Skrobik Y, Comtois N, Friberg S, Gottfried S.B, Lindström L. Neural control of mechanical ventilation in respiratory failure. *Nat Med*. 1999, 5(12):1433-6.
- 117) Brander L, Leong-Poi H, Beck J, Brunet F, Hutchison S.J, Slutsky A.S, Sinderby C. Titration and implementation of neurally adjusted ventilatory assist in critically ill patients. *Chest* 2009, 135(3):695-703.
- 118) Steimle K.L, Mogensen M.L, Karbing D.S, Smith B.W, Vacek O, Andreassen S. A mathematical physiological model of the pulmonary ventilation. In Rees S.E. et al., The 7th IFAC symposium on modeling and control in biomedical systems, 2009, pp 222-227, ISBN 978-3-902661-49-4.
- 119) *Gøtzsche M, Nielsen S.K, Rees S.E. A combined model of respiratory drive and acid-base status. In Rees S.E. et al., The 7th IFAC symposium on modeling and control in biomedical systems, 2009, pp 251-255, ISBN 978-3-902661-49-4.

7. Summary

This dissertation has addressed the broad hypothesis as to whether building mathematical models is useful as a tool for translating physiological knowledge into clinical practice. In doing so it describes work on the INtelligent VENTilator project (INVENT), the goal of which is to build, evaluate and integrate into clinical practice, a model-based decision support system for control of mechanical ventilation. The dissertation describes the mathematical models included in INVENT, i.e. a model of pulmonary gas exchange focusing on oxygen transport, and a model of the acid-base status of blood, interstitial fluid and tissues. These models have been validated, and applied in two other systems: ALPE, a system for measuring pulmonary gas exchange and ARTY, a system for arterialisation of the acid-base and oxygen status of peripheral venous blood.

The major contributions of this work are as follows. A mathematical model has been developed which can describe pulmonary gas exchange more accurately than current clinical techniques. This model is parsimonious in that it can describe pulmonary gas exchange from measurements easily available in the clinic, along with a readily automatable variation in FIO_2 . This technique and model have been developed into a research and commercial tool (ALPE), and evaluated both in the clinical setting and when compared to the reference multiple inert gas elimination technique (MIGET).

Mathematical models have been developed of the acid-base chemistry of blood, interstitial fluid and tissues, with these models formulated using a mass-action mass-balance approach. The model of blood has been validated against literature data describing the addition and removal of CO_2 , strong acid or base, and haemoglobin; and the effects of oxygenation or deoxygenation. The model has also been validated in new studies, and shown to simulate accurately and precisely the mixing of blood samples at different PCO_2 and PO_2 levels. This model of acid-base chemistry of blood has been applied in the ARTY system. ARTY has been shown to accurately and precisely calculate arterial values of acid-base and oxygen status in patients residing in the ICU, and in those with chronic lung disease.

The INtelligent VENTilator (INVENT) system has been developed for optimization of mechanical ventilator settings using physiological models and utility/penalty functions, separating physiological knowledge from clinical preference. The models can be tuned to the

individual patient via parameter estimation, providing patient specific advice. The INVENT team has shown prospectively that the system provides advice on FIO_2 which is as good as clinical practice, and retrospectively that the system provides reasonable suggestions of tidal volume, respiratory frequency and FIO_2 .

In general, this dissertation has illustrated a further example of the role of modeling in describing and understanding complex systems. The dissertation has shown that when dealing with complexity the goal of the model must be in focus if a correct balance is to be maintained between system complexity and model parameterization. The original goal of the INVENT team, i.e. to build, evaluate and integrate a DSS for control of mechanical ventilation has not as yet been completed. However, the broader hypothesis that building models generates new and interesting questions has been successfully demonstrated. The ALPE model and system has been applied in intensive care, post operative care and cardiology and is currently being evaluated in new clinical domains. ARTY has been shown to have potential benefit in eliminating the need for painful arterial punctures, and may also be useful as a screening tool. These systems illustrate the benefits of investing in models as a mechanism for translating physiological knowledge to clinical practice.

8. Dansk Resumé

Denne afhandling har søgt at besvare den brede hypotese om, hvorvidt det at bygge matematiske modeller er et brugbart værktøj til at omsætte fysiologisk viden til klinisk praksis. Herunder beskriver afhandlingen arbejdet med INtelligent VENTilator projektet (INVENT), som har det mål at bygge, evaluere og integrere et modelbaseret medicinsk beslutningsstøttesystem til kontrol af mekanisk ventilation i klinisk praksis. Afhandlingen beskriver de matematiske modeller der indgår i INVENT, dvs. en model af den pulmonale gasudveksling med fokus på iltransport og en model af syre-base status i blodet, den interstitielle væske samt vævene. Disse modeller er blevet valideret, og anvendt i to andre systemer: ALPE som er et system til at måle pulmonal gasudveksling, og ARTY som er et system til at udregne arteriel syre-base og ilt status ud fra perifer venøs blod.

De primære bidrag fra dette arbejde er som følger. En matematisk model er blevet udviklet som kan beskrive pulmonal gasudveksling mere nøjagtigt in nuværende kliniske målemetoder. Denne model er ”parsimonious”, idet den kan beskrive pulmonal gasudveksling ud fra målinger som er let tilgængelige i klinisk praksis sammen med en variation i FIO_2 , som let kan automatiseres. Denne målemetode og model er blevet udviklet til et forsknings- og kommercielt værktøj (ALPE), og er blevet evalueret både klinisk og i sammenligning med referencemetoden, ”the multiple inert gas elimination technique” (MIGET).

Matematiske modeller af syre-base kemien i blod, interstitiel væske samt vævene er blevet udviklet ud fra massevirkning og massebevarelse principper. Modellen af blodet er blevet valideret mod data fra litteraturen, som beskriver tilførelse og fjernelse af CO_2 , stærk syre eller base, og hæmoglobin samt effekterne af oxidation. Modellen er også blevet valideret i nye studier, som har vist at modellen nøjagtigt og præcist kan simulere blanding af blod med forskellige PCO_2 og PO_2 niveauer. Denne model af blodets syre-base kemi er blevet anvendt i ARTY systemet. Det er blevet vist at ARTY nøjagtigt og præcist kan udregne arterielle værdier for syre-base og oxygen status i patienter på en intensivafdeling, og i patienter med kronisk lungesygdom.

INtelligent VENTilator (INVENT) systemet er blevet udviklet til optimering af respiratorindstillinger ved at bruge fysiologiske modeller og nytte/straf-funktioner, hvorved fysiologisk viden adskilles fra kliniske præferencer. Modellerne kan tilpasses den individuelle

patient via parameterestimering, for derved at muliggøre patient specifikke råd. INVENT holdet har vist i et prospektivt studie at systemets råd om indstilling af FIO_2 er lige så hensigtsmæssige som niveauer valgt i klinisk praksis og i et retrospektivt studie at systemet giver fornuftige råd om indstilling af tidalvolumen, respirationsfrekvens og FIO_2 .

Generelt set har denne afhandling illustreret et yderligere eksempel på modellerings rolle i forbindelse med beskrivelse og forståelse af komplekse systemer. Afhandlingen har vist at ved arbejde med kompleksitet det nødvendigt at bevare fokus på modellens mål, hvis man skal opretholde den korrekte balance imellem kompleksitet af systemet og parametrisering af modellen. Det oprindelige mål for INVENT holdet om at bygge, evaluere og integrere et beslutningsstøttesystem til kontrol af mekanisk ventilation er endnu ikke blevet opnået. Trods det, så er den bredere hypotese om, at det at bygge modeller genererer nye og interessante spørgsmål, blevet succesfuldt demonstreret. ALPE modellen og systemet er blevet anvendt i intensiv medicin, postoperativ pleje samt kardiologi og bliver i øjeblikket evalueret i nye kliniske domæner. Det er blevet vist, at ARTY potentielt kan gøre gavn ved at fjerne behovet for smertefulde arterielle punkture og at det kan være et nyttigt værktøj til screening. Disse systemer illustrerer fordelene ved at investere i modeller som en mekanisme til at omsætte fysiologisk viden til klinisk praksis.