



Aalborg Universitet

AALBORG UNIVERSITY  
DENMARK

## An improved control method of power electronic converters in low voltage micro-grid

Xiaofeng, Sun ; Qingqiu, Lv ; Yanjun, Tian ; Chen, Zhe

*Published in:*

Proceedings of the International Conference on Electrical Machines and Systems, ICEMS 2011

*DOI (link to publication from Publisher):*

[10.1109/ICEMS.2011.6073439](https://doi.org/10.1109/ICEMS.2011.6073439)

*Publication date:*

2011

*Document Version*

Early version, also known as pre-print

[Link to publication from Aalborg University](#)

*Citation for published version (APA):*

Xiaofeng, S., Qingqiu, L., Yanjun, T., & Chen, Z. (2011). An improved control method of power electronic converters in low voltage micro-grid. In *Proceedings of the International Conference on Electrical Machines and Systems, ICEMS 2011* (pp. 1-6). IEEE Press. <https://doi.org/10.1109/ICEMS.2011.6073439>

### General rights

Copyright and moral rights for the publications made accessible in the public portal are retained by the authors and/or other copyright owners and it is a condition of accessing publications that users recognise and abide by the legal requirements associated with these rights.

- ? Users may download and print one copy of any publication from the public portal for the purpose of private study or research.
- ? You may not further distribute the material or use it for any profit-making activity or commercial gain
- ? You may freely distribute the URL identifying the publication in the public portal ?

### Take down policy

If you believe that this document breaches copyright please contact us at [vbn@aub.aau.dk](mailto:vbn@aub.aau.dk) providing details, and we will remove access to the work immediately and investigate your claim.

# An Improved Control Method of Power Electronic Converters in Low Voltage Micro-grid

Sun Xiaofeng<sup>1</sup>, Lv Qingqiu<sup>2</sup>, Tian Yanjun<sup>3</sup>, ZHE CHEN<sup>4</sup>

<sup>1</sup> Professor, Yan shan University, He bei, China

<sup>2,3</sup> Master Candidate, Yanshan University, He bei, China

<sup>4</sup> Professor, Aalborg University, Aalborg, Denmark

<sup>1</sup> E-mail: sxf@ysu.edu.cn

**Abstract** —With the increasing acceptance, micro-grid, combined with distributed generation (DG), may be operated in two modes: grid-connected mode and island mode. In grid connected mode, energy management is the control objective. While in island mode, the control of Voltage and frequency will take the place. The conventional droop control can perform the energy management in grid-connected mode, but may not so effective when micro-grid transferring between grid-connected mode and island mode. The paper analysis the micro-grid in different modes (Conventional droop control, Voltage reference compensation, Constant power output mode, Phase adjustment mode), and then proposes an overall control strategy for the micro-grid. The voltage reference compensation would minimize the steady-state error on the nominated operation point; the coordinate control of voltage and frequency with a feed forward control of the voltage and frequency deviation added to power references could achieve secondary regulation of the voltage and frequency. In this paper, the authors take the steady and transient transition of grid connecting and disconnecting of the micro-grid as an example, and demonstrate that compensation on voltage reference is effective, and voltage and frequency coordination control can well perform not only energy management in grid-connected mode, but also the secondary regulation of voltage and frequency when micro-grid separates from the main grid, and furthermore the strategy can perform well in the transition states between the operation modes. The new droop control method has been validated through simulations by PSCAD software and experiments.

## I. INTRODUCTION

In recent years, researchers start to pay attention on studies of distributed generation (DG) technology [1-3]. DG units may be located in distribution network or on the local load side, which can supply reliable and economic energy [4]. The generation technology can be gas turbines, fuel cells, photovoltaic systems or wind turbines. When cooperate with energy storage devices (battery, fly wheel etc) to supply energy for load, they may form a micro-grid [5-6]. A Micro-grid has two operating modes: grid-connected mode and island mode, both modes require effective regulations and control of the DG. A power electronic system is usually used to interface the DG and micro-grid, the control of power electronic converter is the key point.

The control strategy in micro-grid may be classified into two kinds: master-slave control and distributed control. In master-slave control, the master unit collects the information

and delivers control data to distributed slave units, so a communication system will be necessary. The distributed control performs the regulation based on the local measurements, which achieves the plug and play without the interconnection lines. So several papers discuss the distributed control method, but more often directly apply the droop control in high voltage system into low voltage distribution system without a detailed analysis on the feature of the distributed system [7]. Ref [8] has proposed an improvement on the conventional droop control, suggested an On-line estimation algorithm which makes the droop control can apply in the low voltage micro-grid. But the control strategy is quite complex. Ref. [9] takes the output impedance into account, applies the droop control of high voltage systems on the control of DG in micro-grid as well as a multi loop control, but this make the design complicated. Ref [10-11] put forward the control strategy of the opposite droop control, making the conventional droop control correcting to opposite droop control according to low voltage micro-grid's line impedance feature. But when separating from the main grid, the converter output power may make the micro-grid voltage and frequency beyond the limited values; in the process of reconnecting to the main grid, the inverter output power will also have great impact. Ref [12] provided with a phase detection method to minimize the impact based on interconnection line to deliver the phase message.

The paper analyzes droop control and presents an improved control strategy based on Power-Voltage (PV) droop control and a number of control methods. When in grid connected mode, it applies constant power control, making the micro-grid's active power and reactive power to follow a given value. The transition from grid connected mode to the island mode, it will apply a droop control based on secondary frequency control concept to maintain the stable voltage and frequency; The transition from an island mode to a grid connection mode, a phase detection is applied to adjust the micro-grid phase so that the micro-grid's phase is similar the main grid's phase, reducing the impact of connecting to grid. This control scheme may realize both the micro-grid's distributed control and the plug and play control.

## II. ANALYSIS OF DROOP CONTROL

Fig 1 is a simplified topology of an inverter connected to a micro-grid. The voltage source  $V_s \angle \delta$  represents the output voltage of the inverter, and the transmission line impedance is  $R + jX$ , and the  $E \angle 0^\circ$  is voltage on the bus.

The output active and reactive power of the inverter are given as (1)(2):

$$P = \frac{E}{R^2 + X^2} [R(V_s \cos \delta - E) + XV_s \sin \delta] \quad (1)$$

$$Q = \frac{E}{R^2 + X^2} [X(V_s \cos \delta - E) - RV_s \sin \delta] \quad (2)$$

(3) (4) can be derived from (1)(2) :

$$V_s \sin \delta = \frac{XP - RQ}{E} \quad (3)$$

$$V_s \cos \delta - E = \frac{RP + XQ}{E} \quad (4)$$

In a low voltage system, the line reactance X is small in comparison with the line resistance, R. An example is given in Table 1.

TABLE 1 : TYPICAL TRANSMISSION LINE PARAMETER

Voltage	$R/\Omega \cdot km^{-1}$	$X/\Omega \cdot km^{-1}$	$R/X$
Low	0.624	0.083	7.7
Middle	0.161	0.190	0.85
High	0.060	0.191	0.31

So  $\sin \delta = \delta, \cos \delta = 1$  is assumed (3)(4) may be simplified as (5)(6).

$$\delta \cong \frac{-RQ}{V_s E} \quad (5)$$

$$V_s - E \cong \frac{RP}{E} \quad (6)$$

Then the PV droop control may be expressed as :

$$f - f_0 = k_q (Q - Q_0) \quad (7)$$

$$V - V_0 = -k_p (P - P_0) \quad (8)$$

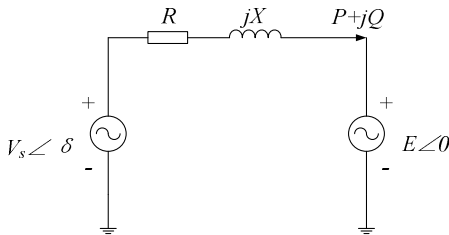

Fig.1 Schematic of a voltage source inverter connected to grid

## III. ANALYSIS OF MICRO-GRID OPERATIONAL MODAL

### A. Constant Power Output and Opposite Droop Control

When a micro-grid is connected to the main grid, the sources with small capacity, which can not causes significant impact on the voltage of the micro-grid, can work in constant power mode, then they will behave like loads. When the micro-grid needs to work with the dispatched power, it can also adopt the constant power output mode.

The constant power output equations are expressed (9) and (10):

$$V - V_0 = \frac{k_p s + k_i}{s} (P - P_0) \quad (9)$$

$$f - f_0 = k (Q - Q_0) \quad (10)$$

The PV droop control of uses an PI regulator as shown in (9) to eliminate the steady-state error. The frequency droop control stays the same, for the reactive power output is zero steady-state error. The diagram of the PV droop control and constant power output mode are shown as Fig 2,  $V_{ref}$  is the rated amplitude of voltage of the main grid, and  $P_{ref}$  is the rated active power. When K1 is closed, it will be constant power output, when K2 is closed, it will be PV droop control. As depicted in Fig 3, in PV droop control if the output active power is zero steady-state error, the output voltage of the inverter is  $V_{ref}$ . According to (6), then the output active power will be zero. So the voltage reference needs to be adjusted according to the active power reference. The compensation is from the same as the constant power output mode, as shown in Fig3.

When K1 is closed and K2 is open, the droop part will be PI regulator, which can achieve zero steady-state error in the output of active power. The main grid takes care of the fluctuation of the load.

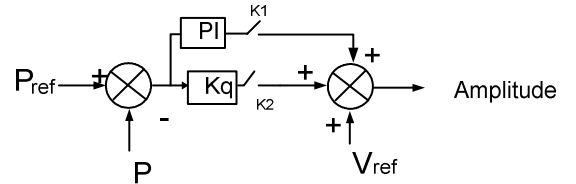

Fig 2 Constant power output mode and PV droop control

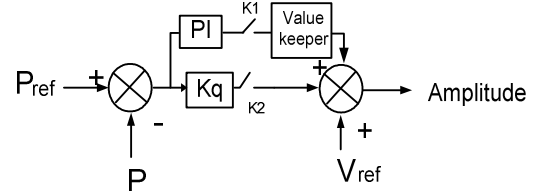

Fig 3 Voltage reference compensation in opposite droop control

The value keeper in Fig 3 takes the record of the output of the PI regulator, and the value in the value keeper is used to modify the power reference value  $P_{ref}$ . Then K1 is open and K2 is closed, the PV droop control will work in zero error steady-state.

### B. Switching Control between Grid Connected Mode and Island Mode

In grid connected mode, if a power system fault takes place in main grid, the micro-grid may turn into island mode. The transition will affect the output power of the inverter, and may result in the voltage and frequency out of the limitation. So on the basis of secondary frequency regulation, the paper proposes a coordination droop control, as (13) (14).

$$f - f_0 = k_{nq} \left[ (Q - Q_0) + \frac{k_{pf}s + k_{if}}{s} (f_0 - f) \right] \quad (13)$$

$$V - V_0 = -k_{np} \left[ (P - P_0) + \frac{k_{pv}s + k_{iv}}{s} (V_0 - V) \right] \quad (14)$$

Where  $k_{p\omega}$ ,  $k_{i\omega}$ ,  $k_{pv}$ ,  $k_{iv}$  are the feed forward controller parameters.

In(13) and(14) , the second term of the right parts contribute to secondary adjustment of the voltage and frequency to minimize the deviation.

The coordination droop control will keep the value of voltage and frequency within specified rang, and smoothens the transition. For a multi-inverter system, the new droop control can preform the transformation between grid connected and island mode; for a single inverter system, it can also perform power quality control in island mode.

#### IV. COORDINATION CONTROL FROM ISLAND MODE TO GRID CONNECTED MODE

Before reconnecting to the main grid, the micro-grid has to synchronize its voltage vector with the main grid. Several papers adopt the method as following:

$$f = f_0 - PI * (|\theta| - |\theta_0|) \quad (15)$$

$\theta_g$  is the phase angle of the micro-grid voltage vector, and  $\theta_{ug}$  is the phase angle of the micro-grid voltage vector.  $f_0$  is the nominated value of frequency.  $f$  is the output frequency of the inverter.

The method need to detect the phase angle of main grid, and then deliver the information to the inverters. Therefore, the interconnection between inverters will be necessary and enable the function of of “plug and play”. The paper presents a new solution based on the phase detection of the voltage at the point of common coupling (PCC). After receiving the order of operation, the phase error on the both sides of the circuit

breaker at PCC will be detected the circuit breaker will not be operated until the phase error within a specified range. which can be realized by adjusting the inverter with adding small deviation on the frequency.

$$f_d \times T_d < 2\Delta\theta \quad (16)$$

$$|f_d| < |(f_0 - f_{limit})| \quad (17)$$

$f_d$  is the deviation of the frequency,  $T_d$  is the time that the circuit breaker will take to execute the action  $f_{limit}$  is the boundary of the frequency.  $f_d$  and  $T_d$  will obey the following rule to guarantee the phase error will be zero within certain range:

$$f_d \times T_d > 2\pi \quad (18)$$

$f_d$  will not be a single constant value , but three values depending on different conditions, as in Fig 4.

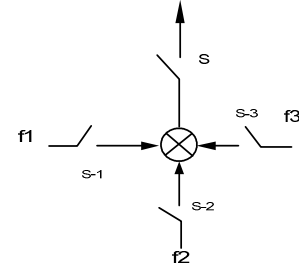

Fig 4 Phase adjustment before connecting to grid

#### V. THE OPERATION MODES OF MICRO-GRID

As depicted in Fig 5, in grid connected mode, the objective is the management of dispatched power. So the DG in micro-grid could adopt constant power output mode or PV droop control. When disconnecting from the main grid, the coordination droop control is implemented to minimize the transition impact. In island mode, opposite droop control is employed, and cooperate with load shielding to keep balance of the whole power system between supply and consumption. When reconnected to the main grid, micro-grid implements phase adjustment to synchronize the voltage vector with main grid. The control diagram of the inverter is declared in Fig 6.

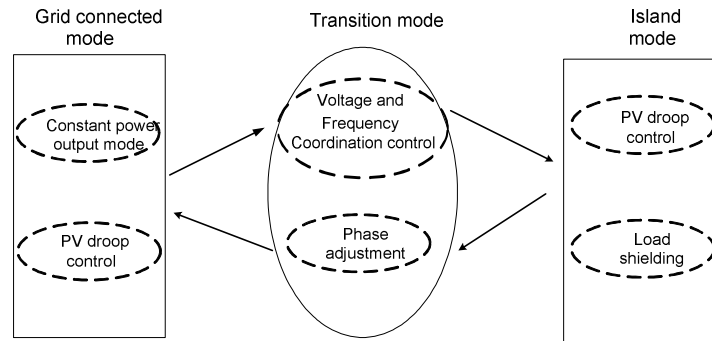

Fig5The operation modes and their transition of micro-grid

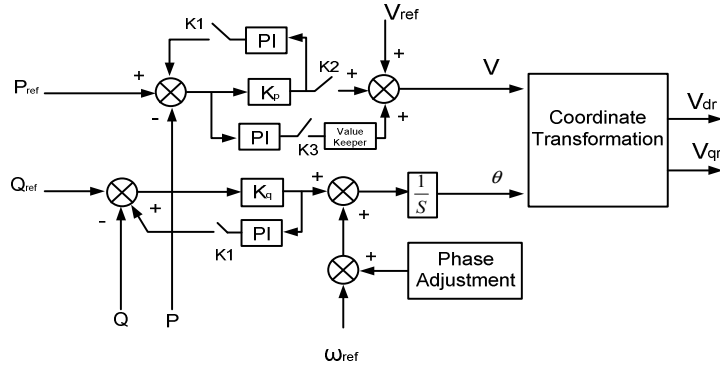

Fig 6 The control diagram of the inverter

If K1 and K3 are open and K2 is closed, the control structure will be PV droop control; if K1, K2 are open and K3 is closed, the system will be constant power output mode. If K1 K2 are closed, and K3 is open, it will be coordination droop control. By operating the selective switches, the inverter can operate and transform among the different control modes.

## VI. SIMULATION RESULTS

The micro-grid was built and tested in PSCAD software. Fig 7 shows the topology. The micro-grid system is shown in single lines. Two DGs are a PV system and a fuel cell. Micro-grid is connected to main grid through an intelligent static bypass switch, IBS. When a fault occurs in main-grid, the IBS will separate the micro-grid from the main grid. After the recovery of main grid, the IBS will be closed to reconnect the micro-grid to the main grid.

### A. Simulation Results of Voltage Reference Compensation

As depicted in Fig 8, the blue curves are PV droop control without voltage reference compensation, the green curves include reference compensation.

The  $P_{ref}$  is 15kW.  $Q_{ref}$  is 5 kVar. At 1.0s, the micro-grid is disconnected from the main grid. Without voltage reference compensation, the inverter output active power is 12.4kw, and reactive power is 4.1kVar, however, with voltage compensation, the output active power is 15kw, and reactive power is 4.9 kVar. The compensation on voltage reference reduces the steady-state error, and also optimizes the voltage on the micro-grid bus.

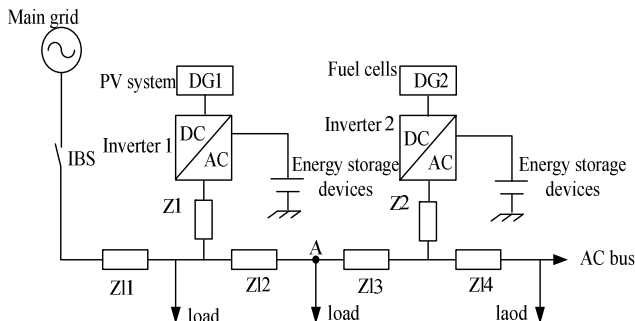

Fig.7 Micro-grid structure used for simulation

### B. Transformation between Opposite Droop Control and Constant Output Power Output Control

As showed in Fig. 9, the upper curve is active power that delivered from main grid to micro-grid, the middle curves are the output active powers of DG in micro-grid, and the bottom curve is the voltage at the bus of micro-grid. In PV droop control operation, both the DG in micro-grid and the main grid supply the load change, as showed in the first step. In the second step, the inverter turned to constant power output, so the main grid takes the load change while the inverter output constant power. In step three, when the load is decreasing, the inverter return to opposite droop control to maintain balance on dispatched power.

### C. Working Pattern of IBS

Fig 10 is the wave pattern on the IBS, the upper curve is the phase error, and the bottom curve is the statue of the IBS. Set the range of the phase error is  $(-0.02\text{rad}, 0.02\text{rad})$ , after receiving the order of closing the circuit, the IBS will execute the action of connecting to main grid.

### D. Coordination Droop Control

Fig 11 and 12 compare the intentional island operation between the two regulation methods, opposite droop control and new droop control.

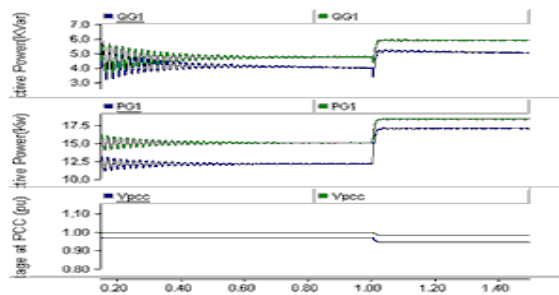

Fig 8 the comparison of effect by the voltage reference compensation

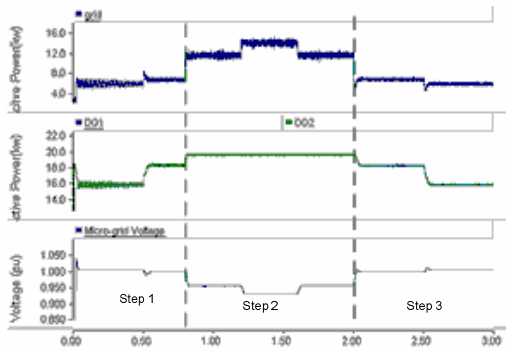

Fig9 the transition between droop control and constant power output mode

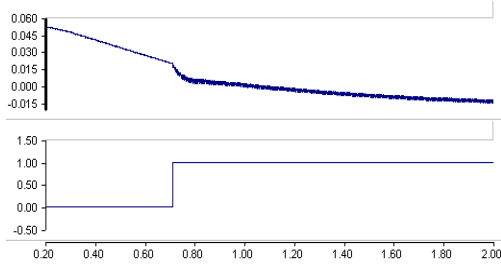

Fig10 the phase error and the execute time of the IBS in phase adjustment mode

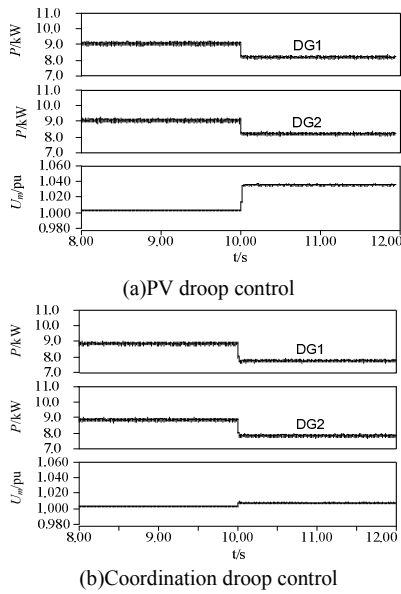
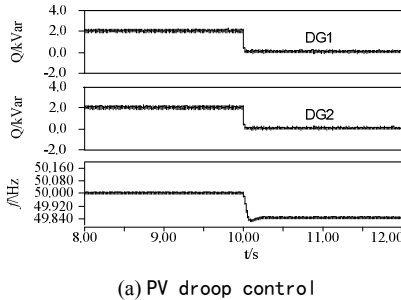

Fig11 The output active power of inverters and the voltage of A point while disconnecting to grid



(a) PV droop control

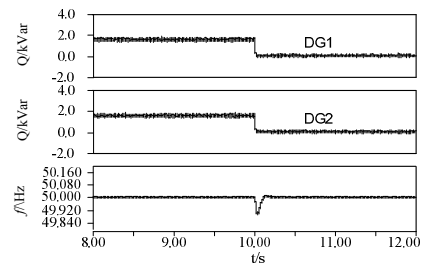

Fig.12 The output reactive power of inverters and the frequency of A point while disconnecting to grid

Opposite and new droop control can both realize energy management. In island mode, opposite control output active power was 7.9kW, the per unit voltage on the bus was 1.0017; the new droop output active power was 8.25kW, the per unit voltage is 1.036. The both values of output reactive power are 0Var. But there is a frequency difference, new droop control was nearly 50Hz, while P-V was 49.85Hz. The new droop control realized the secondary frequency regulation.

## VII. EXPERIMENT RESULTS

The inverter in the experiment is 3kW, the inverter is formed by three IGBT half bridges and LC filters.

The switching frequency is 20kHz. The transmission line impedance is resistive of 1  $\Omega$ . Inverter rated active power is 650W, and rated reactive power is 130Var, while total active load is 400W, reactive load is 0Var. The deviations in voltage and frequency were enlarged for a clear view.

As depicted in figure 13 and 14, from grid connected to island mode, the output active power in opposite droop control is 408W, per unit voltage is 1.01045, while in P-V regulation, the correspondent value are 430W, and 1.022. The values of both output reactive are the same 0Var.

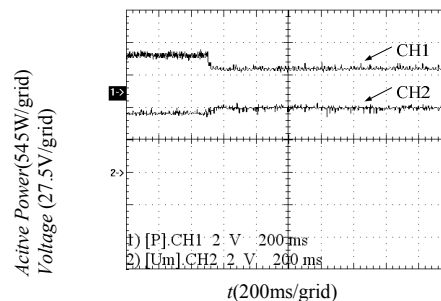
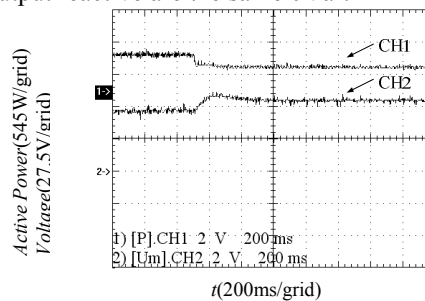
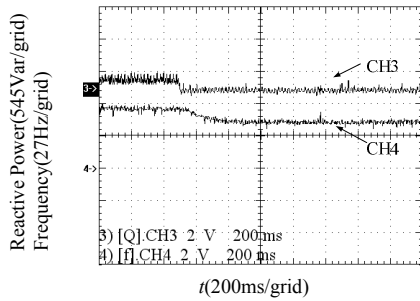
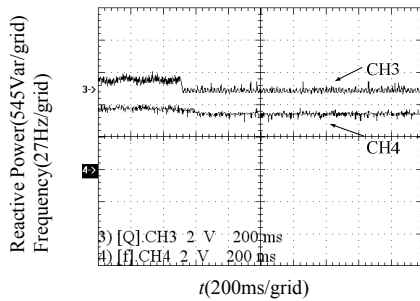

Fig.13 The output active power and the voltage of inverter while disconnecting to grid



(a)PV droop control



(b)Coordination droop control

Fig.14The output reactive power and the frequency of inverter while disconnecting to grid

The frequency in NP-V control is 49.95Hz but the P-V control is 49.757Hz.

As stated above, in island mode, secondary regulation in voltage and frequency can be realized in NP-V regulation, which will minimize the voltage and frequency deviation and can also switch seamlessly from grid-connected mode to island mode.

## VIII. CONCLUSIONS

The paper presents theoretical analysis, and simulation results of an overall control strategy of a micro-grid. By adding a voltage reference compensation the steady state of inverters in micro-grid can be optimized. The transition impact when disconnecting or reconnecting to the DG from/to main grid is smoothenby implementing the opposite droop control and phase adjustment mode . Through simulation and experiment, the paper showed that the NP-V can re-adjust the deviation in voltage and frequency, maintain the voltage and frequency more stable..

## ACKNOWLEDGMENT

This This work was supported by National Science Foundation of China (51077112 , 50837003).

## REFERENCES

[1] Liang Youwei, Hu Zhijian, Chen Yunping. A survey of distributed generation and its application in power system . Power System Technology, 2003,27(12):71-75

[2] Qian kejun, Yuan ye, Zhou chenke. Study on impact of distributed generation on distribution system reliability . Power System Technology, 2008, 32(11) : 74-78.

[3] Ding Lei, Pan Zhencun, Cong Wei. Searching for Intentional Islanding Strategies of Distributed Generation Based on Rooted Tree[J] . Proceedings of the CSEE, 2008, 28(25) : 62-67.

[4] Ackermant, Andersong, and Sederl. Distributed generation : a definition[J]. Electric Power System Research, 2001, 57(6) : 195-204.

[5] Lasseter R, Piagi P. Providing Premium Power through Distributed Resources[C]. Proc. of the 33rd Hawaii Int. Conf. on System Science, 2000.

[6] Wang Zhiqun, Zhu Shouzhen, Zhou Shuangxi. Controller design for inverter-based distributed generation[J]. Automation of Electric Power System, 2004, 28(24) : 61-66.

[7] T. Ota, K. Mizuno, K. Yukita, H. Nakano, Y. Goto, K. Ichianagi. Study of Load Frequency Control for a Micro-Grid. Australasian Universities Power Engineering Conference. 2007.

[8] Yun Wei Li, Ching-Nan Kao. An Accurate Power Control Strategy for Power-Electronics-Interfaced Distributed Generation Units Operation in a Low-Voltage Multibus Microgrid. IEEE TRANSACTIONS ON POWER ELECTRONICS ,VOL 24. NO 12.DECEMBER 2009

[9] Wang Chenshan , Xiao Zhaoxia , Wang Shouxiang . Synthetical control and analysis of micro-grid. Automation of Electric Power System, 2008, 32(7) : 98-103.

[10] Wang Chenshan , Xiao Zhaoxia , Wang Shouxiang . Multiple feedback loop control scheme for inverters of the micro source in microgrids. Transactions of China Electrotechnical Society, 2009, 24(2) : 100-107.

[11] Josep M. Guerrero, Nestor Berbel, Jose Matas. Droop Control Method with Virtual Output Impedance for Parallel Operation of Uninterruptible Power Supply Systems in a Micro-grid. Conference Proceedings - IEEE Applied Power Electronics Conference and Exposition. 2007.

[12] P.Arboleya, D. Diaz, J.M.Guerrero, P.Garcia, F.Briz, C. Gonzalez-Moran, J.Gomez Aleixandre , An improved control scheme based in droop characteristic for microgrid converters, Electric Power Systems Research 80 (2010)1215-1221