



AALBORG UNIVERSITY
DENMARK

Aalborg Universitet

Rolling Cylinder Phase 1

proof of concept and first optimization

Margheritini, Lucia; Taraborrelli, Valeria Taraborrelli

Publication date:
2011

Document Version
Publisher's PDF, also known as Version of record

[Link to publication from Aalborg University](#)

Citation for published version (APA):

Margheritini, L., & Taraborrelli, V. T. (2011). *Rolling Cylinder Phase 1: proof of concept and first optimization*. Department of Civil Engineering, Aalborg University. DCE Technical reports No. 115

General rights

Copyright and moral rights for the publications made accessible in the public portal are retained by the authors and/or other copyright owners and it is a condition of accessing publications that users recognise and abide by the legal requirements associated with these rights.

- ? Users may download and print one copy of any publication from the public portal for the purpose of private study or research.
- ? You may not further distribute the material or use it for any profit-making activity or commercial gain
- ? You may freely distribute the URL identifying the publication in the public portal ?

Take down policy

If you believe that this document breaches copyright please contact us at vbn@aub.aau.dk providing details, and we will remove access to the work immediately and investigate your claim.

Rolling Cylinder Phase 1: proof of concept and first optimization

Lucia Margheritini
Valeria Taraborrelli

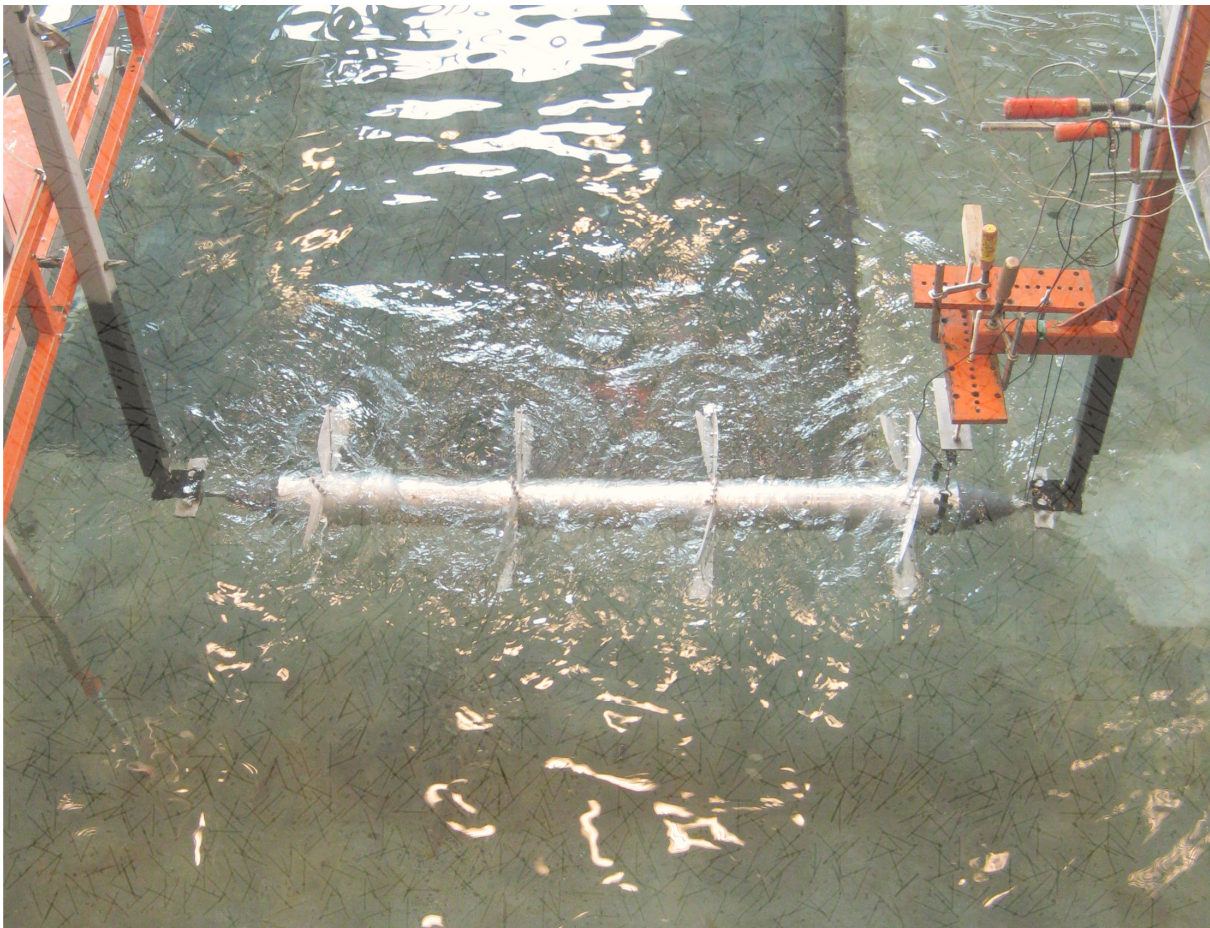

Aalborg University
Department of Civil Engineering
Group Name

DCE Technical Report No. 115

**Rolling Cylinder Phase 1:
proof of concept and
first optimization**

by

Lucia Margheritini
Valeria Taraborrelli

July 2011

© Aalborg University

Scientific Publications at the Department of Civil Engineering

Technical Reports are published for timely dissemination of research results and scientific work carried out at the Department of Civil Engineering (DCE) at Aalborg University. This medium allows publication of more detailed explanations and results than typically allowed in scientific journals.

Technical Memoranda are produced to enable the preliminary dissemination of scientific work by the personnel of the DCE where such release is deemed to be appropriate. Documents of this kind may be incomplete or temporary versions of papers—or part of continuing work. This should be kept in mind when references are given to publications of this kind.

Contract Reports are produced to report scientific work carried out under contract. Publications of this kind contain confidential matter and are reserved for the sponsors and the DCE. Therefore, Contract Reports are generally not available for public circulation.

Lecture Notes contain material produced by the lecturers at the DCE for educational purposes. This may be scientific notes, lecture books, example problems or manuals for laboratory work, or computer programs developed at the DCE.

Theses are monographs or collections of papers published to report the scientific work carried out at the DCE to obtain a degree as either PhD or Doctor of Technology. The thesis is publicly available after the defence of the degree.

Latest News is published to enable rapid communication of information about scientific work carried out at the DCE. This includes the status of research projects, developments in the laboratories, information about collaborative work and recent research results.

Published 2011 by
Aalborg University
Department of Civil Engineering
Sohngaardsholmsvej 57,
DK-9000 Aalborg, Denmark

Printed in Aalborg at Aalborg University

ISSN 1901-726X
DCE Technical Report No. 115

Preface

This report has been prepared under the contract agreement between Aalborg Universitet and Storper Innovation ApS.

The report has been written by Lucia Margheritini (lm@civil.aau.dk) who is also responsible for the data analysis. Laboratory tests in regular waves have been run by Lucia Margheritini and Valeria Taraborrelli (valeria.taraborrelli@hotmail.it) with a total of 3 day visit from the developers. Laboratory tests in irregular waves will be performed by Lucia Margheritini.

The report is aimed at the first stage testing of the Rolling Cylinder wave energy device. This phase includes tests in regular waves and irregular waves, realized in two different set of tests.

Date and version	Person	Comment
17/04/2012 0.1	Lm	N/m in Nm

Table of Contents

1.	Introduction	3
2.	Objectives of the report.....	4
3.	Laboratory tests in regular waves – Optimization.....	5
1.1	Objectives.....	5
1.2	Model description.....	5
1.3	Laboratory set up.....	6
1.3.1	Measuring equipment.....	8
1.3.2	Test program.....	9
2	Results and Analysis – (Regular Waves).....	12
2.1	Optimization of fin’s thickness.....	12
2.1.1	Conclusions –best fin thickness	15
2.2	Optimization of number of fin’s sets	16
2.2.1	Length of the model and shadowing effect	19
2.2.2	Conclusions –best number of fin’s sets	21
2.3	Optimization of fin’s number par set.....	22
2.3.1	Conclusions –best number of fins par set.....	24
2.4	Optimization of the buoyancy level.....	25
2.4.1	Conclusions –best draft/buoyancy level.....	27
3	First estimate of power production	28
4	Conclusions	29
	Appendix A	31
	Appendix B.....	35

1. Introduction

The Rolling Cylinder is an innovative wave energy device at first stage of development at the time this report is created. Similar concepts are: Pelamis, T Basse's wave turbine and Bartholins roterende bølgeenergiabsorber (J. B. Jensen & J. P. Kofoed, 2002).

Wave energy converters typically undergo to four phase testing before full scale/prototype deployment (Kofoed et al. 2009):

- Phase 1: Proof of concept. Rough estimates of energy production in five specified wave states leading to an estimate of a yearly energy production, through small indicative laboratory tests. Outcomes include suggestions for further development of the device.
- Phase 2: Design and feasibility study. Typically through detailed laboratory tests in scale 1:50 to 1:20, optimization, detailed numerical calculations, estimates on cost, feasibility studies, Power take-off (PTO) design, etc. This is done by mean of intensive laboratory tests and/or intensive numerical modeling, often in more than one run.
- Phase 3: Testing in real seas in scale 1:10 to 1:3. Normally Nissum Bredning (a "small" benign piece of inner sea, a part of the Limfjord in the northern part of Denmark has been previously used for this purpose.
- Phase 4: Demonstration in half or full scale.

The Rolling cylinder has been previously tested at the Folkecenter and in Nissum Bredning therefore the present study includes aspects both from Phase 1 and Phase 2.

2. Objectives of the report

The general objective of the report is to prove the Rolling Cylinder concept through laboratory testing. This is done by constructing a short model corresponding to 1/3 of the total length of the device in scale 1:25 and optimizing some key parameters in regular waves. Particular attention is given in order to identify any shadowing effect generated by the sets of fins, as required by the developer.

The specific objectives can then be broken down to:

- 1) Model construction.
- 2) Optimization of the fin thickness.
- 3) Optimization of the distance between two consecutive sets of fins (i.e. optimization of the number of sets of fins).
- 4) Optimization of fins number par set.
- 5) Optimization of the buoyancy level.

Results are presented in terms of power production and efficiency in scale 1:25.

After the regular waves tests, the optimized “short model” is defined. Two identical pieces will be constructed to form the all together the “long model” that will then represent the complete model of the Rolling Cylinder in scale 1:25. The long model will be tested in irregular waves for validation of results and estimation of power production. The purpose of this final stage is:

- 1) Final calculation of power production for the optimized geometry.

3. Laboratory tests in regular waves – Optimization

Small scale laboratory testing is used in order for optimization and to gain knowledge on the device before the deployment at sea. Laboratory tests can give information on energy production, movements of the device and loads. In this report only the energy production and the some movements of the device are investigated for different configurations. The tests give a rough estimate of the energy production ($\pm 25\%$).

The model law used in relation to wave laboratory tests is Froudes Model Law, which requires:

- Inertia forces to dominate the physics. Friction forces must be negligible relative to the inertia forces. Inertia forces are forces proportional to the volume/mass of the device.
- The model must be geometrically similar to the full scale device.

The Froude number is defined as:

$$Fr = \frac{V}{\sqrt{gL}}$$

Where L is the length (m), g is the gravity acceleration ($=9.82 \text{ m/s}^2$) and V is the velocity (m/s). Dynamic similarity requirement between model (M) and full scale (F) is:

$$\frac{V_M}{\sqrt{gL_M}} = \frac{V_F}{\sqrt{gL_F}}$$

This equality ensures that gravity forces are correctly scaled. Scaling relations (Table 1) are derived from the physical units:

$$V_F = V_M \sqrt{\frac{L_F}{L_M}} = V_M \sqrt{\lambda}, \quad \lambda = \frac{L_F}{L_M}$$

The scale of the model (λ) is typically defined by the dimensions of the laboratory and the wave generation capabilities. In this case this has been chosen to $\lambda=25$.

Parameter	Scaling relation
Length	λ
Time	$\lambda^{0.5}$
Velocity	$\lambda^{0.5}$
Force	λ^3
Power	$\lambda^{3.5}$

1.1 Objectives

The objectives of the laboratory tests are:

- 1) Construction of the model
- 2) Optimization of fin thickness
- 3) Optimization of distance between consecutive sets of fins
- 4) Optimization of the buoyancy level
- 5) To find optimal load for each of the tested configurations

1.2 Model description

The main body of the short model (1/3 of overall length in scale 1:25) has been realized with one tube of stainless steel of 1400 mm and two hard plastic cones fixed at the two extremities of 120 mm each. The

fins have been fixed to the main body by mean of an “L” element rigidly connected to the tube by mean of two screws each (Fig. 1).

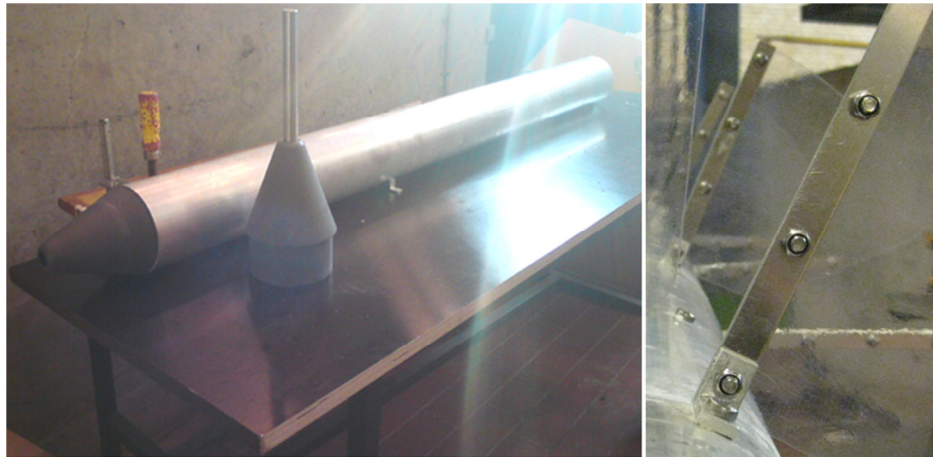

Figure 1. Model construction. Main body (lf) and fin's connection detail (rg).

The fins' profile have been suggested by the developer. Because of the necessity of testing different thicknesses, fins have been cut in the desired shape and then have been mounted on the device connecting them to the “L” element by mean of two rigid metallic stripes that where locking the fin by mean of 4 screws each (Fig2).

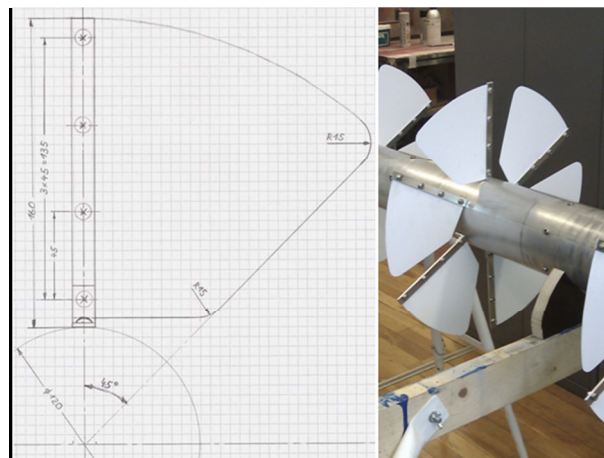

Figure 2. Fins' profile.

The short model also has the possibility to modify the fin's setup and allocate the fin's sets in different points along the length.

1.3 Laboratory set up

The model has been tested in the deep 3D wave basin at the Hydraulic and Coastal Engineering Laboratory of Aalborg University. It is a steel bar reinforced concrete tank with the dimensions 15.7 x 8.5 x 1.5 m. A 1.5 m deep section of 4.5 x 2.1 m with windows meant for under-water inspection of models allows water depths up to approximately 3 m. The paddle system is a snake-front piston type with a total of ten actuators, enabling generation of short-crested waves. The snake principle was chosen as it for the same number of actuators lead to a significant reduction in spurious waves compared to the more common seen segmented type. The wave generation software used for controlling the paddle system is AWASYS (Fig. 3), developed by the laboratory.

A long rod of 6 mm through the device length has been equipped with bearings to allow the rotation. Bearing are then rigidly fixed to the two bridges over the tank by mean of clamps. The water depth was 0.65 m (Fig 4).

The data acquisition was handled by WaveLab software, chosen sample frequency of 25 Hz.

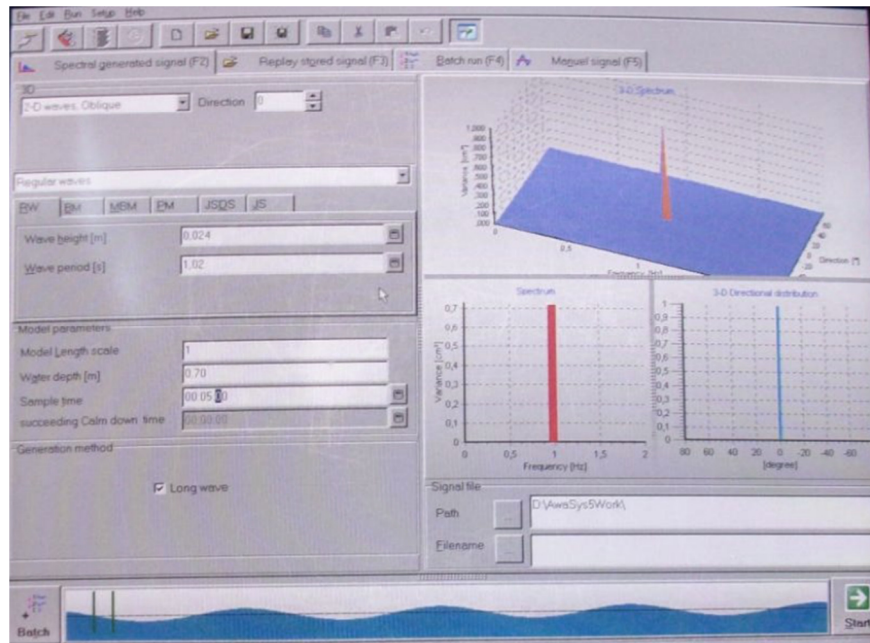

Figure 3. AWASYS main window.

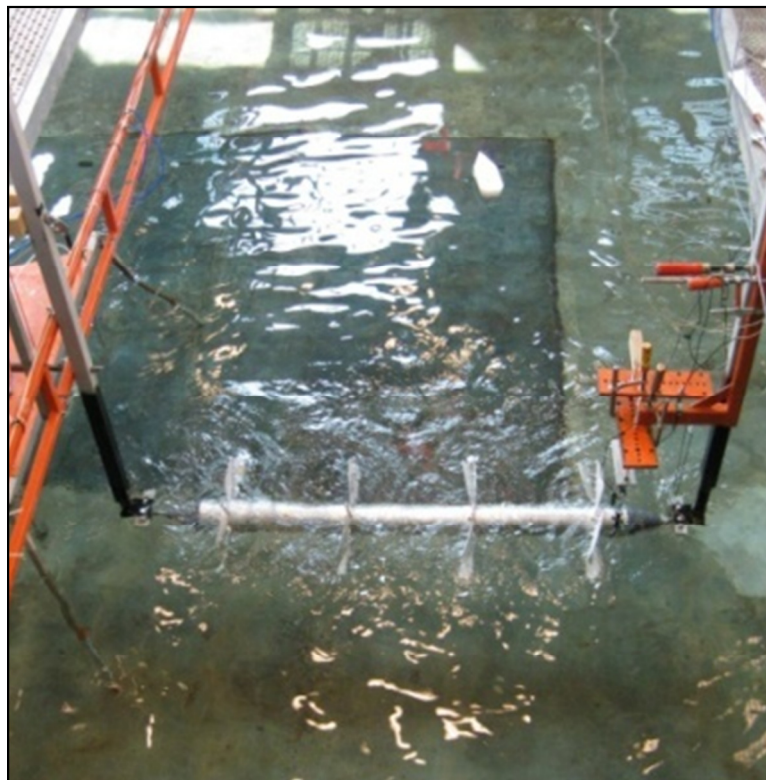

Figure 4. Laboratory set-up

1.3.1 Measuring equipment

Two different measuring systems have been used.

- The first measuring system (Fig. 5) is of a friction based kind (Fig. 6). It included two load cells attached to a stripe passing around the cylinder. By a mechanism it is possible to adjust the load on the cylinder. The cylinder rotation generates then 2 forces. The instantaneous resultant of F1 and F2 multiplied by the radius of the cylinder $R = 0.06$ m gives the instantaneous momentum (or torque) $M(t)$. In addition, a potentiometer connected to the small root measures the rotational speed v . The power in this case is instantaneously calculated from the equation:

$$P(t) = M(t) * v(t) \quad (1)$$

The waves are measure by three wave gauges positioned in front of the device allowing reflection analysis.

The data are handled by a Matlab routine that graphically plots instantaneous power and give average power, efficiency and rotational speed. The advantage in this case is of having an automatize system than can run for long time and can handle big number of data. All the events in the tests are recorded with 25 Hz frequency making the analysis more precise.

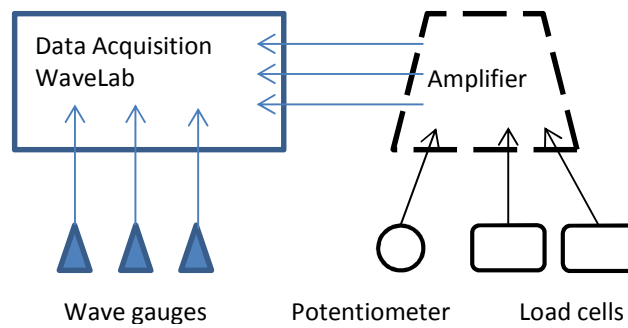

Figure 5. General scheme of the measuring system

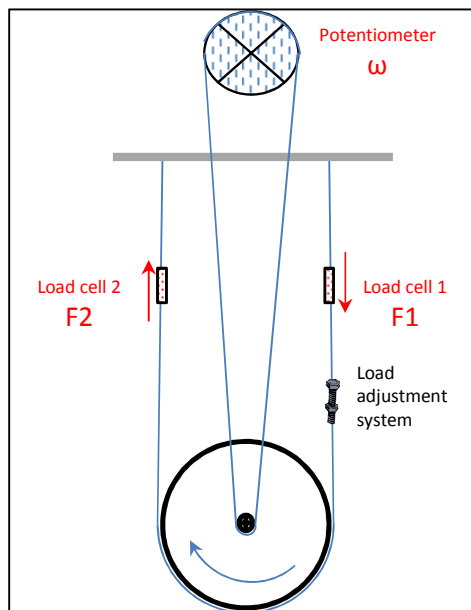

Figure 6. Detail of 1st measuring system on the cylinder.

Unfortunately the friction of the cylinder in the water resulted not to be a constant along the circumference (varying between 0.39 N to 2.75 N) and therefore the system was inadequate and, for regular waves, unnecessary. Indeed, tests in regular waves have a short duration and the measuring system has been replaced after few tests with the following mechanism.

- The second measuring system adopted for regular waves (Fig. 7) was simplified and featured a wire attached to the main body and a pulley. By changing the weights it was possible to vary the load on the model device. The time needed to lift the device from water level to the pulley was measure with a stopwatch three times and average time was used for power calculations with the equation:

$$P = \frac{mgh}{t} [W] \quad (2)$$

Where:

m is the mass of the weight [Kg];

g is the gravity acceleration;

h is the distance between the water level and the pulley [m];

t= measured time [s].

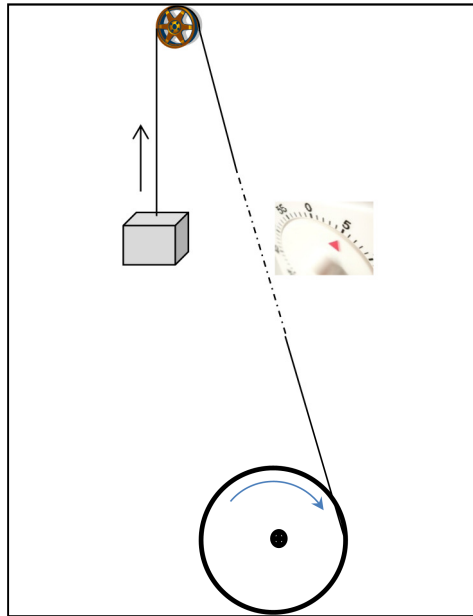

Figure 7. Detail of 2nd measuring system on the cylinder.

1.3.2 Test program

The test program followed 4 different main steps (Fig. 8). In particular, the investigation aimed at the optimization of:

- Fin's thickness
- Number of fin's sets
- Fin's no. par set
- Buoyancy level

After each session, the optimized configuration was used in the following investigation. For each optimization step, the optimal load was found. Target waves are derived from the typical North Sea conditions (Table 1). Regular waves corresponding to irregular waves have been worked out assuring the same energy content (i.e. imposing spectral moment m_0 for regular and irregular waves to be the same;

this means imposing $H_{\text{regular}}^2/8=H_{\text{mo}}^2/16$, resulting in $H_{\text{regular}}=H_{\text{mo}}/2^{0.5}$). The target regular and irregular waves for the tests are indicated in Table 2.

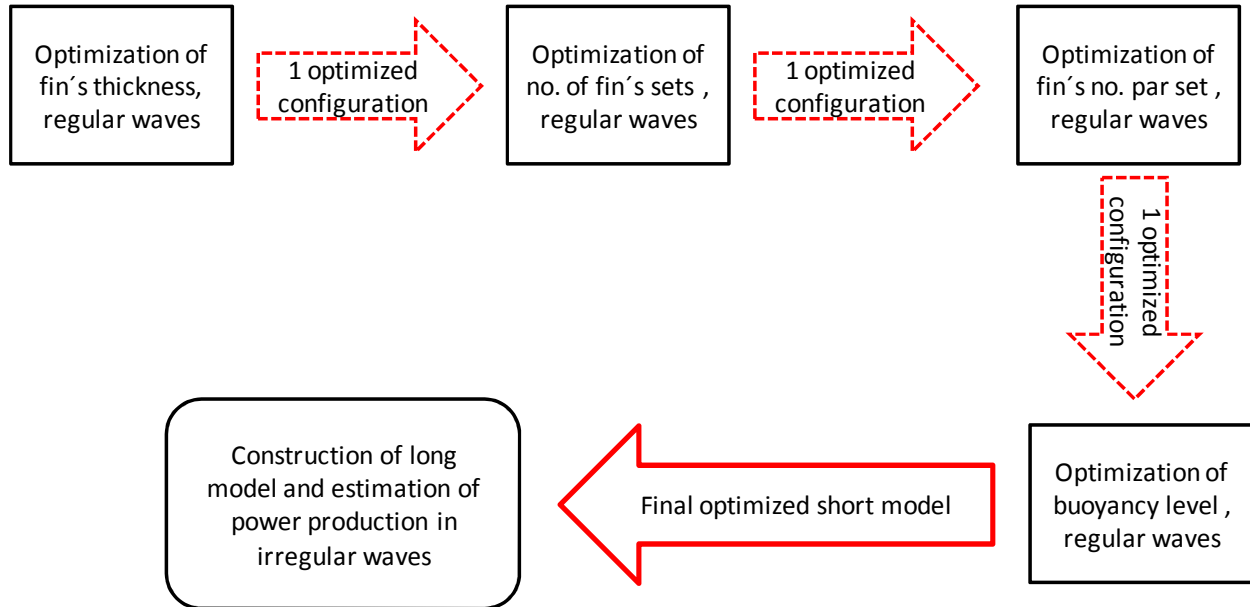

Figure 8. Steps in the optimization process.

Table 1. Full scale typical North Sea sea states.

(W)	Hs [m]	Tp [s]	Prob. Occur. [%]
1	1.0	5.6	46.8
2	2.0	7.0	22.6
3	3.0	8.4	10.8
4	4.0	9.8	5.1
5	5.0	11.2	2.3

Table 2. Target wave conditions.

wave state	Scale 1:25 irregular waves (W)		Scale 1:25 regular waves (RW)	
	Hs [m]	Tp [s]	H [m]	T [s]
1	0.04	1.12	0.028	1.12
2	0.08	1.4	0.057	1.4
3	0.12	1.68	0.085	1.68
4	0.16	1.96	0.113	1.96
5	0.2	2.24	0.141	2.24

A total of 230 tests have been done in regular waves (Table 3). Each test lasted few minutes for different model configurations and loads. In addition to the typical 5 wave conditions (RW1-5) in Table 2, also RWØ has been used as specific request of the developer in order to compare it with previous results obtained in the past when this wave conditions was used. Target RWØ features $H=0.16$ m and $T=1.4$ s. compared to the other RW this has the highest H and relative short period, quite advantageous if considering that the short model under exam is not properly scaled towards the wave length. Indeed, the length of the model is a limit for the typical wave conditions as the wave length is not related to the

total length of the device. Nevertheless the RW \emptyset is not a realistic wave and results from this wave condition not have any quantitative value.

During the tests, the longest time was spent on taking out the model from the basin and changing the fins configuration between one set of optimizations and the other; such an operation took up to 4 hours of 1 person work.

Prior to the tests, the static friction was measured and added up to the applied load and power calculations (average 1.57 N). Each test was run 3 times in order to minimize the error. Subsequently the average value was chosen.

The results are presented graphically in terms of efficiency, angular velocity and torque.

Table 3. Performed tests.

	Main variable	Wave conditions	Number of tests with varying loads
Optimization of fin thickness	0.4 mm		9
	0.75 mm	RW2, RW3, RW4, RW5, RW \emptyset	29
	1 mm		22
Optimization of no. of fin's sets	3		26
	4	RW2, RW3, RW4, RW5, RW \emptyset	29
	7		32
Optimization of fin's no. par set	6		32
	3	RW2, RW3, RW4, RW5, RW \emptyset	13
	3 alternate		18
Optimization of buoyancy level	B*= 27 cm		4
	B*= 22 cm		4
	B*= 14 cm	RW5	8
	B*= 6 cm		4

*B = submerged reference length, see Chapter 2.4.

2 Results and Analysis – (Regular Waves)

In the following chapters the results from the regular wave (RW) tests will be presented. Following the order introduced in the previous chapter, the efficiency of each investigated configuration will be graphically presented against the torque. Indications on the rotational speed will also be reported. (Main results are reported in Table 6 in A Appendix).

The efficiency is calculated as:

$$Efficiency = \frac{P}{P_{waves}D} [\%] \quad (3)$$

Where:

P is the calculated power defined in Eq. (2);

D = 0.44 m, is the diameter of the cylinder (= 0.12 m) plus the outside diameter given by the blades (= 0.32 m);

P_{wave} is the wave energy flux per unit wave crest length, calculated as:

$$P_{wave} = \frac{\rho g^2 H^2 T}{\beta \pi} [\text{W/m}] \quad (4)$$

Where:

ρ = water density = 1000 [kg/m³];

g = gravity acceleration = 9.82 [m/s²];

H is the measured wave height provided by WaveLab (average wave height H_m) [m];

T is the measured period provided by WaveLab (average wave period T_m) [s];

β = coefficient = 32 for regular waves.

The torque (or momentum) is calculated as:

$$M = mg \wedge R [\text{Nm}] \quad (5)$$

Being R= 0.06 m = cylinder radius.

The rotational speed is calculated as:

$$w = \frac{l}{Rt} [\text{rad/s}] \quad (6)$$

Where:

l= distance between the water level and the pulley = 3.1 m

and t= measured time [s] needed for the weight to be lifted from water level to pulley level by the rotation of the cylinder under the action of specific wave condition RW.

Results are in scale 1:25 to the North Sea. It must be noticed that the length of the short model under exam is not related to the wave length in the realized waves, appearing to be too short. It is therefore expected that the efficiency will be lower than in the case where the device length is more or less equal to the wave length.

2.1 Optimization of fin's thickness

Three different fin thicknesses have been tested with 4 sets of fins, 6 fins each set and draft = 0.36 m: 1mm, 0.75 mm and 0.4 mm (Fig 9). The issue is not directly related to the thickness but to the flexibility of the parts and the Young's modulus E of the material (see B Appendix for more information on used material). This must be taken into account when scaling up the fins. Indeed, it will be shown that the device performs better when a certain degree of flexibility is allowed in the fins.



Figure 9. The three thicknesses tested. From the left: 1mm, 0.75 mm and 0.4 mm thickness.

The problematic would be better described in a fluid dynamics contest. As for the wings of a plane, it is important to achieve a lift induced drag; nevertheless in our case we are not in presence of a unidirectional flow, but instead wave generated flow velocities are multi-directional (Fig. 10). The flexibility of the fins allows taking better advantage of the flow velocities, but the balance must be reached among the different components.

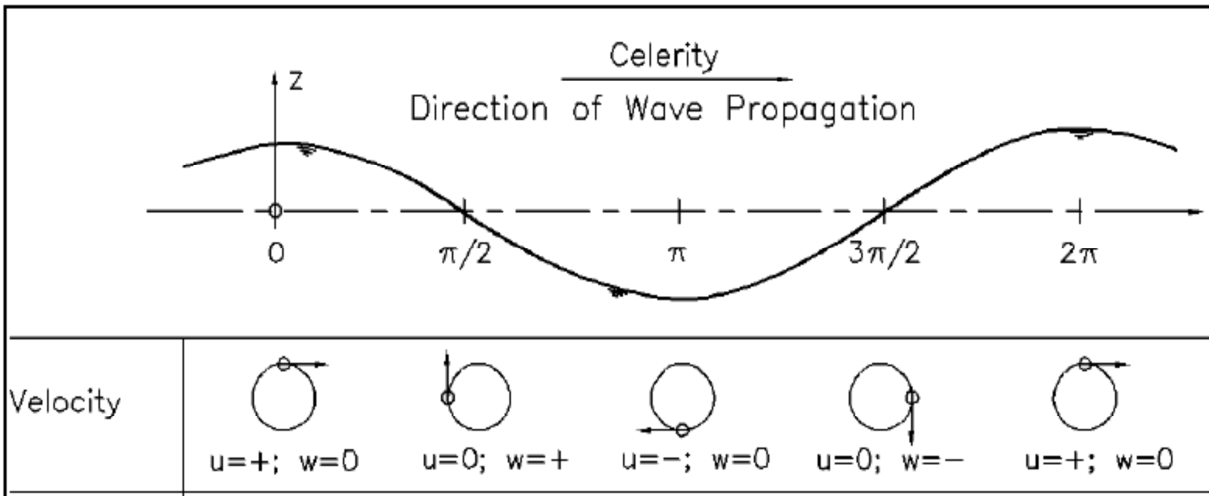

Figure 10. Notes on linear wave theory, u =wave velocities, w =wave accelerations (particles moving in orbital motion).

The results are presented in terms of efficiency (calculated used Eq. 3), torque (Eq. 5) and rotational speed (Eq. 6, only for the best case, i.e. fin thickness = 0.75 mm.). Results are in scale 1:25 to the North Sea. The device was rotating for all fin's thicknesses for RW4, RW5 and RWØ while it was never rotating for RW1 and RW2 and was rotating with RW3 only with fin's thickness =0.75 mm, indicating that this is indeed the best of the tested solutions. This is always evident for all the tested wave conditions (Fig. 11-13). Indeed, for fin's thickness = 1mm and = 0.4 mm, the peak efficiency is around half the obtained on in the other case. With 0.4 mm the fin's movement perpendicularly to the wave forces was allowed a lot of flattening and they were not providing adequate response. The problem with 1 mm thickness was instead the opposite: the fins were too rigid and they weren't unable to generate the adequate angle that would allow the lift induced drag on the rear side. Thickness 0.75 mm resulted to provide enough rigidity to have a direct drag and enough flexibility to allow an angle that would maximize the induced lift.

Under $H=0.11$ m and $T=2$ s the maximum efficiency is 6.9% and occurs for torque values of 0.47 [Nm] and fin's thickness=0.75 mm. Under $H=0.13$ m and $T=2.2$ s maximum efficiency is 6.2% and occurs for torque values of 0.53 [Nm]. Under $H=0.16$ m, $T=1.4$ s the maximum efficiency is 9.5% corresponding for a torque of 0.71 [Nm].

The angular velocity w is decreasing when increasing the torque, as expected. Raging values for the best case range between 0.8 – 4.0 rad/s.

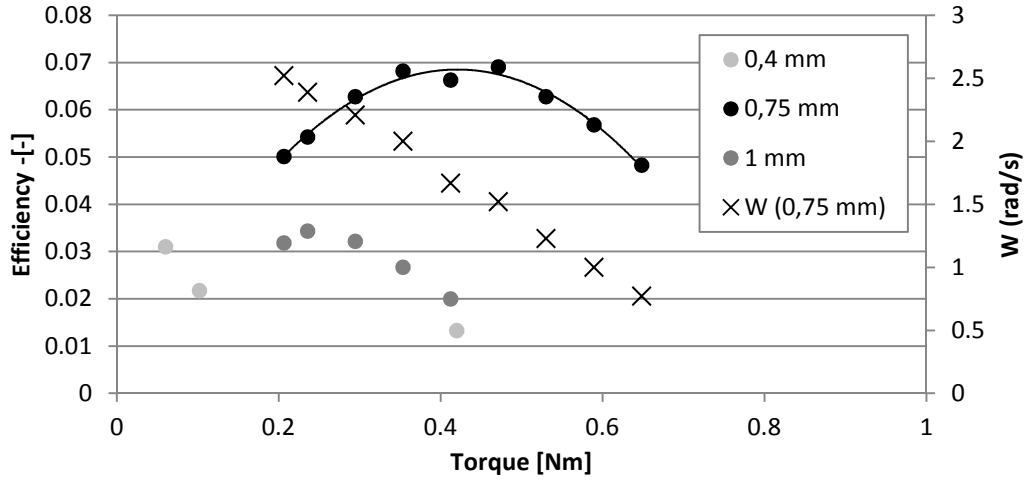

Figure 11. Efficiency depending on fin's thickness for different torque values under target wave condition 4 (RW4). 4 sets of fins, 6 fins per set, draft=0.36 m. Measured H=0.11 m, T=2 s.

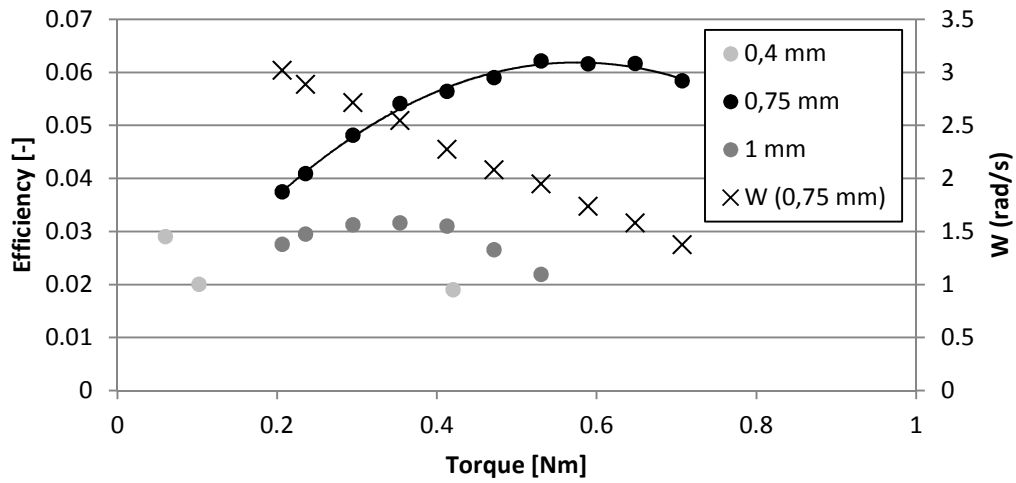

Figure 12. Efficiency depending on fin's thickness for different torque values under target wave condition 5 (RW5). 4 sets of fins, 6 fins per set, draft=0.36 m. Measured H=0.13 m, T=2.2 s.

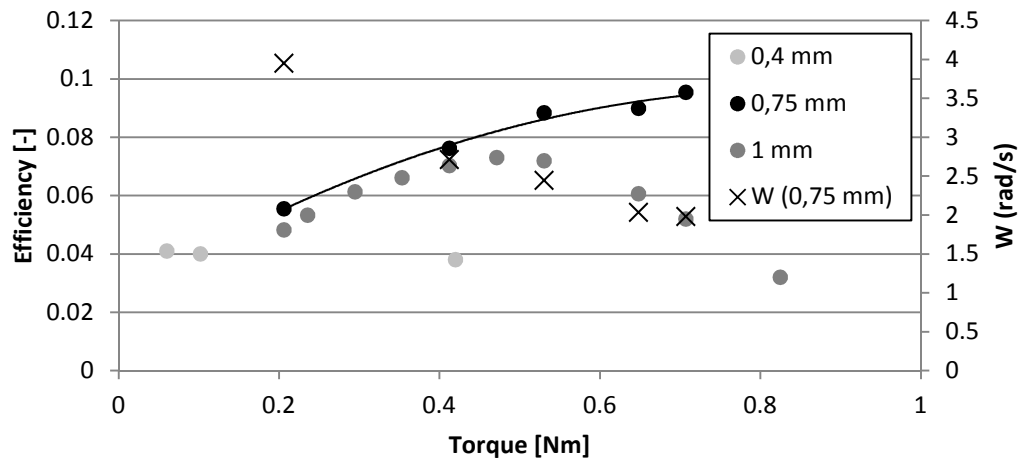

Figure 13. Efficiency depending on fin's thickness for different torque values under target wave condition \emptyset (RW \emptyset). 4 sets of fins, 6 fins per set, draft=0.36 m. Average measured H=0.16 m, T=1.4 s.

When comparing the results obtained for the different wave conditions for the best fin's thickness (Fig. 14), it can be noticed that the maximum torque increases when increasing the wave height, while the maximum efficiency decreases when increasing the wave height, with exception to the RWØ that anyways has completely different characteristic and therefore cannot be directly compared to the other results. The maximum efficiency for $H=0.08$ m and $T=1.7$ s is 7.2% with corresponding torque = 0.30 [Nm]. It must be noticed that the tests with the best efficiencies are the ones with the shortest periods (i. e. RW3 and RWØ).

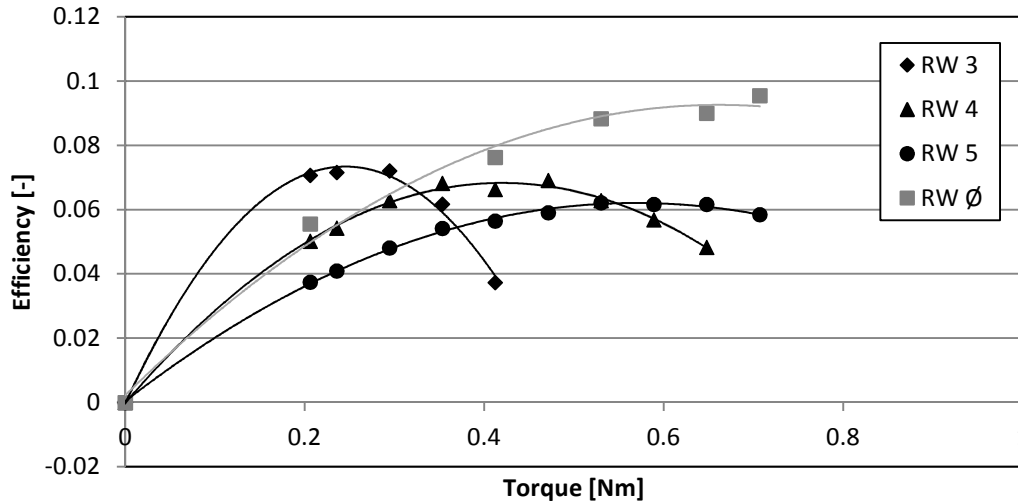

Figure 14. Best results. Comparison of results for different wave conditions, fin's thickness = 0.75 mm, 4 sets of fins, 6 fins per set.

2.1.1 Conclusions –best fin thickness

The best fin thickness resulted to be 0.75 mm. It is recommended that the same elasticity i.e. the same behavior is researched in full scale materials.

2.2 Optimization of number of fin's sets

Three different fin's sets configurations have been tested with the optimal thickness of 0.75 mm and 6 fins each set and draft $d=0.36$ m: 7 sets, with relative distances between two consecutive sets of 0.20 m, 4 sets (Fig. 15), with relative distances of 0.40 m and 3 sets, with relative distances of 0.60 m.



Figure 15. Investigation of number of fin's sets; seven (left) and four (right) with 0.75 mm thickness.

The results are presented in terms of efficiency (calculated used Eq. 3), torque (Eq. 5) and rotational speed (Eq. 6, only for the best case). Results are in scale 1:25 to the North Sea.

The device was rotating for all fin's sets for RW3, RW4, RW5 and RW \emptyset . The device was never rotating for RW2 and RW1.

The higher efficiency is obtained with 7 set of fins, even if the results are often not significantly different than the one coming from the configuration with 4 set of fins (Fig. 16-19). Under $H=0.08$ m, $T=1.7$, the maximum efficiency is 8.7% and occurs for torque values of 0.32 [Nm] for 7 sets of fins, while for 4 sets of fins, the maximum efficiency is 7.2% with a torque of 0.3 [Nm]. The results with 3 sets of fins are always considerably smaller with peak efficiencies 1.5-1.9 times smaller than the configuration with 7 or 4 sets of fins. Under $H=0.11$ m, $T=2$ s, the maximum efficiency is 7.3% and occurs for torque values of 0.50 [Nm] for 7 sets of fins, while for 4 sets of fins, the maximum efficiency is 6.9% with a torque of 0.47[Nm]. Under $H=0.12$ m, $T=2.2$ s, the maximum efficiency is 6.3% and occurs for torque values of 0.61 [Nm] for 7 sets of fins, while for 4 sets of fins and $H=0.13$ m and same period, the maximum efficiency is 6.2% with a torque of 0.53[Nm]. It must be said, in this last case, that the recorded wave height for 7 set of fins was 1 cm lower than the one recorded with 4 set of fins and this may partially explain the irrelevant difference in the efficiency curves.

Under $H=0.13$ m, $T=1.4$ s, the maximum efficiency is 15.8% and occurs for torque values of 0.97 [Nm] for 7 sets of fins, while for 4 sets of fins and $H=0.16$ m and same period, the maximum efficiency is 9.5% with a torque of 0.71[Nm]. It must be said, that also in this last case, the recorded wave height for 7 set of fins was lower than the one recorded with 4 set of fins. Nevertheless the result is here clear, being this one the only case when 7 set of fins are clearly superior that 4 set of fins. As we have already said, this wave condition (RW \emptyset) is never representative of the real sea conditions but it highlights again the importance of dimensioning correctly the length of the device. It is for this reason possible to conclude that with a model of the length comparable to the wave length of the incoming waves, the efficiency would be higher than the one resulted in RW2-RW5 until now.

The angular velocity ω is decreasing when increasing the torque, as expected. Raging values for the best case range between 0.6 to 3.0 rad/s.

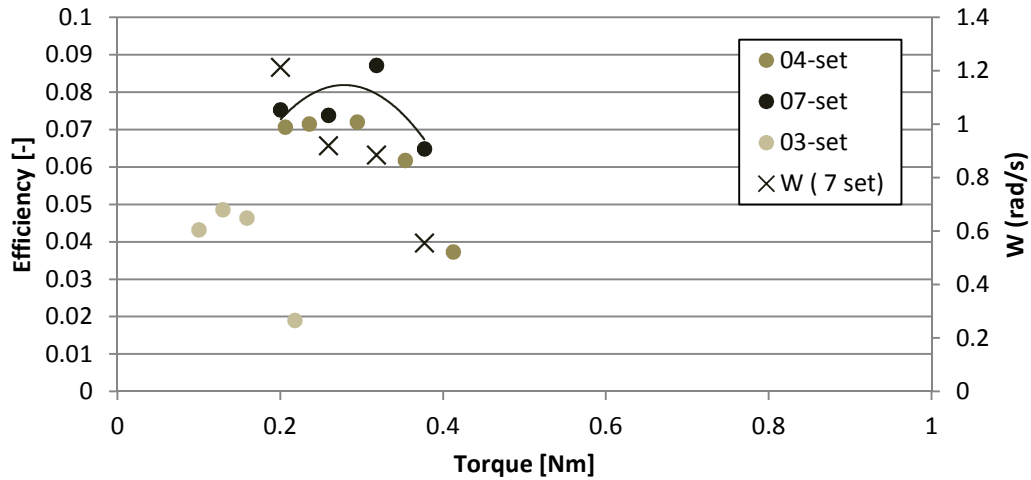

Figure 16. Efficiency for different number of fin's sets depending on torque values under wave condition 3 (RW3). 0.75mm, 6 fins par set, draft=0.36m. Average measured H=0.08 m, T=1.7 s.

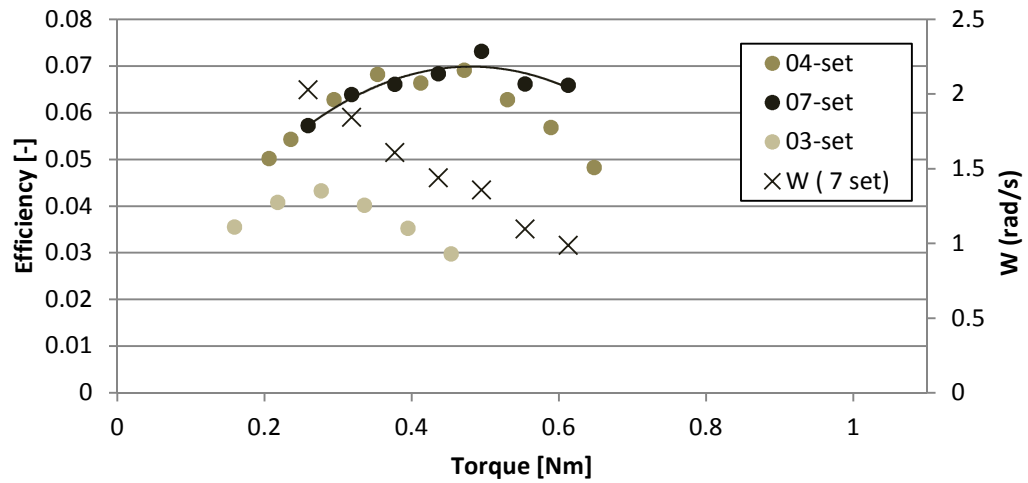

Figure 17. Efficiency for different number of fin's sets depending on torque values under wave condition 4 (RW4). 0.75mm, 6 fins par set, draft=0.36m. Average measured H=0.11 m, T=2 s.

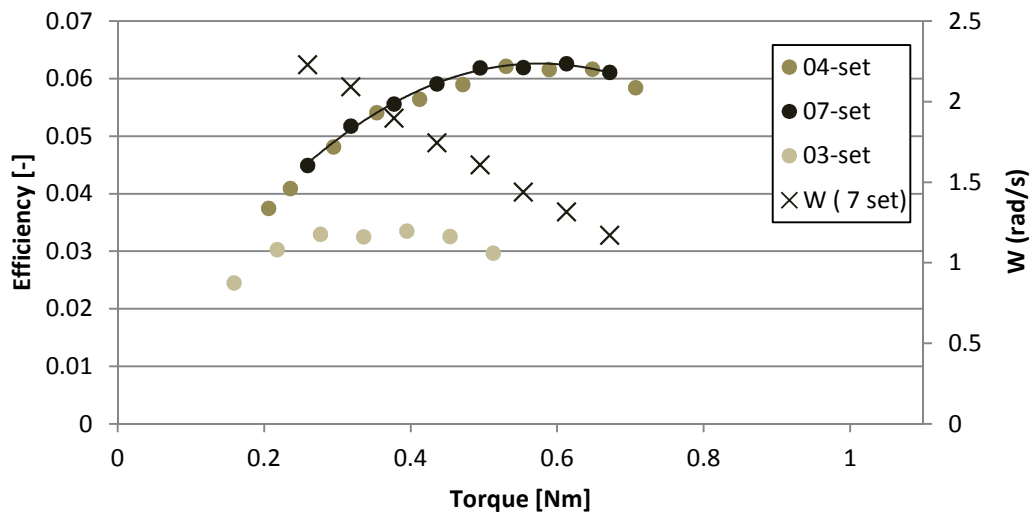

Figure 18. Efficiency for different number of fin's sets depending on torque values under wave condition 5 (RW5). 0.75mm, 6 fins par set, draft=0.36m. Average measured H=0.13 m, T=2.2 s.

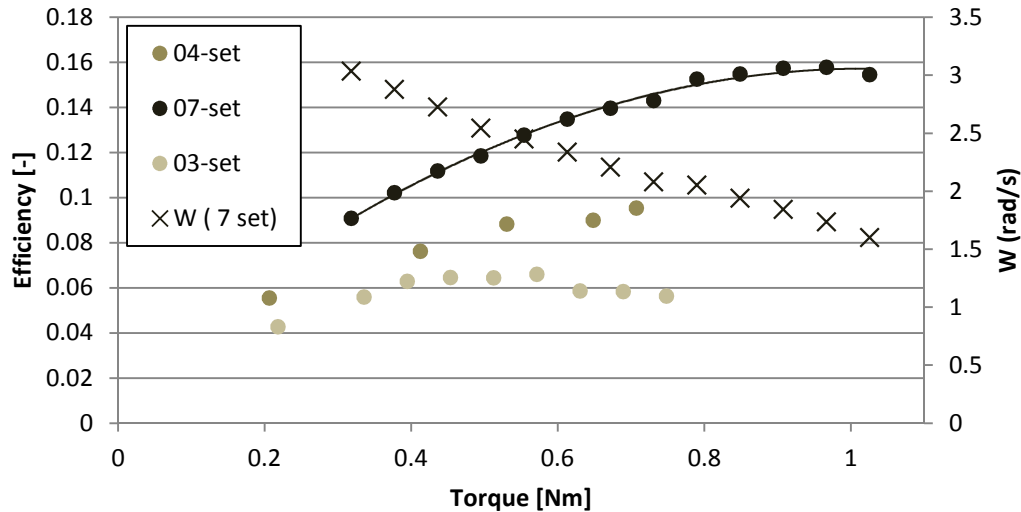

Figure 19. Efficiency for different number of fin's sets depending on torque values under wave condition Ø (RWØ). 0.75mm, 6 fins par set, draft=0.36m. Average measured H=0.15 m, T=1.4 s.

When comparing results for 7 sets of fins in different wave conditions (Fig. 20), we can see that the peak efficiency decreases when increasing the wave height while the maximum torque increases. This is valid when referring to the typical wave conditions (RW3-5), while wave condition RWØ should be considered separately as the wave periods is shorter and therefore more convenient for the short model device tested in this section.

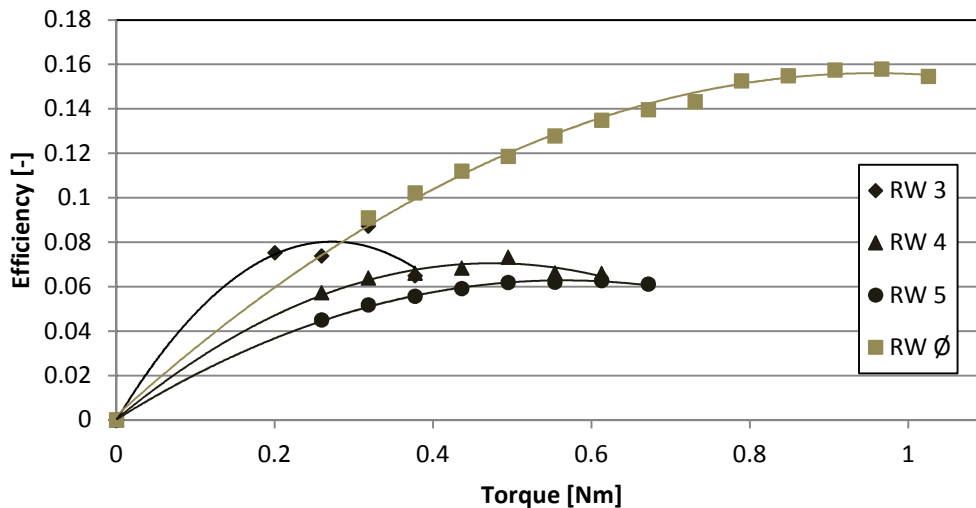

Figure 20. Best results. Comparison of results for different wave conditions, 7 sets of fins, 6 fins par set, 0.75 mm thickness.

When analyzing the peak efficiencies par wave condition depending on the number of fin's sets mounted on the model (Fig. 21) it is possible to notice that the best advantages occur when passing from 3 to 4 sets, while only little is gained when passing from 4 to 7 sets, for typical wave conditions (RW3-5). A gain of 3.9, 3.0, 2.9 and 9.2 points percentage is obtained when passing from 3 to 4 sets for wave conditions RW3, 4, 5 and Ø respectively while only a gain of 2.3, 2.6, 2.9 and 2.9 points percentage is reached when passing from 4 to 7 sets for RW3, 4, 5 and Ø respectively. It can be noticed that RWØ features a completely different trend. This is always due to the peculiarity of the wave condition, tailored to perform optimally on the short device.

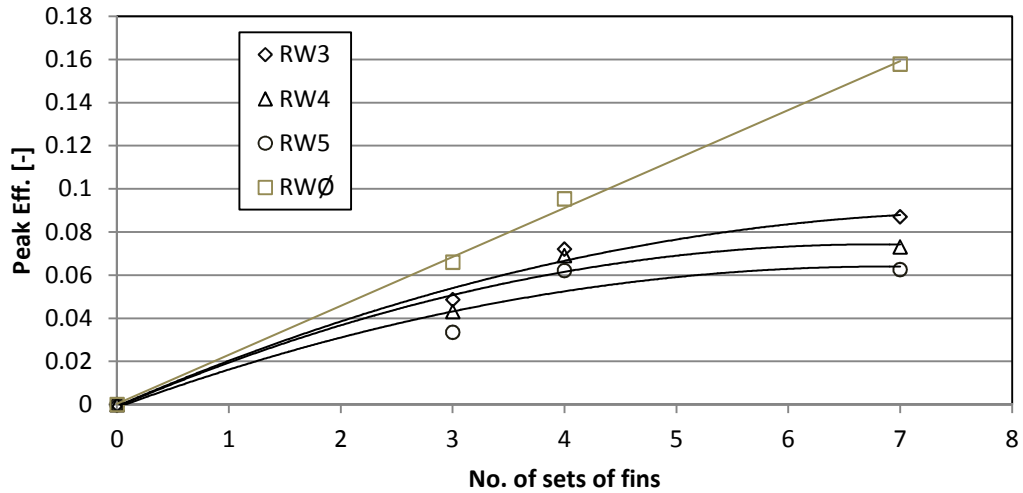

Figure 21. Peak Efficiencies divided by wave condition, depending on the number of fin's sets installed.

2.2.1 Length of the model and shadowing effect

In the present sub-chapter the relation between the device length and the wave length will be briefly investigated. The development of the topic will touch also the shadowing effect derived from using 7 set of fins.

The tests carried out in regular waves, as we said, utilize a short model of the rolling cylinder i.e a section of the entire model. This is because what is of interest at this stage is the optimization of parameters and therefore the relative comparison among configuration and not the quantitative results. Nevertheless it must be pointed out that it is obvious that the model, as expected, it is too short for the tested waves and therefore results are lower than if the device length was somehow in the range of the wave length.

The wave length is here calculated with the intermediate waters assumption as:

$$L = \frac{gT^2}{2\pi} \tanh\left(\frac{2\pi h}{L}\right) \text{ [m]} \quad (7)$$

Where:

h is the water depth =0.65 m and all the other are already defined parameters. The length of the short model $l = 1.4$ m. The device is half the wave length when considering the outstanding wave RWØ and in average 1/3 of the wave length for the typical wave conditions RW3-RW5 used during the regular wave testing. We can see that in all configurations (Fig. 22) the efficiency increases when the ration l/L is increasing i.e. when the device length l increases. The maximum should be reached when the $l/L \sim 1$. Anyways in full scale that could require a device of few hundred meters. The device length should be chosen considering to optimize it around the most common wave conditions: the ones that give the higher power*probability (Table 1) that in our case are (R)W3 and (R)W4, with a wave length of 3.50 m and 4.26 m meters respectively, that corresponds to 87.5 m and 106.5 m in full scale. This also raises the issue of the materials: despite the results with 7 sets of fin being slightly better than the ones with 4 sets, it is questionable if the higher number of fins will be a valuable solution when the economics will enter the discussion. More fins means also more maintenance and more parts that may fail.

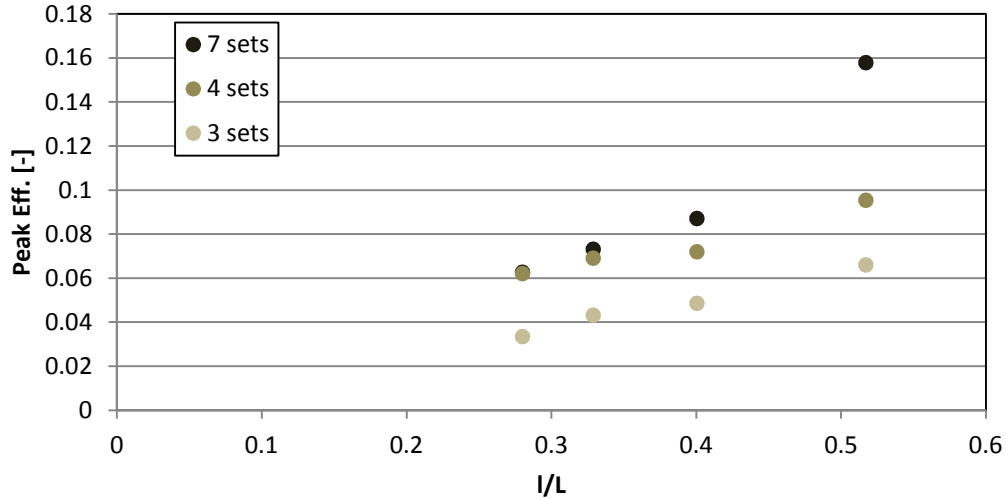

Figure 22. Peak efficiencies depending on the ratio between the device length $l=1.4$ m and the wave length, for 3, 4 and 7 fin's sets.

Results are also presented in Table 4, where one new parameter is introduced: if we define the ration between the space of two consecutive sets of fins x [m] ($=0.20$ m, 0.40 m and 0.60 m for 7, 4 and 3 sets respectively) and the wave length L [m] as:

$$\lambda = x/L \quad (8)$$

The λ parameter is introduced with the hope of describing the level of fin's stacking along the main body of the device in relation to the wave length. The smallest λ is the more fins the incoming wave will encounter.

Table 4. Wave lengths for the used wave conditions, scale 1:25.

reference wave condition	T [s]	L [m]	I/L	Λ 3 set	Λ 4 set	Λ 7 set
RW\emptyset	1.40	2.71	0.52	0.22	0.15	0.07
RW3	1.68	3.50	0.40	0.17	0.11	0.06
RW4	1.96	4.26	0.33	0.14	0.09	0.05
RW5	2.24	5.00	0.28	0.12	0.08	0.04

Through the λ parameter we can try to generalize the previous results. We can see (Fig. 23) that for $\lambda < 0.09$ there is little gain in efficiency passing from one configuration to another (i.e. passing from 4 to 7 sets) as the curves flatten down. As usual there is the exception of RW \emptyset , nevertheless the exceptional result (compared to the others obtained in the tests), that features the highest efficiency recorded may be an indication of how the device will perform when realized in full length i.e. with an efficiency around 3 times higher than the one reached with the short model for RW3-5.

As the RW \emptyset is not a realistic wave, the validity of results is merely qualitative.

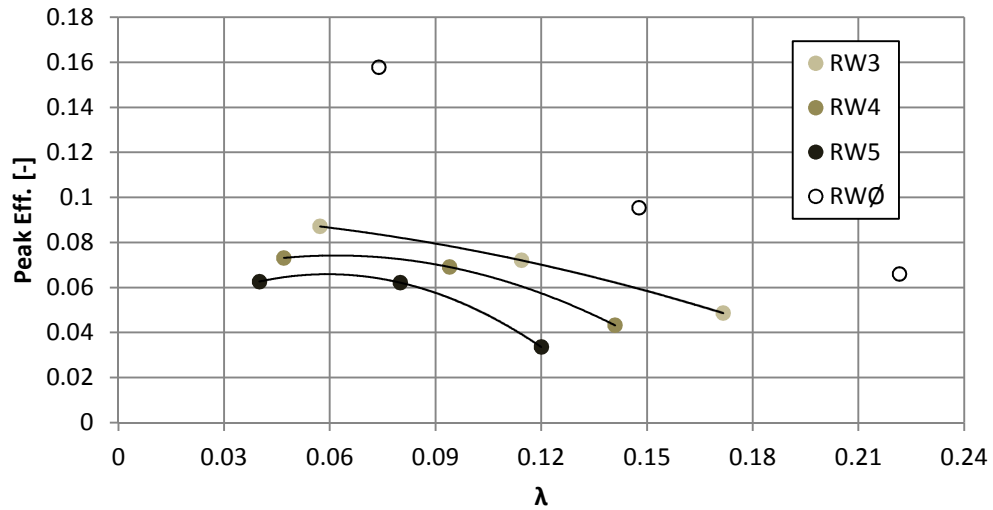

Figure 23. Dependency of the efficiency on the λ parameters that relates the distance between fin's sets to the model length, for different wave conditions.

2.2.2 Conclusions –best number of fin's sets

The best number of sets resulted to be 7, with a relative distance between two consecutive sets of 0.20 m. Nevertheless results are only slightly better than the ones from 4 sets of fins and it is reasonable to take economics into account when making the final decision (cost of materials).

The optimal device length has been found to be between 87.5 and 106.5 m in full scale.

2.3 Optimization of fin's number par set

With the fin's thickness of 0.75 mm and 7 sets of fins and draft $d=0.36$ m, three different configurations featuring different number of fin's par set have been tested: 6 fins, 3 fins and 3 fins-alternate (Fig. 24). The configuration with 3 fins par set-alternate has been thought in order to mitigate a negative effect observed during the tests. Indeed it was noticed that the waves running over the device's body would not find enough surface to act on when the gap between two blades was occurring and that would slow down the device rotation.

The results are presented in terms of efficiency (calculated used Eq. 3), torque (Eq. 5) and rotational speed (Eq. 6, only for the best case). Results are in scale 1:25 to the North Sea.

The device was rotating under WR3 only for 6 fin's par set. The higher efficiency corresponds always to the configuration with 6 fins par set. The results with three fin's par set are considerably lower.

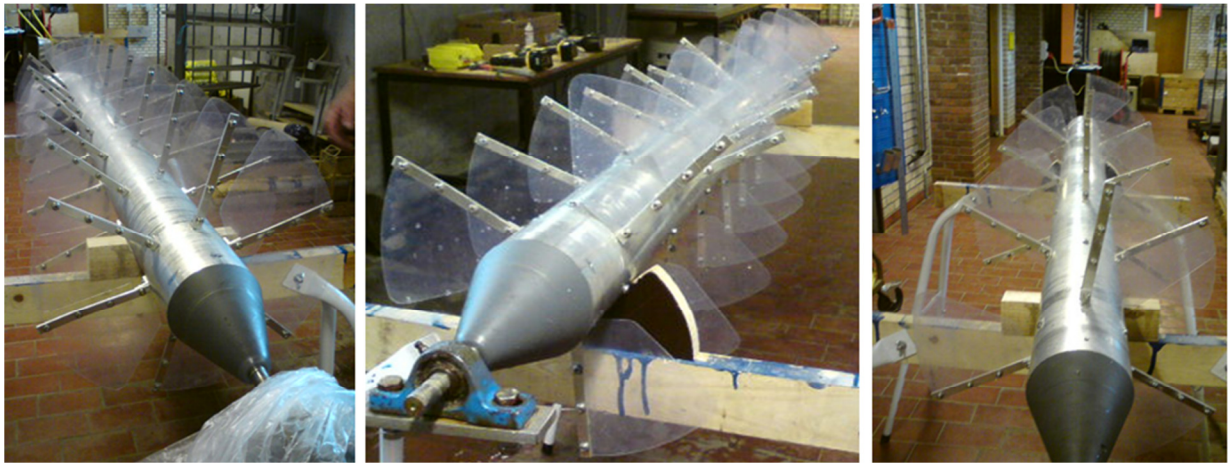

Figure 24. From the left to the right, short model equipped with 7 sets of fins, 6 fin's par set (lf), 3 fin's part set (c), 3 fin's par set-alternate (rg). Fin's thickness=0.75 mm.

Under average $H=0.11$ m, $T=2$ s the higher efficiency is 7.3% and occurs for torque values of 0.50 [Nm] for 6 fins par set. Under average $H=0.13$ m, $T=2.2$ s, the maximum efficiency is 6.3% and occurs for torque values of 0.61 [Nm]. Under average $H=0.14$ m, $T=1.4$ s, the maximum efficiency is 15.8% and occurs for torque values of 0.97 [Nm].

It is interesting to notice that the configuration featuring 3 fins par set-alternate, performs slightly better than the configuration with 3 fins par set (normal). This is probably due to the fact that in this case the waves find always a surface to act on in every along the model length at each fin's set. This was not happening with the traditional 3 fins par set configuration that would instead allow the formation of a gap between two fins where the waves would not be able to act and therefore produce rotation.

Nevertheless the results with three fins par set are among the lowest of all the tests and therefore do not represent an option. In case of economic considerations it seems more reasonable to consider a reduction in number of fin's sets that in number of fins par set.

The angular velocity w is decreasing when increasing the torque, as expected. Raging values for the best case range between 1 to 3.0 rad/s.

The best configuration corresponds to the best configuration of the previous chapter, see Fig. 20.

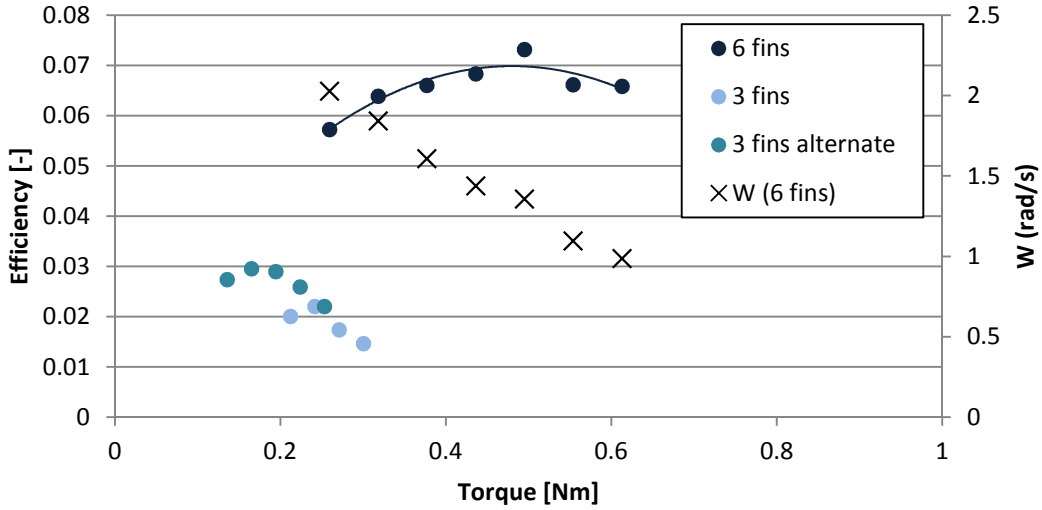

Figure 25. Efficiency for different no. of fins per set depending on torque values under wave condition 4 (RW4). 7 sets of fins, 0.75 mm thickness, 0.36 m draft. Average measured $H=0.11$ m, $T=2$ s.

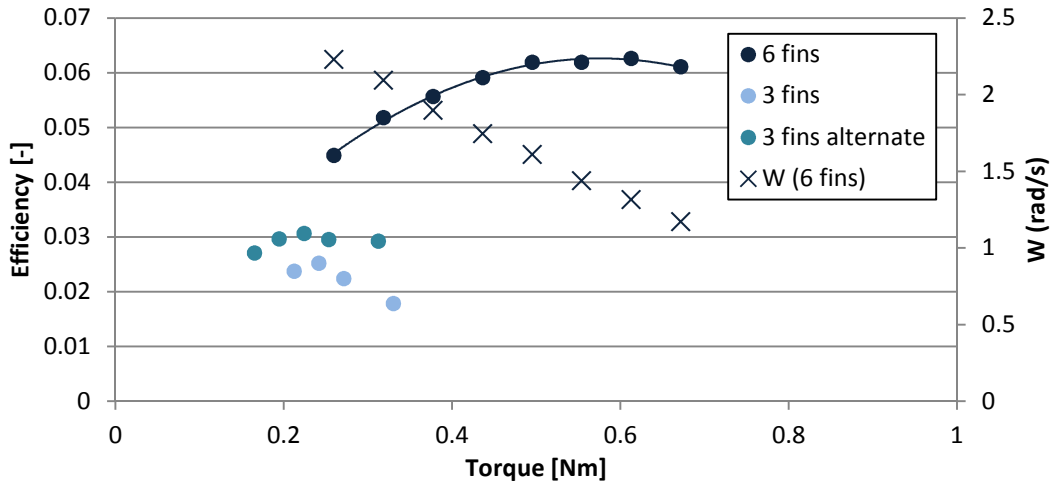

Figure 26. Efficiency for different no. of fins per set depending on torque values under wave condition 5 (RW5). 7 sets of fins, 0.75 mm thickness, 0.36 m draft. Average measured $H=0.13$ m, $T=2.2$ s.

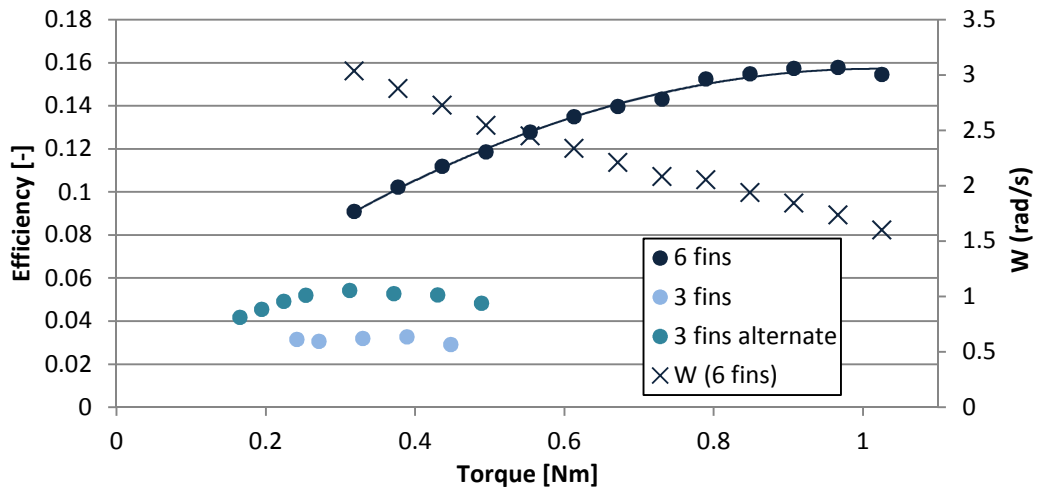

Figure 27. Efficiency for different no. of fins per set depending on torque values under wave condition \emptyset (RW \emptyset). 7 sets of fins, 0.75 mm thickness, 0.36 m draft. Average measured $H=0.14$ m, $T=1.4$ s.

2.3.1 Conclusions –best number of fins par set

The best number of fins par set resulted to be 6.

It is valuable to notice that even if considerably lower than the optimal case, the efficiency of the case of 3 fins par set-alternate performed slightly better than the case of 3 fins par set (normal). This is due to a smarter alignment of the fins along the device.

2.4 Optimization of the buoyancy level

Four different buoyancy levels have been tested (Fig. 28) under RW5 for the best configuration (7 sets of fins, 6 fins each set, 0.75 mm thickness) and three for the configuration with 4 sets of fins, 6 fins each set with 1,0 mm thickness. Due to the orbital motion of the water particles under wave action, the higher forces and the best results in terms of efficiency are close to the surface. Nevertheless, it is important to consider a different buoyancy level when making considerations on the storm protection mode that could foreseen the sinking of the device deeper under the surface level where forces are lower in order to protect the structure from damage.

The results are presented in terms of efficiency (calculated used Eq. 3), torque (Eq. 5) and rotational speed (Eq. 6, only for the best case). Results are in scale 1:25 to the North Sea.

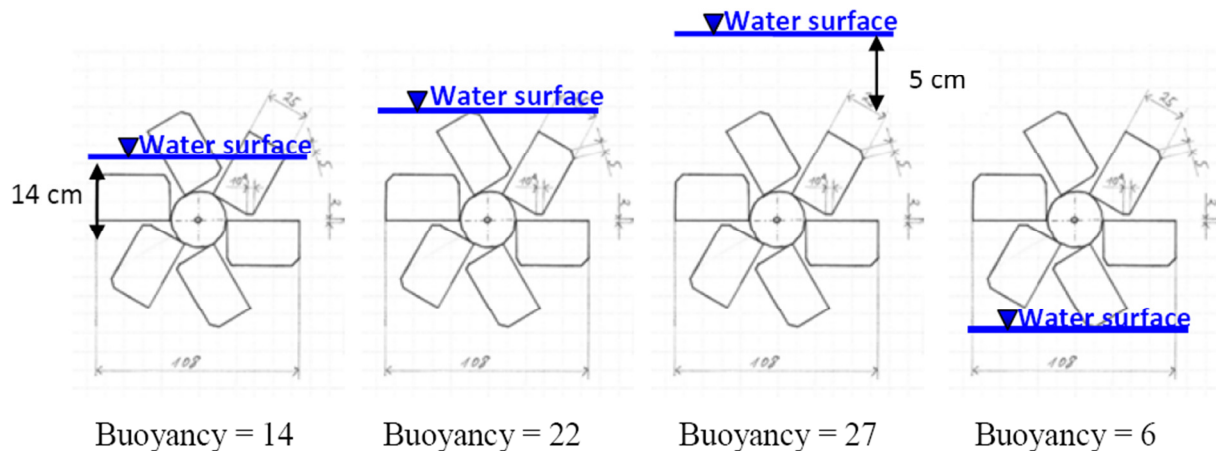

Figure 28. Definition sketch for tested buoyancy levels.

The best results are always the ones featuring buoyancy level 14. This configuration has most of the device under the water with only half part of the fins coming out from water level. The worst configuration is always the buoyancy level 27.

In general, the deeper he device is installed, the higher is the loss.

Comparing the peak torques for the case with 7 sets of fins (Fig 29), buoyancy level 22 (the entire device just below water level) shows a loss of 11.2% (0.7 points percentage) with reference to the best buoyancy level 14 and 40.2% and 45.7% (corresponding to 2.9 and 2.5 points percentage) for buoyancy levels 6 and 27 respectively.

Despite buoyancy level 27 and 7 being so different, they show very similar losses. The first one features an installation 0.05 m below mean water level (=1.25 m in full scale). Nevertheless the loss is consistent if we think that applied wave height $H=0.14$ m (3.5 m in full scale). In this situation parts of the device still emerge out of the water when a wave is passing over it (through of the waves) potentially exposing the parts to damage. The buoyancy level 6 has slightly better results than the buoyancy level 27 and it is quite interesting.

Comparing the peak torques for the case with 4 sets of fins (Fig 30), buoyancy level 22 (the entire device just below water level) shows a loss of 15.0% (0.5 points percentage) with reference to the best buoyancy level 14 and 31.5% (corresponding to 1.0 point percentage) for buoyancy level 27.

If the re-define the draft of the device as the distance between the mean water level and the lowest submerged part, we obtain that:

- Buoyancy level 14= draft of 0.36 m
- Buoyancy level 22=draft of 0.44 m
- Buoyancy level 27= draft of 0.49 m

- Buoyancy level 6= draft of 0 m.

We can then plot the loss in efficiency compared to the best case (draft=0.36m,) depending on the draft of the device (Fig 31). It can be noticed a very steep increase in the loss of efficiency when increasing the draft. This can be related easily to the decrease in wave forces along the water column. It must be noticed that the loss is accentuated for smaller wave conditions. It is therefore implied that for RW1-4 the loss in efficiency is expected to be higher than in the presented case (RW5).

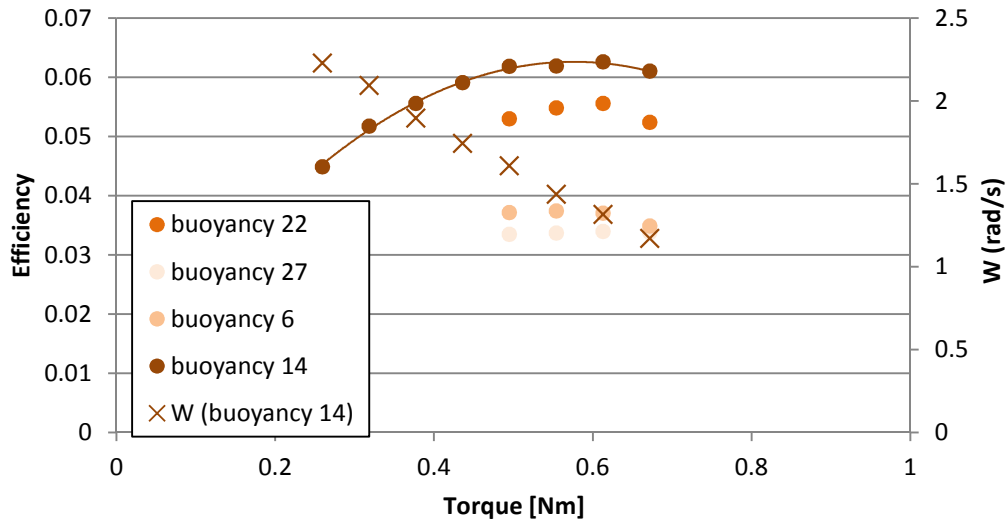

Figure 29. Efficiency depending on the torque for different buoyancy levels, 7 sets of fins, 6 fins per set with 0.75 mm thickness.

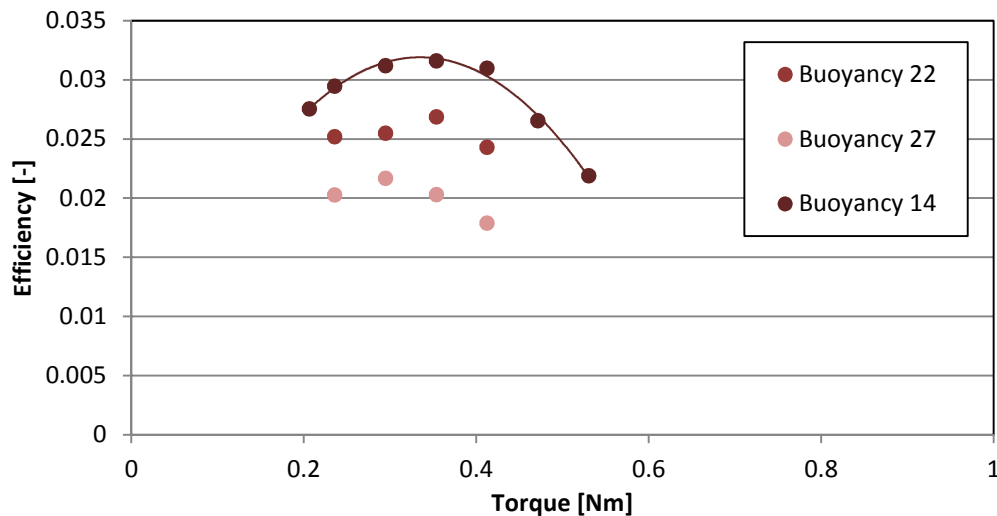

Figure 30. Efficiency depending on the torque for different buoyancy levels, 4 sets of fins, 6 fins per set with 1 mm thickness.

The reasons to install the device at a lower position than optimal can be:

1. To adopt a storm protection strategy i.e. the device is at a lower position only during storms when a threshold wave height is exceeded.
2. To have a lower visual impact or to protect the device in everyday basis from potentially dangerous forces.

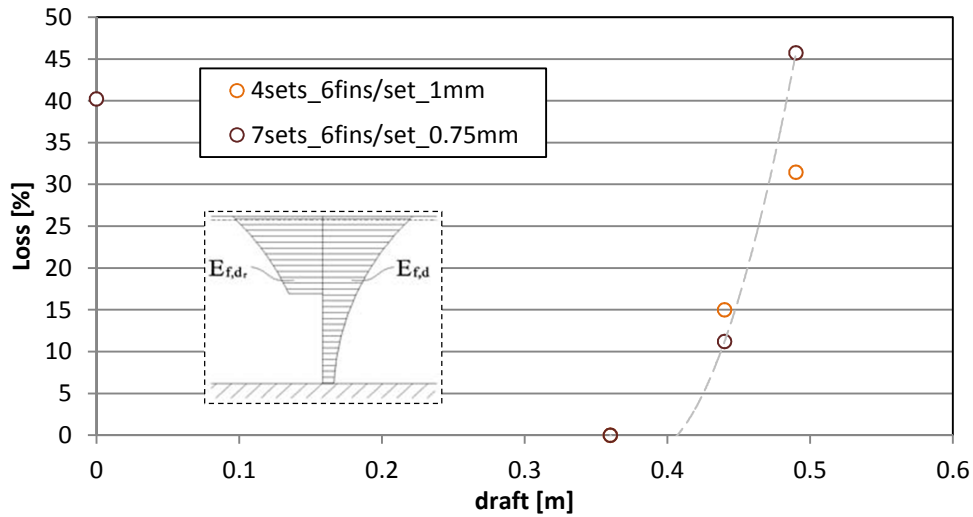

Figure 31. Loss in efficiency depending on the draft for the two tested configurations, for RW5. In the small square, the qualitative behavior of the wave energy flux in the water column.

2.4.1 Conclusions –best draft/buoyancy level

The best draft resulted to be $d=0.36$ m.

When increasing the draft, the efficiency decreases with a trend similar to exponential and it is expected that the loss is more accentuated for smaller wave heights.

It is interesting to notice that the efficiency of the case when the device is all out of the water (with reference to mean sea level) shows the same performance than the case where the device has a draft of 0.49m, under wave condition RW5.

3 First estimate of power production

The estimation of the power production can only be done under irregular waves. Nevertheless it is possible to have a first estimate based on the results obtained so far. This estimate has a low accuracy (around $\pm 25\%$) and must be validated by tests in irregular waves.

The yearly average wave power, the yearly average power production, the overall efficiency and the yearly energy power production, have been calculated in full scale. For the total length of the device $l=105$ m (three times the short model) has been chosen.

The peak efficiency of the corresponding regular wave condition has been chosen for each irregular wave condition in the North Sea (Danish Seas), and multiplied by three (Table 5). For $H_s=1$ m and $H_s=2$ m where we have no results because the device was not rotating, we chose an arbitrary efficiency.

The results are just the first guess; they must be validated with irregular wave tests and are valid only under the tested conditions.

Table 5. Summary of wave conditions and relative expected device performance in irregular waves.

Hs [m]	Tp [s]	Pwave [kW]	Prob. [-]	Pwave*Prob.	Device Eff.	P [kW]	P*Prob.
1	5.6	23.1	0.468	10.81	0.05	1.16	0.543
2	7	127.6	0.226	28.84	0.12	15.31	3.460
3	8.4	352	0.108	38.02	0.261	91.87	9.922
4	9.8	715	0.051	36.47	0.219	156.59	7.986
5	11.2	1254	0.024	30.10	0.186	233.24	5.598

The yearly average available wave power is then 144.24 kW and the yearly average produced power is estimated to be 27.51 kW for 105 m long fixed (not floating) device, with 21 sets of fins, 6 fins each set and with flexibility comparable to the 0.75 mm flexibility in scale 1:25 and draft = 9 m, resulting in a mechanic efficiency of 19% and an yearly energy production of 241 MWh/y (minus losses in power take off).

4 Conclusions

The optimized short model for the rolling cylinder resulted to have 7 sets of fins with relative distance between two consecutive sets = 0.20 m, 6 fins per set with a thickness of 0.75 mm and a draft $d = 0.36$ m that features half blade emerging from mean water level. In this case the maximum efficiencies were:

- 8.7% for RW3
- 7.3% for RW4
- 6.3% for RW5

These results under typical regular waves (RW3-5) were very close to the results with 4 sets of fins with relative distance between two consecutive sets = 0.40 m, 6 fins per set, 0.75 mm thickness and draft = 0.36 m:

- 7.2% for RW3
- 6.9% for RW4
- 6.2% for RW5

It must be noticed that the short model does not have the necessary length to perform optimally under the target wave conditions. The optimal device length has been calculated to be comparable to the wave length of the most energetic/probable wave conditions, i.e. RW3 and RW4. Under this consideration, the short model is only 1/3 of the total length of a complete device that should then be = 4.2 m (105 m in full scale).

A first rough estimation of the power production for the rolling cylinder has been conducted using the results from regular wave tests. It has been concluded that for a fixed device (not floating), 105 m long with 23 sets of fins, 6 fins per set, draft of 9 m, similar geometry and fin's elasticity than the model tested in the present report, as well as possibility of adjusting the load to the incoming wave condition (gearing), the yearly energy production of 241 MWh/y (minus the losses in the power take off system), corresponding to a mechanic efficiency of 19%. Result must be validated with irregular wave tests. It is foreseen that the irregular wave tests will be concluded before September 2011.

References

Jensen J. B. og Kofoed, J.P. 2001: " Bartholinis roterende bølgeenergiabsorber", Technical report Department of Civil Engineering, Aalborg University, Maj 2002.

Kofoed, J.P. and Frigaard, P.2009: Development of wave energy devices: the Danish case. *The Journal of Ocean Technology*, vol. 4 no. 4, Dec. 2009.

Appendix A

Table 6. Summary of results.

Torque [Nm]	Efficiency [-]	Torque [Nm]	Efficiency [-]	Torque [Nm]	Efficiency [-]	Torque [Nm]	Efficiency [-]
RW Ø		RW 5		RW4		RW3	
7 sets_3fins/set_0.75mm_d0.36							
Hm=0.155 m , Tm = 1.4 s		Hm=0.1366 m , Tm = 2.24 s		Hm=0.1149 m , Tm = 1.96 s			
0.2416	0.0315	0.2121	0.0237	0.2121	0.0200		
0.2710	0.0306	0.2416	0.0252	0.2416	0.0220		
0.3300	0.0318	0.2710	0.0224	0.2710	0.0174		
0.3889	0.0326	0.3300	0.0178	0.3005	0.0146		
0.4478	0.0290						
7 sets_3fins/setaletrnate_0.75mm_d0.36							
Hm=0.1348 m , Tm = 1.4 s		Hm=0.12 m , Tm = 2.24 s		Hm=0.1043 m , Tm = 1.96 s			
0.1650	0.0417	0.1650	0.0271	0.1355	0.0274		
0.1944	0.0455	0.1944	0.0296	0.1650	0.0295		
0.2239	0.0492	0.2239	0.0306	0.1944	0.0290		
0.2534	0.0520	0.2534	0.0295	0.2534	0.0220		
0.3123	0.0542	0.3123	0.0292	0.2239	0.0259		
0.3712	0.0527						
0.4301	0.0522						
0.4890	0.0483						
4sets_6fins/set_0.75mm_d0.36							
Hm=0.1576 m , Tm = 1.4 s		Hm=0.1337 m , Tm =2.20 s		Hm=0.1123 m , Tm = 1.95 s		Hm=0.07663 m , Tm = 1.68 s	
0.2062	0.0555	0.2062	0.0374	0.2062	0.0501	0.2062	0.0706
0.4124	0.0762	0.2357	0.0409	0.2357	0.0543	0.2357	0.0715
0.5303	0.0883	0.2946	0.0481	0.2946	0.0627	0.2946	0.0720
0.6481	0.0900	0.3535	0.0541	0.3535	0.0682	0.3535	0.0617
0.7070	0.0954	0.4124	0.0564	0.4124	0.0663	0.4124	0.0373
		0.4714	0.0590	0.4714	0.0691		
		0.5303	0.0621	0.5303	0.0628		
		0.5892	0.0616	0.5892	0.0568		
		0.6481	0.0616	0.6481	0.0482		
		0.7070	0.0584				
7sets_6fins/set_0.75mm_d0.36							
Hm=0.1341 m , Tm = 1.4 s		Hm=0.1167 m , Tm = 2.24 s		Hm=0.1054 m , Tm = 1.96s		Hm=0.06752 m , Tm = 1.68 s	
0.3182	0.0909	0.2592	0.0449	0.2592	0.0572	0.2003	0.0752
0.3771	0.1021	0.3182	0.0517	0.3182	0.0638	0.2592	0.0738
0.4360	0.1118	0.3771	0.0556	0.3771	0.0660	0.3182	0.0871
0.4949	0.1185	0.4360	0.0591	0.4360	0.0683	0.3771	0.0648
0.5538	0.1277	0.4949	0.0619	0.4949	0.0731		
0.6128	0.1348	0.5538	0.0619	0.5538	0.0661		
0.6717	0.1396	0.6128	0.0626	0.6128	0.0658		
0.7306	0.1431	0.6717	0.0611				

0.7895	0.1525						
0.8484	0.1548						
0.9074	0.1573						
0.9663	0.1578						
1.0252	0.1545						
3sets_6fins/set_0.75mm_d0.36							
Hm=0.1594 m , Tm = 1.4 s		Hm=0.1375 m , Tm = 2.24 s		Hm=0.1148 m , Tm = 1.96 s		Hm=0.07223 m , Tm = 1.68 s	
0.2180	0.0428	0.1591	0.0245	0.1591	0.0355	0.1002	0.0431
0.3358	0.0559	0.2180	0.0303	0.2180	0.0408	0.1296	0.0486
0.3948	0.0629	0.2769	0.0329	0.2769	0.0432	0.1591	0.0463
0.4537	0.0646	0.3358	0.0325	0.3358	0.0401	0.2180	0.0190
0.5126	0.0644	0.3948	0.0335	0.3948	0.0352		
0.5715	0.0659	0.4537	0.0325	0.4537	0.0297		
0.6304	0.0586	0.5126	0.0297				
0.6894	0.0584						
0.7483	0.0563						
4 sets_6fins/set_0.4mm_d0.36							
Hm=0.16 m , Tm = 1.4 s		Hm=0.13 m , Tm = 2.24 s		Hm=0.113 m , Tm = 1.96 s			
0.0600	0.0410	0.0600	0.0290	0.0600	0.0310		
0.1020	0.0400	0.1020	0.0200	0.1020	0.0217		
0.4200	0.0380	0.4200	0.0190	0.4200	0.0133		
4 sets_6fins/set_1mm_d0.36							
Hm=0.1482 m , Tm = 1.4 s		Hm=0.132 m , Tm = 2.24 s		Hm=0.1105 m , Tm = 1.96 s			
0.2062	0.0482	0.2062	0.0275	0.2062	0.0319		
0.2357	0.0533	0.2357	0.0295	0.2357	0.0343		
0.2946	0.0613	0.2946	0.0312	0.2946	0.0321		
0.3535	0.0661	0.3535	0.0316	0.3535	0.0266		
0.4124	0.0702	0.4124	0.0310	0.4124	0.0200		
0.4714	0.0730	0.4714	0.0265				
0.5303	0.0719	0.5303	0.0219				
0.6481	0.0606						
0.7070	0.0519						
0.8249	0.0320						
4sets_6fins/set_1mm_d0.44							
		Hm=0.137 m , Tm = 2.24s					
		0.2357	0.0252				
		0.2946	0.0255				
		0.3535	0.0269				
		0.4124	0.0243				
4sets_6fins/set_1mm_d0.49							
		Hm=0.140 m , Tm = 2.24s					
		0.2357	0.0203				

	0.2946	0.0217	
	0.3535	0.0203	
	0.4124	0.0179	
7sets_6fins/set_0.75mm_d0.44			
	Hm=0.1191 m , Tm = 2.24s		
	0.4949	0.0530	
	0.5538	0.0548	
	0.6128	0.0556	
	0.6717	0.0524	
7sets_6fins/set_0.75mm_d0.49			
	Hm=0.1407 m , Tm = 2.4s		
	0.4949	0.0335	
	0.5538	0.0337	
	0.6128	0.0340	
	0.6717	0.0338	
7sets_6fins/set_0.75mm_d0			
	Hm=0.1402 m , Tm = 2.4s		
	0.4949	0.0371	
	0.5538	0.0374	
	0.6128	0.0371	
	0.6717	0.0349	

Appendix B

*For PS the E-Module is 1900 and for Vekaplan KT (PVC), the E-module is 3200.

