



**Aalborg Universitet**

**AALBORG UNIVERSITY**  
DENMARK

## **Advanced Control Techniques for WEC Wave Dragon**

Tedd, James; Kofoed, Jens Peter; Jasinski, M.; Morris, A.; Friis-Madsen, E.; Wisniewski, Rafal; Bendtsen, Jan Dimon

*Published in:*

Proceedings of the 7th European Wave and Tidal Energy Conference

*Publication date:*  
2007

*Document Version*  
Publisher's PDF, also known as Version of record

[Link to publication from Aalborg University](#)

*Citation for published version (APA):*

Tedd, J., Kofoed, J. P., Jasinski, M., Morris, A., Friis-Madsen, E., Wisniewski, R., & Bendtsen, J. D. (2007). Advanced Control Techniques for WEC Wave Dragon. In *Proceedings of the 7th European Wave and Tidal Energy Conference: EWTEC 2007* European Ocean Energy Association.

### **General rights**

Copyright and moral rights for the publications made accessible in the public portal are retained by the authors and/or other copyright owners and it is a condition of accessing publications that users recognise and abide by the legal requirements associated with these rights.

- ? Users may download and print one copy of any publication from the public portal for the purpose of private study or research.
- ? You may not further distribute the material or use it for any profit-making activity or commercial gain
- ? You may freely distribute the URL identifying the publication in the public portal ?

### **Take down policy**

If you believe that this document breaches copyright please contact us at [vbn@aub.aau.dk](mailto:vbn@aub.aau.dk) providing details, and we will remove access to the work immediately and investigate your claim.

# Advanced Control Techniques for WEC Wave Dragon

J. Tedd<sup>1,2</sup>, J.P. Kofoed<sup>1</sup>, M. Jasinski<sup>3</sup>, A. Morris<sup>1</sup>, E. Friis-Madsen<sup>2</sup>,  
R. Wisniewski<sup>4</sup>, J.D. Bendtsen<sup>4</sup>

<sup>1</sup>Department of Civil Engineering,  
Aalborg University, Sohngaardhølsvej 57,  
Aalborg 9000, Denmark  
jt@civil.aau.dk, jpk@civil.aau.dk,  
am@civil.aau.dk

<sup>2</sup>WaveDragon ApS  
Blegdamsvej 4, Copenhagen, 2200 Denmark  
jt@wavedragon.net,  
efm@wavedragon.net

<sup>3</sup>Institute of Control and Industrial Electronics  
Warsaw University of Technology,  
Warsaw, Poland  
mja@isep.pw.edu.pl

<sup>4</sup>Department of Electronic Systems  
Aalborg University, Fredrik Bajers Vej 7,  
Aalborg Ø, 9220 Denmark  
raf@es.aau.dk. dimon@es.aau.dk

## Abstract

This paper presents the ongoing work on control of the Wave Dragon wave energy converter. Research is being conducted in and between several centers across Europe. This is building upon the knowledge gained in the prototype project, and will enable much better performance of the future deployment of the full scale Wave Dragon.

**Keywords:** Wave Dragon, Control, Sea Testing

## Introduction

Wave Dragon is a floating wave energy converter, extracting energy principally by means of overtopping of waves up a ramp and into a reservoir. Potential energy of the water at the higher head is extracted by several turbines within the reservoir. There is a fully automated, real sea prototype of the device deployed in northern Denmark.

The Wave Dragon concept does not need any active control to survive even extreme sea states or to absorb energy as such. Power output is greatly improved by applying a number of control systems. The control of the device can be split, considering three characteristic time spans:

- Slow - Tuning the device to the sea state
  - Must follow storms growing and declining – O(1 hour)
  - This is achieved through raising and lowering the platform by filling and emptying buoyancy tanks.
- Fast – Extracting the most energy from the waves.
  - Must follow either waves / groups of waves – O(1 minute)
  - This is achieved through opening and closing turbines to regulate the volume of water in the reservoir.
- Very fast – Ensuring the turbines run at the optimal speed and power delivered to the grid is of good quality
  - Well below the wave period O(1 second)

- This is achieved through controlling the speed of the synchronous Permanent Magnet Generators (PMGs) by AC/DC/AC frequency converters .

This paper will describe, for each of these three control systems, how they have been successfully implemented on board the Wave Dragon. The efficiency, robustness and experiences gained while using these techniques is discussed. Currently the Wave Dragon team is developing advanced control strategies for improving the device energy capture. This paper will introduce these, including real time prediction of waves, state-space control of the non-linear buoyancy system, on/off control of the turbines and AC/DC/AC control of the PMGs

## 1 The Wave Dragon

### Principle and Components

The Wave Dragon consists of three main components:

- Two wave reflectors. Attached to the central platform these act to focus the incoming waves. Laboratory tests have verified numerical simulations showing their effect of increasing the wave height. This has been shown to improve the energy captured by approximately 100 % in typical wave conditions by Kramer and Frigaard [1].
- The main platform. This is a floating reservoir with a double curved ramp facing the incoming waves. The waves overtop the ramp which has a variable crest freeboard 1 to 4 m. Underneath the platform open chambers operate as an air cushion maintaining the level of the reservoir.
- Hydro turbines. A set of low head Kaplan turbines converts the hydraulic head in the reservoir. These turbines are attached to PMG allowing variable speed operation. The produced electricity is converted using AC/DC/AC power electronics to the grid frequency.

Waves overtopping the ramp fill the reservoir with water at a higher level than the mean sea level. This head of water is used for power production through the specially designed hydro turbines. Figure 1 shows the device layout and components. A thorough description of the principle can be found in Kofoed et al. [2].

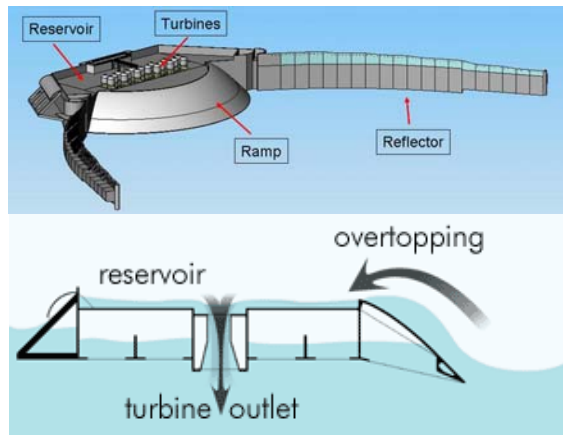

**Figure 1:** The basic principle of the Wave Dragon. The computer image above shows the double curved ramp facing waves approaching from the bottom right. The filled reservoir has turbines placed roughly in the centre. The slender wave reflectors focus the wave energy towards the ramp. The lower schematic shows the overtopping flow filling the reservoir, and turbines extracting the power when draining the water back to the sea.

### Prototype testing

Since April July 2003 testing has been conducted on a 1:4.5 scale prototype Wave Dragon in real sea environment at Nissum Bredning, in Northern Denmark. A scale of 1:4.5 was chosen as the wave climate within the area corresponds well to a 4.5 scaled down version of the North Sea wave climate. The prototype tested is built in steel and has a total mass (including water ballast) of 237 tonnes, and its length between reflector tips is 58 m. Fig. 2 shows the device in action.

The device is an automatically controlled and grid connected power plant. The conclusions of testing show the power capture of the device has reached expectations, and the availability has exceeded expectations, as reported in Tedd et al. [3].



**Figure 2:** Good overtopping occurring on the Wave Dragon prototype in Nissum Bredning

All the control strategies have been tested and developed at this scale. They have all functioned as expected. During the operational period continuous improvements have been made.

### Pre-Commercial Demonstrator

In the summer of 2008 Wave Dragon plan to commission and deploy a 7 MW unit in the Welsh Waters. This is described in great detail in Friis-Madsen et al. [4].

This will be the world's largest wave energy converter. The 7 MW device will be located 4-5 miles off Milford Haven and tested for 3-5 years only, to gain operational experience and knowledge on the energy transfer efficiencies. The project will even in this early demonstration phase produce enough clean, green electricity each year to meet the annual demand of between 2,500 and 3,000 homes. This clean generation will offset the release of about 1,000 tonnes of carbon dioxide (the main greenhouse gas contributing to global warming and climate change) every year. It is planned that this demonstrator device shall form the first of 11 devices in a 77MW farm further off the Welsh coast.

To improve the performance of this device a concerted effort is underway to improve the control performance of the Wave Dragon.

## 2 Slow Control

The main aim of the slowly acting control is to regulate the floating height of the WD to the optimal level for the current sea state. This aims to maximize the power flowing over the ramp. A lower floating level will have more flow but at a lower head, and a higher floating level will have lower flow but a higher head – the optimum must be found.

The time scale of the change in sea states is of the order of a few hours. Therefore, the platform can also change its buoyancy, and thus floating level, at a similar rate. The input to this control strategy is the current, or future, sea

state which can be measured directly in the region of the WD, or predicted based on weather forecasts.



**Figure 3:** Wave Dragon prototype seen from beneath at launch in March 2003. The open air-chambers are used to control the floating level.

Simultaneously, the heel and trim of the platform also need to be maintained as close to a preset value (normally zero) as possible. Due to the layout and non constant cross sections of the air chambers, and the free surface water volume in the reservoir, there is dependence between several buoyancy parameters.

The method for controlling the floating level, heel and trim of the platform is by blowing air into, or venting air from, open compartments beneath the reservoir. These open compartments can be seen in Fig. 3.

Due to the free surface of the reservoir this can be compared to balancing a tray full of water. The layout of these compartments and the detailed strategy for filling them is crucial to maintain stability. For example if there is a large central compartment filled with air, and low buoyancy at the edges the device will be quite unstable. However, in general the more stable the platform is, the closer to full the reservoir can be, and so the more power will be generated.

The Wave Dragon has been designed with more than enough closed buoyancy tanks to survive even if all control has failed, and the valves to all of the air chambers are left open. Such a condition has also been tested in periods with harsh weather conditions to prove survivability.

The buoyancy control method used currently is fully described in Kofoed et al [5]. Some results from this paper are reproduced in figures 4 and 5 showing how controlling the heel is important for better power capture. The Figures show the standard deviation of the heel (the quasi static

inclination of the platform along the centre line - wave induced oscillations are filtered out) of the platform.

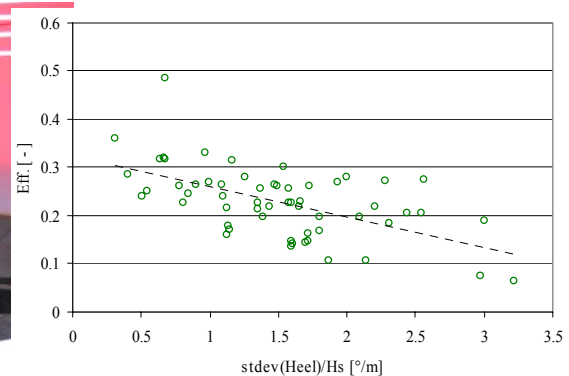

**Figure 4:** Efficiency as a function of standard deviation of heel normalized by significant wave height. A linear best fit line shows the trend.

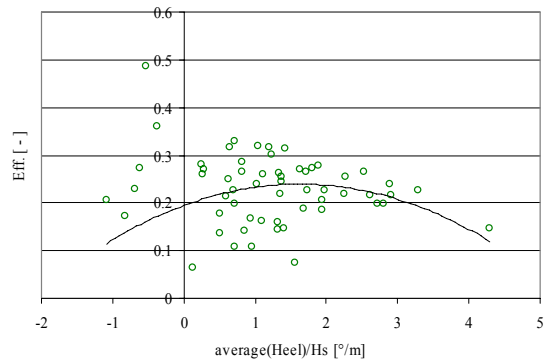

**Figure 5:** Efficiency as a function of averages of heel normalized by significant wave height. A quadratic best fit line shows the trend.

Detailed buoyancy models are being developed in order to make a simulation programme to optimise the control strategy. These are complicated by the complex geometry and the free surface of the water.

During the second testing period of the prototype, pressure readings have been taken inside each of the buoyancy chambers. Records where the buoyancy control was active, and there was little stochastic wave input to the system are valuable for calibrating such a model. One is shown in Figure 6. The initial impetus for controlling the system is due to an overly high floating level. This trips the heel and trim of the device, so that they must later be compensated. A better control strategy would not suffer from this.

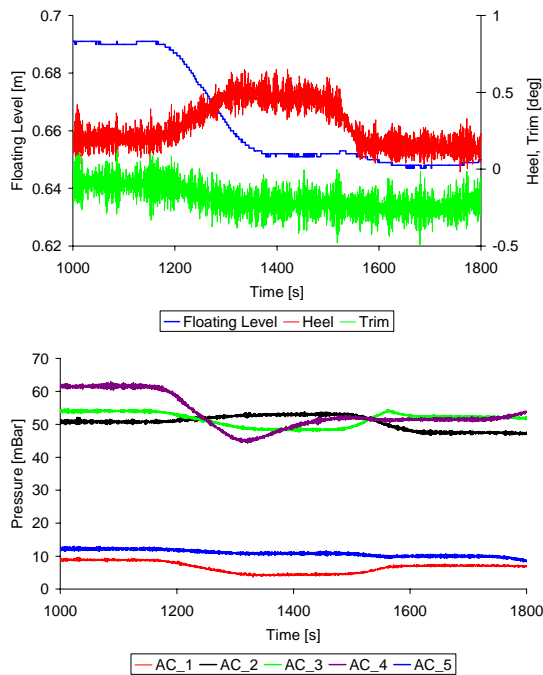

**Figure 6:** Buoyancy Behaviour and Air Chamber Pressures.

### 3 Fast Control

The faster acting control is performed to maintain a suitable water level within the reservoir. If the water level is too high, then large waves will not be able to be accommodated in the reservoir so there will be considerable spill from it. However, if the water level is lower the head across the turbines is less so less power can be produced from the same water overtopping the ramp. Again an optimal compromise must be found.

Controlling the reservoir level is done by turning the low head turbines on and off in a cascade fashion using cylinder gates. At a minimum reservoir set-point the first turbines cut-in, as waves fill the reservoir the remaining turbines progressively start, up to a maximum level where all turbines are operational. The water level in the reservoir can either be determined from pressure transducers within the reservoir itself, or from measurements of the power generated by the generators, from which the head can be inferred.

An area of development here is in the use of predictive algorithms, to control the turbines dependant on the expected overtopping in the next few waves. By lowering the reservoir level when some large waves are approaching, spill would be minimized. Also by maintaining a higher reservoir level when smaller waves are expected, less water would be discharged at a lower head. Initial studies by Tedd et al. [6] have shown that an increase in power generated of 5 to 10 % is possible.

The focus so far has been on developing methods for predicting the waves. A Digital filter based method is presented in Tedd and Frigaard [7]. By measuring the incoming waves with a pressure transducer at the mooring point (see figure 7) and transforming this using linear wave theory, real time prediction over a period of  $4 \cdot T_m$  can be achieved.

These predictive methods will be used to improve the control algorithms, as are presented by Knapp [8]. Computer simulations work with the known future overtopping (including the expected error) will optimise this stage of the power take-off.

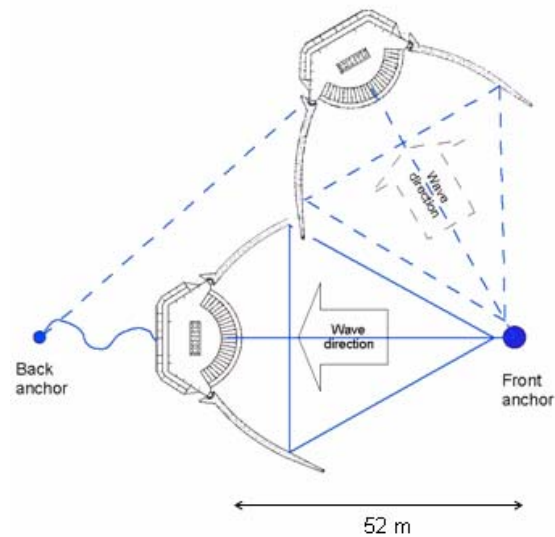

**Figure 7:** Mooring Schematic. In the study waves are measured with a pressure transducer at the front anchor, and transformed to the platform.

### 4 Very Fast Control

The power simulation work conducted shows that for the Welsh 7 MW device 16 turbines with variable speed are the optimum choice for the Wave Dragon. Power electronics are used to give good performance, and a stable system. Jasinski et al. [9] fully describes this. Each turbine is connected to an AC/DC/AC system as shown in Figure 8.

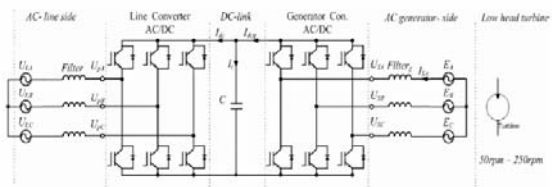

**Figure 8:** Full controlled AC/DC/AC converter (back to back) for the Wave Dragon MW system.

### Direct Power And Torque Control Of AC/DC/AC Converter With Permanent Magnet Synchronous Generator

Direct power control with space vector modulation (DPC-SVM) and direct torque control with space vector modulation (DTC-SVM) are very promising for control of an AC/DC/AC converter. When both algorithms are joined together for control of the AC/DC/AC converter connecting electrical machine and supply line direct power and torque control with space vector modulation is obtained – DPTC-SVM.

### Direct Torque Control with Space Vector Modulation – DTC-SVM

The classical DTC control method has many disadvantages as: variable switching frequency, problem with start and operation at low speed as well as requirement of very fast sampling time (fast microcontroller is necessary). Therefore, to avoid the drawbacks of switching table based DTC instead of hysteresis controllers and switching table the PI controllers with the SVM block were introduced like in field oriented control (FOC). Therefore, DTC-SVM joins DTC and FOC features in one control structure as in figure 9.

The command electromagnetic torque  $M_{ec}$  of generator is delivered from outer PI speed controller (Fig. 5). Then,  $M_{ec}$  and command stator flux  $\Psi_{sc}$  amplitudes of generator are compared with estimated actual values of torque  $M_e$  and stator flux  $\Psi_s$  in generator. The torque  $e_M$  and flux  $e_\Psi$  errors are fed to two PI controllers. The output signals are the command stator voltage components  $U_{Syc}$ , and  $U_{Sxc}$  in stator flux coordinate system respectively.

Further, these signals are transformed into  $\alpha\beta$  stationary coordinate system using  $\gamma_{yc}$  flux position angle. Obtained stator voltage vector  $U_{Sc}$  is delivered to SVM which generates appropriate switching states vector  $S_2(S_{2A}, S_{2B}, S_{2C})$  for the inverter, which supply the stator windings of generator.

Proper design of the PI torque controller parameters is very important especially in respect to generation of power quality.

### Direct Power Control with Space Vector Modulation – DPC-SVM

Direct power control with space vector modulation – DPC-SVM guarantees high dynamics and static performance via an internal power control loops. This method joins the concept of DPC and virtual flux (VF) oriented control (V-FOC). The active and reactive power is used as control variables instead of the line currents. The DPC-SVM with constant switching frequency uses closed active and reactive power control loops (Fig. 5). The command active power  $P_c$  are generated by outer DC-link voltage controller,

whereas command reactive power  $Q_c$  is set to zero for unity power factor operation.

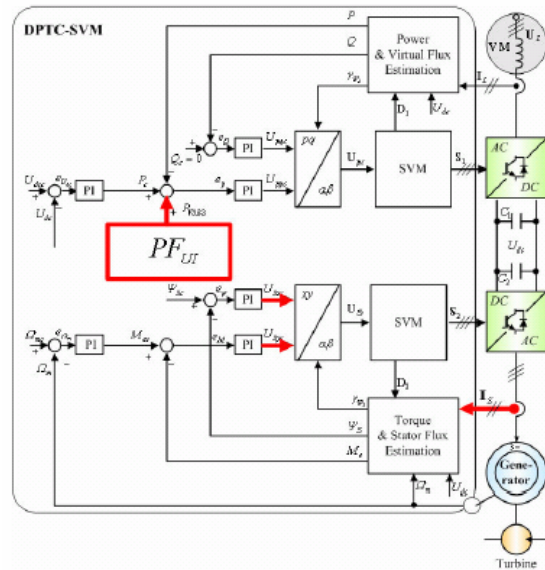

**Figure 9:** Direct Power and Torque Control-Space Vector modulated (DPTC-SVM) with active power feedforward (PF). Where VM – Virtual machine, SVM – Space Vector modulator.

### Active power feedforward – PF

In spite of very good dynamics behaviors of DPTC-SVM scheme, the control of the DC-link voltage can be improved. Therefore, active power feedforward – PF from generator side converter (GSC) to line side converter (LSC) was introduced. The PF deliver information about machine states directly to active power control loop of the LSC. Thanks to faster control of power flow between generator and line, the fluctuation of the DC-link voltages will be significantly decreased. So, the life time of the DC-link capacitors would be prolonged. In Fig. 6 is shown simplified diagram of the AC/DC/AC converter which consist of LSC and GSC. Both converters are IGBT bridge converter. Note again that, the coordinates system for control of the LSC is oriented with VF vector. Therefore,  $L_{xc}$  is set to zero to meet the unity power factor (UPF) condition. With this assumption the line side power of LSC can be calculated.

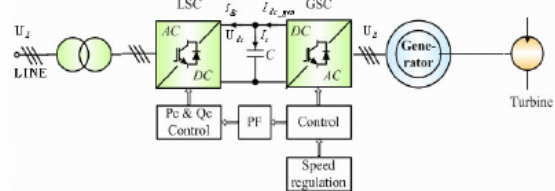

**Figure 10:** Simplified configuration of the AC/DC/AC converter with control between generator and Line.

This fast control system has been tested using computer simulation tools, and has shown to allow the speed to accurately follow the desired speed. This varies as the head across the turbines changes as the reservoir fills and empties.

## Conclusions

This paper has presented the ongoing research into control of the Wave Dragon device. The work builds on the knowledge gained during the prototype project, and more work will be completed to give better performance of the full scale deployment in Welsh waters in 2008 .

## Acknowledgements

The Wave Dragon prototype project has only been possible with generous support funding from the European Commission (Contract No: ENK5-CT-2002-00603), Danish Energy Authority, Elkraft System (PSO Funding), The Obel Family Trust and the dedication of the participating partners

The Pre-Commercial Demonstrator project is supported by the Welsh Assembly Government. A European Research project is co-supporting it.

The first author is a research fellow funded by the Marie Curie WaveTrain research training network.

## Further Information

More information can be found on the project at the website [www.wavedragon.net](http://www.wavedragon.net).

## References

[1] Kramer, M and Frigaard, P. Efficient Wave Energy Amplification with Wave Reflectors. *Proceedings of the 9th ISOPE conference*, 2002.

[2] Kofoed JP, Frigaard P, Friis-Madsen E and Sørensen HC. Prototype testing of the wave energy converter wave dragon. *Renewable Energy* 31, 2006.

[3] Tedd J, Kofoed JP Knapp W, Friis-Madsen E and Sørensen HC. Wave Dragon, prototype wave power production. *World Renewable Energy Congress IX proceedings*, Florence. 2006.

[4] Friis-Madsen E, Christensen L, Kofoed, JP and Tedd J. Worlds Largest Wave Energy Project 2007 in Wales. *Powergen Europe Conference Proceedings*, Cologne 2006.

[5] Kofoed JP, Tedd J, Friis-Madsen E and Nimskov M. Influence of Buoyancy Control performance on power production by the Wave Dragon Nissum Bredning Prototype. *17th ISOPE conference proceedings*, Lisbon, 2007.

[6] Tedd J., Knapp W., Frigaard P, and Kofoed J. P. Turbine Control Strategy Including Wave Prediction for Overtopping Wave Energy Converters. *Co-ordinated Action on Ocean Energy, 2nd Workshop proceedings*, Uppsala, 2005.

[7] Tedd J and Frigaard P. Short term wave forecasting, using digital filters, for improved control of Wave Energy Converters. *17th ISOPE conference proceedings*, Lisbon, 2007.

[8] Knapp, W. Water Turbines for Overtopping Wave Energy Converters. *Co-ordinated Action on Ocean Energy, 2nd Workshop proceedings*, Uppsala 2005

[9] Jasinski M, Malinowski M, Kazierkowski MP, Sørensen HC, Friis-Madsen E and Swierczynski D. Control of AC/DC/AC Converter for Multi MW Wave Dragon Offshore Energy Conversion System,