

Sylvie Duvernoy

Via Benozzo Gozzoli, 26  
50124 Florence ITALY  
sduvernoy@kimwilliamsbooks.com

Keywords: Leonardo da Vinci,  
Luca Pacioli, quadrature of the  
circle, doubling the cube,  
Renaissance mathematics

Research

## *Leonardo and Theoretical Mathematics*

**Abstract.** Leonardo's mathematical notes bear witness to a work in progress and allow us to look directly into the mind of the writer. In Leonardo we find two of the three fundamental classical geometric problems: the duplication of the cube and the quadrature of the circle. While Leonardo is extremely familiar with two-dimensional geometry problems, and proposes playful graphic exercises of adding and subtracting polygonal surfaces of all kinds, he is still unable to solve the problem of the duplication of the cube. Numerous pages testify of the attempt to rise above planar geometry and reach the realm of the third dimension, but Leonardo always bumps against the limits of quantity calculation possibilities of his age.

### *Introduction*

Leonardo came to the study of mathematics rather late in life. We know from Giorgio Vasari that he attended in his youth, as any student of his time, the *scuola d'abbaco*, where he is presumed to have learned the bases of arithmetic and geometry. Vasari also reports that he was so clever that he did not attend the school for more than a few months, and soon left because he used to argue with the teacher, who was not able to give satisfactory answers to his objections [Vasari 1991: 557-558].

We must believe the biographer when he tells us that Leonardo quickly decided to leave the school, but we cannot agree with him when he says that he did so because he was too good a student and would not increase his knowledge in this popular institution. Until he met Luca Pacioli in Milan, whom he accepted as a teacher and a master, Leonardo was far from being a brilliant mathematician. Looking through the various folios of the early codices we can see that he was unfamiliar with arithmetic, and very clumsy in computational operations involving fractions, both in multiplication and division. He would not believe, for instance, that the division of a number (or fraction) by a number (or fraction) inferior to one would give a result superior to the original number. He also used to make basic mistakes when multiplying large numbers including zeros.

The zero symbol, 0, had been introduced into the Western arithmetic annotation system, together with the full series of Arab numerals – 1,2,3, ... 9 – by Leonardo of Pisa, better known as Leonardo Fibonacci, nearly three full centuries earlier, in 1202, with the publication of his famous *Liber Abaci* which at the time of Leonardo da Vinci's youth was still the main textbook on which teachers relied for their lessons.

Leonardo da Vinci and Luca Pacioli met in Milan in 1496, at the Court of Ludovico Sforza. Leonardo had been in the Duke's service since 1482, and he was 44 years old when he first met Luca Pacioli, who had been called by the Duke to teach mathematics. Pacioli himself was 51, and had just published two years before, in 1494, his *Summa de aritmetica*

*geometria proportioni e proportionalità*, which was for the most part a revisitation of the *Trattato d'abaco* written (but not published) by his own master, Piero della Francesca.

The encounter with Pacioli marks a turning point in Leonardo's life as regards the study of mathematics. Guided by his master and friend, he started a systematic study of theoretical mathematics, going from recent and contemporary publications back to classical sources and textbooks. It is clear that, just like every scientist of his period, he carefully studied the *Elements* of Euclid, and became familiar with all the classical geometrical problems.

We have at our disposal a fair number of architectural and mathematical treatises from the Renaissance period, but the preliminary research notes necessary for the compilation of those books were all lost. We only have the final compositions, printed and illustrated in order to offer a didactic edition. Leonardo, on the other hand, never wrote a proper treatise, but left to posterity a huge quantity of manuscript papers that can be considered as preliminary notes for books never written. His notes, although confused and somewhat disordered, are very precious to us because they testify to work in progress and allow us to look directly into the mind of the scientist. While real treatises only show the solutions to problems and the certified rules, in Leonardo's manuscripts we find numerous questions that sometimes reach a conclusion, sometimes not, giving us valuable information as regards the process of mathematical research in the Renaissance period, covering a wide range of approaches, from graphic and arithmetic, to geometric and analytical.

### *The duplication of the cube*

The first striking thing to notice is how at least two of the three fundamental classical geometric problems were still present in the minds of the scientists of Renaissance times: the duplication of the cube and the squaring of the circle.

Leonardo put a lot of effort into trying to solve the problem of the duplication of the cube. This problem, according to the legend attached to it, is the most ancient example of a relationship between architecture and mathematics. The people of Delos were faced with an architectural conundrum concerning a religious monument. The oracle had told them to build an altar to Apollo twice as big as the previous one, which was of a cubic form. But what should the dimension of the side of the new cube be in order to obtain a cube twice the volume of the original one? After a first, wrong, attempt consisting in doubling the side of the cube, the architectural request was for mathematicians, who had not yet discovered the algebraic calculation of irrational quantities. Leonardo's predilection for this specific problem surely comes from his obvious interest in three-dimensional geometry and stereometry. His many efforts to solve the problem go from somewhat ingenuous and empirical attempts, to the study of classical solutions, and follow different sorts of scientific research methodologies.

**A graphic approach: *Codex Arundel*, folio 283v.** Leonardo asks himself whether any kind of simple extension from two- to three-dimensional geometry exists (fig. 1).

Can Plato's theorem on the duplication of the square be extended to the duplication of the cube?

Is the volume of a cube built from a double square twice the volume of a single unity cube?

If the diagonal (or diameter) of a square with a side of 1 is the graphic visualisation of the incommensurable quantity of the square root of two, is the diagonal of a cube with a side of 1 the graphic answer to the irrational number equal to the cube root of 2?

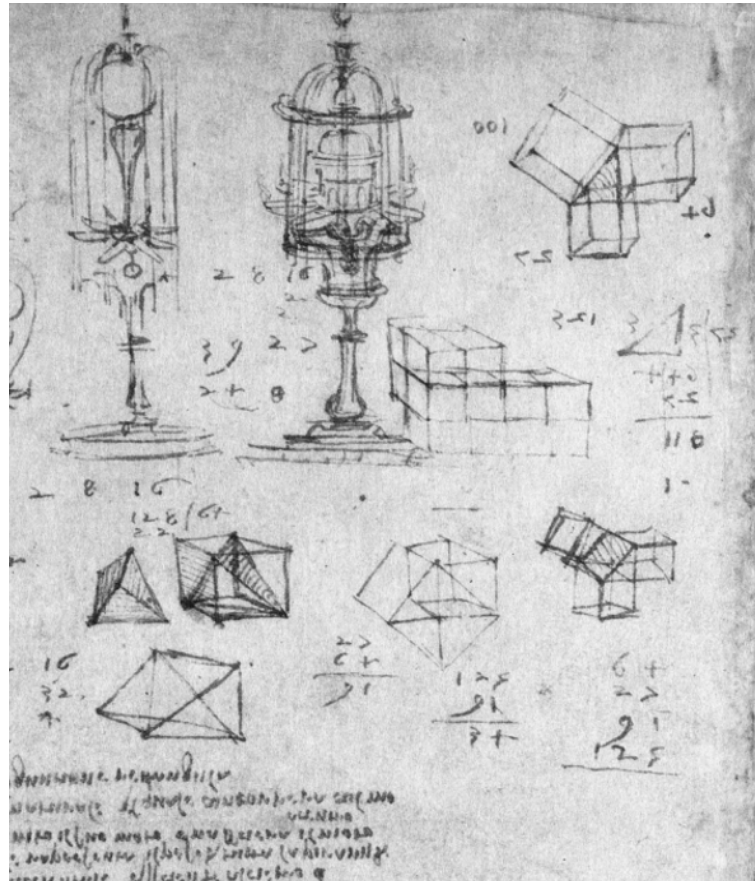

Fig. 1. Leonardo da Vinci, *Codex Arundel*, fol. 283v. Graphic and arithmetical approaches to the duplication of the cube, starting from the theorems of Plato and Pythagoras

The answers are no. The diagonal of the cube is equal to the square root of 3, and not the cube root of 2, which is a smaller number than the square root of 2.

**An arithmetic approach: *Codex Arundel*, folio 283v.** Following another idea, Leonardo then tries to extend Pythagoras's theorem on right-angled triangles from squares to cubes. If the sum of the squares of the sides of these triangles is equal to the square of the hypotenuse, can the same apply to cubes?

Taking the simplest example, the 3-4-5 triangle (the so-called "Egyptian triangle"), the calculation quickly appears disappointing.

More generally, is there a cubic number that can be split into the sum of two lesser cubic numbers? Would those three numbers lead to the discovery of a particular family of triangles?

The answer is no. The equation  $a^n + b^n = c^n$  does not have a solution in integers for  $n > 2$ . But this theorem had yet to be demonstrated. It was not before 1753 that Leonhard Euler demonstrated that the equation  $a^3 + b^3 = c^3$  does not have a solution. And the final demonstration of the so-called “Fermat’s third theorem”, which is that the general equation  $a^n + b^n = c^n$  does not have a solution for  $n > 2$ , was given by Andrew Weil in 1993.

**A stereometric approach: *Codex Arundel* folios 223v and 223r.**

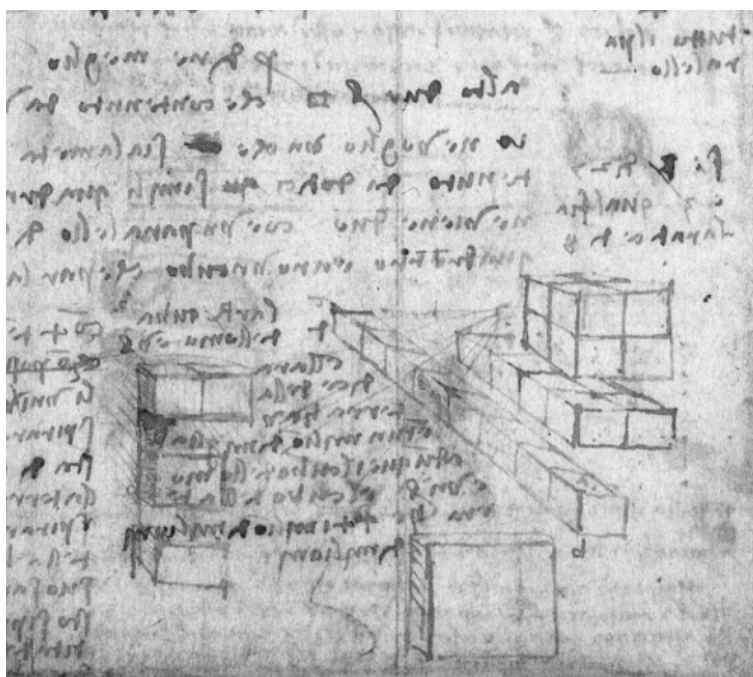

Fig. 2. Leonardo da Vinci, *Codex Arundel*, fol. 223 v. Stereometric approach to the duplication of the cube

Other pages testify to a strenuous effort to solve the problem of Delos according to a stereometric approach. Instead of doubling a cube Leonardo reverses the problem and tries to divide one cube into two smaller and equal ones. He starts with a cube that he divides into 27 small units – which is easy because it was “made from the cube root of 27”, equal to 3 – but 27 is an odd number whose units cannot be rearranged into two equal small cubes. So, Leonardo takes another cube made of 8 small cubic units and tries to work out how to arrange four of these units in a cubic form. In the meantime, he tries to find out if there is a direct proportional relationship between the surface and the volume of a solid. Is the envelope of a solid proportional to its volume? This eventuality could be a convenient solution to bring back the problem from three-dimensional geometry to two-dimensional, but he quickly understands that the idea is erroneous. The negative conclusion comes on

the back of the same folio, which contains the affirmation “...so don’t use this science of cubes according to their surfaces but according to their bodies, because a same quantity has different surfaces of infinite values... equal surfaces don’t always contain equal bodies...”

So going back to the 8-unit cube, Leonardo wonders: “ if I have a cube made of eight cubes, I made it from the cube root of eight... if the cube root of 27 is 3, which is the root of 8?”

**Another arithmetic approach: *Codex Atlanticus*, folio 161r.** Finding an approximate value for the cubic root of 8 would not have solved the problem of the duplication of the cube anyway, nor the reverse corollary, its division into two. Only the determination of an approximate value of the cubic root of 2 would have given an arithmetical solution to this mathematical problem (fig. 3).

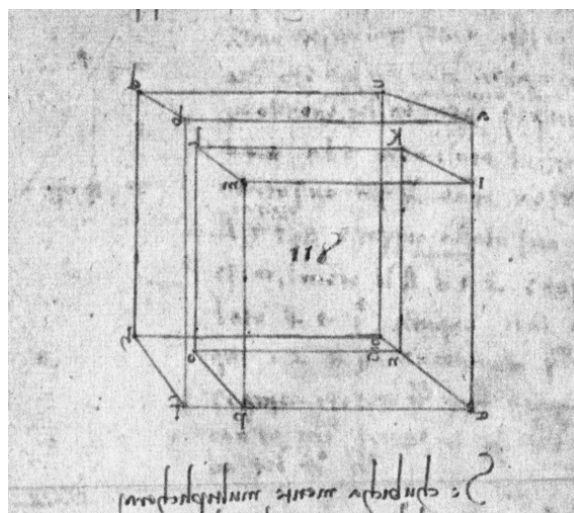

Fig. 3. Leonardo da Vinci, *Codex Atlanticus*, folio 161r. Arithmetical approximation: the value of cube root of 2 is close to  $5/4$

In the published mathematics books of Leonardo’s times (*Summa de aritmetica geometria proportioni e proportionalità* by Luca Pacioli, etc...), whereas the value of  $\pi$  had long been considered almost equal to  $22/7$ , and square root of 2 nearly equivalent to  $7/5$  (or  $14/10$ ), the cubic roots, which are not equal to a round number, such as the cube root of 27 or 64, are not approximated by a fraction, but remain as “cubic root of  $x$ ” and the authors do not give estimated values for them.

Leonardo reached an acceptable approximation for the cube root of 2. Successive calculation attempts lead him to conclude that a cube of a 5-unit side has a volume close to twice that of a cube of a 4-unit side.  $125/64$  is accepted as a good approximation of  $128/64 = 2$ .

$5/4$  can therefore be considered a close approximation of the cube root of 2, which can consequently be adopted from then on for the practical purposes of three-dimensional metrical geometry (fig. 4).

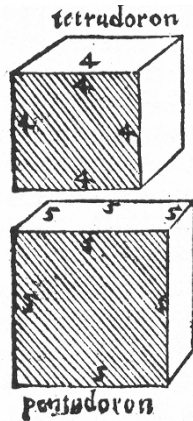

Fig. 4. Evidence of ancient approximation to the irrational value of cubic root of 2: the cubic Greek bricks of sides 4 and 5 (*tetradoron* and *pentadoron*) mentioned by Vitruvius in *De Architectura*, bk. II, chap. 3, drawn by Andrea Palladio for Daniele Barbaro's Renaissance translation and commentary of Vitruvius (1556)

**A classical geometric approach: *Codex Forster I*, folio 32.** In addition to looking for his own solutions to the duplication of the cube, Leonardo also studied the classical solutions of the ancient Greek mathematicians, probably guided by Luca Pacioli, who was a scholar of Euclid. Evidence of this can be seen in the carefully drawn interpretation of Apollonius's method for the Delian problem (fig. 5).

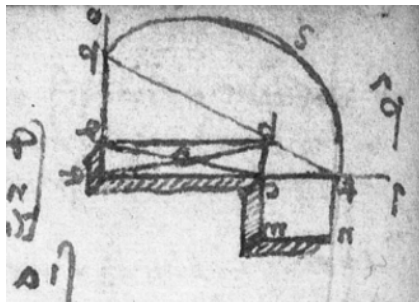

Fig. 5. Leonardo da Vinci, *Codex Forster I*, folio 32. A classical geometrical approach to the duplication of the cube, from Apollonius' method

Hippocrates of Chios had reduced the problem of the duplication of the cube to the problem of finding two mean proportionals between two straight lines representing two arithmetical magnitudes.

The three most famous answers to the query are the work of three mathematicians of the Platonic era: Archytas, Eudoxus and Menaechmus. These solutions were followed by several others, including one attributed to Apollonius that is particularly simple both conceptually and graphically. Apollonius's method is not among the two classic solutions that Vitruvius mentions in his treatise, and that Barbaro was to illustrate in his Renaissance commentary of Vitruvius, adding Nicomede's proposal. This method is derived from Euclid, and more precisely from Book 2, last proposition: from a given rectangle, find an

equivalent square; or on the other way round: from a given square, find the equivalent rectangle having a given base (fig. 6).

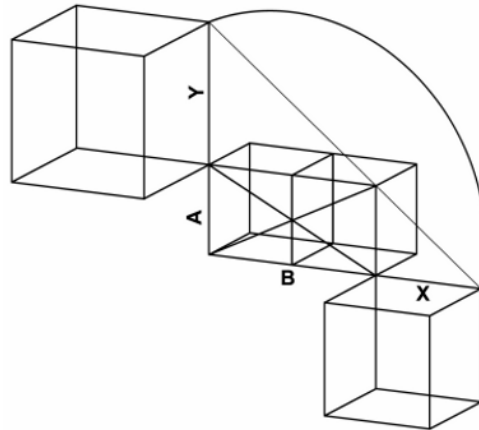

Fig. 6. Apollonius's solution to the duplication of the cube. Drawing by the author

The demonstration runs as follows: if the two initial straight lines (A and B) are assembled to form two adjacent sides of a rectangle, a ruler must be placed on the opposite vertex of that parallelogram, and swung around the pivot thus formed until it bisects two lines extending out from the initial sides of the rectangle at two points that are equidistant from the rectangle's center. The equidistance is verified – and demonstrated – by drawing an arc traced with a compass whose needle is placed at the center of the rectangle: i.e., the intersection point of its diagonals. The values of the two intervals thus obtained (X and Y) between the sides of the rectangle and the intersection points will be the two sought-after mean proportionals (fig. 7).

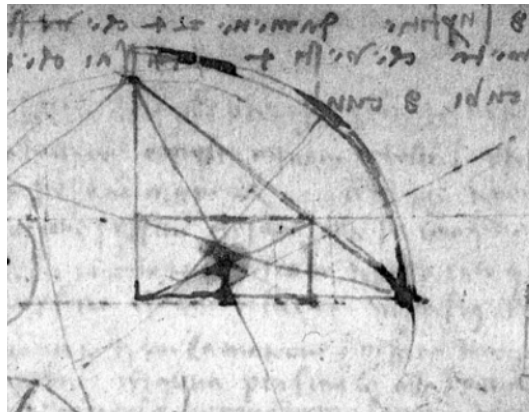

Fig. 7. Leonardo da Vinci, *Codex Arundel*, f. 223v. Leonardo's copy of a classical two-dimensional graphic explaining Apollonius's solution

In accordance to the Greek tradition of mathematical sketches, the diagram drawn by Apollonius to illustrate his demonstration is extremely schematic and two-dimensional: it represents the partial orthogonal projection of volumes on a plane parallel to one of their

faces. It can be considered to be either a top view – *ichnographia* – or a front view – *orthographia*. The rectangle seen in the diagram is the face of a parallelepiped whose depth is equal to its width: a prism with a square base (invisible on the figure because of its perpendicularity to the drawing plane), and a given height. Apollonius’s demonstration can be understood with the help of the figure only if the reader of the image is able to interpret it correctly by substituting the missing information regarding the third dimension with a mental procedure that will complete the message. Leonardo, while studying and sketching, added the third dimension, transforming the figure in a perspective (axonometric?) drawing in order to ease comprehension (see fig. 5).

Leonardo’s drawing shown in *Codex Atlanticus* fol. 588 r (fig. 8) illustrates the case in which the cylinder is a double cube, and makes a discovery when noticing (probably by chance) that BF is equal to BE. This implies that the geometric construction can be reduced to a very quick and easy manipulation of the single straightedge (with the very slight support of a compass), and represents an important step towards the simplification of the solving of this problem, which has inspired the most sophisticated inventions and construction of heavy mechanical drawing tools since antiquity. Leonardo’s method makes it possible to skip Apollonius’s mechanical test of the simultaneous line balancing on point A, and arc drawing with center in M, which Leonardo judged to be imprecise and dubious, with a result that can only be obtained through *fatioso negozio*, “tiring effort”.

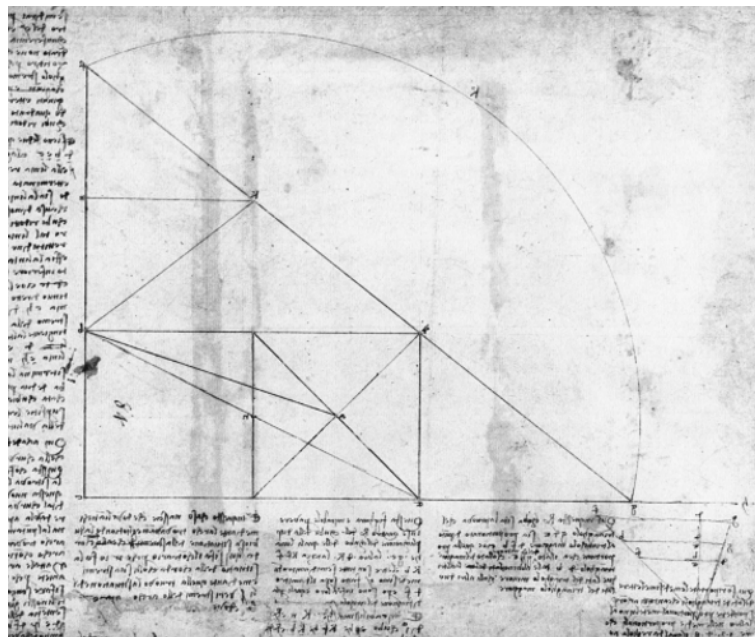

Fig. 8. Leonardo da Vinci, *Codex Atlanticus*, folio 588 r. Leonardo’s addition to Apollonius’s solution

Simplification means divulgation and popularization. The graphic representation of this unknown and incommensurable quantity of the cube root of 2 has become as easy as – for instance – the construction of a pentagon inscribed in a circle. But Leonardo admits to not being able to draw an explanatory theory from his own finding, and this is why we may suppose that he reached it in a totally empirical way. Scientific theoretical demonstration is



not Leonardo's specialty. Investigation and experimentation tend to stop when a discovery is made, in hope and haste to make another. The caption next to the figure in *Codex Atlanticus* shown in fig. 8 says: "If you will tell me for what reason the half diameter of the circle fits six times into its circumference and why the diagonal of the square is not commensurable to its side, I shall tell you why the straight line that goes from the upper vertex of one of the two joined squares to the center of the second square shows us the cube root of the two cubes reduced in a single one".

### *The squaring of the circle*

Leonardo also spent a lot of time trying to solve a second classical problem: the squaring of the circle. One day he even claims to have reached a solution: on *Codex Madrid II*, folio 112r we read, "the night of St Andrew, I finally found the quadrature of the circle; and as the light of the candle and the night and the paper on which I wrote were coming to an end, it was completed; at the end of the hour." But the solution is not there...

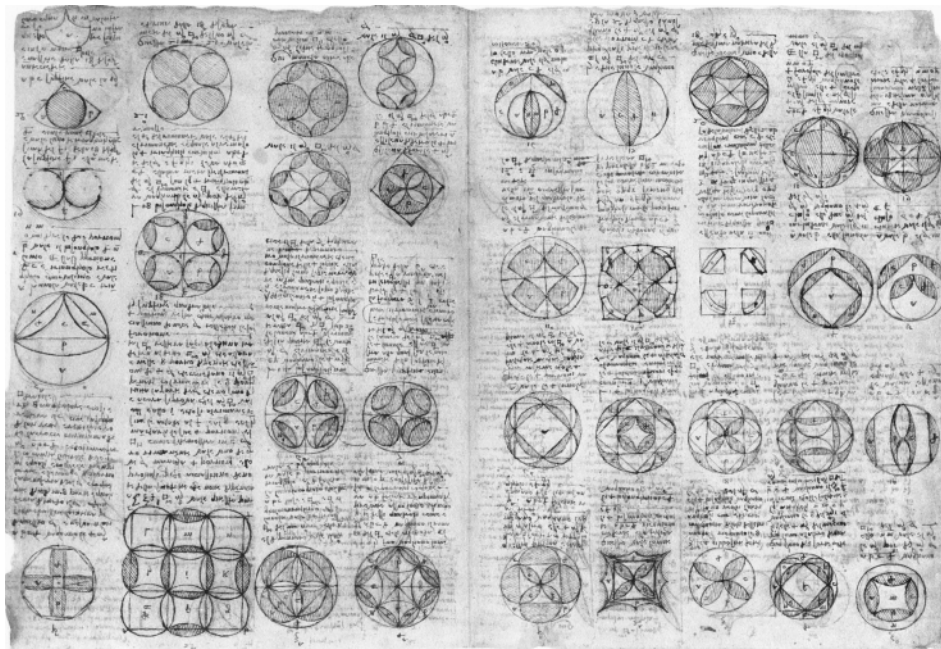

Fig. 9. Leonardo da Vinci, *Codex Atlanticus*, folio 471. Squaring the circle, graphic research

Leonardo's approach to the attempt of squaring the circle is obviously inspired by that of Archimedes, even if it is not clear whether it is by direct reading or only by second-hand knowledge. In any case, he remained unsatisfied with the approximate ratio between the circumference and the diameter as  $22/7$ . Therefore he tries to take this approximation beyond the 96-sided polygon, in an attempt to bring the difference of areas between circle and polygon to be as small as the "mathematical point", which has no quantity. This research generates an enormous quantity of sketches that show an infinite variety of decorative shapes (*Codex Atlanticus*, fol. 471, fig. 9). Scientific research turns into a never-ending, playful, graphic game. Leonardo intended to write and publish a treatise in order

to make public his discovery, and its title would have been *De Ludo Geometrico*. This methodology does not lead to a satisfactory solution, or even to any progress towards a result, but the value of his effort lies in this attempt at extension ad infinitum.

### *Leonardo's contribution to mathematic research*

It is in the realm of three-dimensional geometry that Leonardo achieved his greatest result: the determination of the location of the center of gravity of a pyramid.

**A mechanical approach: codex Arundel, folio 218 v.** The elevation from two- to three-dimensional geometry starts with the study of Archimedes' book, *On the equilibrium of planes*. Leonardo must have felt at ease with Archimedes' experimental method, where the planes are considered to have a weight and are hung at the end of levers and ropes in order to determine the exact position of their center of gravity. Archimedes deals with planes, especially triangles, while Leonardo extends the experiment to solids, and first of all to the regular tetrahedron. Knowing from previous studies the position of the centers of gravity of the faces of the solid, he finds out that "the center of gravity of the body of four triangular bases is located at the intersection of its axes and it will be in the 1/4 part of their length" (fig. 10).

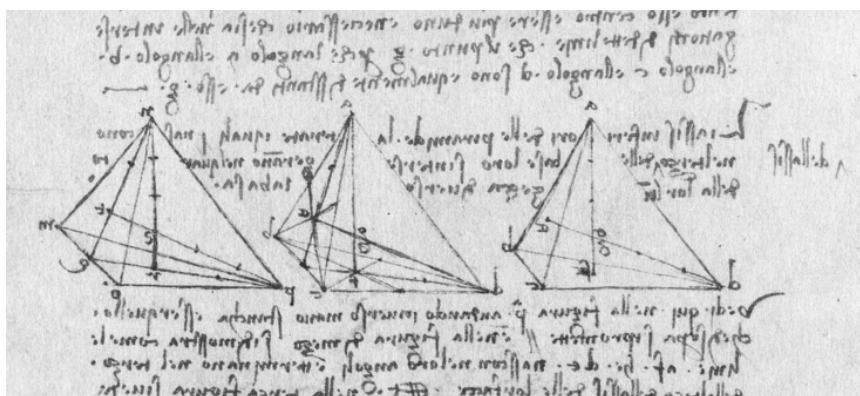

Fig. 10. Leonardo da Vinci, *Codex Arundel*, fol. 218v. The centre of gravity of a pyramid

The generalization of this discovery leads to the statement that "the center of gravity of any pyramid – round, triangular, square, or of any number of sides – is in the fourth part of its axis near the base."

On *Codex Arundel* folio 123v there is an additional theorem concerning the tetrahedron:

the pyramid with triangular base has the center of its natural gravity in the segment which extends from the middle of the base [that is the midpoint of one edge] to the middle of the side [that is, edge] opposite the base; and it is located on the segment equally distant of the line joining the base with the aforesaid side.

## ***Conclusion***

From this brief study of the works of Leonardo in the area of theoretical mathematics it appears that stereometry and solid geometry were the fields that best suited his inventive skills, and this is probably due to his skill in three-dimensional representation, which allowed him to obtain an exact visualization of the objects of his studies. All the folios of the various codices are full of perspective sketches that are not drawn in compliance to the recently established *costruzione legittima*, but rather following a spontaneous gift for representation that often generates some kind of pre-axonometric drawings rather than perspective ones.

On a more general level, we may conclude that Leonardo contributed to mathematical and scientific research in the Renaissance period by demonstrating the power of the tool of three-dimensional representation as a research device as well as a persuasive instrument. The well-known series of drawings of the Platonic – and non – solids that he made as illustrations for the book of his friend Luca Pacioli is simply one of the many examples of this.

## ***Bibliographic references***

- ARTMANN, Benno. 1999. *Euclid – The creation of mathematics*. New York: Springer-Verlag.
- BAGNI, Giorgio T. and Bruno D'AMORE. 2006. *Leonardo e la matematica*. Florence : Giunti.
- EUCLID. 1993. *Œuvres*. Ed. and trans. Jean Itard. Blanchard, Paris
- FOWLER, David. 1999. *The mathematics of Plato's academy. A new reconstruction*. Oxford: Clarendon Press,.
- HEATH, Sir Thomas. 1981. *A history of Greek mathematics*. New York: Dover Publications.
- KNORR, Wilbur Richard. 1986. *The ancient tradition of geometric problems*. Boston: Birkhäuser.
- LORIA, Gino. 1914. *Le scienze esatte nell'antica Grecia*. Milan: Hoepli.
- MARCH, Lionel. 1998. *Architectonics of Humanism*. London: Academy editions.
- MARINONI, Augusto. 1982. *La matematica di Leonardo da Vinci*. Arcadia.
- PACIOLI, Luca. 2004. *De Divina Proportione*, Augusto Marinoni ed. Milan: Silvana editore.
- TATON, René, ed. 1958. *Histoire générale des sciences*. Paris: Presses Universitaires de France.
- VASARI, Giorgio. 1991. *Le vite dei più eccellenti pittori, scultori e architetti* (1550). Rome: Newton Compton editori.
- WITTKOWER, Rudolf. 1962. *Architectural principles in the Age of Humanism*. London: Academy editions.

## ***About the author***

Sylvie Duvernoy is an architect who graduated from Paris University in 1982. She participated in the Ph.D. program of the Architecture School of University of Florence and was awarded the Italian degree of "Dottore di Ricerca" in 1998. She presently teaches architectural drawing at the engineering and architecture faculties of University of Florence. Her research has mainly focused on the reciprocal influences between graphic mathematics and architecture. These relationships have always been expressed by the means of the drawing: the major and indispensable tool of the design process. The results of her studies were published and communicated in several international meetings and reviews. In June 2002 she presented "Architecture and Mathematics in Roman Amphitheaters" at the Nexus 2002 conference in Óbidos, Portugal. In addition to research and teaching, she maintains a private practice as an architect. After having worked for a few years in the Parisian office of an international Swiss architecture firm, she is now partner of an associate office in Florence, the design projects of which cover a wide range of design problems, from remodelling and restoration to new constructions, in Italy and abroad.