



**AALBORG UNIVERSITY**  
DENMARK

**Aalborg Universitet**

## **Power Electronics and Controls for Wind Turbine Systems**

Blaabjerg, Frede; Iov, Florin; Chen, Zhe; Ma, Ke

*Published in:*

Proceedings of the IEEE Energy Conference and Exhibition, ENERGYCON 2010

*DOI (link to publication from Publisher):*

[10.1109/ENERGYCON.2010.5771701](https://doi.org/10.1109/ENERGYCON.2010.5771701)

*Publication date:*

2010

*Document Version*

Accepted author manuscript, peer reviewed version

[Link to publication from Aalborg University](#)

*Citation for published version (APA):*

Blaabjerg, F., Iov, F., Chen, Z., & Ma, K. (2010). Power Electronics and Controls for Wind Turbine Systems. In *Proceedings of the IEEE Energy Conference and Exhibition, ENERGYCON 2010* (pp. 333-344). IEEE Press. <https://doi.org/10.1109/ENERGYCON.2010.5771701>

### **General rights**

Copyright and moral rights for the publications made accessible in the public portal are retained by the authors and/or other copyright owners and it is a condition of accessing publications that users recognise and abide by the legal requirements associated with these rights.

- ? Users may download and print one copy of any publication from the public portal for the purpose of private study or research.
- ? You may not further distribute the material or use it for any profit-making activity or commercial gain
- ? You may freely distribute the URL identifying the publication in the public portal ?

### **Take down policy**

If you believe that this document breaches copyright please contact us at [vbn@aub.aau.dk](mailto:vbn@aub.aau.dk) providing details, and we will remove access to the work immediately and investigate your claim.

# Power Electronics and Controls for Wind Turbine Systems

F. Blaabjerg, F. Iov, Z. Chen, K. Ma

Department of Energy Technology, Aalborg University  
Pontoppidanstraede 101, DK-9220 Aalborg East, Denmark  
fbl@et.aau.dk, fi@et.aau.dk, zch@et.aau.dk, kema@et.aau.dk

**Abstract** – The electrical energy consumption continues to grow and more applications will be based on electricity in the next decades. We can expect that more 60 % of all energy consumption will be converted and used as electricity. It is a demand that production, distribution and use of electrical energy are done as efficiently as possible. Further, emerging climate changes argues to find future solutions which also are sustainable. Two major technologies will play important roles to solve parts of those future problems. One is the change the electrical power production from conventional, fossil (and short term) based energy sources to renewable energy sources. Another is to use power electronics to achieve high efficiency in power generation, transmission/distribution and utilization. This paper discuss trends of the most promising renewable energy sources, wind energy, which ,integrated with power electronics, is changing the future electrical infrastructure and also contributes steadily to non-carbon based electricity production. The paper's focus is on the power electronics technologies used in wind turbine systems.

## I. INTRODUCTION

In classical power systems, large power generation plants located at adequate geographical places produce most of the power, which is then transferred towards large consumption centers over long distance transmission lines. Now the power system is changing, as a large number of dispersed generation (DG) units, including both renewable and non-renewable sources such as wind turbines, wave generators, photovoltaic (PV) generators, small hydro, fuel cells and gas/steam powered Combined Heat and Power (CHP) stations, are being developed and installed all over the world [1]-[2]. A widespread use of renewable energy sources in distribution networks is seen. E.g. Denmark has a high power capacity penetration (> 30 %) of wind energy in major areas of the country and today 25 % of the whole electrical energy consumption is covered by wind energy. They have even an ambition to achieve non-fossil based power generation in 2050 [3]. The main advantages of using renewable energy sources are the elimination of harmful emissions and the inexhaustible resources of the primary energy. However, the main disadvantage, apart from initial higher costs, is the uncontrollability as they are completely weather-based. The availability of renewable energy has strong daily and seasonal patterns and the power demand by the consumers could have a very different characteristic. Therefore, it is difficult to operate a power system installed with only renewable generation units due to the characteristic differences and the high uncertainty in the availability of the renewable energy

sources. This is further exaggerated as no real large scale electrical energy storage systems exist.

The wind turbine technology is the most promising renewable energy technology [4]-[13]. It started in the 1980's with a few tens of kW production power per unit to today with multi-MW size wind turbines that are being installed. It also means that wind power production in the beginning did not have any serious impact on the power system control but now due to their size they have to play an active part in the grid. The technology used in wind turbines was in the beginning based on a squirrel-cage induction generator connected directly to the grid. Power pulsations in the wind are almost directly transferred to the electrical grid by this technology. Furthermore, no control of the active and reactive power exists except from some capacitor banks, which are important control parameters to regulate the frequency and the voltage in the grid system. As the power range of the turbines increases those control parameters become more important and it has been necessary to introduce power electronics [6] as an interface between the wind turbine and the grid. The power electronics is changing the basic characteristic of the wind turbine from being an energy source to being an active power source. The electrical technology used in wind turbine is not new. It has been discussed for several years but now the price pr. produced kWh is so low, that solutions with power electronics are very attractive [4]-[36].

The scope of this paper is to give an overview and discuss some trends in power electronics technologies for wind turbines. First, the basic market developments are discussed. Next different wind turbine configurations are explained both aerodynamically and electrically – including a comparison. Then some dominant and promising power converter topologies for wind turbines are presented and compared. Also different control methods are explained for state-of-the art wind turbines including the grid codes which are pushing the technology. Further the power electronics for the wind farms and some final conclusions are given for the technologies.

## II. WIND POWER DEVELOPMENT

The wind power has grown to a cumulative worldwide installation level of 160 GW with over 38 GW alone installed in 2009, according to BTM Consult. The total electrical power capacity market is presently around 200 GW and this number is indicating that wind power is really an important

factor. The worldwide penetration of wind power of electricity was 1.6% and the prediction for 2019 is more than 8% or 1 TW cumulative installations. China was the largest market in 2009 with over 13 GW installed and in general EU, USA and China are sharing around one third of the total market. The evolution of the wind turbine market is shown in Fig. 1.

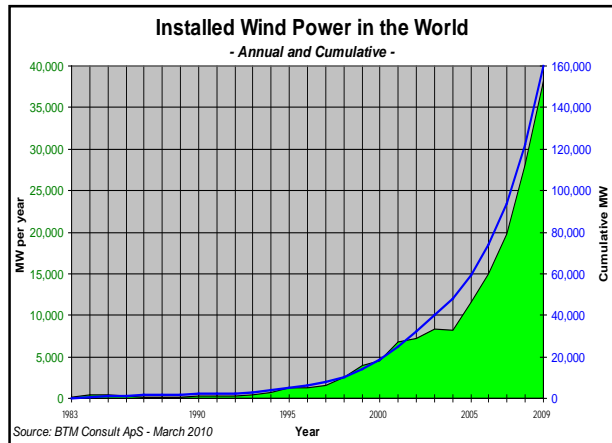

Fig. 1. Annual and cumulative installed Wind Power Capacity from 1985 to 2009 (source: BTM Consult).

The Danish company Vestas Wind Systems A/S was in 2009 still on the top position among the largest manufacturers of wind turbines in the world, closely followed by GE Wind, as the second largest in the world. Fig. 2 shows the wind turbine top-suppliers in 2009.

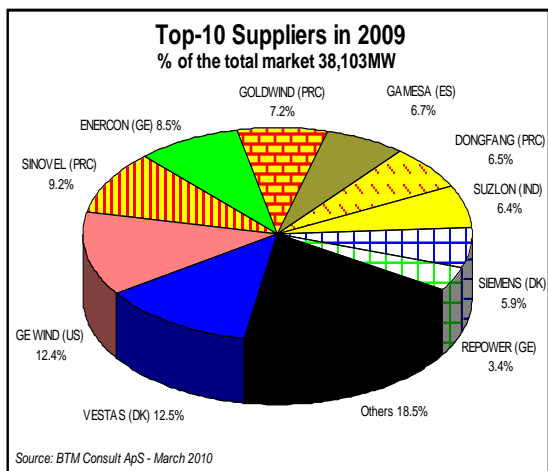

Fig. 2. Wind turbine market share distributed by manufacturers in 2009. (source: BTM Consult).

The Chinese company Simovel, the German Company Enercon and Chinese company Goldwind are in third, fourth and fifth positions, respectively. It is interesting to notice that three Chinese manufacturers are in the Top 10 and with a total share of 23.3%.

Nowadays, the most attractive concept seemed to be the variable speed wind turbine with pitch control [4]-[23]. Still some manufacturers are providing the ‘classical’ active stall, fixed speed turbines especially for countries where the grid codes do not demand dynamic reactive power control

(presently e.g. in China, parts of USA). However, recently Siemens Wind Power released a multi-megawatt class variable speed full-scale power converter (FSC) wind turbine based on the squirrel-cage induction generator. The most used generator type was the induction generator. Enercon is using the wound synchronous generator while other companies have launched new wind turbines with Permanent Magnet Synchronous Generators (PMSG). One manufacturer, the German company ENERCON, offers a gearless variable speed wind turbine. All wind turbine manufacturers are using a step-up transformer for connecting the generator to the grid. In order to get the optimum control performance, the general trend is to move from Doubly-Fed Induction Generator (DFIG) to Full-Scale Converter (FSC) wind turbines. Today the DFIG is still dominating the market but in the future FSC is expected to take over. The transition is mainly valid for larger wind turbines (3-6 MW).

### III. WIND POWER CONVERSION

Wind turbines capture power from the wind by means of aerodynamically designed blades and convert it to rotating mechanical power. As the blade tip-speed should be lower than half the speed of sound, the rotational speed will decrease as the diameter of the blade increases. For multi-MW wind turbines the rotational speed is 10-15 rpm. So far the most weight efficient way to convert the low-speed, high-torque power to electrical power is to use a gear-box and a standard “high” speed generator as illustrated in Fig. 3.

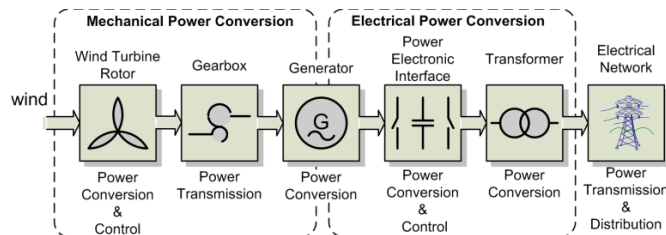

Fig. 3. Converting wind power to electrical power in a wind turbine using a gearbox and a power converter [6].

The gear-box is optional as multi-pole generator systems also are solutions. Between the grid and the generator a power converter can be inserted and it has clearly been the trend the last decade.

#### A. Basic control methods for wind turbines

The development in wind turbine systems has been steady for the last 35 years [4]-[36] where four to five generations of wind turbines have been developed and the power capacity has increased by a factor of 100. In a wind turbine it is essential to be able to control and limit the converted mechanical power at higher wind speeds, as the power in the wind is a cube of the wind speed. It is also important to maximize the energy capture from the wind below maximum power production. The power limitation is done either by Stall Control (the blade position is fixed but stall of the wind appears along the blade at higher wind speed, and it limits the power production), Active Stall Control (The blade angle is adjusted in order to create stall along the blades) or Pitch Control (here the blades are turned out of the wind at higher wind speed). The basic output characteristics of a wind

turbine using these three methods of controlling the power are summarized in Fig. 4.

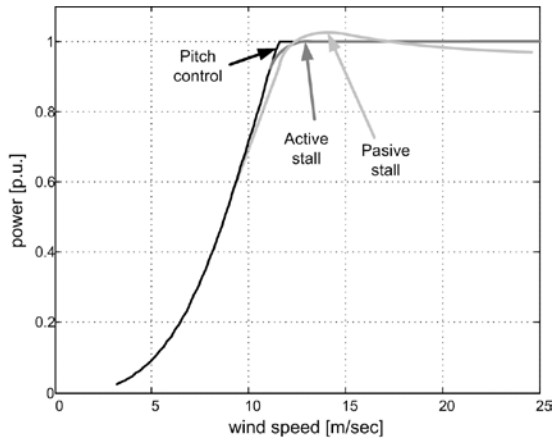

Fig. 4. Power characteristics of different wind turbine systems. Passive stall is based on fixed speed operation.

Another control variable in wind turbine system is the rotational speed. A fixed speed wind turbine has the advantages of being simple, robust, reliable, well proven and with low cost of the electrical parts. Its direct drawbacks are the uncontrollable reactive power consumption, mechanical stress during wind gusts and limited power quality control. Due to its fixed speed operation, wind speed fluctuations are converted to mechanical torque fluctuations, beneficially reduced slightly by small changes in generator slip, and then transmitted as fluctuations into electrical power to the grid.

The variable speed wind turbines are designed to achieve maximum aerodynamic efficiency over a wide range of wind speed. By introducing the variable speed operation, it is possible to continuously adapt (accelerate or decelerate) the rotational speed of the wind turbine to the wind speed, in such a way that the tip speed ratio is kept constant to a predefined value corresponding to the maximum power coefficient of the blades. In a variable speed system the generator torque is nearly kept constant, the power variations in wind being absorbed by the generator speed changes.

Seen from the wind turbine system point of view, the most important advantages of the variable speed operation compared to the conventional fixed speed operation are: reduced mechanical stress on the mechanical components such as shaft and gearbox, increased power capture and reduced acoustical noise.

Additionally, the presence of power converters in wind turbines also provides high potential control capabilities for both large modern wind turbines and wind farms to fulfill the high technical demands imposed by the grid operators such as: controllable active and reactive power (frequency and voltage control); quick response under transient and dynamic power system situations, influence on network stability and improved power quality. Those features are becoming dominant in the development of the technology.

### B. Wind Turbine Concepts

The most commonly applied wind turbine designs can be categorized into four wind turbine concepts [10], [13]. The

main differences between these concepts are in the generating system and the way in which the aerodynamic efficiency of the rotor is limited during above the rated value in order to prevent overloading.

#### 1) Fixed Speed Wind Turbines (WT Type A)

This configuration corresponds to the so called “Danish concept” that was very popular in 80’s. This wind turbine is fixed speed controlled machine, with asynchronous squirrel cage induction generator (SCIG) directly connected to the grid via a transformer as shown in Fig. 5.

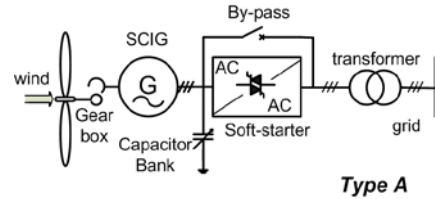

Fig. 5. Fixed speed wind turbine with directly grid connected squirrel-cage induction generator.

This concept needs a reactive power compensator (capacitor bank) to reduce (almost eliminate) the reactive power demand from the turbine generators to the grid. It is usually done by continuously switching capacitor banks following the power production variation (5-25 steps). Smoother grid connection occurs by incorporating a soft-starter as shown in Fig. 5. Regardless the aerodynamic power control principle in a fixed speed wind turbine, the wind fluctuations are converted into mechanical fluctuations and further into electrical power fluctuations. These can yield to voltage fluctuations at the point of connection in the case of a weak grid.

Thus, the main drawbacks of this concept are: it does not support any speed control and requires a stiff grid; its mechanical construction must be able to support high mechanical stress caused by wind gusts.

#### 2) Partial Variable Speed Wind Turbine with Variable Rotor Resistance (WT Type B)

This configuration corresponds to the limited variable speed controlled wind turbine with variable rotor resistance, known as OptiSlip (Vestas<sup>TM</sup>) as presented in Fig. 6.

It uses a wound rotor induction generator (WRIG) and it has been used by since the mid 1990’s.

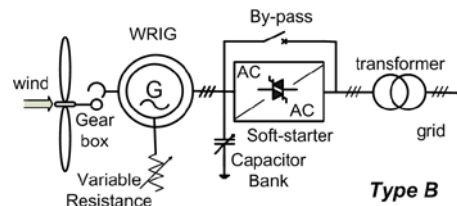

Fig. 6. Partial variable speed wind turbine with variable rotor resistance.

The generator is directly connected to the grid. The rotor winding of the generator is connected in series with a controlled resistance (variable resistance), whose size defines the range of the variable speed (typically 0-10% above synchronous speed). A capacitor bank compensates the

reactive power. Smooth grid connection occurs by means of a soft-starter. An extra resistance is added in the rotor circuit, which can be controlled by power electronics. Thus, the total rotor resistance is controllable and the slip and thus the power output in the system are controlled. The dynamic speed control range depends on the size of the variable rotor resistance. The energy coming from the external power conversion unit is dissipated as heat loss activated at full load operation.

### 3) Variable Speed WT with partial-scale frequency converter (WT Type C)

This configuration is known as the doubly-fed induction generator (DFIG) concept, which gives a variable speed controlled wind turbine with a wound rotor induction generator (WRIG) and partial power-scale frequency converter (rated to approx. 30% of nominal generator power) on the rotor circuit. The topology is shown in Fig. 7.

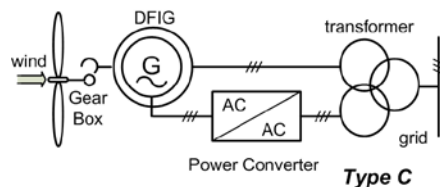

Fig. 7. Variable speed wind turbine with partial scale power converter.

The stator is directly connected to the grid, while a partial-scale power converter controls the rotor frequency and thus the rotor speed. The power rating of this partial-scale frequency converter defines the speed range (typically  $\pm 30\%$  around synchronous speed). Moreover, this converter performs the reactive power compensation and a smooth grid connection. The control range of the rotor speed is wider compared to the variable rotor resistance type. The smaller frequency converter makes this concept attractive from an economical point of view. In this case the power electronics is enabling the wind turbine to act as a more dynamic power source to the grid. However, its main drawbacks are the use of slip-rings and the protection schemes/controllability in the case of grid faults.

### 4) Variable Speed Wind Turbine with Full-scale Power Converter (WT Type D)

This configuration corresponds to the full variable speed controlled wind turbine, with the generator connected to the grid through a full-scale power converter as shown in Fig. 8.

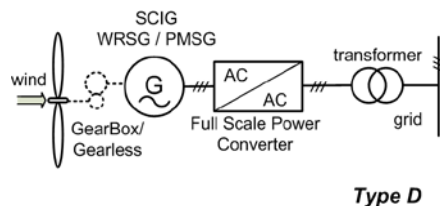

Fig. 8. Variable speed wind turbine with full-scale power converter.

The frequency converter performs the reactive power compensation and a smooth grid connection for the entire speed range. The generator can be electrically excited (wound rotor synchronous generator WRSG) or permanent magnet

excited type (permanent magnet synchronous generator PMSG). The stator windings are connected to the grid through a full-scale power converter.

Some variable speed wind turbine systems are gearless – see dotted gearbox in Fig. 8. In these cases, a heavier direct driven multi-pole generator is used. The wind turbine companies Enercon and Siemens Wind Power are examples of manufacturers using more direct drive type system.

### C. System comparison of wind turbines.

Comparing the different wind turbine topologies in respect to their performances it will reveal a contradiction between cost and performance to the grid. A technical comparison of the main wind turbine concepts, where issues on grid control, cost, maintenance, internal turbine performance is given in Table I. More details can be found in [10], [13].

TABLE I.

System comparison of wind turbine configurations.

System	Type A	Type B	Type C	Type D
Variable speed	No	No	Yes	Yes
Control active power	Limited	Limited	Yes	Yes
Control reactive power	No	No	Yes	Yes
Short circuit (fault-active)	No	No	No/Yes	Yes
Short circuit power	contribute	contribute	contribute	limit
Control bandwidth	1-10 s	100 ms	1 ms	0.5-1 ms
Standby function	No	No	Yes +	Yes ++
Flicker (sensitive)	Yes	Yes	No	No
Softstarter needed	Yes	Yes	No	No
Rolling capacity on grid	Yes, partly	Yes, partly	Yes	Yes
Reactive compensator (C)	Yes	Yes	No	No
Island operation	No	No	Yes/No	Yes
Investment	++	++	+	0
Maintenance	++	++	0	+

## IV. POWER CONVERTERS FOR WIND TURBINES

Currently, concepts Type C and Type D are dominant in the newly established wind turbines, as shown in Fig. 7 and Fig. 8. The performance of power converters plays a key role in these two wind power generation systems. Some promising power converters are shown as follows.

### A. Two-level power converter

Pulse Width Modulation-Voltage Source Converter with two-level output voltage (2L-PWM-VSC) is the most frequently used three-phase power converter topology. The knowledge available in this field is extensive and very well established. As an interface between generator and grid in the wind turbine system, two 2L-PWM-VSCs are usually configured as back-to-back structure (2L-BTB) with a transformer on the grid side, as shown in Fig. 9.

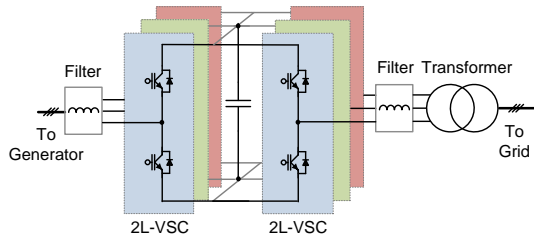

Fig. 9. Two-level back-to-back voltage source converter for wind turbines. (2L BTB)

A technical advantage of the 2L-BTB solution is the relative simpler structure and fewer components, which contributes to well-proven robust and reliable performance.

However, as fast increasing in power and voltage range of the wind turbines, 2L-BTB converter may suffer from larger switching losses and lower efficiency at Mega-Watts (MW) and Medium-Voltage (MV) power level. And the available switching devices could probably need to be paralleled or series in order to obtain the required power and voltage of wind turbines, - this will lead to reduced simplicity and reliability of the power converter [40].

Another problem in 2L-BTB solution is the two-level output voltage. The only two voltage stages introduce relative higher  $dv/dt$  stresses to the generator and transformer. Bulky output filters may be needed to limit voltage gradient and reduce the THD [37].

This topology is state-of-the-art in DFIG based wind turbines e.g. [7], [10], [13]. And several manufacturers also are using this topology for full-rating power converter wind turbines with squirrel-cage induction generator (e.g. Siemens Wind Power).

### B. Multilevel power converter

As mentioned before, power capacity of a wind turbine keeps climbing up even to 10 MW, it is more and more difficult for traditional 2L-BTB solution to achieve acceptable performances with available switching devices. With the abilities of more output voltage levels, higher voltage amplitude and larger output power, multilevel converter topologies are becoming the most popular candidates in the wind turbines application [38], [39].

Generally, multilevel converters can be classified in three categories [39]-[43]: neutral-point diode clamped structure, flying capacitor clamped structure, and cascaded converter cells structure. In order to get a cost-effective design, multilevel converters are mainly used in the 3 MW to 10 MW variable-speed full-scale power converter wind turbines. The generator can be squirrel-cage induction generator (SCIG), wound rotor synchronous generator (WRSG), or permanent magnet synchronous generator (PMSG). Several promising multilevel solutions are presented as follows.

#### 1) Three-level Neutral Point diode Clamped back-to-back topology (3L NPC-BTB)

Three-level Neutral Point diode Clamped topology is one of the most commercialized multilevel converters in the market. Similar like 2L-BTB, it is usually configured as back-

to-back structure in wind turbines, as shown in Fig. 10, which is called 3L NPC-BTB for convenience. It achieves one more output voltage level and less  $dv/dt$  stresses compared to the 2L-BTB, thus the filter size is smaller. And 3L-NPC BTB is able to output doubled voltage amplitude compared to the two-level topology by switching devices of the same voltage rating.

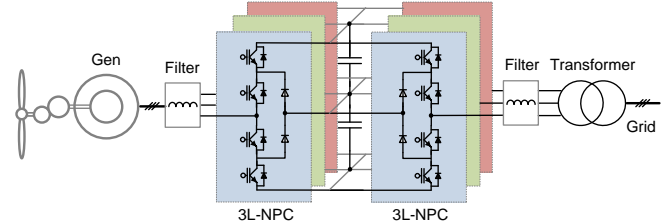

Fig. 10. Three-level Neutral Point Clamped back-to-back converter for wind turbines. (3L-NPC BTB)

The mid-point voltage fluctuation of DC bus used to be a drawback of the 3L-NPC BTB. However, this problem has been extensively researched and is considered solved by the controlling of redundant switching status [42]. However, it is found that the loss distribution is unequal between the outer and inner switching devices in a switching arm, and this problem could lead to de-rated converter power capacity when it is practically designed [42], [44].

#### 2) Three-level H-bridge back-to-back topology (3L HB-BTB)

The 3L-HB BTB solution is composed of two H-bridge converters which are configured as back-to-back structure, as shown in Fig. 11. It can achieve the similar output performance of the 3L-NPC BTB solution, but the unequal loss distribution and clamped diodes are eliminated. More efficient and equal usage of switching devices as well as higher designed power capacity could be acquired [45].

Moreover, because only half of the DC bus voltage is needed in 3L-HB BTB compared to the 3L-NPC BTB, there are less series connection capacitors and no mid-point in DC bus, the size of DC link capacitors can be further reduced.

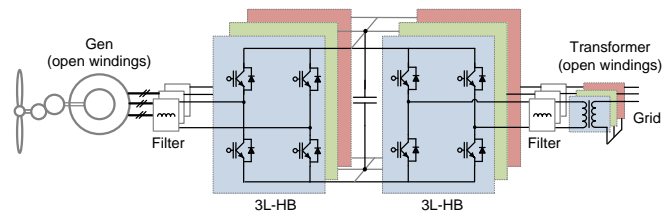

Fig. 11. Three-level H-bridge back-to-back converter for wind turbines. (3L-HB BTB)

However, 3L-HB BTB solution needs open windings structure in the generator and transformer in order to achieve isolation between each phase. This feature has both advantages and disadvantages: on one hand, open winding structure enables relative isolated operation of each phase, potential fault tolerant ability is thereby obtained if one or even two phases of the generator or the generator side converter are broken. On the other hand, open winding structure requires doubled cable length and weight in order to

connect with generator and transformer. Extra cost, loss and inductance in the cables should also be a major drawback. And the open-winding impacts on the loss/weight of generator and transformer still need to be further investigated.

4) *Five-level H-bridge back-to-back topology (5L HB-BTB)*

The 5L-HB BTB converter is composed of two back-to-back H-bridge converters making use of 3L-NPC switching arms, as shown in Fig. 12. It is an extension of 3L-HB BTB, and shares the same special requirements for open-winding generator and transformer.

With the same voltage rating switching devices, 5L-HB BTB can achieve five level output voltage, and doubled voltage amplitude compared to the 3L-HB BTB solution. These features enable smaller output filter and less current rating in the switching devices as well as in the cables [39], [46].

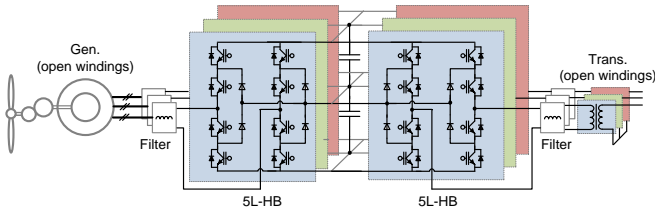

Fig. 12. Five-level H-bridge back-to-back converter for wind turbines. (5L-HB BTB)

However, compared to 3L-HB BTB, the 5L-HB BTB converter introduces more switching devices, which could reduce the reliability of total system. And the problems of unequal loss distribution as well as larger DC link capacitors unfortunately come back.

3) *Three-level Neutral Point diode Clamped topology for generator side and Five-level H-bridge topology for grid side (3L NPC + 5L HB)*

Generally, output quality requirements of grid side are much stricter than those of the generator side [36], [62]. To adapt this unsymmetrical requirements for wind power converters, this “compound” configuration employs 3L-NPC topology on the generator side, and 5L-HB topology on the grid side to achieve an unsymmetrical performances, as shown in Fig. 13.

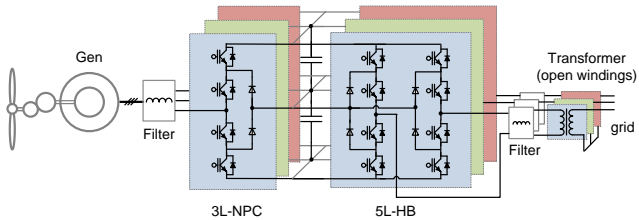

Fig. 13. Three-level Neutral Point Clamped and five-level H-bridge converter for wind turbines. (3L-NPC + 5L-HB)

On the generator side, this configuration has the similar performance of 3-NPC BTB solution. While on the grid side, it shares the same performance of 5L-HB BTB. The voltage levels and amplitude of grid side is higher than those on the generator side. It is noted that, open winding structure in

generator is avoided, cable length on the generator side is reduced to half, but the potential fault tolerant ability is also eliminated. It has less switching devices compared to 5L-HB BTB, but unequal loss distribution in the switching devices still exists.

5) *Cascaded H-bridge Back-to-back converter with Medium-Frequency-Transformers (CHB-MFT)*

Up until now, one of the most commercialized cascaded converter cells multilevel topologies is Cascaded H-Bridge (CHB) converter. Unfortunately, the CHB needs isolated DC-link for each converter cell. This characteristic may involve complex multi-pulse transformer on the generator side, resulting in larger weight and volume [39], [47].

A configuration which shares the similar idea with some of the next generation traction converters [48], [49], and European UNIFLEX-PM Project [50] is proposed in Fig. 14, whose converter cell is indicated in Fig. 15. It is based on a back-to-back Cascaded H-bridge converter structure, with galvanic insulated DC/DC converters as interface.

The DC/DC converters with medium frequency transformer (MFT) operate at several kHz to dozens of kHz, the transformer size is thereby reduced. Because of the cascaded structure, this configuration can be directly connected to the transmission power grid (10 kV-20 kV) with high output voltage quality, filter-less design, and redundancy ability [48]-[50].

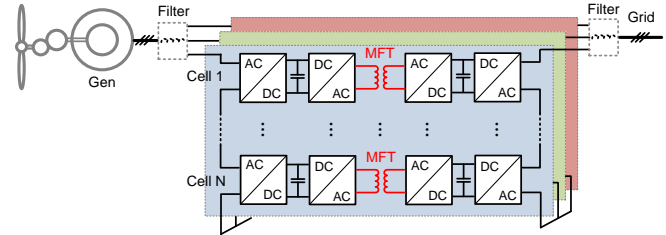

Fig. 14. Cascade H-bridge back-to-back converter for wind turbines with Medium Frequency Transformer. (CHB-MFT)

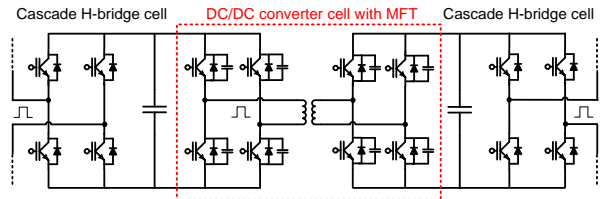

Fig. 15. Converter cell of the Cascade H-bridge back-to-back converter with Medium Frequency Transformer

However, the large amount of power semiconductors as well as auxiliary components could largely reduce this converter’s reliability and increase the cost. The total system weight and volume reduction in the wind turbine application still needs to be further investigated.

The comparisons between the six solutions for full-scale power converter wind turbines are shown in Table II, regarding the performances of output voltage levels, power semiconductor numbers, maximum output voltage amplitude, fault tolerant ability, as well as filter and transformer size.

TABLE II.

Comparisons of the multilevel solutions for wind turbines.

Configurations	2L BTB	3L-NPC B/TB	3L-HB B/TB	5L-HB B/TB	3L-NPC +5L-HB	CHB-MFT
Output voltage levels	2	3	3	5	3 / 5	2N+1 <sup>1</sup>
IGBT number <sup>2</sup>	1 pu.	2 pu.	2 pu.	4 pu.	3 pu.	4N pu.
Diode number <sup>2</sup>	1 pu.	3 pu.	2 pu.	6 pu.	4.5 pu.	4N pu.
Max output voltage <sup>2</sup>	1 pu.	2 pu.	2 pu.	4 pu.	2 / 4 pu.	2N pu. <sup>1</sup>
Fault tolerant ability	No	No	Limited <sup>3</sup>	Limited <sup>3</sup>	No	Yes
Filter size <sup>4</sup>	+++	++	++	+	++ / +	0
Transformer size <sup>4</sup>			+++			+

Note:

1. N is the cascade converter cell number.
2. Value is normalized based on 2L BTB configuration.
3. Fault tolerant ability in the grid side converter may be not allowed.
4. The more +, the larger and heavier.

### C. Unidirectional power converter solution

Nowadays there is also a trend to use the permanent magnet synchronous generator (PMSG) in the full-rated power converter wind turbines. Because there is no reactive power needed in such generator and active power flows unidirectionally from PMSG to the grid. A simple diode rectifier can be applied as the generator side converter to get a cost-effective solution. While for the grid side converter, some of the previously presented four-quadrant topologies, which will offer all the grid support features, can be directly used.

These wind turbines with PMSG can have a gearbox or they can be direct-driven [51]. In order to get variable speed operation and stable DC bus voltage, a boost DC-DC converter could be inserted in the DC-link, as shown in Fig. 16.

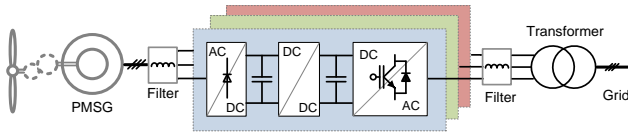

Fig. 16. Full-rated power converter wind turbine with permanent magnet generator.

## V. CONTROL OF WIND TURBINES AND GRID REQUIREMENTS

Controlling a wind turbine involves both fast and slow control dynamics [22]-[34]. Overall the power has to be controlled by means of the aerodynamic system and has to react based on a set-point given by a dispatched center or locally with the goal to maximize the power production based on the available wind power. The power controller should also be able to limit the power. An example of an overall control scheme of a wind turbine with a doubly-fed generator system is shown in Fig. 17.

Below maximum power production the wind turbine will typically vary the speed proportional with the wind speed and keep the pitch angle  $\theta$  fixed. At very low wind the turbine speed will be fixed at the maximum allowable slip in order not to have over voltage. A pitch angle controller limits the power when the turbine reaches nominal power. The generated electrical power is done by controlling the doubly-

fed induction generator through the rotor-side converter. The control of the grid-side converter is simply just keeping the dc-link voltage fixed. Internal current loops in both converters are used which typically are PI-controllers, as it is illustrated in Fig. 17. The power converters to the grid-side and the rotor-side are both voltage source converters.

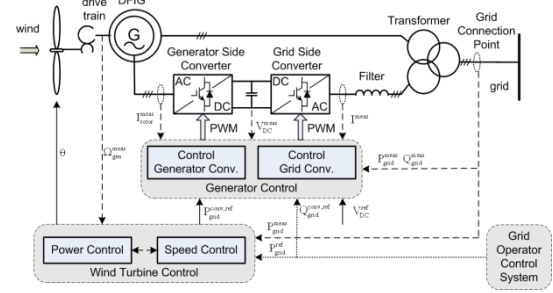

Fig. 17. Control of a wind turbine with doubly-fed induction generator (WT Type C).

Another solution for the electrical power control is to use the multi-pole synchronous generator and a full scale power converter. A passive rectifier and a boost converter can be used in order to boost the voltage at low speed. The system is industrially used today and it is shown in Fig. 18.

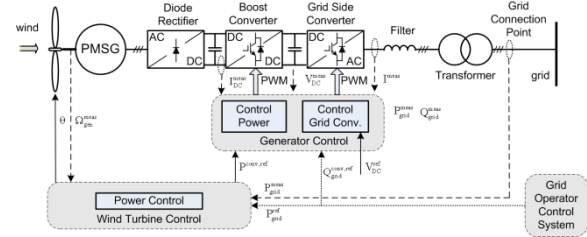

Fig. 18. Control of active and reactive power in a wind turbine with multi-pole synchronous generator (WT Type D).

A grid-side converter is interfacing the dc-link to the grid. Common for both discussed systems are that they are able to control active and reactive power to the grid with high dynamics. Another advantage of the system in Fig. 18 is that the dc-link partly is performing a decoupling between the wind turbine and the grid. The dc-link will also give an option for the wind turbine to have an added energy storage connected which can accommodate for extra active power demand (both positive and negative) from the utility side – further improving the system capabilities of the wind turbine.

Most European countries have dedicated grid codes for wind power and they are updated regularly [52]-[62]. These requirements reflect, in most of the cases, the penetration of wind power into the electrical network.

The requirements for wind power cover a wide range of voltage levels from medium voltage to very high voltage. The grid codes for wind power address also issues that make wind farms to act as a conventional power plant into the electrical network. These requirements have focus on power controllability, power quality, fault ride-through capability and grid support during network disturbances. Examples of Active and Reactive Power Control, Power Quality and Ride-Through capabilities are given.



### A) Active power control

According to most grid codes the wind turbines must be able to control the active power in the Point-of-Common-Coupling (PCC) in a given power range. The active power is typically controlled based on the system frequency e.g. Denmark, Ireland, Germany so that the power delivered to the grid is decreased when the grid frequency rise above 50 Hz. A typical characteristic for the frequency control in the Danish grid code is shown in Fig. 19.

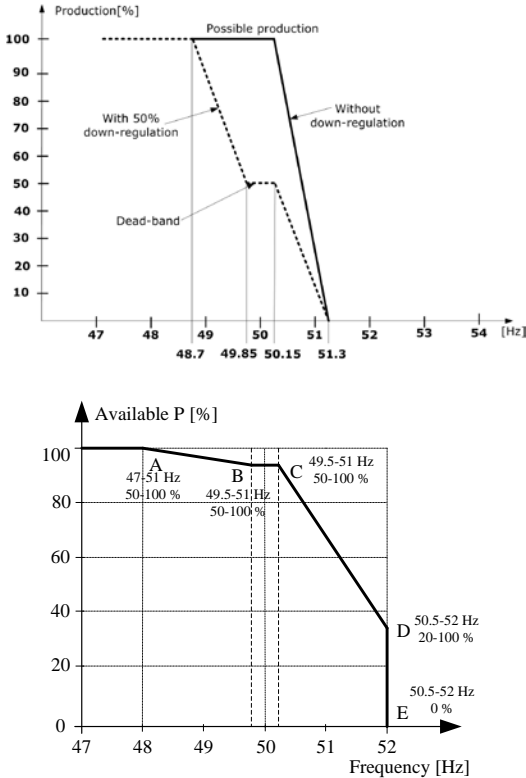

Fig. 19. Frequency control characteristic for the wind turbines connected to the Danish grid (upper) and Irish system (lower).

On the contrary other grid codes, e.g. Great Britain specifies that the active power output must be kept constant for the frequency range of 49.5 Hz to 50.5 Hz, and a drop of maximum 5% in the delivered power is allowed when the frequency drops to 47 Hz [62].

Wind farms connected at the transmission level shall act as a conventional power plant providing a wide range of controlling the output power based on Transmission System Operator's (TSO) demands and also participate in primary and secondary control. Seven regulation functions are required in the wind farm control. Among these control functions, each one is prioritized, the following can be mentioned: delta control, balance control, absolute production and system protection as illustrated in Fig. 20.

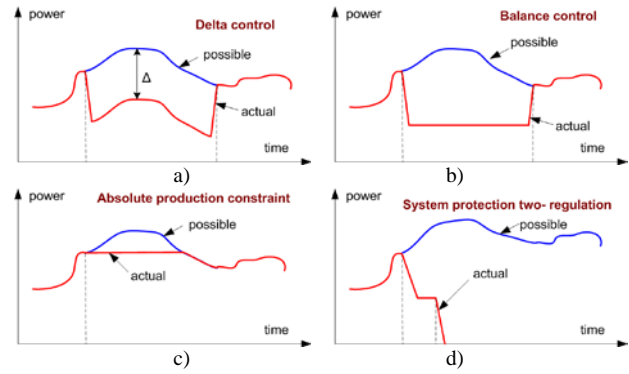

Fig. 20. Regulation functions for active power control implemented in wind farm controller required by the Danish grid codes. a) delta control, b) balance control, c) absolute production constraint and d) system protection.

### B) Reactive power control and voltage stability

Reactive power is typically controlled in a given range. The grid codes specify in different ways this control capability. The Danish grid code gives a band for controlling the reactive power based on the active power output as shown in Fig. 21.

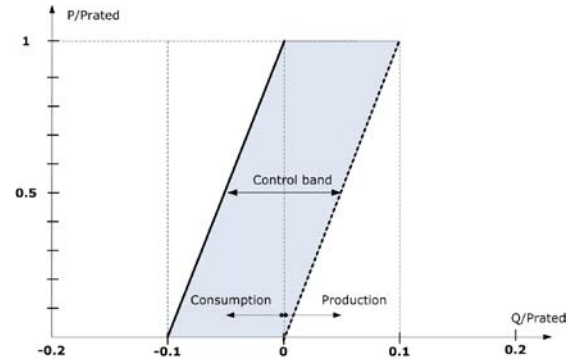

Fig. 21. Danish grid code demands for the reactive power exchange in the PCC [52], [53].

The German transmission grid code for wind power specifies that the wind power units must provide a reactive power provision in the connection point without limiting the active power output as shown in Fig. 22.

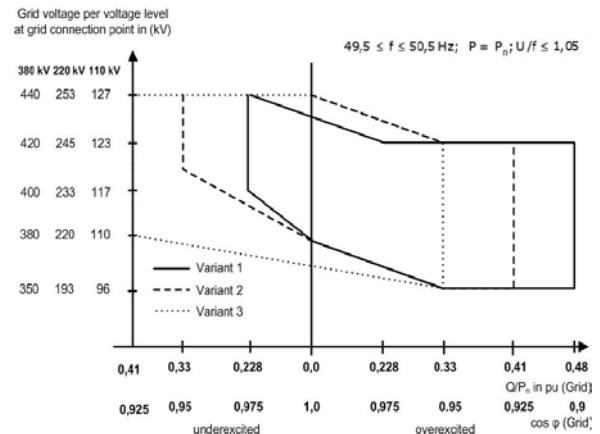

Fig. 22. Requirements for reactive power provision of generating units without limiting the active power output in the German transmission grid code [56].

As it can be noticed in Fig. 22 there are actually three possible V-Q profiles depending on the specific strength of the transmission system close to the PCC. This basic form of voltage control should be realized very slowly with a time constant in the range of two minutes [62].

### C) Power Quality

Power quality issues are addressed especially for wind turbines connected to the medium voltage networks. However, some grid codes, e.g. in Denmark and Ireland have also requirements at the transmission level.

Mainly two standards are used for defining the power quality parameters namely: IEC 61000-x-x and EN 50160. Specific values are given for fast variations in voltage, short term flicker severity, long term flicker severity and the total harmonic distortion. A schedule of individual harmonics distortion limits for voltage are also given based on standards or in some cases e.g. Denmark custom harmonic compatibility levels are defined. Inter-harmonics may also be considered.

### D) Ride through capability

All considered grid codes requires fault ride-through capabilities for wind turbines to overcome grid faults. Voltage profiles are given specifying the depth of the voltage dip and the clearance time as well. One of the problems is that the calculation of the voltage during all types of unsymmetrical faults is not very well defined in some grid codes. The voltage profile for ride-through capability can be summarized as shown in Fig. 23.

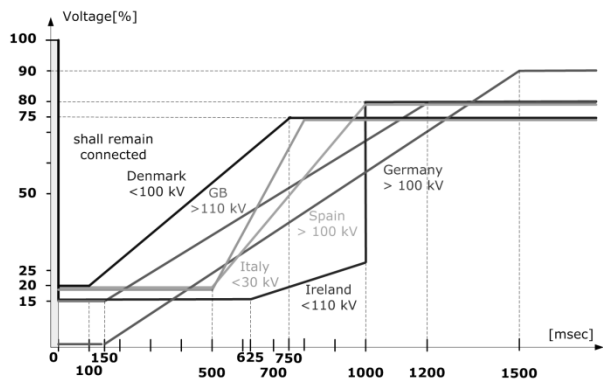

Fig. 23. Voltage profile for fault ride-through capability in European grid codes for wind power [62].

Ireland’s grid code is very demanding in respect to the fault duration while Denmark has the lowest short circuit time duration with only 100 ms. However, the grid code in Denmark requires that the wind turbine shall remain connected to the electrical network during successive faults, which is a technical challenge.

On the other hand Germany and Spain requires grid support during faults by reactive current injection up to 100% of the rated current. This is illustrated in Fig. 24.

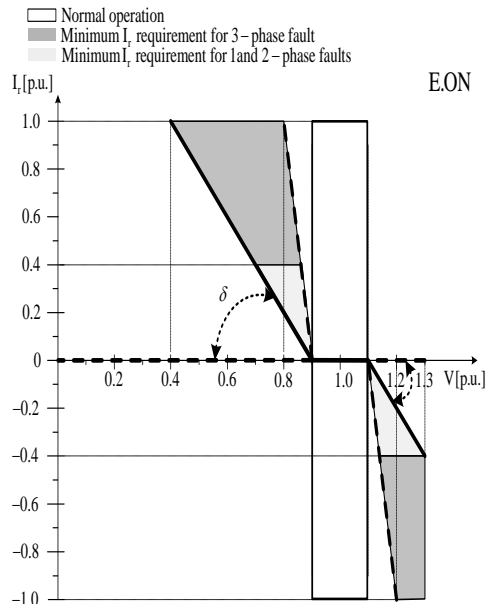

Fig. 24. Reactive current support during faults as specified in the German grid code [62].

As it can be seen in Fig. 24, the 1 pu reactive current should be injected already at 0.4 – 0.8 pu voltage. The slope should be flexible and should be decided by the TSO.

This demand is relative difficult to meet by some of the wind turbine concepts e.g. active stall wind turbine with directly grid connected squirrel cage induction generator (**WT Type A**).

The grid codes have the last ten years challenged the wind turbine technology and forced the use of power electronics. It has on one hand increased the cost pr. kWh slightly but on the other hand the technology itself is much more technical sustainable. The grid codes will also in the next years challenge the wind turbine technology which means new control concepts may still be developed. Further on – new research in the field of smart grid may even extend the demands to the wind turbine systems – they are not defined yet [2].

## VI. POWER ELECTRONICS FOR WIND FARM

Large wind farms are being developed in many countries. These wind farms may present a significant power contribution to the grids, and therefore, play an important role on the power quality and the control of power systems. Consequently, high technical demands are expected to be met by these generation units, such as to perform frequency and voltage control, regulation of active and reactive power, quick responses under power system transient and dynamic situations, for example, it may be required to reduce the power from the nominal power to 20 % power within 2 seconds. The power electronic technology is again an important part in both the system configurations and the control of the wind farms in order to fulfill these demands. Some possible electrical configurations of wind farms are shown in Fig. 25.

A wind farm equipped with power electronic converters as

shown in Fig. 25 (a), can perform both active and reactive power control and also operate the wind turbines in variable speed to maximize the captured energy as well as reduce the mechanical stress and noise. Such a system is in operation in Denmark as a 160 MW off-shore wind power station.

Fig. 25 (b) shows a wind farm with induction generators where a STATCOM can be used to provide the reactive power control to meet the system reactive power control requirements. It can help to control the voltage as well as to provide the reactive power demanded by the induction generators in the wind farm.

For long distance power transmission from an offshore wind farm, HVDC may be an interesting option. In a HVDC transmission, the low or medium ac voltage at the wind farm is converted into a high dc voltage on the transmission side and the dc power is transferred to the onshore system where the dc voltage is converted back into ac voltage as shown in Fig. 25 (d). For certain power level, a HVDC transmission system, based on voltage source converter technology, may be used in such a system instead of the conventional thyristor based HVDC technology. The topology may even be able to vary the speed on the wind turbines in the whole windfarm. Another possible dc transmission system configuration is shown in Fig. 25 (c), where each wind turbine has its own power electronic converter, so it is possible to operate each wind turbine at an individual optimal speed. A comparison of the topologies is given in Table III. As it can be seen the wind farms have interesting features in order to act as a power source to the grid. Some have better abilities than others. The overall considerations will include production, investment, maintenance and reliability.

There are also other possibilities, such as field excited synchronous machines or permanent magnet synchronous generators, can be used in the systems shown in Fig. 25 (c) or Fig. 25 (d), in the case of a multiple-pole generator, the gearbox may be removed.

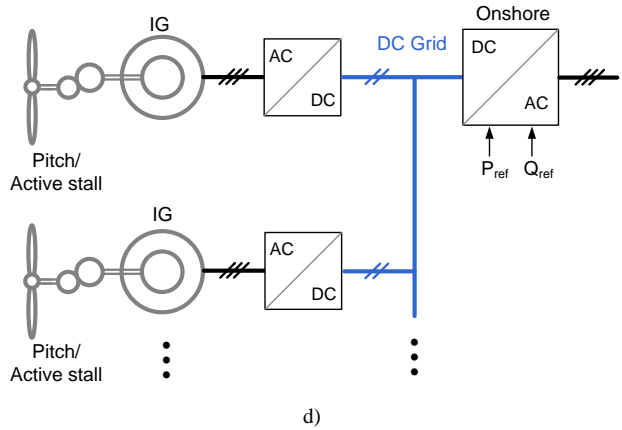
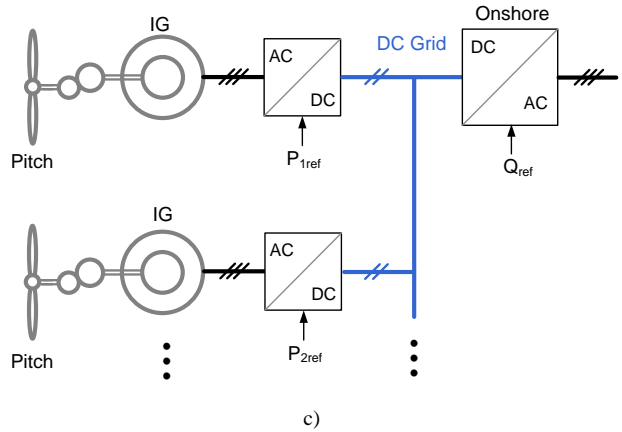
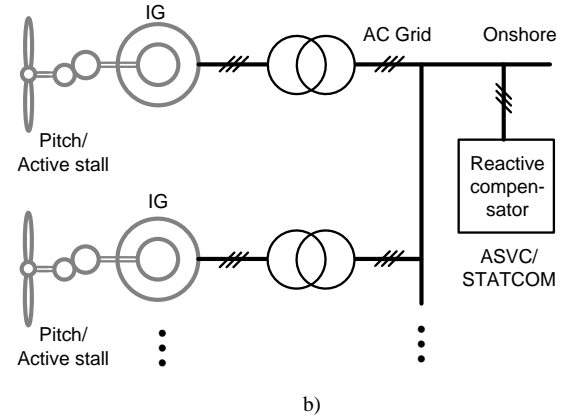
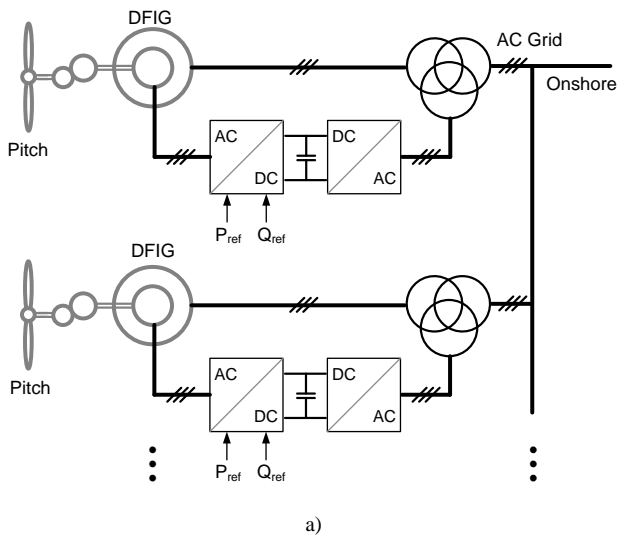

Fig. 25. Offshore wind farm configuration. a) Doubly-fed induction generator system with ac-grid (System A). b) Induction generator with ac-grid (System B). c) Speed controlled induction generator with common dc-bus and control of active and reactive power (System C). d) Speed controlled induction generator with common ac-grid and dc transmission (System D).

TABLE III. COMPARISON OF FOUR WIND FARM TOPOLOGIES

Farm configurations (Fig. 25)	A	B	C	D
Individual speed control	Yes	No	Yes	No
Control active power electronically	Yes	No	Yes	Yes
Control reactive power	Yes	Centralized	Yes	Yes
Short circuit (active)	Partly	Partly	Yes	Yes
Short circuit power	Contribute	Contribute	No	No
Standby-function	Yes	No	Yes	Yes
Soft starter needs	No	Yes	No	No
Rolling capacity on grid	Yes	Partly	Yes	Yes
Investment	+	++	+	+
Maintenance	+	++	+	+

Note: ++ is better than +

## VII. CONCLUSION

The paper discusses the applications of power electronics in wind turbines systems. The applications of power electronics in various kinds of wind turbine generation systems are illustrated showing that the wind turbine behavior/performance is significantly improved by using power electronics. Wind turbines are able to act as a contributor to the frequency and voltage control in the grid by means of active and reactive power control using power electronics.

As the power is increasing a trend is to use multilevel converter topologies and a number of them are shown in this paper. Different control methods are discussed as well as the technical grid codes. Finally, topologies for wind power plants are also shown.

## REFERENCES

- [1] S. Heier, "Grid integration of wind energy conversion systems", translated by Rachel Waddington, John Wiley, 1998. ISBN-10: 0-47-197143X.
- [2] J. M. Guerrero, F. Blaabjerg, T. Zhelev, K. Hemmes, E. Monmasson, S. Jemei, M. P. Comech, R. Granadino, J. I. Frau, "Distributed Generation: Toward a New Energy Paradigm," *IEEE Industrial Electronics Magazine*, vol.4, no.1, pp.52-64, March 2010.
- [3] Report of Danish Commission on Climate Change Policy, "Green Energy - the road to a Danish energy system without fossil fuels," September 2010. (Available: <http://www.klimakommissionen.dk/en-US/>)
- [4] A.D. Hansen, F. Iov, F. Blaabjerg, L.H. Hansen, "Review of contemporary wind turbine concepts and their market penetration", *Journal of Wind Engineering*, 28(3), 2004, pp. 247-263.
- [5] Z. Chen, E. Spooner, "Grid Power Quality with Variable-Speed Wind Turbines", *IEEE Trans. on Energy Conversion*, 2001, vol. 16, no.2, pp. 148-154.
- [6] M.P. Kazmierkowski, R. Krishnan, F. Blaabjerg, "Control in Power Electronics-Selected problems", Academic Press, 2002. ISBN 0-12-402772-5.
- [7] R. Pena, J.C. Clare, G.M. Asher, "Doubly fed induction generator using back-to-back PWM converters and its application to variable speed wind-energy generation", *IEE Trans. on Electronic Power application*, 1996, pp. 231-241.
- [8] K. Wallace, J.A. Oliver, "Variable-Speed Generation Controlled by Passive Elements", *Proc. of ICEM*, 1998, pp. 1554-1559.
- [9] J.B. Ekanayake, L. Holdsworth, W. XueGuang, N. Jenkins, "Dynamic modelling of doubly fed induction generator wind turbines", *IEEE Trans. on Power Systems*, 2003, vol. 18, no. 2, pp. 803-809.
- [10] F. Blaabjerg, Z. Chen, S.B. Kjaer, "Power Electronics as Efficient Interface in Dispersed Power Generation Systems", *IEEE Trans. on Power Electronics*, 2004, vol. 19, no. 4, pp. 1184-1194.
- [11] L. Mihet-Popa, F. Blaabjerg, I. Boldea, "Wind Turbine Generator Modeling and Simulation Where Rotational Speed is the Controlled Variable", *IEEE Transactions on Industry Applications*, 2004, vol. 40, no. 1, pp. 3-10.
- [12] N. Flourentzou, V.G. Agelidis, G.D. Demetriades, "VSC-Based HVDC Power Transmission Systems: An Overview," *IEEE Transactions on Power Electronics*, vol.24, no.3, pp.592-602, March 2009.
- [13] Z. Chen, J.M. Guerrero, F. Blaabjerg, "A Review of the State of the Art of Power Electronics for Wind Turbines," *IEEE Transactions on Power Electronics*, vol.24, no.8, pp.1859-1875, Aug. 2009.
- [14] M. Molinas, J. A. Suul, T. Undeland, "Low Voltage Ride Through of Wind Farms With Cage Generators: STATCOM Versus SVC," *IEEE Transactions on Power Electronics*, vol.23, no.3, pp.1104-1117, May 2008.
- [15] M. Zhao, Z. Chen, F. Blaabjerg, "Load flow analysis for variable speed offshore wind farms," *IET Renewable Power Generation*, vol.3, no.2, pp.120-132, June 2009.
- [16] P. Tenca, A.A. Rockhill, T.A. Lipo, P. Tricoli, "Current Source Topology for Wind Turbines With Decreased Mains Current Harmonics, Further Reducible via Functional Minimization," *IEEE Transactions on Power Electronics*, vol.23, no.3, pp.1143-1155, May 2008.
- [17] M. El Moursi, G. Joos, C. Abbey, "A Secondary Voltage Control Strategy for Transmission Level Interconnection of Wind Generation," *IEEE Transactions on Power Electronics*, vol.23, no.3, pp. 1178-1190, May 2008.
- [18] R. Li, S. Bozhko, G. Asher, "Frequency Control Design for Offshore Wind Farm Grid With LCC-HVDC Link Connection," *IEEE Transactions on Power Electronics*, vol.23, no.3, pp.1085-1092, May 2008.
- [19] Z. Chen, F. Blaabjerg, J.K. Pedersen, "Hybrid compensation arrangement in dispersed generation systems," *IEEE Transactions on Power Delivery*, vol.20, no.2, pp. 1719- 1727, April 2005.
- [20] D.S. Oliveira, M.M. Reis, C. Silva, L. B. Colado, F. Antunes, B.L. Soares, "A Three-Phase High-Frequency Semicontrolled Rectifier for PM WECS," *IEEE Transactions on Power Electronics*, vol.25, no.3, pp.677-685, March 2010.
- [21] S. Grabic, N. Celanovic, V.A. Katic, "Permanent Magnet Synchronous Generator Cascade for Wind Turbine Application," *IEEE Transactions on Power Electronics*, vol.23, no.3, pp.1136-1142, May 2008.
- [22] A. Prasai, Y. Jung-Sik, D. Divan, A. Bendre, Seung-Ki Sul, "A New Architecture for Offshore Wind Farms," *IEEE Transactions on Power Electronics*, vol.23, no.3, pp.1198-1204, May 2008.
- [23] F. Iov, P. Soerensen, A. Hansen, F. Blaabjerg, "Modelling, Analysis and Control of DC-connected Wind Farms to Grid", *International Review of Electrical Engineering*, Praise Worthy Prize, February 2006, pp.10, ISSN 1827-6600.
- [24] F.K.A Lima, A. Luna, P. Rodriguez, E. H. Watanabe, F. Blaabjerg, "Rotor Voltage Dynamics in the Doubly Fed Induction Generator During Grid Faults," *IEEE Transactions on Power Electronics*, vol.25, no.1, pp.118-130, Jan. 2010.
- [25] D. Santos-Martin, J.L. Rodriguez-Amenedo, S. Arnaltes, "Providing Ride-Through Capability to a Doubly Fed Induction Generator Under Unbalanced Voltage Dips," *IEEE Transactions on Power Electronics*, vol.24, no.7, pp.1747-1757, July 2009.
- [26] Z. Dawei, L. Xu, B.W. Williams, "Model-Based Predictive Direct Power Control of Doubly Fed Induction Generators," *IEEE Transactions on Power Electronics*, vol.25, no.2, pp.341-351, Feb. 2010.
- [27] M. S. El-Moursi, B. Bak-Jensen, M.H. Abdel-Rahman, "Novel STATCOM Controller for Mitigating SSR and Damping Power System Oscillations in a Series Compensated Wind Park," *IEEE Transactions on Power Electronics*, vol.25, no.2, pp.429-441, Feb. 2010.
- [28] J. Dai, D.D. Xu, B. Wu, "A Novel Control Scheme for Current-Source-Converter-Based PMSG Wind Energy Conversion Systems," *IEEE Transactions on Power Electronics*, vol.24, no.4, pp.963-972, April 2009.
- [29] X. Yuan, F. Wang, D. Boroyevich, Y. Li, R. Burgos, "DC-link Voltage Control of a Full Power Converter for Wind Generator Operating in

- Weak-Grid Systems," *IEEE Transactions on Power Electronics*, vol.24, no.9, pp.2178-2192, Sept. 2009.
- [30] P. Rodriguez, A. Timbus, R. Teodorescu, M. Liserre, F. Blaabjerg, "Reactive Power Control for Improving Wind Turbine System Behavior Under Grid Faults," *IEEE Transactions on Power Electronics*, vol.24, no.7, pp.1798-1801, July 2009.
- [31] F. Blaabjerg, R. Teodorescu, M. Liserre, A.V. Timbus, "Overview of Control and Grid Synchronization for Distributed Power Generation Systems," *IEEE Transactions on Industrial Electronics*, vol.53, no.5, pp.1398-1409, Oct. 2006.
- [32] A. Timbus, M. Liserre, R. Teodorescu, P. Rodriguez, F. Blaabjerg, "Evaluation of Current Controllers for Distributed Power Generation Systems," *IEEE Transactions on Power Electronics*, vol.24, no.3, pp.654-664, March 2009.
- [33] M. Liserre, F. Blaabjerg, S. Hansen, "Design and control of an LCL-filter-based three-phase active rectifier," *IEEE Transactions on Industry Applications*, vol.41, no.5, pp. 1281-1291, Sept.-Oct. 2005.
- [34] P. Rodriguez, A.V. Timbus, R. Teodorescu, M. Liserre, F. Blaabjerg, "Flexible Active Power Control of Distributed Power Generation Systems During Grid Faults," *IEEE Transactions on Industrial Electronics*, vol.54, no.5, pp.2583-2592, Oct. 2007.
- [35] L. Maharjan, S. Inoue, H. Akagi, J. Asakura, "State-of-Charge (SOC)-Balancing Control of a Battery Energy Storage System Based on a Cascade PWM Converter," *IEEE Transactions on Power Electronics*, vol.24, no.6, pp.1628-1636, June 2009.
- [36] R. Teodorescu, F. Blaabjerg, "Flexible control of small wind turbines with grid failure detection operating in stand-alone and grid-connected mode," *IEEE Transactions on Power Electronics*, vol.19, no.5, pp. 1323-1332, Sept. 2004.
- [37] F. Iov, M Ciobotaru, F. Blaabjerg, "Power Electronics Control of Wind Energy in Distributed Power System", in Proceedings of 11th International Conference on Optimization of Electrical and Electronic Equipment Optim'08, pp. 16, May 24-26, Brasov, Romania, ISBN 1-4244-1545-4.
- [38] J. M. Carrasco, L. G. Franquelo, J. T. Bialasiewicz, E. Galvan, R. Portillo, M. M. Prats, J. I. Leon, N. Moreno-Alfonso, "Power-electronic systems for the grid integration of renewable energy sources: A survey," *IEEE Transactions on Industrial Electronics*, vol. 53, pp. 1002-1016, Jun. 2006.
- [39] S. Kouro, M. Malinowski, K. Gopakumar, J. Pou, L. G. Franquelo, B. Wu, J. Rodriguez, M. A. Perez, J. I. Leon, "Recent Advances and Industrial Applications of Multilevel Converters," *IEEE Transactions on Power Electronics*, vol. 57, no. 8, pp. 2553 - 2580, 2010.
- [40] J. Rodriguez, S. Bernet, Wu Bin, J. O. Pontt, S. Kouro, "Multilevel Voltage-Source-Converter Topologies for Industrial Medium-Voltage Drives," *IEEE Transactions on Industrial Electronics*, vol. 54, no. 6, pp.2930-2945, 2007.
- [41] D. Krug, S. Bernet, S. S. Fazel, K. Jalili, M. Malinowski, "Comparison of 2.3-kV Medium-Voltage Multilevel Converters for Industrial Medium-Voltage Drives," *IEEE Transactions on Industrial Electronics*, vol. 54, no. 6, pp. 2979-2992, 2007.
- [42] J. Rodriguez, S. Bernet, P. K. Steimer, I. E. Lizama, "A Survey on Neutral-Point-Clamped Inverters," *IEEE Transactions on Industrial Electronics*, vol. 57, no. 7, pp. 2219-2230, 2010.
- [43] R. Teichmann, S. Bernet, "A comparison of three-level converters versus two-level converters for low-voltage drives, traction, and utility applications," *IEEE Transactions on Industry Applications*, vol. 41, no.3, pp. 855-865, 2005.
- [44] T. Bruckner, S. Bernet, H. Guldner, "The active NPC converter and its loss-balancing control," *IEEE Transactions on Industrial Electronics*, vol. 52, no. 3, pp.855-868, 2005.
- [45] O. S. Senturk, L. Helle, S. Munk-Nielsen, P. Rodriguez, R. Teodorescu, "Medium voltage three-level converters for the grid connection of a multi-MW wind turbine," in *Proc. EPE*, pp: 1- 8, 2009.
- [46] H. Hosoda, S. Peak, "Multi-level converters for large capacity motor drive," in *Proc. IECON*, pp. 516-522, 2010.
- [47] M. Malinowski, K. Gopakumar, J. Rodriguez, M. A. Pérez, "A Survey on Cascaded Multilevel Inverters," *IEEE Transactions on Industrial Electronics*, vol. 57, no. 7, pp. 2197-2206, 2010.
- [48] B. Engel, M. Victor, G. Bachmann, and A. Falk, "15 kV/16.7 Hz energy supply system with medium frequency transformer and 6.5 kV IGBTs in resonant operation," in *Proc. EPE*, Toulouse, France, Sep. 2-4, 2003.
- [49] S. Inoue, H. Akagi, "A Bidirectional Isolated DC-DC Converter as a Core Circuit of the Next-Generation Medium-Voltage Power Conversion System," *IEEE Transactions on Power Electronics*, vol.22, no. 2, pp. 535-542, 2007.
- [50] F. Iov, F. Blaabjerg, J. Clare, O. Wheeler, A. Rufer, A. Hyde, "UNIFLEX-PM-A Key-Enabling Technology for Future European Electricity Networks," *EPE Journal*, vol. 19, no. 4, pp.6-16, 2009.
- [51] M.R. Dubois, H. Polinder, J.A. Ferreira. "Comparison of Generator Topologies for Direct-Drive Wind Turbines", Proceedings of IEEE Nordic Workshop on Power and Industrial Electronics (Norpie 2000), Aalborg, Denmark, pp. 22-26.
- [52] EnergiNet – Grid connection of wind turbines to networks with voltages below 100 kV, Regulation TF 3.2.6, May 2004, pp. 29.
- [53] Energinet - Grid connection of wind turbines to networks with voltages above 100 kV, Regulation TF 3.2.5, December 2004, pp. 25.
- [54] ESB Networks – Distribution Code, version 1.4, February 2005.
- [55] CER – Wind Farm Transmission Grid Code Provisions, July 2004.
- [56] E.ON-Netz – Grid Code. High and extra high voltage, April 2006.
- [57] VDN – Transmission Code 2003. Network and System Rules of the German Transmission System Operators, August 2003.
- [58] VDN – Distribution Code 2003. Rules on access to distribution networks, August 2003.
- [59] REE – Requisitos de respuesta frente a huecos de tension de las instalaciones de produccion de regimen especial, PO 12.3, November 2005.
- [60] ENEL – DK 5400 - Criteri di allacciamento di clienti alla rete AT della distribuzione, October 2004.
- [61] ENEL – DK 5740 - Criteri di allacciamento di impianti di produzione alla rete MT di ENEL distribuzione, February 2005.
- [62] M. Altin, O. Goksu, R. Teodorescu, P. Rodriguez, B. Bak-Jensen, L. Helle, "Overview of recent grid codes for wind power integration," *Proc. of OPTIM'2010*, pp.1152-1160, 2010.