



AALBORG UNIVERSITY
DENMARK

Aalborg Universitet

Back-to-Back Energization of a 60kV Cable Network - Inrush Currents Phenomenon

Faria da Silva, Filipe; Bak, Claus Leth; Hansen, M. Lind

Published in:

Proceedings of the Power and Energy Society General Meeting 2010

DOI (link to publication from Publisher):

[10.1109/PES.2010.5589314](https://doi.org/10.1109/PES.2010.5589314)

Publication date:

2010

Document Version

Accepted author manuscript, peer reviewed version

[Link to publication from Aalborg University](#)

Citation for published version (APA):

Faria da Silva, F., Bak, C. L., & Hansen, M. L. (2010). Back-to-Back Energization of a 60kV Cable Network - Inrush Currents Phenomenon. In *Proceedings of the Power and Energy Society General Meeting 2010* (pp. 1-6). IEEE Press. <https://doi.org/10.1109/PES.2010.5589314>

General rights

Copyright and moral rights for the publications made accessible in the public portal are retained by the authors and/or other copyright owners and it is a condition of accessing publications that users recognise and abide by the legal requirements associated with these rights.

- ? Users may download and print one copy of any publication from the public portal for the purpose of private study or research.
- ? You may not further distribute the material or use it for any profit-making activity or commercial gain
- ? You may freely distribute the URL identifying the publication in the public portal ?

Take down policy

If you believe that this document breaches copyright please contact us at vbn@aub.aau.dk providing details, and we will remove access to the work immediately and investigate your claim.

Back-to-Back Energization of a 60kV Cable Network - Inrush Currents Phenomenon

F. Faria da Silva, Claus L. Bak, M. Lind Hansen

Abstract—On November 2008 the Danish government decided that all Danish transmission lines with a rated voltage equal to and below 150kV must be put underground, in order to reduce the visual pollution caused by Overhead Lines.

This decision will lead to a massive use of underground cables in the Danish Network, and force a change in the approach used until now when planning, analyzing and operating electrical power systems.

One problem that might arise is the energization of cables in parallel, as this operation may originate high inrush currents, which represent a risk to the circuit breakers connected to the cables.

The Danish utility ENV plans to install a new cable on its 60kV network, which will be installed in parallel with other cables already installed in the network.

This paper summarizes the study made to calculate the inrush currents during the cable's energization, and its importance to the purchase of a new circuit breaker for the cable. A theoretical background of this phenomenon is also presented

I. INTRODUCTION

THE increasing use of underground cables in electrical power systems, is making more relevant some problems that were uncommon before. One of these problems is the appearing of inrush currents during the energization of cables in parallel. If not attended this situation can lead to the deterioration of the cable and endangerment of the circuit breaker.

Electrically, cables are mainly capacitive elements, so the energization of a cable, when connected to an already energized one, can be seen as being similar to the energization of capacitor banks in parallel. When energizing a capacitor bank that is in parallel with an already energized capacitor bank there will be an inrush current whose amplitude depends of the voltage in the connection moment, and can go up to 100pu [1] or even 200pu [2].

ENV (Elforsyningen Nordvendssyssel), utility company in charge of electrical distribution in the north part of Denmark, plans to install a new 9.33km long, 72.5kV line on its network. Due to political decisions this line has to be an

underground cable [3][4]. This cable will be connected to a busbar at which are already connected several long cables, as it is shown in Fig. 1 and Fig. 2, so it is advisable to study the system and verify the amplitude and frequency of the inrush currents during the cable's energization.

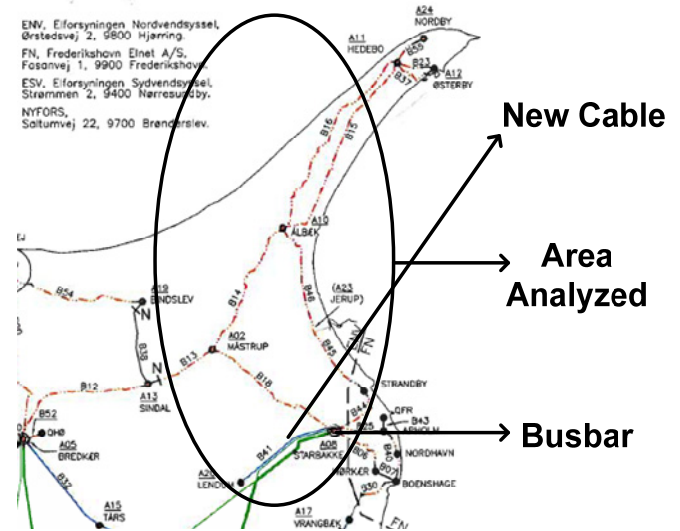

Fig. 1. ENV 60kV Network map

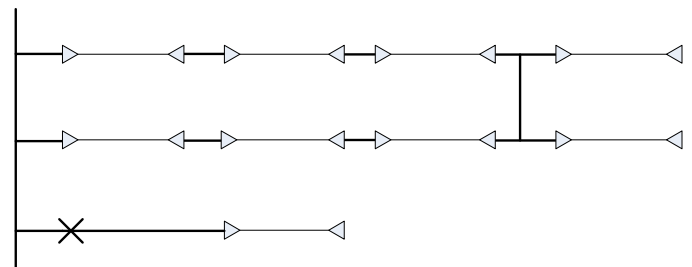

Fig. 2. Single Line Diagram of the analyzed area

The knowledge of this data is required to choose the adequate circuit breaker, as the IEC standard for AC Circuit Breakers defines limits for the maximum frequency and maximum peak value of an inrush current [5][6].

II. CIRCUIT BREAKERS IN CABLE NETWORKS

According to IEC 62271-100 “High Voltage alternating current circuit breakers” 2nd edition [5] circuit breakers have to fulfill requirements regarding back-to-back capacitor inrush making currents. As the switching on of cables in an already energized cable network can be considered similar to back-to-back capacitor inrush making phenomena, further analysis of

This work was supported by ENV: Elforsyningen Nordvendssyssel
 F. F. da Silva is a PhD student at the Institute of Energy Technology, Aalborg University, 9220 Aalborg, Denmark (e-mail: ff@iet.aau.dk).
 C. L. Bak is with the Institute of Energy Technology, Aalborg University, 9220 Aalborg, Denmark (e-mail: clb@iet.aau.dk).
 M. Lind Hansen is with ENV, 9800 Hjørring, Denmark (e-mail: mlh@env.dk).

inrush phenomena under such conditions is justified.

Circuit breakers have rated values for back-to-back capacitor bank inrush making current. For all voltage levels these values are $I_{bi}=20\text{kA}$ peak and $f_{bi}=4250\text{Hz}$, where I_{bi} designates maximum peak value and f_{bi} maximum frequency of the inrush current transient.

According to the IEC standard 1st edition [6], the product of I_{bi} and f_{bi} for certain conditions were not to exceed the product of $I_{bi,N}$ and $f_{bi,N}$ ($20\text{kA}\cdot 4250\text{Hz}=85\cdot 10^6\text{A/s}$). This paragraph has been removed from the IEC standard 2nd edition [5]. But regarding the making in cable networks, it seems justified to do the judging of circuit breaker suitability using this concept.

For the purchase of the circuit breaker there were arranged meetings with Siemens Schaltwerk, Berlin. During one of the meetings, experts have provided the following explanation to the fact that making of back-to-back capacitor alike networks can be a problem for circuit breakers. Most circuit breakers for lower HV levels (as in this case 72,5 kV) are of the selfblast type utilizing internal arc heating to provide the energy to blast short circuit currents, as can be verified in Fig. 3.

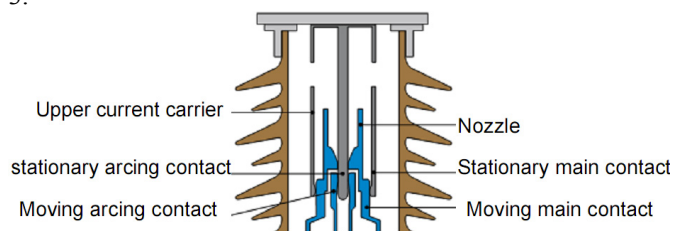

Fig. 3. Selfblast type Circuit Breaker

During closing a prestrike will emerge between arcing contacts before they make mechanical contact. When switching back-to-back capacitor banks this prestrike is followed by the inrush current transient, both with a high peak value and frequency. This will give rise to a degradation of the arcing contacts reducing their lifetime and increasing the need of more often monitoring and maintenance. This degradation also exists during normal makings, but under such normal conditions inrush current peak value and frequency are less severe, and therefore the arcing contacts are subjected to a lower stress.

The high frequency of the inrush current displaces the current in the stationary arcing contact towards the surface (skin effect) in such a way that the wear of the contact is more concentrated to the surface region of the contact than for 50 Hz currents, which gives a more even wear of the stationary arcing contact. So due to the inrush currents the stationary arcing contact is worn to a cone-like shape by the back-to-back capacitor switching, whereas in normal condition switching it merely is worn to a hemispherical shape. The cone like wear will in time give rise to prestrikes between main contacts instead of the arcing contacts. This will damage the main contacts and lead to the circuit breaker malfunction.

It can be concluded that, when in presence of inrush currents circuit breakers can be expected to suffer from

shortening of arcing contact lifetime if the making conditions are more severe than stated in the IEC 62271-100 standard, paragraph 4.107.6 regarding rated back-to-back capacitor bank inrush making current.

III. CABLE ENERGIZATION

A. Single Cable Energization

The energization of a cable can origin a transitory overvoltage, which amplitude depends of the moment in which the cable is connected. If the circuit breaker is closed when the voltage at its terminals is zero the overvoltage is minimum, ideally zero, but if the connection is made for a peak voltage, the overvoltage is maximum.

The reason for this difference is the charging of the cable's capacitance and the energy oscillation between the cable's capacitance and inductance. To better understand this phenomenon it will be explained using a simple LC series circuit, as the one shown in Fig. 4, whose simulation's plot is shown in Fig. 5.

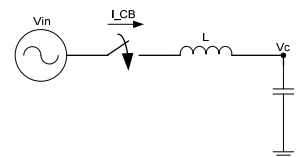

Fig. 4. LC circuit

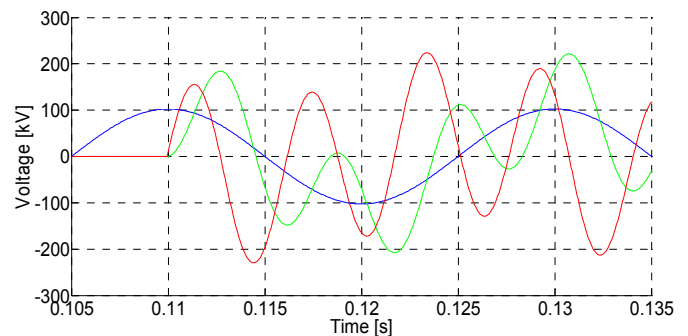

Fig. 5. Voltages and current (current not at scale) for Fig. 4 circuit when connected at peak voltage. (Blue: V_{in} , Green: V_c , Red: I_{CB})

In this system, initially both capacitor and inductor have no energy, but as the voltage in the capacitor (V_c) has to be continuous, when the circuit breaker closes for a voltage value that is not zero, the capacitor has to be charged through the inductor, initiating a transient with the system natural frequency. After a very short moment the voltage in the capacitor is equal to the source voltage, but when this moment is reached the current in the inductor is at a peak value (see Fig. 5) and by energy conservation it can not become zero immediately. Thus the voltage in the capacitor continues to increase becoming larger than the source voltage while the current decreases to zero, when the current makes to zero V_c reaches a peak value and the capacitor starts to discharge [7].

As the system has no resistance this transient is not damped, and the oscillatory behaviour continues with one difference. Due to the fact that source is sinusoidal, for each transient cycle at system natural frequency, V_c will match the source

voltage at different points, and thus the amplitude of V_c is different for each cycle, as the zero voltage for the capacitor terminals, is constantly changing.

A cable can be seen as an infinite group of RLC circuits in series, so a cable energization is similar to the energization of an LC circuit, with the difference of damping due to resistance and that the waves are not perfectly sinusoidal because of the distortion originated by the series of RLC circuits.

B. Cables in parallel

When a cable is connected in parallel with an already energized cable, there is an energy transfer from the energized cable to the cable that is being connected, which results in an inrush current whose amplitude depends of the voltage at the connection instant, the larger the voltage the larger the inrush current's peak value.

A cable can be modeled as series of RLC circuits like is shown in Fig. 6. As the cable's inductance and resistance are very small the series of "capacitors" on the two cables will be almost in parallel. When in parallel, capacitors should have the same voltage, so part of the charge on the "capacitors" of the energized cable will transfer almost immediately for the "capacitors" of the cable being connected, originating an inrush current.

This shift of the "capacitor's" charge from one cable to the other is shown in Fig. 6. When the circuit breaker is closed the energy stored in the cable already energized is transferred to the cable being energized, as indicated by the arrows in Fig. 6.

The inrush currents will not be as high as the ones obtained when energizing capacitor banks in parallel, due to the cables' resistance and inductance, which limits the transient and damps it faster.

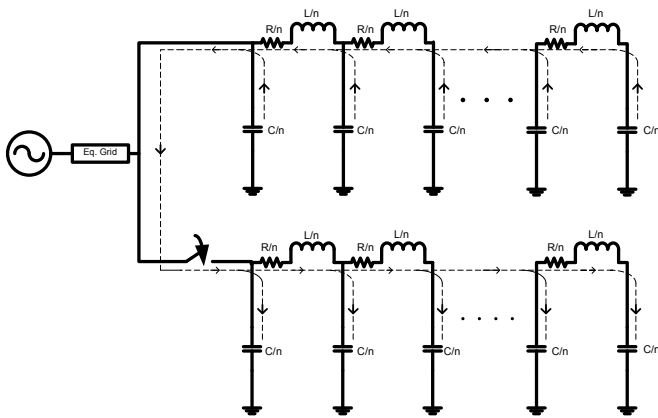

Fig. 6. Cable's energization equivalent circuit

To demonstrate this phenomenon the energization of two equal 40km, 72.5kV cables will be simulated, the cables' datasheet can be consulted in [8]. The cables are connected in parallel, and in order to reduce the grid influence its short-circuit power is low (a 0.4367Ω resistance and a 31.416Ω reactance), this way there is a larger interaction between the two cables and a smaller one with the grid (system's single line diagram on Fig. 5).

To perform the simulation is used PSCAD/EMTDC being

the cables modeled by a frequency dependent phase model, which is at the present the most accurate method of simulating a cable [9].

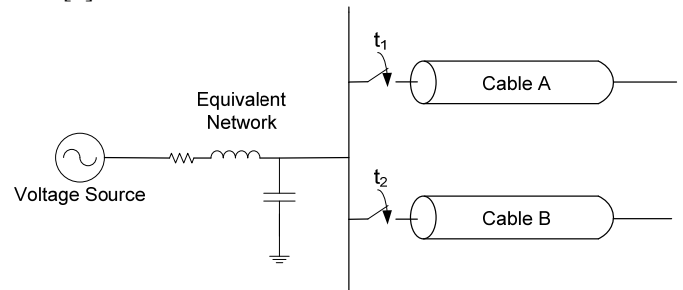

Fig. 7. Energization of a cable in parallel with an already energized cable ($t_2 \gg t_1$)

The simulation results are presented in Fig. 8 and Fig. 9. Fig. 8 shows the current on the sending end for the energization of cable A at t_1 , with cable B not connected to the busbar. This situation is similar to the one explained in the previous sub-section, and as can be noticed the current maximum value is around 700A.

At t_2 , after cable A have reached steady-state conditions, cable B is energized. The currents in both cables during the energization of cable B are shown in Fig. 9.

As can be noticed during the first 0.3ms the currents are almost symmetrical, meaning that the current being injected in cable B is coming from cable A. It should be observed that when energizing a cable in parallel with an already energized cable, the frequency and the currents reach higher peak values that for the energization of a single cable, the current's amplitude is 1kA when for energization of a single cable it did not pass the 700A, an increase of 43%.

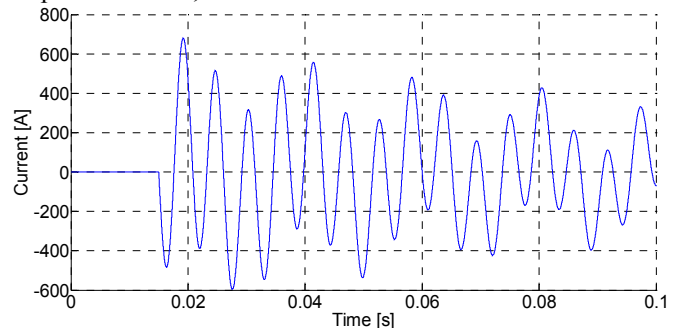

Fig. 8. Current on Cable A sending end during the energization its energization

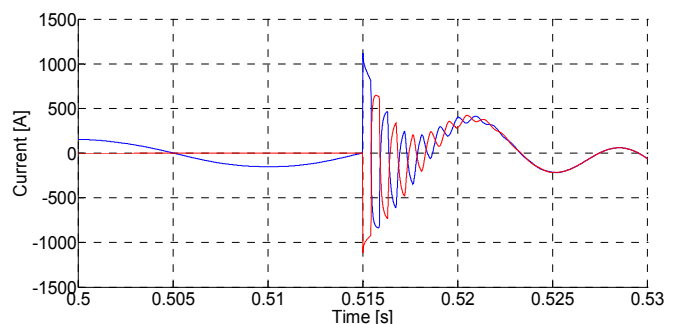

Fig. 9. Currents on the sending ends of Cable A and Cable B during the energization of Cable B (Blue: Cable A; Red: Cable B)

IV. ENV 60kV NETWORK CHARACTERIZATION

The system under analysis (presented in Fig. 1) is compounded by 9 different cables, whose information is provided in Table 1, the cables' datasheet can be found in [8].

The single line diagram of the system is shown on Fig. 10, the cable to be connected is B41, which will be energized with the rest of the network already in steady-state conditions.

The circuit breaker closes the three phases at the same time and there is no synchronization of the closing instant. Thus, the transients will not be equal in all the phases, and it is not possible to choose a connection moment that reduces the overvoltage and inrush currents, i.e. there is no synchronized switching.

TABLE 1 - CABLES ON THE NETWORK

Cable code	Type	Length [km]
B18	400mm ² PEX-M-AL-LT 72kV	13.360
B14	400mm ² PEX-M-AL-LT 72kV	11.940
B16	400mm ² PEX-M-AL-LT 72kV	18.934
B15	400mm ² PEX-M-AL-LT 72kV	18.511
B45/46	240mm ² PEX-M-AL-LT 72kV	16.000
B44	240mm ² PEX-M-AL-LT 72kV	4.600
B37	150mm ² PEX-CU	3.150
B55	400mm ² PEX-M-AL-LT 72kV	2.209
B41	800mm ² PEX-M-AL-LT 72kV	9.330

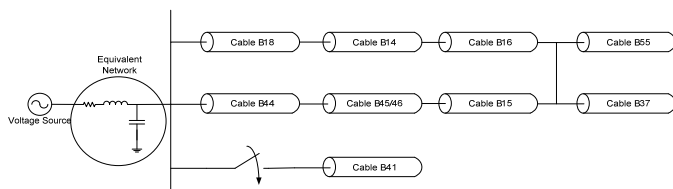

Fig. 10. Single line diagram of the simulated network

V. SIMULATIONS

To ease the understanding of this phenomenon it will be simulated for two different situations: Busbar connected to an ideal voltage source or connected to an equivalent network with a 765MVA short-circuit power.

In all the simulations the cables are modeled using a frequency-dependable phase model, being the software used PSCAD/EMTDC.

A. Cable connected to an Ideal Voltage Source

The connection of the busbar to an ideal voltage source makes it easier to understand the energization of cable B41. On this situation there are no differences between having and not having the remaining cables connected, as the voltage on the cable's sending end will always be the one of the voltage source, i.e. sinusoidal.

The worse case scenario, connection at peak voltage in one of the phases (phase A), was simulated. The simulation results are presented in Fig. 11 and Fig. 12, and it was obtained a peak voltage around 114kV, a peak current of around 3100A

for a transient inrush current frequency of 5kHz.

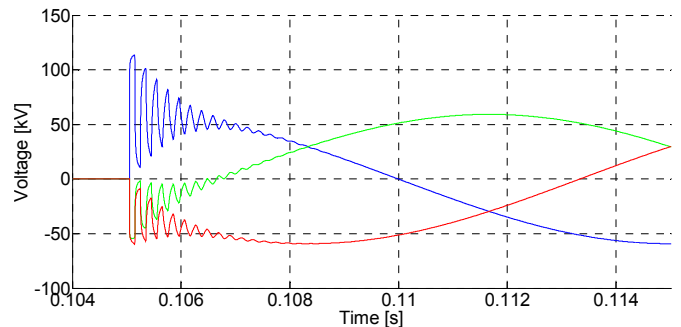

Fig. 11. Voltage in cable B41 open end during its energization using an ideal voltage source (Blue: Phase A, Green: Phase B, Red: Phase C)

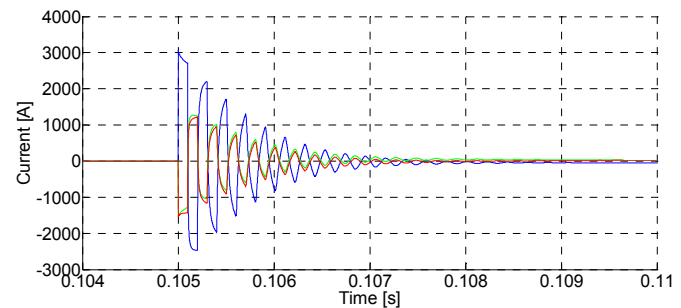

Fig. 12. Current into cable B41 during its energization using an ideal voltage source (Blue: Phase A, Green: Phase B, Red: Phase C)

B. Cable connected to an Equivalent Grid

The use of an ideal voltage source is useful to understand how the cable would behave in ideal conditions or when connected to a very strong node, but it does not provide accurate results for the network under analysis.

The grid short-circuit power is 765MVA, for the X/R ratio is considered a typical value of 13 [10]. Using these values for a 66kV network is obtained a resistance of 0.4376Ω and a reactance of 5.565Ω, for the capacitance it is used a standard value of 2nF [11].

The simulation were made for the worst case scenario, connection with peak voltage in one of the phases (phase A), and the plots are shown in Fig. 13 and Fig. 14.

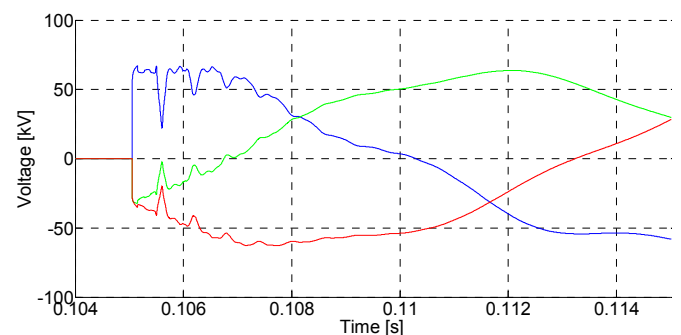

Fig. 13. Voltage in the open end of cable B41 during its energization using an equivalent network (Blue: Phase A, Green: Phase B, Red: Phase C)

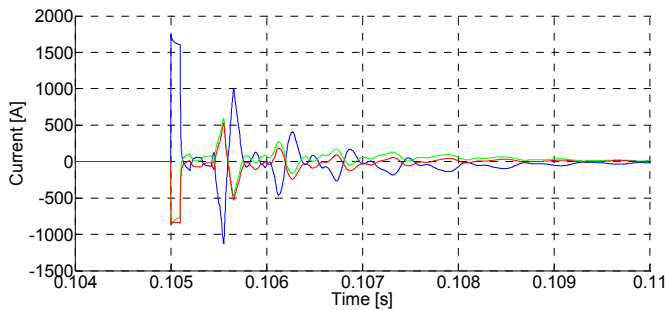

Fig. 14. Current in cable B41 during its energization using an equivalent network (Blue: Phase A, Green: Phase B, Red: Phase C)

Analyzing Fig. 13 and Fig. 14 it is noticed, as expected, that because of the interaction between the cables and the equivalent grid inductance, both voltage and currents are more distorted when the cable is connected to an equivalent grid than when the cable was energized from an ideal voltage source, compare respectively Fig. 13 and Fig. 14 with Fig. 11 and Fig. 12.

In Fig. 14 the current's transient inrush frequency continues to be 5kHz, but its amplitude reaches a peak value of only 1750A, a value inferior to the one obtained when the cable was energized from an ideal voltage source.

Apparently this result goes against the theory presented before, as it was expected an increase of the current peak value. The reason for this discrepancy is the use of the equivalent grid, which reduces the current's peak value during the transient.

In Fig. 15 are presented the currents during the energization of cable B41 when connected to the equivalent grid described before, but being the other cables disconnected from the network. On these conditions the current peak value is around 700A, a value inferior to the 1750A obtained when energizing the cable in parallel with other cables, what proves the theory explained before.

Another difference that can be noticed between the energization of cables in parallel and the one of a single cable, is a reduction of the transient's frequency. As there is no longer an inrush current from one cable to the other the frequency decreases from 5kHz to approximately 720Hz, as can be verified comparing Fig. 15 with Fig. 14.

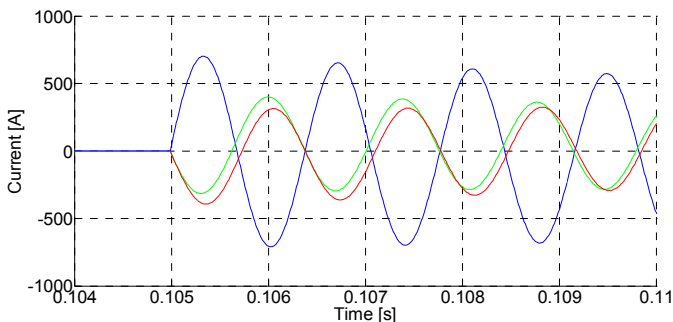

Fig. 15. Current in cable B41 during its energization when connected to an equivalent network, but with the other network cables disconnected (Blue: Phase A, Green: Phase B, Red: Phase C)

VI. CONCLUSION

To the purchase of the circuit breaker necessary for the new cable, ENV consulted the IEC standard regarding AC Circuit Breakers [6]. According to this standard a capacitor bank making performance is covered when the product of the required peak inrush current times the required frequency of the inrush current ($i_{\max \text{ peak}} \times f_{\text{inrush}}$) is equal or lower to $85 \times 10^6 \text{ A.Hz}$.

For the simulation using an ideal voltage source, the peak inrush current is 3100A and its frequency is 5kHz. Multiplying the two values is obtained $15.5 \times 10^6 \text{ A.Hz}$, a value 5.5 times inferior to the allowed maximum.

When using the equivalent network, the value of the peak inrush current is 1750A and the inrush current frequency is 5kHz. Multiplying both values is obtained $8.75 \times 10^6 \text{ A.Hz}$, value about 10 times inferior to the allowed maximum.

Therefore it can be concluded that for the present system the connection of cable B41 do not present any hazards for the circuit breaker, even when it is connected in parallel with already energized cables.

The simulations were all made considering the worst case scenario, connection of the cable with maximum voltage in one of the phases. The use of synchronized switching is enough to completely eliminate this phenomenon, as all the phases are connected for zero voltage and no overvoltage and overcurrents would occur.

VII. FUTURE WORK

The authors are finishing a paper with a more comprehensive theoretical background of this phenomenon, as well as a more detailed explanation of when the energization of cables in parallel may represent a hazard to the network.

VIII. ACKNOWLEDGE

The authors gratefully acknowledge ENV for all the support and data.

IX. REFERENCES

- [1] *IEEE Guide for the Protection of Shunt Capacitor Banks*, IEEE Standard C37.99-2000, 2000
- [2] C. D. Tsirekis, N. D. Hatzigryriou, "Control of Shunt Capacitors and Shunt Reactors Energization Transients", IPST 2003
- [3] Energinet.dk, "Kabelhandlingsplan 132-150kV", 2009 (in Danish)
- [4] ELINFRASTRUKTURUDVALGET, "Technical Report on the future expansion and undergrounding of the electricity transmission grid", 2008
- [5] IEC 62271-100 (2009) "High-Voltage switchgear and control gear - Part 100: Alternating-current circuit-breakers"
- [6] IEC 62271-100 (2001) "High-Voltage switchgear and control gear - Part 100: Alternating-current circuit-breakers"
- [7] Alan Greenwood, "Electric Transients in Power Systems", John Wiley & Sons, 1st Edition, 1971
- [8] 60-500kV High voltage Underground Power Cables: XLPE Insulated Cables, Nexans
- [9] B. Gustavsen, A. Morched, M. Tartibi, "A universal model for accurate calculation of electromagnetic transients on overhead lines and underground cables," IEEE Transactions on Power Delivery, 14(3), p.1032–1038, July 1999
- [10] Richard Roepfer, "Short-circuit current in Three-phases Systems", John Wiley & Sons, 2nd edition, 1985

- [11] ABB, "Zinc oxide surge arrester - Application guidelines for station protection", 2nd edition, 1995

X. BIOGRAPHIES

Filipe Faria da Silva was born in Portugal in 1985 and received his M.S.E. in Electrical and Computers Engineering in 2008 from Instituto Superior Técnico (IST), Portugal.

He is currently working for the Danish TSO (Energinet.dk) and doing a PhD in the Institute of Energy Technology of Aalborg University, where he studies High-Voltage Transmissions Systems with Underground Cables.

Claus Leth Bak was born in Århus in Denmark, on April 13, 1965. He graduated from High School in Århus and studied at the Engineering College in Århus, where he received the B.Sc. with honors in Electrical Power Engineering in 1992. He pursued the M.Sc. in Electrical Power Engineering with specialization in High Voltage Engineering at the Institute of Energy Technology (IET) at Aalborg University (AAU), which he received in 1994. After his studies he worked with Electric power transmission and substations with specializations within the area of power system protection at the NV Net transmission company. In 1999 he got employed as an assistant professor at IET-AAU, where he is holding an associate professor position today. His main research areas include corona phenomena on overhead lines, power system transient simulations and power system protection. He is the author/coauthor of app. 30 publications and IEEE Senior Member.

Magnus Lind Hansen Was born in Odense in Denmark in 1971. He graduated from Technical High School in Odense. After being educated as an electrician he studied at the University of Southern Denmark, where he received the B. Sc. with honours in Electrical Engineering in 2000. He worked with process control systems in the Danish offshore sector for the company ABB. In the year 2002 he was employed at the power plant Nordjyllandsværket where he worked with project management and operation and maintenance for the company Elsam and later Vattenfall. Currently he is employed at ENV Net A/S, working with project management and operation and maintenance of the 60kV grid in the northern part of Denmark.