



**AALBORG UNIVERSITY**  
DENMARK

**Aalborg Universitet**

## **High and Low Reynolds number Measurements in a Room with an Impinging Isothermal Jet**

Skovgaard , M.; Hyldgaard, C. E. ; Nielsen, Peter V.

*Publication date:*  
1990

*Document Version*  
Publisher's PDF, also known as Version of record

[Link to publication from Aalborg University](#)

*Citation for published version (APA):*  
Skovgaard , M., Hyldgaard, C. E., & Nielsen, P. V. (1990). *High and Low Reynolds number Measurements in a Room with an Impinging Isothermal Jet*. Dept. of Building Technology and Structural Engineering. Indoor Environmental Technology Vol. R9003 No. 12

### **General rights**

Copyright and moral rights for the publications made accessible in the public portal are retained by the authors and/or other copyright owners and it is a condition of accessing publications that users recognise and abide by the legal requirements associated with these rights.

- ? Users may download and print one copy of any publication from the public portal for the purpose of private study or research.
- ? You may not further distribute the material or use it for any profit-making activity or commercial gain
- ? You may freely distribute the URL identifying the publication in the public portal ?

### **Take down policy**

If you believe that this document breaches copyright please contact us at [vbn@aub.aau.dk](mailto:vbn@aub.aau.dk) providing details, and we will remove access to the work immediately and investigate your claim.

---

**INSTITUTTET FOR BYGNINGSTEKNIK**  
DEPT. OF BUILDING TECHNOLOGY AND STRUCTURAL ENGINEERING  
AALBORG UNIVERSITETSCENTER • AUC • AALBORG • DANMARK

---

INDOOR ENVIRONMENTAL TECHNOLOGY

PAPER NO. 12

Presented at ROOMVENT '90, International Conference on Engineering  
Aero- and Thermodynamics of Ventilated Rooms, Oslo, June 1990

---

M. SKOVGAARD, C. E. HYLDGAARD & P. V. NIELSEN  
HIGH AND LOW REYNOLDS NUMBER MEASUREMENTS IN A  
ROOM WITH AN IMPINGING ISOTHERMAL JET  
DECEMBER 1990

---

ISSN 0902-7513 R9003

---

The papers on INDOOR ENVIRONMENTAL TECHNOLOGY are issued for early dissemination of research results from the Indoor Environmental Technology Group at the University of Aalborg. These papers are generally submitted to scientific meetings, conferences or journals and should therefore not be widely distributed. Whenever possible reference should be given to the final publications (proceedings, journals, etc.) and not to the paper in this series.

---

**INSTITUTTET FOR BYGNINGSTEKNIK**  
DEPT. OF BUILDING TECHNOLOGY AND STRUCTURAL ENGINEERING  
AALBORG UNIVERSITETSCENTER • AUC • AALBORG • DANMARK

---

**INDOOR ENVIRONMENTAL TECHNOLOGY**

**PAPER NO. 12**

**Presented at ROOMVENT '90, International Conference on Engineering  
Aero- and Thermodynamics of Ventilated Rooms, Oslo, June 1990**

---

**M. SKOVGAARD, C. E. HYLDGAARD & P. V. NIELSEN**  
**HIGH AND LOW REYNOLDS NUMBER MEASUREMENTS IN A**  
**ROOM WITH AN IMPINGING ISOTHERMAL JET**  
**DECEMBER 1990** **ISSN 0902-7513 R9003**

---





# HIGH AND LOW REYNOLDS NUMBER MEASUREMENTS IN A ROOM WITH AN IMPINGING ISOTHERMAL JET

M. Skovgaard, C. E. Hyldgaard, and P. V. Nielsen  
University of Aalborg  
Aalborg, Denmark

## SUMMARY

The present paper, which is within the work of the IEA - annex 20, presents a series of full-scale velocity measurements in a room with isothermal mixing ventilation. The measurements are in the Reynolds number range 1000 - 7000 based on inlet dimensions. This means that a transition from laminar to turbulent flow is occurring. The measurements which have been carried out are: measurements of the change in effective inlet area, wall jet measurements (both Cartesian and radial approach), measurements of mean velocities and rms values in the occupied zone and measurements of low Reynolds' number effects. Further, all measurements are made at different air change rates. The velocity profiles have been normalized and it has been analysed if the measured velocity distribution can be represented as a wall jet. An extensive analysis of the low Reynolds number phenomenon is made.

## NOMENCLATURE

a	Area.	[m <sup>2</sup> ]
c	Constant for determination of velocity in the occupied zone.	
D <sub>a</sub>	Constant in growth of jet width.	
f <sub>1</sub>	Function for determination of velocity in occupied zone. (f <sub>1</sub> = u <sub>rm</sub> /u <sub>L</sub> ).	
K	Function in the radial wall jet decay.	
K <sub>a</sub>	Constant in the decay of a wall jet.	
K <sub>1</sub>	Function in the decay of a radial impinging jet.	
L	Length of the room.	[m]
n	Air change rate.	[1/h]
r	Radius.	[m]
Re	Reynolds' number.	
u	Velocity.	[m/s]
x	Distance from inlet wall.	[m]
x <sub>0</sub>	Distance to virtual origin.	[m]
y	Distance from floor.	[m]

## Subscripts:

d	Diameter of nozzle in the inlet device.
L	Distance L from inlet wall
o	Inlet, effective.
rm	Maximum in the occupied zone.
r	Maximum in radial direction.
x	Maximum in x - direction.

Greek:

$\alpha$	Slope in double logarithmic coordinate system	
$\phi$	Angle in the (x,y) - plane.	[°]
$\theta$	Angle in the radial direction.	[°]
$\delta$	Width of wall jet.	[m]
$\gamma$	Kinematic viscosity.	[m <sup>2</sup> /s]

## 1. INTRODUCTION

Calculation and dimensioning of mixing ventilation systems are traditionally made by a number of simplified models, *Nielsen* [1]. The models are based on the theory of the three-dimensional wall jet because large parts of the air distribution often can be described by this type of flow. Measurement has been made by different authors and additional measurements are reported in this paper. In the simplified models the throw and penetration depth of the jet are the important parameters for determination of the maximum velocity in the occupied zone.

The decay of the center line velocity in a three-dimensional jet is given by *Nielsen* [1], [13]

$$\frac{u_x}{u_0} = K_a \frac{\sqrt{a_0}}{x+x_0} \quad (1)$$

and the maximum velocity in the occupied zone is also given by *Nielsen* [1] for three-dimensional flow and in [9] for two-dimensional flow. For three-dimensional flow:

$$u_{rm} = u_0 f_1 K_a \frac{\sqrt{a_0}}{L+x_0} \quad (2)$$

It is possible to incorporate a possible Reynolds number effect in this model by taking the change in  $a_0$ ,  $K_a$  and  $f_1$  into account. This is not done in most cases but it will be seen that the variation in e.g.  $a_0$  can be quite significant. Equation (1) can be used for values in the mean plane. The flow outside the symmetry plane will often have some radial components. This can be described as done by *Beltaos* [2]. The inlet flow is regarded as a radial impinging jet and *Beltaos* [2] found the following expression

$$\frac{u_r}{u_0} = K_1(\phi, \theta) \frac{d}{r} \quad (3)$$

$$K_1(\phi, \theta) = \frac{1.1 (1 + \cos\phi \sin\theta)}{\sqrt{\sin\phi} \left( \cos^2\theta + \left( \frac{\sin\theta}{\cos\phi} \right)^2 \right)} \quad (4)$$

In order to incorporate the virtual origin and the effective inlet area the following approach is used

$$\frac{u_r}{u_0} = K(\phi, \theta) \frac{\sqrt{a_0}}{r+x_0} \quad (5)$$

The three-dimensional wall jet eq. (1) is identical to the radial approach for  $\theta = 0$  and constant  $\phi$ .

An alternative and rather new approach for determination of the velocity field in a ventilated room is by solving the governing equations which in the isothermal case are the 3 Navier - Stokes equations, the continuity eq. and a turbulence model for closure where the  $k, \epsilon$  - model is the most commonly used (see e.g. *Gosman et. al.* [11]), even though other higher order models seem more promising for recirculating flow (see e.g. *Benocci et. al.* [12]).

The method requires knowledge of the boundary conditions. Because of the very complicated inlet geometry which will require too high a discretization for practical use empirical investigations are still of highest importance. Another important problem of this method is the lack of ability to predict low Reynolds' number effects which has been noticed e.g. by *Nielsen et. al.* [4] or *Murakami et. al.* [8] and being elaborated in this paper. The promising thing about this method is the fact that it is able to predict a very detailed flow pattern in complex geometries and, therefore, a powerful design tool.

## 2. EXPERIMENTAL SETUP

The test room is shown in fig. 1. The inlet device is of the HESCO - type (KS4W205K370) where the flow can be adjusted to any kind of three-dimensional flow structure (see ref. [13]). This feature is typical for modern inlet device design. The diffuser consists of 4 rows with 21 nozzles which independently can be adjusted to different directions. For this purpose all the nozzles have been adjusted to an angle of  $\phi = 40^\circ$  (fig. 2). The purpose of this paper is to give a general idea of the flow field in a room with a mixing type of ventilation, to present measurements which can evaluate the "simplified model" approach (*P.V. Nielsen*, [1]), to evaluate a new kind of simplified approach for description of the flow field by means of an impinging turbulent jet (*S. Beltaos*, [2]) and to evaluate and detect the isothermal flow dependence on the Reynolds number (the low Reynolds number effects) which has also been pointed out in *P.V. Nielsen and Å.T.A. Möller* [3], [4].



The general flow field was established by smoke experiments. To fulfil the main goals velocity measurements had to be carried out in the center line of the room, in the lower part of the room (the occupied zone) and at different locations of a semicircle around the inlet device. All measurements were performed at different air change rates. The measuring locations are listed in fig 3. Ball probes (Dantec 54N10) were used for measurements below the ceiling and hot wire (Disa 56N24) for measurements in the occupied zone.

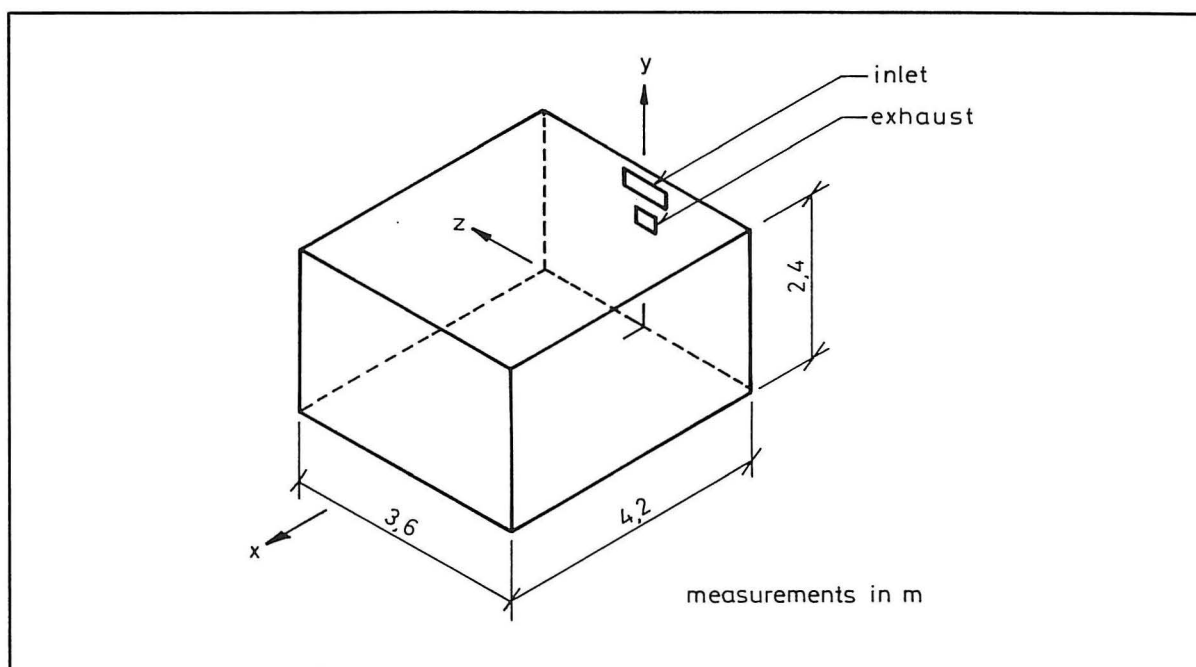

Figure 1: Sketch of the full-scale test room facility.

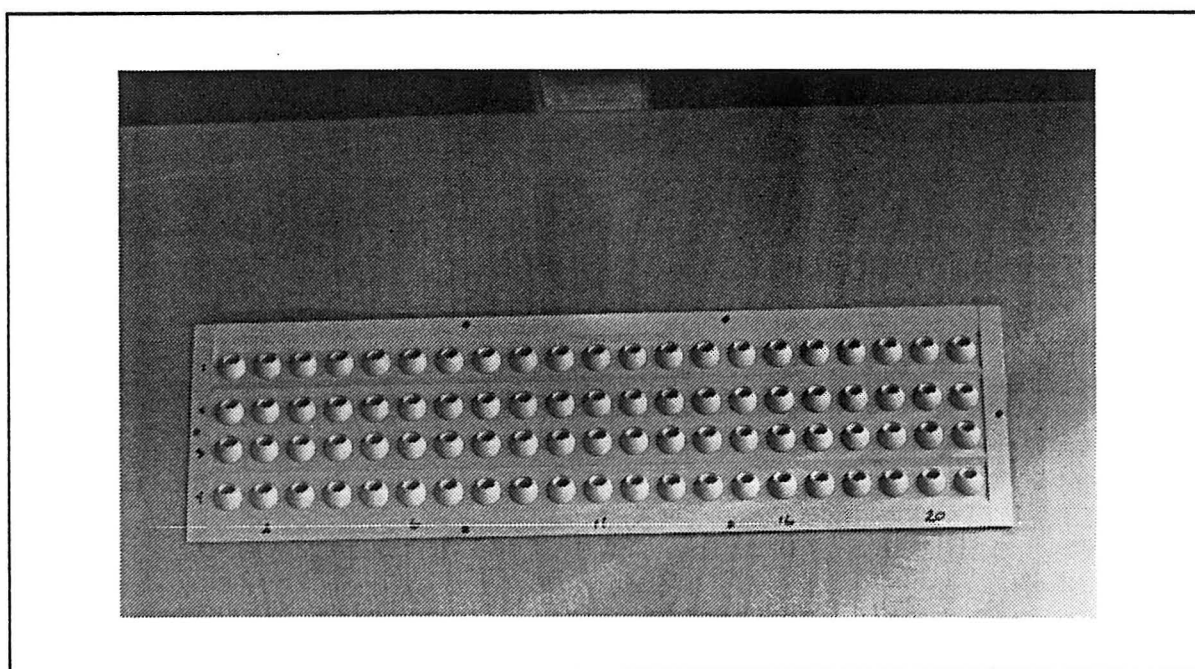

Figure 2: Close-up of the HESCO inlet device. The diffuser consists of 4 rows with 21 independently adjustable nozzles.

x [m]	y*) [m]	z [m]	num. of measur.	air change rates [1/h]	int. time [s]	ref
0.6	2.365- 1.575	0.0	80	1,2,3,4,6,8	90	1
1.4	2.365- 1.575	0.0	80	1,2,3,4,6,8	90	2
2.2	2.365- 1.575	0.0	80	1,2,3,4,6,8	90	3
3.0	2.365- 1.575	0.0	80	1,2,3,4,6,8	90	4
4.0	2.365- 1.575	0.0	80	1,2,3,4,6,8	90	5
0.71	2.365- 1.575	-0.71	80	1,2,3,4,6,8	90	6
1.0	2.365- 1.575	0.0	80	1,2,3,4,6,8	90	7
0.71	2.365- 1.575	0.71	80	1,2,3,4,6,8	90	8
1.06	2.365- 1.575	-1.06	80	1,2,3,4,6,8	90	9
1.5	2.365- 1.575	0.0	80	1,2,3,4,6,8	90	10
1.06	2.365- 1.575	1.06	80	1,2,3,4,6,8	90	11
3.6		0.0	23	1,1.5,2,3,4 6,7,8	960	12
3.0		0.0	23	1,1.5,2,3,4 6,7,8	960	13
2.4		0.0	23	1,2,3,4,5, 6,7,8	960	14
1.8		0.0	23	1,2,3,4,5, 6,7,8	960	15
1.2		0.0	23	1,2,3,4,5, 6,7,8	960	16

\*) The upper bound of the y coordinate includes the location of the maximum velocity.

Figure 3: Data from the measurement sequence.  $Re = (\sqrt{a_0}u_0)/\nu = [7500..57000]$  or  $(du_0)/\nu = [1000..7000]$ .

### 3. ANALYSIS AND RESULTS

The measurements of the effective inlet area,  $a_0$ , were performed at 10 different locations (10 different nozzles) spread over the diffuser area in the Reynolds number range 625-9700. The results are depicted in fig. 4.

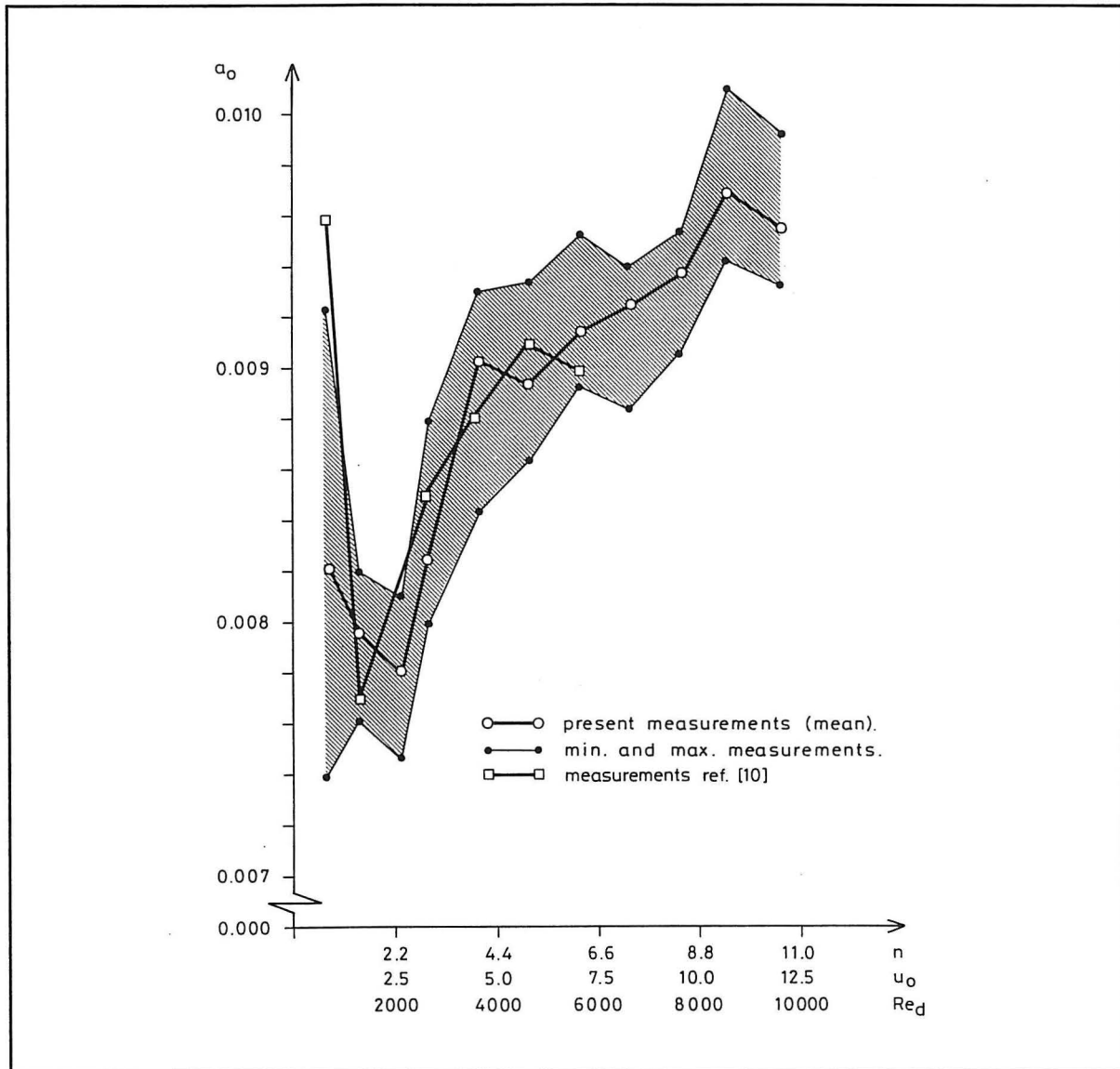

Figure 4: The effective inlet area as a function of the inlet velocity.

As it can be seen the  $a_0$  area is not a constant but an increasing function in the Reynolds number due to the transition from laminar to turbulent flow through the nozzles. The curve has a minimum which is referring to the transition point. This transition is at  $Re_d$  equal to 2000 which corresponds to the assumed critical  $Re$  for a tube. The large  $a_0$  value for  $n = 0.5 \text{ h}^{-1}$  may be explained by asymmetric flow in the opening or by geometrical effects within the diffuser.

For the total flow in the room the essence of fig. 4 is very important. It means that the flow even though it is turbulent has a dependency of the supply velocity which can be

interpreted as an initial laminar effect. This means that a precise calculation of the flow field is a very difficult task (*Murakami et. al.* [8]). The measured velocity profiles close to the ceiling are shown in fig. 5 for the plane  $z = 0.0$  at different  $x$  locations (ref. 1, 2, 3, 4, 5 in fig. 3). The profiles have a self similar form for the different supply velocities and the decay is very close to the decay of a universal wall jet. This fact is the reason why the traditional "simplified model" approach has been extensively used for designing inlet devices for mixing jet ventilation systems (see next paragraph).

### 3.1 Analysis related to the wall jet approach

The velocity distribution in front of the diffuser has a self similar profile at different air change rates which is typical for a wall jet. Another typical characteristic for the turbulent wall jet is the width  $\delta$  which is proportional to the distance from a virtual origin (*Rajaratnam* [5]). For the  $xy$  plane the following relation is valid.

$$\delta = D_a(x+x_0) \quad (6)$$

From fig. 6 it is seen that  $D_a$  is found to be 0.08 and  $x_0$  is 0.45 m.

*Rajaratnam and Pani* [5], [6] found the value of  $D_a$  to be 0.09 - 0.1 and the virtual origin was located 20 times the height of the inlet height behind the inlet in the  $xy$  - plane in the case of a bluff wall jet.

In the case of a radial impinging jet *Beltaos* [2] found an average value of  $D_a$  equal to 0.079. This indicates that the approach with modelling the inlet conditions by means of a radial jet so far seems to be promising.

### 3.2. Analysis related to the "simplified model"

In the simplified model approach the determination of the  $K_a$ -value and the linearity of the velocity in a point as a function of air change rate are essential assumptions. If we assume that equation (1) is valid, which means that we a priori neglect the initial low Reynolds number effect due to the transition of the flow through the nozzles, we can expect that  $u_x/u_0$  as a function of  $(x+x_0)/\sqrt{a_0}$  will be a straight line in a logarithmic coordinate system with the slope -1. Fig. 7 shows that the slope is near -0.5 which is typical of the decay of the center line velocity in a two-dimensional jet. Then a region follows where the decay of the velocity is near the decay of a three-dimensional wall jet (*Trentacoste and Sforza* [7]). Near the end wall the decay of the velocity is increasing due to the geometrical extension of the room.

Fig. 8 shows the maximum velocity at 5 different  $yz$ -planes (ref. 1, 2, 3, 4, 5 in fig. 3) as a function of the air change rate. The figure shows the effect from the inlet device very clearly since the maximum velocity is larger than expected for low air change rates with fully developed turbulence. If one follows the development of the maximum velocity for air change rates 1 and 2  $h^{-1}$  one can see that it is decaying faster than expected. This

means that there is an additional effect which contributes to the decay of the velocity in the low Reynolds number area.

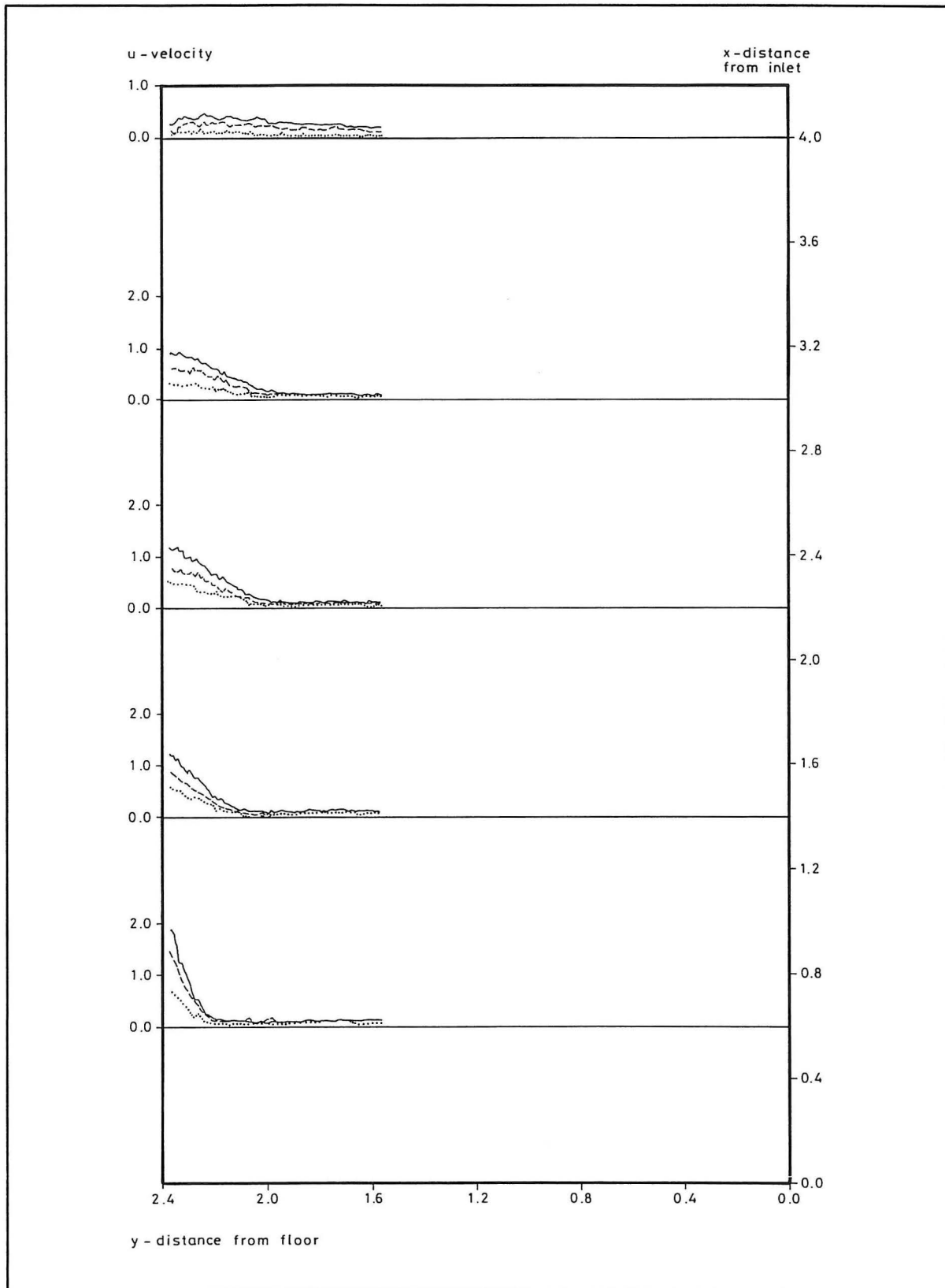

Fig. 5: Measured velocities in the  $z = 0.0$  plane for different downstream locations in the parabolic flow region. Absolute velocity profiles for  $n = 2, 4, 6$  1/h.



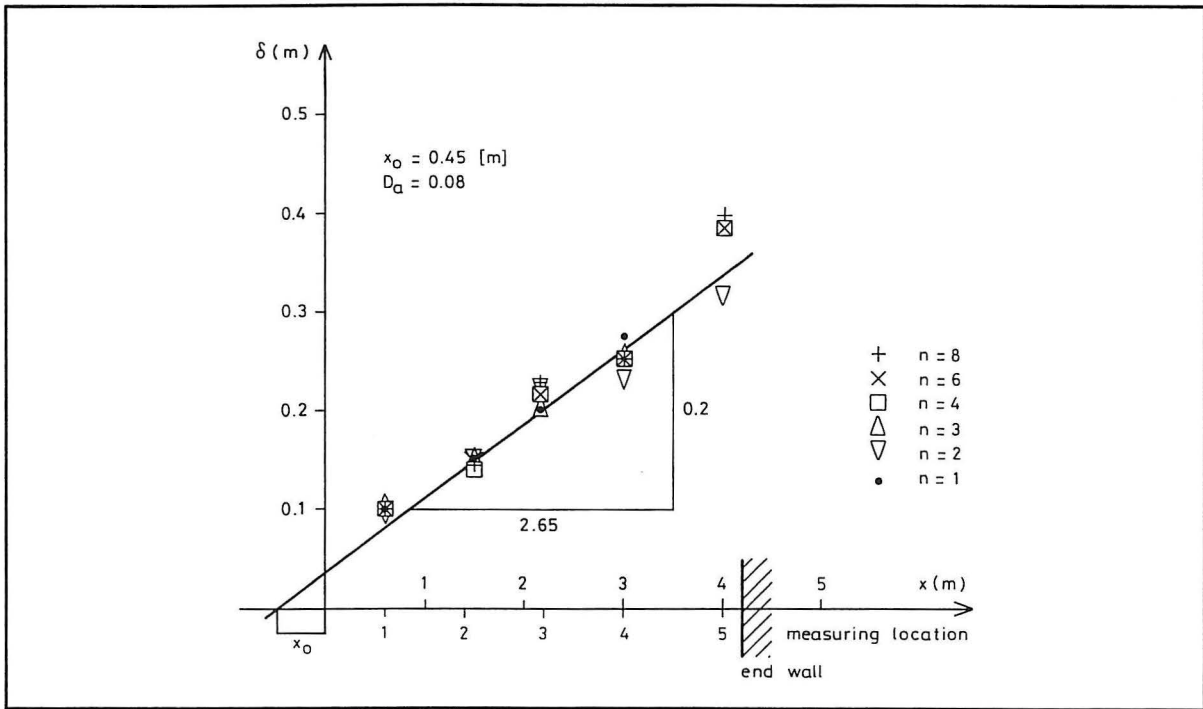

Fig. 6: The width  $\delta$  in the  $xy$  - plane as a function of  $x$ .  $D_a$  is found to be 0.08 and  $x_0$  is found to be 0.45 m.

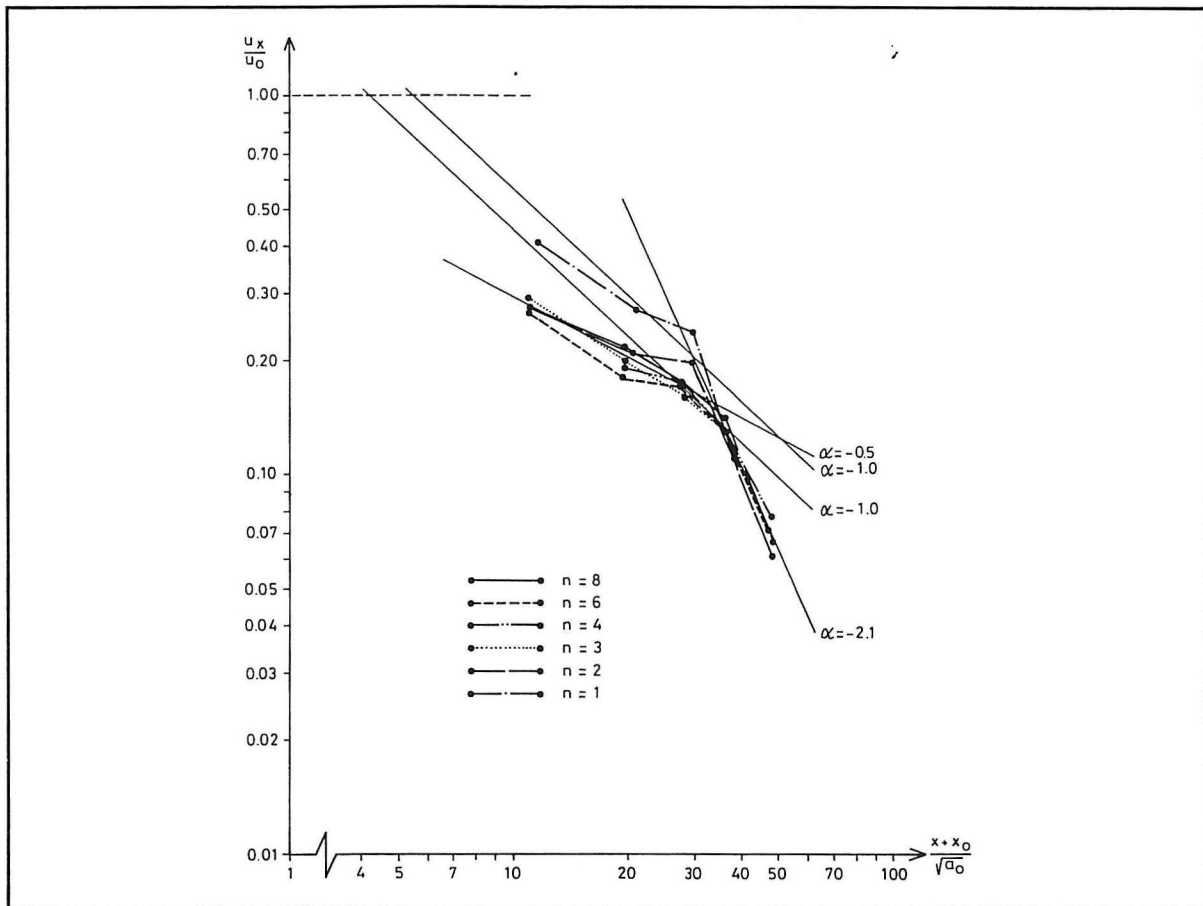

Figure 7: Measured decay of the center line velocity for  $n = 1, 2, 3, 4, 6, 8$ . The  $K_a$ -value is found to 5.2 for  $n = 1$  and 4.2 for  $n = 2, 3, 4, 6, 8$ .

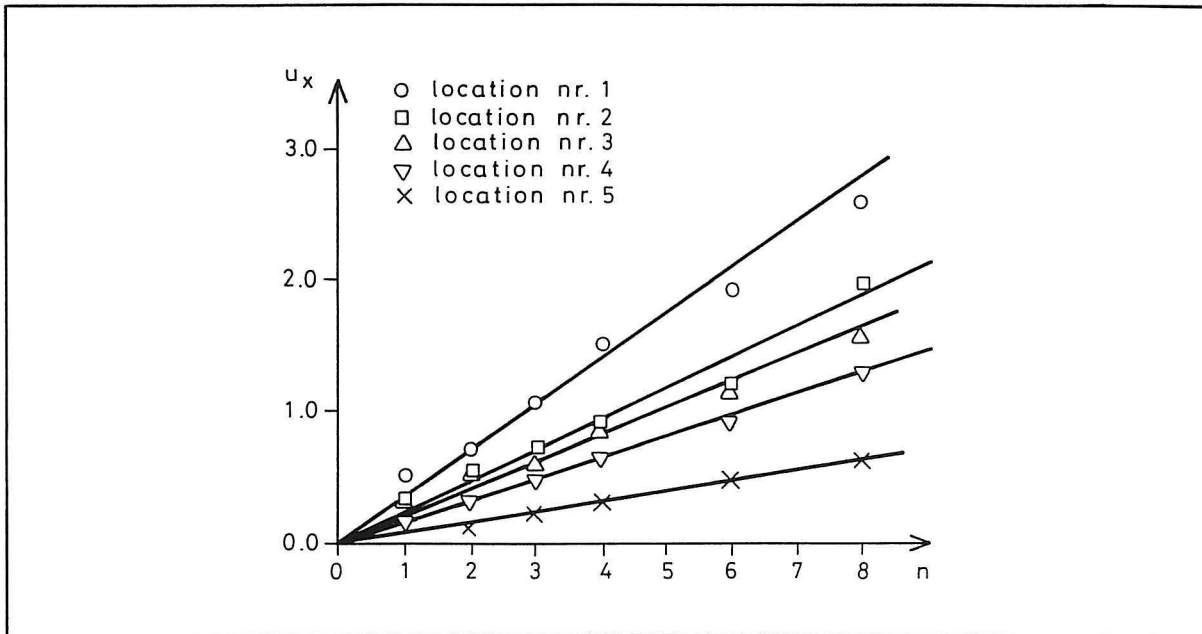

Figure 8: The center line maximum velocity for different air change rates located at ref. 1, 2, 3, 4, 5 in fig 3.

### 3.3 Analysis related to the impinging jet approach

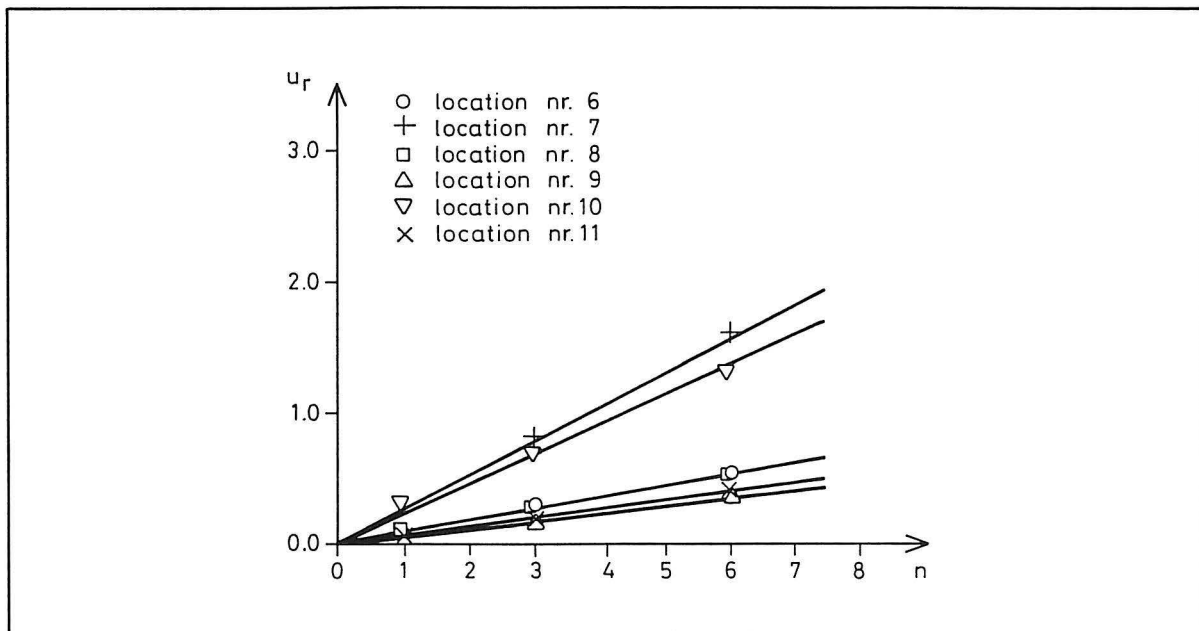

Figure 9: The maximum velocities at  $\theta = 0^\circ$  and  $\pm 45^\circ$  as functions of the air change rate.  $\phi = 40^\circ$ .

Fig. 9 shows the maximum velocities for different air change rates and different  $\theta$ 's. This figure shows that the decay of the velocity is linear and that the velocity in the inlet flow is symmetric around the center line.

*Beltaos* [2] found by means of the  $\pi$  - theorem that  $u_0/u_r$  plotted against  $r/d$  for fixed  $\phi$  and  $\theta$  should result in straight lines and the slope should be reciprocal to  $K_1$  in eq. (3) for high Reynolds' numbers. Since this paper is testing the approach in (5)  $u_0/u_r$  is plotted against  $(r+x_0)/\sqrt{a_0}$ . As it can be seen in fig. 10 there is a distinct difference between  $\theta = \pm 45^\circ$  and  $\theta = 0^\circ$ . It is also seen that the slope of the interpolated lines is difficult to estimate precisely because the geometrical extension of the room makes it impossible to obtain measurements in the range  $(r+x_0)/\sqrt{a_0} = [20..50]$  which is the interval where the slope can be measured unambiguously (*Beltaos* [2]).

Using the approach from the previous paragraph the  $K(\phi, \theta)$  is measured to 4.2 for  $\theta = 0$  and 1.1 - 1.5 for  $\theta = \pm\pi/4$ .

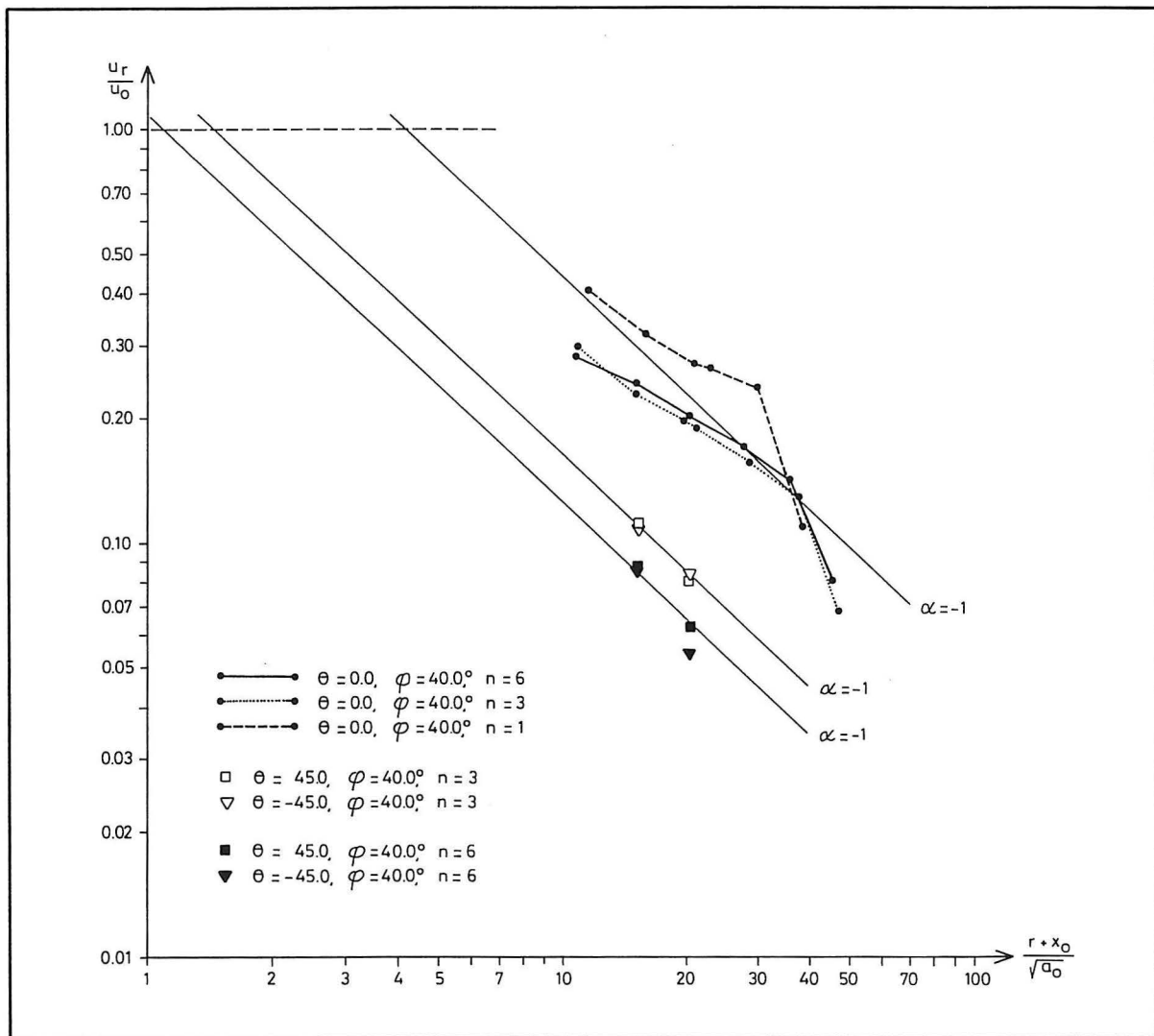

Figure 10: The decay of the maximum velocity for different air change rates at different  $\theta$  values. The  $K(40,0)$  is found to be 4.2 and the  $k(40, \pm 45)$  is found to be 1.1-1.5.

We are now able to perform a comparison between the  $K_1(\phi, \theta)$  obtained by *Beltaos* [2] and the present  $K(\phi, \theta)$ . This is done for high air change rates ( $3 - 6 \text{ h}^{-1}$ ) in fig. 11. When performing this comparison one must remember that the  $K_1(\phi, \theta)$  - values obtained by [2] are the case of a single circular jet impinging on a smooth wall where no geometrical

restrictions of the flow are present. In the present case the flow from the inlet device is not a well defined circular jet and the flow is confined by walls. Nevertheless, the outline of the present  $K(\phi, \theta)$  - values is a pronoun statement of the elements of the 3d - wall jet and the radial impinging jet in the inlet flow.

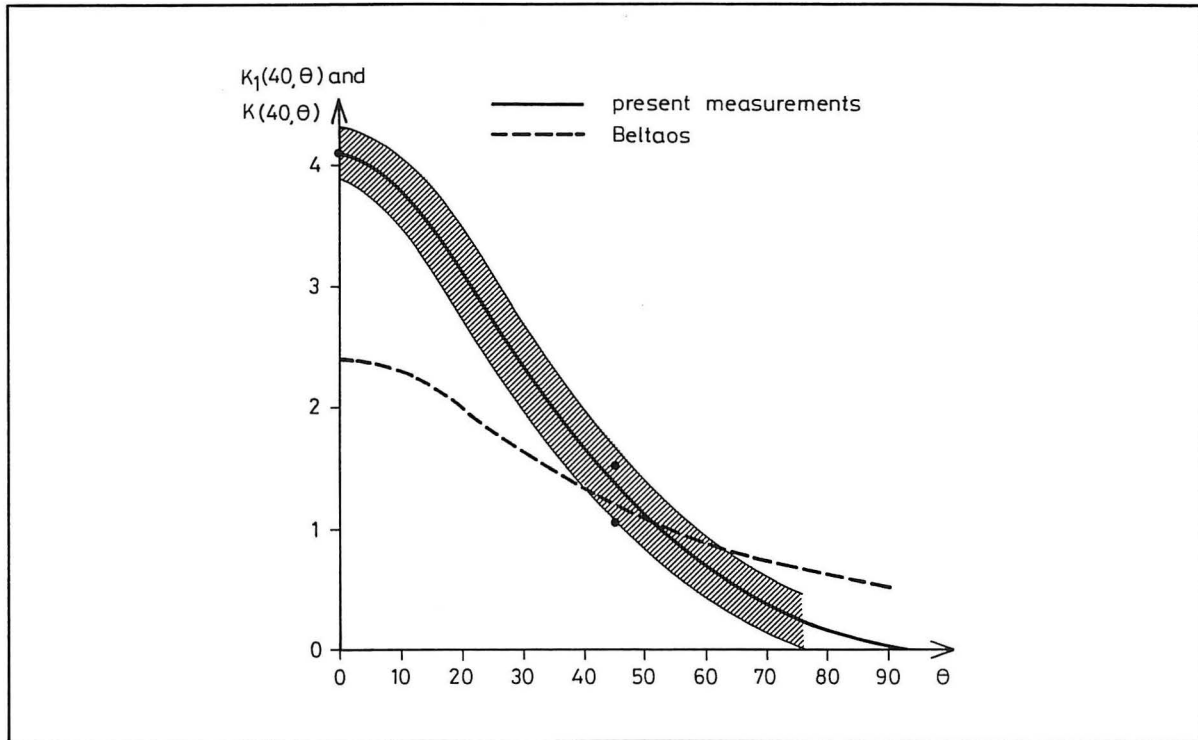

Figure 11: Comparison of the two K - values found in a circular impinging jet and in the inlet flow from a HESCO diffuser.

### 3.4 Analysis related to measurements in the occupied zone

If we follow the assumption that the flow pattern in a ventilated room is fully turbulent - independent of the Reynolds number and disregarding the initial low Reynolds number effects - eq. (2) will be reduced to

$$u_{rm} = cn \quad (7)$$

It is shown in paragraph 3 that this expression is not valid if the inlet device is designed so a laminar to turbulent transition is occurring in the used velocity range.

It has also been shown that even if the velocity profiles have the wall jet characteristics of self similarity (fig. 5) and linear growth of width (fig. 6) there is an influence from the flow rate on  $K_a$  (fig. 7). This indicates low Reynolds' number effect. The effect becomes more evident if the recirculating flow in the occupied zone is examined.

Figure 12 shows that the self similarity of the velocity profile dissolves at a certain point in the recirculating flow depending on the air change rate.

Fig. 13 shows the velocity as a function of the air change rate. The figure illustrates the validity of eq. (7). It is seen that the equation is valid for high air change rates. The validity range in terms of  $n$  is different for different  $x$  - values but in terms of velocity the validity range seems to be  $u > 0.10 - 0.15$  m/s. The effects of low turbulence are significant below this velocity level. These effects of low Reynolds' number which are directly coupled to the room are not included in the two parameters mentioned above. For this room effect a third parameter is needed the  $f_1$  parameter in (2). It is possible to estimate this parameter which has been done in fig. 14 and depicted in fig. 15.

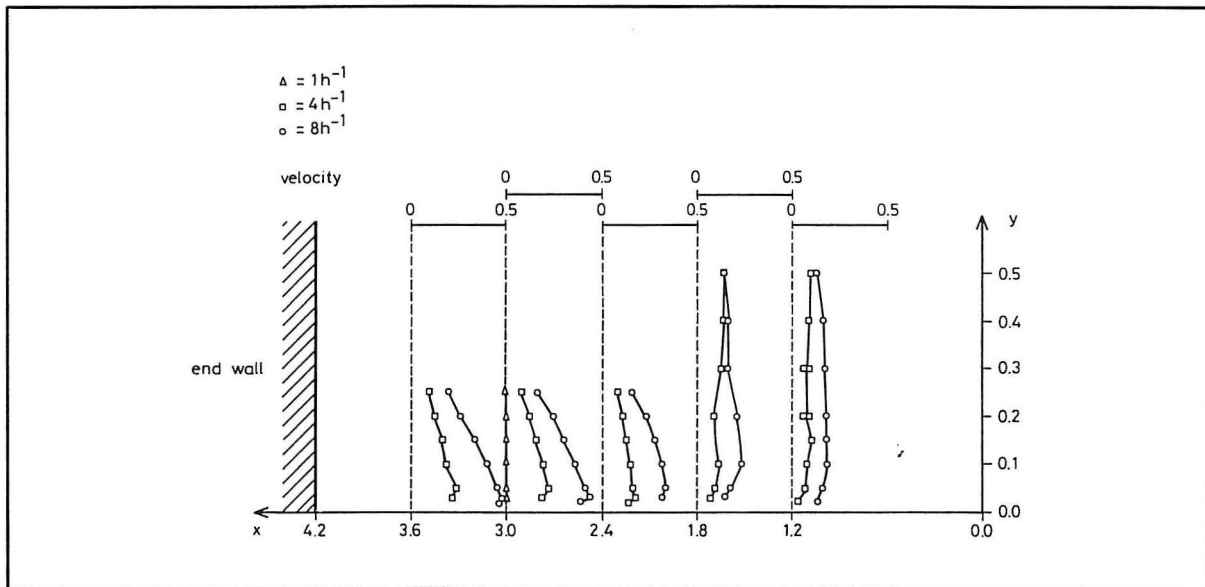

Figure 12: Velocity profiles in the occupied zone at different x distances from the inlet.

It is clearly seen that even if the changes in the inlet conditions are taken into account there is a distinct influence from the low Reynolds number flow in the room - corresponding to the change in  $f_1$ .

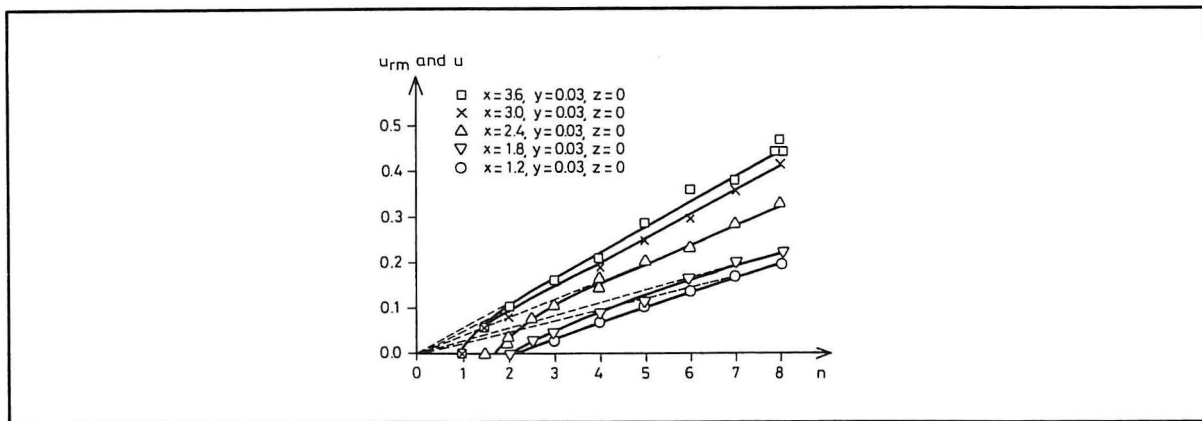

Figure 13: The maximum velocity in the occupied zone at different locations as a function of the air change rate. All measurements are in the mean plane.



n	$u_{rm}$	$u_0$	$K_a$	$\sqrt{a_0}$	$(L+x_0)$	$f_1$	$\Delta f_1$
1	0	1.3	5.2	0.089	4.65	0	+0.15
2	0.1	2.4	4.5	0.091	4.65	0.47	$\pm 0.09$
3	0.16	3.5	4.2	0.093	4.65	0.54	$\pm 0.07$
4	0.22	4.6	4.2	0.095	4.65	0.56	$\pm 0.05$
5							
6	0.33	6.7	4.2	0.096	4.65	0.57	$\pm 0.03$
7							
8	0.44	9.0	4.2	0.096	4.65	0.56	$\pm 0.03$

Figure 14: Estimation of function  $f_1$ . The values of  $u_{rm}$ ,  $u_0$ ,  $K_a$ ,  $a_0$  and  $x_0$  are taken from fig. 13, 4, 7, 4 and 6. The value  $\Delta f_1$  is due to measuring inaccuracy of  $u \pm 0.02$  m/s.

At low air flow rates even a very small temperature difference may result in a significant buoyancy effect. This effect has been tested and the non linearity in fig. 13 or the variations in  $f_1$  do not contain any influence from buoyancy forces due to the restricted level of temperature difference which was obtained during the experiments.

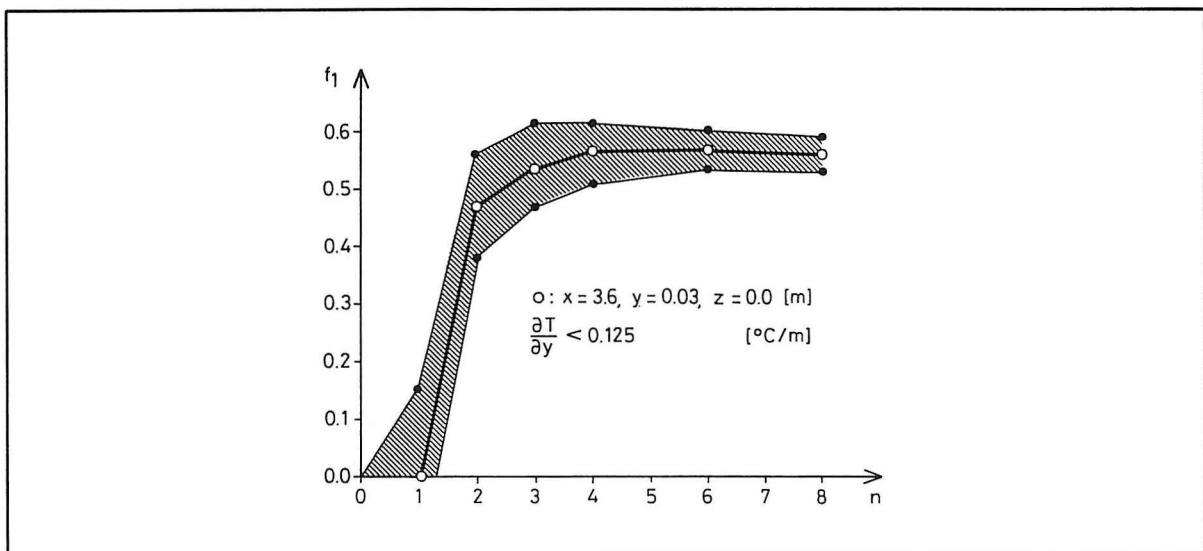

Figure 15: Estimation of the function  $f_1(n)$ . Calculated from the maximum velocity in the occupied zone.

#### 4. CONCLUSION

1. The inlet flow from a typical diffuser seems to have elements from both the three-dimensional wall jet and an impinging jet.

2. Even though the velocity profiles in front of the diffuser are self similar a low Reynolds number effect is shown as decreasing  $K_a$  at increasing air change rate  $n$ .
3. Low Reynolds' number effects are present in the velocity field if the air change rate is in the range of 0 to 3 - 4 which is exactly the range of practical interest. In the occupied zone the influence of the low Reynolds number effects seems to be significant in the velocity range 0 - 0.15 m/s which is also the range of velocity one usually would tolerate in the occupied zone in e.g. an office.
4. The low Reynolds number effects seem to arise from two sources: The change in the inlet flow and change in the flow structure in the room. The effects from the inlet are very important to take into account in both the simplified models and the numerical simulations because the flow field in the room is driven by the inflow momentum. The effects from the room are difficult to take into account in both models. In the simplified model because there the function  $f_1(n)$  is difficult to obtain in all geometries at different air change rates. In the numerical simulation there is no suitable low Reynolds' number model available.

## LITERATURE

- [1] *Nielsen P.V.*: Simplified Models for Room Air Distribution. Internal report, IEA Annex 20, University of Aalborg, 1988. ISSN 0902 - 7513 R 8831.
- [2] *Beltaos, S.*: Oblique Impingement of Circular Turbulent Jets. Journal of Hydraulic Research 14 (1976) no. 1.
- [3] *Nielsen, P.V. and Möller, Å.T.A.*: Measurement of the Three-Dimensional Wall Jet from Different Types of Air Diffusers. World Congress on heating, ventilating and air conditioning, 1985.
- [4] *Nielsen, P.V. and Möller, Å.T.A.*: Measurements on Buoyant Jet Flows From a Ceiling Mounted Slot Diffuser. III seminar on Appl. of fluid mechanics in environmental protection, Silesian Tech. University, Gliwice, Poland, 1988.
- [5] *Rajaratnam, N.*: Turbulent Jets, Elsevier, Amsterdam 1976.
- [6] *Rajaratnam, N. and Pani, B.S.*: Three-Dimensional Turbulent Wall Jets, Proc. A.S.C.E. J. Hydraul. Div., 100, 69-83.
- [7] *Trentacoste, N. and Sforza, D.M.*: Further Experimental Results for Three-dimensional Free Jets., A.I.A.A. Journ. 5, 885-891, 1967.
- [8] *Murakami, S., Tanaka, T. and Kato, S.*: Numerical Simulation of Air Flow and Gas Diffusion in Room Model - Correspondence between Simulation and Model Experiment. University of Tokyo 1983.

- [9] *Nielsen P.V.*: Numerical Prediction of Air Distribution in Rooms - Status and Potentials. In : *Building Systems : Room Air and Air Contaminant Distribution* (Edited by L.L. Christianson) ASHRAE, 1989 ISBN 0-910110-64-6.
- [10] *Larsen , J.H, Kjelgaard, E.W, Agesen, L.*: Private communication. The University of Aalborg, Denmark. 1988.
- [11] *Gosman, A.D., Nielsen, P.V., Restivo, A., Whitelaw, J.H.*: The Flow Properties of Rooms with Small Ventilation Openings. *Transaction of ASME*, Vol. 102. 1980.
- [12] *Benocci, C. and Skovgaard, M.*: Prediction of Turbulent Flow Over a Backward Facing Step. *Proc. 6th int. conf. Laminar and Turbulent Flows*. Swansea, UK. 1989.
- [13] *Nielsen P.V.*: Selection of Air Terminal Device, Internal Report, IEA Annex 20. University of Aalborg. 1988. ISSN 0902-7513-R8838.

## APPENDIX

In the paper it was shown that the inlet flow was symmetric around the center plane. This is not the case for the lower part of the room. The figure shows some additional measurements made across the room in the occupied zone. It is clearly seen that one cannot expect the flow to be symmetric even if the boundary conditions are symmetrical.

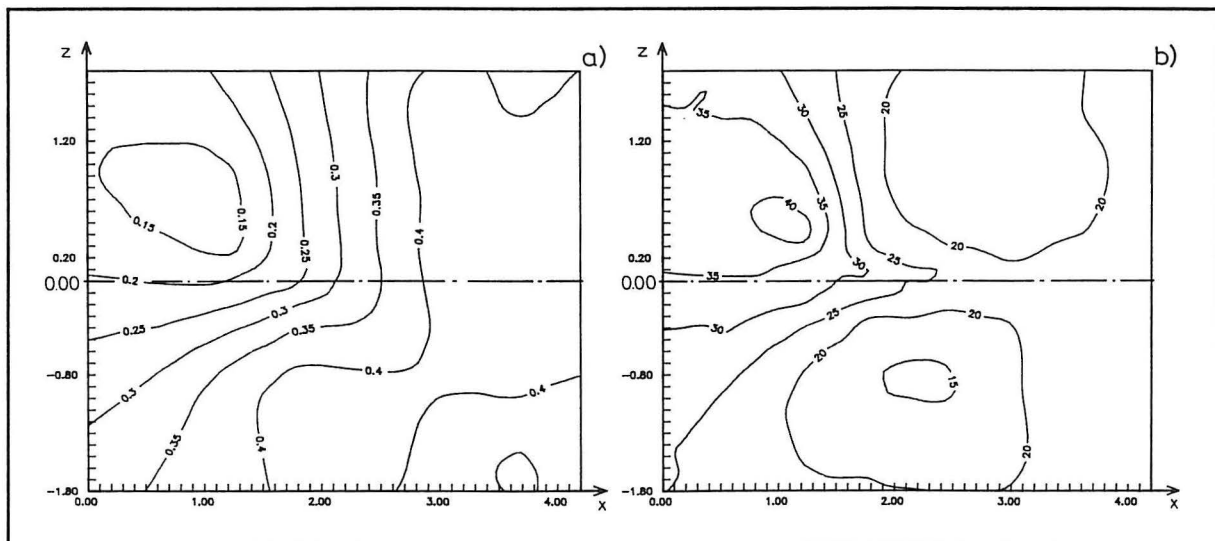

Figure 16: Hotwire measurements of the velocity in the occupied zone. A symmetrical flow is observed. a) mean velocity b) turbulence level.



## PAPERS ON INDOOR ENVIRONMENTAL TECHNOLOGY

PAPER NO. 1: C. E. Hyldgård: *Aerodynamic Control of Exhaust*. ISSN 0902-7513 R8712.

PAPER NO. 2: Per Heiselberg, Peter V. Nielsen: *The Contaminant Distribution in a Ventilated Room with Different Air Terminal Devices*. ISSN 0902-7513 R8713.

PAPER NO. 3: Peter V. Nielsen, L. Evensen, Peter Grabau, J. H. Thulesen-Dahl: *Air Distribution in Rooms with Ceiling-Mounted Obstacles and Three-Dimensional Flow*. ISSN 0902-7513 R8714.

PAPER NO. 4: Peter V. Nielsen, Åke T. A. Möller: *Measurements on Buoyant Wall Jet Flows in Air-Conditioned Rooms*. ISSN 0902-7513 R8715.

PAPER NO. 5: Peter V. Nielsen: *Numerical Prediction of Air Distribution in Rooms. Status and Potentials*. ISSN 0902-7513 R8823.

PAPER NO. 6: Peter V. Nielsen, Åke T. Möller: *Measurements on Buoyant Jet Flows from a Ceiling-Mounted Slot Diffuser*. ISSN 0902-7513 R8832.

PAPER NO. 7: Peter Kofoed, Peter V. Nielsen: *Thermal Plumes in Ventilated Rooms - An Experimental Research Work*. ISSN 0902-7513 R8833.

PAPER NO. 8: Peter V. Nielsen, Lars Hoff, Lars Germann Pedersen: *Displacement Ventilation by Different Types of Diffusers*. ISSN 0902-7513 R8834.

PAPER NO. 9: Per Heiselberg, Peter V. Nielsen: *Flow Conditions in a Mechanically Ventilated Room with a Convective Heat Source*. ISSN 0902-7513 R8835.

PAPER NO. 10: Peter V. Nielsen: *Displacement Ventilation in a Room with Low-Level Diffusers*. ISSN 0902-7513 R8836.

PAPER NO. 11: Peter V. Nielsen: *Airflow Simulation Techniques - Progress and Trends*. ISSN 0902-7513 R8926.

PAPER NO. 12: M. Skovgaard, C. E. Hyldgaard & P. V. Nielsen: *High and Low Reynolds Number Measurements in a Room with an Impinging Isothermal Jet*. ISSN 0902-7513 R9003

PAPER NO. 13: M. Skovgaard, P. V. Nielsen: *Numerical Prediction of Air Distribution in Rooms with Ventilation of the Mixing Type using the Standard  $K, \epsilon$ -Model*. ISSN 0902-7513 R9042.

PAPER NO. 14: P. Kofoed, P. V. Nielsen: *Thermal Plumes in Ventilated Rooms - Measurements in Stratified Surroundings and Analysis by Use of an Extrapolation Method*. ISSN 0902-7513 R9043.

PAPER NO. 15: P. Heiselberg, M. Sandberg: *Convection from a Slender Cylinder in a Ventilated Room*. ISSN 0902-7513 R9044.



**PAPERS ON INDOOR ENVIRONMENTAL TECHNOLOGY**

PAPER NO. 16: C. E. Hyldgaard: *Water Evaporation in Swimming Baths*. ISSN 0902-7513 R9045.

PAPER NO. 17: H. Overby, M. Steen-Thøde: *Calculation of Vertical Temperature Gradients in Heated Rooms*. ISSN 0902-7513 R9046.

**Department of Building Technology and Structural Engineering  
The University of Aalborg, Sohngaardsholmsvej 57. DK 9000 Aalborg  
Telephone: 45 98 14 23 33    Telefax: 45 98 14 82 43**