



Aalborg Universitet

AALBORG UNIVERSITY
DENMARK

Investigation of Balcony Plume Entrainment

Liu, F.; Nielsen, Peter V.; Heiselberg, Per; Brohus, Henrik; Li, B. Z.

Published in:

Proceedings of the International Conference on Sustainable Development in Building and Environment. 28-30 October 2009, Chongqing, China

Publication date:
2009

Document Version
Publisher's PDF, also known as Version of record

[Link to publication from Aalborg University](#)

Citation for published version (APA):

Liu, F., Nielsen, P. V., Heiselberg, P., Brohus, H., & Li, B. Z. (2009). Investigation of Balcony Plume Entrainment. In *Proceedings of the International Conference on Sustainable Development in Building and Environment. 28-30 October 2009, Chongqing, China*

General rights

Copyright and moral rights for the publications made accessible in the public portal are retained by the authors and/or other copyright owners and it is a condition of accessing publications that users recognise and abide by the legal requirements associated with these rights.

- ? Users may download and print one copy of any publication from the public portal for the purpose of private study or research.
- ? You may not further distribute the material or use it for any profit-making activity or commercial gain
- ? You may freely distribute the URL identifying the publication in the public portal ?

Take down policy

If you believe that this document breaches copyright please contact us at vbn@aub.aau.dk providing details, and we will remove access to the work immediately and investigate your claim.

Investigation on Balcony Plume Entrainment

F. LIU¹ P. V. Nielsen² P. Heiselberg² Henrik Brohus² B. Z. LI¹

(1. Faculty of Urban Construction and Environment Engineering, Chongqing University, Chongqing, China;

2. Department of Civil Engineering, Aalborg University, Aalborg, Denmark)

Abstract: An investigation on the scenarios of the spill plume and its equation was presented in this paper. The study includes two aspects, i.e., the small-scale experiment and the numerical simulation. Two balcony spill plume models are assessed by comparing with the FDS (Fire Dynamic Simulation) and small scale model experiment results. Besides validating the spill model by experiments, the effect of different fire location on balcony plume is also discussed.

The results show that the balcony equation in NFPA would give good predictions on the mass flow rate. And the balcony plume entrainment coefficient is independent of the fire location. The Investigations in this paper are useful for the fire engineers in designing smoke control systems.

Keywords: fire plume/ entrainment/ atrium

1 Instruction

Currently, there are a number of calculation methods available to designers for smoke control of atrium buildings. And there are also many researches on smoke movement in atrium building. Different geometrical arrangements of fire inside a building could lead to different entrainment, and hence different plume expressions. A good understanding of the plume in a fire is important in designing smoke control systems.

The amount of air entrained into the plume will depend on the configuration of the plume produced. Milke[1] identified five configurations of smoke plume which may exist within atrium buildings, these are:

◇ Axisymmetric plume

An axisymmetric plume is generally expected from a fire located near the centre of an atrium floor. This type of plume is typically remote from any walls and air is entrained around all sides of the plume. Entrainment of air will occur over the full height of the plume until it reaches the interface with a smoke layer which may have formed above. A classical analysis of axisymmetric plumes has been carried out by Morton, Taylor and Turner^{[2][3][4]}.

◇ Wall plume

A plume which is generated from a fire against a wall is known as a wall plume. Zukoski developed a wall plume entrainment correlation based on “mirror symmetry”. Work by Poreh and Garrad has highlighted that further research on wall plume entrainment is desirable^{[5][6][7]}.

◇ Corner plume

A plume which is generated from a fire located in the corner of a room, where the walls form a 90° angle, is known as a corner plume. Zukoski treated the corner plumes in a similar manner to a wall plume with the use of ‘mirror symmetry’ for plume entrainment. Again, work by Poreh and Garrad has demonstrated that further research is desirable for corner plume entrainment^{[8][9]}.

◇ Spill plume

A spill plume is a vertically rising plume resulting from an initially horizontally moving smoke layer which then subsequently rises at a spill edge (e.g. at an opening onto an atrium space).

◇ Window plume (door plume)

A window plume is a plume which flows from a window (or doorway) into an atrium space. Typically, window plumes are generated from post-flashover fires. An entrainment correlation was developed by Heskestad, by comparing the air entrainment for a window plume with that of an axisymmetric plume. The window plume entrainment correlation is given by Klote and Milke^[10].

The typical balcony plume is shown in the Fig. 1. The estimation of the air entrainment rate is very important for designing the smoke control system in an atrium. Entrainment into the smoke flows at the balcony edge and into the rising plume might be calculated by plume equation. For the plume model of Thomas and NFPA detailed descriptions of this method can be found in the literature^{[11][12][13]}.

Foundation item: European Community Asia-link Project Centre of Sino-European Sustainable Building Design & Construction (Contract No.: CN/ASIA-LINK/011(91-400)) and the experiment conducted in the Department of Civil Engineering Aalborg University Denmark.

Corresponding author: Liu Fang, female, (1965—), postdoctor, associated professor, research fields: Indoor environment and fire safety science
Tel: +86-23-65120756; E-mail: drliufang@126.com.

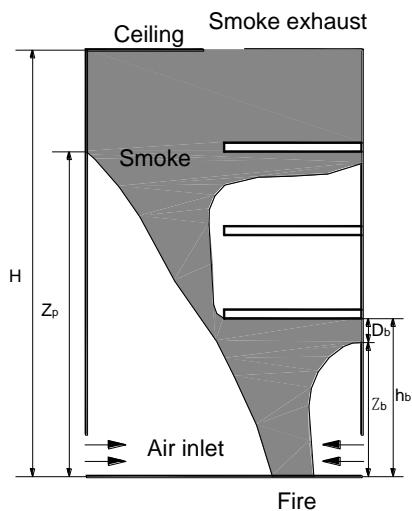

Fig. 1 Typical balcony plume

Plume model of Thomas was taken as a ‘far plume’ rising from a line source of zero thickness some distance below the void edge. A relatively simple plume equation with virtual source correction on mass flow rate m_p at height Z_p can be given as

$$m_p = 0.58 \rho_g \left[\frac{g Q_c W^2}{\rho_g C_p T_a} \right]^{1/3} \left(Z_p + \Delta \right) \left[1 + \frac{0.22 (Z_p + 2\Delta)}{W} \right]^{2/3} \quad (1)$$

Where Δ is the empirical height of the virtual source below the balcony, Z_p is the height above the balcony, and W is the width of the plume as it spills under the balcony. For small Z_p/W , the main term is consistent with Lee and Emmons model^[14]. The results would be reduced to the conventional point source plume theory for $Z_p \gg W$.

Based on the interpretation of the small-scale experiments by Morgan and Marshall, a good linear relationship between m_p and Z_b was found by Law^[15]. The mass production rate can be expressed as:

$$m_p = 0.36 (QW^2)^{1/3} (Z_b + 0.25h_b) \quad (2)$$

Where, h_b is the height of the balcony, Z_b is the height above the balcony ($Z_b = Z_p - h_b$) and Q is the heat release of the fire.

Currently, there are a number of calculation methods available to designers of smoke control system for atrium buildings involving the thermal spill plume. These include various simplified spill plume formulae. These methods are important to the designer in order to calculate the required fan capacity or vent area. However, there is some controversy over the accuracy and robustness of some of these design formulae for spill plumes. There are limitations to the available calculation methods and there are also areas of uncertainty which require further research. Therefore, there is a need to provide empirical correlations to characterize these flows

for a variety of compartment openings and fire location. There have been a number of experimental and Computational Fluid Dynamics modeling (CFD) to examine the entrainment of air into a spill plume studies of the thermal spill plume^{[15] [16] [17] [18]}.

Full-scale burning tests were performed to derive the plume expressions empirically. However, widespread use of this approach is not economically feasible and experimental data are limited. Computational Fluid Dynamics and scale model experiments are two possible methods for the determination of smoke movement in the large building. With the rapid development of computational fluid dynamics (CFD), it is now possible to assess the plume equations, and CFD might be regarded as a useful tool in solving some plume flows in buildings. There had been earlier works on assessing the temperature and mass flux formulae for some expressions on axisymmetric plumes and balcony spill plumes with CFD packages. The scale model experiments and CFD are used to study the plume entrainment in this paper.

This paper aims are on the balcony plume through both physical experiments and numerical simulations. Two balcony spill plume models are assessed by comparing with the FDS and experiment results. In this study, scale model experiments were performed in an atrium constructed in the Aalborg University of Denmark. Numerical simulations were performed by the computational fluid dynamics model, i.e., Fire Dynamics Simulator, FDS. Investigations in this paper are useful for fire engineers in designing smoke control systems.

2 Description of the Experiments

In Froude (or Archimedes) modeling, a model of an atrium is constructed such that every dimension is an exact fraction of a full-scale facility. Scaling relationships are provided in NFPA 92B for the physical modeling of Atrium space. The scaling expressions are as follows^[19]:

$$x_m = x_F (L_m/L_F) \quad (1)$$

$$T_m = T_F \quad (2)$$

$$Q_{c,m} = Q_{c,F} (L_m/L_F)^{5/2} \quad (3)$$

$$V_{fan,m} = V_{fan,F} (L_m/L_F)^{5/2} \quad (4)$$

Where

x = position,

L = length,

T = temperature,

V_{fan} = volumetric exhaust rate,

Q_c = convective heat release rate,

Subscripts

F = full-scale, and

m = reduced-scale model.

The experimental facility used for this study is shown in Fig.2. The physical model is designed to be a 1/15 scale model of a theatre, which has a length, width and height 20*20*30 m. The facility is a compartment with interior dimensions of 1.335m length by 1.335m width by 2.055m height with an exhaust opening on the center of the ceiling^[20]. The exhaust opening has a diameter of 0.10m, which is connected with an exhaust duct. The ceiling, floor and one of walls were made of wood. Three walls were made of Perspex (glass). The two inlets were designed on the bottom of the side wall as shown in Fig 2. These inlets connected with air supply duct, had a width 300-mm and height 200-mm, which had holes on, with 40 percentage areas available for air supply. To allow for visual observation within the compartment, one glass observation was remained, and the two were shielded by shades. The inlet duct and smoke exhaust duct were connected with an orifice flow meter and a fan respectively as shown in Fig.2.

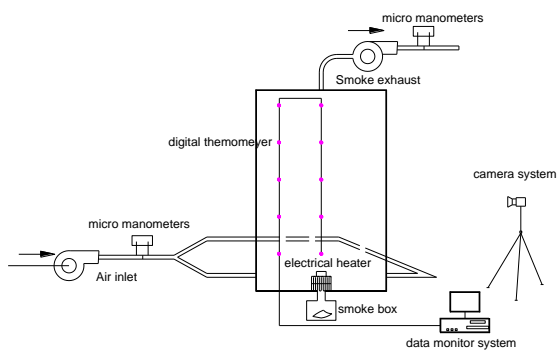

Fig. 2 Sketch of the model

For studying the spill plume, the one half of the test compartment was used as the communicating space and divided in to four parts in vertical direction by the three clapboards. Four sets of thermocouples, labeled as Tree 1, Tree 2, Tree 3 and Tree 4, were installed to measure the characteristic temperatures. As shown in Fig.2, Tree1 and Tree 2 and Tree3 sets are mounted in the atrium and Tree 4 is mounted in the center of balcony. Tree 1 set, arranged in the center of the model, can be used to measure the temperatures of smoke layer at positions of 380 mm, 760 mm, 11240 mm, 1900 mm and 2280mm from the ground by using 5 K-type thermocouples . Tree 2 set, containing 5 K-type thermocouples and arranged in the center of balcony, is used to provide the temperature variations in the balcony. The Tree 3 and Tree 4 are set up to measure the temperature of the spill plume out of the balcony with 5 thermocouples arranged in 380mm vertical intervals.

Fire was placed in the three different locations on the recessed ground level room as shown in Fig.3.

The fire placed in the center of the recessed ground level room is case A, which is the fire located in the center of the communicating space. The case B is the fire

in the corner of the ground level communicating space, and case C is that the fire beside the wall in the ground level communicating space.

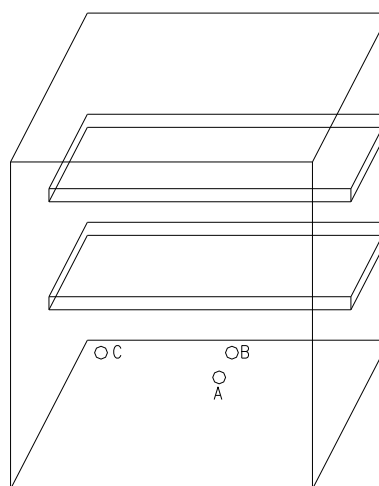
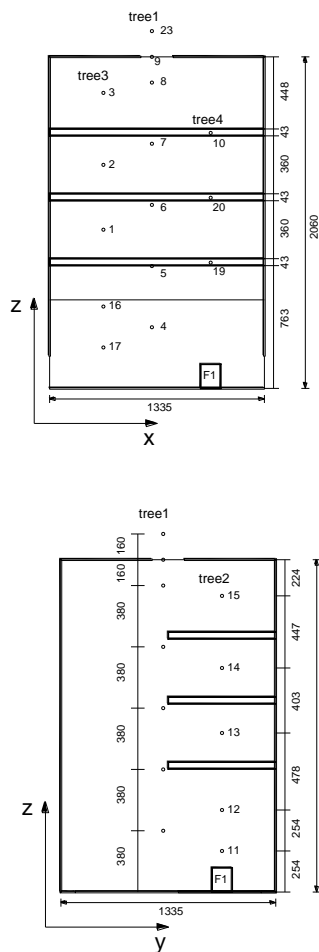

Fig. 3 Model dimension and thermocouple for the balcony plume

Table 1 Fire location for the balcony plume

case	X(mm)	Y(mm)
A	668	1001
B	668	1250
C	85	1250

Instrumentation

In the test compartment there were thermocouple trees to test the smoke temperature. The electrical heater was used as the fire source. The smoke was produced by smoke box using fuming liquid.

Frequency conversion method was used to change the fans rotation speed. The two transducers were used for the air supplement fan and smoke exhaust fan respectively. And then the designed inlet air volume rate and exhaust rate could be obtained by changing the electric frequency.

The volume flow rate was measured using the throttle aperture mounted in the each air supply duct and smoke exhaust duct. Firstly the throttle aperture ducts were standardized. The rate of the smoke exhaustion and inlet air were deduced from the static pressure difference measured by the micro manometers and the temperature measured by the thermocouple. There is a ruler put in the model to measure the smoke layer height.

The two sets of throttle duct were used in the experiment. One set is large and the other is small. Their equations for calculating the volumetric rate are calibrated. The volume rate can be calculated by the pressure difference tested in the experiment. Inlet air velocity may be calculated by the volumetric rate and actual inlet areas.

3 Test Methods

The inlet air supply rate and smoke exhaust rate were designed to get the steady smoke layer height. Before the test, the exhaust and inlet fans were opened. The transducers were adjusted to ensure the designed air supply rate and smoke exhaust rate according to the experimental cases. The smoke producer and electrical heater were turned on for several minutes. When the air flow in the model began to the steady, then carefully made the smoke filled the smoke box, and the air pump was switched on at a fixed voltage to obtain a uniform outlet velocity. The smoke layer height, smoke temperature and inlet air temperature were measured during the test.

The smoke layer height was deduced from the temperature profile collected by thermocouple and the smoke image observed or caught by video. Temperature data were recorded every ten seconds during the test times on a multi-channel data acquisition system. The conditions in the test space were observed by a video

camera.

The three different fire location of the recessed ground level room is as shown in Fig.3. The fire placed in the center of the recessed ground level room is case A, which is the fire located in the center of the communicating space. The case B is the fire in the corner of the ground level communicating space, case C is that the fire beside the wall in the ground level communicating space. At the test beginning the inlet and exhaust fans and the smoke box were opened.

4 FDS Simulation

To obtain more information about the smoke layer on the smoke exhaust condition, CFD simulations were finished by adopting large eddy simulation (LES) program, FDS^[21]. The FDS simulation model was designed to be a 15 times of the experiment model, which has a length, width and height 20*20*30 m³. There were two inlet openings on the two sides of the simulation model with the length and height 18.5*3 m². The exhaust vent on the ceiling is an opening with 1.5*1.5m². The location of the inlet and exhaust vents is the same as in the model experiment. The smoke movement was simulated by a steady fire. The initial temperature, air inlet volume and the smoke exhaust rate were set according to the scaling expressions. In this paper, one of the numerical simulations will be presented with heat release rate of 260 kW.

5 Results and Discussion

The tested inlet air temperature, smoke temperature, and smoke layer height for the case A with the heat release 300W are compare to the numerical simulation results for the case A with the heat release 260 kW. Fig. 4 shows a comparison of temperature profiles at the center of compartment between experimental and numerical simulations for the fire in the center of communicating space. The dimensionless smoke layer height means the value of a percentage of the ceiling height. It is obvious that the FDS simulation seems to over predict the temperature. Despite the difference in the temperature values between the simulation and experimental data, there is a good agreement between the experimental and numerical hot layer height in the compartment, as well as the average hot layer temperature.

Comparison of experimental data with FDS simulation predictions indicate that, while a one to one comparison of temperature does not give very good results, the FDS was able to predict the level of the hot layer as well as the average temperature in this layer. Despite the difference in the temperature values between the simulation and experimental data, there is a good agreement between the experimental and numerical hot

layer height in the compartment, as well as the average hot layer temperature.

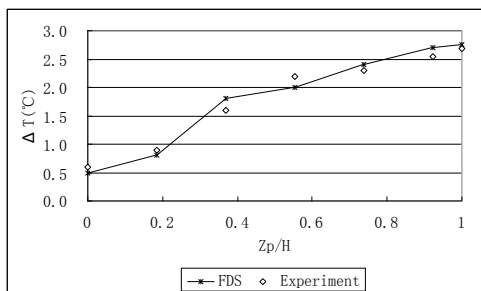

the inlet air supply rates in the experiment and FDS simulation are 0.06 m³/s and 10.5 m³/s respectively

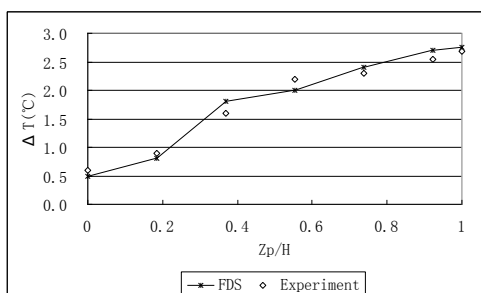

the inlet air supply rates in the experiment and FDS simulation are 10.5 m³/s and 50.5 m³/s respectively.

Fig. 4 Comparison of temperature rise between experimental data and predictions

The relationship between the mass flow rate of the balcony plume and the smoke layer height by FDS simulation and experiment results of the Case A are compared with those by different spill plume models are shown in Fig. 5a. It is obvious that a linear relationship between the mass flow rate m_p and the smoke layer height Z_p can be observed. A good agreement is found between the results of CFD simulation, the experiment and those predicted by the NFPA plume equations. Larger discrepancies between the simulation and experiment results in this study and those estimated by the Thomas equation were found.

The FDS simulation and experiment results of the Case B, C with the different heat release are compared with those by different spill plume models shown in Fig. 5b. It is obvious that the balcony plume entrainment coefficient is independent of the fire location. And compared with the NFPA model, the error range of the results from the experiment and FDS simulation data in this paper is between -0.08 and 0.05. The balcony equation in NFPA would give good predictions on the mass flow rate.

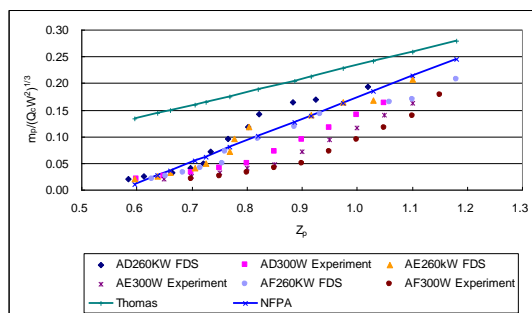

Fig. 5a Comparison of the predicted mass flux with those by different balcony spill plume models

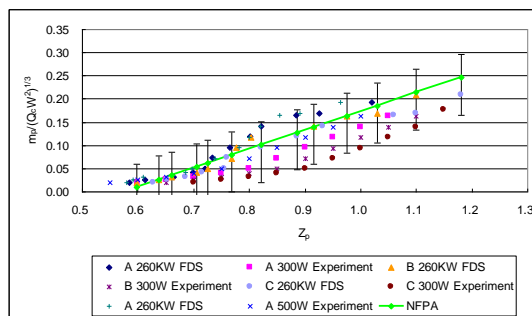

Fig. 5b Comparison of the predicted mass flux with those by different balcony spill plume models

6 Conclusion

The results of FDS simulation and model experiment indicate that:

The smoke layer height and temperature difference in FDS simulation are consistent with these from the small-scale model.

The balcony plume entrainment coefficient is independent of the fire location. The balcony equation in NFPA would give good predictions on the mass flow rate. Compared with the NFPA model, the error range of the results from the experiment and FDS simulation data in this report is between -0.08 and 0.05.

Acknowledgements

The work described in this paper was partially supported by European Community Asia-link Project Centre of Sino-European Sustainable Building Design & Construction (Contract No.: CN/ASIA-LINK/011(91-400)). The experiment was conducted in the Department of Civil Engineering Aalborg University Denmark.

Thanks to Dr. R. M. Yao for her care in the project execution. Thanks to Heidi Stentoft and Torben Christensen for their help with experiment.

References

- [1] Milke J A. Smoke management for covered malls and atria [J]. Fire Technology, 1999, 26(3):223-243.

- [2] Heskestad G. Engineering relations for fire plumes [J]. *Fire Safety Journal*, 1984, 7, No 1:25-32.
- [3] Zukoski, E.E., Kubota, T. and Cetegen, B. Entrainment in Fire Plumes [J]. *Fire Safety Journal*, 1980/81, 3: 107–121.
- [4] Zukoski E E. Properties of fire plumes, in *Combustion Fundamentals of Fire*[M]. London: Cox G, Editor. Academic Press, 1995.
- [5] Michael Poreh, Gordon Garrad. A study of wall and corner plumes [J]. *Fire Safety Journal*, 2000, 34: 81-98.
- [6] Cegeten, B., Zukoski, E.E. and Kubota, T. Entrainment in the near and Far Field of Plumes [J]. *Combustion Science and Technology*, 1984, 39:305-331.
- [7] McCaffrey, B.J... Momentum Implication for Buoyant Diffusion Flames[J]. *Combustion and Flame*, 1983, 52:149-167.
- [8] Poreh, M., Morgan, H.P., Marshall, N.R. and Harrison, R.. Entrainment by Two-dimensional Spill Plumes [J]. *Fire Safety Journal*, 1998, 30:1–19.
- [9] Thomas, P.H., Morgan, H.P. and Marshall, N. The Spill Plume in Smoke Control Design [J]. *Fire Safety Journal*, 1998, 30:21–46.
- [10] Klote J H and Milke J A. Design of smoke management systems [M]. Atlanta, GA: American Society of Heating, Refrigerating and Air-conditioning Engineers, 1992.
- [11] Thomas, P.H.. On the Upward Movement of Smoke and Related Shopping Mall Problems [J]. *Fire Safety Journal*, 1987, 12:191–203.
- [12] Law, M.. Measurements of Balcony Smoke Flow [J]. *Fire Safety Journal*, 1995, 24:189–195.
- [13] Poreh, M., Morgan, H.P., Marshall, N.R. and Harrison, R. Entrainment by Two-dimensional Spill Plumes [J]. *Fire Safety Journal*, 1998, 30:1-19.
- [14] Poreh, M., Morgan, H.P., Marshall, N.R. and Harrison, R. Entrainment by Two-dimensional Spill Plumes [J]. *Fire Safety Journal*, 1998, 30:1-19.
- [15] Law, M.. Measurements of Balcony Smoke Flow [J]. *Fire Safety Journal*, 1995, 24:189–195.
- [16] Marshall N R and Harrison R. Experimental studies of thermal spill plumes. Building Research Establishment Occasional Paper, OP1, 1996.
- [17] W. K. Chow and J. Li. Simulation on Natural Smoke Filling in Atrium with a Balcony Spill Plume [J]. *Journal of Fire Sciences*, 2001, 19:258.
- [18] C.L. Shi, W.Z. Lu, W.K. Chow, R. Huo. An investigation on spill plume development and natural filling in large full-scale atrium under retail shop fire [J]. *International Journal of Heat and Mass Transfer*, 2007, 50:513 - 529.
- [19] NFPA. 1995. NFPA 92B, Guide for smoke management system in malls, atria and large area. Quincy, Mass.: National Fire Protection Association.
- [20] P. V. Nielsen, H. Brohus, H. la Cour-Harbo, M. Lykkegaard, M. Dam1 and B. V. Jensen. The Design of a Fire Source in Scale-Model Experiments with Smoke Ventilation. 2004.
- [21] K.B. McGrattan and G.P. Forney, 2004a, *Fire Dynamics Simulator—User’s Manual*, National Institute of Standards and Technology [M]. Gaithersburg, MD: NIST Special Publication 1019, 2004.