



AALBORG UNIVERSITY
DENMARK

Aalborg Universitet

Gas turbine control for islanding operation of distribution systems

Mahat, Pukar; Chen, Zhe; Bak-Jensen, Birgitte

Published in:

Proceedings of the IEEE Power & Energy Society General Meeting 2009

DOI (link to publication from Publisher):

[10.1109/PES.2009.5275701](https://doi.org/10.1109/PES.2009.5275701)

Publication date:

2009

Document Version

Publisher's PDF, also known as Version of record

[Link to publication from Aalborg University](#)

Citation for published version (APA):

Mahat, P., Chen, Z., & Bak-Jensen, B. (2009). Gas turbine control for islanding operation of distribution systems. In *Proceedings of the IEEE Power & Energy Society General Meeting 2009* IEEE.
<https://doi.org/10.1109/PES.2009.5275701>

General rights

Copyright and moral rights for the publications made accessible in the public portal are retained by the authors and/or other copyright owners and it is a condition of accessing publications that users recognise and abide by the legal requirements associated with these rights.

- ? Users may download and print one copy of any publication from the public portal for the purpose of private study or research.
- ? You may not further distribute the material or use it for any profit-making activity or commercial gain
- ? You may freely distribute the URL identifying the publication in the public portal ?

Take down policy

If you believe that this document breaches copyright please contact us at vbn@aub.aau.dk providing details, and we will remove access to the work immediately and investigate your claim.

Gas Turbine Control for Islanding Operation of Distribution Systems

Pukar Mahat, Zhe Chen and Birgitte Bak-Jensen

Abstract—Danish distribution systems are characterized by a significant penetration of small gas turbine generators (GTGs) and fixed speed wind turbine generators (WTGs). Island operation of these distribution systems are becoming a viable option for economical and technical reasons. However, stabilizing frequency in an islanded system is one of the major challenges. This paper presents three different gas turbine governors for possible operation of distribution systems in an islanding mode. Simulation results are presented to show the performance of these governors in grid connected and islanding mode.

Index Terms— Droop control, fixed speed wind turbine, gas turbine governor, isochronous control.

I. INTRODUCTION

The growing environmental concerns and constraints on construction of new transmission and distribution lines have made it difficult for power utilities to catch up with the increased demand. This has resulted in overloading of the transmission and distribution systems and distributed generation (DG) is seen as an option to overcome this. There are various DG technologies available in market. However, the DG technologies that have been widely used in Denmark are wind turbine generators and small gas turbine generators for combined heat and power application [1]. Gas turbines have become increasingly popular due to their lower greenhouse emission as well as the higher efficiency, especially when connected in a combined cycle setup [2]. The large wind farms connected at transmission level have variable speed WTGs but old small wind turbines connected at the distribution level are largely fixed-pitch and fixed-speed turbines. The significant penetration of GTGs and WTGs in the Danish distribution systems has opened an option to operate distribution systems in island mode, supplying power to small areas, due to technical and economical reasons. Also, the IEEE Std. 1547-2003 [3] states that the implementation of intentional islanding of DGs is one of its tasks for future consideration. However, stabilizing frequency of an islanded

system is one of the major issues as loads and generations in the islanded systems seldom match. In such a situation, speed governors can be implemented to control the frequency of the system.

This paper presents possible governor configurations that can be used to control the frequency of the islanded system. Their performance during grid connected state is also analyzed. The modeling of GTG and WTG is explained in Section II. The performance of the governors is tested in a radial distribution system, which is presented in Section III. The possible governor configurations are presented in section IV. GTG, WTGs and governors are modeled in DigSILENT PowerFactory 13.2.334 and the results are presented in Section V. Section VI concludes the paper.

II. MODELING OF GTG AND WTG

A gas turbine usually consists of a compressor and a turbine operating under the Brayton cycle [4] consisting of four completely irreversible processes namely; isentropic compression, isobaric heat addition, isentropic expansion, and isobaric heat rejection. A typical model of a gas turbine in stability studies models load-frequency control, temperature control and acceleration control. These components have been reviewed in [5],[6].

Various gas turbine models have been proposed for stability analysis. Rowen proposed a simplified mathematical model for heavy duty gas turbines in [7]. He extended the model by including inlet guide vanes in [8]. But the control loops for the speed and acceleration remained essentially the same. IEEE also presented a model of a gas turbine in [9]. Another model is the GAST model [10], which is one of the most commonly used dynamic models [11]. These models and other models are reviewed in details in [12]. For the purpose of this study, it is assumed that the temperature control loop will not become active and hence the GAST model is chosen for its simplicity. The GAST model for the gas turbine generator is shown in Figure 1.

A WTG model consists of an aerodynamic model, a mechanical model and a generator model. The mechanical model for the drive train can be modeled as a two-mass model or a single-mass model. In the two-mass model, one mass accounts for hub and blades and the other accounts for the rotor of the generator. In the single-mass model, all the

P. Mahat, Z. Chen and B. Bak-Jensen are with the Institute of Energy Technology, Aalborg University, Pontoppidanstræde 101, Aalborg, DK-9220, Denmark (e-mails: pma@iet.aau.dk, zch@iet.aau.dk, bbj@iet.aau.dk).

The work is funded by PSO program, project 2006-1-6316, "Operation and Control of Modern Distribution Systems".

rotating parts of the windmill are lumped in a single mass. Various wind turbine models have been proposed in different literatures [13]-[17]. A simplified block diagram of a fixed-pitch fixed-speed wind turbine system is shown in Figure 2. For the purpose of this study, wind turbines are modeled as a two-mass system as it is adequate for power system transient studies [18].

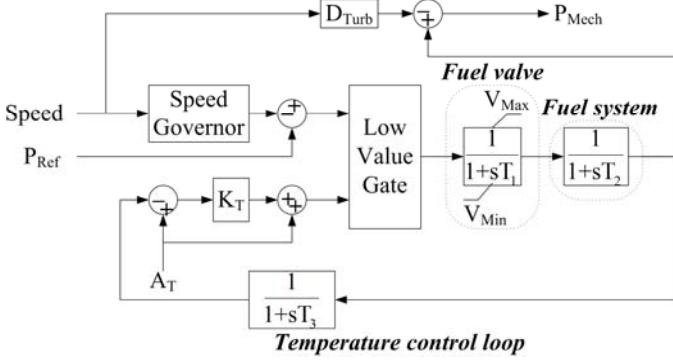

Fig. 1. GAST model

In Figure 1, T_1 is controller time constant, T_2 is fuel system time constant, T_3 is load limiter time constant, A_T is ambient temperature load limit, K_T is temperature control loop gain, V_{Min} and V_{Max} are fuel controller minimum and maximum output, respectively, and D_{Turb} is frictional losses factor.

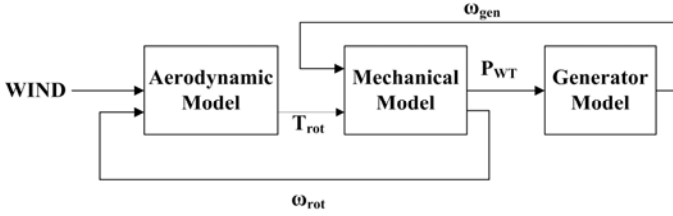

Fig. 2. Simplified wind turbine generator model

The aero dynamic torque (T_{rot}) developed by wind is given by Equation 1 [19].

$$T_{rot} = \frac{1}{\omega_{rot}} C_p \left(\frac{\rho \pi R^2 v^3}{2} \right) \quad (1)$$

Where, ρ is air density, R is turbine rotor radius, v is wind velocity, ω_{rot} is rotor speed and C_p is power coefficient, which is a function of tip speed ratio (λ) for fixed pitch turbines. λ is given by Equation 2 [19].

$$\lambda = \frac{R\omega_{rot}}{v} \quad (2)$$

In case of a two-mass model, the angular difference between the two ends of the flexible shaft (θ) is given as in Equation 3 and the torque from low speed shaft (T_s) is given by Equation 4 [20].

$$\frac{d\theta}{dt} = \omega_{rot} - \omega_{gen} \quad (3)$$

$$T_s = K\theta + D(\omega_{rot} - \omega_{gen}) \quad (4)$$

where, ω_{gen} is generator speed, K is drive train stiffness, D is drive train damping constant and J is inertia of the rotor. The rotor speed is given as in Equation 5 and the power from wind turbine to generator (P_{WT}) is given by Equation 6.

$$\frac{d\omega_{rot}}{dt} = \frac{(T_{rot} - T_s)}{J} \quad (5)$$

$$P_{WT} = \omega_{gen} T_s \quad (6)$$

III. MODEL OF DISTRIBUTION SYSTEM

Figure 3 shows the model of the distribution system in which the controllers are tested. The distribution system is a part of a distribution network, owned by Himmerlands Elforsyning, in Aalborg, Denmark.

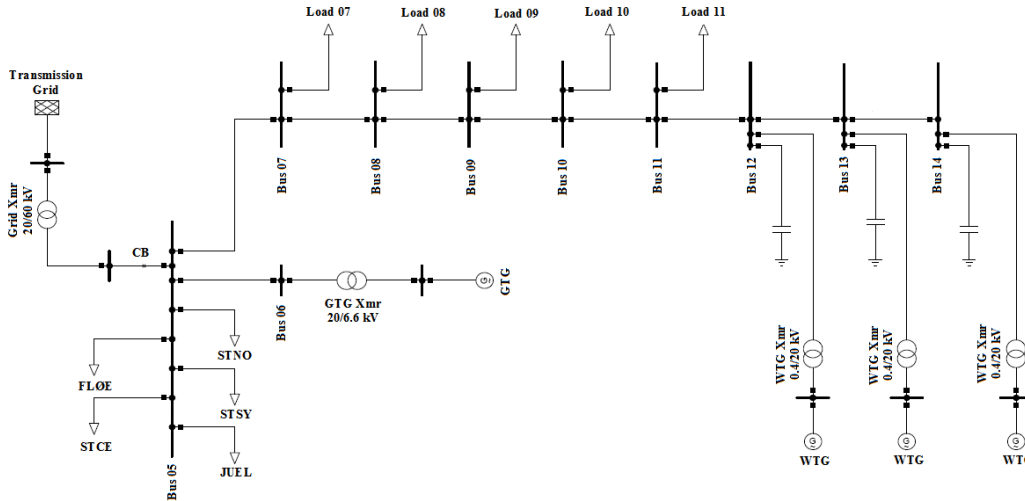

Fig. 3. Test distribution system

islanded and when it is connected to grid, are presented in the following sections.

A. Performance of controllers when islanded

The distribution system is islanded at $time = 0$ second (s). Now, the GTG contributes a huge percentage of the total power generation in the islanded system and thus governs the distribution system frequency. Figure 7 shows the distribution system frequency when the distribution system is islanded. Figure 8 and 9 show the GTG turbine power and active power, respectively. Similarly, Figure 10 shows the WTG active power when the distribution system is islanded.

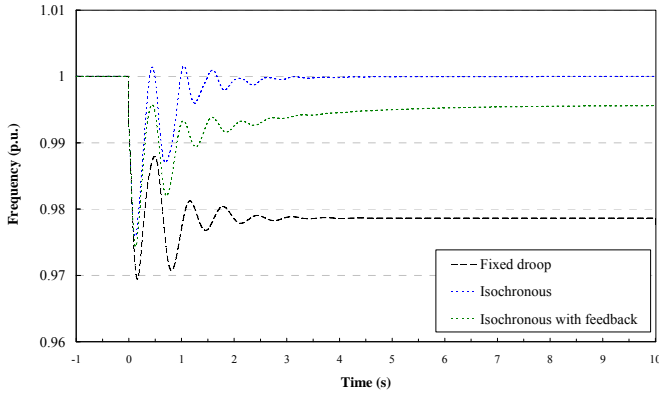

Fig. 7. Islanded distribution system's frequency with different controllers

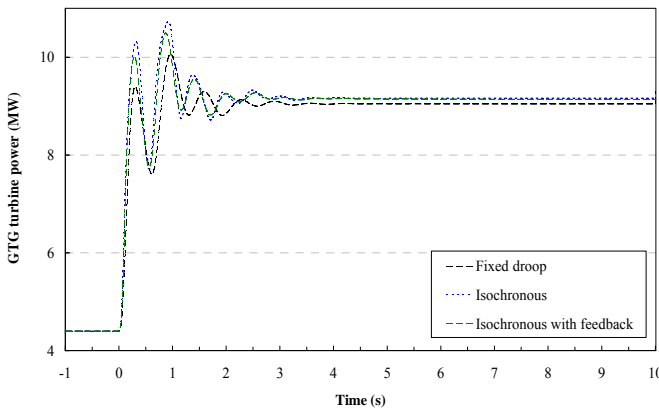

Fig. 8. GTG turbine power after islanding with different controllers

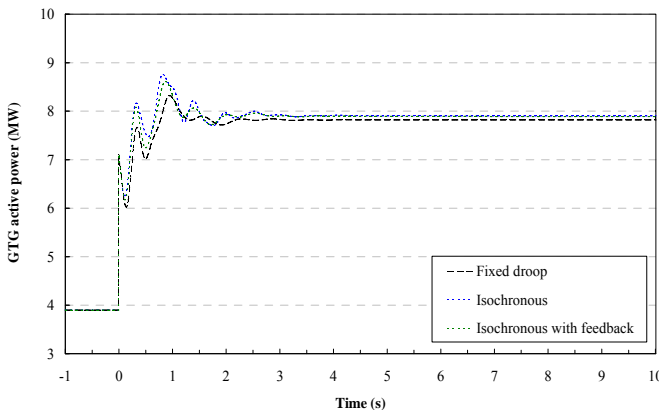

Fig. 9. GTG active power after islanding with different controllers

From the Figure 7, it can be seen that, with the speed droop, the islanded distributed system settles at a frequency, which is below the power quality limit of 0.99 p.u.. However, as expected, the isochronous controller brings the frequency back to 1 p.u. when the system is islanded. Even though the isochronous controller with feedback does not bring the frequency back to nominal, the final frequency error is significantly less compared to the one with speed droop controller.

As the loads are frequency dependent, the GTG will produce least power when the speed droop controller is employed and maximum power when the isochronous control is employed. Also, power produced from WTGs will be maximum when the frequency is brought back to nominal with the isochronous control and minimum when the speed droop controller is employed with the wind speed remaining the same. However, the difference is very small as the WTGs are producing a very small amount of power.

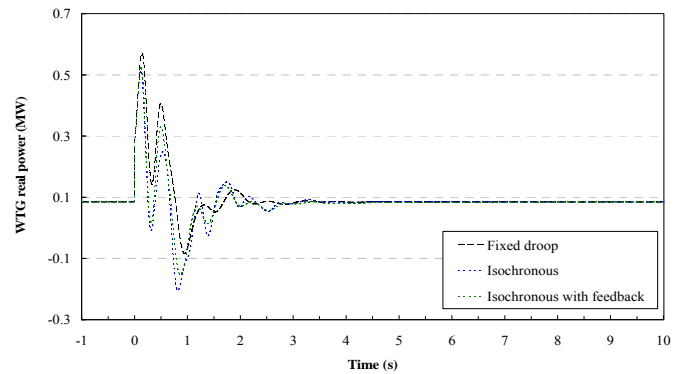

Fig. 10. GTG active power after islanding with different controllers

B. Performance of controllers when grid connected

To see the performance of controllers, when they are connected to the grid, system frequency is changed as shown in Figure 11. Figure 11 also shows the change in speed of the GTG, with different controllers, as a response to the grid frequency change. Figures 12 and 13 show changes in turbine power and active power of the GTG with different controllers, when the grid frequency changes. Similarly, Figure 14 shows the variation in output power of the WTG for the same fluctuation in system frequency.

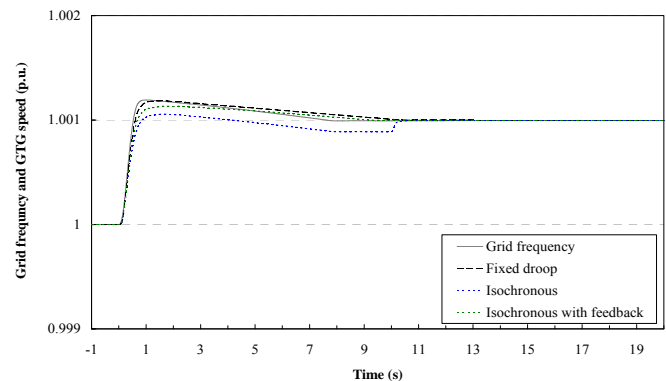

Fig. 11. Grid frequency and GTG speed for grid frequency change with different controllers

The speed droop controller will try to follow the grid frequency when it changes. With the speed droop, the GTG will lower its turbine power and hence active power and settles at a new operating point. The isochronous controller will also lower GTG turbine power and hence its active power to bring the speed back to reference speed. But, since the grid is too strong, it cannot bring the GTG speed to reference. Eventually, the turbine power becomes zero and GTG rotates at grid frequency. However, with the feedback, the reference speed is increased and the GTG finds the new operating point similar to the case of speed droop controller. In case of WTGs, with the change in the frequency, the tip speed ratio and hence power coefficient and output power change.

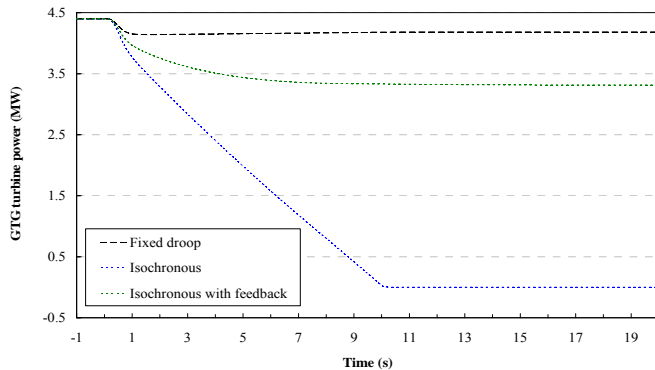

Fig. 12. GTG turbine power for grid frequency change with different controllers

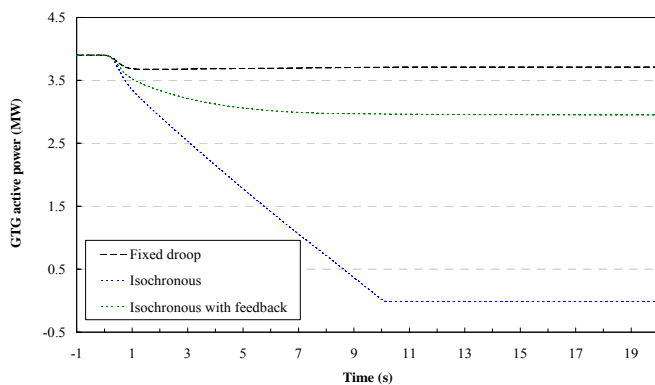

Fig. 13. GTG active power for grid frequency change with different controllers

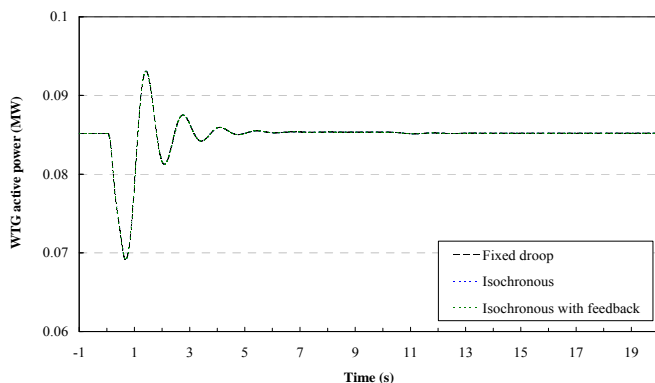

Fig. 14. WTG active power for grid frequency change with different controllers

Having a higher droop helps when the system is grid connected as output power does not change much with changing grid frequency. Thus, the speed droop controller will perform better at grid connected condition. However, it performs badly when the system is islanded. The isochronous controller performs the best when the system is islanded by bringing the frequency back to nominal. But any deviation in grid frequency, when the system is connected to the grid, will lead to output power being driven to limits. As the grid is much stronger compared to a small generator like the GTG in the test distribution system, change in generator power have negligible impact in system frequency. Furthermore, it makes no economical sense to reduce the power generation to zero to maintain system frequency to nominal while reduction in power production is hardly having any impact in system frequency. Hence, it is desirable to have least fluctuation in power when the small generators are connected to grid. Though at the same time, bring frequency within an acceptable limit for islanding operation is also a priority. The isochronous controller with feedback performs relatively well in both cases. The output power is not driven to limits when the system frequency fluctuates and it keeps the frequency within the acceptable limits when the distribution system is islanded.

VI. CONCLUSIONS

The speed droop controller is very effective to control power when the generator is connected to grid. But, depending on power imbalance in the islanded distribution system, the final settling frequency can be outside the power quality limit. On the other hand, the isochronous controller can bring the frequency back to nominal value when the system is islanded. However, when connected to grid, its operating point is driven to either lower or upper limit even with the slightest deviations in frequency. The presented isochronous controller with feedback takes the advantage of both the above mentioned controllers and performs satisfactorily in both situations. It is basically a PI controller like the isochronous controller but changes its speed reference, with a feedback, like the speed droop controller.

The presented isochronous controller with feedback can find a new operating point when the frequency of the strong grid, to which it is connected, deviates. It also keeps the frequency within an acceptable limit when the distribution system is islanded. Thus, the isochronous controller with feedback is a possible solution to control gas turbine generators and stabilize frequency when the distribution system with WTGs and GTGs is islanded.

APPENDIX

TABLE AI
LOAD DATA

Loads	Active Power	Reactive Power
	(MW)	(Mvar)
FLØE	0.787	0.265
JUEL	0.811	0.147
STCE	1.212	0.16
STNO	2.109	0.286
STSY	1.757	0.484
Load 07	0.4523	0.2003
Load 08	0.7124	0.3155
Load 09	0.1131	0.0501
Load 10	0.1131	0.0501
Load 11	0.1131	0.0501

TABLE AII
EXCITATION SYSTEM DATA

Parameters	Value
Controller gain (p.u.)	150
Controller maximum input (p.u.)	3
Controller maximum output (p.u.)	7
Controller minimum input (p.u.)	-3
Controller minimum output (p.u.)	-7
Controller time constant (s)	0.02
Excitor current compensation factor (p.u.)	0
Filter delay time (s)	1
Filter derivative time constant (s)	1
Measurement delay (s)	0
Stabilization path delay time (s)	0.15
Stabilization path gain (p.u.)	0.01

TABLE AIII
WIND DRIVE TRAIN DATA

Parameters	Value
J Rotor Inertia (kg mm)	$4 \cdot 10^6$
K Drive train Stiffness (Nm/rad)	10000
D Drive train Damping (Nm/rad)	0

TABLE AIV
GOVERNOR SYSTEM DATA

Parameters	Value
R Speed Droop (p.u.)	0.05
K_i Isochronous controller gain (p.u.)	40
T_i Isochronous controller time constant (s)	1
K_{FB} Feedback gain (p.u.)	0.01
T₁ Controller time constant (s)	0.05
T₂ Fuel system time constant (s)	0.1
T₃ Load limiter time constant (s)	10.2
A_T Ambient temperature load limit (p.u.)	0.909
K_T Temperature control loop gain (p.u.)	2
V_{Min} Controller minimum output (p.u.)	0
V_{Max} Controller maximum output (p.u.)	1
D_{Turb} Frictional losses factor (p.u.)	0

ACKNOWLEDGMENT

Authors would like to thank Himmerlands Elforsyning A.m.b.a, SEAV-NVE and DEFU, Denmark for their support for the work.

REFERENCES

- [1] Danish Energy Authority, "Energy Statistics 2006," 2007.
- [2] K. Qiu, A.C.S. Hayden, and P. Sears, "Energy from waste/gas turbine hybrid combined cycles and their potential for GHG emissions reduction," IEEE EIC Climate Change Technology, pp. 1-9, May 2006.
- [3] IEEE Standard 1547TM, "IEEE Standard for Interconnecting Distributed Resources into Electric Power Systems," June 2003.
- [4] Y. A. Cengel and M. A. Boles, "Thermodynamics: An Engineering Approach," New York: McGraw-Hill, 1994.
- [5] P. Centeno, I. Egido, C. Domingo, F. Fernandez, L. Rouco, and M. Gonzalez, "Review of gas turbine models for power system stability studies," 9th Spanish Portuguese Congress on Electrical Engineering, Marbella, Spain, 2005.
- [6] Q. Zhang and P. L. So, "Dynamic modelling of a combined cycle plant for power system stability studies," IEEE PES Winter Meeting 2000, vol. 2, pp. 1538-1543, 2000.
- [7] W. I. Rowen, "Simplified mathematical representations of heavy-duty gas turbines," ASME Journal of Engineering for Power, vol. 105, pp. 865-869, 1983.
- [8] W. I. Rowen, "Simplified mathematical representations of single shaft gas turbines in mechanical drive service," International Gas Turbine and Aeroengine Congress and Exposition, Cologne, Germany, 1992.
- [9] Working Group, on Prime Mover and Energy Supply Models, "Dynamic models for combined cycle plants in power system studies," IEEE Transaction on Power System, vol. 9, no. 3, pp. 1698-1708, Aug. 1994.
- [10] Power System Simulator - PSS/E, "Program Operation Manual," Power Technologies, Inc., New York, USA.
- [11] M. Nagpal, A. Moshref, G. K. Morison, and P. Kundur, "Experience with testing and modeling of gas turbines," IEEE PES Winter Meeting, 2001, vol. 2, pp. 652-656, 2001.
- [12] S. K. Yee, J. V. Milanovic, and F. M. Hughes, "Overview and comparative analysis of gas turbine models for system stability studies," IEEE Transactions on Power Systems, vol. 23, no. 1, pp. 108-118, Feb. 2008.
- [13] S. Santoso and H. T. Le, "Fundamental time-domain wind turbine models for wind power studies," Renewable Energy, vol. 32, no. 14, pp. 2436-2452, Nov. 2007.
- [14] A. D. Hansen, F. Iov, P. Sørensen, N. Cutululis, C. Jauch, and F. Blaabjerg, "Dynamic wind turbine models in power system simulation tool DlgSILENT," Risø DTU, Aug. 2007.
- [15] W. Qiao, R. G. Harley, and G. K. Venayagamoorthy, "Dynamic modeling of wind farms with fixed-speed wind turbine generators," IEEE PES General Meeting 2007, pp. 1-8, June 2007.
- [16] L. Dusonchet, F. Massaro, and E. Telaretti, "Transient stability simulation of a fixed speed wind turbine by Matlab/Simulink," International Conference on Clean Electrical Power 2007, pp. 651-655, 2007.
- [17] M. Martinsa, A. Perdanaa, P. Ledesma, E. Agneholma, and O. Carlson, "Validation of fixed speed wind turbine dynamic models with measured data," Renewable Energy, vol. 32, no. 8, pp. 1301-1316, July 2007.
- [18] S.M. Muyeen, M. Hasan Ali, R. Takahashi, T. Murata, et. al., "Comparative study on transient stability analysis of wind turbine generator system using different drive train models," IET Renewable Power Generation, vol. 1, no. 2, pp. 131-141, June 2007.
- [19] G. L. Johnson, "Wind energy systems," Prentice-Hall, 1985.
- [20] V. Akhmatov, "Variable-speed wind turbines with doubly-fed induction generators. Part I: Modelling in dynamic simulation tools," Wind Engineering, vol. 26, no. 2, pp. 85-108, 2002.
- [21] P. Mahat, Z. Chen, and B. Bak-Jensen, "A hybrid islanding detection technique using average rate of voltage change and real power shift," IEEE Transaction on Power Delivery, to be published.
- [22] IEEE, "IEEE Recommended Practice for excitation System Models for Power System Stability Studies," IEEE Press, 1992.



Pukar Mahat received B.Eng and M.Eng degree from Kathmandu University, Nepal and Asian Institute of Technology, Thailand, respectively.

He was Research Associate at Asian Institute of Technology, Thailand. Since 2007, he has been a PhD candidate at Institute of Energy Technology, Aalborg University, Denmark. Mr. Mahat's research interest includes Distributed Generation, Wind Power Generation and Distribution System Planning. He is a

Certified Engineer in Nepal.



Zhe Chen (M'95, SM'98) received the B.Eng. and M.Sc. degrees from Northeast China Institute of Electric Power Engineering, Jilin City, China, and the Ph.D. degree from University of Durham, U.K.

He was a Lecturer and then a Senior Lecturer with De Montfort University, U.K. Since 2002, Dr. Chen has been a Research Professor and is now a Professor with the Institute of Energy Technology, Aalborg University, Denmark. He is the coordinator of Wind Power System Research program at the Institute of Energy Technology, Aalborg University. His research areas are power systems, power electronics and electric machines; and his main current research interests are wind energy and modern power systems. He has more than 170 publications in his technical field.

Dr Chen is an Associate Editor (Renewable Energy) of the IEEE Transactions on Power Electronics, Guest Editor of the IEEE Trans. on PE on Special Issue on Power Electronics for Wind Energy Conversion. He is a Member of the Institution of Engineering and Technology (London, U.K.), and a Chartered Engineer in the U.K



Birgitte Bak-Jensen (M'88) received her M.Sc. degree in Electrical Engineering in 1986 and a Ph.D. degree in "Modeling of High Voltage Components" in 1992, both degrees from Institute of Energy Technology, Aalborg University, Denmark.

From 1986-1988, she was with Electrolux Elmotor A/S, Aalborg, Denmark as an Electrical Design Engineer. She is an Associate Professor in the Institute of Energy Technology, Aalborg University, where she has worked since August 1988. Her fields of interest are modeling and diagnosis of electrical components, power quality and stability in power systems. During the last years, integration of dispersed generation to the network grid has become one of her main fields, where she has participated in many projects concerning wind turbines and their connection to the grid.