



## EXPERIMENTAL STUDY OF FATIGUE CHARACTERISTICS OF LAMINATED COMPOSITE PLATES

Prof. Dr. Muhsin J. Jweeg, Dr. Ali Hussain Al-Hilli, Hussain Mohan Suker  
Nahrain University/ College of Engineering

### ABSTRACT

The fatigue damage is a dangerous and could be considered as the most unwanted failure in the materials that are used to construct the engineering components. As composites take an advanced position in the industry of aircraft, marine and many other high performance components, because of their high ability and their light weight and for their strength, this forces us to find the deformation and data to give a good expectation for the composite behavior under fatigue and other types of damage.

In this study the material used is the glass fiber with a polyester resin; the experiment used a device to force the composite to be under a bending fatigue through specified deflection and then the force is measured. The results for different values of imposed deflection and different thicknesses are presented, as S-N curves and in a logarithmic way.

Fractography has been used to characterize the fatigue damage in the composite, it is shown that the fatigue damage in the composite is a complex, interactive damage process and combines between several damage mechanisms such as delamination, fiber breakage, matrix cracking and fiber matrix debonding.

### دراسة عملية لخواص الكلال للصفائح المركبة الطباقية

#### الخلاصة:

إن ضرر الكلال هو اخطر أنواع الإضرار الميكانيكية التي قد تحصل في داخل المواد ويعتبر الأقل رغبة. بينما تأخذ المواد المركبة موقعا متقدما في صناعة الطائرات، السفن والعديد من المكونات العالية الأداء الأخرى، بسبب قدرتها العالية ووزنهم الخفيف ومتانتها العالية، هذا يجبرنا لإيجاد المعلومات والبيانات إعطاء توقع جيد لسلوك المواد المركبة تحت الإعياء والأنواع الأخرى من الضرر.

في هذه الدراسة، المادة المستعملة هي الليف الزجاجي والمادة المستخدمة كمصفوفة هي راتنج البولستر؛ استعملت التجربة أداة لإجبار المواد المركبة لكي تكون تحت انحناء الإعياء من خلال امالة محددة لفرض قوة محددة.

إن النتائج للقيم المختلفة من النتائج العملية لعدد من العينات ذات الأسماك المختلفة وتحت أحمال إجهاد مختلفة كانت موضوعة على شكل منحني بياني لكل من القوة مع الإجهاد المسلط لكل حالة من الحالات وتم وضع شكل بياني يمثل الإجهاد مع عدد الدورات على محاور لوغاريتمية.

من خلال كل هذا تم التوصل إلى إن ضرر الإعياء في المواد المركبة عملية تفاعلية معقدة بين عدّة و فقدان قابلية التفصيح (Delamination) أليات ضرر مثل تكسر الألياف، تصدّع المصفوفات و بين الألياف والمصفوفة.

**KEY WORDS:** Fatigue, Composite, Delamination, Matrix debonding, S-N curve.

## INTRODUCTION

In general fatigue of fiber-reinforced composite materials is a quite complex phenomenon, and a large research effort is being spent on it today. Fiber-reinforced composites have a rather good rating as regards life time in fatigue. The same does not apply to the number of cycles to initial damage nor to the evolution of damage. Composite materials are inhomogeneous and anisotropic, and their behavior style is more complicated than that of homogeneous and isotropic materials such as metals. The main reasons for this are the different types of damage that can occur (e.g. fiber fracture, matrix cracking, matrix crazing, fiber buckling, fiber-matrix interface failure, delaminations,...etc), their interactions and their different growth rates.

The fatigue models can be classified in three major categories:

1. Fatigue life models, which do not take into account the actual degradation mechanisms but use S-N curves (influence of stress amplitude on occurrence of final failure) or Goodman –type 22 diagram (influence of mean stress level) and introduce some sort of fatigue failure criterion.
2. Residual strength models, which describe the degradation in the initial static strength, equally without taking into account stiffness reduction.
3. The last category uses one or more damage variables related to measurable manifestation of damage (number of transverse matrix cracks, delamination size) or to the residual stiffness.

Phenomenological residual stiffness model which predicts the stiffness degradation as well as final failure of the composite component was presented by [Paepegem 2001], the reserve to failure has been evaluated by means of modified use of Tsai-Wu static failure criterion. The fatigue damage model has been applied to displacement-controlled bending fatigue experiment of plain woven glass/epoxy specimens, the damage and stress redistribution, as well as the force- cycle history have been simulated and compared to experimental result.

[Liu 2004] proposed a damage cumulative model for fatigue life predication of composite laminates, it is constructed on the ply level and uses a multiaxial damage index to quantify the damage caused by different stress components. [Daneila 2007] developed a model for damage progress to fatigue failure in cyclic loaded woven composite materials with polymer, the relative stiffness is changed per cyclic loading at given stress or strain level.

The correlation between the stiffness degradation rate and the loading parameter is described as power function dependence; this model divides the S-N curve of the fiber reinforced polymer composite into three regions, the first region approaches a nearly horizontal line where the number of cycles to failure depends more on statistical strength distribution than the stress level, the second region is more classical fatigue behavior where the S-N correlation can be describe as a power law function and the third region suggest a fatigue limit where an infinite lifetime is found below a given stress or strain level –the fatigue strength.

[Diawekar 2002] produced an analytical model supported by numerical simulation which describes the behavior of the energy release of composite materials subjected to the fatigue, this model established that accumulation of damage due to intermittent surge in applied load reduces the energy release rate ((G)) of the material. The effect of constant amplitude, regularly applied overloads to the energy release rate of [0/90]<sub>n</sub> graphite/epoxy composite appears diminished as the structural integrity reduces over time suggesting the effect of the overloads is more severe during the initiation of delamination growth, their investigation shed light on the nature and extent of damage accumulation during spectral fatigue.

They established that the energy release rate reduces as the delamination length increases, indicating that during growth a delamination requires smaller amounts of energy in order to progress.

[Mohamed 1997] built a model for predication the behavior of laminates composite under fatigue loading this model uses a technique called progressive fatigue damage modeling which is capable of predicating the residual strength, residual stiffness, and fatigue life of composite laminate.



The stress analysis, failure analysis and material property are the three major components of the model for the stress analysis. There is a finite element technique proposed, it is based on the state of stress of different failure modes detected by a set of fatigue failure criteria. This technique restricts the application of failure criteria to limited states of stresses.

The model determines the state of damage at any load level and number of cycles from failure initiation and propagation to catastrophic failure. The model is able to predict the residual strength residual life, final failure mechanisms and final fatigue life of composite laminate under general fatigue loading condition.

[Miyano 1997] proposed a prediction method of fatigue strength of polymer composites for an arbitrary frequency, stress ratio and temperature. This method is based upon the four hypotheses (i) same failure mechanism for static, creep and fatigue failure, (ii) same time-temperature superposition principle for all failure strengths, (iii) linear cumulative damage law for monotone loading and (iv) linear dependence of fatigue strength upon stress ratio. J Lee W et. al [Lee 1989] proposed a model for predicting fatigue life of cross-ply laminates which develop transverse cracking up to the characteristic damage state (CDS) level before fatigue failure. The fatigue life consists of two portions: the portion necessary to reach the CDS and the residual life after attainment of the CDS. The CDS life is described based on the relationship between residual stiffness and crack density and the stress-life curve of the 900 lamina. The residual life after CDS was obtained by calculating the stress carried by the 0 plies and assuming that these plies within the damaged laminate behave like a 900 lamina under cyclic loading.

Fatigue life predictions were in good agreement with experimental results for three graphite/epoxy cross-ply laminates.

[Hwang 1985] and [Han 1985] built damage models using fatigue modulus and resultant strain, and prediction of fatigue life of composite materials using degradation and damage models, this approach can predict accurately the multi-stress level fatigue life as well as single-stress level fatigue life of composite materials.

Fatigue life is predicted by the following procedures:

- (1) Establish the fatigue modulus degradation model [Mahmood 2007].
- (2) Find fatigue life equation as a function of fatigue modulus.
- (3) calculate the fatigue life using strain failure criterion, degradation models for composite damage are generalized; the three-parameter degradation model is found most suitable for predicting fatigue life of composites.

Theoretical equation for predicting fatigue life is formulated using the fatigue modulus and its degradation rate, this relation is simplified by strain failure criterion for the practical application, it is proved that the final formula predicts the fatigue life of a glass fiber epoxy composite material better than S-N curve. "Fatigue modulus concept" is defined as a slope of applied stress and resultant strain at a specific cycle.

Fatigue modulus degradation is studied using an assumption that the fatigue modulus degradation rate follows a power function of fatigue cycle.

[Mahmood 2007] presented a simulation process by which the cyclic stresses and fatigue loadings on its constituents could be predicted for an under fatigue loading lamina model introduces a new coupled stiffness/strength technique by relating lamina stiffness to the stress field in its constituents. Therefore, the stress field and strength considerations in its constituents could be studied when the lamina stiffness is determined by a non-destructive process. For representing a complete description of the constituents' properties and their interactions, the effect of fiber/matrix interface debonding is introduced into the model.

## PREPERATION OF MAKING THE SPACIEMEN

The specimens which fabricated consisted of plain E-glass woven fiber piles in a thermosetting polyester matrix They were manufactured by hand lay-up technique, the thickness of the glass

fabrics was approximately (4.6, 3.75 and 2.5 mm) with a 400g/m<sup>2</sup> density and a warp number 3 per 10 mm.

The resin matrix employed was a low viscosity thermosetting polyester resin commonly used for hand lay-up at room temperature. This resin is cured at 70°C and is designed to wet easily the reinforcement fabrics employed in hand lay-up construction.

Fabrication of laminates was conducted by first cutting four 15cmx15 cm sections, and each section was ply oriented in the same direction as the previous ply . The fabrics were placed in a mold consisting of 30 cm x 30 cm ceramic plates with two X-ray photo sheets to avoid abrasive and insure flattening of specimen surfaces. As shown Fig. 1.

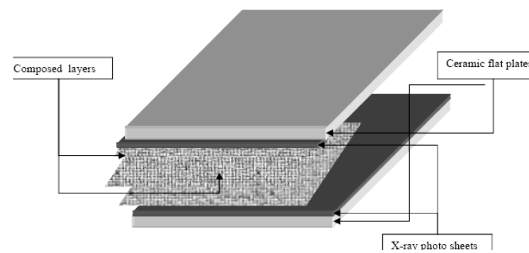

**Figure.(1) Schematic of mold of test specimen**

The X-ray photo sheet, which was first placed on the bottom ceramic plate, was wet with the catalyzed polyester resin before the first ply was placed on it. More catalyzed resin was applied to this first ply with brush until it was thoroughly wet. Following this, the remaining plies were placed in the mold following the same sequence. Once all the plies were placed on top of the stack, the assembly was heated to 70°C in an oven with sufficient pressure to get rid of the excess resin and the entrapped air bubbles. The cure time was 3 hours to ensure complete cross-linking. The volume fraction was determined to be 0.56 for the glass fiber composites (based on weighing of the fabric before impregnation, and the laminate after curing and using the weight density of the fibers and the resin)[ Ali Al-Hilli 2006].

The samples were cut into a 20 mm wide and a 150 mm long in rectangular shape using a steel saw and then finished by abrasive grinding of the edges.

### **EXPERIMENTAL ARRANGEMENT AND PROCEDURE FOR THE FATIGUETEST**

The experiments were carried out using a HSM20 alternating bending machine{Fig. 2} which was developed specially for flexural fatigue test on cantilever beam specimens and {Fig. 3}.

The device was modified by adding a new clamping device which consists of a metal shoulder which has two holes for a 8 mm bolt which connects the shoulder to the bridge of the machine so it is firmly connected to the bridge, a metal plate with 6 hexagonal bolts of 8 mm diameter is connected to the shoulder and produces the clamping device in which the rotating faceplate carries an adjustable eccentric bearing driving a connecting rod attached to the cantilever, shown in Fig. 4.

The bridge to which this test piece is clamped can be adjusted vertically so that the imposed displacement can be varied, shown in Fig. 5. A counter with a 50:1 reduction gear is driven by the electric motor, offering a 1:100 or 1:25 count depending on the frequency of the reciprocation.

This mechanism imposes an alternating displacement on the hinge (point C ) Fig.6 ,that connects the linkage with the lower clamp of the composite specimen ,at the other end the specimen is clamped ,hence the sample is loaded as a composite cantilever beam, the amplitude of the imposed displacement is a controllable parameter and the adjustable crank allows to choose between single-side and fully-reversed bending ,i.e. the deflection can vary from zero to the maximum deflection in one direction or in two directions respectively.



Figure (2) HSM20 alternating bending fatigue machine

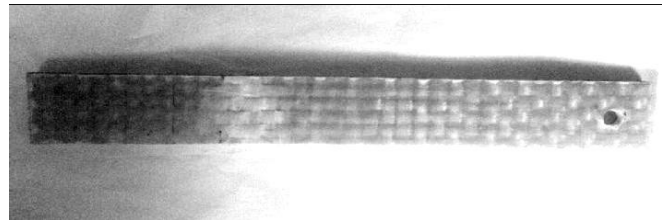

Figure (3) Composite specimen, 20mm wide and 150mm long dimension

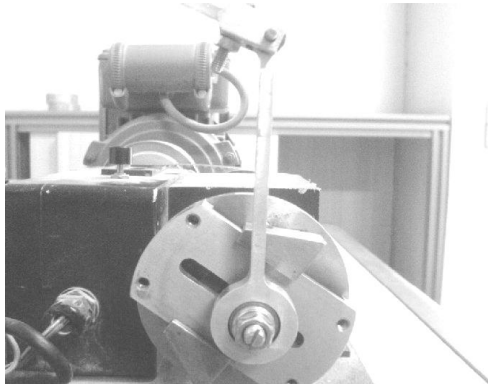

Figure (4) Rotating faceplate carries an adjustable eccentric bearing driving a connecting rod attached to the cantilever

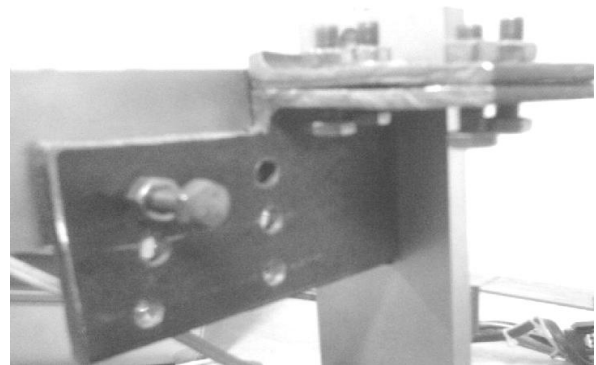

Figure (5) The shoulder connected to the bridge

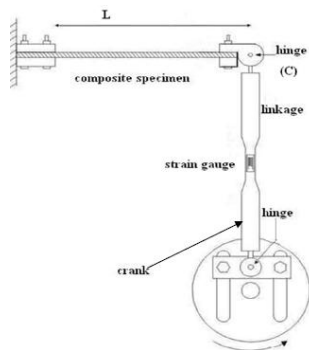

Figure (6) Schematic drawing of the crank-linkage mechanism.



Figure (7) Strain meter

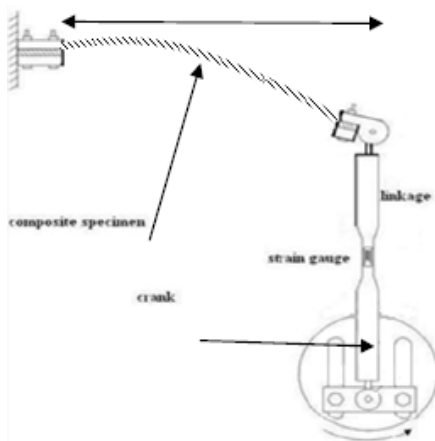

Figure (8) Schematic drawing of the crank-linkage mechanism howing

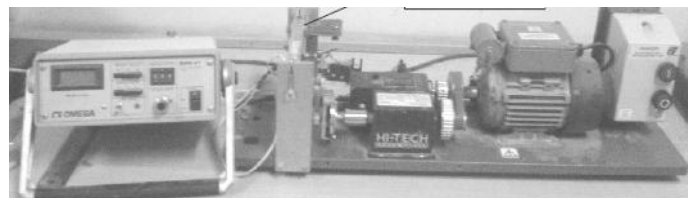

Figure (9). The complete device consisting of the strain meter and the fatigue machine

The connecting rod was molded from aluminum, the connecting rod contains a narrow region in which a strain gauge is connected, The strain gauge is used to measure any strain that affects the connecting rod this, strain is a result of the force which has effect on the specimen. The relation of the force and the strain gauge is calculated from a previous calibration, this calibration was made by putting the connecting rod under a known force and the strain of the force was measured using the strain meter shown in Fig. 7 from which a calibration curve was made, the calibration was remade at every beginning of the experiments.

When the experiment started the force which has effect on the specimens is taken to be the first point at which the number of cycles is zero the strain reading was taken when the connecting rod reached the lower point in which the maximum displacement is implied and it is the maximum force effecting the specimens, as number of cycles increased many reading were taken each reading present the maximum force affect the specimens. Fig. 6 a schematic drawing of the crank-linkage mechanism and it shows the machine before any movement and the displacement imposed is zero in this position while in Fig. 8 the machine is at lower point and the imposed deflection is maximum, the other Figures show the machine parts and the strain meter and the clamp, the machine at lower point and the imposed deflection is maximum.

The complete system of the experiments is shown in Fig. 9.

## RESULTS

It was well established that the composite materials are significantly different from their metal counterpart in manner in which fatigue fracture initiates and develops during the load cycling, It must be deal with a number of considerations which are unique to composite materials where only one or two fatigue damage characterization technique may be sufficient to completely characterize the damage in metals.

The unique phenomena by which the damage occurs in composite necessitate the use of several damage characterization techniques to understand the damage mechanism in the composite material.

The specific elements that need to be carefully examined are:

1. The typical failure modes.
2. The interplay of various failure modes.
3. Initiation and producing mechanism during various stages of fatigue life.

The following presentation of results of the present study and ensuing discussion is an effort to add on the existing knowledge of the fiber reinforced composites

The S-N curves are the most important method for the presentation of the fatigue effect on any kind of material whether is metal or it is made from the composite materials, in the Figures below the relation between the stress and the number of cycles is presented, these Figures are for different values of stress for a different thicknesses of composite specimens.

Fig. 10 gives the relation between the stress and number of cycles for the 10 layer composite with thickness 4.6 mm under a deflection of 15 mm, the initial stress is equal to (1435.2) N/mm<sup>2</sup> and it final failure is at (600123) cycle in which the stress indicated is to be equal to (184) N/mm<sup>2</sup>, there is another way for presentation of the stress versus number of relation in fatigue, this method uses a logarithmic relation in which both the stress and number of cycles are transferred into the logarithms with the passes 10, in Fig. 11, the relation between stress and number of cycles for the 10 layer composite with thickness of 4.6 mm under a deflection of 15 mm is presented in the logarithmic way.

The stress decreases during the test in different percentages as it decreases rapidly during the first two thousand cycles and this is first region in which the fatigue life initiates the first damages, most of these damages are a transverse crack that takes place in the composite structure, as cycles increase the decrease in the stress takes new pattern and the decrease is less sharp than the first two

thousand, and starts to take a linear decreasing and could be seen as a slope between two points these two points start around the 80 thousand cycles to the 300 thousand cycles.

After that the decrease returns to be a rapid drop in the value, to the final failure at the end of the 600000 cycles, this behavior can be explained as that the damage in the first few thousand cycles was because of the transverse crack and then it starts to grow in the composite and starts to produce the fiber matrix debonding, and then a delamination area which is noticeable and after that a final failure or breakage of fiber happens.

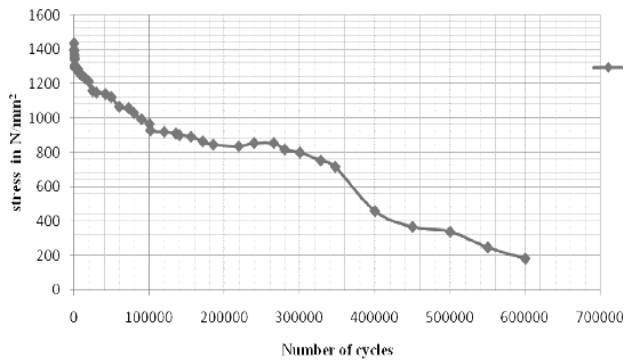

Figure(10). The relation between stress and number of cycles for the 10 layer 4.6 mm thick composite specimens under a deflection of 15mm.

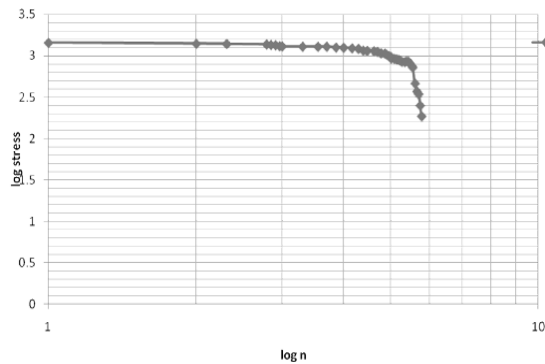

Figure (11) The relation between stress and number of cycles for the 10 layer composite with thickness 4.6 mm under a deflection of 15 mm is presented in the logarithmic way.

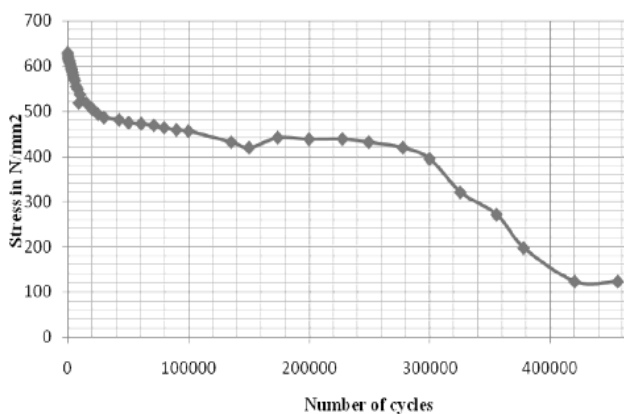

Figure (12).The relation between stress and number of cycles for the 10 layer 4.6 mm thick composite specimens under a deflection of 10mm.

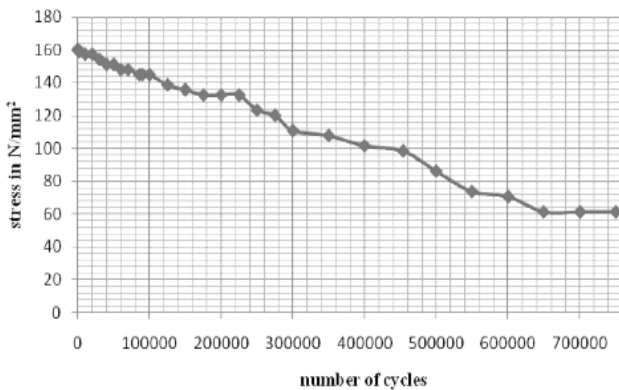

Figure (13).The relation between stress and number of cycles for th 10 layer 4.6 mm thick composite specimens under a deflection of 5mm.

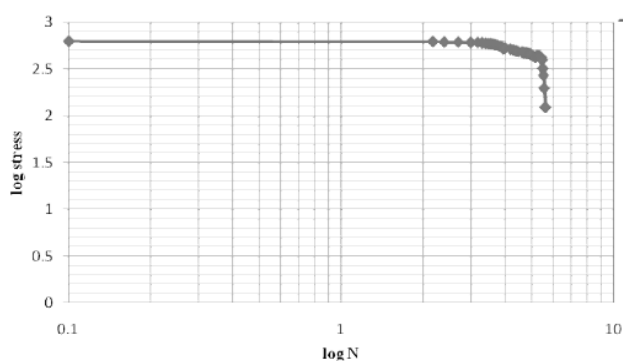

Figure (14). The relation between stress and number of cycles for the 10 layer composite with thickness 4.6 mm under a deflection of 10 mm is presented in the logarithmic way.

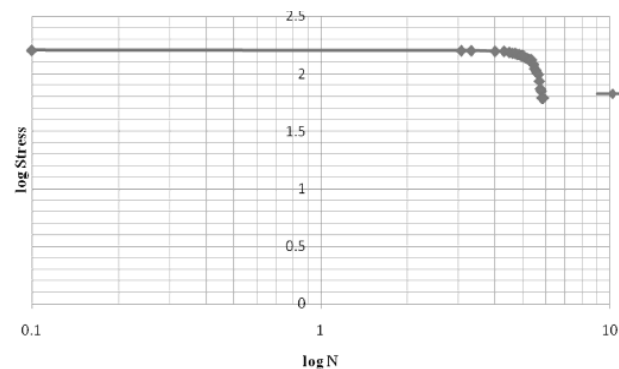

Figure (15). The relation between stress and number of cycles for the 10 layer composite with thickness 4.6 mm under a deflection of 5 mm is presented in the logarithmic way.



The modulus of elasticity is affected by the damage inside the composite material and this is because the modulus depends on the microstructure of the composite and as damage takes place in composite it affects the property of the composite, in the start the modulus which calculated from the material during the fatigue experiments was equal to 21.36 which had a 0.6 percentage of error for the value calculated from tensile tests, this number drops to the half after 340000 cycle and it ends at 2.7 in the final failure of the specimen.

Fig. 12 and Fig. 13 gives the relation of stress and number of cycles for the 10 layer with 4.6mm thickness composite materials under 10mm and 5mm deflection respectively ,also the relation in logarithmic way is also presented in the Fig. 14 and Fig. 15 respectively.

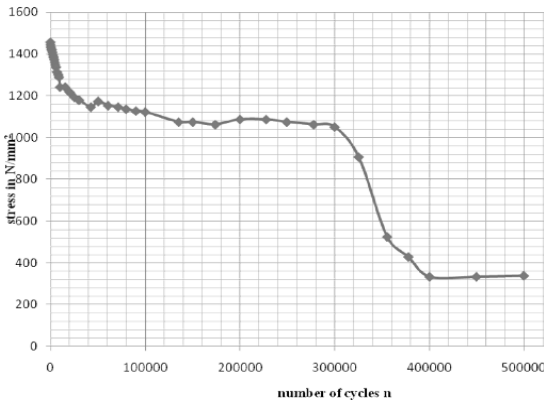

Figure (16).The relation between stress and number of cycles for the 8 layer 3.75 mm thick composite specimens under a deflection of 15mm.

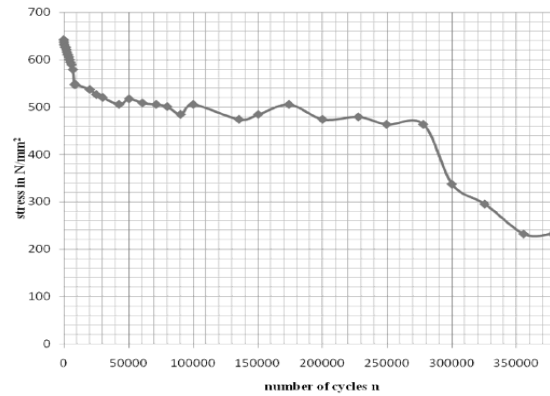

Figure (17).The relation between stress and number of cycles for the 8 layer 3.75 mm thick composite specimens under a deflection of 10mm.

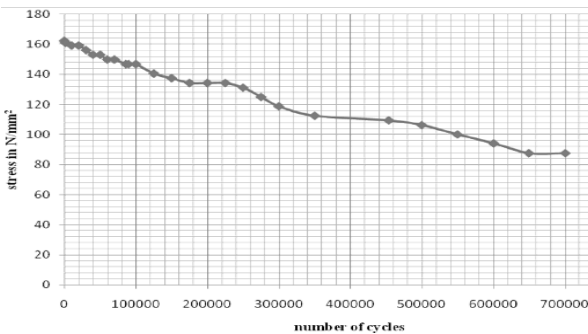

Figure (18).The relation between stress and number of cycles for 8 layer 3.75 mm thickness under 5 mm deflection.

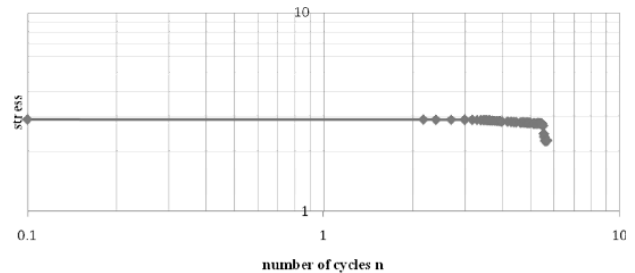

Figure (19).The relation between stress and number of cycles for the 8 layer composite with thickness 3.75 mm under a deflection of 15 mm is presented in the logarithmic way.

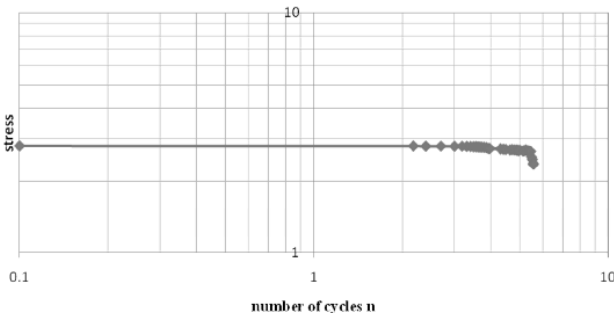

Figure (20).The relation between stress and number of cycles for the 8 layer composite with thickness 3.75 mm under a deflection of 10 mm is presented in the logarithmic way.

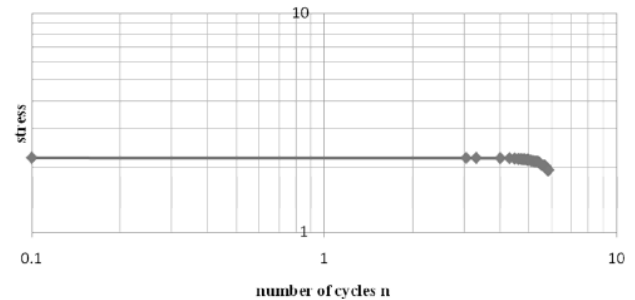

Figure (21).The relation between stress and number of cycles for the 8 layer composite with thickness 3.75 mm under a deflection of 5 mm is presented in the logarithmic way.



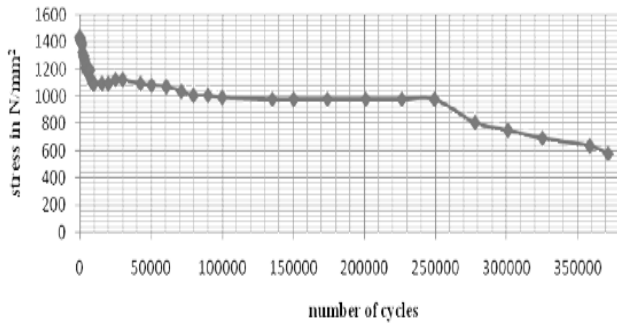

Figure (22) The relation between stress and number of cycles for 6 layer 2.5 mm thickness under 15 mm deflection.

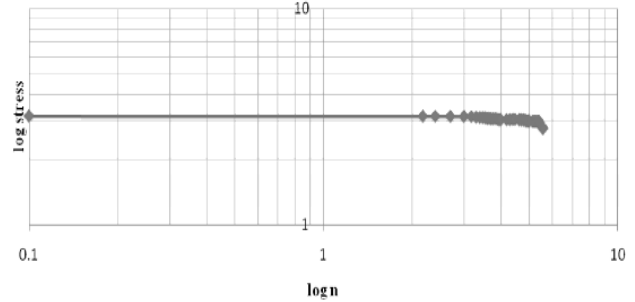

Figure (23) The relation between stress and number of cycles for the 6 layer composite with thickness 2.5 mm under a deflection of 15 mm is presented in the logarithmic way.

The relation between stress and number of cycles is shown here for the composite material of 8 layer and 3.75 mm thickness in the first one {Fig. 16}, the deflection is equal to 15 mm and in the second {Fig.17} it is 10mm while the third it is 5 mm {Fig.18} .Also the relation between stress and number of cycles is presented in logarithmic method in Fig. 19, Fig. 20, and Fig. 21, for 8 layer with 3.75mm thickness composite specimen for deflection of 15mm,10mm , and 5 mm respectively. For the specimens of 6 layer with a 2.5mm thickness under deflection 15 mm, stress relation with number of cycles is shown in Fig. 22 and in Fig.23 but in logarithmic relation. Equations were found for each of the Figures that show the relation between the stress and the number of cycles for the different thicknesses and different deflections as a polynomial equation with the 3rd degree, this is useful to fit all the data granted during experiments, the equation expression form is :

$$\sigma = a + b n + c n^2 + d n^3 \tag{1}$$

Table 1 shows these coefficients for conditions used in the present work, in which higher order coefficients (c and d) have negligible values hence linear behavior is dominant.

Table (1). Polynomial coefficients for equation (1)

Thickness (mm)	Deflection (mm)	a	b (10 <sup>-3</sup> )	c (10 <sup>-9</sup> )	d (10 <sup>-15</sup> )
4.6	15	1233.53	-2.72876	5.34	-6.54
4.6	10	553.76	-1.51825	6.85	-12.92
4.6	5	136.24	0.140561	-0.87	0.73
3.75	15	1285.43	-1.20413	1.01	-6.21
3.75	10	573.92	-1.48141	9.09	-20.85
3.75	5	138.51	0.119892	-0.73	0.67
2.5	15	1217.27	-3.73584	20.09	-40.21

Fig. 24 shows the load versus the number of cycles. The initial load for the 4.6mm thickness specimen starts with 156 N and it decreases to reach 20 N at the end, the first 10000 cycles show a rapid decrease in the load needed to produce deflection and reaches to about 136 N, this decrease is about 13% of the initial loading, and as it reach the first 100000 cycles the load equal to 105 N and it equal to 32% from initial load, and as the cycles continue and the time go on the load reaches a 50% of the initial load at 3.4\*10<sup>5</sup> cycles, but before that we notice that the decrease below the 10<sup>5</sup> cycles is very limited and it is a small percentage of decrease , in comparison to the first 10<sup>4</sup> cycle, after the 4\*10<sup>4</sup> cycles the load decreases and reaches the failure position at around 600000.

While the decrease in the 8 layer 3.75 mm thickness specimens starts from 84.5 N and reach the 72.8 N which is equal to a 14% of the initial load and reaches to 75% of the initial load at 135000

cycles and reaches 50% at about  $3 \times 10^5$  cycle when it reaches the  $3 \times 10^5$  cycle a rapid decrease was shown and a final failure occurs .

The third thickness is equal to 2.5 mm which comes from 6 layer of fiber glass yarns as in previous curves it decrease at a fast rate and reaches to a position in which the decrease to the final failure in a study range that starts from the  $1.6 \times 10^4$  cycle to the end and the final failure.

The relations between the load and number of cycles and the stress versus number of cycles for the 10 layer 4.6 mm thickness composite subjected to 15mm,10mm, and 5mm deflection are shown in Fig.25 and Fig.26 respectively.

The relations between the load and number of cycles and the stress versus number of cycles for the 8 layer 3.75 mm thickness composite subjected to 15mm,10mm, and 5mm deflection are shown in Fig. 27 and Fig. 28 respectively.

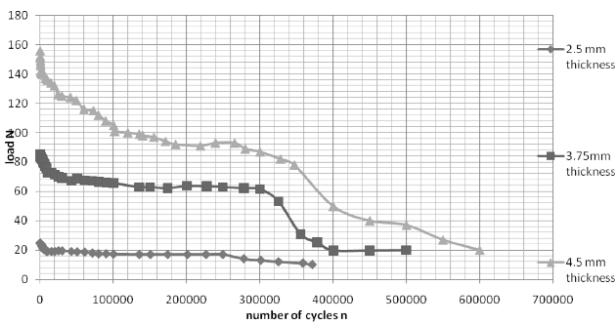

Figure (24) The relation between 3 different thicknesses of composite they are, 4,6mm ,3,75mm, and 2.5 mm under 15 mm deflection.

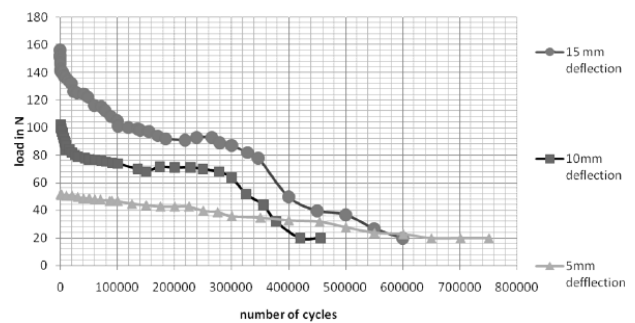
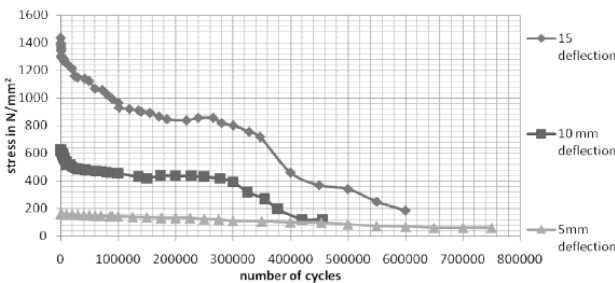
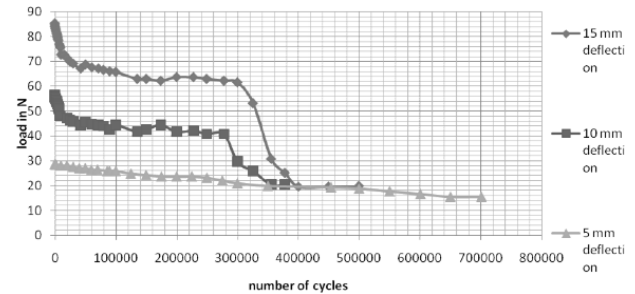

Figure (25).The relation between load and number of cycles for the 10 layer 4.6 mm thickness composite subjected to 15 mm,10mm, and 5mm deflection.



Figure(26).The relation between the stress and number of cycles for the 10 layer 4.6 mm thickness composite subjected to 15 mm,10mm, and 5mm deflections.



Figure(27).The relation between the stress and number of cycles for the 8 layer 3.75 mm thickness composite subjected to 15 mm,10mm, and 5mm deflections.

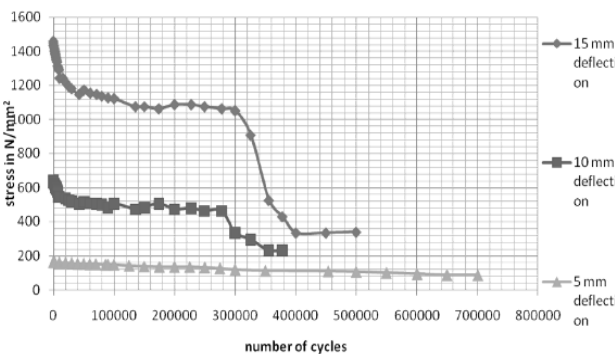

Figure(28).The relation between the stress and number of cycles for the 8 layer 3.75 mm thickness composite subjected to 15 mm,10mm, and 5mm deflections.

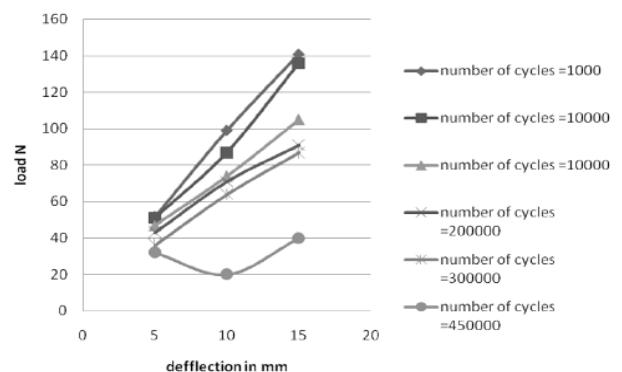

Figure(29).The relation between the deflection and load at various number of cycles of 10layer 4.6 mm thickness specimens.

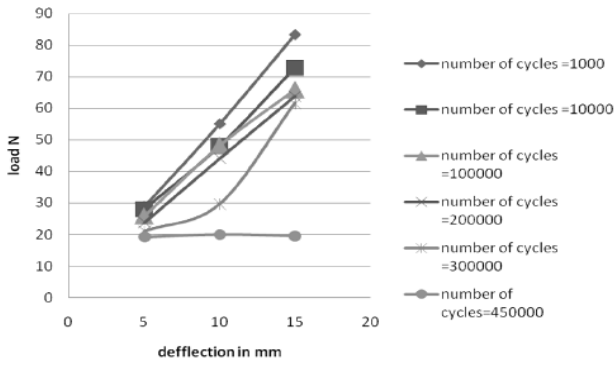

Figure(30).The relation between the deflection and load at various number of cycles of 8layer, 3.75 mm thickness specimens.

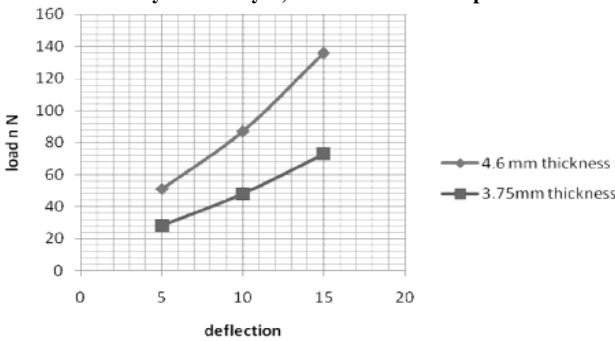

Figure(32).The relation between the deflection and load at various number of cycles for 10 layer, 4.6mmthickness and the 8layer, 3.75 mm thickness specimens after 10000 cycles.

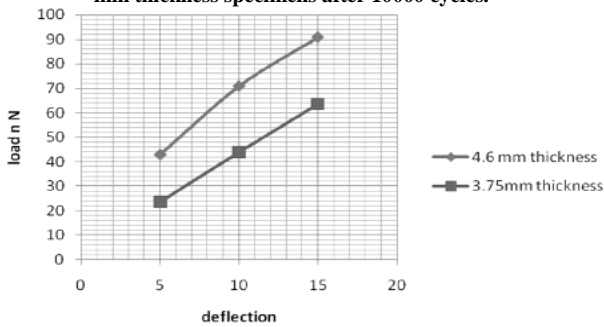

Figure(34).The relation between the deflection and load at various number of cycles for 10 layer, 4.6mmthickness and the 8layer, 3.75 mm thickness specimens after 200000 cycles.

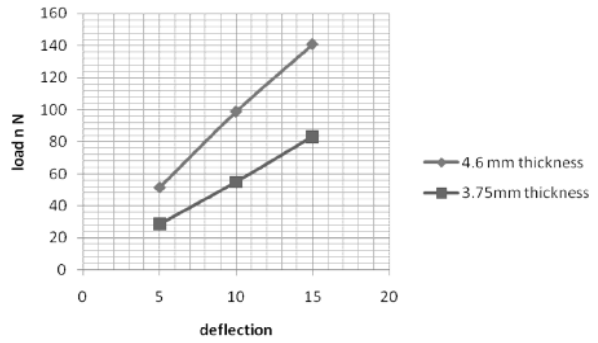

Figure(31).The relation between the deflection and load at various number of cycles for 10 layer, 4.6mmthickness and the 8layer, 3.75 mm thickness specimens after 1000 cycles.

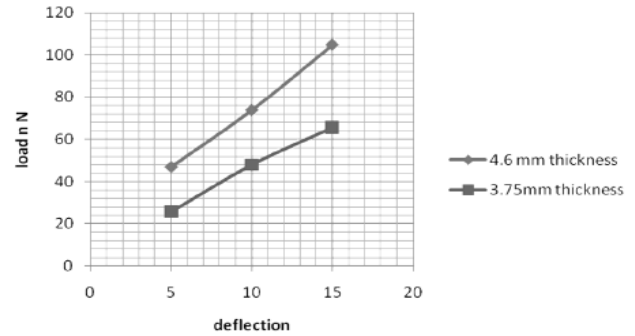

Figure(33).The relation between the deflection and load at various number of cycles for 10 layer, 4.6mmthickness and the 8layer, 3.75 mm thickness specimens after 100000 cycles.

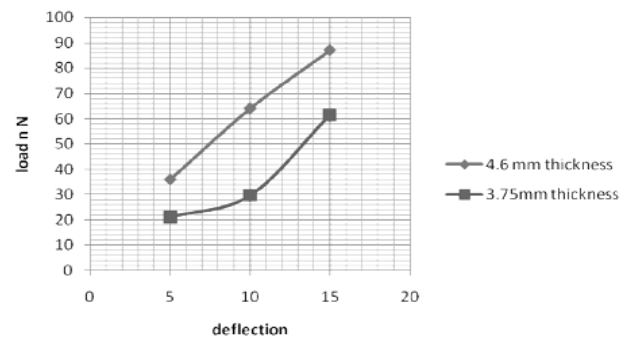

Figure(35).The relation between the deflection and load at various number of cycles for 10 layer, 4.6mmthickness and the 8layer, 3.75 mm thickness specimens after 300000 cycles.

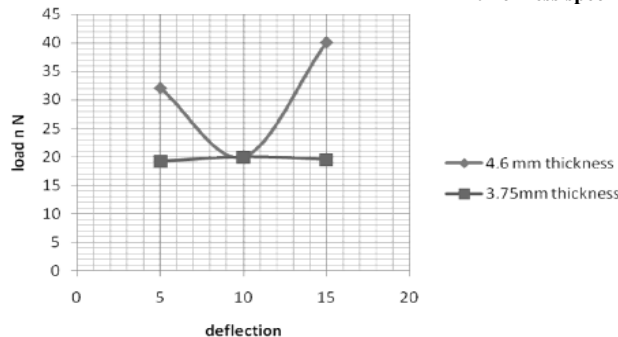

Figure(36).The relation between the deflection and load at various number of cycles for 10 layer, 4.6mmthickness and the 8layer, 3.75 mm thickness specimens after 450000 cycles.

In Fig. 29 and Fig. 30 the load against the deflection as the x-axis shows the difference between different values and curves for different numbers of cycles which show how number of cycles affect the load and its values during the tests, the first Fig. is to 10 layer 4.6 mm thickness composite under different deflections at various selected numbers of cycles and the second is for the 8 layer 3.75 mm thickness specimens under the same conditions.

As it seen from the Fig. 29 and Fig. 30, the initial values are in a linear increase to reach top value at the maximum deflection and from there as the test progress and the cycles increase the load for the lest deflection decreases at a study rate to reach failure point but for maximum deflection the decrease is concentrated in the first hundred thousand of fatigue and then it slows to decreasing rate and at the end the rate increase to reach it failure value.

In Fig. 31, Fig. 32, Fig. 33, Fig. 34, Fig. 35, and Fig.36 represent the relation between the load and deflection for two different thicknesses under three different deflections for different points of the number of cycles.

As it is seen from the Fig. 32 to Fig. 36 the difference between the two curves increases as the load required deflection increases and as the experiment moves on the difference for the small deflection stays the same, but this thing doesn't apply to the other two points where the difference decreases as the cycles increase.

### **Damage Characterization through Optical Microscopy**

The specimens were polished and viewed under the light microscope at different magnification ranges.

It can be clearly seen that the composite have a very complex structure because of the use of the fabric instead of the use of fiber in the composite fatigue.

The inter woven nature of the fabric provides some extra components of stress because of the presence of the extra weft fiber in the transverse direction .The micrographics shown provides a summary of events taking place in a variety of computations, the revels matrix cracking, delamination ,splitting of fiber and matrix, and breaking of fiber bundle. In Fig. 37 a micrographics of the composite specimen shows the nature of the composite and its fiber arrangement in the site of the composite.

The transverse cracks that take place in the fiber matrix interface are shown in Fig. 38 where also it shows the matrix cracks which result from the tensile stress at the top of the specimen.

In Fig. 39 the fiber matrix debonding is seen along the edge of the fiber, this is because of the complex nature of the normal stresses then cracks move in almost a perpendicular way to the 0o fiber on the other side in a 90° to the fiber direction, leading to break the interface inside the composite and inside the layer.

Fig.40 shows the fiber is being pulled out from the matrix, complete failure of the specimen is shown in Fig. 41 where the delamination and total splitting are present, for a more clear view of the delamination and fiber fracture and the fiber matrix debonding, see Fig. (42), which is for the scanning electron fractography [Zham 2002].



Figure (37). Micrographics for composite material shows it fiber arrangement.

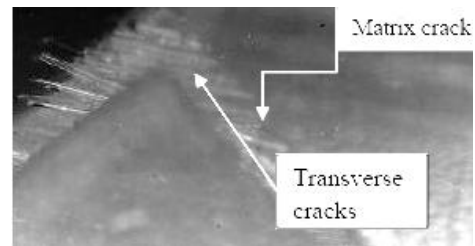

Figure (38) The transverse cracks in the composite specimen

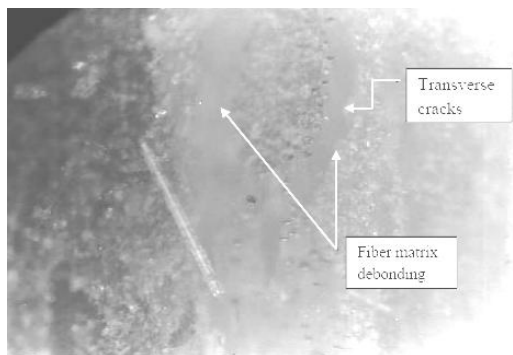

Figure (39) The fiber matrix debonding.

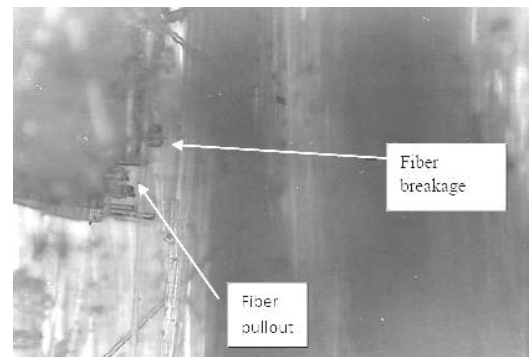
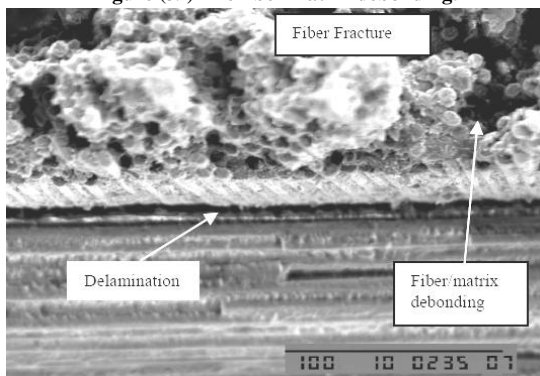

Figure (40) Fiber is being pulled out from the matrix.



Figure(41) Scanning electron fractograph showing damage events in the composite[Zham 2002].

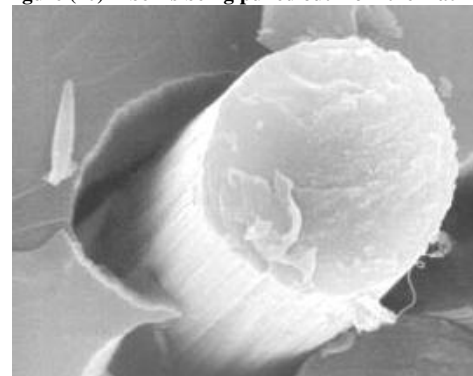

Figure (42) The fiber matrix debonding [Zham 2002].

## CONCLUSIONS

The main conclusions drawn from this work are listed below:

- The delamination was found to be the major damage mode in the glass fiber reinforced composite while the matrix cracking plays a secondary role as it is the key for the delamination.
- The fatigue damage mostly starts with transverse crack and it leads to the other type of damage such as fiber fracture, fiber matrix debonding and delamination.
- The fatigue life is effected by both the thickness of the specimens and the load value, and it has a significant behavior that could be divided to three major regions the first is with a very fast drop in the strength and this drop depends on the load factor and the thicknesses, and a second region

that could be considered is the face where the crack propagation takes place till it reaches the limit in which the composite drops rapidly and goes to the final failure.

## REFERENCES

- Ali Hussain Mohammed Al-Hilli," Analytical and Experimental Analysis of High Velocity Impact on Composite Material Targets", Ph.D., Nahrain University, 2006
- Daneila Popescu," A Model for damage predication in polymer matrix composite subjected to bending fatigue loading ", Proceedings of the Romanian academy, Series A, Volume 8, Number2, (2007).
- Diawekar Keddlaya and Assimina A. Pelegri ," Failure redicationof graphite/epoxy laminates with induced intermittent load during fatigue ", Acta materialia , Volume 50, Pages 4813-4821,(2002).
- Hwang W, Han K. S.," Fatigue of Composite Material Damage Model and Life Predication ", ASTM special technical publication (1985).
- Hwang W, Han K. S.," Fatigue of Composite-Fatigue modulus Concept and Life Predication ",Journal of Composite Materials, Volume 20, Pages 154-165,(1986).
- Lee J-W, Daniel IM, Yaniv G.," Fatigue Life Prediction of Cross- Ply Composite Laminates ", ASTM International,(1989).
- Liu Y.M. and S.Mahadeven," Fatigue Damage Modeling of Composite Laminates ", 9th ASCE Conference on Probabilistic Mechanics and Structural Reliability, (2004).
- Mahmood Zabihpoor and Saeed Adibnazari," A Micromechanics Approach for Fatigue of Unidirectional Fibrous Composites ",Iranian Polymer Journal, Volume 16, Pages 219-232, (2007).
- Miyano Y. Nakada M."Predication of Flexural fatigue strength of CFRP Composite Under Arbitrary Frequency Stress Ratio and Temperature " Journal of Composite Material ,Volume 31 ,(1997).
- Mohamed Shorieh and Larry B. Lessard," progressive fatigue modeling of laminated composite pinned/bolted connections ", proceeding of ICCM, volume 2,fatigue,fractureand ceramic matrix composites, Pages II-156-III166,(1997).
- Paepegem W. Van and J.Degerick." Fatigue degradation modeling of palin woven glass/epoxy composite ". Composite Materials, Composite Material part a, 32(10), Pages 1433-1441, (2001).
- Zham, R. Khan, F. Al-Sulaiman, N. Merah," Fatigue Damage in Woven Carbon Fabric/Epoxy Laminate at Non-Ambient Temperature ", The 6th Saudi Engineering Conference, KFUPM, Dhahran, Volume 5,Pages 313-326,(2002).