



Aalborg Universitet

AALBORG UNIVERSITY  
DENMARK

## Computational Fluid Dynamics Study on the Influence of Airflow Patterns on Carbon Dioxide Distribution in a Scaled Livestock Building

Rong, Li; Nielsen, Peter Vilhelm; Tong, Guohong; Ravn, Peter; Zhang, Guoqiang

*Published in:*

AgEng 2008 International Conference on Agricultural Engineerings

*Publication date:*

2008

*Document Version*

Publisher's PDF, also known as Version of record

[Link to publication from Aalborg University](#)

*Citation for published version (APA):*

Rong, L., Nielsen, P. V., Tong, G., Ravn, P., & Zhang, G. (2008). Computational Fluid Dynamics Study on the Influence of Airflow Patterns on Carbon Dioxide Distribution in a Scaled Livestock Building: . In AgEng 2008 International Conference on Agricultural Engineerings: Conference Proceedings CD : Agricultural & Biosystems Engineering for a Sustainable World : Knossos Royal Village, Hersonissos - Crete, 23-25 June 2008, Greece AgEng.

### General rights

Copyright and moral rights for the publications made accessible in the public portal are retained by the authors and/or other copyright owners and it is a condition of accessing publications that users recognise and abide by the legal requirements associated with these rights.

- ? Users may download and print one copy of any publication from the public portal for the purpose of private study or research.
- ? You may not further distribute the material or use it for any profit-making activity or commercial gain
- ? You may freely distribute the URL identifying the publication in the public portal ?

### Take down policy

If you believe that this document breaches copyright please contact us at [vbn@aub.aau.dk](mailto:vbn@aub.aau.dk) providing details, and we will remove access to the work immediately and investigate your claim.

# COMPUTATIONAL FLUID DYNAMICS STUDY ON THE INFLUENCE OF AIRFLOW PATTERNS ON CARBON DIOXIDE DISTRIBUTION IN A SCALED LIVESTOCK BUILDING

Li Rong<sup>1)\*</sup>, Peter V. Nieslen<sup>1)</sup>, Guohong Tong<sup>2)</sup>, Peter Ravn<sup>3)</sup>,  
Guoqiang Zhang<sup>3)</sup>

<sup>1)</sup> Department of Civil Engineering, Aalborg University, Sohngaardsholmsvej 57, DK-9000 Aalborg e-mail:

[li@civil.aau.dk](mailto:li@civil.aau.dk)

<sup>2)</sup> College of Water Conservancy, Shenyang Agricultural University, Shenyang 110161, China. e-mail:

[guohongtong@yahoo.com.cn](mailto:guohongtong@yahoo.com.cn)

<sup>3)</sup> Department of Agricultural Engineering, Research Centre Bygholm, University of Aarhus, Schutttesvej17,

DK-8700 Horsens, Denmark, e-mail: [guoqiang.zhang@agrsci.dk](mailto:guoqiang.zhang@agrsci.dk)

---

## Abstract

Airflow patterns and airflow rate have an important influence on contaminant distribution in livestock buildings. The objective of this paper is to model and evaluate the effect of airflow rates and airflow patterns effect on CO<sub>2</sub> concentration distribution and emission rates in a scaled livestock building with slatted floor. Contaminant sources are assumed to be modelled as a constant concentration on the manure surface. Three different ventilation rates and two different deflector degrees are studied, in which the deflector is applied to change the airflow patterns. A CFD commercial software code has been applied to simulate the contaminant distribution. Experiments of tracer gas concentration distribution in the chamber are performed at Air Physic Lab of Aarhus University to validate CFD software. Simulation results and measurements show that ventilation rates and airflow patterns have an effect on the contaminant distribution within the room. The non-dimensional CO<sub>2</sub> concentration along the horizontal direction above the slatted floor varies largely which means the emission rate is

related to the local velocity. With increasing airflow rate, the emission rate of CO<sub>2</sub> and average mass transfer coefficient will increase. The influence of the deflector on the emission rate is also shown.

---

Key word: airflow patterns, airflow rate, contaminant distribution, emission rate, deflector, livestock building

## **1. Introduction**

Air quality in livestock buildings is becoming more and more concerned since it will affect workers' health as well as animals. Ventilation, with appropriate air-handling processes, is used to create an indoor environment with acceptable air temperature, humidity, air velocity and to remove pollutants for better air quality. It removes heat, moisture and contaminants generated inside the buildings. Generally it is not easy to control the contaminants since contaminant distribution is related to the airflow rates and airflow patterns as well as depending on the type and location of contaminant sources (Xudong Yang et al, 2004). The emission rates of CO<sub>2</sub> in livestock buildings are related to the concentration in manure, velocity profile, turbulence intensity, temperature profile, etc( Jiqin Ni et al, 1999; Heber A J et al, 1996; Zhang G et al, 2000). In order to simplify the problem, we assume that the air temperature and CO<sub>2</sub> concentration on liquid surface keep constant in experiments.

In this paper, we use a Computational Fluid Dynamics (CFD) model to simulate the impact of three ventilation rates and two deflector degrees on emissions from floor surface source. See Figure 1 for layout of the model. The studied ventilation rates include 100m<sup>3</sup>/h, 150m<sup>3</sup>/h and 200m<sup>3</sup>/h and two deflector degrees are 45 degree and 90 degree. The 45 degree deflector will generate a stronger jet to the space under the slatted floor while the 90 degree will issue a weaker one. For each ventilation rate and deflector degree, CO<sub>2</sub> concentration in simulation are presented and compared with each other. Experimental measurements of CO<sub>2</sub> concentration conducted in the Air Physics Lab of Aarhus University are used to validate the CFD model (see Guohong Tong et al, 2008). It is assumed that CO<sub>2</sub> of constant concentration is releasing from the entire floor surface.

## **2. validation of the CFD model**

CFD has become a tool in indoor environment analysis since 1970s. Srebric and Chen

(2002) suggested that the decision to use CFD must be firmly based on realistic expectations and it is necessary to validate the turbulence models since no turbulence models are universal to any cases. Nielsen (1998) also discussed the selection of an appropriate turbulence model to predict different room airflow patterns and ventilation systems. In this paper, the standard  $k - \varepsilon$  model is adopted and validated with the experiments data from the Air Physics Lab of Aarhus University. More details about the measurements are stated in the paper by G. Tong et al.

Figure 1 shows the sketch of the physical model in simulation. The model is 2.2m long, 0.62m wide and 2.41m high. The air is supplied from the inlet with  $100\text{m}^3/\text{h}$  and exhausted from a circular outlet located at the left wall. Here we modeled the diffuser in detail as used in experiments because it is known that correct description of the flow and thermal information of an air supply diffuser is fatally important for a reliable prediction of room air distribution by using CFD simulation. The deflector is applied to change the airflow patterns on the right wall and a slatted floor is installed at the lower part of the model. It is an isothermal case and all the walls are adiabatic. On the surface below the slatted floor, the  $\text{CO}_2$  concentration is assumed to be constant and on other walls there is no emission of  $\text{CO}_2$ . The results are presented in non-dimensional value to compare the measurements at five points ( see Figure 1, shown as ‘ \* ’ in yellow) above the slatted floor with the simulation results. The non-dimensional  $\text{CO}_2$  concentration  $c^*$  is defined as:

$$c^* = \frac{c - c_0}{c_r - c_0} \quad (1)$$

$c^*$ ,  $c$ ,  $c_0$  and  $c_r$  represent the non-dimensional  $\text{CO}_2$  concentration, the concentration at different points inside the room, the inlet concentration and the outlet concentration of  $\text{CO}_2$  respectively.

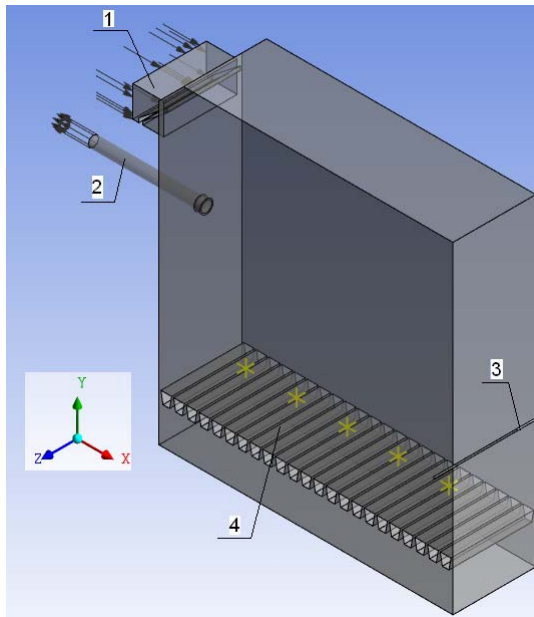

(a) Deflector with 45 degree

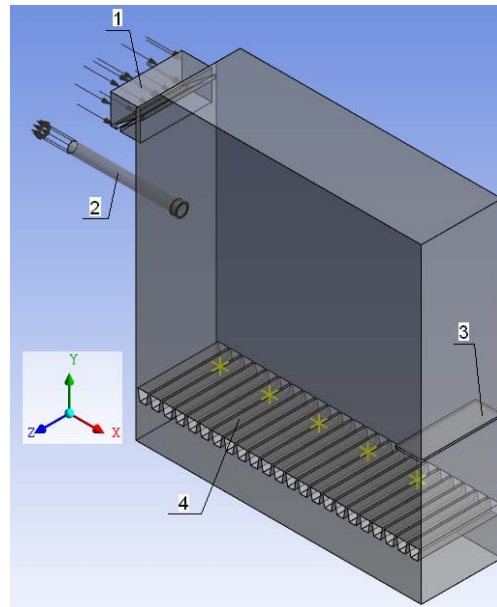

(b) Deflector with 90 degree

1—inlet, 2—outlet, 3—deflector, 4—slatted floor, ‘ \* ’—measurement points

Figure 1 sketch of physical model

Fig.2 and Fig.3 shows the velocity distribution and CO<sub>2</sub> concentration distribution respectively. From these two figures, it is seen that the basic velocity pattern is reasonable and it has an important influence on CO<sub>2</sub> concentration distribution. Fig.4 presents the comparison of  $c^*$  between simulation results and measurements along a line of  $y=0.51\text{m}$  through the five points above the slatted floor (see Figure 1). The simulation results are in good agreement with the measurements except for one point in the model with 90 degree deflector. All these simulation results show that standard  $k-\varepsilon$  model can be applied in this kind of ventilation system simulations.

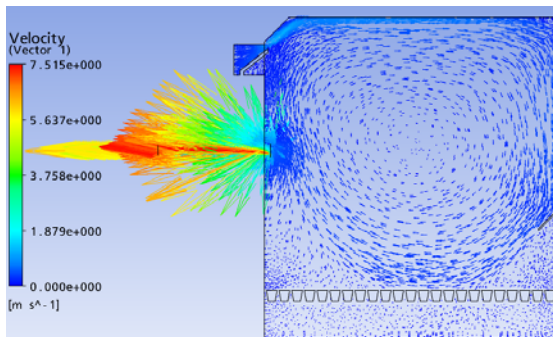

(a) Deflector with 45 degree

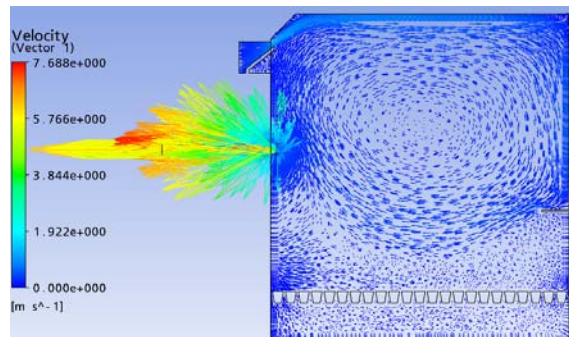

(b) Deflector with 90 degree

Figure 2 velocity distribution at the middle plane with  $z=0.31\text{m}$

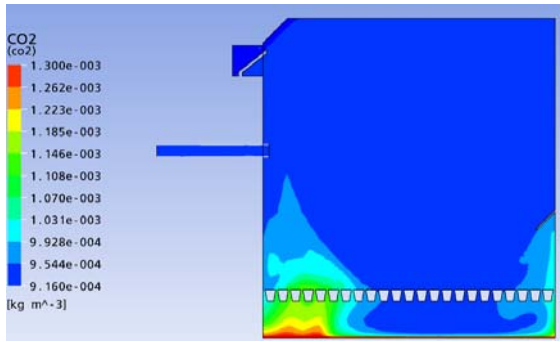

(a) Deflector with 45 degree

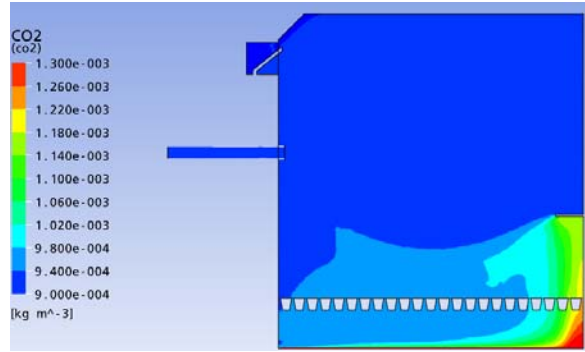

(b) Deflector with 90 degree

Figure 3 CO<sub>2</sub> concentration distribution at the middle plane of  $z = 0.31$  m

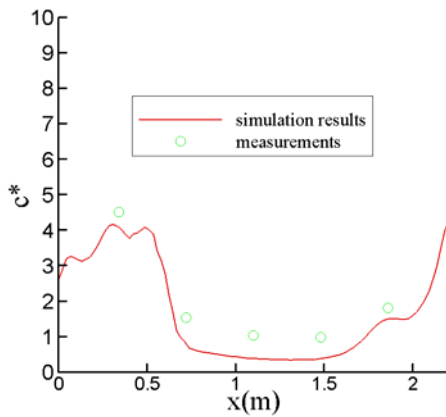

(a) Deflector with 45 degree

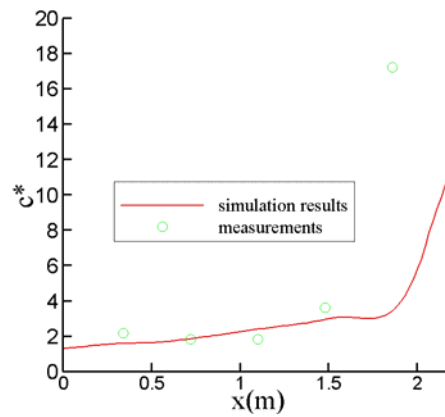

(b) Deflector with 90 degree

Figure 4 comparison of non-dimensional CO<sub>2</sub> concentration between measurements and simulation results at line of  $y = 0.51$  m in the middle plane

### 3. Results and discussion

In this part, we simulated the two models with three ventilation rates to investigate the influence of ventilation and deflector on emission rate, concentration distribution as well as the relation between mass transfer coefficient and the velocity.

#### CO<sub>2</sub> concentration distribution

Figure 5 shows CO<sub>2</sub> concentration distribution along a horizontal line of  $y = 0.51$  m above the slatted floor in the middle plane with various airflow rates. From the graphs, it is seen that the non-dimensional CO<sub>2</sub> concentration varies largely in horizontal direction. The  $c^*$  increases with distance as the velocity level decreases both in 45 degree deflector and in 90 degree deflector. The difference of  $c^*$  between graph (a) and graph (b) in Figure 5 is caused by the deflector which changes the airflow

patterns, see figure 2 and figure 3.

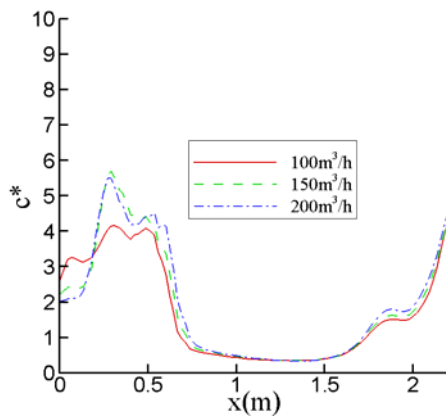

(a) Deflector with 45 degree

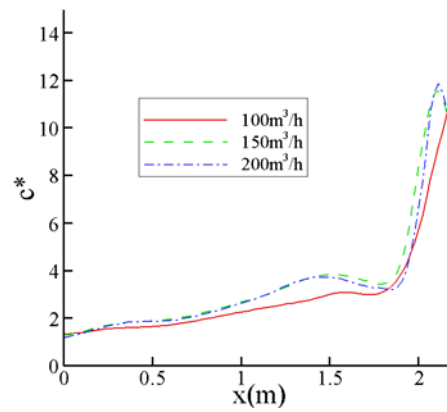

(b) Deflector with 90 degree

Figure 5 Non-dimensional CO<sub>2</sub> concentrations versus horizontal distance with various airflow rates

Figure 6 and Figure 7 show typical boundary layer profiles of the middle plane at  $z = 0.31\text{m}$ . It is seen that the boundary layer is thin and almost the same at the three airflow rates in figure 6(b) and figure 7(a). The reason for the similar and thin boundary layer in figure 6(b) and figure 7(a) is that the relatively fresh air from the inlet is supplied directly to the space below the slatted floor where the two positions are located. Then the boundary layers below the slatted floor are becoming thicker along the direction of velocity, see Fig.6 (a) and Fig.7 (b).

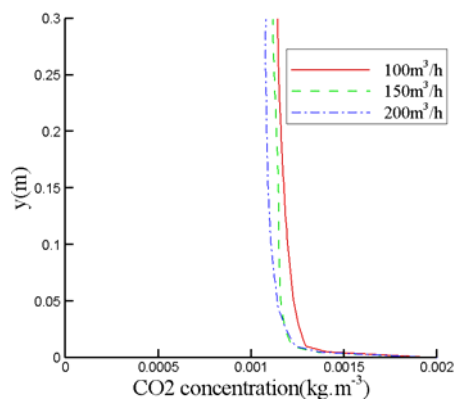

(a) Boundary layer profile at  $x = 0.29\text{m}$

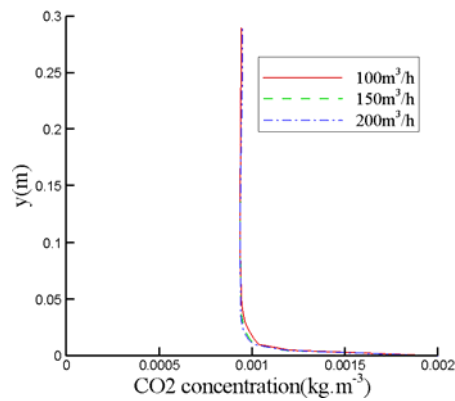

(b) Boundary layer profile at  $x = 1.1\text{m}$

Figure 6 Typical boundary layer profiles at the middle plane with 45 degree deflector (the slatted floor is located at  $y = 0.275\text{m}$ )

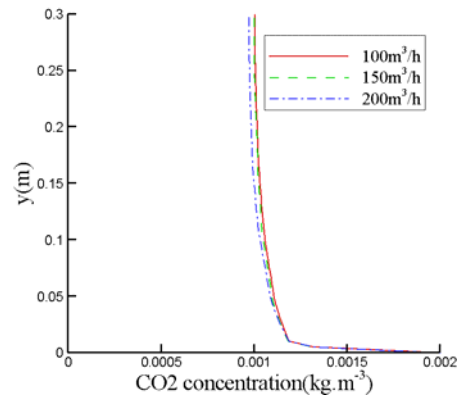
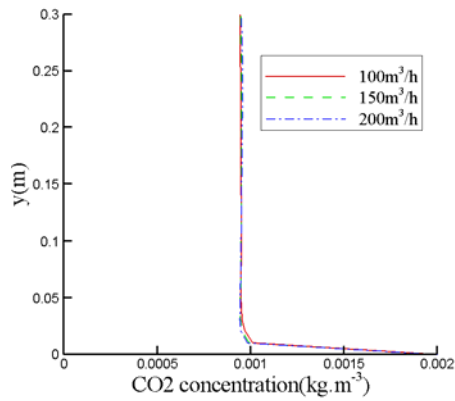

(a) Boundary layer profile at  $x=0.29\text{m}$

(b) Boundary layer profiles at  $x=1.91\text{m}$

Figure 7 typical boundary layer profiles at the middle plane with 90 degree deflector (the slatted floor is located at  $y=0.275\text{m}$ )

### ***Influence of airflow rate on emission rate***

Figure 8 shows the emission rates in the scale model from CFD simulations at various ventilation rates and deflector degrees. It is calculated as airflow rate multiplying with the difference of  $\text{CO}_2$  concentration between outlet and inlet. The graph shows that the emission rate increases when the airflow rates increase. The emission rate is higher when the 90 degree deflector is applied. However, when the ventilation rate is increasing, the difference of emission rate between the two models is becoming smaller which means that the function of the deflector to change the emission from the floor surface below the slatted floor is not so obvious at higher ventilation rate.

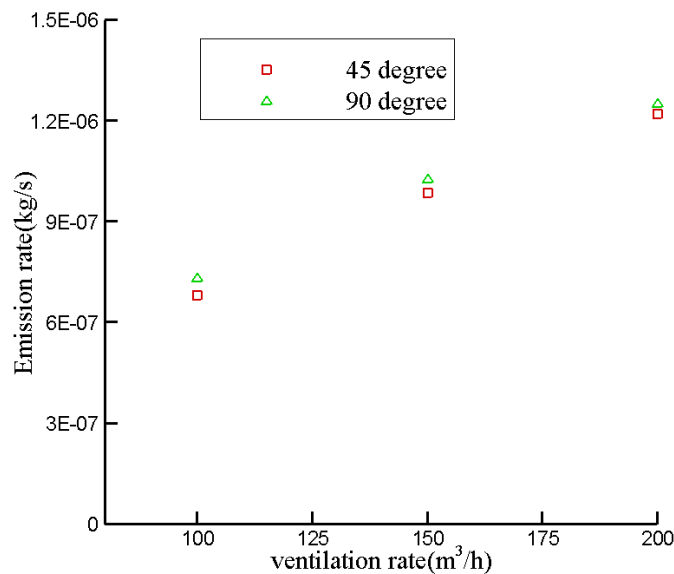

Figure 8 emission rates at various ventilation rates with different deflector degrees



### ***influence of airflow rate on mass transfer coefficient***

Figure 9 presents the relation between mass transfer coefficients  $k_c$  and ventilation rate for two different deflections. The mass transfer coefficient is calculated based on the emission rate and the difference of CO<sub>2</sub> concentration between the surface concentration below the slatted floor and the outlet concentration; it is therefore the average transfer coefficient for the emitting surface. It is seen that there is a substantial increase in mass transfer coefficient with ventilation rate in two models with different degree of deflection.

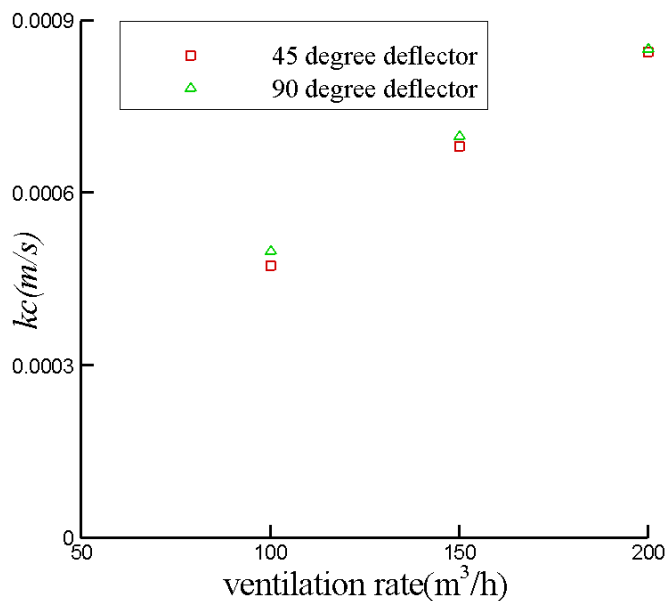

Figure 9 relations between mass transfer coefficient and airflow rate with two different deflectors

#### **4. Conclusions**

This paper presents numerical simulation results made in a scale model of swine buildings. The influence of airflow rates and airflow patterns on emission rate from a surface contaminant source is investigated and CO<sub>2</sub> concentration distributions of the middle plane are also shown in the paper. Experimental data is used to validate the CFD model in two different settings of a deflector.

From the results, it is found that the non-dimensional CO<sub>2</sub> concentration varies along the horizontal direction which means that the emission rate is related to the local airflow. On the one hand, the emission rate increases with larger ventilation rate.

On the other hand, the setting of the deflector also has an influence on emission rate which is higher with 90 degree deflector than that with 45 degree deflector, but the function of the deflector to affect the emission rate is decreasing with increasing the airflow rate.

The concentration distribution is strongly depending on the airflow patterns. The boundary layer below the slatted floor is becoming thicker along the direction of velocity. The mass transfer coefficient also increases with increasing the airflow rate as expected.

### **Reference**

- Guohong Tong, Guoqiang Zhang, Peter Ravn, Li Rong, Peter V. Nielsen. Effect of environmental deflector on air exchange in slurry pit and concentration distribution in a two-dimensional ventilation chamber. *International conference on agricultural engineering & industry exhibition*. 2008.
- Heber A J, Boon C R, Peugh M V. Air Patterns and Turbulence in an Experimental Livestock Building. *Journal of Agricultural Engineering Research*. 1996, 64, 209-226.
- Jelena Srebric, Qingyan Chen. An example of verification, validation and reporting of indoor environment CFD analysis. *ASHRAE Transactions*. 2002, 108(2), 185-194.
- Jiqin Ni, Christiaan Vinckier, Jos Hendriks, Jan Coenegrachts. Production of carbon dioxide in a fattening pig house under field conditions. II . Release from the manure. *Atmospheric Environment*. 1999, 33, 3697-3703.
- P. V. Nielsen. The selection of Turbulence models for prediction of room airflow. *ASHARE Transactions*. 1998, 104, Part 1B, 1119-1127.
- Xudong Yang, Jelena Srebric, Xianting Li, Guoqing He. Performance of three air distribution systems in VOC removal from an area source. *Building and Environment*. 2004, 39, 1289-1299.
- Zhang G., Morsing S., Bjerg B., Svidt K., Strøm J.S.. Test room for validation of airflow patterns estimated by computational fluid dynamics. *Journal of Agricultural Engineering Research*. **2000**, 76, 141-148.