



Aalborg Universitet

AALBORG UNIVERSITY
DENMARK

Advantages in using Kalman phasor estimation in numerical differential protective relaying compared to the Fourier estimation method

Bukh, Bjarne Søndergaard; Gudmundsdottir, Unnur Stella; Balle Holst, Per; Boe Jensen, Kim; Jensen, Louise Carina; Bak, Claus Leth

Published in:

Proceedings of International Conference on Power System Transients

Publication date:
2007

Document Version
Publisher's PDF, also known as Version of record

[Link to publication from Aalborg University](#)

Citation for published version (APA):

Bukh, B. S., Gudmundsdottir, U. S., Balle Holst, P., Boe Jensen, K., Jensen, L. C., & Bak, C. L. (2007). Advantages in using Kalman phasor estimation in numerical differential protective relaying compared to the Fourier estimation method. In *Proceedings of International Conference on Power System Transients IPST*.

General rights

Copyright and moral rights for the publications made accessible in the public portal are retained by the authors and/or other copyright owners and it is a condition of accessing publications that users recognise and abide by the legal requirements associated with these rights.

- ? Users may download and print one copy of any publication from the public portal for the purpose of private study or research.
- ? You may not further distribute the material or use it for any profit-making activity or commercial gain
- ? You may freely distribute the URL identifying the publication in the public portal ?

Take down policy

If you believe that this document breaches copyright please contact us at vbn@aub.aau.dk providing details, and we will remove access to the work immediately and investigate your claim.

Advantages in using Kalman phasor estimation in numerical differential protective relaying compared to the Fourier estimation method.

Bjarne Bukh, Unnur Stella Gudmundsdottir, Per Balle Holst, Kim Boe Jensen, Louise Carina Jensen, Claus Leth Bak,
Institute of Energy Technology, Aalborg University, Denmark.

Abstract-- This paper demonstrates the results obtained from detailed studies of Kalman phasor estimation used in numerical differential protective relaying of a power transformer. The accuracy and expeditiousness of a current estimate in the numerical differential protection is critical for correct and not unnecessary activation of the breakers by the protecting relay, and the objective of the study was to utilize the capability of Kalman phasor estimation in a signal model representing the expected current signal from the current transformers of the power transformer. The used signal model included the fundamental frequency, an exponentially decaying current, the 2nd and the 5th harmonic to the fundamental frequency.

Keywords: Numerical differential protection, Protective relaying, Kalman phasor estimation, Differential protection.

I. INTRODUCTION

SINCE the late 1980's there has been considerable improvements in numerical protection techniques. This paper discusses a numerical differential protection for a transformer. The transformer is a 1.6 MVA, Dyn5 power transformer.

The basic principle of the differential protection is based on the relay-characteristic shown in figure 1, where the sum of current I_1 flowing into and the current I_2 flowing out of the protected unit is plotted as a function of the difference of the same current [1]. Using this method, the internal failures should be placed above the relay-characteristic, because of $I_2=0$, and the external failures should be placed below the relay-characteristic, because of $I_1=-I_2$.

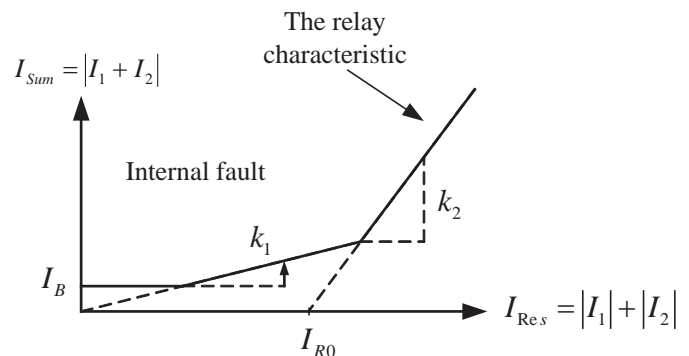

Fig. 1. Simple detection algorithm for differential protection. The parameters I_B , I_{R0} , k_1 and k_2 are used to control the sensitivity and selectivity of the protection.

For this type of differential protection, the primary and secondary currents of the power transformer are measured with six current transformers, then the currents are transformed to the same amplitude base and compared.

In this paper it is introduced how a Kalman phasor estimation method, implemented in a Digital signal processing unit (DSP), can be used as a numerical differential protection algorithm and the benefits of using the method versus the classical Fourier algorithm. The Kalman estimation method is implemented with the fundamental frequency, the DC-component and the 2nd and the 5th harmonics.

The estimate of the 2nd harmonic is used to detect inrush of the transformer and the 5th harmonic is used to detect if the transformer is overexcited. If this being the case, the differential protection should not activate a circuit breaker. The 2nd and the 5th harmonics can therefore effectively be used to prevent unnecessary activation of the breakers by the protecting relay. Furthermore the 2nd and the 5th harmonic can be used to detect saturation of the current transformers (CTs) and prevent activation of circuit breakers if this is the case [2].

II. NUMERICAL DIFFERENTIAL PROTECTION

A numerical differential protection can use various different algorithms to fulfill the functionality of the protection. In this paper Fourier transformation and Kalman phasor estimation are discussed.

A. Fourier transformation

This type of algorithm uses one period of measured

B. Bukh is a student at dept. of power systems and high voltage, institute of energy technology, Aalborg University (e-mail: bbu@elektrisk-energiteknik.dk).

U.S. Gudmundsdottir is a student at dept. of power systems and high voltage, institute of energy technology, Aalborg University (e-mail: s07usg@ponstud.aau.dk).

P. B. Holst is a student at dept. of power systems and high voltage, institute of energy technology, Aalborg University (e-mail: s07pbh@ponstud.aau.dk).

K. B. Jensen is a student at dept. of power systems and high voltage, institute of energy technology, Aalborg University (e-mail: s07kbj@ponstud.aau.dk).

L. C. Jensen is a student at dept. of power systems and high voltage, institute of energy technology, Aalborg University (e-mail: s07lcj@ponstud.aau.dk).

C. L. Bak is with dept. of power systems and high voltage, institute of energy technology, Aalborg University (e-mail: clb@iet.aau.dk).

Presented at the International Conference on Power Systems Transients (IPST'07) in Lyon, France on June 4-7, 2007

samples to estimate the frequency content. It uses the Fourier transformation, shown in (1).

$$I_h = \frac{2}{N} \cdot \sum_{n=0}^{N-1} i(n \cdot \Delta t) \left[\cos\left(\frac{2\pi n h}{N}\right) - j \sin\left(\frac{2\pi n h}{N}\right) \right] \quad (1)$$

Where I_h is the estimated harmonic current signal, N is the number of samples in one period, n is the sample number and h is the number of the harmonic frequency being calculated.

This is a rather simple method to implement, but it has its drawbacks, such as that it is dependent on samples from a whole period, which makes the prediction relatively slow. For many cases this is enough and is rather cheap to implement, hence this is a widely used numerical differential technique [3].

B. Kalman phasor estimation

Kalman filtering uses recursive calculations to estimate the current signals. It suffices with only one sample to estimate the signal and which reduces the memory storage. Kalman phasor estimation is in this paper a matrix calculation method based on two principles, namely prediction and update and uses the expression shown in (2)[4].

$$\hat{Y}(n+1|n+1) = \hat{Y}(n+1|n) + B(n+1) \left[i(n+1) - \hat{i}(n+1|n) \right] \quad (2)$$

Where $i(n+1)$ is the measured current, n is the sample number, $\hat{i}(n+1|n)$ is the estimated current, estimated from the last estimate, $\hat{Y}(n+1|n)$ are the estimated parameters of the signal, estimated from last estimate, $B(n+1)$ is the Kalman weighting calculated using least square error and $\hat{Y}(n+1|n+1)$ are the estimated parameters of the signal for the sampletime $n+1$.

In order to estimate the current of the protected unit, this rather complex equation must be implemented as a matrix and the calculations can therefore become quite large and time consuming in the DSP.

III. DESIGN OF NUMERICAL DIFFERENTIAL PROTECTION USING KALMAN PHASOR ESTIMATION

Estimation of a current signal by the signal model containing, a DC-component, the fundamental frequency and the 2nd and the 5th harmonics to the fundamental frequency, for one phase based on (2) is shown in (3).

$$\hat{i}((n+1)\Delta t) = I_0 \cdot e^{-\frac{\Delta t}{\tau}} + I_1 \cos(\omega_0 \Delta t + \theta_1) + I_2 \cos(2\omega_0 \Delta t + \theta_2) + I_5 \cos(5\omega_0 \Delta t + \theta_5) \quad (3)$$

Where Δt is the sample time, $I_0 \cdot e^{-\frac{\Delta t}{\tau}}$ is the DC component, $I_1 \cos(\omega_0 \Delta t + \theta_1)$ is the fundamental frequency, $I_2 \cos(2\omega_0 \Delta t + \theta_2)$ is the 2nd harmonic and $I_5 \cos(5\omega_0 \Delta t + \theta_5)$ is the 5th harmonic of the estimated current $\hat{i}((n+1)\Delta t)$.

This signal model can also be represented in the matrix form $\hat{i}((n+1)\Delta t) = \bar{A} \cdot \bar{H} \cdot \bar{Y}(n)$, which is used for the Kalman filtering method, where \bar{H} is the driving function matrix that advances the changes of the parameters in the signal model by one sample, \bar{A} is an output matrix that is used to calculate the estimated current signal and $\bar{Y}(n)$ is a vector containing the magnitude of the DC component and the phasors of the fundamental, 2nd and 5th harmonics, as is shown in (10) in Appendix.

A. Prediction Step

When estimating the current signal, using the Kalman filtering method, $i(n+1)$ should be measured and compared to the estimated current $\hat{i}(n+1|n)$. One of the advantages of the Kalman estimation is that it is not an average of present and past samples within a sample window, but a statistical weighting between the old estimated value and the new sample. In order to achieve this weighting the estimation of the current is performed in two steps. First there is a prediction which is shown in (4)-(6) and then there is update which is demonstrated later.

$$\bar{Y}(n+1|n) = \bar{H}(n+1) \bar{Y}(n|n) \quad (4)$$

$$\hat{i}(n+1|n) = \bar{A}(n+1) \bar{Y}(n+1|n) \quad (5)$$

$$\bar{R}(n+1|n) = \bar{H}(n+1) \bar{R}(n|n) \bar{H}(n+1)^T + \bar{Q}_z(n+1) \quad (6)$$

The autocorrelation matrix \bar{R} for the process is used to calculate the LS-estimate of $\bar{R}(n|n) \equiv E \left[(Y(n) - \bar{Y}(n|n))^2 \right]$ and of $\bar{R}(n+1|n) \equiv E \left[(Y(n+1) - \bar{Y}(n+1|n))^2 \right]$. The matrix \bar{Q}_z is the variance matrix for the parameter noise.

B. Updating Step

After the estimation, a new current measurements has to be carried out and the parameters are updated. The updating equations are shown in (7)-(9).

$$\bar{B}(n+1|n) = \bar{R}(n+1|n) \bar{A}(n+1)^T \left[\bar{A}(n+1) \bar{R}(n+1|n) \bar{A}(n+1)^T + \bar{Q}_w(n+1) \right]^{-1} \quad (7)$$

$$\bar{Y}(n+1|n+1) = \bar{Y}(n+1|n) + \bar{B}(n+1) \left[i(n+1) - \hat{i}(n+1|n) \right] \quad (8)$$

$$\bar{R}(n+1|n+1) = \left[I - \bar{B}(n+1) \bar{A}(n+1) \right] \bar{R}(n+1|n) \quad (9)$$

Where \bar{B} is the Kalman gain for the weighting of $\bar{Y}(n+1|n)$ depending on the difference between $i(n+1)$ and $\hat{i}(n+1|n)$. The matrix \bar{Q}_w is the variance for the measurement noise due to the noise disturbances during current measurements.

In order to reduce the number of multiplications, and the calculation time, the Kalman phasor estimation is designed, so that the Kalman gain is calculated beforehand, because the

current measurements and the estimated parameters are not a part of the recursive calculations of \hat{B} . Instead of implementing the calculation of (6), (7) and (9) into the Kalman phasor estimation algorithm, the calculated gains are implemented in the algorithm. This makes it possible to implement the Kalman phasor estimation method, with the estimation of the fundamental frequency, the DC-component and the 2nd and 5th harmonics on a small 32 bit DSP-processor.

C. Noise Model and Tuning Possibilities

The variance matrices \overline{Q}_z and \overline{Q}_w in (6) and (7) have not yet been discussed in this paper. \overline{Q}_z is the variance of the parameter noise and \overline{Q}_w is the variance of the measurement noise. The noise is presumed to be Gaussian with zero mean and a constant variance. Therefore, the variance matrices are constant, and the matrix entries can be used as a tuning parameter for the filter behavior in estimation speed and accuracy of the estimated current \hat{i} as seen by the numerical differential relay, compared to the true fault current i through the power transformer.

The Kalman filtering method is based on the estimation and updating equations demonstrated above, and it is clear from these equations that the Kalman filtering method uses recursive calculations, where the estimation is only dependent on the current sample and the last sample. This gives the Kalman phasor estimation method a variety of tuning possibilities by means of the variance matrices.

IV. VERIFICATION METHOD

To verify the Kalman algorithm a simulation was performed in PSCAD/EMTDC on a 1.6 MVA step down power transformer which is part of a combined heat/power station in Linz-Mitte Austria. The purpose of this simulation was to simulate different faults and produce data of the fault current for phase 1, 2 and 3. These data could then be used in a simulation of the Kalman algorithm in MATLAB and on a test circuit.

A. Simulated faults

A series of faults were simulated for both the primary and secondary side of the power transformer and inside and outside the protection zone of the differential relay. These faults were:

- 3 phase short circuit (1-2-3)
- 2 phase ground fault (1-2-Ground and 1-3-Ground)
- 2 phase short circuit (1-2 and 1-3)
- 1 phase ground fault (1-Ground)

These faults were all simulated and the fault currents were obtained as data-files.

B. Test setup

To verify the feasibility of the Kalman algorithm it was implemented on the DSP. A Omicron CMC 256-6 relay testing device was used to generate the 3-phase fault currents

obtained from the PSCAD/EMTDC simulations.

The used relay testing device could generate +/- 20 A peak. It was chosen to use a 32 bit DSP of the type TMS320F2812 from Texas Instruments. The Kalman algorithm was implemented on the DSP with a sampling frequency of 1200 Hz. To obtain the phase currents from the relay testing device a measurement circuit was realized together with the DSP. The setup is illustrated in figure 2.

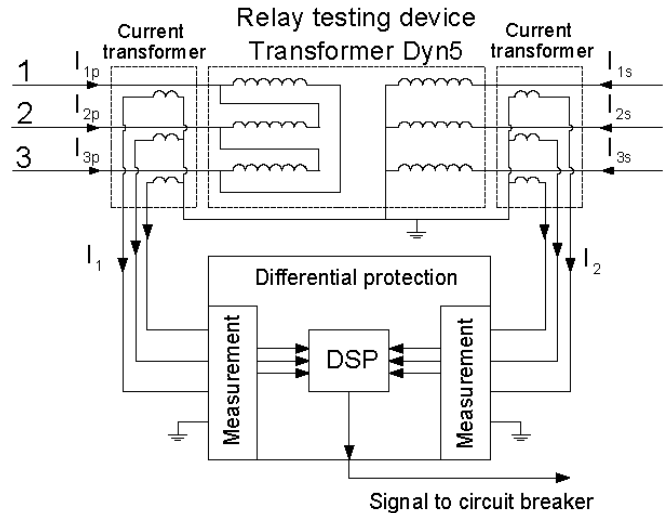

Fig. 2. The test setup.

Tests showed that an internal fault on the secondary side of the power transformer gave the least accurate estimate of the short circuit currents. All fault situations on the primary and secondary side has been simulated and was applied to the differential protection. The short circuit was initiated at zero crossing of phase 1. The cosine estimate of the fault current has been compared to the fault current signal and the difference in terms of percentage in amplitude in the 2nd and 3rd half period has been calculated. The results for the secondary side can be seen in table I.

TABLE I
CALCULATED MEAN DEVIATION OF COSINE ESTIMATION

Fault type	2 nd half period	3 rd half period
Phase 1 – ground	7.4%	1.6%
Phase 1 – 2 – ground	5.3%	0.8%
Phase 1 – 3 – ground	7.7%	3.0%
Phase 1 – 2	9.8%	2.8%
Phase 1 – 3	15.4%	2.8%
Phase 1 – 2 – 3	6.2%	0.5%

From the table, it can be seen that the worst case scenario regarding the 2nd half period is a short circuit between phase 1 and 3 and in the 3rd half period it is the phase 1-3-ground short circuit. The phase 1-3-ground short circuit on the secondary side of the power transformer results in the largest change in amplitude of the primary side current and the largest deviation during the 3rd half period. Therefore, in order to show the possibilities of the algorithm, it is chosen to examine this short

circuit failure in the paper.

V. RESULTS

This chapter presents the simulation results for the differential protection algorithm. The results are generated by the verification methods described in chapter IV.

The objective here is to show the following results that verifies the application of the Kalman estimation in differential protection:

- That the phasor estimation of the fundamental component is better and faster with Kalman estimation than with a Fourier-transformation.
- That the implementation of the differential algorithm is possible on a digital signal processor and that the results from the processor are the same as the simulation results from MATLAB.
- That the estimation of the 2nd and 5th harmonics of the fundamental frequency can be used to identify inrush and overexcitation of the protected power transformer.

The simulation data of the current transformer currents have been used to test the differential protection algorithm in this paper.

The used fault situation in the following results is the 2 phase short circuit between phase 1 and 3 through ground on the secondary side of the power transformer as discussed above. The results will be shown for both an internal and an external fault for the differential protection.

Figure 3 shows the results from MATLAB simulations of the 2 phase short circuit where the fundamental frequency, the 2nd and 5th harmonics and the decaying dc component is estimated for the current signal of phase 1 on the primary side of the power transformer.

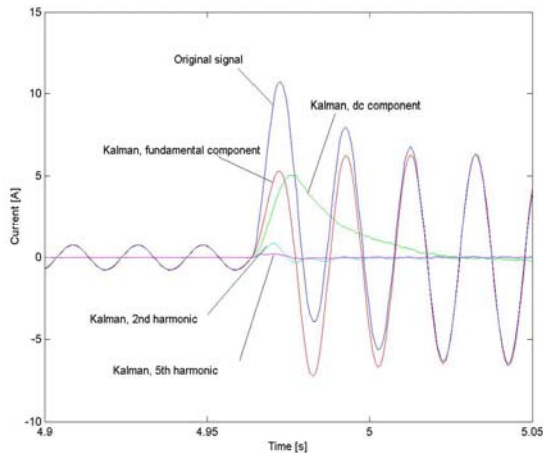

Fig. 3. The original current from the current transformer of phase 1 on the primary side of the power transformer and the estimated signal components: fundamental frequency, 2nd and 5th and the decaying DC-component.

In order to be able to evaluate the performance of the

Kalman phasor estimation, the estimated fundamental frequency with Kalman estimation and Fourier transformation is shown in figure 4.

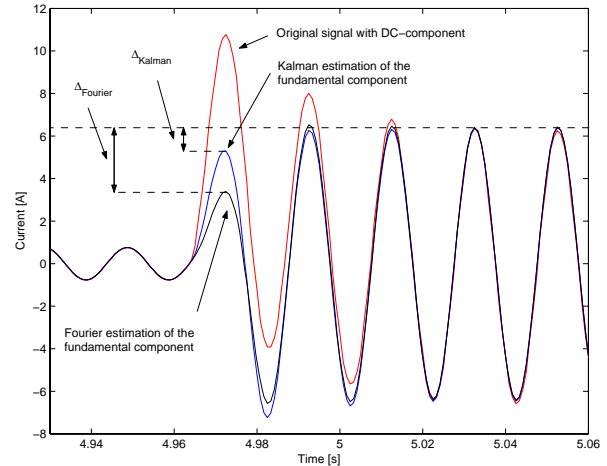

Fig. 4. The original current and the estimated fundamental frequency with Kalman estimation and Fourier transformation of the current from the current transformer of phase 1 on the primary side of the power transformer.

Figure 4 shows the difference between the fundamental of the original signal and the estimation done by Kalman- and Fourier estimation, respectively. The difference Δ_{Kalman} between the original signal and the Kalman estimation and the difference Δ_{Fourier} between the original signal and the Fourier estimation has been calculated for the first and second half period of fault duration. The result is shown in table II.

TABLE II
CALCULATED DEVIATION BETWEEN ORIGINAL AND ESTIMATED SIGNAL

Difference	1 st half period	2 nd half period
Δ_{Kalman}	17%	2.6%
Δ_{Fourier}	47%	12%

From the table, it can be seen that the Kalman estimate in the 1st half period is 30% closer to the fundamental of the original signal than the Fourier estimate and in the 2nd half period, the Kalman estimate coincide with the fundamental of the original signal, while the Fourier estimate has a 12% overshoot. It can be clearly seen, that the Kalman estimate of the fundamental frequency is faster than the Fourier estimation within the first period after the fault.

The phasor estimations in figure 3 are made for the currents from all the six current transformers in the differential protection of the power transformer. After transformation of the secondary transformer currents to the primary side, the sum and difference for each phase pair is plotted as shown in figure 5 and as explained in chapter I, figure 1. Each dot in figure 5 is the sampled and calculated sum and difference of the phase pair for phase 1.

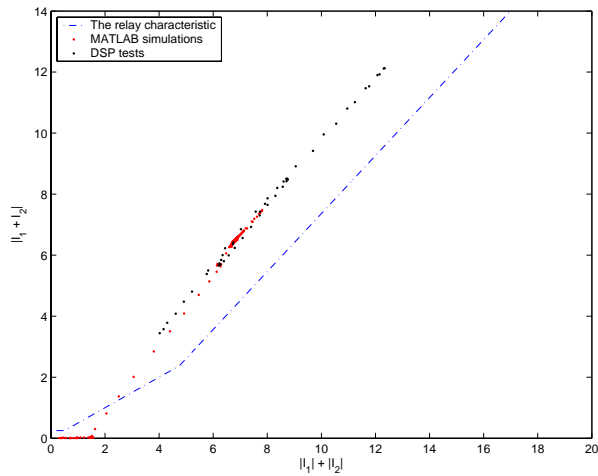

Fig. 5. The sum and difference of the phase pair for phase 1 for an internal fault compared to an example of a relay characteristic. The simulated and the DSP sample are coinciding.

Here the result of an internal differential fault is shown for the chosen fault situation. Figure 5 shows that the sampled values for the internal fault are well defined above the relay characteristic, which makes it possible to detect an internal fault situation.

On figure 6 is the sampled and calculated sum and difference of the phase pair for phase 1 during an external fault shown. The sampled value has in this situation been read out on a PWM output of the DSP.

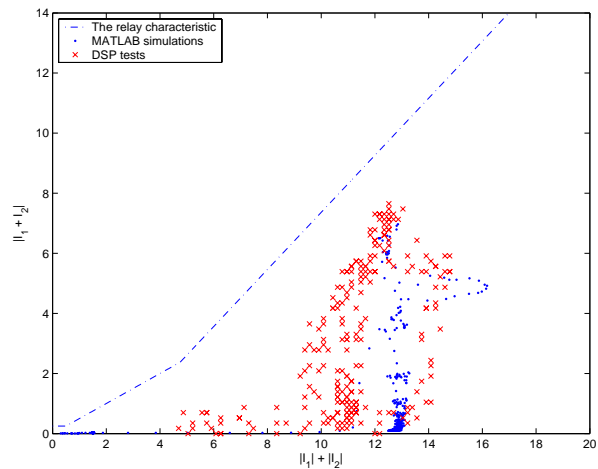

Fig. 6. The sum and difference of the phase pair for phase 1 for an external fault compared to an example of a relay characteristic. The simulated and the DSP sample are also somewhat coinciding.

Figure 6 shows that the sampled values for the external fault are somewhat well defined below the relay characteristic, which makes it possible to estimate an external fault situation and avoid activation of a circuit breaker.

The 2nd and 5th harmonics of the fundamental frequency are used to detect inrush and overexcitation of the power transformer. An example of an inrush current situation for the power transformer is shown in figure 7.

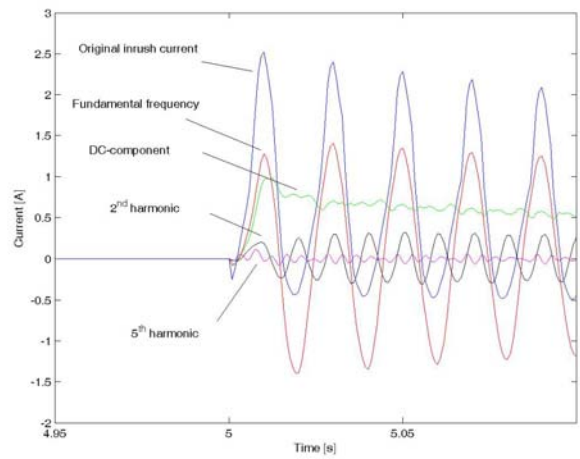

Fig. 7. The detection of a relatively high amplitude of the 2nd harmonic frequency compared to the fundamental frequency during inrush of the power transformer.

The detection of a high amplitude of the 2nd harmonic relative to the amplitude of the fundamental frequency in figure 7 is used to prevent a fault detection during start up of the power transformer.

An example of saturation in an overexcitation situation for the power transformer is shown in figure 8.

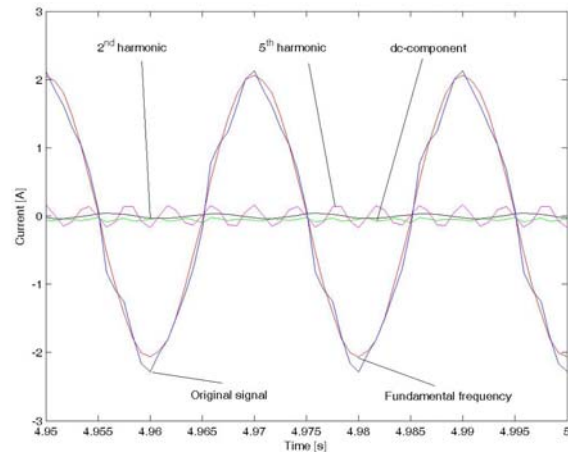

Fig. 8. The detection of a relatively high amplitude of the 5th harmonic frequency compared to the fundamental frequency during over excitation of the power transformer.

The detection of a high amplitude of the 5th harmonic relative to the amplitude of the fundamental frequency in figure 8 is used to prevent fault detection during overexcitation of the power transformer.

An example of a CT saturation situation is shown in figure 9. It can be seen, that the original current signal is distorted due to the magnetic saturation of the CT iron part. Using the Kalman estimation method, the detection of the high amplitude of the 2nd harmonic relative to the amplitude of the fundamental frequency in figure 9 can be used to prevent unnecessary activation of circuit breakers in the case of CT saturation.

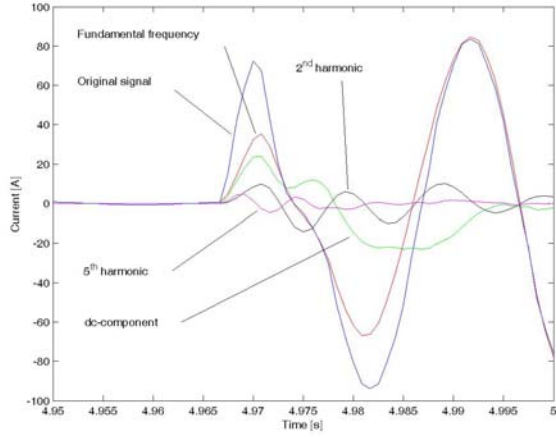

Fig. 9. The detection of a relatively high amplitude of the 2nd harmonic frequency compared to the fundamental frequency during saturation of a CT.

VI. CONCLUSION

This paper has presented the results of a verification study, showing that the Kalman phasor estimation of the fundamental fault current is 30% more accurate within the first half period of the fault duration than the Fourier estimation method. It has been documented in this paper that it is possible to implement the Kalman phasor estimation on a 32 bit DSP of the type TMS320F2812 from Texas Instrument. Tests showed that within the first half period of the signal, the Kalman algorithm could estimate a series of faults, both externally and internally with regards to the protection zone of the differential relay. In the paper it has been demonstrated how the Kalman algorithm is able to distinguish between internal and external faults, and it has been shown how both tests on a DSP and MATLAB simulation results fulfils the requirements of a differential protection. Based on the tests it can be concluded that the Kalman phasor estimation technique is a better choice compared to the Fourier transformation, because it is a somewhat faster estimation. Additionally, the paper has shown how inrush and overexcitation of the power transformer, along with saturation of CTs, can be detected using the Kalman phasor estimation. This was done by implementing estimation of the 2nd and 5th harmonics as a part of the Kalman phasor estimation algorithm.

Based on this it can be concluded that it is possible to implement the Kalman phasor estimation technique on a DSP with estimation of the 2nd and 5th harmonics, which thus makes it possible to use the technique as a differential protection that can distinguish between inrush and overexcitation in the power transformer as well as saturation of CTs, compared to an internal fault in the differential protection.

VII. APPENDIX

$$\hat{i}((n+1)\Delta t) = I_0 \cdot e^{-\frac{\Delta t}{\tau}} + I_1 \cos(\omega_0 \Delta t + \theta_1) + I_2 \cos(2\omega_0 \Delta t + \theta_2) + I_5 \cos(5\omega_0 \Delta t + \theta_5) \quad (10)$$

$$A = \begin{bmatrix} 1 & 1 & 0 & 1 & 0 & 1 & 0 \end{bmatrix}$$

$$H = \begin{bmatrix} e^{-\frac{\Delta t}{\tau}} & 0 & 0 & 0 & 0 & 0 & 0 \\ 0 & \cos(\omega_0 \Delta t) & -\sin(\omega_0 \Delta t) & 0 & 0 & 0 & 0 \\ 0 & \sin(\omega_0 \Delta t) & \cos(\omega_0 \Delta t) & 0 & 0 & 0 & 0 \\ 0 & 0 & 0 & \cos(2\omega_0 \Delta t) & -\sin(2\omega_0 \Delta t) & 0 & 0 \\ 0 & 0 & 0 & \sin(2\omega_0 \Delta t) & \cos(2\omega_0 \Delta t) & 0 & 0 \\ 0 & 0 & 0 & 0 & 0 & \cos(5\omega_0 \Delta t) & -\sin(5\omega_0 \Delta t) \\ 0 & 0 & 0 & 0 & 0 & \sin(5\omega_0 \Delta t) & \cos(5\omega_0 \Delta t) \end{bmatrix}$$

$$\vec{Y}(n) = \begin{bmatrix} I_0 \\ I_1 \cos(\theta_1) \\ I_1 \sin(\theta_1) \\ I_2 \cos(\theta_2) \\ I_2 \sin(\theta_2) \\ I_5 \cos(\theta_5) \\ I_5 \sin(\theta_5) \end{bmatrix}$$

VIII. ACKNOWLEDGMENT

The authors gratefully acknowledge the contributions of the company Aalborg Energie Technik a/s for providing technical information about the combined heat/power station in Linz-Mitte, Austria.

IX. REFERENCES

- [1] G. Ziegler, *Numerical Differential Protection-Principles and Applications*, vol. I. Erlangen: Publicis Corporate, 2005.
- [2] M.S Sachdev, R.Das "Understanding microprocessor-based technology applied to relaying, Power System Relaying Committee, Report of Working Group I16 and the Relaying Practices Subcommittee, February 2004.
- [3] ELIN Energieversorgung GmbH, "Kraftwerkssystemtechnik: Digitales Schutzrelais", DRS-COMPACT, Donau Forum Druck.
- [4] P. Pankajakshan., "Phase measurement using Kalman filtering", in *Proc. 1991 IEEE Power Engineering Society Transmission and Distribution Conf.*, pp. 315-320.

X. BIOGRAPHIES:

Bjarne Bukh was born in Nykøbing Mors, Denmark on December 28, 1974. He is studying M.Sc (electrical power eng.) at institute of energy technology, Aalborg University.

Unnur Stella Gudmundsdottir was born in Reykjavik, Iceland on February 15, 1980. She is studying M.Sc (electrical power eng.) at institute of energy technology, Aalborg University.

Per Balle Holst was born in Tommerup, Denmark, on September 14, 1979. He is studying M.Sc (electrical power eng.) at institute of energy technology, Aalborg University.

Kim Boe Jensen was born in Holstebro, Denmark, on marts 10, 1976. He is studying M.Sc (electrical power eng.) at institute of energy technology, Aalborg University.

Louise Carina Jensen was born in Aalborg, Denmark on April 30, 1983. She is studying M.Sc (electrical power eng.) at institute of energy technology, Aalborg University.

Claus Leth Bak was born in Ugelbølle near Århus, Denmark, on April 13, 1965. He received the B.Sc (electrical power eng.) degree in 1992 from the engineering college in Århus and the M.Sc (electrical power eng.) degree in 1994 from institute of energy technology, Aalborg University. From 1994 to 1999 he was working at Nordjyllandsværket power plant with planning, design operation and maintenance of 150 and 60 kV substations and relay protection. He was employed as an assistant professor at the dept. of power systems and high voltage, institute of energy technology, Aalborg University in September 1999 and is currently holding a position as an associate professor. Main research areas are: High voltage engineering with focus on gaseous discharges and overhead line corona, relay protection with focus on power system simulation transient testing of relays.