



AALBORG UNIVERSITY
DENMARK

Aalborg Universitet

Testing, Analysis and Control of Wave Dragon, Wave Energy Converter

Tedd, James William

Publication date:
2007

Document Version
Publisher's PDF, also known as Version of record

[Link to publication from Aalborg University](#)

Citation for published version (APA):
Tedd, J. (2007). Testing, Analysis and Control of Wave Dragon, Wave Energy Converter. Aalborg: Department of Civil Engineering, Aalborg University. (DCE Thesis; No. 9).

General rights

Copyright and moral rights for the publications made accessible in the public portal are retained by the authors and/or other copyright owners and it is a condition of accessing publications that users recognise and abide by the legal requirements associated with these rights.

- ? Users may download and print one copy of any publication from the public portal for the purpose of private study or research.
- ? You may not further distribute the material or use it for any profit-making activity or commercial gain
- ? You may freely distribute the URL identifying the publication in the public portal ?

Take down policy

If you believe that this document breaches copyright please contact us at vbn@aub.aau.dk providing details, and we will remove access to the work immediately and investigate your claim.

Testing, Analysis and Control of Wave Dragon, Wave Energy Converter

PhD Thesis
Defended in public at Aalborg University
(101207)

James Tedd

Aalborg University
Department of Civil Engineering
Hydraulics and Coastal Engineering Laboratory

DCE Thesis No. 9

**Testing, Analysis and Control
of Wave Dragon,
Wave Energy Converter**

**PhD Thesis defended in public at Aalborg University
(101207)**

by

James Tedd

October 2007

© Aalborg University

Scientific Publications at the Department of Civil Engineering

Technical Reports are published for timely dissemination of research results and scientific work carried out at the Department of Civil Engineering (DCE) at Aalborg University. This medium allows publication of more detailed explanations and results than typically allowed in scientific journals.

Technical Memoranda are produced to enable the preliminary dissemination of scientific work by the personnel of the DCE where such release is deemed to be appropriate. Documents of this kind may be incomplete or temporary versions of papers—or part of continuing work. This should be kept in mind when references are given to publications of this kind.

Contract Reports are produced to report scientific work carried out under contract. Publications of this kind contain confidential matter and are reserved for the sponsors and the DCE. Therefore, Contract Reports are generally not available for public circulation.

Lecture Notes contain material produced by the lecturers at the DCE for educational purposes. This may be scientific notes, lecture books, example problems or manuals for laboratory work, or computer programs developed at the DCE.

Theses are monographs or collections of papers published to report the scientific work carried out at the DCE to obtain a degree as either PhD or Doctor of Technology. The thesis is publicly available after the defence of the degree.

Latest News is published to enable rapid communication of information about scientific work carried out at the DCE. This includes the status of research projects, developments in the laboratories, information about collaborative work and recent research results.

Published 2007 by
Aalborg University
Department of Civil Engineering
Sohngaardsholmsvej 57,
DK-9000 Aalborg, Denmark

Printed in Denmark at Aalborg University

ISSN 1901-7294
DCE Thesis No. 9

Preface

This thesis, *Testing, Analysis and Control of Wave Dragon, Wave Energy Converter* is submitted as one of the requirements set out in the Ministerial Order No. 114 of March 8th, 2002 regarding Phd studies. The Thesis will be defended by a public lecture on December 10th, 2007 at Aalborg University.

The author has been supported with a fellowship by the Marie Curie WaveTrain research training network, administered by SPOK ApS. Studies of the Wave Dragon Nissum Bredning prototype and laboratory tests have been supported by the European Commission (Contract No: ENK5-CT-2002-00603) and the Danish energy Authority, elkraft System (PSO funding). The author's research has been co-financed by Aalborg University. The Study has been conducted during the period January 2005 to October 2007 at the Civil Engineering Department, Aalborg University, under the supervision of Associate Professor Peter Frigaard, with close co-operation of Assistant Professor Jens Peter Kofoed.

This study has only been made possible by to the dedication of the Wave Dragon project team and partners in developing the Wave Dragon device. The author is eternally indebted to them for providing such a fantastic opportunity, and for their support at all stages. The author would like to thank the staff in the wave energy group of Aalborg University for their valuable advice, the laboratory technicians for their excellent help and to Bendy for his patient assistance at the prototype device. Finally the author would like to thank his parents for their wise counsel and to Katie for her incalculable encouragement and support during this time overseas.

James Tedd

Aalborg, October 2007

Abstract

One of the prongs in the attack on climate change is the development of alternative, non-polluting sources of energy. Wave Dragon is a device at the forefront of this field of development, converting the energy of ocean waves into electricity. This thesis presents the author's work on the technical aspects of the device. The work has been enabled by the close co-operation of the Wave Dragon partner companies and the use of the highly instrumented prototype device in Nissum Bredning in Northern Denmark.

This thesis is presented as a collection of works published by the author. These include a chapter of a textbook, a submitted journal paper and three peer-reviewed conference papers. The content can be broadly divided into four topics: experiences gained with the Wave Dragon prototype device; power-production verification; overtopping analysis; and improvements in control.

A comprehensive record of the process Wave Dragon has undergone to develop from an inventor's concept to a serious contender in the wave energy industry is very valuable. This shows the gradual steps of development testing, increasing in scale and complexity, in parallel with the growth in the organisational structure behind the device. The current high-point of this, the autonomously operating prototype, is presented in detail to show the operating methods, instrumentation and the challenges experienced during its lifetime.

The purpose of the Wave Dragon is to produce electricity. Therefore at each increment in scale the first question asked is: "Does it produce as much as expected?" To answer this question results are presented from testing of the prototype device. This has given the broad answer "Yes", although the answer must be qualified by discussing operation away from the optimal configuration, and methods to scale the expected performance. Other sources of generation are presented, including development and tank testing of a novel power absorbing joint.

Wave Dragon belongs in the family of overtopping wave energy converters. The energy is captured by waves running up a ramp and overtopping the crest into a reservoir. This stored water, at a higher level than the sea, is returned through low-head turbines powering electrical generators. To improve the quality of modelling of these devices, the short-term characteristics of this overtopping flow are presented based on measurements taken on the prototype.

Advance knowledge of the incident waves upon a wave device allows the possibility of accurately tuning the power-take off mechanism (the hydro-turbines for the Wave Dragon) to capture more energy. A digital filter method for performing this prediction in real-time with minimal computational effort is presented. Construction of digital filters is well known within signal processing, but their use for this application in Wave Energy is new. The filter must be designed carefully as the frequency components of waves travel at different speeds.

Research presented in this thesis has advanced the development of the Wave Dragon device and contributes to the stated objective of furthering research in the wave energy field.

Dansk resume

Et element i krigen mod klimaændringer er udvikling af alternative, ikke-forurenende kilder til produktion af energi. Wave Dragon, som er en førende teknologi indenfor området, omdanner havets bølger til elektricitet. Nærværende afhandling omhandler forfatterens arbejde med de tekniske aspekter i relation til udviklingen af Wave Dragon. Arbejde er gennemført i samarbejde med selskaberne bag Wave Dragon, og er i høj grad baseret på anvendelse af den højt instrumenterede Wave Dragon, som har ligget i Nissum Bredning i Norddanmark siden 2003.

Indeværende afhandling indeholder et udpluk af arbejder udført og allerede publiceret af forfatteren. Disse publikationer omfatter et kapitel i en lærebog, et indleveret journal paper samt 3 peer-reviewed konference papers. Afhandlingen kan teknisk set opsplittes i fire emneområder: Erfaringsopsamling på Wave Dragon teknologien og dens historiske udvikling; verifikation af energiproduktion; analyse af bølgeoverskyl; og forbedringer i styringen af energiudtaget.

En komplet historisk beskrivelse af den proces Wave Dragon har gennemgået fra ide (opfindelse) frem til i dag at være en seriøs aktør i bølge-kraft industrien, er værdifuld for at forstå betydningen af forfatterens andre arbejder. Den historiske beskrivelse forklarer udviklingen af afprøvning, stigende i skala og kompleksitet, sideløbende med udviklingen af organisationen bag teknologien. Flagskibet i denne udvikling, den energiproducerende enhed placeret i Nissum Bredning, præsenteres detaljeret for at demonstrere virkemåde, instrumentering samt udfordringer set i dens levetid.

Formålet med Wave Dragon er produktion af elektricitet. Derfor er første spørgsmål: "Producerer den som forventet?" For at kunne besvare dette spørgsmål præsenteres resultater fra Nissum Bredning anlægget. Det brede generelle svar er "Ja", selvom svaret skal underbygges gennem en kvalificeret diskussion af en virkemåde der ikke altid har været konfigureret optimalt, samt metoder til skalering af den sete virkemåde. Andre kilder til energiproduktion på Wave Dragon er beskrevet, hvilket inkluderer udvikling og bølgebassin afprøvning af et nyt energi absorberende led.

Wave Dragon er et overskylds bølgekraftanlæg. Anlægget fungerer ved at bølger løber op langs en rampe, overskyller en kam og fanges i et reservoir. Dette vand, som nu befinder sig i et højere niveau end havets overflade, bringes tilbage gennem nogle lavtryks vandturbiner. For at forbedre beskrivelsen af dette power take off, er korttids karakteristikkene af de overskyldende bølger præsenteret baseret på målinger foretaget på anlægget i Nissum Bredning.

Detaljeret kendskab til de indkommende bølger til et bølgeenergianlæg giver mulighed for at tune power take off delen (lavtryks vand turbinerne på en Wave Dragon) til at optage mest muligt energi. En digital filter metode til lever forudsigelse i real tid med minimal beregningsindsats er udviklet og beskrevet. Konstruktion af digitale filtre er velkendt indenfor signalbehandling, men anvendelsen indenfor bølgeenergiområdet er nyt. Filteret skal være designet omhyggeligt eftersom bølger med forskellige frekvenser har forskellige udbredelseshastighed.

Contents

Preface	
Abstract	1
Dansk resume	3
Contents	5
Thesis Summary	7
Introduction	7
Background	7
Objectives	9
Wave Dragon prototype	11
Power performance	13
Overtopping analysis	18
Wave prediction	21
Ongoing and future research	24
Conclusions	26
Ocean Wave Energy Chapter 7, Device Experience: Wave Dragon	27
Wave Dragon technology	29
Operational experience	44
Test Centres, Pilot Zones and European Co-operation	57
Renovation of the Wave Dragon Nissum Bredning Prototype	65
Wave Dragon, prototype wave power production	73
Measurements of overtopping flow time series on the Wave Dragon, wave energy converter	81
Short term wave forecasting, using digital filters for improved control of Wave Energy Converters	91
Appendix 1. Data handling from the Nissum Bredning prototype	101
Appendix 2. Related publications by the author	104
Bibliography	106

THESIS SUMMARY

Introduction

This summary is a stand-alone document which will introduce the reader to the topics presented in the author's publications. The background to the project shows the motivation behind the study, and explains how the author came to work in the field. For each topic an extended summary and introduction is given explaining the publications' relevance. The reader's attention is drawn to the most interesting results and conclusions of the publications, especially where they support each other. Additional research by the author is included where this can re-emphasise a point or provide further insight. For the fullest details the reader is recommended to read the author's publications re-printed in this thesis.

Background

Many factors are driving the development of wave power at global, national, regional and commercial levels. At the global level the correlation between anthropogenic carbon emissions and climate change is widely accepted, with electricity generation a major contributing factor to these emissions. The Intergovernmental Panel on Climate Change recognises the development of non-fossil based electricity generation, including wave power as a key mitigating measure (IPCC, 2007).

On the national level, governments are increasingly worried about the trend towards importing energy, from insecure areas of the world. In Western Europe there is the greatest wave resource; in the UK 15 - 20% of electricity demand could be supplied practically and economically by wave power (Carbon Trust, 2006). The growth of valuable high-tech development leading to an exporting industry, as seen in the case of the Danish wind industry, is an additional incentives. On the regional level, the development is likely to provide high quality employment (both in servicing and construction). Such employment would be situated in rural areas and old industrial ports, both often relatively deprived areas of otherwise prosperous nations.

Commercially the economics of wave energy are becoming more attractive. Greater electricity costs, possible carbon taxes (as high as \$50 / tonne, suggested by Stern, 2006) and increasing subsidies (up to €0.24 per kWh, IEA-OES, 2006) will make even the early generation wave devices economic. This has brought many more companies into the field, competing to be the first to show good performance at an acceptable cost.

A weakness in the emerging industry has been the lack of new graduates joining firms, as cash-flows can often be insecure. To combat this the European Commission funded the Marie Curie WaveTrain research training network, to train a new generation of engineers in the field (Sarmiento et al, 2006). The author is a fellow on this network. While predominantly focused on the Wave Dragon device much of the author's time has been devoted to visiting and co-operation with the other partner companies and institutions across Europe.

Many devices are being developed for exploiting wave energy. These can be split into point-absorber devices, attenuators and terminators. Point absorbers are small compared to the waves and oscillate with one or more degrees of freedom. The most advanced devices of this type are the Archimedes Wave Swing, the WaveBob and the Pico oscillating water column; all have been tested for limited time periods in prototype scale. An attenuator device is long in the direction of wave propagation, and absorbs the energy diffracting onto it. The most developed is the Pelamis device, where a 2.2 MW, three device power plant is ready to be commissioned in Portugal. The Wave Dragon is a terminator type device. These are characterised by showing a wide front along the wave crest and allowing little energy to pass. Other overtopping devices, relying on water surging up a ramp and into a high reservoir before draining through turbines, such as the Wave SSG and the TapChan are also terminators. Links to further information on these projects can be found in IEA-OES, 2006.

The Wave Dragon is a floating overtopping wave energy device, converting the energy in the waves into electrical energy to be exported to the national grid. Since 1998 a 1:50 scale has been tested in the wave basin facilities in Aalborg University. This led to the formation of a European consortium, which constructed and deployed a 1:4.5 scale device in an inland sea in Northern Denmark in 2003. Aalborg University's Civil Engineering Department operates the device as a field laboratory and have made extensive studies of it. The author has worked on the device and its data at Aalborg University between January 2005 and October 2007.

The focus for Wave Dragon is now on the first 7 MW unit planned to be deployed in Wales. This will be the largest wave power generation scheme in the world.

Objectives

The author has been contracted to work on the Wave Dragon device, therefore the prime motivation of the study has been to develop the device towards commercial reality. During this research many of the intermediate results are of interest or use to the broader community. The overall objective of this thesis is therefore to disseminate the information gained from the author's work on the Wave Dragon device, where this information is relevant for other researchers in the field.

The specific objectives of this thesis are to:

Demonstrate best practice to the wave energy industry

Today's wave energy industry is often compared to the early days of the aviation industry. There are many small companies developing their own inventions and often not learning from each other. In the historic case the emerging winner is considered to be the Wright brothers' Flyer. Unlike other developers who went straight to market, the brothers methodically tested aerofoils at scale before building their first units. This theoretical basis allowed successful tests and by sharing their knowledge they put the aerospace industry on the path to its present importance.

In the ocean energy industry several developers are rushing to develop their devices without sufficient testing and modelling at smaller scale. The International Energy Agency (IEA-OES, 2006) and the UK's Department of Trade and Industry (DTI, 2007) are developing protocols and best practice guidelines for this development. Wave Dragon is seen as one of the developers who have best implemented a complete and clear procedure. Publishing detailed results and the testing procedure will inform guidelines and standards for testing, development and certifying of all devices.

Advance research in wave energy

This thesis contains technical advancements which are of interest to wave energy researchers. Collating into one thesis makes these more accessible. Two clear advancements are in the modelling of overtopping and the design of filters for prediction of waves. Modelling of overtopping for low-crested structures is useful to all developers of overtopping wave devices. Filter design for prediction has already generated interest from other wave energy developers.

Record the development of the Wave Dragon

During the history of the wave energy industry the story of many devices has been sadly lost. The first oil crisis in the 1970s provided early momentum for wave energy. Norway pioneered devices by testing an oscillating water column and an overtopping device on their North Sea cliffs. Neither was a great success, and after funding stopped the results of both are hard to find. In the UK in the 1980s the near-shore oscillating water column device, the Osprey, sank within days of being deployed in an unexpected storm. Apart from early enthusiasm, careful reflection on the merits of these devices and the

cause of their problems has not been published. This has inevitably led to repetition of similar mistakes.

In summary, this thesis provides a record of the current situation of the Wave Dragon, its performance in the prototype stage, the problems which have been overcome and advancements which are ongoing. The author's papers reprinted in this thesis address these main topics. This documentation will be of interest when Wave Dragons are a common sight in the oceans; or as part of the historical record if Wave Dragon is not so successful.

Wave Dragon prototype

The prototype Wave Dragon has been central to this thesis. The device is deployed in Nissum Bredning, an inland sea of Northern Denmark. The device is a 1:4.5 scale version of a North Sea production unit to match the lower wave climate of the area (Svendsen and Frigaard, 2001). Due to the smaller size, instrumentation, maintenance and experimentation aboard are much simpler to perform.

Device

The principal structural component of the Wave Dragon is the floating reservoir platform. Oncoming waves surge up a ramp and overtop into the reservoir. Energy is extracted as this water passes through a series of low-head hydro-turbines back down to the sea, as shown in Figure 1. There are additionally two wings, hinged to the platform, which reflect the waves towards the ramp to improve the performance. The individual components are all well established technologies. The Wave Dragon is a novel application combining these to produce electricity from the waves.

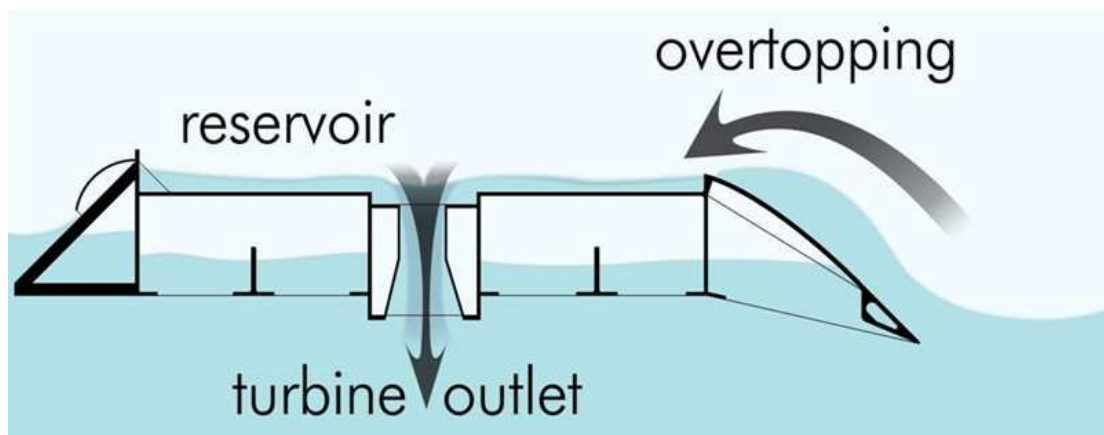

Figure 1, Wave Dragon operational principle.

The sections of the book *Ocean Wave Energy*, ed. Cruz, re-printed in this thesis provide a complete introduction to the Wave Dragon, the history of the Wave Dragon prototype (shown in Figure 2), its subsystems, and basic theory. The chapter is the author's contribution to a textbook on wave energy (Cruz, 2007), which shows the current status of the industry and future perspectives. The editor of the book was also a fellow of the WaveTrain research network; other co-authors of the book are international experts in the field.



Figure 2, Wave Dragon prototype in Nissum Bredning, Northern Denmark.

The European Commission funded the Wave Dragon consortium of nine companies and two universities to construct and test the prototype. The device was first

commissioned in April 2003. Many significant issues with the device had been ironed out, and the first results analysed by January 2005 when the author began working with Wave Dragon. Much data still required analysis, and provided the input to much of the work in this thesis. Appendix 1 contains detailed information on this data and its processing.

Development

The author's paper "Renovation of the Wave Dragon Nissum Bredning Prototype" presented at the 2006 conference of the International Society of Offshore and Polar Engineers describes the improvements made to the structure and instrumentation during 2005 and early 2006 while the device was in harbour. The author was involved in renewing the measurement systems, which allowed more reliable recordings to be made during the second period of deployment from March 2006.

Once redeployed the opportunity to make specific tests on the device existed. The aim was to construct the transfer function between individual waves and overtopping events. The author designed and constructed a run-up gauge for fixing to the ramp, however this unfortunately failed due to adverse weather conditions. A successful test was made of the flow incoming into the reservoir. This required keeping the reservoir level to a minimum, to prevent water spilling back over the ramp.

Power performance

The Wave Dragon converts the energy of the waves into electricity. Therefore the performance of the device is of major interest in this thesis. The requirements for this power performance can be split into the following three categories:

Commercial Requirement

To pass the due-diligence of investors the device developers must guarantee a power production for each of a range of sea states. This is usually desired in the form of a Power Matrix, with mean output electricity to the grid for wave state parameters significant wave height, H_S and peak period, T_P . In the earlier development stage commercial backers may accept a predicted production.

Design Improvements

Quantifying the power produced in comparable sea-states can give an insight into the design parameters. Comparison of various setup conditions, such as the turbine strategy, buoyancy distribution and platform floating condition, show the best solutions. This can lead to improvements in the design of the device and its control strategies as is described by Kofoed et al (2007).

Scaling Validation

When making large changes in scale from a laboratory model the scaled down tests must be checked. For the Wave Dragon surface tension and the compressibility in the buoyancy compartment are not scaled correctly with Froude scaling. Additionally the method for modelling the turbines must be shown to be accurate. By confirming the validity of the scale tests, further laboratory tests can be performed with greater confidence.

There are many ways to quantify the power performance of a device such as the Wave Dragon. There is a careful balance to be made between simplicity and complexity. The simplest measure is likely to miss effects which are present as it is an early prototype. More complex measures can be awkward to explain to lay-people, thus giving the impression of making many excuses. The results considered for the Wave Dragon are the following:

Delivered electrical power to the grid

This is the result which will be required eventually for an investor. However in the case of a 1:4.5 scale device (with power production scaling by $1:4.5^{3.5}$, i.e. 1:193) this is a highly biased measure. The power converter units, cooling system for the cabin, instrumentation and control computers demand a considerable power to maintain the device. Therefore only in large sea states does the prototype platform deliver power to the grid. The power requirement for these auxiliary systems would be proportionately much less for a open sea scale unit.

Produced electrical power generated by the turbines

This measure shows the performance of the turbines, and how they work. However, again it gives a result biased on the low side. On the prototype Wave Dragon seven of the turbines are equipped with generators, with an additional three “dummy” turbines, in fact calibrated valves. This compares to a projected full sized Wave Dragon with 16-20 operational turbines. Power dissipated through the dummy turbines is not included. An additional cause for bias, is the efficiency of the turbines in this small scale, dropping from 80-95% in full scale to 40-80% in this scale, due mainly to frictional effects.

Hydraulic power passing through the turbines

The flow and the head across each turbine are used to calculate the hydraulic energy dissipated by each. As the efficiency of full scale turbines is projected to be very high this is the closest measure to the full scale power production. It has been used most widely for comparison of operational strategies for making improvements to the design.

Estimated electrical power delivered by the turbines

This measure is rather convoluted; showing the production assuming the turbines (including dummies) had produced as designed. During testing the speed control of the turbines was changed, to ensure they turned at the optimal speed for a given head of water. This measure is used for comparison to, and calibration of, the power production simulations.

Flow passing through the turbines of the device

This is the most direct measure which compares to the laboratory model testing and theory. At laboratory 1:50 scale power was gauged by measuring the flow into the device at a given floating level. Much literature exists examining the overtopping flow rates, allowing further checks on the results.

In the paper “Wave Dragon, prototype wave power production” presented by the author at the ninth World Renewable Energy Congress (WREC) in Florence the author published detailed time histories of the power production of the Wave Dragon. Figure 3 is replicated from the paper.

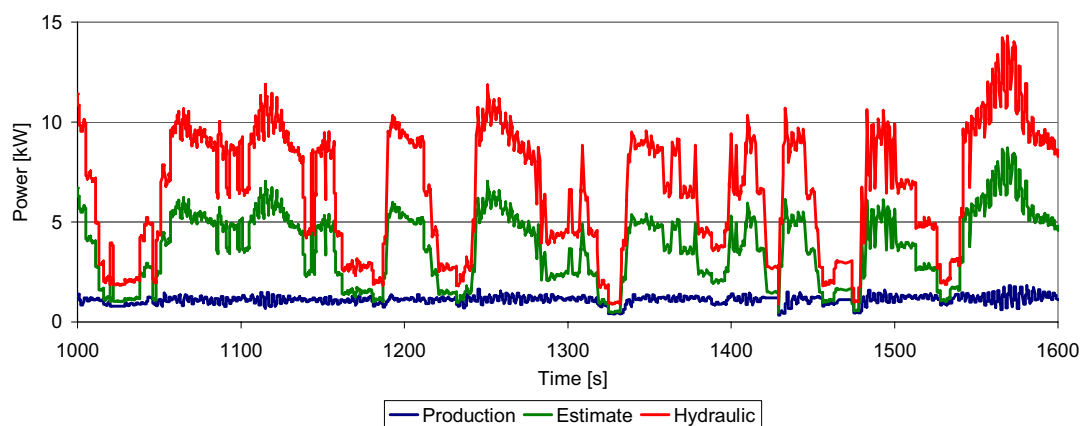

Figure 3, Time history of power production, Tedd et al. WREC, 2007.

Figure 3 shows three of the power traces as described above. Produced power does not vary as for most of this period three generators are operating continuously, and the dummy turbines are switching in and off as seen in the Estimated and Hydraulic power. The effect of the smoothing of the wave power by the reservoir can be seen from the Hydraulic power. It is much less variable than the wave energy incident at the device, or the power which may be extracted by a typical point absorber.

Flow comparison to theory

During the later part of 2004 much data was collected by the Wave Dragon operating without reflector wings. These tests allow clear comparison to the theory and laboratory tests of generic overtopping ramps. Kofoed (2002) considered the overtopping formula for low crested two dimensional structures and devised the relationship in equation 1. This equation is derived from studies on higher freeboard structures presented by Van de Meer and Janssen (1994).

$$Q_N = \frac{\bar{Q}}{W \sqrt{gH_S^3}} \cdot \frac{1}{\lambda_{d_r}} \cdot \frac{1}{\lambda_\alpha \lambda_s} = 0.2e^{-2.6 \frac{R_C}{H_S} \left(\frac{1}{\gamma_b \gamma_h \gamma_f \gamma_\beta} \right)} \quad (1)$$

Where:

$\frac{Q_N}{\bar{Q}}$	Non-dimensional flow
$\frac{\bar{Q}}{W}$	Average flow \bar{Q} per unit of ramp width W
$\frac{1}{\sqrt{gH_S^3}}$	Standard non-dimensionalising factor for flow, using acceleration due to gravity g and significant wave height H_S
λ_{d_r}	Reduction factor for energy passing beneath the draft of the ramp as defined by Kofoed (2002). This is calculated for the case of Wave Dragon.
λ_α	Reduction factor for non-optimal slope defined by Kofoed (2002). Unity is used to compare to the Wave Dragon.
λ_s	Reduction factor for low relative crest freeboard, as defined by Kofoed (2002).
$\frac{R_C}{H_S}$	Non-dimensional crest freeboard, the ratio between crest freeboard R_C and H_S
$\gamma_b, \gamma_h, \gamma_f, \gamma_\beta$	Constants describing reduction factors for overtopping of the ramp (berm, shallow foreshore, roughness and oblique wave attack) as defined by Van de Meer and Jansen (1994). These are unity for the case of the Wave Dragon.

Equation 1 gives a non-dimensional form for the overtopping to enable comparison from tests in different scales. It also provides an empirical result for the overtopping given a set of input parameters. This empirical result is compared to the overtopping measure on the Wave Dragon without its wings as shown in Figure 4.

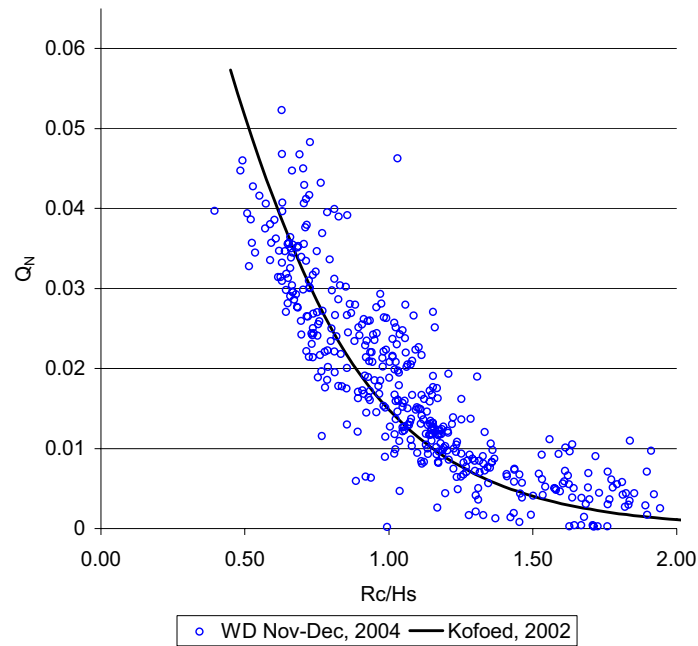

Figure 4, Comparison of measured overtopping flow on the Wave Dragon prototype without reflectors, to two dimensional theory.

These results show a good correlation to the theory. This shows the basic structure of the Wave Dragon is working well. The scatter can be due to the specific operating conditions, variations in turbine strategy, lack of turbine capacity leading to spill, various buoyancy configurations of the platform and natural scatter of the random process. These effects are illustrated in Kofoed et al, 2007. As expected many of the records are above the expected line. This shows the influence of the improved geometry of the double curved Wave Dragon ramp, above the straight geometry of the two dimensional case, as well as the improvements due to guiding fins on the ramp. Apart from the natural scatter of the overtopping process there are many related topics to research and develop to further improve the performance of the Wave Dragon.

Design of reflector wings

The wings of the Wave Dragon are designed to focus the waves towards the ramp, thus increasing the wave height and increasing the overtopping. The marginal cost of the wings must be less than the improvement in performance. In the paper “Renovation of the Wave Dragon Nissum Bredning Prototype” presented by the author to the 2006 conference of the International Society of Offshore and Polar Engineers the development of a new design for the joint between the wings and the platform is presented.

Testing on the 1:50 scale laboratory device was conducted in the wave basin facilities at Aalborg University during the summer of 2005. The testing concentrated on measuring the forces in the joint and the motions of the reflector. As the new “ball and socket” design resulted in large roll motions of the reflector a hydraulic power take off system was included in the design to reduce the extreme motions and extract energy. The system was modelled using a cylinder pressing water through a length of thin piping. The measurement system shown in Figure 5 measures concurrently the roll motions of the reflector and the turning moment, thus providing the power absorbed.

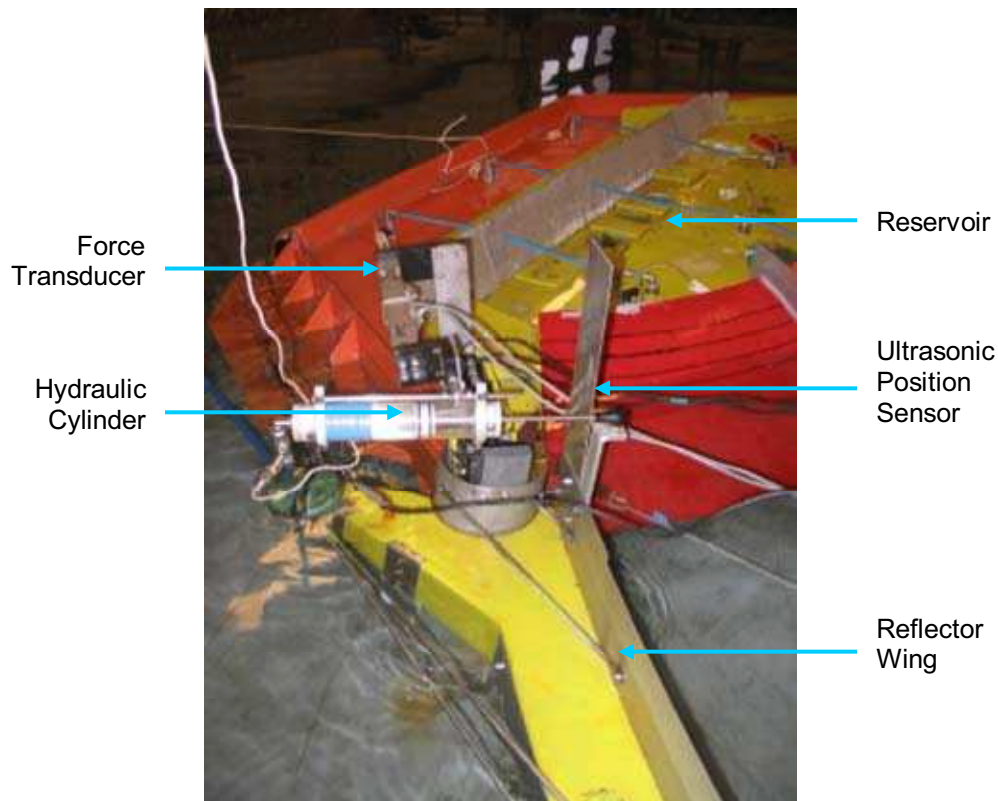

Figure 5, Set up for testing of reflector joint at Aalborg University wave basin

In addition to damping the joint mechanism to prevent extreme motions, it is very important to keep the reflector as stiff as possible to reflect the waves. The projected performance of the reflector wings (Kramer and Frigaard, 2002) is based on laboratory testing and numerical modelling with reflectors in a fixed position. A rotation of even a few degrees will have a very adverse effect on the reflection performance of the wings. The design currently proposed must therefore be carefully considered to ensure that minimal rotation occurs.

The conclusions of the testing in the laboratory are that by tuning the hydraulic dampers the power absorbed in the hydraulic cylinders at the two joints would be of the order of 20% of the power of the device. With the reflectors fixed as rigidly as possible the increase in power, through increased overtopping, would be of the order of 100% improvement. Therefore the design of the joints should strongly favour rigidity. In this case the potential power to be absorbed by the hydraulic cylinders would be negligible.

Overtopping analysis

In order to simulate the power production of an overtopping device a model for the overtopping flow into the reservoir must be constructed. In practice this is made in two sections, the average flow for a given sea-state and crest freeboard and the time distribution of the flow. This enables a simulation programme (such as presented by Jakobsen and Frigaard, 1999 for Wave Dragon or Meinert et al., 2006 for the Wave SSG) to be used to optimise the device geometry, turbine set-up and control points.

Average overtopping flow

When extrapolating from one wave situation to another, it is important to represent realistically the physical situation. The wave period has a weak influence on the overtopping rate of the Wave Dragon, this can therefore be hard to distinguish. Early expressions for the average overtopping rate of Wave Dragon used a criterion based on the wave steepness S_{op} . This is commonly used in high crest freeboard applications such as dykes, where occasional storms cause the majority of the overtopping. Storms in which many of the waves are broken (i.e steep unstable waves of S_{op} above 0.141, (CEM, 2002)) result in lower overtopping. Wave Dragon predominantly extracts energy from waves far below the breaking steepness, which surge up the ramp.

In Figure 6 a comparison is made between the waves measured at the first test site in Nissum Bredning to typical sea states for a production device. The waves from Nissum Bredning have been scaled up using the Froude scaling by a length factor of 4.5. The Wales wave states represent five typical seas measured from a meteorological buoy at Turbot Bank near the planned deployment site for the first full scale Wave Dragon. The North Sea wave states are five representative sea states for energy production in the Danish part of the North Sea, as defined by Bølgekraftudvalgets Sekretariat 2002. These sea states (scaled down by a factor of 50) were used in early testing of the Wave Dragon in the wave basin in Aalborg University.

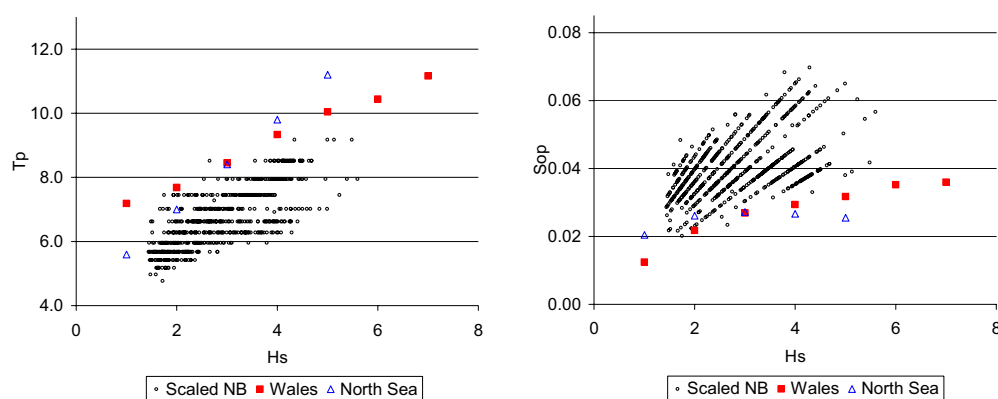

Figure 6, Comparison of wave states and wave steepness between prototype testing in Nissum Bredning (NB) and open-sea production conditions in Wales and the North Sea.

Typical power production sea states at Wales and the North Sea have similar steepness. However the states in Nissum Bredning are scattered around half the

steepness. This led to lower expected efficiencies in Nissum Bredning, as compared to the North Sea when using the criterion based on S_{op} . Early comparisons of performance in Nissum Bredning were therefore inaccurate when scaled to the open sea situations.

An improved method for including the wave period dependence is to use the criterion λ_{dr} as shown in Equation 1. This describes the power available to the front face of the ramp. The energy in shorter wave periods is concentrated closer to the surface, and therefore the device will capture proportionately more of their energy. This behaviour has been observed on the prototype device, analysis of the measured data shows less scatter.

This form of the average overtopping flow equation has produced new power production curves for Wave Dragon. These new curves have not led to significant changes in predicted performance in the open-sea conditions. Additionally it gives better accuracy for situations with differing wave steepness. The new formulation is being confirmed by further tests of a wider set of sea-state variables in the wave basin at Aalborg University.

Distribution of overtopping flow

The performance of the device is sensitive to the distribution of the overtopping rate. The more variable the overtopping flow into the reservoir, the larger the capacity of the reservoir and turbines must be to achieve the same performance. The author's paper "Measurements of overtopping flow time series on the Wave Dragon, wave energy converter" submitted to the Journal of Renewable Energy presents a study of the distribution based on measurements at the Nissum Bredning prototype Wave Dragon.

Several studies of the distribution, for high-crested structures, are summarised by Van de Meer and Janssen (1994), where basic formulae for the distribution are presented. It is technically difficult to perform such a study as the overtopping must be measured very accurately. Kofoed (2002) presents the only results for a low crested structure, examining overtopping of a two dimensional model in laboratory scale. This provided confirmation of the theoretical distribution, but only down to a time resolution of 10 mean wave periods.

In this paper, overtopping flow into the Wave Dragon prototype's reservoir has been measured during a storm build-up on October 26th 2006. Three pressure transducers within the reservoir measured water level, while compensating for the flow passing through the turbines and filtering out noise caused by cross waves inside the reservoir. To prevent spill the reservoir was kept as empty as possible. This allowed measurement of the overtopping rate in time resolution accurately at five mean wave periods.

Figure 7 is reproduced from the author's paper. It shows the normalised time series of the overtopping flow, separated into blocks the length of five mean wave periods. By normalising the flow by the mean flow (here denoted Q_M) and the time by the mean wave period T_M it is easier to compare different records. The variability of the overtopping flow can be clearly seen and by comparing to Figure 2 the power

smoothing of the reservoir can be appreciated. Further analysis must be performed on this signal in order to validate the theoretical distribution.

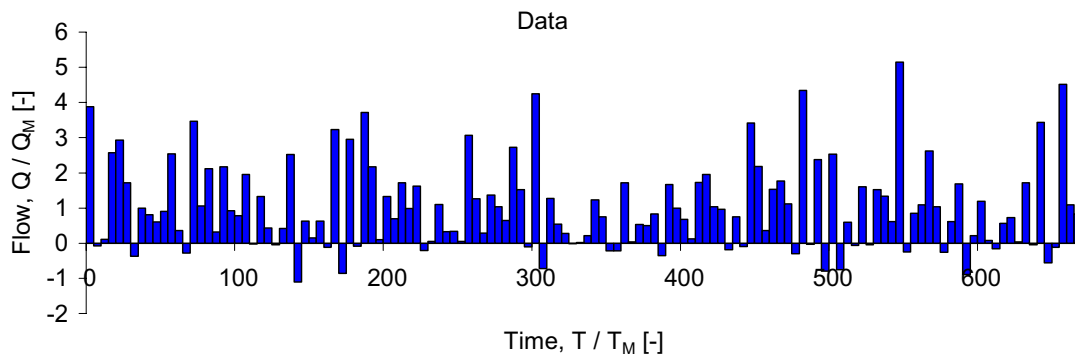

Figure 7, Overtopping time series for a half hour record, both time and flow have been normalised, from Tedd and Kofoed, 2007.

For each of the half hour records examined a overtopping time series was simulated from the theoretical distribution with the same sea state parameters and platform floating level as the measured record. These simulated time series were treated identically in order to be compared to the measured overtopping simulation. Figure 8, reproduced from the paper, shows the comparison for the probability distribution assumed by the theory. A parameter defining the distribution spread in the theory ‘c’ is being checked in this case at two values 1.21 and 1.62. The comparison shows that the measured results provide evidence to confirm the overtopping distribution. However the accuracy of the results was not good enough to fine tune the theoretical distribution.

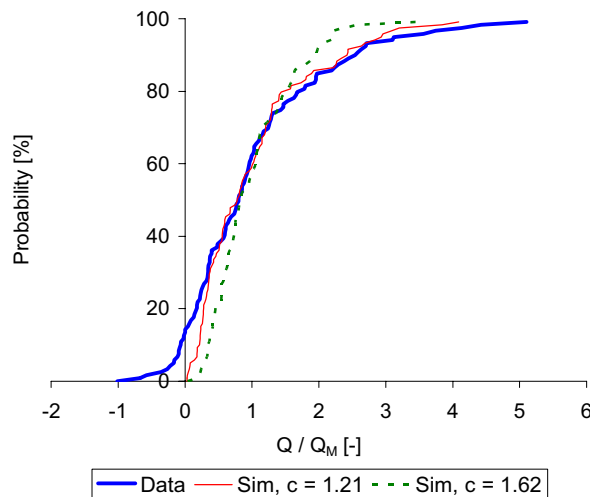

Figure 8, Overtopping distribution comparison of measured data to simulated flows, from Tedd and Kofoed, 2007.

Another assumption used in generating the overtopping flow in the simulation is the independence of overtopping events. There are many practical reasons why this may not be the case, such as wave grouping and submergence of the platform, so it was felt important to investigate the assumption. The autocorrelation of the overtopping signal was calculated to examine this. A small tendency towards anti-correlation was noted. However the conclusion was made to recommend assuming no correlation between overtopping events as this is the conservative approach.

Wave prediction

Performance of almost all wave energy converters can be improved with prediction of the incoming waves. The cost to implement would be low as the control hardware is typically in place, only the measuring system and improved control techniques need be developed.

The paper “Short term wave forecasting, using digital filters, for improved control of Wave Energy Converters” was presented by the author at the 2007 conference of the International Society of Offshore and Polar Engineering in Lisbon. The paper presents a practical method for converting a measurement into a prediction in a generic way. An example illustrates prediction of the surface elevation at the ramp of the prototype Wave Dragon from measurements at a sub-surface pressure transducer several wavelengths ahead of the device.

To explain the concept behind the device a simple example can be used. If a measurement some wavelengths ahead of the wave energy converter shows large waves passing, then at a given time later this energy will be incident on the device. The control of the device can then be altered quickly to extract this larger energy, e.g. by increasing hydraulic resistance to an oscillator’s motion allowing more energy to be captured within the stroke length, or by draining the reservoir of an overtopping device to allow for a large overtopping volume.

The challenges are threefold; to implement a system for measuring the waves approaching the ramp, to accurately transform this into usable input for the control systems, and to construct new control strategies to make the best use of this. The author’s paper addresses the second of these challenges.

The standard approach (Forsberg 1985, Morris et al. 1992) for performing such deterministic sea-state prediction involves discrete frequency domain techniques. This is computationally intensive, as the two Fourier transforms must be made to convert from the time domain to the frequency domain and return to the time domain. The method demonstrated in the author’s paper constructs a digital filter from the Gain and Phase functions, and thus can be performed solely in the time domain. The mathematical equivalence of the two methods is shown in Figure 9. Less processing in real time is a great advantage as a programmable logic controller (PLC) computer is likely to be used; these are typically not very fast.

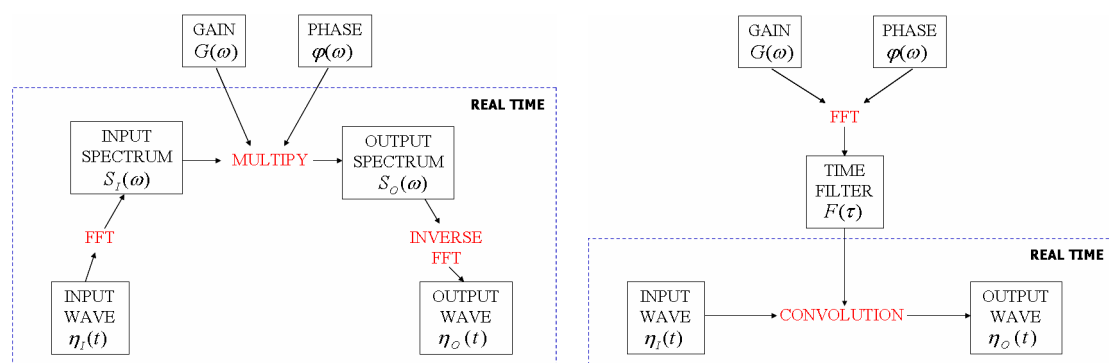

Figure 9, Comparison of filtering in the frequency and time domain.

Multi-frequency dispersive wave states are non-causal as shown by Falnes, 2002. It is shown that a transformation (e.g. surface elevation to pressure at a depth) cannot be performed accurately in real time due to approaching waves having an uncounted effect. In the situation as described, the waves are measured at least a couple of wavelengths ahead of the device. Therefore the non-causality is minimal, due only to very low frequency waves, where there is almost no energy. The system may therefore be well approximated as causal.

Wave flume prediction test

While implementing a predictive algorithms for another device developer, the author constructed the following test of the method using data measured at the wave flume of the Hydraulics and Maritime Research Centre (HMRC), at University College, Cork (during a WaveTrain course the author attended). The results provide input to a simulation programme for the submerged point absorber wave energy device in order to improve control strategies. The laboratory set up is shown in Figure 10, with two capacitive wave gauges in a wave flume. The paddle generated a wave series following a Pierson-Moskovitz spectrum with wave height H_s of 83 mm and peak period T_p of 1.44 s. To simulate a realistic production sea-state results have been scaled by a factor 64 according to Froude scaling for surface waves.

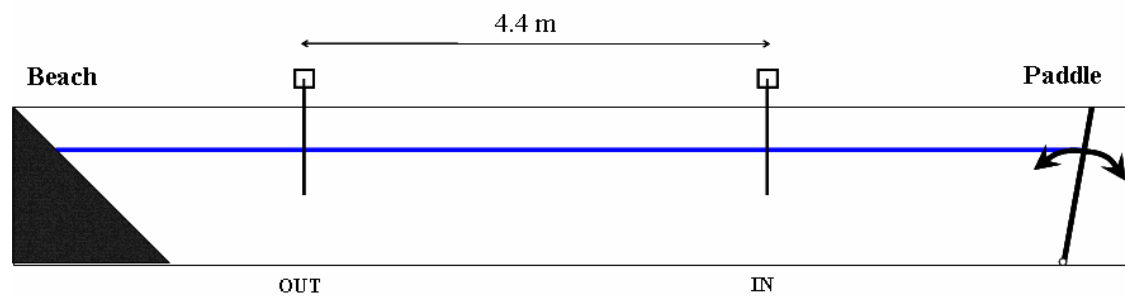

Figure 10, Laboratory set up in HMRC, Cork. The wave gauge separation is approximately 1.5 typical wavelengths.

The filter aims to predict the waves at the “OUT” gauge, based on the record at the “IN” gauge. In order to test many parameters combinations efficiently and to check the filter is valid over the wave frequencies, the author designed the programme shown in Figure 11. To the left the parameters are shown which define the filter. The upper graph shows the filter gain, the discrete target points, the theoretical values and the actual performance of the filter. The middle graph shows the same values for the filter phase. The lower graph shows the digital filter components, which are used for transforming the signal between the two wave gauges.

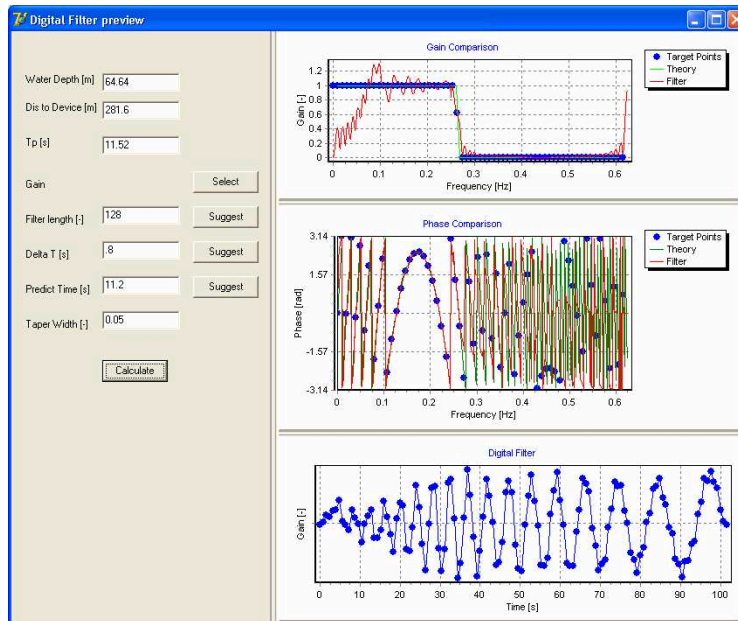

Figure 11, Programme to create and test a digital filter given parameter input.

To control the point absorber device prediction of the future 1/2 wavelength is required. A prediction time of 11.2 seconds, as compared to a scaled peak period of 11.52 seconds, is selected. Figure 12 shows the performance of the filter in predicting the waves. The performance is good for the phase of the peaks, however the magnitude is less accurate. Errors are also present caused by reflections and cross waves in the flume. This is akin to the problem in an open sea with multidirectional waves, which would require more wave measuring points to know wave direction.

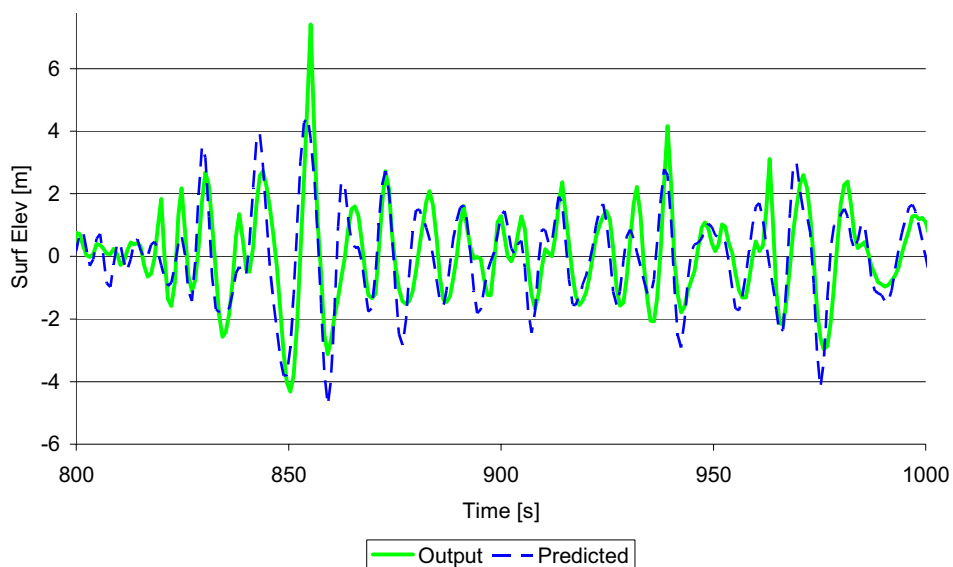

Figure 12, Prediction performance in the test at HMRC, prediction of 11.2 seconds.

Application of prediction

The useful improvement to the performance of the device has been estimated for the Wave Dragon at around 10% (Tedd et al. 2005). For a submerged heaving buoy studies by Valerio et al. 2007 show a potential increase of from around 50 % up to 500 %. These approximations will depend on the accuracy of the predicted signal.

Ongoing and future research

The next stage for the Wave Dragon device is to build and deploy a 7 MW pre-commercial demonstrator in the waters off Pembrokeshire Wales, scheduled for August, 2008. This will be the most powerful wave energy scheme in the world, producing enough electricity for 2,600 homes. The Environmental Statement (WD, 2007) published in April, 2007 provides a great detail of information on the project.

The multi-MW project is part funded by a European research project, with a consortium similar to the Nissum Bredning Prototype. Aalborg University have the responsibility for the instrumentation of the device. By integrating this into the design at an early stage good data should result. This data will be analysed similarly to that from the prototype, considering optimisation of the control systems, force measurements and further analysis of the overtopping flows.

Many device developers are contemplating including predictive techniques within their control systems. Several have approached the author to work collaboratively on the practicalities of this.

Standardisation within the wave energy industry is developing. The author is a member of the UK's Department of Trade and Industry funded Wave Standard Working Group, which aims to make standards performance monitoring. Representing the developer with the longest testing period offshore, the content of this thesis is sure to have a major impact on this report.

Conclusions

This research presented in this thesis has advanced the development of the Wave Dragon device, while also contributing to the stated objectives of furthering research in the wave energy field.

The comprehensive presentation of the development process of the Wave Dragon device, up to the prototype testing in Nissum Bredning, provides a clear history useful to both the Wave Dragon team and to other developers. For the Wave Dragon development team it can act as a first information point on the device, providing easy access to all development conducted by the partners. This will be valuable in the near future as the project team must grow to meet the increased challenges ahead. For other researchers and developers in the wave energy field this shows a successful development process, while allowing reflection on the strengths and weaknesses so that the best aspects may be followed.

The power production figures shown for the Wave Dragon in this thesis are of great interest. These are amongst the fewer than a handful of power production results published from sea testing of all wave devices to date. This openness shows future developers the best practice to use in publishing their results. For the Wave Dragon project team, the results provide two crucial functions. Firstly they show how the device worked, enabling the structure, control and turbine layout to be optimised. Secondly, and most importantly, these results confirm that the Wave Dragon produces as was expected.

This thesis contains two direct advancements in wave energy research. Analysis of the overtopping flow, taken from measurements on the prototype Wave Dragon, is of interest to all developers of overtopping wave energy converters. It gives greater confidence in the simulation programmes which are currently in use. The wave forecasting method, using digital filters, provides a practical solution to the challenge of prediction of the next wave or waves. This enables developers to improve their device control, and provides control engineering a practical expectation of the accuracy of the forecasting process.

The author has learnt a great deal during this study, and must thank all his co-workers from Aalborg University, the Wave Dragon project team and the WaveTrain Network. The topics covered are very broad, from wave dynamics, to business development, from environmental impacts to turbine hydro-dynamics. The most notable of these are: the practice and the limitation of instrumentation, in the laboratory, the prototype and for the sea state; also the challenges and opportunities afforded when managing a small technology development company, currently with a limited budget, although with a enormous potential market. The author feels this exactly completes the aim of the WaveTrain network, to train new graduates in this field.

During the thesis research period the Wave Dragon project has developed from running a prototype test device to detailed planning for a full scale power plant. The author's research has aided this process, and he hopes to continue to work on the development until the seas are full of Wave Dragons.

Ocean Wave Energy

Chapter 7, Device Experience: Wave Dragon

Chapter 7 of Ocean Wave Energy, edited by Joao Cruz

**Accepted by the editor,
To be published by Springer, Germany
(020207)**

ISBN: 978-3-540-74894-6

**7.1. WD Technology: Tedd J., Friis-Madsen E.,
Kofoed J. P. and Knapp W.**

**7.2. Operational Experience: Tedd J., Kofoed J. P.,
Friis-Madsen E. and Christensen L.**

**7.3. Test Centres, Pilot Zones and European Co-
operation: Tedd J. Sørensen H. C. and Russell I.**

Thesis author's contribution

The thesis author is the main author of the sections re-produced here. He has brought together all the information on the Wave Dragon device for the purposes of this chapter of the book. As each section has drawn on the experiences of the project team, and their publications they are acknowledged as co-authors.

Wave Dragon

7.1. Technology

Introduction

Wave Dragon is one of the foremost technologies within the field of Wave Power. Unlike most other devices it doesn't oscillate with the waves, it gathers the wave energy passively by utilising the overtopping principle. The front face of the device is a curved ramp, oncoming waves surge up it, as if it were a beach. Behind the crest of this ramp lies a reservoir which gathers the water "overtopping" the ramp which now has higher potential energy than the surrounding water. The effect of Wave Dragon is amplified by long reflector wings. Mounted to the reservoir, they channel the waves towards the ramp. The energy is extracted as the water drains back to the sea through low head hydro turbines within the reservoir.

The Wave Dragon is designed as a floating offshore device to be placed in water depths above 20 m. These areas are where the greatest wave energy is, and also where it is easiest to gain the permission to deploy. Over 3 years of sea testing have been conducted on a prototype in Northern Denmark



Fig. 1: The Wave Dragon prototype in Northern Denmark. The reservoir and ramp are situated in the middle, with the reflectors concentrating the waves towards the ramp.

This section will introduce the technology and the history of the Wave Dragon. A short introduction to overtopping theory is presented. The rationale behind the design is considered in detail for the wave reflecting wings, the low head hydro turbines and the control strategies of the Wave Dragon.

In section 7.2 the prototype device is described fully. Section 7.3 will present Wave Dragon's work in conjunction with test centres, Pilot zones and European Co-operation.

A floating overtopping device

The Wave Dragon is built on the concept: Use proven technologies when going offshore. It consists of three main elements:

- Two patented wave reflectors focusing the waves towards the ramp, linked to the main structure. These wave reflectors have the verified effect of increasing the wave height substantially and thereby increasing energy capture.
- The main structure consisting of a patented double curved ramp and a water storage reservoir built in concrete. This is very comparable to concrete boats, many of which were built (due to lack of expensive steel) during the first world war and are still floating to this day
- A set of low head propeller turbines for converting the hydraulic head in the reservoir into electricity. These are similar to turbines which have been used in low head river hydro plants for generations.

The challenge is to put these sub-systems together to work in this novel method and survive in the extreme environment present in offshore conditions.

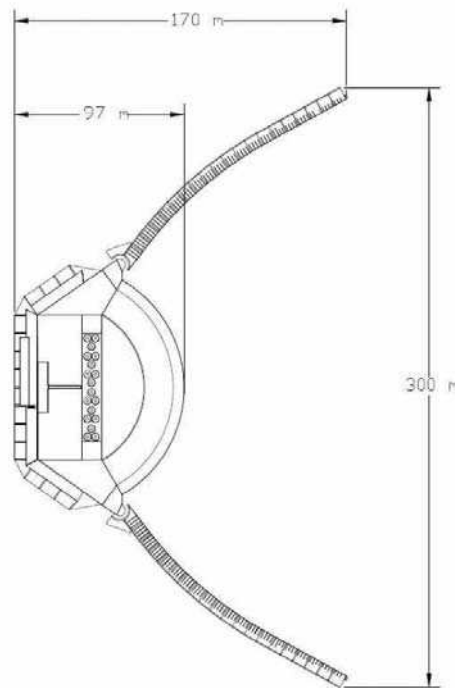

Fig. 2: Top view of the 7 MW Wave Dragon

Wave Dragon is by far the largest envisaged wave energy converter today. Each unit will have a rated power of 4-11 MW or more depending on how energetic the wave climate is at the deployment site. This will be on a device with a displacement of approximately 30,000 tonnes and dimensions as shown in Fig. 2 above.

This size brings many advantages. The device will respond minimally to waves, reducing fatigue problems. Also as it is large and stable it will be possible to work on board the device, which will dramatically reduce maintenance costs and downtime. As an overtopping device there are also many advantages to robustness of the design, in particular there are no end-stop problems as in larger seas the waves will wash over the platform harmlessly.

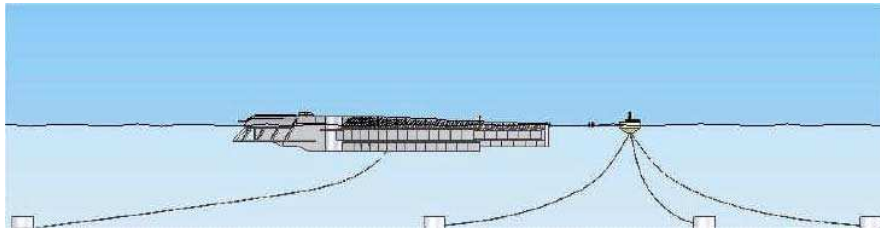

Fig. 3: This figure shows the CALM mooring system envisaged to be used on the demonstrator unit.

The front mooring of the device will be a Catenary Anchored Leg Mooring (CALM) buoy, with a single rear mooring to restrain the device to a given rotation about the front mooring. The choice of anchor will depend on the sea bed. For the demonstrator unit concrete buckets filled with ballast rocks will be used as gravity anchors.

History of the Wave Dragon

The inventor, Erik Friis-Madsen, initiated the development of the Wave Dragon in 1986. In the early years he developed the principle of the Wave Dragon, and in 1994 an application for patent was submitted. Both Danish and European patents for the Wave Dragon have been obtained since then.

During the period 1995 - 1999 a number of studies of structural layout, overtopping of a fixed model, reflector efficiency, financial aspects, geometry, optimal choice of turbine configuration, and movements of the Wave Dragon were carried out. The findings are described fully in the report EMU et al, 2000 and Kofoed et al 2000. Using the findings of these studies, the Wave Dragon design was slightly modified and the first test programme formulated.

The first test programme, financed by the Danish Wave Energy Program, consisted of thorough laboratory investigations of movements of the floating structure, mooring forces, forces in the reflectors, overtopping/amount of captured energy and survival in extreme wave conditions. These tests were carried out at the Hydraulics and Coastal Engineering Laboratory, Aalborg University, 1998-1999, using a floating 1:50 scale model of the Wave Dragon built by the Danish Maritime Institute, see Fig 4.

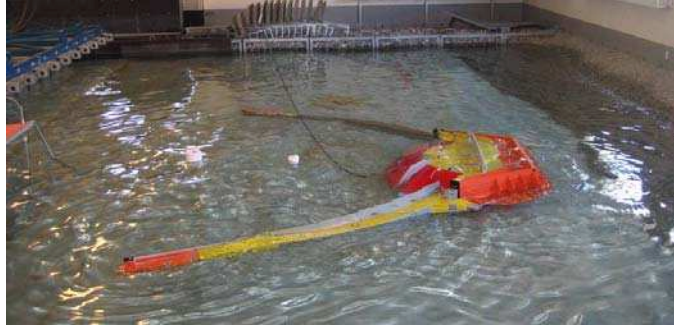

Fig. 4: Testing of 1:50 scale Wave Dragon in Aalborg University wave basin.

As a continuation of the work performed under the Danish Wave Energy Program and on the basis of the research feasibility study, from 2000 to 2002 the EU granted funding for the project “Low-pressure Turbine and Control Equipment for Wave Energy Converters” under the Non-Nuclear Energy RTD Program. The total budget for this project was €1 million of which the EU funds contributed 50%.

The objective of this project was to optimise the hydraulic performance, structural design, design of configuration, control and regulation of the turbines and design of electrical component and connection to grid. The laboratory model was modified, and tested at Aalborg University and at the facilities in University College Cork-HMRC (Ireland). The modifications showed significant improvements to energy capture and hydraulic behaviour. In parallel the configuration and regulation of the turbines was designed by the following companies: Ossberger Turbinenfabrik (Germany) / Kössler GmbH (Austria), Hälleryd Turbiner AB (Sweden) and Veteran Kraft (Sweden) together with turbine tests and computer simulations conducted at the Technical University Munich (Germany). The structure was designed by the inventor Erik Friis-Madsen and adjusted to shipbuilding standards by Armstrong Technology (UK). Electrical components and connection to grid was designed by Balslev (Denmark), Belt Electric (Denmark) and Elsamprojekt / Eltra (Denmark).

After these successful tests, the next stage for Wave Dragon was to build, deploy and operate a field prototype. Funding from the Danish Energy Authority and European Commission led to deployment of this prototype in April 2003 in The Nissum Bredning (Broads), an inland sea, connected to the Danish North Sea (see section 7.3 for complete details). Testing has been ongoing since then on the many aspects of the device, from control systems and hydraulic performance to behaviour in extreme sea states (during a 100 year storm) to effects on bird life to sub-sea acoustic behaviour and more. As the world’s first grid-connected floating WEC this Wave Dragon has been providing power to the grid of Northern Denmark consistently. Chapter 7.2 gives the full details of this deployment, including results and operational experiences learnt. Progress was reported in the conference papers of Sørensen et al, 2003 and 2005.

The current focus for the Wave Dragon technology is to build and deploy a multi MW unit. A European Commission project was begun in May 2006 to im-

plement the design for this commercial size. Off the coast of Pembrokeshire in South West Wales much work is ongoing to gain the relevant permissions to deploy a unit there. This is mainly focused on the Environmental Impact Assessment (EIA), studying the flora, fauna, geology, shipping and other aspects.

After the first successful deployment of a Wave Dragon unit there are several projects in the pipeline to construct farms of Wave Dragons in a variety of countries.

EMU et al (2000): Publishable Final Report – Low Pressure Hydro Turbines and Control Equipment for Wave Energy Converters (Wave Dragon), Contract JOR3-CT98-7027, Copenhagen, , Denmark.

Kofoed, JP, Frigaard, P, Soerensen, HC and Friis-Madsen, E (2000). Development of the Wave Energy Converter – Wave Dragon. Proceedings of the 10th ISOPE conference, vol. 1, No 10, pp 405-412

Sørensen, H.C. et. al. (2003). Development of the Wave Dragon from scale 1:50 to prototype, Proceedings of the 5th European Wave Energy Conference, Cork, Ireland.

Sørensen, H.C. et. al.(2005). The Results of Two Years Testing in Real Sea of Wave Dragon, proceedings of the 6th European Wave and Tidal Energy Conference, Glasgow, September.

Overtopping theory

The theory for modelling overtopping devices varies greatly from the traditional linear systems approach used by most other WECs. A linear systems approach may be used with overtopping devices. This considers the water oscillating up and down the ramp as the excited body, and the crest of the ramp as a highly non-linear power take off system. However due to the non-linearities it is too computationally demanding to model usefully. Therefore a more physical approach is taken. The time series of the overtopping flow is modelled, thus relying heavily upon empirical data.

Fig 5 shows the schematic of flows for the Wave Dragon. Depending on the current wave state (H_s, T_p) and the crest freeboard R_c (height of the ramp crest above mean water level, MWL) of the device, water will overtop into the reservoir $Q_{\text{overtopping}}$. The power gathered by the reservoir is a product of this overtopping flow, the crest freeboard and gravity. If the reservoir is over filled when a large volume is deposited in the basin there will be loss from it Q_{spill} . To minimise this, the reservoir level h must be kept below its maximum level h_R . The useful hydraulic power converted by the turbines is the product of turbine flow Q_{turbines} , the head across them, water density and gravity.

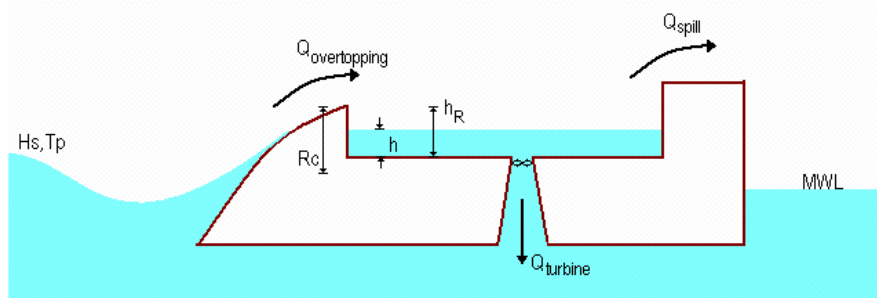

Fig. 5: Schematic of flows on the Wave Dragon.

Within the field of coastal engineering there is a considerable body of work looking at the overtopping rates on rubble-mound breakwaters, sea walls and dykes. The studies of Van der Meer and Janssen (1994) provided the basis of the theory on the average expected overtopping rate. Gerloni et al (1995) investigated the time distribution of the flow. However this work was focused on structures designed to minimise the rate of overtopping, counter to the aims of the Wave Dragon. Kofoed (2002) performed laboratory tests on many permutations of ramp angles, profiles, crest freeboard levels in a variety of sea states, all with heavy overtopping rates. These studies showed the Wave Dragon's patented double curved ramp to be highly efficient at converting incident wave power.

When comparing results between different scales of model testing it is very useful to use Non-Dimensional units to describe the variables. Results from the model scale can then simply be used for any size of device. In coastal engineering the average flow \bar{Q} is converted into non dimensional form by dividing by the breadth of the device b , gravity g and the significant wave height H_s :

$$Q_{ND} = \frac{\bar{Q}}{b\sqrt{gH_s^3}} \quad (X)$$

In the case of the floating Wave Dragon it has been seen that there is a dependency on the wave period. The dominant physical explanation for this is the effect of energy passing beneath the draft of the structure. Fig 6 shows a typical distribution of wave energy in the water column, with the left side showing the portion influenced by the ramp of Wave Dragon and therefore available to be exploited.

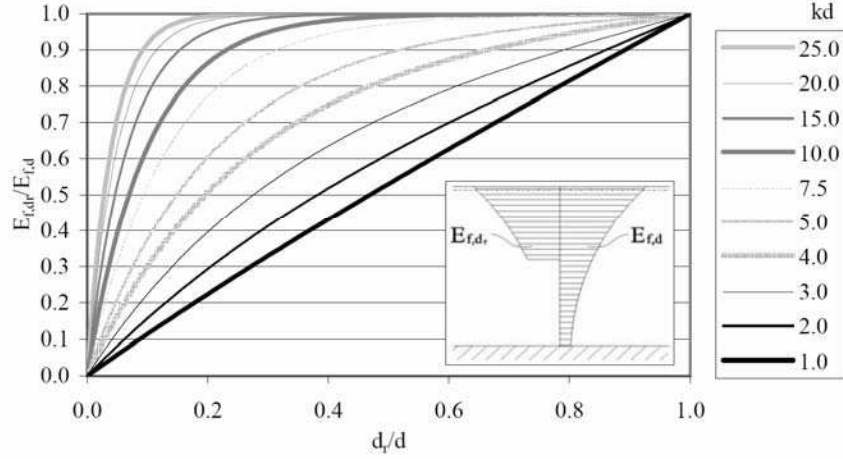

Fig. 6.: Vertical distribution of energy in water column, corresponding to equation 3, from Kofoed 2002.

Shorter period waves have their energy concentrated in the upper part of the water column so Wave Dragon will absorb proportionately more energy from these. For Wave Dragon the following non-dimensional form has been used to include this period effect.

$$Q_N = \frac{1}{\lambda_{d_r}} \frac{\bar{Q}}{b\sqrt{gH_S^3}} \quad (\text{X})$$

This uses the coefficient λ_{d_r} , the ratio of energy between free surface and device draft $E_{f,dr}$ to incident wave energy $E_{f,d}$. This is based on linear wave theory and defined as following equation:

$$\lambda_{d_r} = 1 - \frac{\sinh(2k_p d(1 - \frac{d_r}{d})) + 2k_p d(1 - \frac{d_r}{d})}{\sinh(2k_p d) + 2k_p d} \quad (\text{Y})$$

Where k_p is the wave number at peak period, d is the water depth and d_r is the draft of the device.

To analyse the overtopping flow performance the Non-Dimensional overtopping rate is compared to the relative crest freeboard R , as shown in Equation z. This allows scale test results to be scaled to a full sized device:

$$R = \frac{R_c}{H_S} \quad (\text{Z})$$

Time variation of the overtopping flow is also very important for modelling the power produced by the Wave Dragon. To make the model overtopping events are assumed to be random and independent, with a Weibull distribution. This has

been confirmed by comparisons with data from a prototype Wave Dragon (Section 7.2).

With this good understanding of the overtopping flows a simulation programme was designed and has been extensively used to optimise and model the Wave Dragon behaviour. This programme provides as an input a randomly generated time history of waves overtopping the ramp according to the mean rate and distribution shown above. This allows modification of many attributes (such as: reservoir depth and area, crest freeboard height, turbine number and type and turbine operational strategy) in order to pick the configuration which will produce the most electricity for each sea condition present at a location.

Franco, L, de Gerloni, M, Van der Meer, JW (1995). Wave Overtopping on Vertical and Composite Breakwaters. Proc. 24th Int. Conf. Coastal Eng., Kobe, Japan 1, 1030-1044.

Kofoed JP (2002) Wave Overtopping of Marine Structures – Utilization of Wave Energy, PhD thesis, Aalborg University

Van der Meer, JW, and Janssen, JPFM (1994). Wave Run-up and Wave Overtopping at Dikes. In: Kobayashi N and Demirebilek Z, (eds) Wave Forces on inclined and vertical wall structures, pp 1-27, ASCE. Also Delft hydraulics, Publ. No 487.

Wave Reflector Wings

One of the most distinctive aspects of the Wave Dragon are the long slender wings mounted to the front corners of the reservoir platform. These are designed to reflect the oncoming waves towards the ramp. A wider section of wave is available to be exploited with only a moderate increase in capital cost. The overtopping volume in a wave is very dependent on the wave height, therefore by providing only a moderate increase in height, much more energy can overtop the ramp.

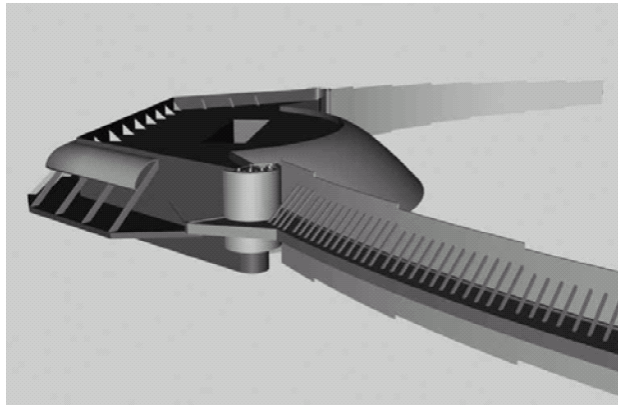

Fig. 7: Computer image of Wave Dragon. This shows the double curved ramp facing waves approaching from the right. The reservoir is behind and would have the turbines placed roughly in the centre. The slender wave reflectors are shown, with a flat side facing the waves, and stiffeners on their rear side.

In order to choose the correct lengths, angles, and position of these wings Kramer and Frigaard (2002) did extensive computer modelling of many combinations of these. The computer modelling used a 3D boundary element method. The meshing requirement is reduced to the structure's boundary surface, so as a result it provides a fast, efficient and accurate frequency domain solution for linear wave structure interaction problems. The method modelled the wings in isolation. The energy flux through the central gap (where the ramp and reservoir would be) gave a performance coefficient for each setup. A smaller selection of sea-states and configurations was tested in a similar manner in a wave basin. Here again the wings were fixed, the platform removed and wave probes measured the waves passing through the central gap. A very good correlation was found between the two methods.

Reflectors which are floating and have finite draft, will reflect higher frequency waves better than lower frequency. Typically these waves are also the smaller waves. Therefore increasing their input is very advantageous, improving the bandwidth of the device. The results show an increase in energy approaching the ramp of 85 % in these smaller operational wave states. When averaged over the sea states expected within the Danish part of the North Sea during one year, this translates to an increase in power of around 40%.

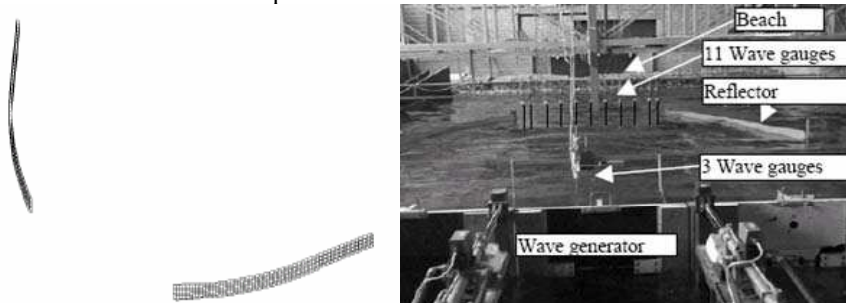

Fig. 8, Computer mesh of the reflector wings and laboratory set up

Secondary bonuses of the presence of the wave reflector wings include: better weather-vaning performance to face the waves, lower peak mooring forces, and improved horizontal stability of the main platform.

As the aft and rear mooring attachment points are separated further, the yaw of the platform is more stable. Therefore the device will not turn away from the predominant wave direction, and will also realign itself faster as when the wave direction changes.

The peak mooring force is decreased as there is an internalisation of the wave loading forces within the structure. As the length of the device is comparable to the length of the waves, at some instants the wave force will push the platform, while pulling the wings or vice versa. Therefore the net peak force on the mooring links will be lower. This does however demand careful consideration for the design of this joint to resist these forces. Initial work and prototype work has concentrated on strain gauges mounted in the shoulder. Corona and Kofoed (2006) were able to show this internalisation of forces in practice by analysing the fre-

quency spectrum of the strains close to the joint. Two force peaks were evident, one corresponding to wave frequencies and a secondary lower frequency peak at the slow surge frequency of the device.

Lastly the reflectors wings act as stabilisers to the device. As they float under their own buoyancy they counteract any list of the platform. This is important as the more horizontal the platform is kept the less water is spilt and so the more efficient the device operation.

Corona L and Kofoed JP (2006). Wave induced stresses measured at the Wave Dragon Nissum Bredning Prototype. Co-ordinated Action on Ocean Energy, 3rd Workshop proceedings, Amsterdam

Kramer M and Frigaard P (2002). Efficient Wave Energy Amplification with Wave Reflectors. Proceedings of the 9th ISOPE conference.

Low Head Turbines and Power Train

Water turbines which are suitable for this purpose have been used in low head river water power plants for many decades and have been developed to a high level of efficiency and reliability. In France the 240 MW La Rance tidal power station has used such turbines in a salt water environment since 1967. Thus, in contrast to most of the other WEC principles, a proven and mature technology can be used for the production of electrical energy.

Turbine operating conditions in a WEC are quite different from the ones in a normal hydro power plant. In the Wave Dragon, the turbine head range is typically between 1.0 and 4.0 m, which is on the lower bounds of existing water turbine experience. While there are only slow and relatively small variations of flow and head in a river hydro power plant, the strong stochastic variations of the wave overtopping call for a radically different mode of operation in the Wave Dragon. The head, being a function of the significant wave height, is varying in a range as large as 1:4, and it has been shown by Knapp, 2005 that the discharge has to be regulated within time intervals as short as ten seconds in order to achieve a good efficiency of the energy exploitation.

From a river hydro power installation which is properly maintained, a service life of 40 – 80 years can be expected. On an unmanned offshore device, the environmental conditions are much rougher, and routine maintenance work is much more difficult to perform. Special criteria for the choice and construction of water turbines for the Wave Dragon have to be followed, it is advisable to aim for constructional simplicity rather than maximum peak efficiency.

Fig. 9. shows the application ranges of the known turbine types in a graph of head H vs. rotational speed n_q . The specific speed n_q is a turbine parameter characterising the relative speed of a turbine, thus giving an indication of the turbines power density. Evidently, all turbine types except the Pelton and the cross flow type are to be found in a relatively narrow band running diagonally across the graph. Transgressing the left or lower border means that the turbine will run too slowly, thus being unnecessarily large and expensive. The right or upper border is defined by technological limits, namely material strength and the danger of cavita-

tion erosion. The Pelton and the cross-flow turbine do not quite follow these rules, as they have a runner which is running in air and is only partially loaded with a free jet of water. Thus, they have a lower specific speed and lower power density. Despite its simplicity and robustness, the cross flow turbine is not very suitable for wave power applications:

- Its operating principle entails a 'lost head' in the order of one runner diameter. This leads to a very low efficiency at very low heads.
- Due to the typically very narrow blade passages this turbine cannot cope very well with debris like seaweed and fishing net parts.
- Due to its low specific speed, the turbine itself is rather bulky, and it needs a gearbox to drive the generator.

This type of turbine has thus not been further evaluated.

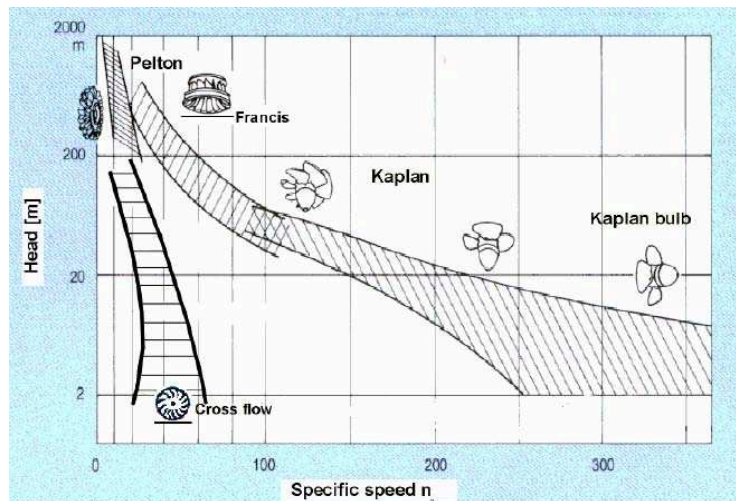

Fig. 9: Head range of the common turbine types, Voith and Ossberger.

The Kaplan type is the only turbine suitable for the head range in question. The shape of a turbine's guide vanes and runner blades is designed to give an optimal energy conversion in its design point, which is defined by optimum values of head and flow (H_{opt} and Q_{opt}) at a given speed. For every other operating point, there will be a discrepancy between the flow angles and the blade angles, decreasing the efficiency of the turbine. Whenever a turbine is required to operate in a relatively wide head and flow range it is important that the efficiency curve is flat and widely spread. This criterion is best fulfilled by the double regulated Kaplan type.

In this type of turbine, both the guide vanes and the runner blades are adjustable, thus making the turbine very adaptable to varying operating conditions. This is only achieved by a relatively complex construction which implies an oil-filled runner hub with a number of critical bearings and oil seals and a great number of joints and bearings in the guide vane operating mechanism. This is not only reflected in higher manufacturing costs, but also in a higher demand for maintenance.

nance, especially when the turbine is operated in an aggressive environment i.e. saltwater with possible silt contents. For these reasons single regulated variants of the Kaplan turbine have been conceived, namely the Propeller type with fixed runner blades, the Semi-Kaplan type with fixed guide vanes and the unregulated on/off turbine with fixed runner blades and fixed guide vanes. These turbines are simpler in construction, but they have a narrower efficiency curve, see fig 10.

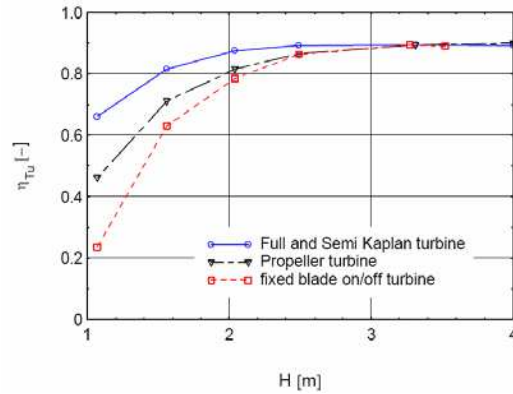

Fig. 10: Efficiency vs. Head for variants of the Kaplan turbine,

With a projected plant is of a larger size, it should be considered to use a number of smaller turbines instead of a single larger turbine. This has the following advantages:

- By stopping a number of turbines at lower flow rates, the flow rate can be regulated over a wider range without sacrificing efficiency, see fig. 11.
- Single units can be taken out of service for maintenance without stopping production.
- Capacity demanded for hoisting and transport equipment to perform repair and maintenance work, is greatly reduced.
- The smaller turbines have shorter draft tubes, and are thus easier to accommodate in the whole device.
- The smaller turbines have a higher speed, which reduces the cost of the generator.

Depending on the location of a production Wave Dragon it is envisaged that there will be between 16 and 24 turbines mounted.

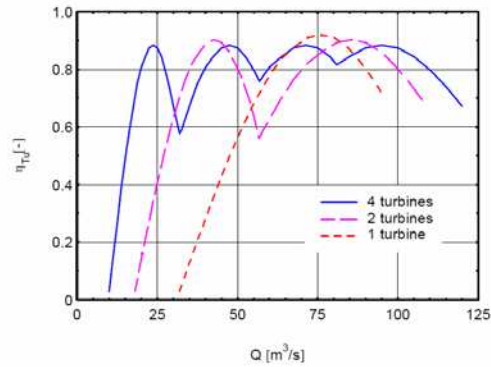

Fig. 11: Turbine efficiency vs. flow rate for a single and a multiple turbine configuration.

In normal hydro power stations, the turbines are operated at constant speed, as they are coupled directly to generators feeding into a fixed frequency grid. However, if the generator is connected to a frequency converter, the turbine can be operated in a relatively wide speed range. This is very advantageous in situations where a large variation in turbine head occurs. By adapting the speed to the actual turbine head, the efficiency of the turbine can be kept almost constant, see fig. 12.

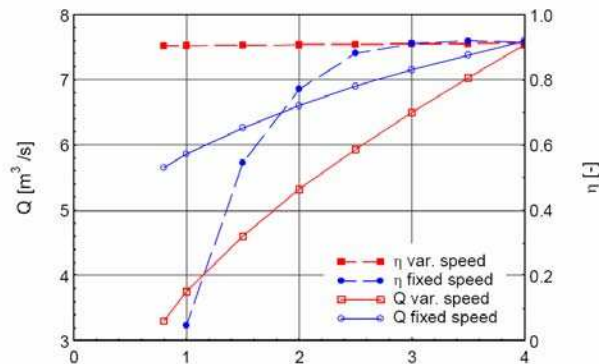

Fig. 12: Turbine efficiency and flow rate vs. head for fixed and variable speed drive

In the development of the Wave Dragon, different turbine regulation strategies have been evaluated by means of simulation software. Maximum overall plant efficiency was obtained when the turbine flow was reduced along with the emptying of the reservoir. The variable speed turbines adapt well to this, naturally reducing flow at the lower head. Therefore by using enough variable speed on/off turbines a good efficiency can be delivered, with smooth power delivery and a high load factor.

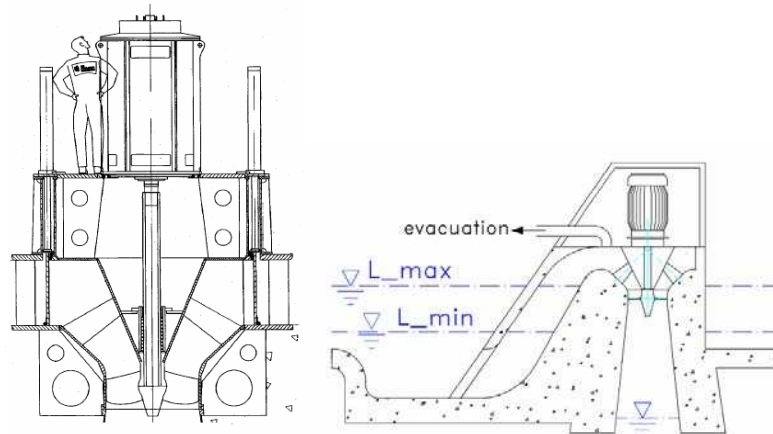

Fig. 13: A full scale Wave Dragon cylinder gate turbine and a Siphon on/off turbine

Two alternative methods for interrupting the flow have been analysed, the first one using a large mechanically operated cylinder gate, the second one using a siphon principle, see fig. 13. The siphon type has no gate, it is stopped by simply admitting air into the top of the inlet duct; the turbine is started again by partly evacuating the air until the flow starts again and takes the rest of the air along with it. The cylinder gate type has the advantage of shorter start-up time and slightly better efficiency. If suitably designed it has been found that it has low maintenance requirements.

Knapp, W. (2005). Water Turbines for Overtopping Wave Energy Converters. Co-ordinated Action on Ocean Energy, 2nd Workshop proceedings, Uppsala

Control of Device

Control is very important. Improved control algorithms are very valuable, as for no extra capital cost or maintenance cost they can improve the performance of a device, effectively free extra energy capture. Therefore this is an area which currently is a major focus of research work being performed. On the basic level, as with several other WECs, Wave Dragon has two control loops. A slow acting control loop is used to tune the device to the current sea state. A much faster acting control strategy is used to extract the maximum energy from wave to wave.

The long period control's main aim is to regulate the floating height of the Wave Dragon to the optimal level for the sea state. This aims to maximise the power flowing over the ramp. A lower floating level will have more flow but at a lower head, and a higher floating level will have lower flow but a higher head – the optimum must be found. The time scale of the sea states increasing is of the order of a few hours, therefore the platform can also change its buoyancy at a similar rate. The input to this control strategy is the current, or future sea state

which can be measured directly in the region of the Wave Dragon, or predicted based on weather forecasts.

The method for controlling the floating level of the platform is by blowing air into, or venting air from, open compartments beneath the reservoir. Due to the free surface of the reservoir this can be compared to balancing a tray full of water. The layout of these compartments and the detailed strategy for filling them is crucial to maintain stability. For example if there is a large central compartment filled with air, and low buoyancy at the edges the device will be quite unstable. In general the more stable the platform is, the closer to full the reservoir can be, and so the more power will be generated.

The fast acting control is to maintain a suitable water level within the reservoir. If the water level is too high, then large waves will not be able to be accommodated in the reservoir so there will be considerable spill from it. However if the water level is lower the head across the turbines is less so less power can be produced from the same water overtopping the ramp. Again an optimal level must be found.

The reservoir level is controlled by the turbines. They are controlled on and off in a cascade fashion using the cylinder gates as explained earlier. At a minimum reservoir set point, the first turbines cut-in. As waves fill the reservoir, the remaining turbines progressively start. At a maximum level all turbines are operational. The input for this can either come from pressure transducers within the reservoir itself giving the level, or from direct measurements of the power generated by the generators, from which the head can be inferred. An area of development here is in the use of predictive algorithms, to control the turbines dependant on the expected overtopping in the next few waves. By lowering the reservoir level when some large waves are expected, spill would be minimised. Also by maintaining a higher reservoir level when smaller waves are expected, less water would be discharged at a lower head. Initial studies have shown that this small work alone could increase performance by 5 to 10 % (see Tedd et al, 2005).

Tedd J., Knapp W., Frigaard P, and Kofoed J. P. (2005) Turbine Control Strategy Including Wave Prediction for Overtopping Wave Energy Converters. Co-ordinated Action on Ocean Energy, 2nd Workshop proceedings, Uppsala

Summary

Wave Dragon is a large floating overtopping type WEC. Its natural broadband behaviour and the use of established components make it one of the leaders in the wave energy field. It is a challenge to operate in the uncompromising environment where wave energy is greatest. Progress has been made in implementing existing technologies in this new manner. More development continues to improve the Wave Dragon device.

Wave Dragon

7.2. Operational Experience

Introduction

Wave Dragon have deployed and run a successful prototype wave energy power plant in Northern Denmark for over 3½ years. The device is located in an inland sea and so is scaled appropriately, while maintaining all automatic control and power take off system and grid connection which will be seen in larger open sea power plants. This section will introduce the device and the Europe-wide consortium who built it. The operational experience gained from running the device will be shared by considering a selection of the subsystems on board. The power production results will be presented showing how the prototype has shown Wave Dragon to achieve an efficiency of 18%, close to the long term goal.

A scale prototype in a 1:4.5 scale sea

Nissum Bredning, a sheltered sea connected to the Danish North Sea was chosen as the site to deploy the first Wave Dragon prototype (see figs. 1 and 2). By deploying in a less energetic site many of the components and subsystems could be tested and developed at a reasonable cost. Also the expense of a site visit was greatly reduced. The available wave energy in the site makes it suitable for a 1:4.5 scale machine, (relative to the North Sea). Therefore the original concrete construction drawings were scaled down and the construction material replaced with steel. This had the added advantage that any small changes to the structure could be made on board.

The main aspects to be tested at this site were those which can not be successfully modelled in the laboratory. Low head hydro turbines controlled by variable speed Permanent Magnet Generators, and the hydraulic response of the platform with its open buoyancy compartments have been tested. In addition to this, control strategies for optimal power production and buoyancy regulation have been focused on. Operating in the harsh offshore environment has taught many additional lessons.



Fig. 1: The platform at the dockside in 2003 before being launched. On the right the open air compartments used for buoyancy regulation can be seen.



Fig. 2: Wave Dragon in Nissum Bredning. Wave Dragon was deployed at two sites in the sea, initially at the Northern site, and then later at the more energetic southern site. Section 7.3 has a map and full description of the Nissum Bredning Test Centre.

The device itself has been very highly instrumented with over 100 sensors. These include: pressure sensors to measure the incoming waves, floating height and water in the reservoir; strain gauges and force transducers to measure the forces in the structure; a wind station; accelerometers and inclinometers to view the positions of the device; electrical sensors within the PTO system and many more. Amongst the most used of these have been the 5 web-cameras mounted on board, allowing 24 hour visual checks of the situation on the platform.

Kofoed JP, Frigaard P, Friis-Madsen E and Sørensen HC. (2006). Prototype testing of the wave energy converter wave dragon. *Renewable Energy* 31, 2006.

Wave Dragon Consortium

An early decision by the Wave Dragon team was to have the majority of work performed by experts in the field. This philosophy has led to a very dynamic company structure with a small core element, and a broad selection of trusted partner companies with years of experience in their own field. This structure is favoured by many public funding bodies, and allowed the Wave Dragon project to qualify

for support from the European Commissions R&D targeted funds. The partner companies provided match funding for their own work and were rewarded with an option of a share in the Wave Dragon core company. With the modern age of telecommunications there was no problem with the wide spread of work across the European continent. The partner companies involved and their respective roles are:

	<p>Wave Dragon ApS is the development company for the wave energy converter technology.</p>
	<p>Löwenmark Consulting Engineers FRI – A small Danish company which is home to the inventor of Wave Dragon Erik Friis-Madsen. This company has worked closely with all the engineering companies in the project to ensure the best possible design for the device. Most work is now performed by the Wave Dragon company</p>
	<p>SPOK ApS – This small Danish company provided the project management for the consortium and developed the Wave Dragon corporate side and initiated further projects. In addition to this work they had the responsibilities for the environmental surveys and Life Cycle Analysis work conducted for the prototype. Most work is now performed by the Wave Dragon company.</p>
	<p>Balslev A/S – As a larger Danish electrical and control engineering company they have worked on the active control of the Wave Dragon. This has involved implementing the control strategies into the Programmable Logic Controller (PLC) and development of the System Control and Data Acquisition (SCADA) user interface for the operation of the Wave Dragon.</p>
	<p>ESBI Engineering Ltd – This large Irish consultancy (once part of the Electricity supply board of Ireland) have had responsibility for the design and monitoring of the grid connection of the Wave Dragon.</p>
	<p>NIRAS AS – As a larger structural engineering consultancy based in Denmark this company has had a broad brief of responsibilities. The core of their work was to define the design criteria for the device and perform some detailed design. In addition they worked with Finite Element Modelling of the internal forces within the structure and prediction of waves from the wind states.</p>

	<p>Promecon A/S – A subsidiary of MT Højgaard this company is one of the largest steel constructors in Scandinavia. They constructed the main structure in Steel and were responsible for the successful deployment of the device.</p>
	<p>Kössler Ges.m.b.H. – This Austrian company has decades of experience in construction of hydro turbines. As a partner in the consortium they brought this experience into play when constructing the turbines used on board the device.</p>
	<p>Aalborg University – As the local University in northern Denmark, and one of two major technical universities in the country, Aalborg University have been core to the Wave Dragon project since the earliest days. The first scale testing was conducted in their laboratories. In this project Aalborg University specialised in monitoring the prototype, with over 100 sensors mounted on board and 5 web-cameras providing round the clock results. This has led to many published research papers on all aspects of the prototype and countless students have been inspired from working on related projects.</p>
	<p>Technical University Munich – The turbine group at this university joined the project with the aim of designing and testing the scaled turbines, and analysing their control strategies in cooperation with Veterankraft AB. As the project developed, they have also been crucial in many more practical matters, mainly with maintenance of the turbines.</p>
	<p>Armstrong Technology Associates – A structural engineering company from the UK. Initially in the consortium to provide naval engineering expertise to convert original concrete 1:1 construction drawings to 1:4.5 scale steel equivalents. Unfortunately after initial design work the company changed direction and withdrew, their responsibilities were taken on primarily by NIRAS AS.</p>

Performance in Storms

Survivability is essential, and Wave Dragon has had this built into all systems from the start. Overtopping devices are naturally adapted to perform well in storm situations, where the wave will pass over and under the device with no potential end-stop problems. However as the Wave Dragon prototype has been deployed for more than three years in an offshore situation it comes as no surprise that the platform has had to survive some severe weather. With the web cameras on board some dramatic moments have been caught, as in figs. 3 and 4.



Fig. 3: View from web camera mounted to control container of large wave surging down reflector wing of Wave Dragon.



Fig. 4: View from web camera mounted to the device's shoulder of waves crashing into turbine area.

The two incidents shown on camera did not cause any damage to the Wave Dragon. Unfortunately this has not always been the case. On one occasion damage was suffered to the main platform and a large fixed buoyancy tank was punctured. This was a reminder of the need for redundancy in the design, here the other fixed buoyancy tanks were sufficient to allow the Wave Dragon to continue operating. Although this was a slightly reduced performance as the automatic buoyancy control was not adept with a non-symmetrically ballasted platform.

During the next calm period the breached tank was emptied, the puncture welded tight, and the tank separated into two smaller units to add extra redundancy.

In 2005 the largest storm for 100 years hit northern Denmark. Average wind speeds were in excess of 110 km/h with gusts above 150 km/h. In addition to widespread structural damage to buildings in the region the storm broke a force transducer mounted in the mooring system of the device. On the prototype the force transducer was selected to give accurate readings of mooring forces in even small waves. It therefore did not have the safety factors of the other sections of the mooring system. Small defects in the steel could be seen at the nucleus of the fracture shown in fig. 5.

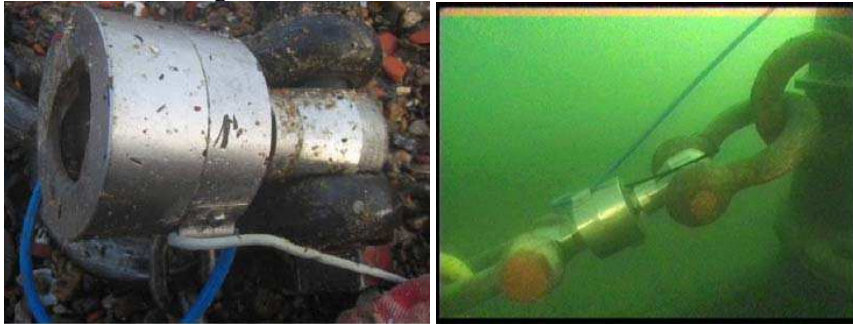

Fig. 5: Fractured force transducer after Force 11 storm and view of transducer in position taken by diver.

After losing the mooring connection the Wave Dragon soon drifted onto a sandy shore, where it suffered little damage. The device was soon refloated and taken to harbour for some scheduled maintenance. Thus Wave Dragon became the first WEC to be successfully recovered and redeployed at sea.

Control of Device

All of the control devices for the Wave Dragon prototype are housed in the white container mounted to the back of the Wave Dragon platform. Clearly this is oversized on the 1:4.5 scale device as any operational humans won't scale. Fig. 6 shows the inside of this container.

The core of the control system is a Programmable Logic Controller (PLC). The PLC controls the blowers and valves to regulate the buoyancy of the device, aiming for a horizontal and stable platform. A series of regulation strategies have been implemented within the PLC with implementing aspects of PID control giving more stable behaviour. The regulation is able to change the floating height of the platform by around 20 cm every hour, allowing the crest freeboard to rise with increasing storms, and thus improve the power capture. The PLC is also responsible for controlling the action of the turbines, in order to extract the maximum energy from the water which has overtopped. The PLC controls a hydraulic pump and solenoid valves to allow the water hydraulic system to operate the turbine cyl-

inder gates or evacuate the siphon. Again several strategies have been tested on board, with much improvement.



Fig. 6: Inside the control room of Wave Dragon, the PLC and Frequency inverters are in the cabinets to the left, in the far corner the piping, valves and blower for the automatic buoyancy can be seen, and to the right are the SCADA and data acquisition PCs in front of windows looking out onto the reservoir.

One of the PC's in the control room is running a System Control and Data Acquisition (SCADA) system allowing the primary human interface with the device. In fig. 7 and fig. 8 some screenshots from the system are shown. In addition to giving the current status of the device the system allows set points to be altered and records historic values for the power production system. In parallel with this a more typical data acquisition system is run recording the measurements not used in the active control of the device, but of interest for scientific and development uses, such as strain gauge readings and wind records.

8 Operational Experience

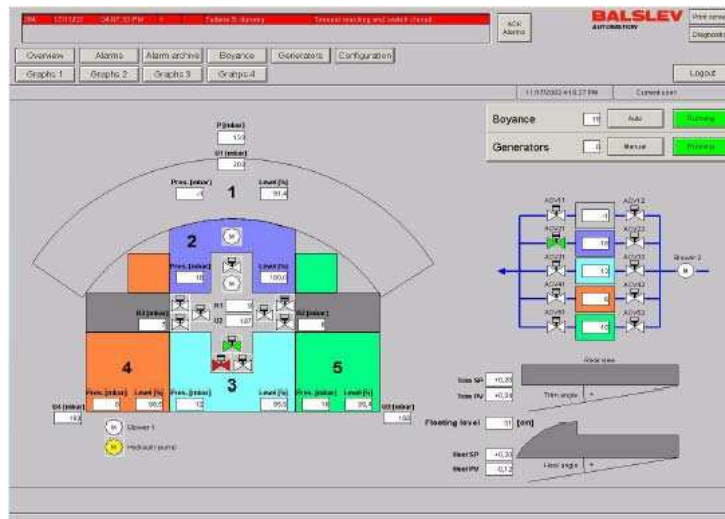

Fig. 7: Front page of the SCADA system showing stability of platform, buoyancy tank status, and turbine status.

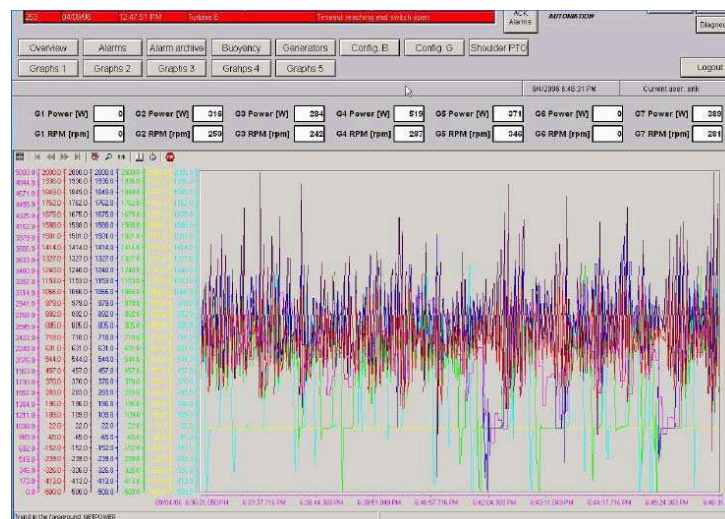

Fig. 8: Power production graphs taken from the SCADA system on 4th September 2006.

The SCADA PC is connected to the internet, and therefore allows control of the device completely remotely. This is aided by the use of 5 web cameras as a visual check on any abnormal behaviour. However on occasion this link has been lost; either due to grid power failures in the district, power failures on board, or simply issues with the internet provider. In these cases a back up system which uses the

GSM network becomes operational. In the case of serious abnormalities the PLC will send SMS messages to two nominated people. These people are able to control the PLC in a basic way by sending coded messages to the device. If both of these lines of communication are all down then the PLC will continue to operate in a safe manner. If power is lost to the PLC, the structure of the Wave Dragon will stay afloat without any active control system.

Moorings

The design for a full sized Wave Dragon has the device moored to buoy anchored by several catenary chains, a CALM buoy system. In Nissum Bredning the site is too shallow (at around 6 m) to allow this system. In the prototype the compliance of the mooring is provided by using elastic nylon and polyester ropes, a schematic of this is shown in fig. 9. The anchor is provided by a steel bucket filled with local sediment. A pile is attached to this anchor which is of great use, for mounting wind measuring devices, a webcam, and a pressure transducer to measure the incoming waves. A second smaller back anchor is present in the prototype to prevent the device colliding with the mooring pile. This restricts the movement of the device to $\pm 60^\circ$, which is acceptable close to a coast.

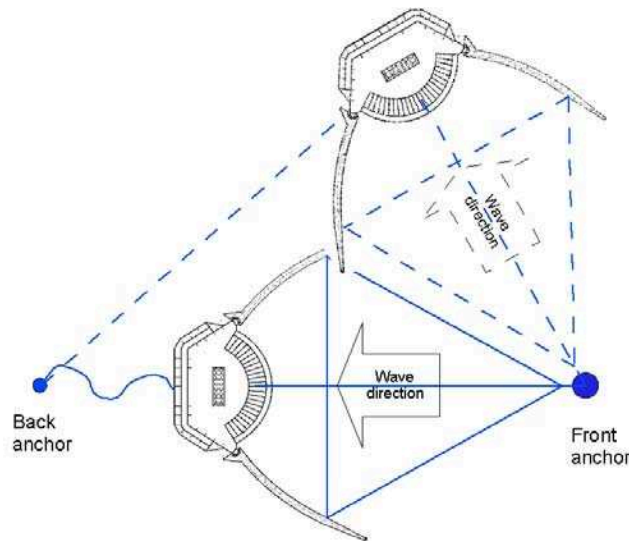

Fig. 9: Mooring Schematic.

A lot of data has been recorded by the force transducers in the mooring system. As reported in Kofoed et al (2006) and shown in fig. 10, the mooring forces show good correlation to the scale testing in the laboratory. There was a noticeable increase in the stiffness of the mooring lines due to marine growth during the period. This will not be an effect on catenary chains in a full scale deployment.

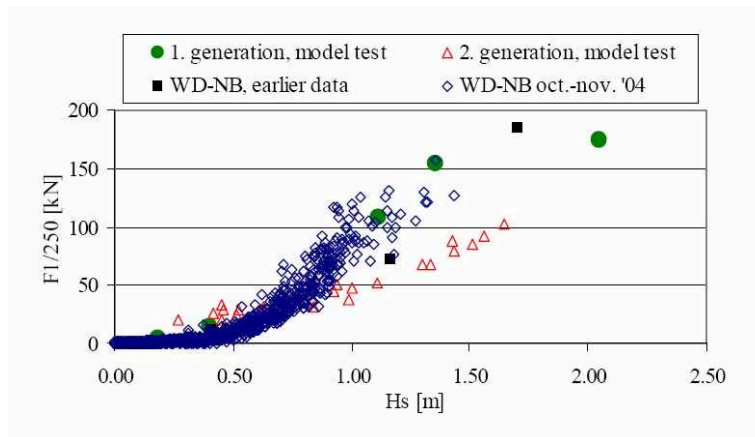

Fig. 10: Comparison of mooring forces in terms of $F/250$ (average of the 1/250 largest peaks) measured during 1:50 scale tests and prototype measurements (1 : 4.5). H_s is given in prototype scale.

Kofoed JP, Frigaard P, Friis-Madsen E and Sørensen HC. (2006). Prototype testing of the wave energy converter wave dragon. *Renewable Energy* 31, 2006.

Experience with Hydro Turbines

Power simulation investigations show a power take-off system consisting of 16 to 20 variable speed on/off low-head turbines of the Kaplan type with fixed runners and guide vanes is optimal for a production Wave Dragon. For the prototype platform a choice was made to replicate these with a selection of turbines, 10 in all. Each generating turbine is directly connected (no gear box) to a permanent magnet generator (PMG). Each PMG is connected to a frequency converter, which is used for control of the speed of the turbine and for supplying the power from each turbine onto a common DC rail. The power is then via another frequency converter put onto the grid with grid frequency and voltage. The turbines used are shown in Fig. 11 and detailed below.

- A Kaplan turbine with siphon inlet. This is the original turbine which had been tested at Technical University of Munich. The runner diameter of the siphon turbine is 0.34 meter, rated flow is 0.22 m³/s (at 0.5 m head) and rated power is 2.6 kW (at 1 m head) corresponding to 350 kW in a full scale North Sea Wave Dragon.
- 6 Kaplan turbines with cylinder gates. These turbines have the same runner diameter and performance data as the siphon turbine. The turbines were fabricated in Austria by Kössler GmbH, their runners were made by TUM.
- 3 dummy turbines. These turbines are not able to produce power; they are merely calibrated valves which let the overtopped water run back into the sea. The diameter of the valves is 0.43 meter, and discharge is about twice one of the real turbines. They permit accurate simulation of the discharge from a further 6 real cylinder gate turbines at a fraction of the cost.

In order to avoid debris in the turbines the turbine area was enclosed by a trash rack, see fig. 12. There is also a powerful water pump on board to enable testing and calibration of the turbines in calm situations.



Fig. 11: Turbines in the reservoir of the prototype: The yellow structure in the background is the siphon turbine, the grey towers are five of the six cylinder gate turbines, and the small devices in unpainted steel are two of the dummy turbines.



Fig. 12: Trash rack with 5 x 5 cm grid openings enclosing the turbine area.

Experience has shown that the aggressiveness of the salt water environment had been underestimated. A design proven in many river hydro power turbines has been used for the main turbine bearing, but the bearings failed after a few months of operation due to problems with the shaft seals.

The bearings of four out of the 7 turbines have been modified and rebuilt during the summer 2004, and the turbines have been operated without further problems from October to December 2004. The bearings of the remaining turbines have been modified and rebuilt during Summer 2005. It was possible to conduct the majority of this work onboard the floating platform.

Dismantling the turbines during the above mentioned repairs has also shown that marine growth is a factor that may not be taken lightly. The draft tubes of the turbines had been made from different materials: uncoated stainless steel, black steel protected with conventional epoxy paint and black steel protected with a recently developed silicone-based anti-fouling paint. The draft tubes painted with the conventional paint system were found heavily overgrown (mainly by the acorn barnacle (*balanus crenatus*) and sea squirt (*ciona intestinalis*)), which were almost impossible to remove. The stainless steel tubes as well as the ones coated with the silicone paint had only a few small barnacles on them which could be swept off very easily, as can be seen in fig. 13.



Fig. 13: The insides of two turbine draft tubes, on the left one painted with silicone paint, and on the right painting with conventional epoxy paint.

Power Production

There are many ways to show the power production of a WEC, depending on where you measure the power. In several published papers (e.g. Tedd et al, 2006) some of these methods are explored. Fig. 14 shows a typical time series for a record.

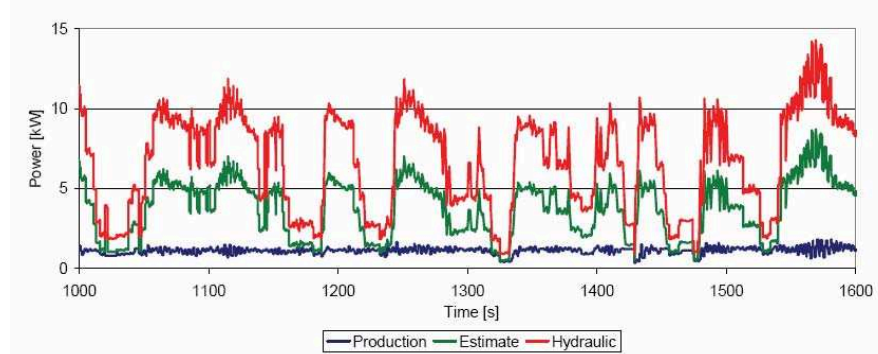

Fig. 14: Time series of a typical record, showing: Production, power delivered to the grid; Estimate power, which supposes the turbine set points were correct and

the dummy turbines produced as real turbines; and Hydraulic power the power of the water passing through the turbines.

An enormous quantity of data has been collected during the testing period, which has not yet been fully analysed. However, the work done up to now has confirmed that the performance predicted on the basis of wave tank testing and turbine model tests will be achieved in a full scale prototype.

Looking at the period May 2003 to December 2004 and scaling the energy production (1:4.5) to a typical 16 kW/m wave climate as found in the North Sea the prototype Wave Dragon would have produced from 50 to 500 MWh/month. Taking into account down periods and testing periods the real production has been approx. 3.2 GWh/year. The latest tests have shown that an optimal setting of the set points of the PM generators has increased the power production with a factor 2. Therefore it is assumed that the real production easily could have been 6.5 GWh/year or equal to an 18 % average wave-to-wire efficiency.

This result should be compared to the 16 % prototype goal and the 21 % long term goal for the Wave Dragon technology. Measurements of the hydraulic power indicate that it will be possible to reach this value of energy production. Some of the discrepancies are believed to be due to the scaling which will cause extra energy losses in bearings etc.

Tedd J, Kofoed JP Knapp W, Friis-Madsen E and Sørensen HC. (2006). Wave Dragon, prototype wave power production. World Renewable Energy Congress IX, Florence.

Summary

Since March 2003 a prototype of Wave Dragon has been tested in an inland sea in Denmark. This has been a great success with all subsystems tested and improved through working in the offshore environment. The project has proved the Wave Dragon device and has enabled the next stage, a production sized version.

Wave Dragon

7.3. Test Centres, Pilot Zones and European Co-operation

Introduction

As one of the pioneers of the wave energy field, Wave Dragon has been instrumental in developing Denmark's test centre for wave energy in Nissum Bredning. This has spurred development of Wave Energy in the area with more devices being tested in the vicinity. These later deployments have been much easier as Wave Dragon had already mapped the resource, performed environmental surveys, and liaised with local contractors to ensure reliable maintenance.

The next move for Wave Dragon is to build a device in Pembrokeshire, West Wales in the UK system. As a new technology deployed within a UK national park, Wave Dragon must provide a detailed Environmental Impact Assessment, before gaining consent for the deployment. This new pilot site is an early test case for the authorities of England and Wales, where it is only the second such application to be submitted.

Support from the European Commission together with the Danish and Welsh governments has been vital to the development of Wave Dragon. Support was forthcoming in the early tank testing stages, through the prototype development and now for development of a full sized pre-commercial demonstrator in Wales. Therefore Wave Dragon has operated a very open policy, publishing as much and as often as possible, supporting all Europe-wide initiative, as well as hosting exchange students. This has proved to be of great value to the company.

Nissum Bredning Test Centre

Nissum Bredning (broads) is a sheltered sea in the Danish mainland separated from the Danish North Sea by two thin tongues of sand, see fig. 1. The sea covers an area of approximately 200 km² with the longest continuous fetch in the area of 29 km. Therefore the waves in the area are solely driven by the local wind, with no long period swell waves. The water depth is mostly around 6 m, although there are shallower regions in the west.



Fig. 1: Satellite images of Nissum Bredning, from Google Earth. The detailed image shows shallower sandbanks to the West.

In 1998 the Danish Energy Authority and the Danish Wave Power Association collaborated with the local Nordic Folkecentre for Renewable Energy to construct a pier for initial testing of Wave Energy devices. This has been used by several inventors to test small wave energy devices, by putting them in the water at the end of the pier.



Fig. 2: The Nordic Centre for Renewable Energy's test pier, seen at sunset, with Wave Dragon floating to the right.

In preparation for the Wave Dragon test deployment in Nissum Bredning several studies were undertaken. The most important was to analyse the wave resource within the broads. As the waves are fetch limited the Shore Protection Manual method (SPM) could be used to determine the waves. Wind speeds to be used were well defined from four weather stations in the vicinity and the bathymetry is also well known. The study of Svendsen and Frigaard, 2001 produced fig. 3 showing the mean wave power per unit width.

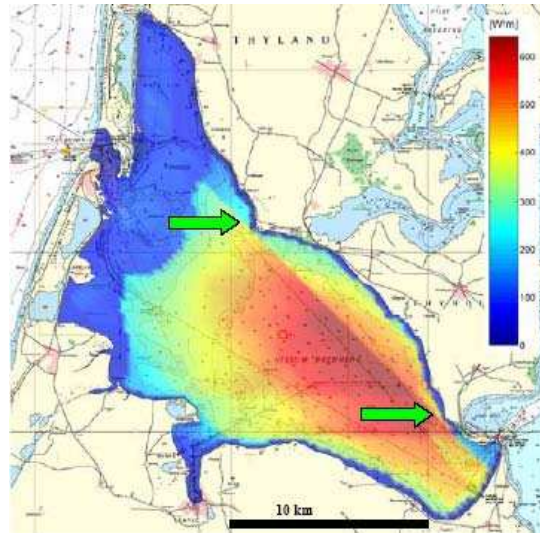

Fig. 3: Energy Density in Nissum Bredning. The arrows show the two sites where Wave Dragon was deployed, the Northern site is close to the pier in fig. 2, and the Southern site is one of the most energetic sites within the broads.

The Wave Dragon deployed here was built in scale 1:4.5 of a Wave Dragon for the North Sea. Wave power per meter of crest scales with a power of 2.5. The Northern site therefore has an equivalent power of 16 kW/m. The Wave Dragon was first tested here, as it is very accessible for early teething maintenance issues and a grid connection was available close to the test pier. The Southern site was chosen to test the device in the largest waves available within the broads, here there is an equivalent power of 24 kW/m. However it is less accessible, as a boat must travel from the harbours of Oddesund or Remmerstrand, both of which are around 5 km from the site.

Before deploying, Wave Dragon sent a consent application - including a description of the device - to the Danish Energy Authority. They performed a consultation process with all possible authorities (environmental, H&S, regional, local and military), and with relevant associations (fishermen, environmental etc) and announced the project in local newspapers and called for public objections. The consent was granted with these objections converted into requirements. The authorities and others found that there would be no or close to no negative effects from the project given that it was temporary. All found that it was a good idea to test new technologies. The full process is described well by Hansen et al, 2003.

The broads area is designated an EU Bird Protection Area (due to three diving ducks species: Common Goldeneye, Red-Breasted Merganser and Goosander); the northern site is also protected by the Ramsar Convention (on wetlands and waterfowl habitat of international importance). In response Wave Dragon agreed to not perform intrusive on-site work during the spring breeding season. Only a small area of seabed is affected by the device, so it has only a small impact on mussel

fishing. A non-toxic anti-fouling paint was applied to the turbine draft tubes to prevent poisoning of shellfish. The Wave Dragon has been grid connected at both the northern and southern locations.



Fig. 4: Bird life in Nissum Bredning. An Arctic Tern perches on the tip of the reflector wing, and a Herring Gull has made its nest in some spare cable on the roof of the control room.

In 2006 another Danish device, the Wave Star, a multi-point absorber was installed, mounted to the end of the test pier at the northern site. There are future plans for the southern site to be used for a prototype of a heaving buoy device. This would be using the offshore grid connection provided by Wave Dragon. Both of these devices have benefited from the Wave Dragon experience in the broads area, showing that wave energy can be environmentally benign.

Hansen LK, Christensen L and Sørensen HC. (2003). Experiences from the Approval Process of the Wave Dragon Project. Proceedings of the 5th European Wave Energy Conference, University College Cork, Ireland 2003.

Svendsen R and Frigaard P. (2001). Calculation of the Wave Conditions in Nissum Bredning. Report, Aalborg University Department of Civil Engineering.

Pembrokeshire Pilot Zone

Wave Dragon is progressing through the next stage of development: to build and deploy a device at a power production scale in order to show the technology to be commercially attractive. The project aims to deploy a 4-7 MW Wave Dragon, for 3-5 years in the Irish Sea, close to Milford Haven, Pembrokeshire, Wales. After the period of initial testing the device will be towed to a more energetic site, around 10 NM (19 km) offshore, to join a larger array. As this will be the first Wave energy device in Wales, and one of the earliest in the UK, a very stringent planning process must be observed.

Wave Dragon decided to make the pilot zone in Wales for practical and economic reasons. For a project to be economically feasible there must be possibilities to move the first pre-commercial demonstrator into a farm of devices. This farm requires good wave conditions, a large port for construction and maintenance

and good access to strong grid connection. Considering fig. 5, the areas of good wave resource in the UK are the islands of Western Scotland and the South West of Wales and England. Unfortunately the Western Islands of Scotland have very weak grid connections. Pembrokeshire was chosen as the Welsh Development Agency (now the Welsh Assembly Government) has been very supportive of the project since 2001, and also all the facilities such as large deep harbours and skilled workforce exist within Milford Haven.

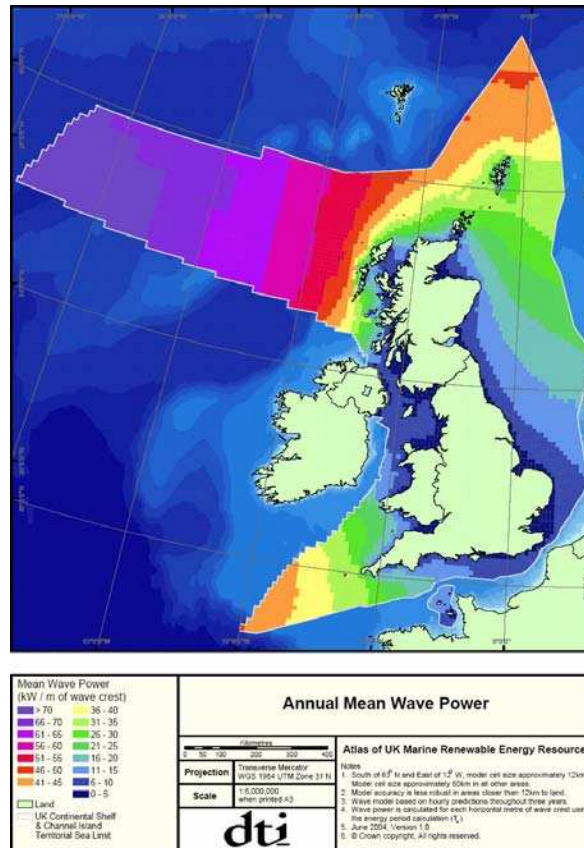

Fig. 5: Wave resource for the UK.

In Pembrokeshire there were several factors in choosing the precise site for the deployment. These varied from a desire to be close to shore and near a major port to reduce cabling and maintenance costs, to avoid major shipping lanes, and fishing areas, to avoid military training sites and munitions dumps, to minimise environmental impacts, and of course to choose a location with good wave climate. After initial considerations in the region, a 6 km square box was chosen with the intention to deploy the Wave Dragon within it. A scoping study (May and Bean, 2006) and consultation with all local, regional and national bodies and organisations enabled a full design for the Environmental Impact Assessment. This is re-

quired as the coast is a National Park, and the seabed itself is a Marine Reserve and a Site of Special Scientific Interest (SSSI).

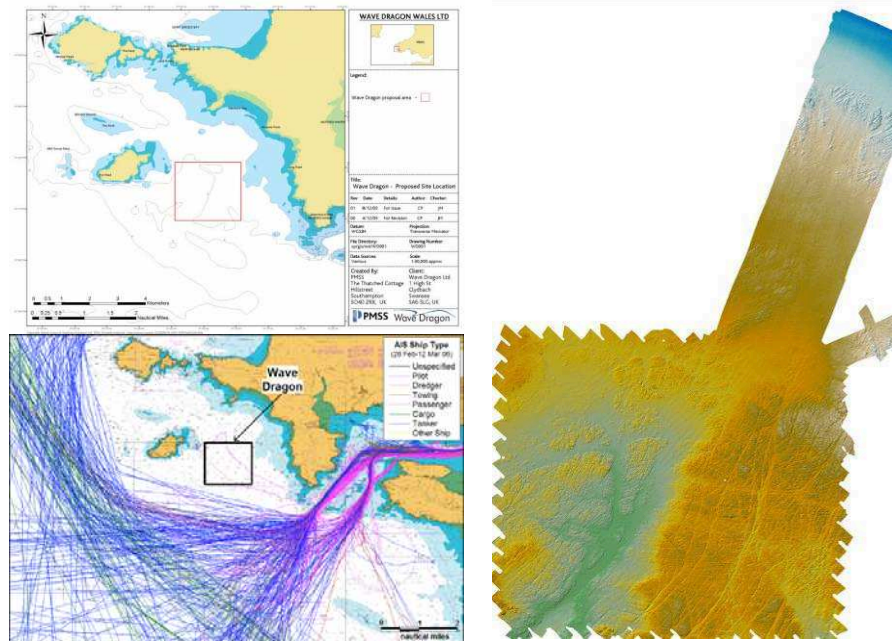

Fig. 6: Maps from the EIA, Clockwise from Top right, these show: Location of the surveyed 6 km²; Bathymetry of the site and cable approaches taken during the Geophysical survey; Ship paths recorded by AIS during a 14 day period.

Currently a wide variety of specialist consulting companies are working on the project, each looking at the impact within their own area of expertise. These vary from the wildlife including seabed, inter-tidal, marine mammals, birdlife, and more. The hydraulics of the device are studied for analyses of the effect on coastal processes such as erosion, sediment travel and surf waves. The human aspects are also covered including the effects on shipping, fisheries and navigation risk and any archaeology which may be disturbed. Some results from these studies are shown in figs. 6 and 7. From the Geophysical survey, an area of coarse sediment could be seen to the north east of the survey zone. The pilot plant will be deployed here, with the best mooring option, the minimising of cabling costs, and limiting possible damage to some more sensitive rocky habitats.

This system of gaining consents in the UK is very rigorous; it must also be followed by other offshore projects, such as wind farm developments. This is advantageous as it clearly proscribes what needs to be done. However it is also a time consuming and expensive process, two luxuries thinly spread in the field of wave energy. A full discussion of the UK system, and comparisons to other country procedures, can be found in Neumann et al, 2006.



Fig. 7: Visual impact: A 7MW Wave Dragon seen from the Pembrokehire Coast Path above Marloes Sands. Photomontage by Enviros.

In parallel with the consents procedure the engineering design work is being conducted. Wave Dragon has started a new European Research Project to produce a baseline design for a MW sized Wave Dragon, and to instrument and monitor its deployment. This partnership is very similar to the group involved in the last EU project, with additional academic partners from Warsaw and Swansea Universities who contribute their expertise on power electronics. To complete the concrete engineering Design, Dr. Tech. Olaf Olssen, a Norwegian engineering firm with extensive experience of construction and deployment in the North Sea, have joined. Finally Wave Dragon Wales Ltd, the UK subsidiary of Wave Dragon is the partner who will build, run and own the device.

Neumann F, Tedd J, Prado M, Russell I, Patrício S, La Regina V. (2006). Licensing and Environmental Issues of Wave Energy Projects. Proceedings of the World Renewable Energy Congress IX, Florence, Italy.

May J and Bean D. (2005). Wave Dragon Pre-Commercial Demonstrator - Environmental Impact Assessment Scoping Report, Prepared by PMSS, available at www.wavedragon.co.uk.

European cooperation

Wave Dragon is currently actively involved in the following Europe Wide projects:

1. The EU funded WD-MW Research Project (contract number 019983). This three year project will provide a baseline design for a multi-MW sized Wave Dragon and develop the remaining subsystems. It will continue to monitor the deployment of the first multi-MW sized Wave Dragon. There are 10 partners involved from 7 European countries.
2. The Co-ordinated Action on Ocean Energy (contract number 502701 (SES6) CA-OE), in which Wave Dragon ApS participates as developer. Wave Dragon partners SPOK ApS, the Technical University of Munich and Aalborg University participate as experts in their fields. This project enables a direct link to suppliers, utilities and other developers.
3. The Marie Curie Research Training Networks "WAVETRAIN" (Contract nr. MRTN-CT-2004-505166) in which SPOK is participating. This EC fi-

nanced mobility network programme aims at knowledge transfer and training of researchers within the field of wave energy. The Wave Dragon Team already had a wealth of experience with this programme and have hosted a research fellow (James Tedd) for a period of 3 years. Further on Wave Dragon Team has recruited another fellow (Iain Russell) from the network to work permanently in the newly established UK company Wave Dragon Ltd, mainly dealing with the environmental development.

4. EU-OEA – Dr Hans Christian Sørensen is a founding member of the board of the European Ocean Energy Association. The association will act as the central network for its members on information exchange and EU financial resources, as well as promoting the ocean energy sector by acting as a single EU voice.
5. NEEDS – Dr. Hans Christian Sørensen is representing the ocean energy developers in the New Energy Externalities Developments for Sustainability project establishing the thorough picture of the full costs including externalities of future energy systems. A Life Cycle Analysis for Wave Dragon will be included.

Wave Dragon was previously involved in the following European projects:

1. EU Joule Craft project (phase 3a). This early project involved feasibility testing of the design, both by computer simulations in Denmark and Germany, as well as laboratory tests of a 1:50 scaled device in Denmark and Ireland, and tests of the low-head turbines in Germany.
2. WaveDragon 1:4.5 research project (contract number: ENK5-CT-2002-00603). This project supported the sea-testing and deployment of the 1:4.5 scale demonstrator of Wave Dragon. It is described in great detail in section 7.2. and in the final report to the Commission Sørensen et al, 2006.

In addition to these formal projects that Wave Dragon has been involved with the company has been very active in promoting itself and Wave Energy in general to the academic and business world within Europe. This has involved giving many papers and presentations at conferences, and other workshops. Many students from France, the UK and Denmark have benefited from internships of several months with Wave Dragon, learning how a new technology can be brought forward.

Sørensen, H C, et al. (2006): Sea Testing and Optimisation of Power Production on a Scale 1:4.5 Test Rig of the Offshore Wave Energy Converter Wave Dragon, Final technical report, project NNE5-2001-00444.

Summary

Wave Dragon has been instrumental in developing the Danish Wave energy test centre at Nissum Bredning. The company is now developing a pilot zone in Pembrokeshire to deploy a multi-MW device. This has been achieved with good support from national governments and European co-operation projects.

Renovation of the Wave Dragon Nissum Bredning Prototype

Peer-reviewed conference paper

**Presented to the Sixteenth (2006) International Offshore
and Polar Engineering Conference, San Francisco, USA
(310506)**

**Published in the proceedings
ISBN 1-880653-66-4
Vol 1. pp 474-479**

Tedd J., Kofoed, J. P. and Friis-Madsen E.

Thesis author's contribution

The thesis author is the main author of this paper. He performed the laboratory tests on the novel joint supervised by co-author Kofoed. Together with co-authors Kofoed and Friis-Madsen the thesis author was involved with the process for the other improvements to the platform described. Co-author Friis-Madsen has overall responsibility for the prototype.

Renovation of the Wave Dragon Nissum Bredning Prototype

James Tedd¹, Jens Peter Kofoed¹ and Erik Friis-Madsen²

1. Department of Civil Engineering, Aalborg University,
Aalborg, Denmark

2. Löwenmark Consulting Engineers F.R.I.
Copenhagen, Denmark

ABSTRACT

This paper presents developments of the Wave Dragon, a large offshore wave energy converter. A prototype has been tested in a real sea environment for over 20 months. During 2005 the plant has been in harbor for a major overhaul of several of its components. The motivation for the upgrades, the laboratory testing procedure and the design and manufacture are described. The modifications are complete and the prototype is scheduled to be deployed at a higher energy site in December 2005.

KEY WORDS: Wave Energy; Prototype Testing; Scale Effects; Overtopping.

INTRODUCTION

The Wave Dragon is a floating offshore wave energy converter of the overtopping type. A full scale Wave Dragon designed for the North Sea would have a installed power of 4-11 MW. A 18.2 kW prototype has been tested in Nissum Bredning, a large inland waterway in Denmark since May 2003.



Figure 1: The Wave Dragon Nissum Bredning Prototype.

After this period of testing much information has been gained about the main components of the Wave Dragon, it is now to be deployed to a higher energy site within the Nissum Bredning area. Before redeployment several of the components have been upgraded, renovated and improved. The most noticeable of these is the joint between the long reflector arms and the main body. Issues with the

robustness of the previous design for the joint necessitated replacing it with a ball and socket type joint. This new design has been extensively tested on a 1:51.8 scale model in the wave basin facilities at Aalborg University.

The manufacture of this joint is now complete and fully instrumented. Other upgrades include refurbishment of the low head hydro turbines and re-ballasting of the reflector arms. The Wave Dragon prototype is now ready to be redeployed.

THE WAVE DRAGON CONCEPT

The Wave Dragon consists of three main elements:

- Two wave reflectors. Attached to the central platform these act to focus the incoming waves. Laboratory tests have verified numerical simulations showing their effect of increasing the wave height. This has been shown to improve the energy captured by approximately 100 % in typical wave conditions by Kramer and Frigaard (2002).
- The main platform. This is a floating reservoir with a doubly curved ramp facing the incoming waves. The waves overtop the ramp which has a variable crest freeboard 1 to 4 m. Underneath the platform open chambers operate as an air cushion maintaining the level of the reservoir.
- Hydro turbines. A set of low head Kaplan turbines converts the hydraulic head in the reservoir into electricity.

Waves overtopping the ramp fill the reservoir with water at a higher level than the mean sea level. This head of water is used for power production through the specially designed hydro turbines.

An advanced pneumatic system is used to adjust the floating level of the Wave Dragon. By allowing the main platform of the Wave Dragon to be raised and lowered the rate of overtopping can be controlled. The floating height is set to maximize energy captured for a given significant wave height, with a higher setting in large sea states. The time scale for this is approximately 250 wave periods.

The many hydro turbines on the Wave Dragon allow the flow out of the reservoir to be controlled too. The turbines are progressively started and stopped to ensure the reservoir is as close to full as possible, thus maximizing the available hydraulic head, and energy captured. The time scale to open the turbine cylinder gate and accelerate the turbine to operating speed is less than 1 wave period.

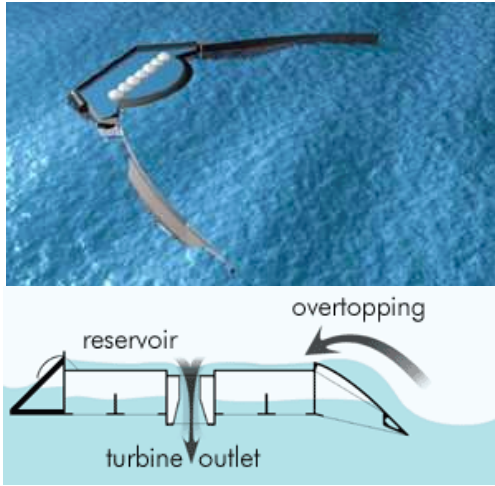

Figure 2: The Basic Principle of the Wave Dragon.

From 1998 to 2001 extensive scale testing and design of many aspects of operation was conducted. A 1:51.8 scale model was tested at Aalborg University by Kofoed et al. (2000). This led to a substantial redesign of the platform shape, optimizing the ramp profile for energy capture and the reservoir to minimize the platform motions. The low head Kaplan turbines were developed and tested at the Technical University of Munich. This led to a design with fixed angle guide vanes and rotor blades, and with variable speed drive see Knapp (2005b).

The prototype testing at Nissum Bredning has developed the design and tested aspect which could not be tested in small scale. A major aspect is the automatic control system, maintaining the floating height, keeping the platform level and operating the turbines optimally. Operation in a sea environment has also been tested, with the corresponding marine fouling, environmental studies and maintenance requirements. Still in this scale some aspects cannot be fully studied, in particular the mooring system. The CALM buoy system intended for the full scale is modeled by compliant polypropylene and Nylon mooring lines attached to a fixed pile.

A first full scale demonstrator Wave Dragon is planned to be deployed in the waters off Wales in early 2007. Currently environmental surveys are underway in order to gain the required consents and the design has begun. Future projects are in their early stages for deployments in the Danish North Sea, Portuguese waters and Hawaii.

PROTOTYPE TESTING

From July 2003 to January 2005 testing has been conducted on a 1:4.5 scale prototype Wave Dragon in real sea environment at Nissum Bredning. Figure 3 shows the location of Nissum Bredning (indicated by the ellipse), a broad area of salt water separated from the North Sea by two tongues of land. A scale of 1:4.5 was chosen as the wave climate within the area corresponds well to a 4.5 scaled down version of the North Sea wave climate.



Figure 3: Location of the Nissum Bredning Prototype.

The prototype tested at Nissum Bredning has a total mass (including water ballast) of 237 tonnes and the distance between the reflector tips is 58 m.

Figure 4 shows the average wave density in Nissum Bredning. The upper arrow is the position where the prototype has so far been tested. The lower arrow is the most exposed site, where the prototype will be redeployed to.

The previous tests have examined the functionality and power capture of the machine. The device was grid connected at the first location, and thus it became the world's first wave energy converter situated offshore. Frigaard et al. (2004) examined the overtopping measurements of the device and Kofoed et al. (2005) has reported on other general findings from this initial testing phase.

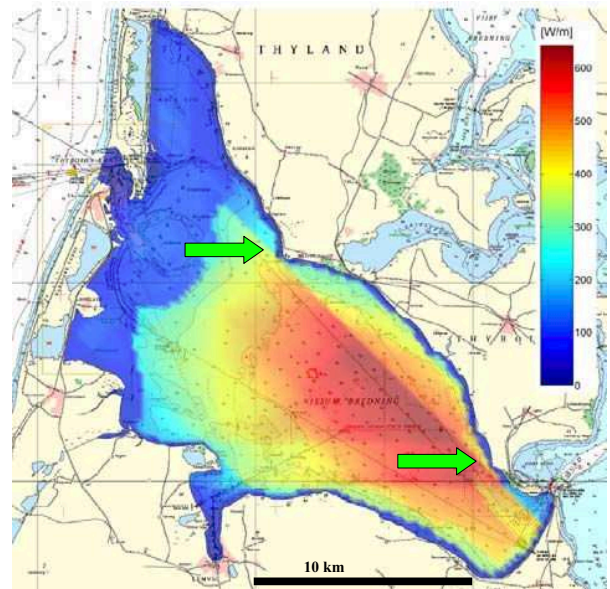

Figure 4: Energy density in Nissum Bredning. The two locations where the prototype will be placed are shown by arrows.

Unfortunately on the 8th January 2005 a large storm hit Northern Europe with ten minute average wind speeds of over 33 m/s. This 100 year event triggered a failure in a force transducer connecting the mooring lines of the Wave Dragon to its anchoring pile. The Wave Dragon stranded on a beach around 400 m from its original site. It suffered very little damage during the episode. After it was re-floated it was taken to the harbor where the work has been conducted.

In the higher energy site the power production to the grid will be greater. As it in a less accessible position the prototype will have to operate with its independent control system with less human intervention. The teething troubles which occurred at the first site have been overcome so this will be possible.

REFLECTOR JOINT

The joint between the reflectors and the main platform has been a source of trouble with the Wave Dragon prototype. The previous design with rubber fenders between the reflector and the platform suffered from a lack of robustness with failures occurring due to minor irregularities in sea states well below design specifications. The maintenance requirements of the previous design would also be too high for the full scale Wave Dragon.

The new design of joint is designed to increase robustness to minor failures in the tension line mooring system, and to lower maintenance costs. A ball and socket is chosen to resist forces in three directions by restricting the degrees of freedom at the joint from six to three.



Figure 5: Test setup with 1:51.8 scale model and force transducer measuring shear force at joint

The 1:51.8 scale model of Wave Dragon, used in previous tests was re-equipped with ball joints between the reflectors and the main platform. Testing was conducted in the wave basin facilities at Aalborg University. Irregular two and three dimensional waves were produced which following the JONSWAP spectrum, a variant of the Pierson-Moscovitz spectra standard for the North Sea. The results were scaled to the prototype size and a full sized Wave Dragon according to the

Froude number as shown in Table 1. Comparisons made between the prototype results and previous model tests show that this scaling is valid, only minor scale effects occur.

Table 1: Scaling ratios between model, prototype and full scale.

Unit	Scaling	Model - Prototype	Model - Full Scale
Length	λ_L	11.5	51.8
Time	$\lambda_L^{0.5}$	3.4	7.2
Force	λ_L^3	1.5×10^3	1.4×10^5
Power	$\lambda_L^{3.5}$	5.2×10^3	1.0×10^6

Initial tests confirmed that the highest position of the joint gives the best stability for the arm. Described in Tedd, Friis-Madsen and Frigaard (2005) these tests continued to measure the forces in the joint and its motions when unrestricted.

Figures 6 and 7 show the results from these tests with values scaled to the North Sea. The graphs show the average of the 1/250 highest peak forces for the axial and shear components. During a thirty minute test this is roughly equivalent to the average of the eight highest values measured, and is used to reduce scatter. The forces measured are in line with, and slightly lower than the measurements on the previous design.

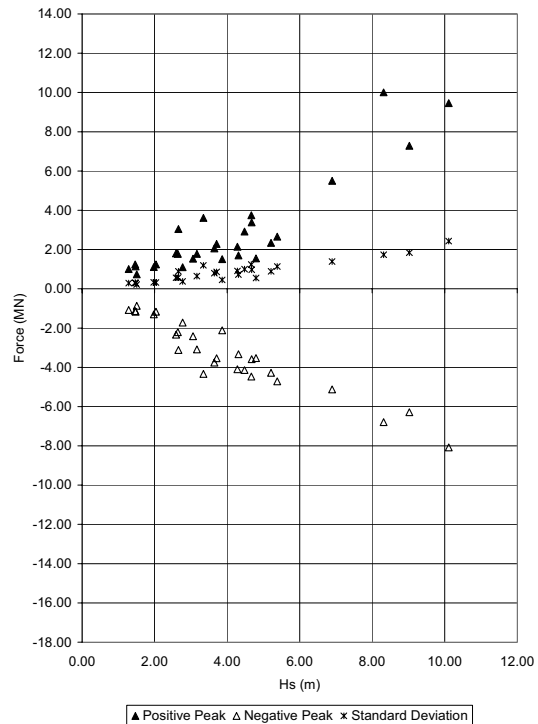

Figure 6: Axial force at joint

The motions of the arm were recorded using ultrasonic measurement system. With no other restrictions apart from the mooring lines the roll motion of the reflector was found to be the most significant. The RMS roll angle was up to 10 degrees with extremes at ± 15 degrees.

The large roll motions of the reflector arm were felt to be quite dangerous for the system as they could likely cause large wear and fatigue failure. The Wave Dragon inventor Erik Friis-Madsen proposed

adding hydraulic cylinders to the joint. Connected to a generator these would act to dampen the motions and also allow power to be extracted from the roll motion of the reflector.

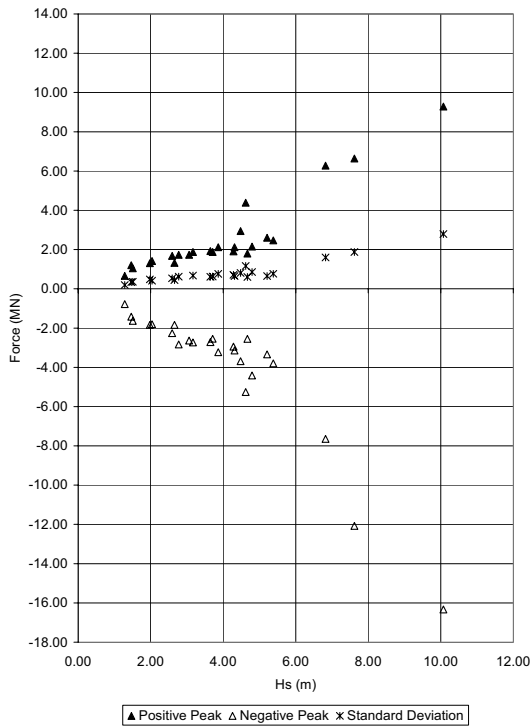

Figure 7: Shear force at joint

It is a significant challenge to model this hydraulic cylinders on such a small scale as the sticking friction in such a small cylinder is great. The solution used was a custom made Perspex cylinder and piston of diameter 33 mm. This, filled with water and connected with a thin (8 mm inner diameter, 2 – 5 m long) pipe to a reservoir gave a system allowing varying damping ratio. Tests on this measuring the moment applied by the cylinder to the reflector and the velocity of the piston were used to design the hydraulic power take off system.

Figure 8 shows the 1/250 maximum and minimum peak roll moments applied to the reflector for three different damping ratios. The roll motions of the reflector were reduced by a factor of between 2 and 3. The average energy absorbed by the reflector was measured at up to 65 kW in North Sea scale in operational states.

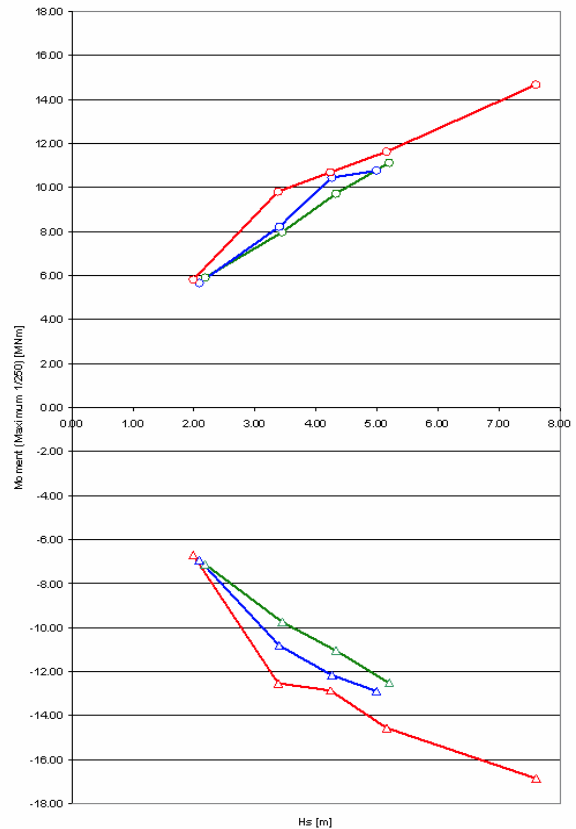

Figure 8: Roll moment on the arm.

This is for a rather over-damped system, by tuning it is anticipated that up to 250 kW will be possible to be extracted. However it must be noted that as will all oscillatory systems the power flow is very irregular with peak values over 5 times the mean. A time history of the power dissipated in the model cylinder is shown in Figure 9. This is described in full in Tedd and Kofoed (2005).

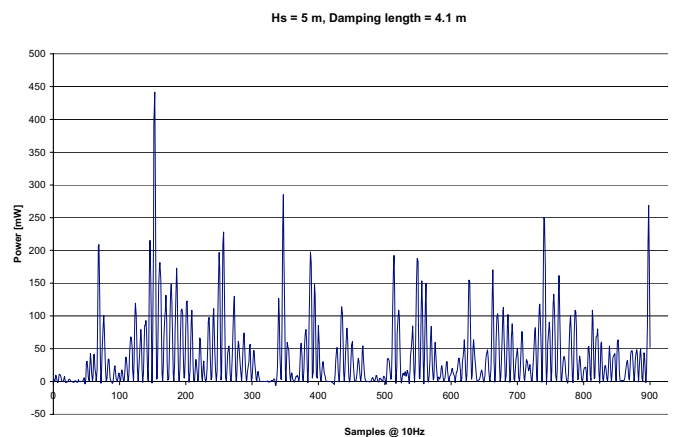

Figure 9: A typical 100 s record of power dissipated in model damping cylinder.

On the prototype the joint is constructed from a cast steel ball with PTFE bearing pads. A short cylindrical section fixes this to the reflector. The ball is encased by the socket which will be fixed to the platform at sea. The whole joint is encased by a rubber bellow to keep

out sea water and prevent corrosion. In case of a leakage the bellow is filled with pressurized air.



Figure 10: Manufactured joint and fitting on main platform.

The short cylindrical section connected to the ball joint has been instrumented with strain gauge roses. As it is a simple geometric shape these strain readings will allow the forces in the joint to be calculated. In connection with a force transducer mounted in the mooring line to the reflector, it will be possible to calculate the shear force at any point of the reflector.

The hydraulic damping system is made with two pistons, mounted between the platform and the upper part of the reflector. They are positioned to mainly reduce the roll motions of the reflector, however they will also act for the roll and sway motions. The high pressure water is stored in a reservoir and from there is used to run a 24 V DC generator. The reservoir will act as a buffer and smooth the power produced.

RENOVATION OF TURBINES

While the Wave Dragon has been in harbor, much work has been conducted on the turbines and their permanent magnet generators (Knapp 2005a). While the Wave Dragon was stranded the six cylinder gate turbines (including the draft tubes and generators) were lifted off the platform.

While on dry land the turbine draft tubes were inspected. There was a large variation in marine growth with almost none on the tubes painted

with non-toxic anti-fouling paint and around 4 cm of growth on unpainted tubes. The rotors which obviously have much higher velocity flows past them had no growth.

During the prototype testing the seals of the thrust bearings failed. The bearing has been redesigned and four had been replaced while the platform was at sea. The remaining three have now also been replaced. An inspection hatch was also fitted to all the cylinder gates.



Figure 11: Reinstallation of turbine.

After the replacement of the turbines their characteristics were tested by pumping water into the Wave Dragon platform. The mechanical, hydraulic and electrical efficiencies of the power train (from hydraulic head to electric power from the permanent magnet generators) were found to be 85 - 92 % at the operating head range.

BALLASTING OF THE REFLECTORS

The typical reflector cross section for a full sized Wave Dragon is shown in Figure 12. The vertical face reflects the wave and the box section provides the buoyancy, stability and stiffness to the arm. Unlike the concrete full scale Wave Dragon the steel construction of the prototype requires extra ballasting.

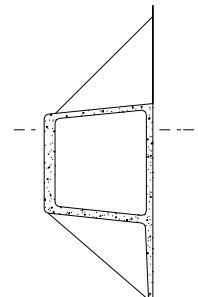

Figure 12: Typical simplified cross-section of reflector.

In the initial design polystyrene foam slabs were fixed to the vertical sides of the box section. The reflectors were then ballasted with water to obtain the correct draught. After almost two years at sea the foam was found to be severely damaged. The large air gap allowed the ballast water to move around in the chambers. The correct ballast is now known and the sections have been fitted with a larger volume of foamed polystyrene placed at the top of the section. This improvement will significantly improve the roll stability of the arms.

PLC SYSTEM

A Programmable Logic Controller (PLC) is used on the Wave Dragon to control the floating position of the platform and the turbines for optimal power take-off. Over the years several modifications and improvements have been made to this control system.

While the Wave Dragon has been in harbor more significant modifications have been conducted. The system has been upgraded to use readings from new pressure transducers positioned in the buoyancy tanks and the reservoir. Also much work was conducted to improve emergency procedures to ensure that the prototype can continue unsupervised.

CONCLUSIONS

During 2005 the Wave Dragon prototype has undergone a major overhaul. This necessitated an extensive laboratory testing procedure of the new joint between the main platform and the wave reflectors.

The plant is now ready to be redeployed in Nissum Bredning. It is instrumented to allow results from the sea testing to be compared with the laboratory expectations.

ACKNOWLEDGEMENTS

The prototype project has only been possible with generous support funding from the European Commission (Contract No: ENK5-CT-2002-00603), Danish Energy Authority, Elkraft System (PSO Funding),

The Obel Family Trust and the dedication of the participating partners. The author is a research fellow funded by the Marie Curie WaveTrain training network.

FURTHER INFORMATION

More information can be found on the project at the website www.wavedragon.net.

REFERENCES

- Frigaard P., Kofoed J. P. and Rasmussen M. R. (2004) "Overtopping Measurements on the Wave Dragon Nissum Bredning Prototype" *ISOPE 2004*, Toulon, France.
- Friis-Madsen E., Kofoed J.P. and Knapp, W (2005). "Prototype Testing of the Wave Energy Converter Wave Dragon" *The World Renewable Energy Congress 2005*, Aberdeen, UK.
- Knapp W. (2005a) "Report on the re- installation and calibration of the Wave Dragon turbines" Laboratorium für Hydraulische Maschinen, Technische Universität München.
- Knapp W. (2005b) "Water Turbines for Overtopping Wave Energy Converters" *CA-OE workshop on Component Technology and Power Take-off*. Uppsala, Sweden.
- Kofoed J.P., Frigaard P., Friis-Madsen E. and Sørensen H.C. (2000) "Development of the Wave Energy Converter – Wave Dragon" *ISOPE 2000*. Seattle. USA.
- Kofoed J.P., Frigaard P., Friis-Madsen E. and Sørensen H.C. (2006) "Prototype testing of the wave energy converter Wave Dragon" *Renewable Energy*, Vol 31, pp 181-189.
- Kramer M., Frigaard P. (2002) "Efficient Wave Energy Amplification with Wave Reflectors" *ISOPE 2002*. Kitakyushu, Japan.
- Tedd J., Friis-Madsen E. and Frigaard P. (2005) "Design and Testing for Novel Joint for Wave Reflectors" *Sixth European Wave and Tidal Energy Conference*, Glasgow, UK.
- Tedd J. and Kofoed J.P. (2005) "Model Testing of Hydraulic Damping of the Reflector Joint on Wave Dragon" Aalborg University.

Wave Dragon, prototype wave power production

Peer-reviewed conference paper

**Presented to the Sixteenth (2006) World Renewable Energy
Congress, Florence, Italy
(310806)**

**Published in the proceedings
ISBN 008-44671-X
Paper: MT-13**

**Tedd J., Kofoed J. P., Knapp W.,
Friis-Madsen E. and Sørensen H. C.**

Thesis author's contribution

The thesis author is the main author of this paper. He designed and performed the analysis of the data from the prototype, the main focus of this paper. Co-author Kofoed was principally in charge of instrumentation of the device during the period of the data collection, and provided details of the device up-time. Co-author Knapp was responsible for the turbines, their calibration, and testing of breaking curves required for the thesis author's analysis. Co-author Friis-Madsen invented the device. Co-author Sørensen co-ordinated the Wave Dragon group of companies in order to achieve the successful testing of the device.

Wave Dragon, prototype wave power production

J. Tedd^{a,b}, J.P. Kofoed^a, W. Knapp^c, E. Friis-Madsen^b, H.C. Sørensen^b

^a Department of Civil Engineering, Aalborg University, Aalborg 9000, Denmark

^b Wave Dragon ApS., Blegdamsvej 4, Copenhagen N 2200, Denmark

^c Laboratorium für Hydraulische Maschinen, TU München, 80290 München, Germany

Wave Dragon is a floating wave energy converter working by extracting energy principally by means of overtopping of waves into a reservoir. A 1:4.5 scale prototype has been sea tested for 20 months. This paper presents results from testing, experiences gained and developments made during this extended period. The prototype is highly instrumented. The overtopping characteristic and the power produced are presented here. This has enabled comparison between the prototype and earlier results from both laboratory model and computer simulation. This gives the optimal operating point and the expected power of the device. The project development team has gained much soft experience from working in the harsh offshore environment. In particular the effect of marine growth in the draft tubes of the turbines has been investigated. The control of the device has been a focus for development as it operates automatically for most of the time. This has led to improvements in the power take off, trim control and stability of the device.

Keywords: Wave Power, Overtopping, Production, Prototype

Introduction

The Wave Dragon is a floating offshore wave energy converter of the overtopping type. A full scale Wave Dragon designed for an appropriate climate would have a installed power of 4-11 MW. A prototype scaled at 1:4.5 of a North Sea model and rated at 20 kW has been tested in Nissum Bredning, a large inland waterway in Denmark from May 2003 to January 2005.

The concept works by waves overtopping a ramp, filling a floating reservoir with water at a higher level than the mean sea level. This head of water is used for power production through the specially designed hydro turbines.



Figure 1: The Wave Dragon Nissum Bredning Prototype.

The prototype has all the features of a operational power plant including: slender wave reflectors to focus the energy of the waves towards the ramp, a pneumatic system to adjust the floating level of the platform; seven Propeller turbines mounted with permanent magnet (PM) generators to convert the potential energy of the water; and an inverter system to control the variable speed of the turbines. Furthermore, three calibrated dummy turbines are used to process overtopping flow rates that exceed the capacity of the Propeller turbines. The power generated is exported to the Danish national grid via a three phase sub-sea power cable.

Availability

The Wave Dragon Nissum Bredning Prototype has been tested in real sea for approx. 2 years. During the period May 2003 to December 2004 the availability of the system has been continuously increasing to up to 80% at the last part of the period.

Monthly operating experience of the power production systems from May 2003 until end

of 2004 is summarised in Figure 2. This reflects time logged in the PLC system where the Wave Dragon's power production system has been in active operation, either

- “Continuous operation” (green) mode which covers longer periods where the prototype has been in automatic production mode. Not necessarily aiming at optimum power output.
- When carrying out specific test runs (labelled “Testing”, yellow). This covers tests of control systems and tests of hydraulic response, i.e. effect on floating level and stability.

The additional time has been spent on:

- Re-construction and re-configuration activities (labelled “Re-construction”, grey)
- Waiting time (labelled “Out of operation”, red). This covers as an example holidays and simply evenings and nights in the periods without a working automatic fire extinguishing systems (insurance question). In these periods power production has been stopped.

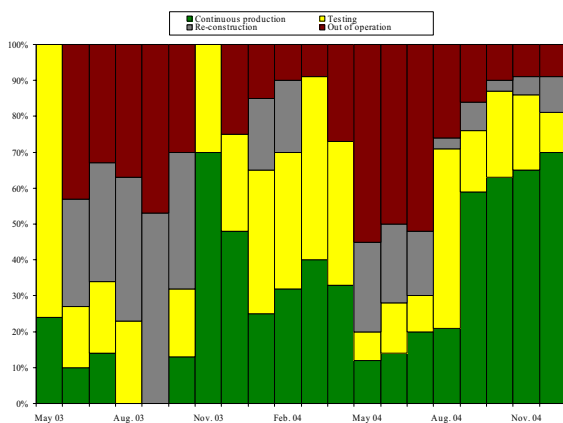

Figure 2: Availability of WD-NB over the period of real sea testing.

The Wave Dragon's power production system referred to covers turbines, generators, inverters and rectifiers plus PLC system.

A close to 100% availability has been achieved for other Wave Dragon systems, like

the automatic floating level and stability system and the remote control and communication systems.

From the 1st October 2004 to 9th January 2005 measurements were made almost continuously on the prototype. Sample periods of 30 minutes were chosen - 300 to 500 waves. This prevents too much scatter within a result set, while preventing a loss of definition due to fast wave build up in Nissum Bredning which has a relatively short fetch. Of the approximately 4800 such sample periods during the time 3969 records were made including the most important measurements. Of these 1577 had high quality enough measurements to allow full time series analysis of all the flows, and of these 247 had significant wave height great enough to give some power production. This relatively low proportion is due to the fact that the platform was not fully ballasted – for safety reasons – and thus it never floated at a level low enough to permit overtopping at very low wave heights. These 247 sample periods are those shown in this paper.

Power capture

The water flow overtopping the ramp and the hydraulic power which passes through the turbines are the two main measures used to compare power production performance at this stage. The overtopping flow is compared to predictions based on earlier laboratory tests. The hydraulic power passing through the turbines accounts for the lower head across the turbine than the crest freeboard. The electrical power generated by the real turbines is recorded. A third measure of power is the estimated electrical power, this is the power which would have been produced by the hydraulic power if the dummy turbine flow had passed through a functioning turbine and if the speed control of the PM generators was working optimally.

The overtopping flow is defined as the flow which passes through the turbines, ignoring

any spill from the reservoir back to the sea. The individual turbine flow is calculated from the turbine characteristic (Keller et al, 2001) as a function of head and rotational speed. Pressure transducers in the reservoir measure the head.

Kofoed et al, 2006, presents the overtopping relationship for the Wave Dragon based on the results from tank testing of a scale model. It is clear that there is a wave length dependency on the overtopping. The form of the non-dimensional units Q^* and R^* depend on the wave steepness, based on the breaking criterion. The slope of the ramp of the Wave Dragon is rather steep; to avoid loss of energy during breaking. A better model for the rate of overtopping over a low crested, non-breaking and floating structure is desirable.

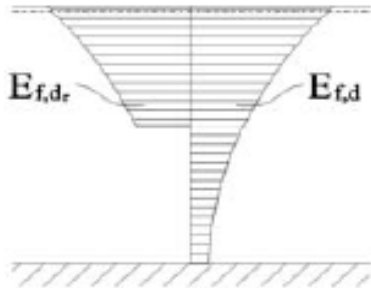

Figure 3: Vertical distribution of energy in water column

A different method to include the frequency dependency of the waves into the non-dimensional form is given by Kofoed, 2002. Its physical basis has more relevance for this case of a floating overtopping device, and is shown above in Figure 3. The average overtopping rate Q_N is non-dimensionalized as normal and modified by the ratio of the energy in the water column between the free surface and the draft of the device to the total energy in the water column.

$$Q_N = \frac{1}{\lambda_{d_r}} \frac{\bar{Q}}{W \sqrt{gH_S^3}} \quad (1)$$

Where:

\bar{Q} = overtopping rate [m^3/s]

H_S = Significant wave height [m]

W = Ramp width 21.6 m [m]
 Ratio of energy between free surface and device draft $E_{f,dr}$ to incident wave energy $E_{f,d}$ [m]
 $\lambda_{d_r} = 1 - \frac{\sinh(2k_p d(1 - \frac{d_r}{d})) + 2k_p d(1 - \frac{d_r}{d})}{\sinh(2k_p d) + 2k_p d}$
 k_p = Wave number at peak period [m^{-1}]
 d = Depth of water [m]
 d_r = Draft of device [m]

Figure 4 shows the overtopping flow relationship, between the Q_N and the relative crest freeboard (Rc/H_s). The predicted overtopping from the old theory (Hald and Frigaard, 2001) is presented to compare the flow through the turbines measured on the prototype. The scatter in these results is due to the difference in the form of the relationship, an exponential best fit line is plotted for these. The measured flow through the turbines is plotted, with the size of the markers indicating the proportion of time the reservoir was within 0.01 m of full. The larger points show a full level between 50 % and 75 % of the time.

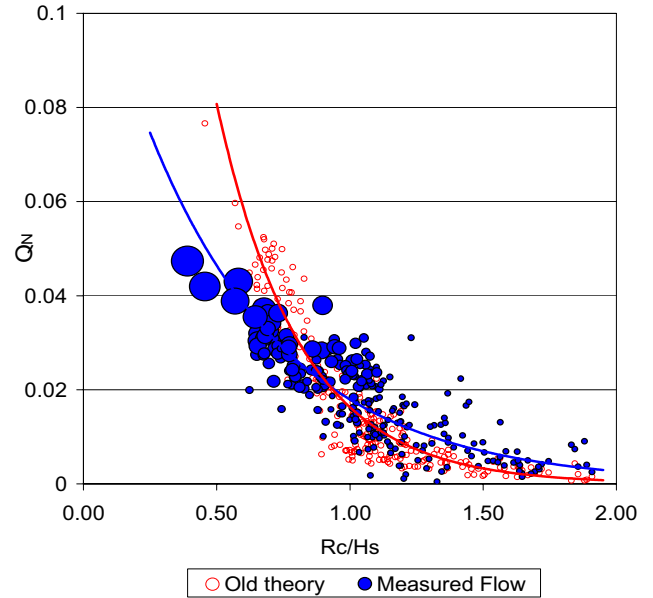

Figure 4: Overtopping flow

When the crest freeboard was high ($Rc/H_s > 1$) the overtopping rate was generally higher

than predicted from the old formulation. In lower crest freeboard the water flow through the turbines was considerably less than the predicted flow. In these cases the reservoir was very close to the full level for over half the period. It is probable that this loss in flow is due to considerable spill from the reservoir back to the sea. This is a greater problem than expected as the flow capacity of the prototype was less than designed. This was caused by an incorrect setting of the inverter speed control, causing the generators to spin at a below optimal speed, and also three of the generators were out of order for this period. The flow capacity of the prototype is thought to have been around 65% of the designed capacity.

Figure 5 below shows the average power produced in various sea states. The ‘Produced’ power is the electricity delivered from the PM generators on the working turbines. The ‘Estimated’ Power is the electrical power which would have produced if the dummy turbines had been producing at the same efficiency as the actual turbines, and if the inverter speed control had been functioning correctly. The ‘Hydraulic’ power is the power of the water passing through the turbines.

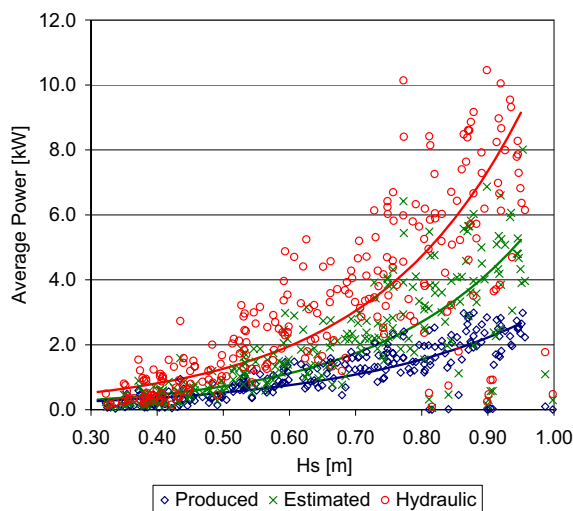

Figure 5: Energy captured

There is a significant difference between the hydraulic and the electrical energy. This is due to the low overall efficiency (0.3-0.65 depending on head) of the scaled down turbines and generators, mainly due to fixed losses such as bearing friction. In the full scale the overall efficiency of this stage will be between 0.80 and 0.85. The total levels of energy production are also low as the platform was mostly operated at a too high floating level and with insufficient turbine capacity at the lower levels.

Figure 6 shows the ratio of energy captured by the Wave Dragon. The ‘Hydraulic’ efficiency is defined as the ratio of the average power of the water through the turbines to the theoretical incoming wave power across a width equal to the Wave Dragon ramp width (see Falnes, 2002). The ‘Production’ energy is the ratio of the average electric power generated by the operating turbines to the same theoretical incoming wave power.

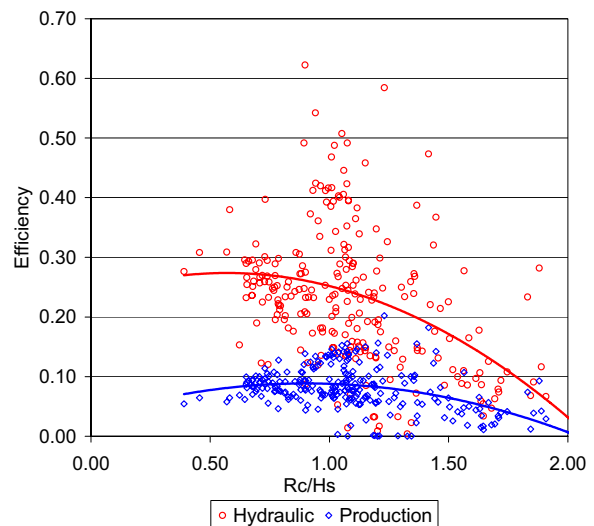

Figure 6: Efficiency

From this diagram it appears that the optimal relative crest freeboard for energy production is around $R_c/H_s = 1.0$. The hydraulic efficiency was lower at the lower crest levels due to the lack of turbine capacity. Production efficiency is much lower at these points as here much of the flow passed

0.62 m and a floating level of 0.45 m. There is a great deal of dummy turbine activity here, which does not show up on the actual electrical production. The power is quite smooth, with a ratio between the peaks and troughs of the estimated power of around 3.

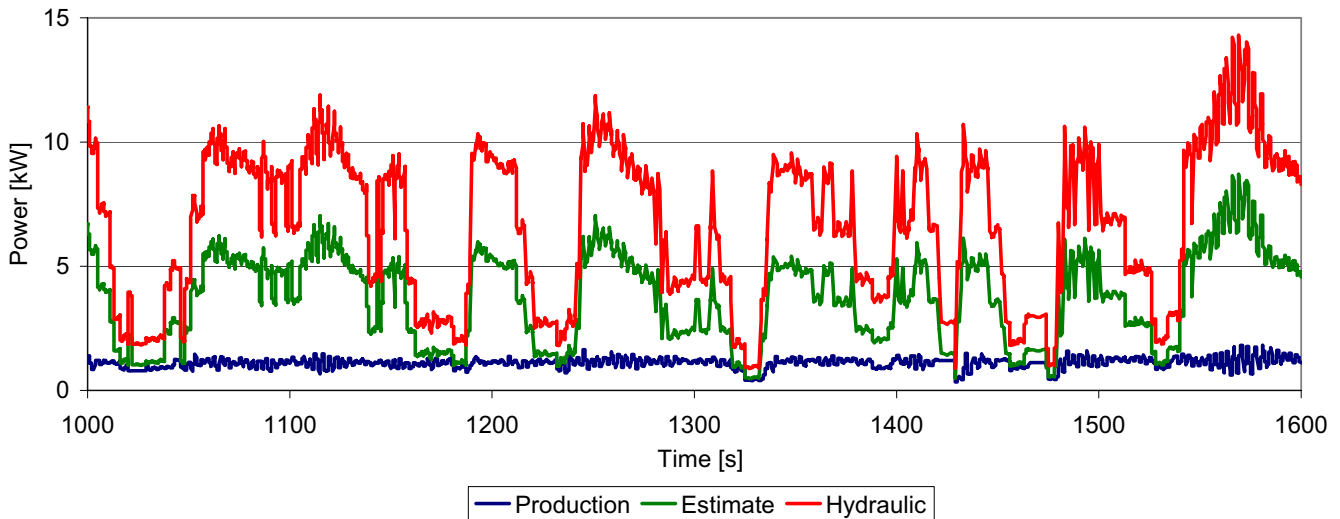

Figure 7: Time series of sample record

through the dummy turbines and so did not generate any electricity. Previous simulation work has shown an optimal relative floating level of R_c/H_s 0.7-0.8 with full capacity. This is still believed to be accurate.

Currently work is being conducted by Knapp in the Technical University of Munich on the simulation program. This work is trying to simulate the production of the prototype Wave Dragon, operating as it did during this period, in particular taking into account the faulty turbine speed behaviour. This will enable a good comparison of whether the energy captured is realistic, and how large the improvement in production would be if the turbines had been operated at full capacity.

The time series shown in Figure 7 shows a 10 minute sample from the record of December 16th 2004 at just after 9 am. The corresponding point lies roughly in the middle of the records and was of a sample with $H_s =$

Soft issues

In operating and maintaining the device during the testing period, the development team has gained invaluable “soft” experiences. This can be grouped into the following categories:

- Maintenance: the experience has shown that access to the device, transportation of pieces of equipment and work on board are only possible in relatively calm weather conditions. This can be planned on the basis of weather forecasts, but major operations need to be planned including a withdrawal scenario for the case that the work needs to be stopped due to bad weather.
- Corrosion: for many stationary steel parts, a conventional epoxy paint system has proven sufficient. For some of the moving parts, however, more expensive corrosion resistant materials needed to be used. This proved to be of particular importance in parts of the power train such as turbine shafts and bearings. For strongly stressed

components, stress corrosion cracking needs to be considered.

- Marine growth: On components underneath the waterline, heavy marine growth has accumulated within a short time. In some components this is acceptable, as it just means additional weight. In others, such as the turbine draft tubes, the layer of growth increases the friction losses and reduces the performance. This problem was solved by using suitable non-toxic anti-fouling coatings, which proved very efficient.
- Electrical equipment: A number of components that were classified IP66 failed although they were just exposed to rain and wind. The spray of sea water is carried into places that seem to be relatively well sheltered. The lesson learnt is that sensitive equipment must be assembled with utmost care to make sure the sealing properties are maintained, and it needs additional protection against splash and spray exposure. Also the effect of corrosion attack onto the sealing surfaces needs to be considered.

Overall, there were no problems that could not be solved, but a lot of problems that were not anticipated.

Conclusion

The real sea testing of the Wave Dragon prototype has proven its seaworthiness, floating stability and power production potential. Operation of the device in the harsh offshore environment has led to a number of smaller component failures. All of these have been investigated, and technical solutions have been found.

An enormous quantity of data has been collected during the testing period, which has not yet been fully analysed. However, the work done up to now has confirmed that the performance predicted on the basis of wave tank testing and turbine model tests will be achieved in a full scale prototype.

Acknowledgements

The prototype project has only been possible with generous support funding from the European Commission (Contract No: ENK5-CT-2002-00603), Danish Energy Authority, The Obel Family Trust and the dedication of the participating partners. The first author is a research fellow funded by the Marie Curie WaveTrain training network.

Further information

More information can be found on the project at the website www.wavedragon.net.

References

Falnes J. *“Ocean Waves and Oscillating Systems”*, Cambridge University Press, 2002

Frigaard P. and Kofoed J.P. *“Power production experience from Wave Dragon prototype testing in Nissum Bredning: 2003 to 2005”* Aalborg University, 2005.

Hald, T. and Frigaard, P.: Forces and Overtopping on 2. generation WD for Nissum Bredning. Phase 3 project, Danish Energy Agency. Project No. ENS-51191/00-0067.

Hydraulics & Coastal Engineering Laboratory, Aalborg University, Denmark, 2001.

Kofoed J.P. *“Wave overtopping of Marine Structures – Utilization of Wave Energy”* Aalborg University, 2002.

Kofoed J.P., Frigaard P., Friis-Madsen E. and Sørensen H.C. *“Prototype testing of the wave energy converter wave dragon”* Renewable Energy 31, 2006.

Keller J., Rohne W., Böhm C. and Knapp W. *“Wave Dragon, Development and Tests of a Variable Speed Axial Turbine”* TU München, 2001.

Measurements of overtopping flow time series on the Wave Dragon, wave energy converter

International journal paper

**Submitted to the Renewable Energy Journal,
Published by Elsevier, UK
(020507)**

ISSN: 0960-1481

Tedd J. and Kofoed J. P.

Thesis author's contribution

The thesis author is the main author of this paper. He set-up the prototype device to make the readings, and analysed them to examine the overtopping flow. Co-author Kofoed assisted with advice with the paper, as he had performed similar earlier studies for a laboratory model.

Measurements of overtopping flow time series on the Wave Dragon, wave energy converter

James Tedd, Jens Peter Kofoed

*Department of Civil Engineering, Aalborg University,
Sohngaardhomsvej 57, Aalborg, 9000, Denmark*

Abstract

A study of overtopping flow series on the Wave Dragon prototype, a low crested device designed to maximise flow, in a real sea, is presented. This study aims to fill the gap in the literature on time series of flow overtopping low crested structures. By comparing to a simulated flow the characteristics of the overtopping flow are discussed and the simulation algorithm is tested. Measured data is shown from a storm build up in October 2006, from the Wave Dragon prototype situated in an inland sea in Northern Denmark. This wave energy converter extracts energy from the waves, by funnelling them to run-up a ramp and overtop into a reservoir. This water is stored at a higher level than the average sea surface, before being discharged through hydro turbines. The waves, device sea handling and overtopping flow are measured by pressure transducers ahead of, beneath and in the device. Comparisons of the distribution and correlation show that the measurements support the use of the algorithm for generating a simulated flow.

Keywords: Overtopping; Wave Dragon; Field Measurement; Time Series;

1. Introduction

Much of the existing literature on overtopping flow (e.g. Van de Meer and Jansen [1], and Franco et al [2]) has investigated flow over breakwaters and dams. These have developed and tested models for both the time average rate of discharge and the distribution of these flows. As the interest has been in coastal defence structures these have always high crest freeboards and therefore low flow rates. For Wave Energy utilisation where maximum flow rates are desired low crested structures (where the crest level is comparable to or lower than the significant wave height) are optimum. In this case detailed work has only studied the average rate of overtopping, as in Kofoed [3]. This paper aims to fill this gap in the literature by considering the distribution of overtopping flow on a low crested structure.

An advancing branch of wave energy is that of the overtopping type device, gathering the energy by waves overtopping into a raised reservoir, and extracting this by draining the water through low head turbines. This principle is shown in Figure 1. When modelling the power capture of such devices a set of equations is used to

generate a time series of the flow into the reservoir. This allows design of the geometry of the reservoir, and the turbines to be used, and the optimal control strategy to use on these. It is therefore crucial that this simulated flow into the reservoir is accurate. Such simulations have been based on theory developed and tested for overtopping on higher relative crest freeboard structures.

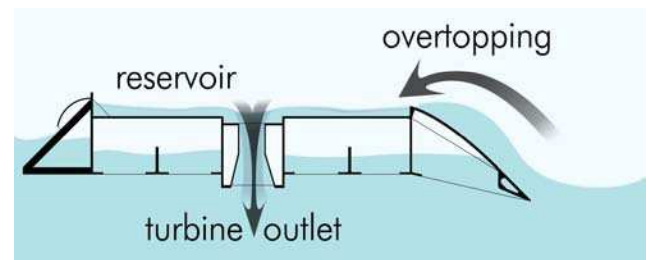

Figure 1. Overtopping Principle

The Wave Dragon device is by far the most developed of the overtopping type of devices. The layout of the device is shown in Figure 2. The device consists of three main components:

- Two wave reflectors. Attached to the central platform these act to focus the incoming waves. Laboratory tests have verified numerical

simulations showing their effect of increasing the wave height. They improve the energy captured by approximately 100 % in typical wave conditions, Kramer and Frigaard [4].

- The main platform. This is a floating reservoir with a double curved ramp facing the incoming waves. The waves overtop the ramp which has a variable crest freeboard 1 to 4 m. Underneath the platform open chambers operate as an air cushion maintaining the level of the reservoir.
- Hydro turbines. A set of low head Kaplan turbines converts the hydraulic head in the reservoir. These turbines are attached to PMG allowing variable speed operation. The produced electricity is converted using AC/DC/AC power electronic converters to the grid frequency.

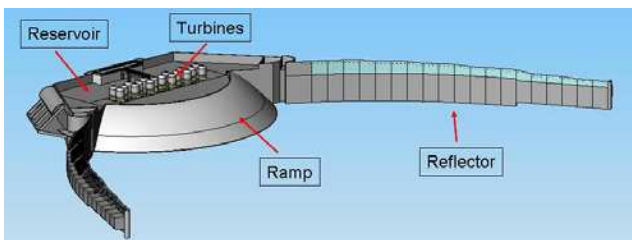

Fig 2. Layout of the Wave Dragon device

Since April 2003 a 1:4.5 scale device has operated in an inland sea in Northern Denmark. The project and results are described fully by Kofoed et al [5], and Tedd et al. [6]. During a storm on October 26, 2006 the prototype was used solely for purposes of measuring overtopping flow distribution. These results are presented. This is a test at almost full scale, in that the scale effects (due to surface tension) seen in the laboratory setting will be insignificant.

2. Instrumentation

The measurements for this study have all been taken on the Wave Dragon Prototype device, shown in Figure 3, at location in Northern Denmark. The wave climate at the fairly sheltered site allows for an approximate scale 1:4.5 to the North Sea. Water depth at the site is around 6 m.



Fig 3. Wave Dragon prototype operating in Nisum Broads, Northern Denmark

In order to measure the flows over the ramp of the device and compare to the model the following measurements have been made:

- Incoming wave climate – measured at the mooring point, around 60 m ahead of the device, by a pressure transducer approximately 1.5 m below the water surface.
- Water level in the reservoir –three pressure transducers mounted to the floor of the reservoir, measure the water in the reservoir.
- Crest freeboard – three pressure transducers mounted below the reservoir measure its floating height.
- Turbine outflow – measurements of the rotational speed and the head across a turbine allow calculation of the flow according to the turbine characteristic.

All measurements are sampled at 10 Hz. To check for possible spilling water from the reservoir inclinometers measure the tilt of the device Heel (Front to back) and Trim (Side to side). In the records taken during this period the volume of water in the reservoir level has been kept very low to avoid any spill.

The results from the pressure transducers on the device are low pass filtered in order to reduce error effect in the signal. This is implemented by a time domain digital filter, in order to preserve the phase information of the signal. Table 1 shows the exact parameters of this filter, and Figure 4 shows them graphically compared to the frequency distribution of incident waves. For transducers in the reservoir the low pass cut-off frequency was chosen as 0.4 Hz. This retains the frequency components present in the incident waves, but cuts off the higher frequency components, associated with cross waves within the reservoir. The transducers beneath the reservoir have a lower cut-off level, below the predominant wave frequencies at 0.15 Hz. This is chosen as frequencies component at the incident wave frequencies are likely to reflect waves passing under the structure. Lower frequencies are kept as they are important, showing the slow movements of the platform in terms of Heel, Trim and Floating Level. Figure 5 shows the measured and filtered signal for one of the pressure transducers within the reservoir.

Table 1. Filter settings for pressure transducers

Transducer location	Reservoir	Beneath device
Low pass cut-off frequency [Hz]	0.4	0.15
Filter length [-]	1024	1024
Sample frequency [Hz]	10	10

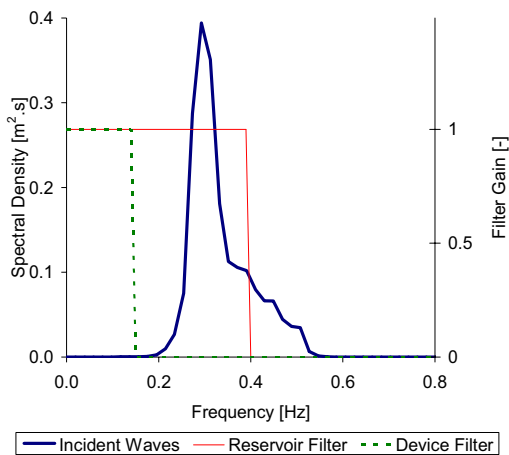

Fig 4. Frequency spectrum of incident waves for Record 3, and transducer low pass filter gains.

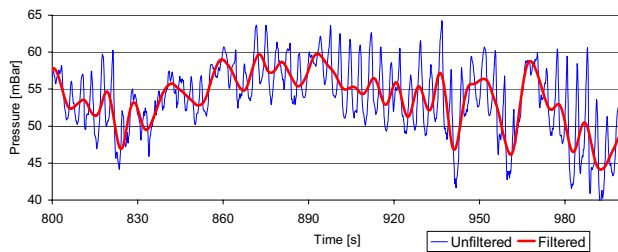

Fig 5. Filtered pressure transducer reading for a transducer beneath reservoir. Taken during Record 3, see Table 2.

The field measurements presented here were all taken during a storm build up on October 26th 2006. At this time the turbine strategy of the Wave Dragon was set to keep the reservoir safely below the full point to prevent spill from the reservoir. The buoyancy strategy aimed for a low floating level to give high levels of overtopping. This is not the optimum for energy capture, but allows the best testing of the overtopping flow. Figure 6 shows the storm build up, in terms of the significant wave height H_s and the average flow overtopping the device.

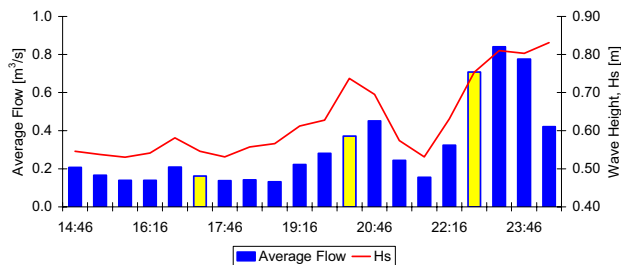

Fig 6. Storm build up on October 26th 2006. Highlighted records are used in this analysis.

Three different operating conditions can be seen in the three records chosen. These records are used for illustration in this paper. The other records give

comparable results. Table 2 presents statistical details of these records. Record 1 with the lowest waves and highest relative crest freeboard, will have less frequent and smaller overtopping. Record 3 has larger waves and a crest freeboard close to the optimum point for energy capture (R_c between 0.6 and 0.7), so will have large volumes of water overtopping regularly. Record 2 is chosen to be between these two.

Table 2. Statistics of measured records.

Record number:	1	2	3
Start time:	17.16	19.46	22.46
Significant wave height: H_s [m]	0.55	0.63	0.75
Peak wave period: T_p [s]	2.8	3.2	3.4
Relative crest (average): R_c/H_s [-]	0.98	0.86	0.68
Average flow: \bar{Q} [m ³ /s]	0.16	0.28	0.71

3. Overtopping theory

For some overtopping structures (e.g. high crested structures [1] and simple geometry low-crested structures [3]) approximate guidelines for the average rate of overtopping exist. These are based on theory and tested in laboratory and field scale. As the geometry of overtopping wave energy converters can often be complex and the volume overtopping in a given sea state is essential to know, laboratory tests are routinely conducted.

To model the power flows of overtopping wave energy converters it is usual to make a simulation programme. According to a given probability distribution a time series is constructed of the overtopping flow into the reservoir of the device. This allows design and optimisation of the turbines within the reservoir, to ensure best performance from the overtopping flow. The simulation model is used on both the Wave Dragon [6] and the Wave SSG (another overtopping type device) [7]. It uses the following basic method, based on the distributions specified for the high-crest freeboard case [1].

The time series is split into discrete events each of length T_m (the mean wave period). These events are considered totally independent of each other. The probability of overtopping is given by:

$$P_{OW} = \exp \left[- \left(\frac{1}{c} \frac{R_C}{H_S} \right)^2 \right] \quad (1)$$

Where:

- P_{OW} Probability that overtopping occurs in the given event.
- R_C Relative crest freeboard [m].
- H_S Significant wave height [m].
- c A constant.

The value of the constant c determines the spread of the overtopping, a larger value of c will give a higher probability of a given wave overtopping and thus make the overtopping more even. Van de Meer [1] suggested a value of c of 1.62 to be used for surging waves. In simulations made to date [6 and 7] a value of 1.21 has been used for these overtopping devices. The justification for using this value is not evident. Simulations using a value of 1.21 have been tested against laboratory data [3] and checked to be reasonable. However this study in a scale of 1:50 was only able to resolve to groups of 10 waves so was not able to investigate in detail. It is possible that a value of c larger than this may be applicable, as many wave devices have modifications to improve the bandwidth of the overtopping, such as the patented double curved ramp of Wave Dragon.

In the model, if overtopping occurs the actual volume in the given event follows a Weibull distribution with shape Factor 0.75, scaled to fit the average overtopping volumes:

$$P_V = P(\underline{V} \leq V) = 1 - \exp\left[-\left(\frac{V}{a}\right)^{\frac{3}{4}}\right] \quad (2)$$

$$\text{With: } a = 0.84 \frac{T_M \bar{Q}}{P_{OW}} \quad (3)$$

Where

- P_V Probability of overtopping volume \underline{V} begin less than or equal to V .
- V Overtopping volume [m^3].
- T_M Average Wave Period [s].
- \bar{Q} Average overtopping flow [m^3/s].
- P_{OW} Probability of overtopping, see equation (1)

The volume for a certain exceedance probability ($1 - P_V$) is given by:

$$V = a[-\ln(1 - P_V)]^{\frac{4}{3}} \quad (4)$$

4. Results

The three records shown in Table 2 are presented in these results. Other records have also been analysed, giving similar results.

4.1. Overtopping time history

Figure 7 shows the overtopping rate for the first of the records. This compares the measured data of the overtopping flow, to two simulated time series. Both flow and time axis are normalised to allow easier comparison. The flow has been averaged over lengths of five mean wave periods. This length is chosen as with finer time resolution the recorded overtopping data shows too much variability, with coarser time resolution more

information is lost. There are still some negative flows, which are erroneous, as there was no spill during the samples. The reason for this could be either cross waves in the reservoir, motions of the platform at the wave frequencies, or start-up errors in the turbine flow not described by the turbine characteristic. These effects can be considered to be similar to white noise on top of the measured data, increasing its variance.

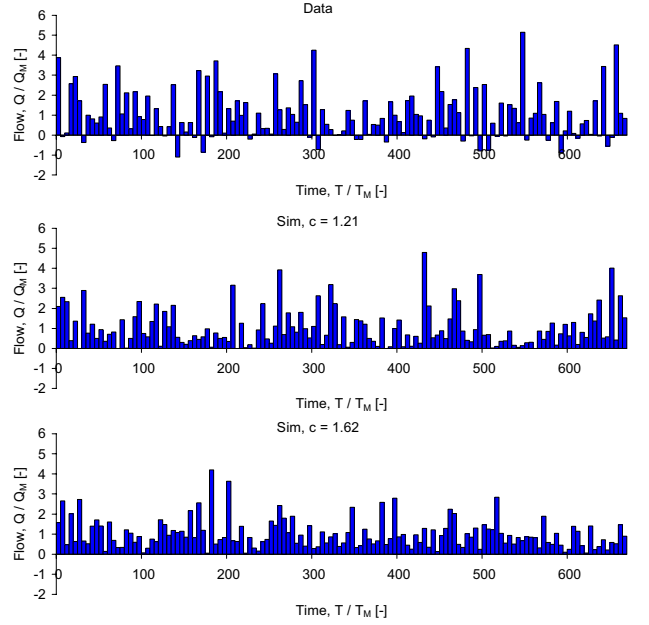

Figure 7: Comparison of measured overtopping flow data of Record 1 to simulated overtopping flow with c values of 1.21 and 1.62, averaged rates of periods of $5 T_M$.

Comparison of the three plots shows that the simulations fit fairly well to the measured data. The measured data seems to be slightly more variable than the simulated records. As expected the simulation with the higher value of c shows a slightly lower variance.

4.2. Overtopping distribution

Figures 8a-c show the distribution of the overtopping waves for the three records. As with Figure 7 the overtopping flow is averaged over periods of 5 wave periods. These samples are sorted and drawn to show the probability distribution of the overtopping event. The flow axis is normalised by the average flow to allow comparison between the records. For each record the measured data is compared to simulated data generated with the same parameters as given in Table 2.

These figures support the use of the overtopping simulation as defined by equations 1 to 4 as the basic shape of the distribution shown by the measured is similar to that shown by the simulated data. Record 3 shows the closest comparison between measurements and simulation, here the crest freeboard is low and therefore

many waves overtop, giving the least variable flow. Record 2 and 1 are less closely matched. This may be caused as Record 3 has a higher overtopping flow rate, so the inaccuracies in the measurement are proportionately lower. Record 3 is also the most interesting as it is closest to the preferred relative crest freeboard for energy capture

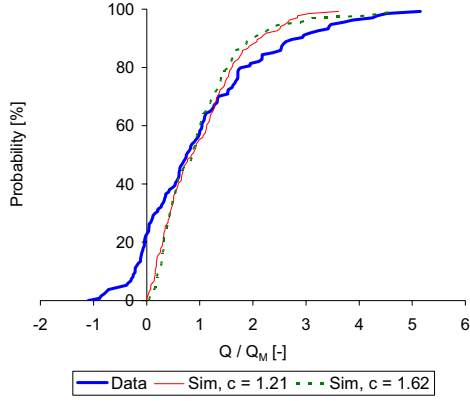

Figure 8a: Flow probability distribution, Record 1.

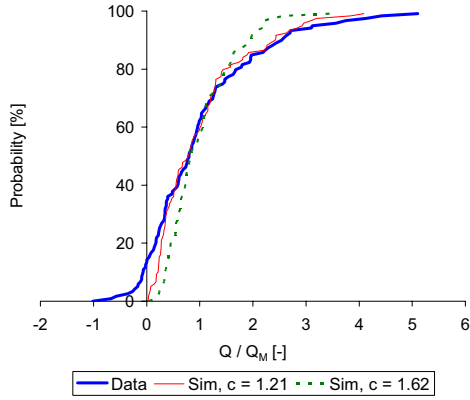

Figure 8b: Flow probability distribution, Record 2.

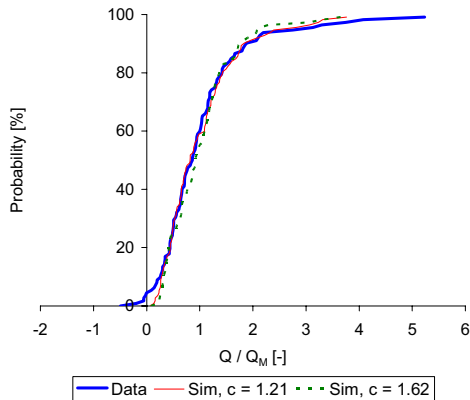

Figure 8c: Flow probability distribution, Record 3.

These results do not provide clear justification to choose a value of c , or even to show a preference between

the two values plotted. The effect of errors in the measured data (acting comparably to a superimposed random signal) is that the measured signal will be more variable and so compare better to a lower value of c . This may be the effect which is shown in Figures 8a-b. With this information using a value of c of 1.62 is suggested as it is better justified in the literature. It should be noted that using a value of c of 1.62 is not (in terms of power production) the most conservative value to use.

4.3. Independence of waves

An assumption within the simulation model is that each overtopping event is independent of the next one. There are some physical reasons why this may not be the case, which could suggest correlation or anti-correlation, such as:

- Wave Grouping – this phenomenon is much studied in ocean waves, whereby large waves come in groups. However the extent to which this happens is debated away from the near shore region.
- Run-up interference – the non-overtopping run-up water could interfere with the next wave while returning down the ramp, the effect of this may be unclear.
- Platform buoyancy – once a large wave has entered the reservoir, it will float lower in the water. Therefore the next wave has a lower ramp to overtop, so will overtop a larger volume.

To test this assumption of independence the autocorrelation function of the overtopping flow is calculated. In this case the flow signal is averaged over periods of one wave. This is finer resolution than used earlier as the phenomena may only occur on this short timescale. Additionally the calculation performs a lot of averaging, thereby losing the white noise effect. The autocorrelation function for the flow is given by:

$$R_{QQ}\left(\frac{\tau}{T_M}\right) = \frac{E\left[\left(Q\left(\frac{t}{T_M}\right) - \bar{Q}\right) \cdot \left(Q\left(\frac{t-\tau}{T_M}\right) - \bar{Q}\right)\right]}{\sigma_Q^2} \quad (5)$$

Where:

- Q Overtopping flow at time t [m^3/s].
- τ Correlation time[s]. This is non-dimensionalised by mean period T_M .
- σ_Q Standard deviation of overtopping flow.

Figures 9a-c show the autocorrelation function for the three records. These are compared to the values from the simulation (where the constant c is 1.62). In this formulation of the autocorrelation function a value of 1 is totally correlated, and a value of 0 is totally uncorrelated.

Values between 0 and 1 show some degree of correlation and negative values show anti-correlation.

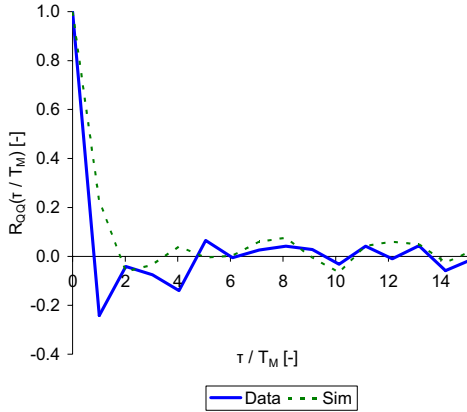

Figure 9a: Autocorrelation function, Record 1.

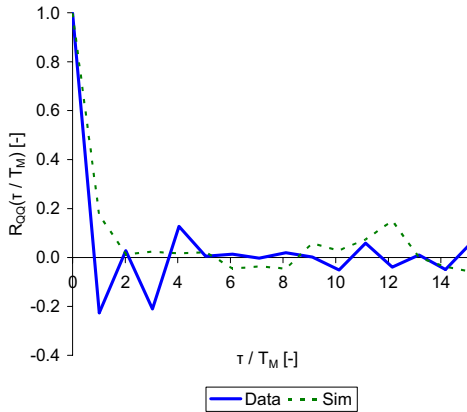

Figure 9b: Autocorrelation function, Record 2.

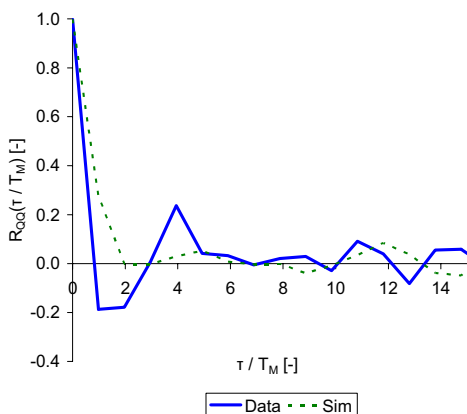

Figure 9c: Autocorrelation function, Record 3.

The autocorrelation of the simulated signal should show what a random signal should give, as the wave overtopping events are independent. Some correlation (0.2 to 0.3) for 1 mean wave period. This is an effect

caused as the averaging method has cut the signal into mean volumes at a time different from that at which they were generated. Therefore each group of length T_M contains parts of two overtopping waves. In the process this was chosen deliberately as this effect would surely occur for the measured data. The autocorrelation function of the simulated flow beyond two mean wave periods can have no correlation. The shown level between -0.1 and 0.1 is the uncertainty as the signals are not so long.

For all three signals moderately strong anti-correlation (around -0.2) may be seen in the measured data at 1 mean wave period. There seem to be some effects occurring up to 4 mean wave periods. Over a longer time span than this the measured results compare closely to the Simulation results with levels between -0.1 and 0.1. It is possible that either this is a real correlation effect, or that it is an effect similar to aliasing within the measured data. As has been said earlier, as the data is imperfect it is unwise to draw a firm conclusion.

It is relatively simple to include correlation into the overtopping simulation work. This may be done as shown in equation 6, where each overtopping event is affected by the previous one:

$$Q_{N_c} = (1 - R)Q_N + RQ_{N-1} \quad (6)$$

Where:

- Q_N Simulated flow for N^{th} wave.
- Q_{N_c} Simulated flow for N^{th} wave including correlation.
- R Correlation coefficient for one mean wave period.

In this formulation to make a simulation give the same anti-correlation as seen in the measured data a value of R of between -0.4 and -0.5 would be required. With such a high correlation, the change to the distribution of the overtopping events must be considered. Correlation will probably tend to decrease the performance of the device. The device must deal with either large waves following each other, or longer period without significant overtopping. Conversely anti-correlation would tend to improve performance, spreading the overtopping events more evenly. Until this can be further investigated it is suggested to consider the events as un-correlated to be conservative.

5. Further Work

This paper has presented overtopping results from the Wave Dragon prototype. The scale of this device has allowed finer time detail to be measured than is possible in a laboratory scale. Currently the Wave Dragon prototype is out of operation so further measurements could not be made. In the next years ocean scale units are due to be deployed of the Wave Dragon device off Pembrokeshire in Wales, and the Wave SSG device on

the Isle of Kvitsøy in Norway. Both of these projects are supported by European research grants. Therefore it is suggested that an area of study of these is in the overtopping distribution. For effective measurement many pressure transducers (or other level gauges) must be included within the reservoir. Consideration should be given early in the design stage to reduce noise (from cross waves and the like) and to ensure durability of the instruments.

A second follow on study should be based on the power simulation programmes which use the overtopping distribution as their starting point. As well as using the simulation to optimise the device parameters (turbine capacity and control, reservoir geometry etc...) the simulations should test the sensitivity to a change in the input parameters. The two considered in this paper are the distribution of the overtopping events (by altering constant c) and the independence of the overtopping events as shown in equation 6. Until further study has been made of the hydro-dynamics, it can be recommended that a power train set up which is insensitive to these input differences is preferable.

6. Conclusions

This paper has presented a study of overtopping flow series on the Wave Dragon prototype, a low crested device designed to maximise flow, in a real sea. The study was made during a storm build up in October 2006, and three records with varying parameters have been closely analysed. Due to measurement inaccuracies (caused by cross waves in the reservoir, motions of the platform at the wave frequencies, or start-up errors in the turbine flow) the time resolution of the measured flow data was limited to spans of five mean wave periods. For each Record presented the measured flow has been compared to a simulated flow (constructed with the same parameters) in order to assess the simulation technique.

The first comparison tested the distribution of the measured data compared to the distribution of the simulated flow. The results support the distribution of the measured overtopping. However as the time resolution is limited the precise coefficients to use can not be specified by this study. In the case of constant c (equation 1), which fines the likelihood of overtopping it is recommended to use a value of 1.62 which is based on previous literature [1].

The second comparison tested the autocorrelation of the overtopping flow. This measured data was compared to a simulation constructed of independent events. The measured data showed some anti-correlation over a time span of one average wave length. This could be a real phenomenon, or an aliasing effect. To be conservative it is recommended to use an uncorrelated simulation.

Acknowledgements

The Wave Dragon prototype project has only been possible with generous support funding from the European Commission (Contract No: ENK5-CT-2002-00603), Danish Energy Authority, Elkraft System (PSO Funding), The Obel Family Trust and the dedication of the participating partners

The first author is a research fellow funded by the Marie Curie WaveTrain research training network.

Further Information

For further information on the Wave Dragon wave energy converter please see the project website: www.wavedragon.net

References

- [1] Van der Meer, J.W., and Janssen, J.P.F.M. Wave Run-up and Wave Overtopping at Dikes. In: Kobayashi, N. and Demirbilek, Z., (eds) Wave Forces on inclined and vertical wall structures, pp 1-27, ASCE. Also Delft hydraulics, Publ. No 487. 1994.
- [2] Franco, L., de Gerloni, M., Van der Meer, J.W. Wave Overtopping on Vertical and Composite Breakwaters. Proc. 24th Int. Conf. Coastal Eng., Kobe, Japan 1, 1030-1044. 1995.
- [3] Kofoed, J.P. Wave Overtopping of Marine Structures – Utilization of Wave Energy, PhD thesis, Aalborg University. 2002.
- [4] Kramer, M. and Frigaard, P. Efficient Wave Energy Amplification with Wave Reflectors. Proceedings of the 9th ISOPE conference, 2002.
- [5] Kofoed, J.P., Frigaard, P., Friis-Madsen, E. and Sørensen, H.C.. Prototype testing of the wave energy converter wave dragon. Renewable Energy 31, 2006.
- [6] Tedd, J., Kofoed, J.P. Knapp, W., Friis-Madsen, E. and Sørensen, H.C.. Wave Dragon, prototype wave power production. World Renewable Energy Congress IX proceedings, Florence. 2006.
- [7] Jakobsen K. P. and Frigaard P.: User's Manual for the Program Wave Dragon – Power Simulation, Hydraulics and Coastal Engineering Laboratory, Aalborg University. November 1999
- [8] Meinert, P., Gilling, L., and Kofoed, J. P.: User manual for SSG Power simulation 2. Hydraulics and Coastal Engineering No. 44, ISSN: 1603-9874, Dep. of Civil Eng., Aalborg University, June 2006.

Short term wave forecasting, using digital filters, for improved control of Wave Energy Converters

Peer-reviewed conference paper

**Presented to the Seventeenth (2007) International Offshore
and Polar Engineering Conference, Lisbon, Portugal
(030707)**

**Published in the proceedings
ISBN 978-1-880653-68-5
Vol 1. pp 388-394**

Tedd J., Frigaard P.

Thesis author's contribution

The thesis author is the main author of this paper. He detailed the method, constructed the filters and tested their performance using data gathered in his work on the Wave Dragon Nissum Bredning prototype. Co-author Frigaard assisted by showing the comparable method used for wave tank reflection analysis, and with plenty of inspiration.

Short term wave forecasting, using digital filters, for improved control of Wave Energy Converters

J. Tedd, P. Frigaard

Department of Civil Engineering, Aalborg University
Aalborg, Denmark

ABSTRACT

This paper presents a Digital Filter method for real time prediction of waves incident upon a Wave Energy device. The method transforms waves measured at a point ahead of the device, to expected waves incident on the device. The relationship between these incident waves and power capture is derived experimentally. Results are shown from measurements taken on the Wave Dragon prototype device, a floating overtopping device situated in Northern Denmark. In this case the method is able to accurately predict the surface elevation at the device 11.2 seconds before the measurement is made. This is sufficient to allow advanced control systems to be developed using this knowledge to significantly improve power capture.

KEY WORDS: Wave Energy Converter; Wave Dragon; Control; Wave Prediction; Real Time; Digital Filter.

INTRODUCTION

Time domain digital filters can be used to transfer a measurement of the waves ahead of a structure to a real-time prediction of the waves in the near future. Knowledge of the forcing, overtopping or other excitation caused by the next few waves may be used for fast control of a device. Studies show such a prediction can improve energy capture by 5 % (Tedd et al, 2005).

This paper describes the general theory and application of this, and presents results from a specific case study of implementation on the Wave Dragon machine.

Wave Dragon is a floating wave energy converter (WEC), extracting energy principally by means of overtopping of waves up a ramp and into a reservoir. Potential energy of the water at the higher head is extracted by several turbines within the reservoir. There is a fully automated, real sea prototype of the device deployed in Northern Denmark. Here the turbines are controlled to turn on and off in a cascading sequence to maintain the water level in the reservoir. This fast acting control could be improved with knowledge of the incoming overtopping flow.

Results are presented from a study on the Wave Dragon prototype. The

incident waves are measured by a pressure gauge several wave lengths ahead of the device. Pressure gauges within the reservoir, combined with the known turbine discharges give the time record of the overtopping flow.

Waves measured by a pressure sensor 52 m from the device are transformed (using Linear Wave theory) to elevations at the ramp. The non-linear transfer function from these to the run-up and overtopping rate can be generated experimentally. The results show the trade off between accuracy and time length of the digital filter, to give some recommendations for how to best implement this method.

WAVE DRAGON

Principle and Components

The Wave Dragon consists of three main components:

- Two wave reflectors. Attached to the central platform these act to focus the incoming waves. Laboratory tests have verified numerical simulations showing their effect of increasing the wave height. This has been shown to improve the energy captured by approximately 100 % in typical wave conditions by Kramer and Frigaard (2002).
- The main platform. This is a floating reservoir with a double curved ramp facing the incoming waves. The waves overtop the ramp which has a variable crest freeboard 1 to 4 m. Underneath the platform open chambers operate as an air cushion maintaining the level of the reservoir.
- Hydro turbines. A set of low head Kaplan turbines converts the hydraulic head in the reservoir into electricity.

Waves overtopping the ramp fill the reservoir with water at a higher level than the mean sea level. This head of water is used for power production through the specially designed hydro turbines. Fig. 1 shows the device layout and components. A thorough description of the principle can be found in Kofoed et al. (2006).

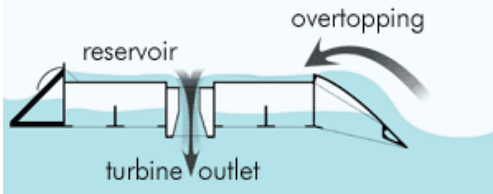

Fig. 1: The basic principle of the Wave Dragon. The computer image above shows the double curved ramp facing waves approaching from the bottom right. The filled reservoir has turbines placed roughly in the centre. The slender wave reflectors focus the wave energy towards the ramp. The lower schematic shows the overtopping flow filling the reservoir, and turbines extracting the power when draining the water back to the sea.

Prototype testing

Since April July 2003 testing has been conducted on a 1:4.5 scale prototype Wave Dragon in real sea environment at Nissum Bredning, in Northern Denmark. A scale of 1:4.5 was chosen as the wave climate within the area corresponds well to a 4.5 scaled down version of the North Sea wave climate. The prototype tested is built in steel and has a total mass (including water ballast) of 237 tonnes, and its length between reflector tips is 58 m. Fig. 2 shows the device in action.

The device is an automatically controlled and grid connected power plant. The conclusions of testing show the power capture of the device has reached expectations, and the availability has exceeded expectations, as reported in Tedd et al. (2006).



Fig. 2: Waves overtopping the ramp of the Wave Dragon prototype in Nissum Bredning, Northern Denmark.

In this paper the results are taken from measurements taken on the 26th October 2006, details are outlined in Table 1. The control of the device was altered, to ensure only a minimal water level in the reservoir. This is not the optimal for power production. However it allows the best measurement of the overtopping into the reservoir as spill from the reservoir is kept to a minimum.

Table 1. Sea state data for the 30 minute test series used.

Name	061026_WD_17
Date and start time	26 th Oct. 2006, 22.46
Significant wave height, H_s [m]	0.75
Peak wave period, T_p [s]	3.4
Average water depth, z [m]	6.08

Overtopping flow is measured by considering the change in reservoir volume (measured with pressure transducers mounted to the reservoir floor) and the turbine flow out of the reservoir (calculated from the turbine characteristic, see Knapp, 2005). The incoming waves are measured with a pressure transducer mounted to a pile which the device is moored to. This pressure transducer is mounted 3.98 m above the sea bed as shown in Fig 3. The device is 52 m from the pile, in the wave propagation direction as shown in Fig. 4.

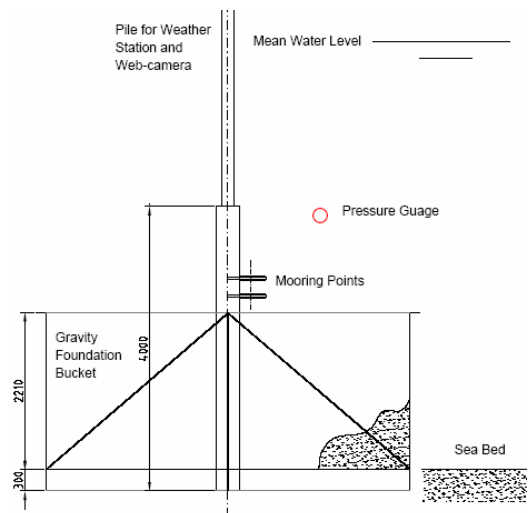

Fig. 3: The pile and bucket mooring of the Wave Dragon. The red circle shows the position of the pressure transducer used for wave measurements. It is mounted 3.98 m from the seabed and 1.5 m from the pile.

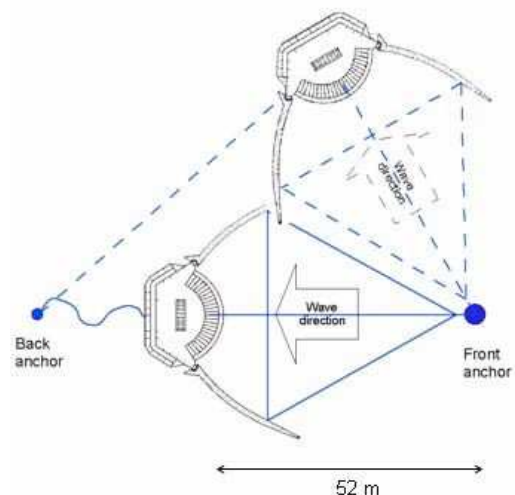

Fig. 4: The mooring of the Wave Dragon. The waves are measured at the front anchor, as detailed in Fig.3. The device is allowed to weather-vane, so the ramp is always 52 m from the anchoring pile in the wave direction.

Device Control

Improved control algorithms are very valuable, as for no extra capital cost or maintenance cost they can improve the performance of a device, effectively free extra energy capture. Therefore this is an area which currently is a major focus of research work. On the basic level, as with several other WECs, Wave Dragon has two control loops. A slow acting control loop is used to tune the device to the current sea state. A much faster acting control strategy is used to extract the maximum energy from wave to wave

The aim of the long period control is to regulate the floating height of the Wave Dragon to the optimal level for the sea state. This aims to maximise the power flowing over the ramp. A lower floating level will have more flow but at a lower head, and a higher floating level will have lower flow but a higher head – the optimum must be found. The time scale of the sea states increasing is of the order of a few hours, therefore the platform can also change its buoyancy at a similar rate. The input to this control strategy is the current, or future sea state which can be measured directly in the region of the Wave Dragon, or predicted based on weather forecasts.

The method for controlling the floating level of the platform is by blowing air into, or venting air from, open compartments beneath the reservoir. Due to the free surface of the reservoir this can be compared to balancing a tray full of water. The layout of these compartments and the detailed strategy for filling them is crucial to maintain stability. For example if there is a large central compartment filled with air, and low buoyancy at the edges the device will be quite unstable. In general the more stable the platform is, the closer to full the reservoir can be, and so the more power will be generated.

The fast acting control aims to maintain a suitable water level within the reservoir. If the water level is too high, then large waves will not be able to be accommodated in the reservoir so there will be considerable spill from it. However if the water level is lower the head across the turbines is less so less power can be produced from the same water overtopping the ramp. Again an optimal level must be found.

The reservoir level is controlled by the low head turbines. They are controlled on and off in a cascade fashion using the cylinder gate. At a minimum reservoir set point, the first turbines cut-in. As waves fill the reservoir, the remaining turbines progressively start. At a maximum level all turbines are operational. The input for this can either come from pressure transducers within the reservoir itself giving the level, or from direct measurements of the power generated by the generators, from which the head can be inferred.

This paper provides a tool for further work on the use of predictive algorithms for control of the turbines dependant on the expected overtopping in the next few waves. By lowering the reservoir level when some large waves are expected, spill would be minimised. Also by maintaining a higher reservoir level when smaller waves are expected, less water would be discharged at a lower head. Initial studies have shown that implementing such predictive algorithms could increase power production by 5 % (Tedd et al, 2005).

DIGITAL FILTERS

Use of Filters

Digital Filters are a time domain method for filtering a signal. As with a frequency domain filter the desired gain and phase are selected as a

function of frequency. In the case of frequency domain filter, a multiplication in the frequency domain of the filter and the Fourier transformation of the time signal is made. The filtered frequency components are then Inverse Fourier transformed back to a time signal. This method loses the phase information and cannot be undertaken in real time. Therefore it does not give a useful result for this case. The Digital Filter operates by taking the Inverse Fourier transform of the gain and phase functions. A convolution of this time domain filter with the input signal gives the filtered output. This allows real time calculation and retains the phase information of the input signal.

Digital filters are a standard tool used in many areas of signal processing. The technique has been used in many offshore wave mechanics fields over the last years. Frigaard and Brorsen, 1995 gives a good introduction to the theory and presents a method for their use in separating incident and reflected waves.

When designing a Digital Filter several factors must be considered to ensure it functions well:

Filter Length N, the number of components in the filter. A longer filter will converge to zero further from its limits, giving a more stable filter. It will describe more input frequencies, so the errors between them are likely to be smaller. However a longer filter will have a longer time delay (see Eq. 1). This is a disadvantage for use in prediction where the extra time is effectively lost.

Time Increment of Filter Δt , the inverse of the sampling frequency of the filter. Together with the Filter length this defines the frequencies specified by the filter. A longer time increment will specify a span of lower frequencies (see Eq. 2). Careful selection of the time increment allows better definition of the most interesting frequencies. This will reduce errors caused at any discontinuities of the input signal.

The filter delay time:

$$\tau_{fd} = \frac{N \cdot \Delta t}{2} \quad (1)$$

The frequency increment of the filter:

$$\Delta f = \frac{1}{N \cdot \Delta t} \quad (2)$$

When designing a Digital Filter, these two parameters must be balanced to ensure the best performance.

An additional method to improve the performance of a filter is to apply a tapering function.. A typical cosine tapering function ensures that the start and end of the filter are zeroed, thus improving the filter's stability. The penalty is that the filter will not give a precisely correct result for the specified frequencies. It should improve the performance for intermediate frequencies. This is useful for situations with a continuous spread of frequencies, such as a wind driven sea.

Filter Design

The transformation of the waves from the pressure readings near the mooring pile (see Fig. 3) to the surface elevation at the ramp of the device can be split into two stages. The Gain function is due to transferring the waves from the pressure transducer to the surface elevation at the measuring point. The Phase function describes the dispersion of the wave frequencies as they travel from the measuring point to the ramp of the device.

The function for Gain is based on Linear Wave Theory, which provides Eq. 3 to relate the wave pressure at a depth h to the surface elevation. The actual function used in this case varies by up to 10 % to account for the affect of measuring the waves close to the bucket. This effect was quantified by Kramer and Kofoed, (2004) using a boundary element method. A maximum gain of 10 is used, the gain of higher frequencies is set to zero.. These higher frequencies are bound waves traveling at a lower carrier frequency, so would give inaccurate results.

$$\Delta Gain = \frac{\cosh k(z+h)}{\cosh kh} \quad (3)$$

The Wave number k is related to the wave length L by $k = 2\pi / L$. The wave length used is the intermediate water wavelength in water of depth z , found by iteration of Eq. 4 for angular wave frequency ω , where $\omega = 2\pi f$, and acceleration due to gravity g . With the prototype situated in water of depth $z \approx 6$ m and a full scale device to be in water of depth $z \approx 25$ m, neither the deep nor the shallow water approximations may be used.

$$L_1 = 2\pi g \left(\frac{1}{\omega} \right)^2 \tanh \left(\frac{2\pi z}{L_0} \right) \quad (4)$$

The phase shift is dependent on the time shift of the frequency component, as in Eq. 5.

$$TimeShift(\omega) = \tau_c - \tau_{fd} - \tau_r(\omega) \quad (5)$$

The Control time τ_c , is a variable chosen to enable the waves to be predicted at the ramp. The filter delay time τ_{fd} is defined in Eq.1. The time to travel $\tau_r(\omega)$ is the time a wave of that frequency takes to travel from the measurement point to the ramp. This is shown in Eqs. 6 and 7 with the wave traveling at phase velocity V_p over a distance D_M .

$$\tau_r(\omega) = \frac{D_M}{V_p(\omega)} \quad (6)$$

$$V_p(\omega) = \frac{L}{T} = \frac{\omega L}{2\pi} \quad (7)$$

The phase shift for the frequency component is then calculated using Eq. 8. A multiple of the harmonic number $n.\pi$ is needed to counteract the effect of the filter-delay which is half the length of the filter.

$$Phase(\omega) = [\omega \cdot TimeShift(\omega) + n.\pi] \quad (8)$$

Filter construction

The frequency spectrum of wave record 061026_WD_17 from Table 1 is shown in Fig. 5. The spectrum has a peak at a frequency of 0.3 Hz and has energy in the range from 0.25 Hz to 0.5 Hz. In the water depth at the prototype site this gives phase velocities V_p of between 3.1 ms^{-1} and 5.8 ms^{-1} , with the peak frequency traveling at 5.1 ms^{-1} . This corresponds to a time to travel τ_r over D_M of 52 m of between 9 s and 16.7 s with the peak frequency taking 10.2 s.

As the frequency of the waves is relatively low a time increment for the filter of 0.4 s is chosen, i.e. a sampling frequency of 2.5 Hz. The sampling frequency of the pressure measurement is 10 Hz. By down-sampling the wave shape is preserved, but the filter will not evaluate frequencies above 1.25 Hz. Therefore a shorter filter length can be used with the same frequency definition. This is acceptable, as from Fig. 5 it is clear that there is no energy above this frequency limit.

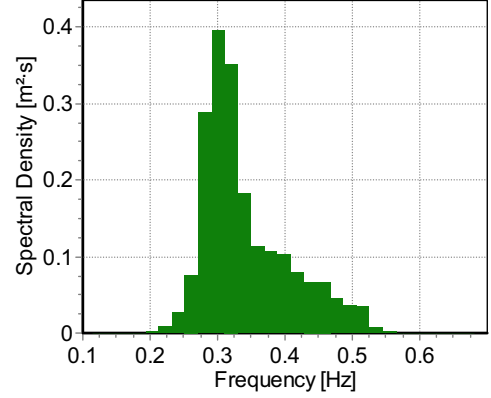

Fig. 5: Power spectrum of wave record 061026_WD_17 after transformation from pressure signal to surface elevation at measurement point.

A filter length of 64 has been chosen. This was chosen as a balance, giving a reasonable resolution of the frequencies used while not leading to too long a filter. In this case the filter delay time τ_{fd} is 12.8 s. If the filter was much longer then it would be impractical to use for predicting the waves. With a shorter filter the resolution of the frequencies would be too poor to be used.

The control time τ_c chosen is 24 s. This gives the output of the filter at 11.2 seconds before the time of the input at the measurement point. This was chosen to ensure that the main energy components of the filter are not too far to either end of the filter. This also allows some control of the device, using the predicted wave field.

A cosine tapering function was applied to the start and end 10 % of the digital filter in order to improve its stability.

Figs 6 and 7 show the Gain and Phase distributions for the sample. As well as the defined points these plots show the theoretical best curve, and the actual performance of the filter. The actual performance of the filter is calculated by measuring the gain and phase of the steady-state response of the filter to a monotonic sine wave, for small increments of frequency.

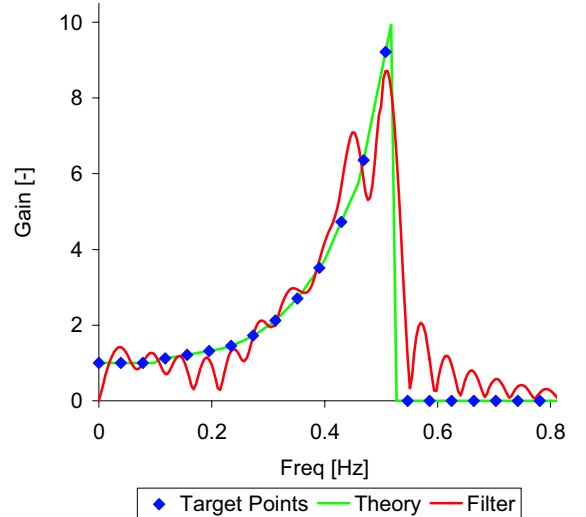

Fig. 6: Gain of Digital Filter. The target points, theoretical value and actual filter performance are shown.

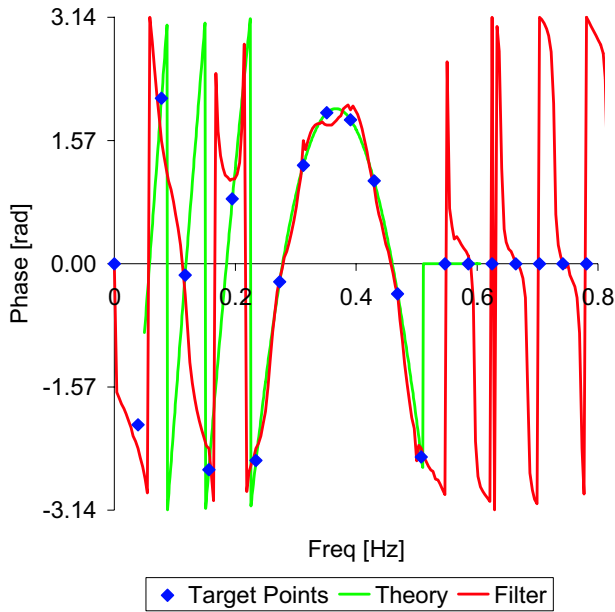

Fig. 7: Phase of Digital Filter. The target points, theoretical value and actual filter performance are shown.

Figs. 6 and 7 show the performance of the filter, i.e. how accurate it replicates the different frequencies which are occurring in the sea state. For the frequency band of interest, 0.25 Hz to 0.5 Hz, the specified filters fit very well to the data. There is some error with the gain, but this is minimized for the frequencies of interest. Outside the frequencies of interest there are large errors for the phase of the filter, this is due to very low amplification, so will not cause large problems. The response has been measured from an analysis of the filter shown in Fig. 8 and constructed as described above. Table 2 gives a summary of the properties of the wave signal and the digital filter.

Table 2. Properties of the Digital Filter and wave spectrum.

Spectrum frequency range	0.25 – 0.5 Hz
Distance to device, D_M	52 m
Time to travel, τ_{tr}	9 – 16.7 s
Filter time increment, Δt	0.4 s
Filter length, N	64
Filter delay, τ_{fd}	12.8 s
Control time, τ_C	24 s
Prediction time	11.2 s

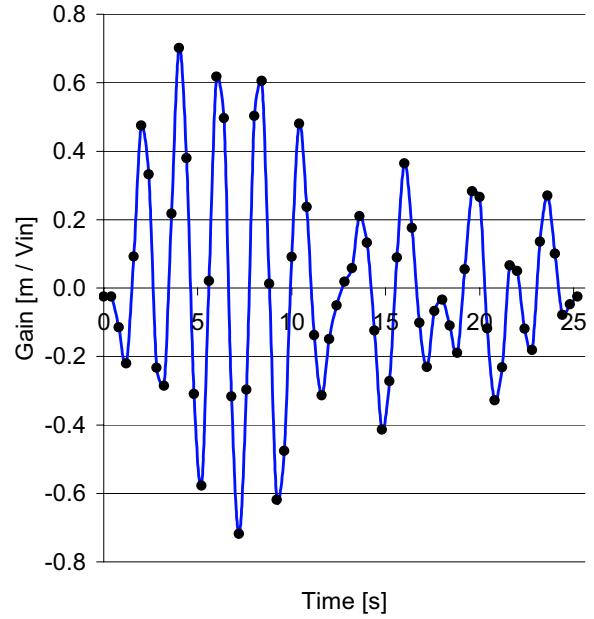

Fig. 8: The Digital Filter used. The method performs a convolution of the filter with the measured pressure signal to give the output wave at the device.

RESULTS

To validate the usefulness of this type of method for predicting waves two things are compared: the accuracy of the short predicting filter to predict the waves at the ramp, and how this can be used for predicting the power take off at the device (in this case overtopping rate).

To measure the wave height at the ramp, a capacitive wave gauge was set-up on the device. The custom made device consisted of several wires traced down the ramp, as the water ran-up and down the ramp the capacitance between the wires and the steel ramp would change. This was set up to be measured with a control box providing a high frequency oscillating current. Unfortunately, after successful laboratory tests of the equipment, and much time used in setting up and calibrating the system on-board, heavy weather and marine growth made the measurements of the run-up doubtful. Therefore a comparison is made in Fig 9 of the predictive filtered surface elevation at the ramp to the surface elevation calculated using a long and accurate filter (too long for predictive use).

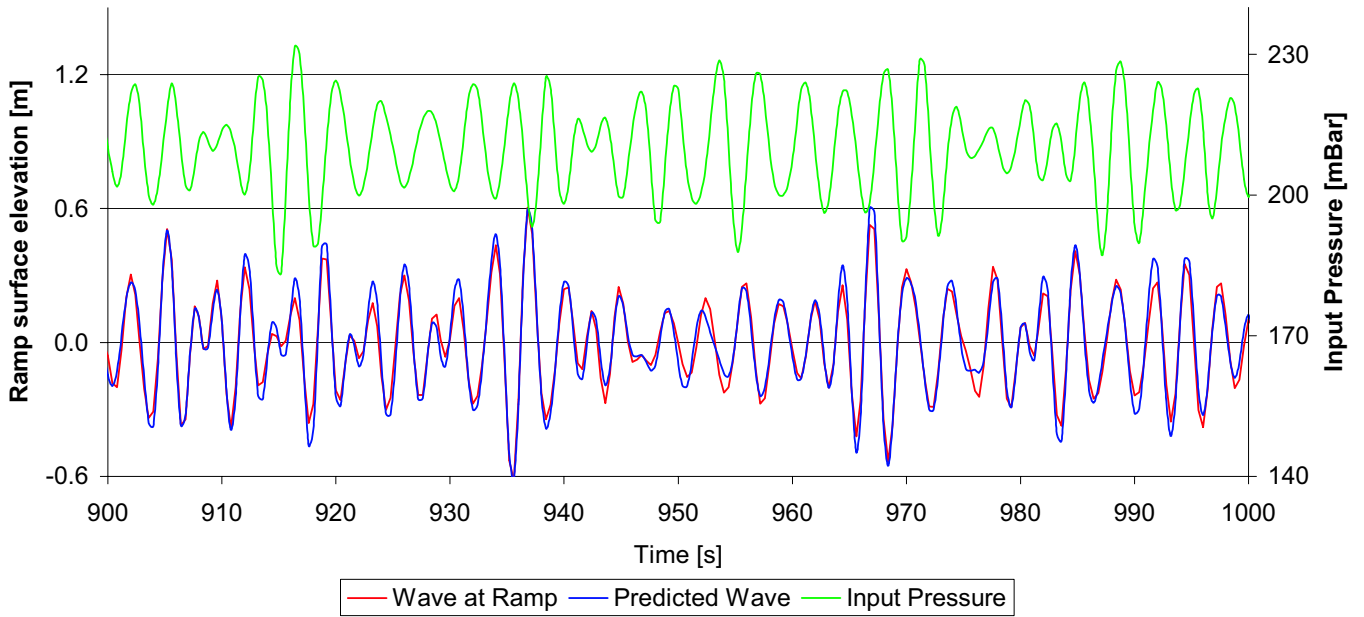

Fig. 9: The filtered wave. The characteristics of the input pressure at the measuring point can be seen in the transformed wave at the ramp of the device. The shorter filter, which uses prediction and allows knowledge of the wave form 11.2 seconds before the wave reaches the device compares well with the highly filtered wave.

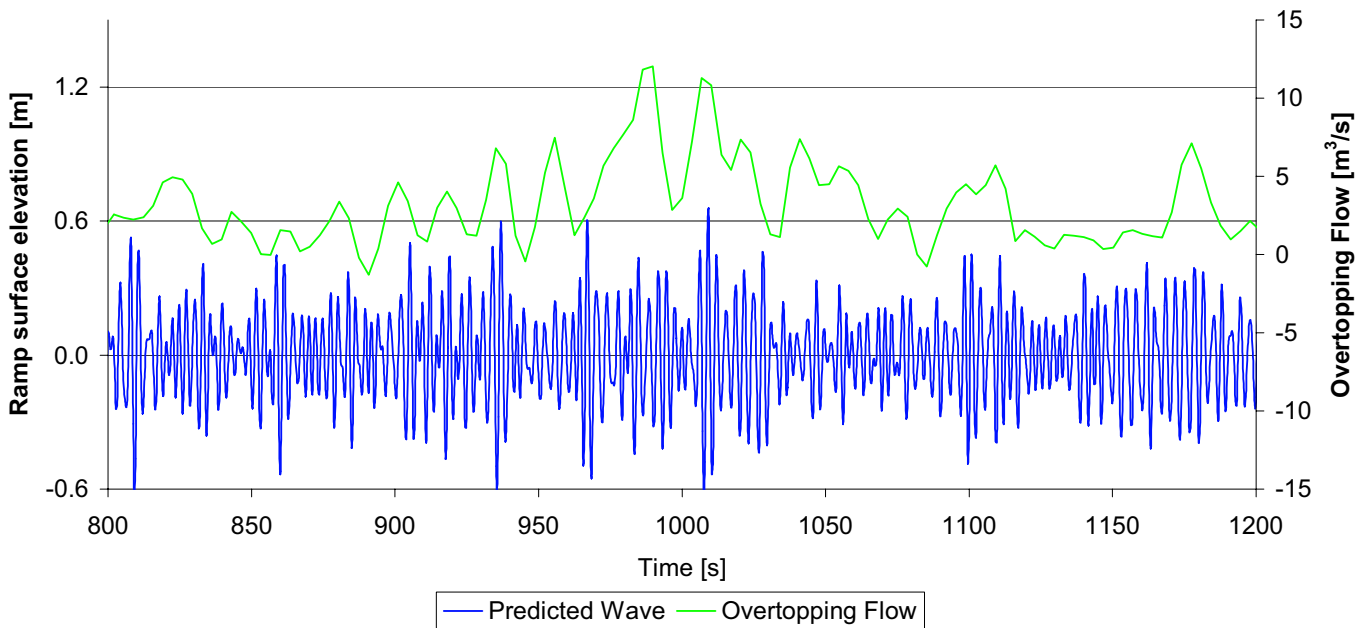

Fig. 10: Comparison of predicted surface elevation to overtopping flow. Some correlation between wave height and overtopping is evident. Unfortunately the time resolution of the overtopping flow is not very accurate.

As is seen in Fig. 9 the error in filtering using the shorter filter, with a prediction time of 11.2 seconds is very minor. There are some limitations to this; the wave transformation has been made using basic mono-directional linear wave theory assuming a horizontal sea bed. Therefore the effects of any irregularity or slope of the seabed, directionality of the waves, higher order effect, or wind generation of waves are ignored.

A more complicated system could be made including these. A similar digital filter method should also work on such a system.

In Fig. 10 the overtopping rate is compared to the predicted wave. A visual inspection shows some correlation here, but not much. It is suggested that this is due to other factors involved, such as the quasi-static state of the platform. This is expanded on further by Kofoed et al. (2007). Through comparing results from more test runs, a transfer function from incident wave to overtopping flow should be able to be made.

11.2 seconds is enough time to perform control on the device, in the current prototype this is enough time to open all the turbines and half empty the reservoir. Further work should be conducted to fully implement a control strategy using this extra knowledge.

A similar predictive control strategy could be used on all other wave energy devices. Potentially the most valuable could be on point absorbers with latching type control, where theory shows optimal control with full knowledge of incoming waves can improve performance by 100%.

CONCLUSIONS

A method for short term prediction of waves has been presented based on a pressure transducer and a Digital Filter. The results show it to be accurate in the conditions tested on the Nissum Bredning Wave Dragon prototype. A prediction time of 11.2 s was successfully achieved. This should enable better control of the turbines to increase power capture by the device.

ACKNOWLEDGEMENTS

The Wave Dragon prototype project has only been possible with generous support funding from the European Commission (Contract No: ENK5-CT-2002-00603), Danish Energy Authority, Elkraft System (PSO Funding), The Obel Family Trust and the dedication of the participating partners. The author is a research fellow funded by the Marie Curie WaveTrain research training network.

FURTHER INFORMATION

More information can be found on the project at the website www.wavedragon.net.

REFERENCES

- Frigaard P. and Brorsen M. (1995): "A time-domain method for separating incident and reflected irregular waves", *Coastal Engineering* 24 pp 205-215.
- Knapp W. (2005) "Report on the re- installation and calibration of the Wave Dragon turbines" Laboratorium für Hydraulische Maschinen, Technische Universität München.
- Kofoed J.P., Frigaard P., Friis-Madsen E. and Sørensen H.C. (2006) "Prototype testing of the wave energy converter Wave Dragon" *Renewable Energy*, Vol 31, pp 181-189.
- Kofoed J.P., Tedd J., Friis-Madsen E. and Nimskov M. (2007) "Influence of buoyancy control performance on power production by the Wave Dragon Nissum Bredning Prototype" *ISOPE 2007*. Lisbon, Portugal.
- Kramer M., and Frigaard P. (2002). "Efficient Wave Energy Amplification with Wave Reflectors" *ISOPE 2002*. Kitakyushu, Japan.
- Kramer, M. and Kofoed, J.P. (2004) "Placering af trukmåler til bølgemåling – Wave Dragon, Nissum Bredning". Aalborg University.
- Tedd J., Knapp W., Frigaard P, and Kofoed J. P. (2005) "Turbine Control Strategy Including Wave Prediction for Overtopping Wave Energy Converters" *CA-OE workshop*, Uppsala.
- Tedd, J, Kofoed J.P. Knapp W., Friis-Madsen E. and Sørensen H.C. (2006). "Wave Dragon, prototype wave power production." *Proceedings of World Renewable Energy Congress IX*, Florence.

Appendix 1: Data handling from the Wave Dragon Nissum Bredning prototype

The prototype device had been operating and recording data for 20 months prior to the author working with it. As there was continuous development work the data had not been systematically analysed during this period. Therefore one of the author's first tasks was to organise the data into a usable form. This appendix presents how the data has been handled so that the reader can clearly see what is behind the results presented in the thesis.

In the measuring period up to 84 sensors recorded continuously at 10 Hz. These included: pressure gauges (on the device, in the reservoir and measuring the waves); wind speed and direction gauges; strain gauges on the structure of the steel; force transducers in the mooring system; accelerometers and inclinometers measuring the platform movements; and power transducers measuring the speed, current and voltage at the turbines and to the grid. These readings are stored in 30 minute files, when uncompressed each requires computer memory of around 10 megabytes.

To process the data the author wrote a programme in Delphi which analyses each of these signals to generate a summary file. The summary file contains basic statistics (mean, max, min, standard deviation) for the main movements and forces measured. It also contains similar statistics for more complex values such as: the sea state; the overtopping flow; and the hydraulic, electric and estimated power. The author wrote a programme in Matlab to import this into a database, so that it is easily usable. The process is further details in the report by Tedd and Kofoed, 2006.

Wave Dragon have adopted a very open attitude to publishing, allowing wide access to their data and results, and the author should be contacted by any researcher desiring access. This has shown in the past to be a good long term strategy, encouraging closer co-operation with academic research groups.

Wave measurements

The waves at the prototype have been measured by a pressure transducer mounted to the mooring pile of the Wave Dragon. It is situated around 2 m below the mean water level as shown in Figure A1. The mooring point is approximately 52 m from the device, which is able to weather vane, so that it faces the predominant waves.

The signal from the pressure transducer is converted to a surface elevation using linear theory and accounting for the presence of the mooring bucket (using coefficients calculated from the numerical study of Kramer and Kofoed, 2004). The wave statistics presented in the results are: the significant wave height H_S calculated as the 0th spectral moment of the wave elevation signal H_{m0} , and the peak wave period T_P as given by peak the spectral analysis.

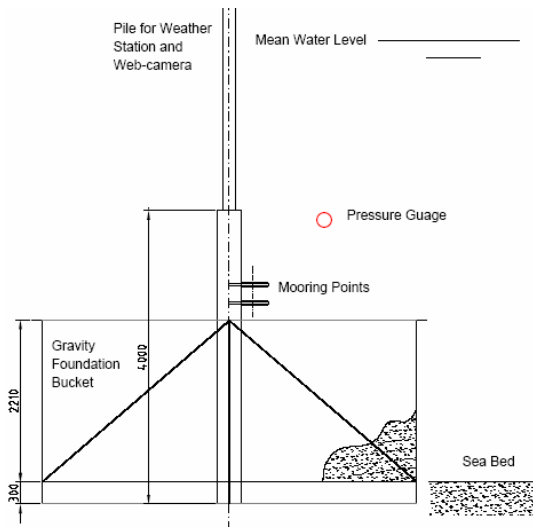

Figure A1, The pile and bucket mooring of the Wave Dragon. The red circle shows the position of the pressure transducer used for wave measurements. It is mounted 3.98 m from the seabed and 1.5 m from the pile. From Tedd and Frigaard, 2007.

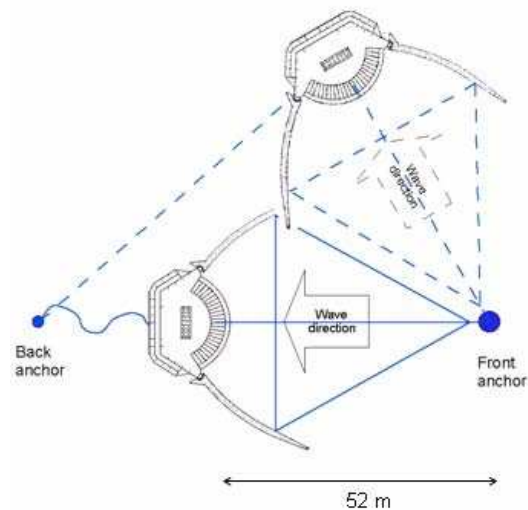

Figure A2, The mooring of the Wave Dragon. The waves are measured at the front anchor, as detailed in Figure A1. The device is allowed to weather-vane, so the ramp is always 52 m from the anchoring pile in the wave direction. From Tedd and Frigaard, 2007.

Concerns were raised that significant reflections from the Wave Dragon would effect the accuracy of the wave measurements. To test this, the author made a comparison of the wave height, at the measuring point for given wind direction, of results where the reflector wings were attached and not attached. The average wind speed and direction are calculated in a vector manner as described by Weber, 1997. Figure A3 shows the result for wind approaching from South West to West, where the longest fetch is. As there is no systematic difference between the wave readings, it may be concluded that the reflections have little effect on the wave height readings.

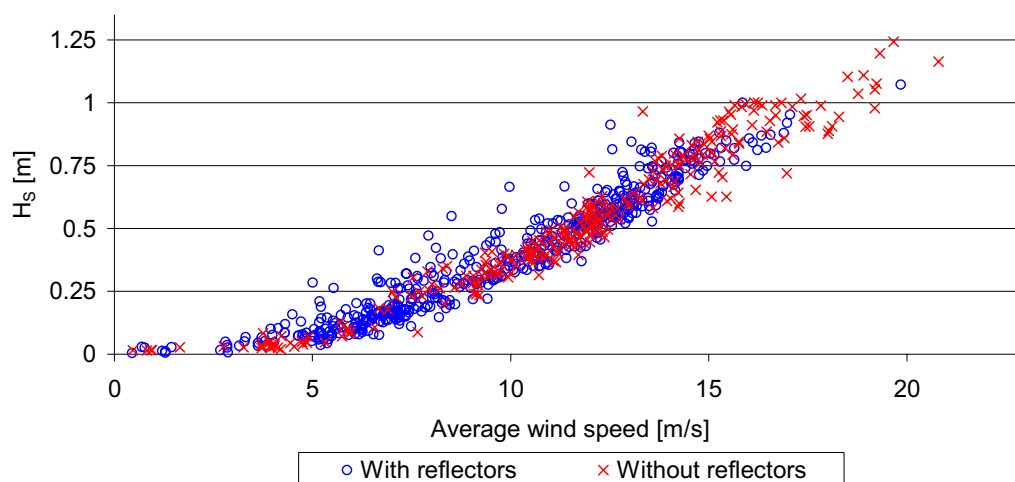

Figure A3, Comparison of wave height against wind speed for winds approaching Nissum Bredning test site 1 from 225° to 270°, with and without the reflector wings of the Wave Dragon present.

Flow calculation

The turbines of Wave Dragon are used to calculate the flow through the device. The flow for each turbine is calculated from the turbine head and its rotational speed according to the calibration measured by Knapp, 2005. The turbine head is derived from the position of the platform (measured by a pressure transducer beneath the device and two inclinometers), and the average of three pressure transducers within the reservoir. End-stops show whether each turbine is open or closed, and the power transducers record the turbine rotational speed. Figure A3 shows a diagram of the signals needed to calculate the overtopping flow.

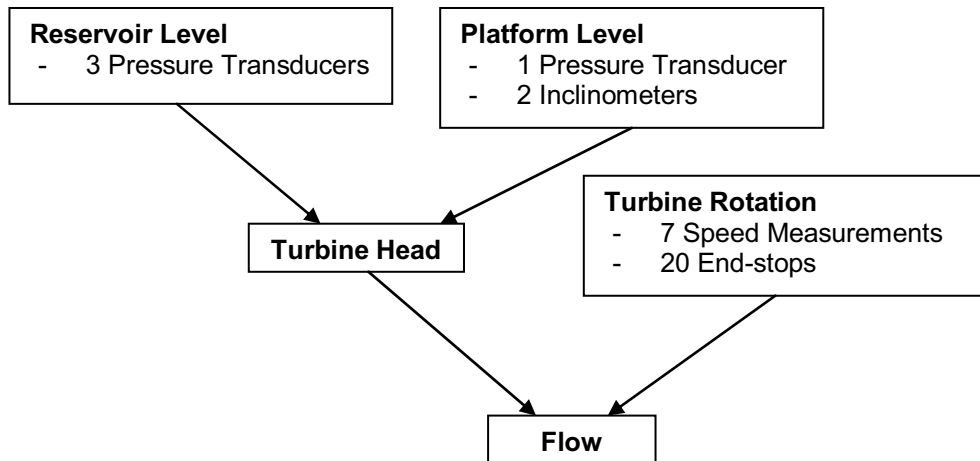

Figure A3, Signals required to calculate the overtopping flow.

Appendix 2 – Related publications by the author

During the research period, from January 2005 to October 2007, and in addition to the content of this thesis, the author has contributed to several publications. These are not re-printed here as they do not directly contribute to the objectives of the thesis. Presenting them allows the reader further access to the wave energy field. The publications have been grouped into related topics.

Wave Dragon general publications

At various conferences and symposia Wave Dragon partner members have been invited to present the device. These publications give the basic information on the device, the history and the future plans. The author has contributed to the following publications:

Christensen L. and Tedd J., 2005: *Introducing a Large Scale Wave Dragon Wave Energy Converter in the Marine Environment*. Presented by Tedd J. at the CoastNET conference “Offshore Development -New Frontiers of Opportunity” London, September 15th 2005.

Sørensen H. C., Christensen L., Friis-Madsen E. and Tedd J., 2005: *Wave Dragon, the Wales 4 -7 MW Demonstrator*, Fluid machinery for wave and tidal energy, IMechE seminar, October 2005

Frigaard P., Kofoed J. P. and Tedd J. 2006: *The Wave Energy device: Wave Dragon*. Proceedings of the Interdisciplinary Conference on Sustainable Technologies for Environmental Protection (ICSTEP), Tamil Nadu, India, January 2006.

Christensen L., Friis-Madsen E., Kofoed J. P. and Tedd J., 2006: *Worlds Largest Wave Energy Project 2007 in Wales*, Proceedings of the PowerGen Europe (PGE) conference, Cologne, Germany, May 2006.

Sørensen H. C., Tedd J., Friis-Madsen E. and Kofoed J. P., 2006: *Preliminary Results from Second Phase Sea Testing of the Wave Dragon Prototype Wave Energy Converter* Proceedings of International Conference Ocean Energy From Innovation to Industry. Ostbayerisches Technologie Transfer Institut (OTTI), Bremerhavn, Germany, October 2006.

Frigaard P., Tedd J. Kofoed, J. P. and Friis-Madsen E. 2006: *3 years experience with energy production on the Nissum Bredning Wave Dragon Co-ordinated Action on Ocean Energy*, 4th Workshop proceedings, Lisbon, Portugal. 2006.

Wave Dragon control publications

As control is a major focus of development for Wave Dragon there have been several publications in the area. In most of these the author has invested considerable work, as in the main the publications draw data from the author’s analysis of the results of the Wave Dragon prototype device. The author has contributed to the following publications:

Tedd J., Knapp W., Frigaard P., and Kofoed J. P. 2005: *Turbine Control Strategy Including Wave Prediction for Overtopping Wave Energy Converters*. Co-ordinated Action on Ocean Energy, 2nd Workshop proceedings, Uppsala, Sweden, November 2005.

Tedd J., Kofoed J. P., Jasinski M., Morris A., Friis Madsen E., Wisniewski R. and Bendtsen R.D. 2007: *Advanced Control techniques for WEC Wave Dragon*, Proceedings of the Sixth European Wave and Tidal Energy Conference (EWTEC), Porto, Portugal, September 2007.

Kofoed J. P., Tedd J., Friis-Madsen E. and Nimskov M. 2007: *Influence of Buoyancy Control performance on power production by the Wave Dragon Nissum Bredning Prototype*. Proceedings of 17th International Offshore and Polar Engineering (ISOPE) Conference, Lisbon, Portugal.

Licensing and environmental publications

As a fellow of the WaveTrain network the author has worked on a collaborative project with other partners and fellows, comparing the non-engineering problems faced by developers in different countries of Europe. The author also contributed with the environmental statement for the Wave Dragon device to be deployed in Wales.

Neumann F., Tedd J., Prado M., Cruz J., Russell I., Patrício S. and La Regina V. 2006: *Licensing and Environmental Issues of Wave Energy Projects* Proceedings of the World Renewable Energy Congress (WREC) IX, Florence, Italy, August 2006.

Andersen T. L., Tedd J., Kramer M. and Kofoed J. P. 2006: *Impact Of Wave Dragon on Wave Climate*. Hydraulics and Coastal Engineering Laboratory, Aalborg University April, 2006

WD, 2007: *Wave Dragon Pre-Commercial Wave Energy Device - Environmental Statement*. Wave Dragon Wales Ltd. Available from: <http://www.wavedragon.co.uk>, April 2007.

Bibliography

Bølgekraftudvalgets Sekretariat, 2002: *Afsluttende rapport fra Energistyrelsens Rådgivende Bølgekraftudvalg 2002.*

Available at: http://www.waveenergy.dk/wave-rapport/1gen_bk/Slutrapport2002.pdf

Carbon Trust, 2006: *Future Marine Energy* [eds. Callaghan J. and Boud R.]

Available from:

http://www.carbontrust.co.uk/technology/technologyaccelerator/marine_energy.htm

CEM, 2002, *Coastal Engineering Manual*, U.S. Army Corps of Engineers, EM 1110-2-1100.

Available from: <http://www.usace.army.mil/publications/eng-manuals/cecw.htm>

Corona L. and Kofoed J.P. 2006: *Wave induced stresses measured at the Wave Dragon Nissum Bredning Prototype*. Co-ordinated Action on Ocean Energy, 3rd Workshop proceedings, Amsterdam, Netherlands. March 2006

Cruz J. 2007: *Ocean Wave Energy: Current Status and Future Perspectives*. [ed Cruz J.] Due to be Published by Springer, Heidelberg, Germany end October 2007.

DTI, 2007: *Preliminary Wave Energy Device Performance Protocol*. UK

Department of Trade and Industry [eds Smith G. and Taylor J.] URN 07/807.

Available at <http://www.berr.gov.uk/files/file38989.pdf>

EMU et al. 2000: *Publishable Final Report – Low Pressure Hydro Turbines and Control Equipment for Wave Energy Converters (Wave Dragon)*. Contract JOR3-CT98-7027, Copenhagen, Denmark.

Falnes J. 2002: *Ocean Waves and Oscillating Systems*, Cambridge University Press Cambridge, UK.

Forsberg J. L. 1985: *On line prediction and identification of waves*. Hydrodynamics of Ocean Wave-Energy Utilization: IUTAM Symposium Lisbon, Portugal.

Franco L., de Gerloni M. and Van der Meer J. W. 1995: *Wave Overtopping on Vertical and Composite Breakwaters*. Proceedings of 24th International Conference of Coastal Engineering, Kobe, Japan 1, 1030-1044.

Frigaard P. and Brorsen M. 1995: *A time-domain method for separating incident and reflected irregular waves*, Coastal Engineering 24 pp 205-215.

Frigaard P., Kofoed J. P. and Rasmussen M. R. 2004: *Overtopping Measurements on the Wave Dragon Nissum Bredning Prototype*. Proceedings of 14th International Offshore and Polar Engineering (ISOPE) Conference Toulon, France.

Frigaard P. and Kofoed J. P. 2005: *Power production experience from Wave Dragon prototype testing in Nissum Bredning: 2003 to 2005*. Hydraulics & Coastal Engineering Laboratory, Aalborg University.

Friis-Madsen E., Kofoed J. P. and Knapp W. 2005: *Prototype Testing of the Wave Energy Converter Wave Dragon*. World Renewable Energy Congress 2005, Aberdeen, UK.

Hald T. and Frigaard P. 2001: *Forces and Overtopping on 2. generation WD for Nissum Bredning*. Phase 3 project, Danish Energy Agency. Project No. ENS-51191/00-0067. Hydraulics & Coastal Engineering Laboratory, Aalborg University, Denmark.

Hansen L.K., Christensen L. and Sørensen H.C. 2003: *Experiences from the Approval Process of the Wave Dragon Project*. Proceedings of the 5th European Wave Energy Conference, University College Cork, Ireland.

IEA-OES, 2006: *Annual Report of the International Energy Agency - Ocean Energy Systems 2006*.

Available from: <http://www.iea-oceans.org/publ/index.htm>

IPCC, 2007: *Climate change 2007: Mitigation. Contribution of Working group III to the Fourth Assessment Report of the Intergovernmental Panel on Climate Change* [eds. Metz B., Davidson O. R., Bosch P. R., Dave R. and Meyer L. A.], Cambridge University Press, Cambridge, United Kingdom and New York, NY, USA.

Available at: www.ipcc.ch/SPM040507.pdf

Jakobsen, K. P. and Frigaard P. 1999: *User's Manual for the Program Wave Dragon – Power Simulation*, Hydraulics and Coastal Engineering Laboratory, Aalborg University. November 1999

Keller J., Rohne W., Böhm C. and Knapp W. 2001: *Wave Dragon, Development and Tests of a Variable Speed Axial Turbine*. Laboratorium für Hydraulische Maschinen, Technische Universität München, 2001

Knapp W. 2005a: *Report on the re- installation and calibration of the Wave Dragon turbines*. Laboratorium für Hydraulische Maschinen, Technische Universität München.

Knapp W. 2005b: *Water Turbines for Overtopping Wave Energy Converters*. Co-ordinated Action on Ocean Energy, 2nd Workshop proceedings, Uppsala Sweden, November 2005

Kofoed J. P., Frigaard P., Friis-Madsen E. and Sørensen H. C. 2000: *Development of the Wave Energy Converter – Wave Dragon*. Proceedings of 10th International Offshore and Polar Engineering (ISOPE) Conference 2000 vol. 1, No 10, pp 405-412. Seattle. USA.

Kofoed J.P. 2002: *Wave Overtopping of Marine Structures – Utilization of Wave Energy*, PhD thesis, Hydraulics and Coastal Engineering Laboratory, Aalborg University. 2002

Kofoed J.P., Frigaard P., Friis-Madsen E. and Sørensen H. C. 2006: *Prototype testing of the wave energy converter Wave Dragon*. Renewable Energy Vol 31, pp 181-189, 2006.

Kofoed J. P., Tedd J., Friis-Madsen E. and Nimskov M. 2007: *Influence of Buoyancy Control performance on power production by the Wave Dragon Nissum Bredning Prototype*. Proceedings of 17th International Offshore and Polar Engineering (ISOPE) Conference, Lisbon, Portugal.

Kramer M., and Frigaard P. 2002: *Efficient Wave Energy Amplification with Wave Reflectors*. Proceedings of 9th International Offshore and Polar Engineering (ISOPE) Conference. Kitakyushu, Japan.

Kramer, M. and Kofoed, J. P. 2004: *Placering af trukmåler til bølgemåling – Wave Dragon, Nissum Bredning*. Hydraulics and Coastal Engineering Laboratory, Aalborg University.

May J. and Bean D. 2005: *Wave Dragon Pre-Commercial Demonstrator - Environmental Impact Assessment Scoping Report*, Prepared by PMSS Ltd for Wave Dragon Wales Ltd.

Available from: <http://www.wavedragon.co.uk>

Meinert P., Gilling L., and Kofoed J. P. 2006: *User manual for SSG Power simulation 2*. Hydraulics and Coastal Engineering No. 44, ISSN: 1603-9874, Aalborg University, June 2006.

Morris E. L., Zienkiewicz H. K., Pouzanjani, M. M. A., Flower J. O., Belmont, M. R., 1992: *Techniques for sea-state prediction*. Proceedings of the Second international Conference on Manoeuvring and Control of Marine Craft, Southampton, July, pp 547-571.

Neumann F., Tedd J., Prado M., Russell I., Patrício S. and La Regina V. 2006: *Licensing and Environmental Issues of Wave Energy Projects*. Proceedings of the World Renewable Energy Congress (WREC) IX, Florence, Italy.

Sarmento A., Whitaker T., Brito e Melo A., Clement A., Salter S., Pontes T. and Neumann F. 2006: *The European Research Training Network For Competitive Wave Energy*, Proceedings of the World Renewable Energy Congress (WREC) IX, Florence, Italy.

Stern N., 2006: *The Stern Review: The Economics of Climate Change*, Cambridge University Press, Cambridge, United Kingdom and New York, NY, USA.

Available at: http://www.hm-treasury.gov.uk/independent_reviews/stern_review_economics_climate_change/sternreview_index.cfm

Svendsen R. and Frigaard P. 2001: *Calculation of the Wave Conditions in Nissum Bredning*. Report for DEA by Hydraulics and Coastal Engineering Laboratory, Aalborg University.

Sørensen H. C. et. al. 2003: *Development of the Wave Dragon from scale 1:50 to prototype*, Proceedings of the 5th European Wave Energy Conference, Cork, Ireland.

Sørensen H. C. et. al. 2005: *The Results of Two Years Testing in Real Sea of Wave Dragon*, proceedings of the 6th European Wave and Tidal Energy Conference, Glasgow, UK, September 2005.

Sørensen H. C., et al. 2006: *Sea Testing and Optimisation of Power Production on a Scale 1:4.5 Test Rig of the Offshore Wave Energy Converter Wave Dragon*, Final technical report, project NNE5-2001-00444

Tedd J. and Kofoed J.P. 2005: *Model Testing of Hydraulic Damping of the Reflector Joint on Wave Dragon*. Hydraulics and Coastal Engineering Laboratory, Aalborg University.

Tedd J., Friis-Madsen E. and Frigaard P. 2005: *Design and Testing for Novel Joint for Wave Reflectors*. Proceedings of the Sixth European Wave and Tidal Energy Conference (EWTEC), Glasgow, UK.

Tedd J., Knapp W., Frigaard P., and Kofoed J. P. 2005: *Turbine Control Strategy Including Wave Prediction for Overtopping Wave Energy Converters*. Co-ordinated Action on Ocean Energy, 2nd Workshop proceedings, Uppsala, Sweden.

Tedd J. and Kofoed J. P. 2006: *Data Obtained from Prototype Wave Dragon in Nissum Bredning: October 2004 – January 2005*. Hydraulics and Coastal Engineering Laboratory, Aalborg University.

Tedd J., Kofoed J. P., Knapp W., Friis-Madsen E. and Sørensen H. C. 2006: *Wave Dragon, prototype wave power production*. Proceedings of the World Renewable Energy Congress (WREC) IX, Florence, Italy.

Valério D., Beirão P. and Sá da Costa J. 2007: *Reactive control and phase and amplitude control applied to the Archimedes Wave Swing*, Proceedings of 17th International Offshore and Polar Engineering (ISOPE) Conference, Lisbon, Portugal.

Van der Meer, J. W., and Janssen, J. P. F. M. 1994: *Wave Run-up and Wave Overtopping at Dikes*. In: Kobayashi, N. and Demirbilek, Z., (eds) *Wave Forces on inclined and vertical wall structures*, pp 1-27, ASCE. Also Delft hydraulics, Publ. No 487.

WD, 2007: *Wave Dragon Pre-Commercial Wave Energy Device - Environmental Statement*. Wave Dragon Wales Ltd.
Available from <http://www.wavedragon.co.uk>

Weber, Rudolf O. 1997: *Estimators for the Standard Deviation of Horizontal Wind Direction*. Journal of Applied Meteorology, Vol 36, October 1997

