



AALBORG UNIVERSITY
DENMARK

Aalborg Universitet

Prototype bucket foundation for wind turbines

Ibsen, Lars Bo; Liingaard, Morten

Publication date:
2006

Document Version
Publisher's PDF, also known as Version of record

[Link to publication from Aalborg University](#)

Citation for published version (APA):
Ibsen, L. B., & Liingaard, M. (2006). Prototype bucket foundation for wind turbines: natural frequency estimation. Aalborg: Department of Civil Engineering, Aalborg University. (DCE Technical Reports; No. 9).

General rights

Copyright and moral rights for the publications made accessible in the public portal are retained by the authors and/or other copyright owners and it is a condition of accessing publications that users recognise and abide by the legal requirements associated with these rights.

- ? Users may download and print one copy of any publication from the public portal for the purpose of private study or research.
- ? You may not further distribute the material or use it for any profit-making activity or commercial gain
- ? You may freely distribute the URL identifying the publication in the public portal ?

Take down policy

If you believe that this document breaches copyright please contact us at vbn@aub.aau.dk providing details, and we will remove access to the work immediately and investigate your claim.

Prototype bucket foundation for wind turbines -natural frequency estimation

**Lars Bo Ibsen
Morten Liingaard**

Aalborg University
Department of Civil Engineering
Division of Water and Soil

DCE Technical Report No. 9

**Prototype bucket foundation
for wind turbines
-natural frequency estimation**

by

Lars Bo Ibsen
Morten Liingaard

December 2006

© Aalborg University

Scientific Publications at the Department of Civil Engineering

Technical Reports are published for timely dissemination of research results and scientific work carried out at the Department of Civil Engineering (DCE) at Aalborg University. This medium allows publication of more detailed explanations and results than typically allowed in scientific journals.

Technical Memoranda are produced to enable the preliminary dissemination of scientific work by the personnel of the DCE where such release is deemed to be appropriate. Documents of this kind may be incomplete or temporary versions of papers—or part of continuing work. This should be kept in mind when references are given to publications of this kind.

Contract Reports are produced to report scientific work carried out under contract. Publications of this kind contain confidential matter and are reserved for the sponsors and the DCE. Therefore, Contract Reports are generally not available for public circulation.

Lecture Notes contain material produced by the lecturers at the DCE for educational purposes. This may be scientific notes, lecture books, example problems or manuals for laboratory work, or computer programs developed at the DCE.

Theses are monographs or collections of papers published to report the scientific work carried out at the DCE to obtain a degree as either PhD or Doctor of Technology. The thesis is publicly available after the defence of the degree.

Latest News is published to enable rapid communication of information about scientific work carried out at the DCE. This includes the status of research projects, developments in the laboratories, information about collaborative work and recent research results.

Published 2006 by
Aalborg University
Department of Civil Engineering
Sohngaardsholmsvej 57,
DK-9000 Aalborg, Denmark

Printed in Denmark at Aalborg University

ISSN 1901-726X
DCE Technical Report No. 9

Preface

The technical report “Prototype bucket foundation for wind turbines—natural frequency estimation” is divided into four numbered sections, and a list of references is situated after the last section. Tables, equations and figures are indicated with consecutive numbers. Cited references are marked as e.g. Friswell and Mottershead (1995), with author specification and year of publication in the text.

The work within this report has only been possible with the financial support from the Energy Research Programme (ERP)¹ administered by the Danish Energy Authority. The project is associated with the ERP programme “Soil–Structure interaction of Foundations for Offshore Wind Turbines”. The funding is sincerely acknowledged.

Aalborg, December 13, 2006

Lars Bo Ibsen & Morten Liingaard

¹In danish: “Energiforskningsprogrammet (EFP)”

Contents

1	Prototype bucket foundation for wind turbines—natural frequency estimation	1
1.1	Introduction	1
1.1.1	The prototype in Frederikshavn	2
1.2	Experimental estimation of natural frequencies	4
1.2.1	Modal identification technique	4
1.2.2	Natural frequencies for idle conditions	7
1.2.3	Natural frequencies for wind turbine without wings	7
1.2.4	Natural frequencies for wind turbine without wings and nacelle	9
1.3	Numerical estimation of natural frequencies	11
1.3.1	Finite Element model of the wind turbine	11
1.3.2	Foundation models	11
1.3.3	Numerical analysis of steady state response	15
1.4	Conclusions	18
1.4.1	Experimental approach	18
1.4.2	Numerical approach	19
1.4.3	Recommendations for future work:	20
	References	21

List of Figures

1.1	The wind turbine on the bucket foundation (a). The levels indicate location of accelerometers. The overall geometry of the bucket foundation (b).	3
1.2	Location of accelerometers at the four levels. The arrows indicate positive measuring directions. Accelerometer no. 1, 4 and 6 are mounted vertical with an upward measuring direction as positive.	5
1.3	Singular values of the spectral density matrices determined by the Frequency Domain Decomposition method—Idle conditions.	7
1.4	Singular values of the spectral density matrices determined by the Frequency Domain Decomposition method—without wings.	8
1.5	Replacement of nacelle in the spring 2005.	8
1.6	Singular values of the spectral density matrices determined by the Frequency Domain Decomposition method—without wings and nacelle.	9
1.7	Two-dimensional finite element model of tower, nacelle and rotor. The model comprises 32 nodes and 31 beam elements.	12
1.8	Foundation models for the finite element model. (a) Static springs, (b) lumped-parameter models, and (c) fixed (used for reference). No coupling terms are shown.	13
1.9	Simple lumped-parameter models. (a) Standard lumped-parameter model, and (b) fundamental lumped-parameter model.	14
1.10	Steady state response (nacelle node) of the wind turbine for different foundation models.	17
1.11	Steady state response (mid-tower node) of the wind turbine for different foundation models.	17

List of Tables

1.1	Properties of the Vestas V90 3.0 MW wind turbine	3
1.2	Specifications of accelerometer	4
1.3	Properties for finite element model	11
1.4	Model properties for the foundation models	15
1.5	Numerical estimation of natural frequencies	16

Chapter 1

Prototype bucket foundation for wind turbines—natural frequency estimation

The first full scale prototype bucket foundation for wind turbines has been installed in October 2002 at Aalborg University offshore test facility in Frederikshavn, Denmark. The suction caisson and the wind turbine have been equipped with an online monitoring system, consisting of 15 accelerometers and a real-time data-acquisition system. The report concerns the in service performance of the wind turbine, with focus on estimation of the natural frequencies of the structure/foundation. The natural frequencies are initially estimated by means of experimental Output-only Modal analysis. The experimental estimates are then compared with numerical simulations of the suction caisson foundation and the wind turbine. The numerical model consists of a finite element section for the wind turbine tower and nacelle. The soil–structure interaction of the soil–foundation section is modelled by lumped-parameter models capable of simulating dynamic frequency dependent behaviour of the structure–foundation system.

1.1 Introduction

The continuous development of wind turbine technology has resulted in great increases in both size and performance of the wind turbines during the last 25 years. The power output of wind turbines has improved by larger rotors and more powerful generators. In order to reduce the costs, the overall weight of the wind turbine components is minimized, meaning that the wind turbine structures are becoming more flexible and thus more sensitive to dynamic excitation. A modern offshore wind turbine (1.5 to 2 MW) is typically installed with a variable speed system so the rotational speed of the rotor varies from, for example, 10–20 RPM. This means that the excitation frequency of the rotor system varies. The first excitation frequency interval then becomes 0.17–0.33 Hz (for 10–20 RPM) and is referred to as the 1Ω frequency interval. The second excitation frequency interval corresponds to the rotor blade frequency that depends on the number of blades. For a three-bladed wind turbine the 3Ω frequency interval is equal to 0.5–1.0 Hz (for 10–20 RPM). Since the first resonance frequency ω_1 of the modern offshore wind turbines is placed between 1Ω and 3Ω , it is of outmost importance to be able to evaluate the resonance frequencies of the wind turbine structure accurately as the wind turbines

increase in size. At present, the wind turbine foundations are modeled simply by beam elements or static soil springs, which means that the foundation stiffness is frequency independent.

The purpose of this report is to investigate the natural frequencies of the Vestas 3.0 MW offshore wind turbine. The first part of this report concerns experimental estimation of the natural frequencies by means of experimental modal analysis of the structure. In the second part of this report, the natural frequencies are evaluated by a finite element model. The nacelle and wind turbine tower are modelled by two-dimensional beam members, and the soil-structure interaction is modelled by two types of foundation models. In the first approach, the soil-structure interaction is modelled by static springs for each degree of freedom at the foundation node. In the second approach, the frequency dependent behaviour of the structure-foundation system is taken into consideration by applying so-called lumped-parameter models.

It should be emphasized that the intention is to demonstrate an experimental and a numerical approach for estimating the response of the wind turbine. The discipline of finite element model updating is not considered. See e.g. Friswell and Mottershead (1995) and Datta (2002) regarding this topic.

1.1.1 The prototype in Frederikshavn

The suction caisson (also known as bucket foundation) is a relatively new type of foundation used to support offshore structures, see Houlsby et al. (2005). The concept has been developed over the past 5 years and has been utilized for the Vestas V90 3.0 MW offshore wind turbine at Aalborg University offshore test facility in Frederikshavn, Denmark. The concept is sketched in Figure 1.1.

In the initial phase of the installation process the skirt penetrates into the seabed due to the weight of the structure. In the second phase suction is applied to penetrate the skirt to the design depth. After installation the foundation acts a hybrid of a pile and a gravity based foundation. The stability of the foundation is ensured by a combination of earth pressures on the skirt and the vertical bearing capacity of the bucket. This foundation type is a welded steel structure and the fabrication/material costs are comparable to those of the monopile foundation concept. The installation phase does not require heavy pile hammers and the decommissioning is a relatively simple process where the foundation can be raised by applying pressure to the bucket structure.

The prototype of the suction caisson in Frederikshavn is designed with a diameter of 12 m and a skirt length of 6 m. The weight of the suction caisson is approx. 140 tons. The overall properties of the wind turbine is summarized in Table 1.1, see Vestas (2006) for further details. The foundation was placed late October 2002, and the actual installation period lasted approx. 12 hours. Det Norske Veritas (DNV) has certified the design of the prototype in Frederikshavn to B level. The turbine was installed on the foundation in December 2002. The design procedure for the prototype bucket foundation has been described in details by Ibsen et al. (2005).

Table 1.1: Properties of the Vestas V90 3.0 MW wind turbine

Property	value
Hub height	80 m
Rotor diameter	90 m
Nominal revolutions	16.1 rpm
Operational interval	8.6-18.4 rpm
Weight nacelle	70 t
Weight rotor	41 t
Weight tower	160 t

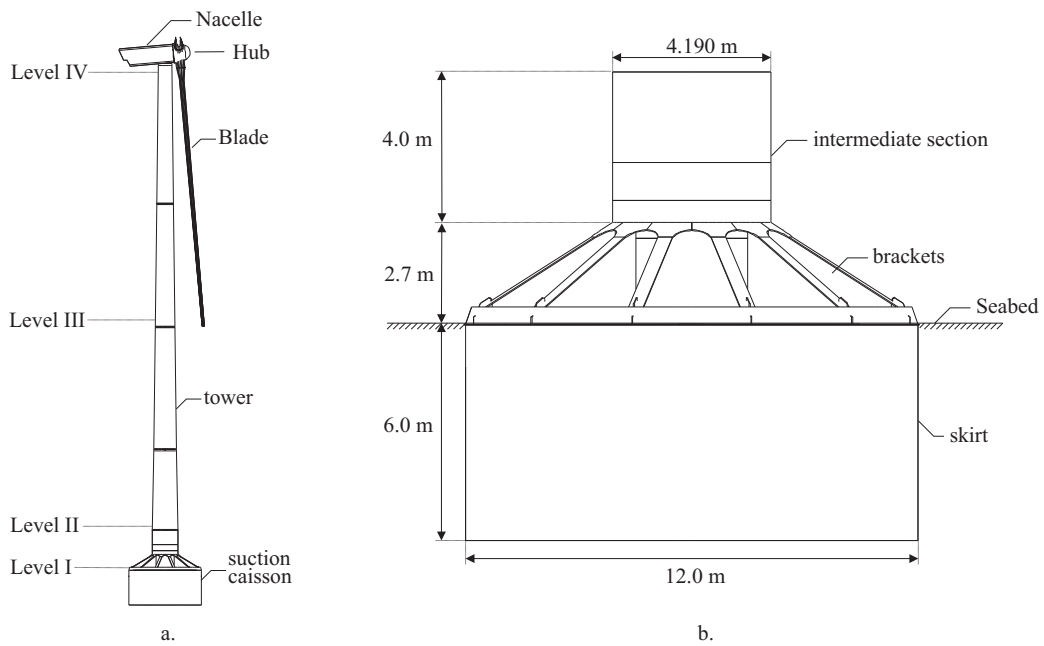

Figure 1.1: The wind turbine on the bucket foundation (a). The levels indicate location of accelerometers. The overall geometry of the bucket foundation (b).

1.2 Experimental estimation of natural frequencies

The natural frequencies of the wind turbine have been estimated experimentally by means of experimental modal analysis of the structure. The monitoring system and analysis software are briefly introduced and the modal parameters are then presented. The experimental estimation technique is used to examine the natural frequencies for three various situations. These are:

- ◆ Idle conditions
- ◆ Wind turbine without wings
- ◆ Wind turbine without wings and nacelle

1.2.1 Modal identification technique

In this subsection the monitoring system, the analysis software, and the procedure for modal identification are introduced.

Monitoring system

The Vestas 3.0 MW prototype wind turbine is instrumented with 15 accelerometers and a real-time data-acquisition system. The sensors are Kinemetrics force balance accelerometers, model FBA ES-U (Kinemetrics 2002). The specifications are listed in Table 1.2. The accelerometers are placed at four different levels, three in the wind turbine tower and one in the compartments inside the bucket foundation, see Figure 1.1a. The positions, measuring directions and numbering are shown in Figure 1.2. The accelerometers are mounted on consoles that are attached to the steel structure by magnets. The online monitoring system consists of a DigiTexx PDAQ-8 portable data acquisition system with 16 channels and 16 bit resolution. The remote portable data acquisition system is placed inside the wind turbine and the DigiTexx RTMS-2001R Remote Client Software is used for real time data acquisition and monitoring at Aalborg University. The performance of the wind turbine is also monitored online by live web imaging.

Table 1.2: Specifications of accelerometer

Type:	Single-axis force balanced acceleration sensor
Model:	Kinemetrics Episensor FBA ES-U
Dynamic range:	145 dB+
Bandwidth:	DC to 200 Hz
Full-scale range:	User selectable: $\pm 0.25g$, $\pm 0.5g$, $\pm 1g$, $\pm 2g$ or $\pm 4g$
Outputs:	User selectable: $\pm 2.5V$ or $\pm 10V$ single-ended; $\pm 5V$ or $\pm 20V$ differential
Operating Temperature:	-20° to $70^{\circ}C$

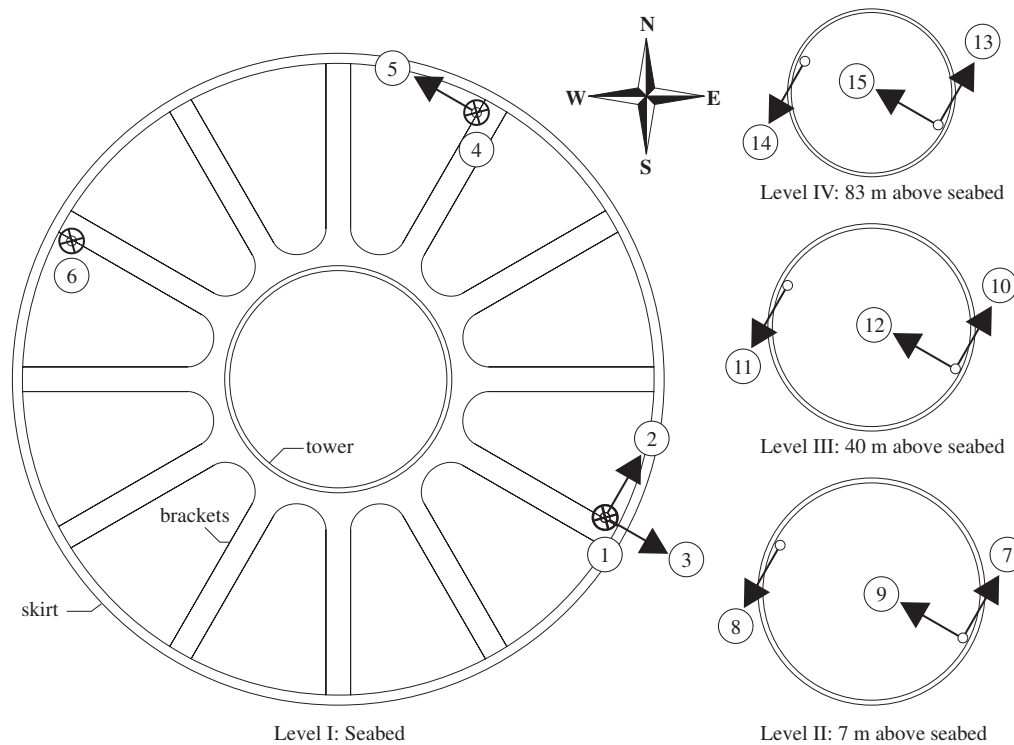

Figure 1.2: Location of accelerometers at the four levels. The arrows indicate positive measuring directions. Accelerometer no. 1, 4 and 6 are mounted vertical with an upward measuring direction as positive.

Analysis software

The modal analysis of the wind turbine makes use of "Output-only modal identification" which is utilized when the modal properties are identified from measured responses only. The experimental modal analysis of the wind turbine prototype is performed by means of the software package ARTeMIS—Ambient Response Testing and Modal Identification Software (SVS 2006). The software is fully compatible with the hardware of the monitoring system described above. The software allows accurate modal identification under operational conditions and in situations where the structure is impossible or difficult to excite by externally applied forces. The typical outputs of the analyses are modal information about the natural frequencies, mode shapes and damping ratios. The modal analysis within this software is based on the assumptions that the underlying physical system of the structure is linear and time-invariant. The linearity implies that the physical system comply with the rules of linear superposition. The time-invariance implies that the underlying mechanical or structural system does not change in time. Within this

frame the program is based on two different estimation techniques, one in time domain and one in frequency domain. The analyses described in this report are based on the frequency domain technique. The frequency domain estimation is a non-parametric model based on a Frequency Domain Decomposition (FDD) method. The FDD method is an extension of the well-known frequency domain approach, which is based on mode estimations directly from the Power Spectral Density (PSD) matrix, i.e. well separated modes can be identified at the peaks of the PSD matrix. The basic principle of the Frequency Domain Decomposition (FDD) technique is to perform an approximate decomposition of the system response into a set of independent single degree of freedom (SDOF) systems; each corresponding to an individual mode. In the FDD the Spectral Density matrix is decomposed by means of the Singular Value Decomposition (SVD) into a set of auto spectral density functions, each corresponding to a single degree of freedom system. The key feature is that the singular values are estimates of the Auto Spectral density of the SDOF systems, and the singular vectors are estimates of the mode shapes. The basic theory concerning identification by FDD is presented in Ibsen and Liingaard (2006d). For references, see (Brincker, Andersen, and Zhang 2000; Brincker, Zhang, and Andersen 2000).

Modal identification procedure

The natural frequencies of the wind turbine have been determined on a regular basis during the last three years of operation. The natural frequencies are estimated for idle conditions only, in order to avoid interference caused by rotating components of the wind turbine. The mode estimation for operational conditions is more complex, and requires information about all the possible "forced harmonic modes" from e.g. gears, generators, rotors and pitch systems. Furthermore, it should be noted that the structural system of an operational wind turbine is time-varying. Thus, errors are introduced in the modal identification, because the framework of the modal estimation relies on the assumptions that the underlying physical system of the structure is linear and time-invariant. In order to obtain reliable data for the modal analysis, the length of each time series corresponds to 1000 times the first natural period of the structure. The first natural frequency is approximately 0.3 Hz, which equals a first natural period of 3.3 seconds. Consequently, the length of data acquisition should be at least 3300 seconds. Finally, the FDD method has been applied for identifying the natural frequencies of the wind turbine.

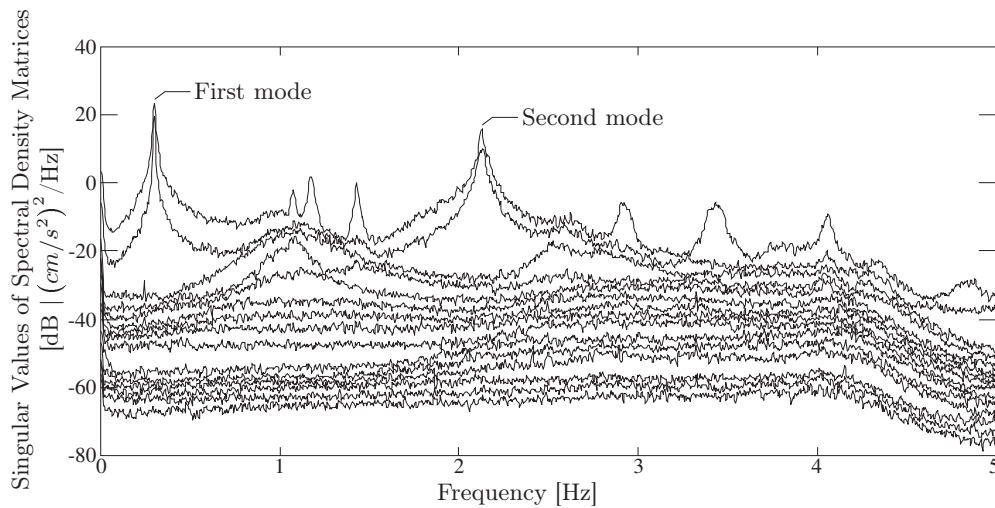

Figure 1.3: Singular values of the spectral density matrices determined by the Frequency Domain Decomposition method—Idle conditions.

1.2.2 Natural frequencies for idle conditions

The singular values of the spectral density matrices determined by the Frequency Domain Decomposition method are given in Figure 1.3. When the wind turbine is stopped the structure is subjected to ambient excitation from the wind. The measured data used in the analysis was recorded February 15, 2005. The data set consists of a 1 hour measurement in 15 channels. The sampling frequency was 200 Hz and the data was decimated by an order of 20. The FDD technique was used for peak picking.

In Figure 1.3 the peaks for the first and second mode of the structure are shown. Note that there are closely spaced modes at the selected frequencies, which implies that there are two perpendicular modes at each natural frequency. The first resonance frequency is equal to 0.30 Hz and the second is 2.13 Hz. The peaks between the first and second mode of the wind turbine correspond to the resonance frequencies for the blades, i.e. the first modes of flap-wise and edgewise vibrations. The peak at 2.93 Hz appears to be a torsional mode of the structure.

1.2.3 Natural frequencies for wind turbine without wings

In the spring 2005 the nacelle of the wind turbine was replaced with a newer prototype version. In Figure 1.5 the wings have been removed prior to the replacement of the nacelle. During the period where the wings were removed, several data acquisition sequences have been performed. Figure 1.4 shows a representative plot of the singular values of the spectral density matrices for the wind turbine without wings. The measured data was recorded the March 21, 2005. The data set consists of a 1 hour measurement in

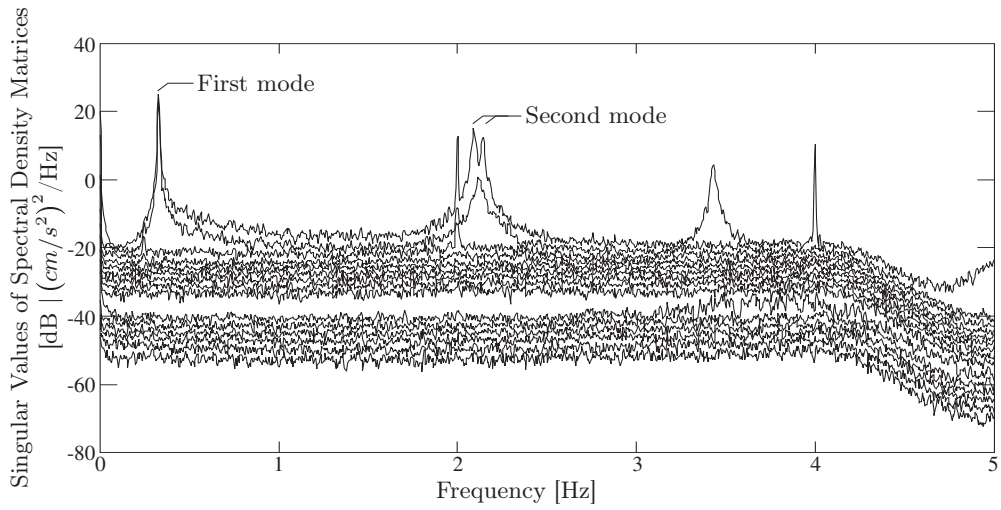

Figure 1.4: Singular values of the spectral density matrices determined by the Frequency Domain Decomposition method—without wings.



Figure 1.5: Replacement of nacelle in the spring 2005.

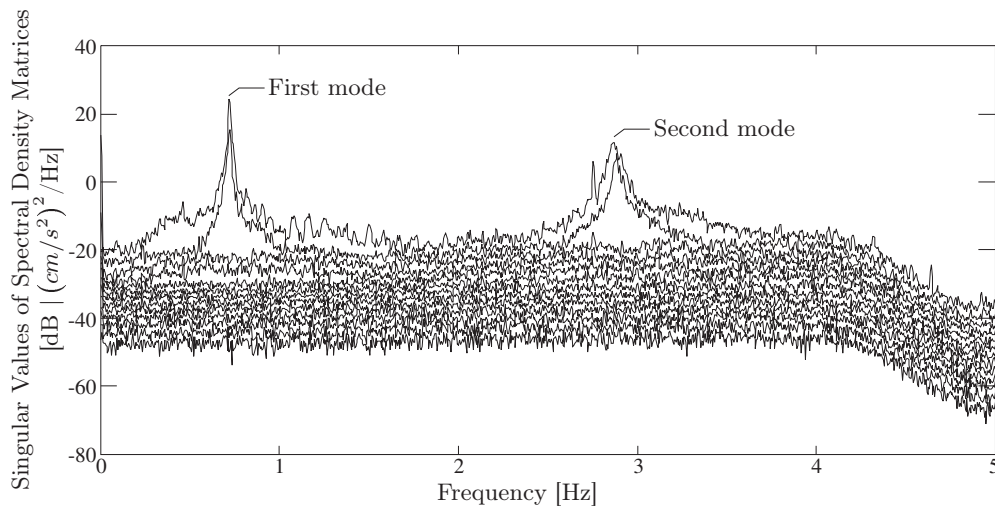

Figure 1.6: Singular values of the spectral density matrices determined by the Frequency Domain Decomposition method—without wings and nacelle.

15 channels. The sampling frequency was 200 Hz and the data was decimated by an order of 20. In Figure 1.4 there are closely spaced modes at the selected frequencies, which again suggest two perpendicular modes at each natural frequency. The first resonance frequency is equal to 0.33 Hz and the second is 2.10–2.14 Hz.

Note that the local peaks (resonance frequencies for the blades) between the first and second mode have disappeared. Furthermore, the resonance frequency of the torsional mode has increased from 2.93 Hz to 3.43 Hz. The sharp peaks at 2 Hz and 4 Hz are forced harmonic vibrations, probably due to maintenance.

1.2.4 Natural frequencies for wind turbine without wings and nacelle

Figure 1.6 shows the singular values of the spectral density matrices for the wind turbine without wings and nacelle. The measured data was recorded the May 11, 2005. The data set consists of a 30 minutes measurement in 15 channels. The sampling frequency was 200 Hz and the data was decimated by an order of 20. The first and second natural frequency of the structure has changed significantly after the nacelle was removed. The first resonance frequency is equal to 0.72 Hz and the second is 2.88 Hz.

Subsequent experimental modal analyses show that the first and second natural frequency are equal to 0.29 Hz and 2.11 Hz, respectively. Thus, the replacement of the nacelle and wings resulted in marginal change of the natural frequencies of the structure.

1.3 Numerical estimation of natural frequencies

The natural frequencies of the wind turbine are estimated numerically by means of a Finite Element model of the wind turbine and the suction foundation. The soil–structure interaction of the structure is taken into account by means of two different approaches: static springs and frequency dependent lumped-parameter models.

Initially, the Finite Element (FE) model of the wind turbine is described. Secondly, the concepts of the two foundation models are briefly introduced, and thirdly, the natural frequencies of the wind turbine are estimated by the numerical model.

1.3.1 Finite Element model of the wind turbine

The finite element model of the wind turbine tower and the nacelle consists of two-dimensional beam members with three degrees of freedom for each node. The model properties of the finite element model are summarized in Table 1.3. The wind turbine tower is discretized by 31 linear elastic beam elements with varying length and section properties. The nacelle and rotor are modelled as point masses. The inertia of the blades is added as a mass moment of inertia in the rotor node. The finite element model is illustrated in Figure 1.7.

1.3.2 Foundation models

In the case of axisymmetric foundations there is only a coupling between the horizontal sliding and rocking motion. Thus, the vertical and torsional motion are completely decoupled from each other and from the remaining degrees of freedom. In this analysis,

Table 1.3: Properties for finite element model

Property		value	
Number of elements	N_{el}	31	
Number of nodes	N_n	32	
Number of dofs	N_{dof}	96	
Young's modulus	E_t	210	GPa
Poisson's ratio	ν_t	0.25	
Mass density	ρ_t	7850	kg/m ³
Loss factor	η_t	2	%
Section area	A_t	varies	
Section area moment of inertia	I_t	varies	
Point mass—nacelle	$m_{nacelle}$	70	t
Point mass—rotor	m_{rotor}	41	t
Mass moment of inertia—rotor	J_{rotor}	3024	t·m ²
Point mass—foundation	m_f	135	t

The subscript t denotes tower.

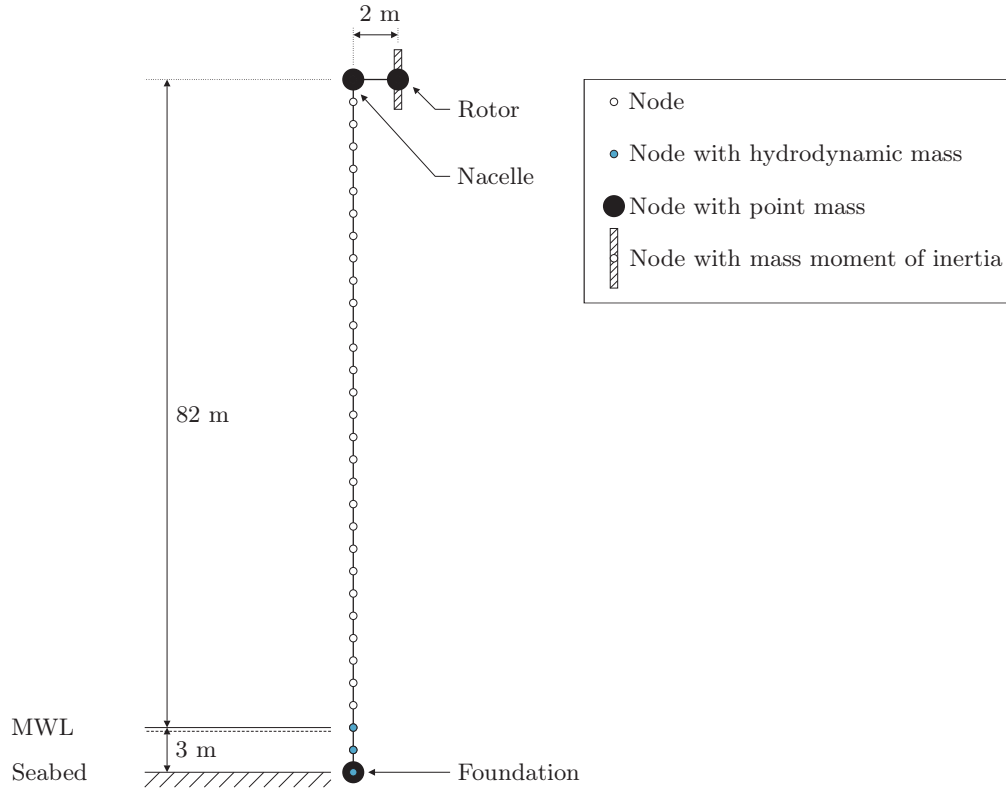

Figure 1.7: Two-dimensional finite element model of tower, nacelle and rotor. The model comprises 32 nodes and 31 beam elements.

the displacements/rotations and forces/moments are defined in one plane, i.e. the model can be formulated as a two-dimensional model, with no out-of-plane motions. Thus, the terms for coupled sliding and rocking perpendicular to the plane of motion can be omitted. Torsional motions are not considered.

The soil–structure interaction is modelled by two types of foundation models. In the first approach, the soil–structure interaction is modelled by static springs for each degree of freedom at the foundation node. In the second approach, the frequency dependent behaviour of the structure–foundation system is taken into consideration by applying lumped-parameter models. A fully fixed structure is used as reference. The foundation models are shown in Figure 1.8.

Static springs

The elastic static stiffness of the foundation can be expressed by dimensionless elastic stiffness coefficients corresponding to vertical (K_{VV}^0), sliding (K_{HH}^0) and rocking (K_{MM}^0)

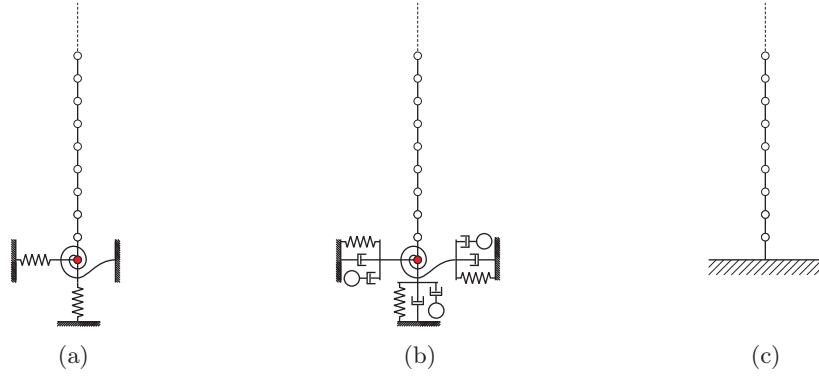

Figure 1.8: Foundation models for the finite element model. (a) Static springs, (b) lumped-parameter models, and (c) fixed (used for reference). No coupling terms are shown.

degrees of freedom. The coupling between sliding and rocking is given by (K_{HM}^0) . For the two-dimensional case, the elastic stiffness of the foundation system can be expressed as

$$\begin{bmatrix} H/G_s R^2 \\ V/G_s R^2 \\ M/G_s R^3 \end{bmatrix} = \begin{bmatrix} K_{HH}^0 & 0 & K_{HM}^0 \\ 0 & K_{VV}^0 & 0 \\ K_{MH}^0 & 0 & K_{MM}^0 \end{bmatrix} \begin{bmatrix} U/R \\ W/R \\ \theta_M \end{bmatrix}, \quad (1.1)$$

where R is the radius of the foundation and G_s is the shear modulus of the soil. H , V and M are sliding force, vertical force and rocking moment, respectively. U , W and θ_M are the corresponding displacements/rotations. The shear modulus G_s is given by

$$G_s = \frac{E_s}{2(1 + \nu_s)} \quad (1.2)$$

where E_s is Young's modulus and ν_s is Poisson's ratio. Note that the foundation is assumed to be rigid and the soil is linear elastic, i.e. the properties are given by G_s and ν_s . This means that the stiffness components in 1.1 are functions of Poisson's ratio. The dimensionless elastic stiffness coefficients for the suction caisson are given in Ibsen and Liingaard (2006a).

Lumped-parameter models

The investigations of frequency dependent behaviour of massless foundations often involves complicated three-dimensional elastodynamic analyses using rigorous methods, such as the finite element method or the boundary element method. The employed models typically consist of several thousand degrees of freedom, and the frequency dependent dynamic stiffness of the foundations are evaluated in the frequency domain. The requirement for real-time computations in the time domain in aero-elastic codes does not

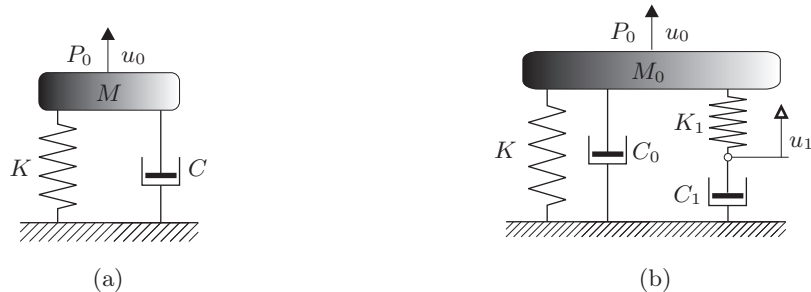

Figure 1.9: Simple lumped-parameter models. (a) Standard lumped-parameter model, and (b) fundamental lumped-parameter model.

conform with the use of e.g. a three-dimensional coupled Boundary Element/Finite Element Method, where the foundation stiffness is evaluated in the frequency domain.

In order to meet the requirements of real-time calculations and analysis in time domain, lumped-parameter models are particularly useful (Wolf 1994). A lumped-parameter model represents the frequency dependent soil-structure interaction of a massless foundation placed on or embedded into an unbounded soil domain. Prior to arranging the lumped-parameter models, the frequency dependent dynamic stiffness of the soil-foundation system must be obtained by a rigorous solution, see Ibsen and Liingaard (2006c) and Ibsen and Liingaard (2006b). The lumped-parameter models are then assembled by an arrangement of springs, dashpots and/or masses with initially unknown parameters. The unknown parameters are determined by curve fitting with respect to a known rigorous solution, i.e. the unknown parameters are determined by minimizing the total square error between the lumped-parameter model and the known rigorous solution. A key feature is that the models consist of real frequency-independent coefficients in a certain arrangement, which can be formulated into stiffness, damping and/or mass matrices. Thus, the lumped-parameter model can be incorporated into standard dynamic programs. Each degree of freedom at the foundation node of the structural model is coupled to a lumped-parameter model that may consist of additional internal degrees of freedom. Two simple lumped-parameter models are sketched in Figure 1.9. The lumped-parameter models are described in details in Ibsen and Liingaard (2006e). The calibration of the lumped-parameter models with respect to the suction caisson is shown in Ibsen and Liingaard (2006a).

Properties of the foundation models

The model properties of the soil and the suction caisson used in the analyses of the static springs and lumped-parameter models (lpm) are given in Table 1.4. For details, see Ibsen and Liingaard (2006a). Note that the loss factor is assumed to be constant for all frequencies, i.e. hysteretic damping is assumed.

Table 1.4: Model properties for the foundation models

Property		value	Static springs	lpm
Foundation radius	R	6 m	x	x
Skirt length	H	6 m	x	x
Skirt thickness	t	30 mm	x	x
Shear modulus (soil) [†]	G_s	1,10,100 MPa	x	x
Poisson's ratio (soil)	ν_s	0.25	x	x
Mass density (soil)	ρ_s	1000 kg/m ³	-	x
Loss factor (soil)	η_s	5 %	-	x
Young's modulus (foundation)	E_f	210 GPa	x	x
Poisson's ratio (foundation)	ν_f	0.25	x	x
Mass density (foundation) [‡]	ρ_f	0/1000 kg/m ³	-	x
Loss factor (foundation)	η_f	2 %	-	x

[†] The models are constructed for three values of G_s

[‡] $\rho_f = 0$ for the lid of the caisson and $\rho_f = \rho_s$ for the skirt

1.3.3 Numerical analysis of steady state response

To determine the steady state response, the wind turbine structure is subjected to a harmonic unit load with the circular frequency ω . The unit load is applied as a horizontal point load at two levels, in order to excite both the first and second natural frequency of the wind turbine structure. To excite the first natural frequency, the load is applied at the nacelle node, and the second natural frequency is excited by applying the load at a mid-tower node. The steady state response is determined by solving the equation of motion for a harmonic response, given by

$$\mathbf{M}\ddot{\mathbf{u}} + \mathbf{C}\dot{\mathbf{u}} + \mathbf{K}\mathbf{u} = \mathbf{f}e^{i\omega t}, \quad (1.3)$$

where \mathbf{M} , \mathbf{C} and \mathbf{K} are the mass, damping and stiffness matrix of the structure, respectively. \mathbf{u} is a column vector containing the nodal displacements and \mathbf{f} is a column vector of nodal forces. t is time and i is the imaginary unit, $i = \sqrt{-1}$. The equation of motion in Equation 1.3 is solved by direct analysis (Petyt 1998). The solution to Equation 1.3 is then

$$\mathbf{u} = [\mathbf{K} - \omega^2\mathbf{M} + i\omega\mathbf{C}]^{-1} \mathbf{f}e^{i\omega t} \quad (1.4)$$

The matrices \mathbf{M} , \mathbf{C} and \mathbf{K} are assembled for the structural system. Subsequently, the boundary conditions are included, either by removing or adding components to the matrices. For the foundation model with static springs, the foundation stiffness for of each degree of freedom is simply added to the associated degree of freedom for the structural system. Additional degrees of freedom are added for the lumped-parameter models, see Ibsen and Liingaard (2006a). Finally, the fixed degrees of freedom are removed from the system matrices for the reference case with a fully fixed foundation.

Steady state response

The steady state response of the wind turbine has been determined by means of the structural finite element combined with the foundation models shown in Figure 1.8. The static springs and the lumped-parameter models have been determined for three different values of the shear modulus of the soil. That is G_s equal to 1, 10 and 100 MPa. The steady state responses for the nacelle node and the mid-tower node are given for the magnitude of the node displacements as function of the frequency f of the harmonic loading (note that $f = 2\pi/\omega$). Resonance of the structure when subjected to a unit load with a given frequency may be observed as local peaks in the magnitude of the node displacements. The steady state responses are shown in Figures 1.10 and 1.11.

The frequency intervals of the responses in Figures 1.10 and 1.11 correspond to the intervals, in which the first and second natural frequency of the structure should appear, according to the experimental findings.

The resonance of the structure is highly dependent on the stiffness of the soil. The natural frequencies are significantly reduced for soft soil conditions ($G_s = 1$ MPa). The first and second natural frequency estimated by the two foundation models tends toward the natural frequency of the fully fixed structure for stiff soil conditions ($G_s \geq 100$ MPa). The estimation of the natural frequencies for the two types of foundation models are shown in Table 1.5. The natural frequency estimations by applying the two foundation

Table 1.5: Numerical estimation of natural frequencies

Soil stiffness	first natural frequency [Hz]			second natural frequency [Hz]		
	Static	LPM	Fixed	Static	LPM	Fixed
$G_s = 1$ MPa	0.205	0.204	-	1.47	1.41	-
$G_s = 10$ MPa	0.307	0.307	-	1.97	1.95	-
$G_s = 100$ MPa	0.329	0.331	-	2.16	2.16	-
∞	-	-	0.331	-	-	2.19

models are very similar. The estimation of the first resonance frequency is identical for $G_s = 1$ and 10 MPa, and there is only minor deviations for $G_s = 100$ MPa. The estimation of the second resonance frequency shows greater, but insignificant variations between the two foundation models.

In contrast, the magnitude and shape of the response vary widely for the two foundation concepts. For a constant soil stiffness, the shape and magnitude of the resonance peaks in static spring response are determined by the amount of material damping in the wind turbine structure. In this case the structural damping has been estimated by a loss factor η_t equal to 2 % (Table 1.3). If η_t is decreased the resonance peak narrows down and the magnitude of the peak response increases. For high structural damping, the peak response of the static spring model becomes more broad-banded (bell-shaped) and the magnitude of the displacement decreases.

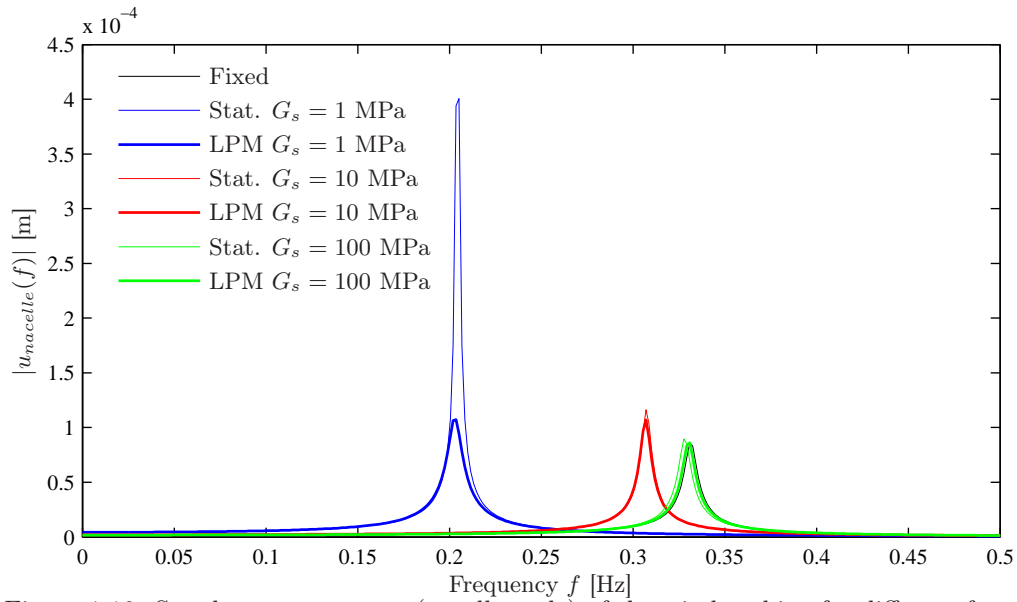

Figure 1.10: Steady state response (nacelle node) of the wind turbine for different foundation models.

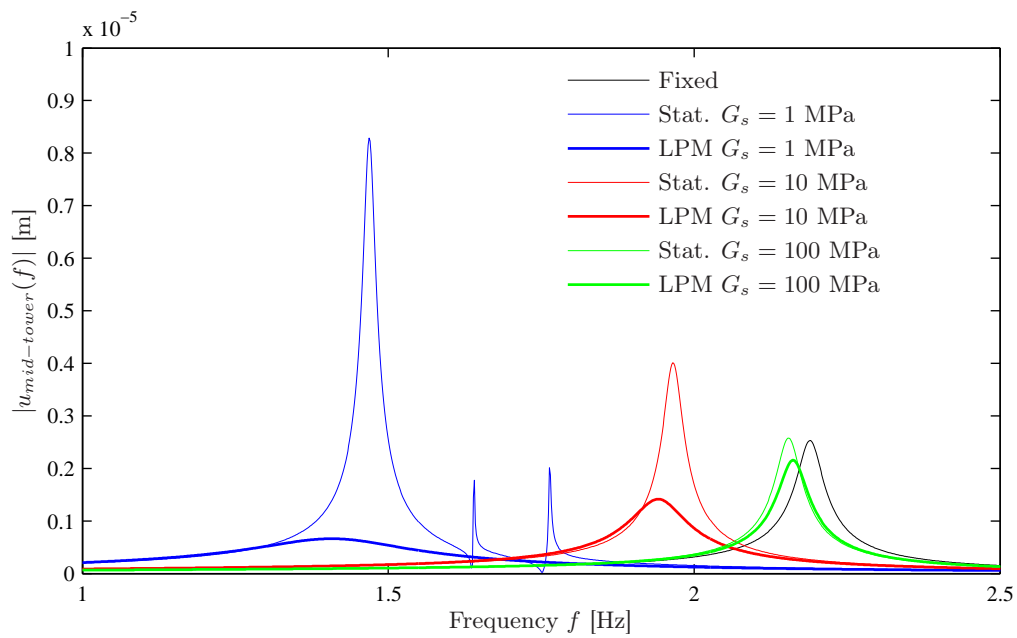

Figure 1.11: Steady state response (mid-tower node) of the wind turbine for different foundation models.

Now consider the response of the lumped-parameter models. Again, for a constant soil stiffness, the shape and magnitude of the resonance peaks are influenced by the amount of material damping in the wind turbine structure. Moreover, damping exists in the soil–structure interaction, contrary to the static spring model. The lumped-parameter models are based on the frequency dependent stiffness (impedance) of a massless foundation vibrating in an visco-elastic half-space. Thus, both geometrical damping, i.e. the radiation of waves into the subsoil, and material dissipation into the subsoil contribute to the overall damping of the structure. The material dissipation of the soil has been estimated by a loss factor η_s equal to 5 % (Table 1.4).

It is evident that the implementation of both geometrical damping and material dissipation in the subsoil influence the peak response remarkably. The peak responses estimated by the lumped-parameter models are broad-banded and the magnitude at the peak is reduced significantly, especially for soft soil conditions ($G_s = 1$ MPa). As G_s is increased, the peaks become more narrow-banded, and the effect of the soil–structure interaction is reduced. For $G_s = 100$ MPa, the response of the lumped-parameter model more or less coincides with that of the fixed model without any soil–structure interaction.

With respect to the lumped-parameter models, it is worth noticing that the peak response of the second natural frequency is heavily damped, compared to the peak response of the first natural frequency. This corresponds to the fact that the damping due to radiation of waves into the subsoil (geometrical damping) becomes more pronounced as the excitation frequency increases.

Experimental vs. numerical

The experimental modal analysis showed that the first and second natural frequency of the wind turbine are 0.30 Hz and 2.13 Hz, respectively. By inspection of Figures 1.10 and 1.11 these frequencies correspond to a soil shear modulus G_s between 10 and 100 MPa. This observation agrees with the fact that G_s has been determined to 40–80 MPa at the site. The in-situ measurement of G_s has been performed by cone penetration tests. The in-situ measurements are reported in Ibsen (2002).

1.4 Conclusions

The response of a Vestas 3.0 MW offshore wind turbine has been examined by means of an experimental and a numerical approach. The experimental estimation of the natural frequencies has been performed by experimental modal analysis of the structure. The numerical estimation of the response has been evaluated by a finite element model with two types of foundation models. One model, where the soil–structure interaction is modelled by static springs, and one model in which the frequency dependent behaviour of the structure–foundation system is taken into consideration by applying lumped-parameter models.

1.4.1 Experimental approach

An experimental modal analysis have been carried out with the intention of estimating the natural frequencies of the wind turbine. The main conclusions are:

- ◆ The natural frequencies have been estimated for idle conditions only, in order to avoid interference caused by rotating components of the wind turbine. If mode estimation are to be performed for operational conditions, information about all the possible "forced harmonic modes" from e.g. gears, generators, rotors and pitch systems are required.
- ◆ The structural system of an operational wind turbine is time-varying. Thus, errors are introduced in the modal identification, because the framework of the modal estimation relies on the assumptions that the underlying physical system of the structure is linear and time-invariant.
- ◆ To obtain reliable data for the modal analysis, the length of each time series corresponds to 1000 times the first natural period of the structure.
- ◆ For idle conditions, the first and second natural frequency is equal to 0.30 Hz and 2.13 Hz, respectively. Resonance frequencies for the blades have been observed in the frequency interval between the first and second natural frequency of the structure.
- ◆ Replacement of the nacelle and blades in the spring 2005 resulted in marginal change of the natural frequencies of the structure.

1.4.2 Numerical approach

A finite element model of the wind turbine has been utilized to estimate the natural frequencies of the structure numerically. The soil–structure interaction has been simulated by two types of foundation models, static springs for each degree of freedom at the foundation node, and lumped-parameter models where the frequency dependent behaviour of the structure–foundation system is taken into account. The static springs and the lumped-parameter models have been determined for G_s (shear modulus of the soil) equal to 1, 10 and 100 MPa. The following conclusions can be made:

- ◆ The resonance frequency of the structure is highly dependent on the stiffness of the soil. For soft soil conditions ($G_s = 1$ MPa) the first and second natural frequency are 0.20 Hz and 1.41 Hz, respectively. For stiff soil conditions ($G_s = 100$ MPa) the frequencies are 0.33 Hz and 2.16 Hz, respectively, close to the natural frequencies of a fully fixed structure (0.33 Hz and 2.19 Hz).
- ◆ The natural frequency estimations by applying the two foundation models are very similar. Insignificant variations on the estimation of the second resonance frequency have been observed.
- ◆ By using the lumped-parameter models, both geometrical damping and material dissipation into the subsoil contribute to the overall damping of the structure, in contrast to the static spring model where damping only exists in the wind turbine structure.
- ◆ The magnitude and shape of the response vary widely for the two foundation concepts. The peak responses estimated by the static spring model are narrow-banded, whereas the responses estimated by the lumped-parameter models are broad-banded

and the magnitude at the peak is reduced significantly, especially for soft soil conditions ($G_s = 1$ MPa).

- ◆ The peak response of the second natural frequency is heavily damped, compared to the peak response of the first natural frequency, regarding the lumped-parameter models, suggesting that the damping due to radiation of waves into the subsoil becomes more pronounced as the excitation frequency increases.

1.4.3 Recommendations for future work:

- ◆ Parameter studies of the influence of soil damping, soil stiffness, structural mass and stiffness on the response of the wind turbine
- ◆ Studies of the effect of soil layering.
- ◆ Parameter studies and comparison of different foundation concepts
- ◆ Implement the lumped-parameter models of wind turbine foundations into aero-elastic codes, in order to test the composite structure–foundation system in a complex loading environment

Bibliography

- Brincker, R., P. Andersen, and L. Zhang (2000). Modal identification from ambient responses using frequency domain decomposition. In *Proceedings of The 18th International Modal Analysis Conference (IMAC)*, San Antonio, Texas, pp. 625–630.
- Brincker, R., L. Zhang, and P. Andersen (2000, September 13–15). Output-only modal analysis by frequency domain decomposition. In *Proceedings of The ISMA25 Noise And Vibration Engineering*, Volume 11, Leuven, Belgium, pp. 717–723.
- Datta, B. N. (2002). Finite-element model updating, eigenstructure assignment and eigenvalue embedding techniques for vibrating systems. *Mechanical Systems and Signal Processing* 16(1), 89–96.
- Friswell, M. I. and J. E. Mottershead (1995). *Finite element model updating in structural dynamics*. London: Kluwer Academic Publishers.
- Houlsby, G. T., L. B. Ibsen, and B. W. Byrne (2005). Suction caissons for wind turbines. In *Proceedings of International Symposium on Frontiers in Offshore Geotechnics: ISFOG 2005*, Perth, Australia. Taylor & Francis Group, London.
- Ibsen, L. B. (2002). *Bøttefundament Frederikshavn Havn*. Data report R0205—version 1: Department of Civil Engineering, Aalborg University, Denmark. Confidential, in danish.
- Ibsen, L. B. and M. Liingaard (2006a). Application of lumped-parameter models. DCE Technical report 12, Department of Civil Engineering, Aalborg University.
- Ibsen, L. B. and M. Liingaard (2006b). Dynamic stiffness of suction caissons—torsion, sliding and rocking. DCE Technical report 8, Department of Civil Engineering, Aalborg University.
- Ibsen, L. B. and M. Liingaard (2006c). Dynamic stiffness of suction caissons—vertical vibrations. DCE Technical report 7, Department of Civil Engineering, Aalborg University.
- Ibsen, L. B. and M. Liingaard (2006d). Experimental modal analysis. DCE Technical report 10, Department of Civil Engineering, Aalborg University.
- Ibsen, L. B. and M. Liingaard (2006e). Lumped-parameter models. DCE Technical report 11, Department of Civil Engineering, Aalborg University.
- Ibsen, L. B., M. Liingaard, and S. A. Nielsen (2005, 26 - 28 October). Bucket foundation, a status. In *Proceedings of Copenhagen Offshore Wind 2005*.

- Kinematics (2002, April). *User Guide—EpiSensor, Force Balance Accelerometer, Model FBA ES-U*. Kinematics, Inc., 222 Vista Avenue, Pasadena, CA 91107 USA.
- Novak, M. and K. Sachs (1973). Torsional and coupled vibrations of embedded footings. *Earthquake Engineering and Structural Dynamics* 2, 11–33.
- Petyt, M. (1998). *Introduction to Finite Element Vibration Analysis*. Cambridge: Cambridge University Press.
- SVS (2006). *ARTEMIS software - version 3.5*. Structural Vibration Solutions (SVS) ApS, Novi Science Park, Niels Jernes Vej 10, DK 9220 Aalborg East, Denmark, www.svibs.com.
- Vestas (2006). *Vestas V90—3.0 MW*. Brochure, downloaded at www.vestas.com: Vestas wind energy systems, Randers, Denmark.
- Wolf, J. P. (1994). *Foundation Vibration Analysis Using Simple Physical Models*. Englewood Cliffs, NJ: Prentice-Hall.