



**Aalborg Universitet**

**AALBORG UNIVERSITY**  
DENMARK

## **Model Predictive Control of the Hybrid Ventilation for Livestock**

Wu, Zhuang; Stoustrup, Jakob; Trangbæk, Klaus; Heiselberg, Per Kvols; Riisgaard Jensen, Martin

*Published in:*  
45th IEEE Conference on Decision and Control Proceedings

*Publication date:*  
2006

*Document Version*  
Publisher's PDF, also known as Version of record

[Link to publication from Aalborg University](#)

*Citation for published version (APA):*  
Wu, Z., Stoustrup, J., Trangbæk, K., Heiselberg, P., & Riisgaard Jensen, M. (2006). Model Predictive Control of the Hybrid Ventilation for Livestock. In 45th IEEE Conference on Decision and Control Proceedings (pp. 1460-1465). Electrical Engineering/Electronics, Computer, Communications and Information Technology Association.

### **General rights**

Copyright and moral rights for the publications made accessible in the public portal are retained by the authors and/or other copyright owners and it is a condition of accessing publications that users recognise and abide by the legal requirements associated with these rights.

- ? Users may download and print one copy of any publication from the public portal for the purpose of private study or research.
- ? You may not further distribute the material or use it for any profit-making activity or commercial gain
- ? You may freely distribute the URL identifying the publication in the public portal ?

### **Take down policy**

If you believe that this document breaches copyright please contact us at [vbn@aub.aau.dk](mailto:vbn@aub.aau.dk) providing details, and we will remove access to the work immediately and investigate your claim.

# Model Predictive Control of the Hybrid Ventilation for Livestock

Zhuang Wu, Jakob Stoustrup, Klaus Trangbaek, Per Heiselberg and Martin Riisgaard Jensen

**Abstract**—In this paper, design and simulation results of model predictive control (MPC) strategy for livestock hybrid ventilation systems and associated indoor climate through variable valve openings and exhaust fans, are presented. The design is based on thermal comfort parameters for poultry in barns and a dynamic model describing the nonlinear behavior of ventilation and associated climate, by applying a so-called conceptual multi-zone method and the conservation of energy and mass. The simulation results illustrate the high potential of MPC in dealing with nonlinearities, handling constraints and performing off-set free tracking. The purpose of this paper is to apply MPC taking into account of the random disturbances from animals and weather condition to calculate the optimal ventilation rate and air flow distribution and the prediction of indoor horizontal variation of temperature through an optimum energy approach.

## I. INTRODUCTION

Livestock ventilation is concerned with comfort interpreted through animal welfare, behavior and health, and most importantly, it is concerned with factors such as conversion ratio, growth rate and mortality [1]. The alleviation of thermal strain and the maintenance of comfort environment significantly depend on the measurement and control of the air temperature and the humidity which have pretty well defined thermal comfort in the presence of air movement and radiation through ventilation systems. The humidity control is not considered in this work because it has little effect on thermal comfort sensation at or near comfortable temperatures unless it is extremely low or high.

Hybrid ventilation systems combine the natural ventilation and mechanical ventilation, and have been widely used for livestock in Denmark. Most existing control systems used for livestock barns are based on the analysis with single zone method, which assumes that the indoor air temperature and contaminants concentration are uniform [2]. However, the actual indoor environment at any controlling sensors (especially when the sensors are located horizontally) will depend on the air flow distribution that is usually depicted as a map of the dominant air paths. Therefore, the control system for large scale livestock barns neglecting the horizontal variations could obviously result in significant deviations from the optimal environment for the sensitive pigs or poultry. Furthermore, the performance of currently used control scheme for livestock are limited when large disturbance occur in the presence of inputs saturation.

Z. Wu, J. Stoustrup and K. Trangbaek are with Department of Control Engineering, Aalborg University, 9220 Aalborg East, Denmark [zhuangwu@control.aau.dk](mailto:zhuangwu@control.aau.dk)

P. Heiselberg is with Department of Building Technology and Structural Engineering, Aalborg University, 9000 Aalborg, Denmark

M. R. Jensen is with Skov A/S, Glyngoere, 7870 Roslev, Denmark

As stated in books [3] and [4], papers [5] and [6], Model Predictive Control (MPC) has become the advanced control strategy of choice by industry mainly for the economically important, large-scale, multi-variable processes in the plant. The rationale for MPC in these applications is that it can deal with high non-linearities, handle constraints and modeling error, fulfill offset-free tracking, and it is easy to tune and implement.

In this paper, the livestock indoor environment and its control system will be regarded as a feedback loop in which the predictive controller provide the optimal actions to the actuators taking into account of the significant disturbances and random noises. This strategy is not only expected to give good regulation of zonal temperatures, but also to minimize the energy consumption involved with operating the valves and the fans.

## II. LIVESTOCK VENTILATION SYSTEM MODELING

### A. System Description and Dynamic Models

The schematic diagram of a large scale livestock barn equipped with hybrid ventilation system analyzed with conceptual multi-zone method is shown in Fig. 1(1), Fig. 1(2) and Fig. 1(3). The system consists of evenly distributed exhaust units mounted in the ridge of the roof and fresh air inlet openings installed on the walls. From the view of direction A and B, Fig. 1(a) and Fig. 1(b) provide a description of the dominant air flow map of the building including the airflow interaction between each conceptual zone. Through inlet system, the incoming fresh cold air mixes with indoor warm air and circulates via the exhaust system, and then drop down to the animal environmental zones slowly in order to satisfy the zonal comfort requirement. Therefore, the exhaust system is the most important link in this circulation chain, because it controls the relative negative pressure inside the building compared to the outside.

By applying a conceptual multi-zone method, the building will be divided into several macroscopic homogeneous conceptual zones horizontally so that the nonlinear differential equation relating the zonal temperature can be derived based on the energy balance equation for each zone as (1). By substituting the subscript  $i$  with the zone number, we could obtain three coupled differential algebraic equations governing a sensible heat model for indoor thermal comfort.

$$M_{iCp,i} \frac{dT_i}{dt} = \dot{Q}_{i+1,i} + \dot{Q}_{i,i+1} + \dot{Q}_{in,i} + \dot{Q}_{out,i} + \dot{Q}_{conve,i} + \dot{Q}_{source,i} \quad (1)$$

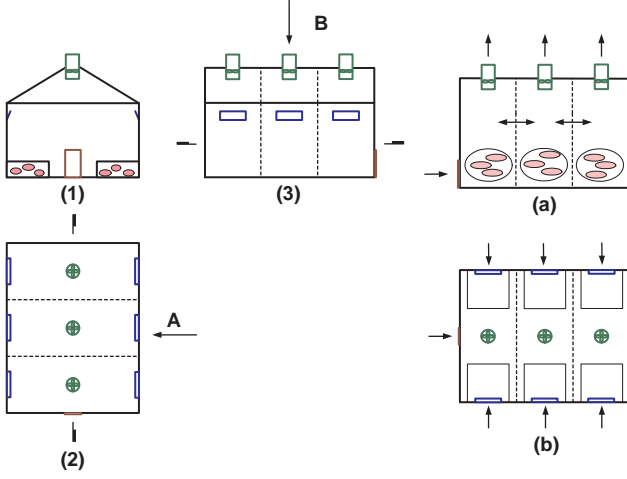

Fig. 1. Synoptic of Large Scale Livestock Barn and the Dominant Airflow Map of the Barn

where  $T_i$  is the indoor zonal air temperature ( $^{\circ}\text{C}$ ),  $c_{p,i}$  is the specific heat of the air ( $\text{J} \cdot \text{kg}^{-1} \cdot \text{K}^{-1}$ ),  $M_i$  is the mass of the air ( $\text{kg}$ ),  $\dot{Q}_{i+1,i}$ ,  $\dot{Q}_{i,i+1}$ , indicate the heat exchange ( $\text{J}/\text{s}$ ) due to the air flow across the conceptual boundary of zone  $i$  and zone  $i+1$ , while for the middle zones which have heat exchange with neighbor zones on each side, two more parts  $\dot{Q}_{i-1,i}$ ,  $\dot{Q}_{i,i-1}$  will be added.  $\dot{Q}_{in,i}$ ,  $\dot{Q}_{out,i}$  represent the heat transfer ( $\text{J}/\text{s}$ ) by mass flow through inlet and outlet of the zone respectively. The convective heat loss through the building envelope is denoted by  $\dot{Q}_{conve,i}$  ( $\text{J}/\text{s}$ ). The heat source of the zone  $\dot{Q}_{source,i}$  includes the heat gain from animal heat production and heating system.

The inlet systems provide variable airflow directions and the amount of incoming fresh air by adjusting the bottom hanged flap. Proper design and applications of the performance of inlet openings in the facade can expand the period of use of hybrid ventilation and increase both air and cooling capacity. The volume flow rate through the inlet is calculated by (2), where  $C_d$  is the discharge coefficient,  $A$  is the geometrical opening area ( $\text{m}^2$ ),  $\Delta P$  ( $\text{Pa}$ ) is the pressure difference across the opening and can be computed by a set of routines solving thermal buoyancy and wind effect as (3). The subscript  $ref$  stands for the value at reference height,  $NPL$  stands for the Neutral Pressure Level.

$$q_{in} = C_d \cdot A \cdot \sqrt{\frac{2 \cdot \Delta P}{\rho}} \quad (2)$$

$$\Delta P = \frac{1}{2} C_{P,r} \rho_o V_{ref}^2 - P_i + \rho_o g \frac{T_i - T_o}{T_i} (H_{NPL} - H_{in}) \quad (3)$$

The exhaust unit consists of an axial-type fan and a swivel shutter. The airflow capacity is controlled by adjusting the r.p.m. of the fan impeller and by means of the shutter. With fan law, the straightforward relationship between the total pressure difference  $\Delta P_{fan}$ , volume flow rate  $q_{out}$  and supplied voltage  $V_{volt}$  with a specific shutter opening angle can be clarified in a nonlinear static equation (4), where the parameters  $a_0$ ,  $a_1$ ,  $a_1$  are empirically determined and

will be discussed in next section. As shown in (5), the total pressure difference across the fan is the difference between the wind pressure on the roof and the internal pressure at the entrance of the fan which considers the pressure distribution calculated upon the internal pressure at reference height denoted by  $P_i$ .

$$\Delta P_{fan} = a_0 \cdot (V_{volt})^2 + a_1 \cdot q_{out} \cdot (V_{volt}) + a_2 \cdot q_{out}^2 \quad (4)$$

$$\Delta P_{fan} = \frac{1}{2} \rho_o C_{P,r} V_{ref}^2 - P_i - \rho_i g \frac{T_i - T_o}{T_o} (H_{NPL} - H_{fan}) \quad (5)$$

For detailed description and necessary simplifying assumptions of the models, we refer to [7] and [8].

### B. Dynamic Parameter Estimation

The dynamic model can be linearly expressed with respect to the dynamic parameters, which then can be estimated by using least-square techniques based on the measurement data collected from the experiments made by SKOV A/S in Denmark.

The discharge coefficient  $C_d$  for inlet system, varies considerably with the inlet type, opening area, as well as incoming air temperature and flow rate. However, for simplifying the computation, we use a constant value of this coefficient for all openings, even though it might lead to over-prediction of airflow capacity and thereby larger openings than necessary. Fig. 2 demonstrates the characteristic curve of the air volume flow rate through the inlet opening corresponding to negative pressure differences. The colored curves represent different opening percentages.

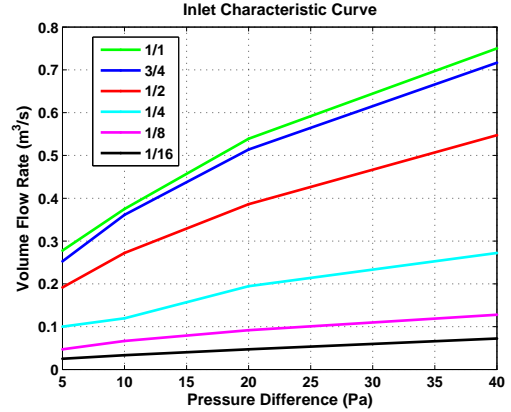

Fig. 2. Inlet Opening Characteristic Curve with Flap Adjustment

Fig. 3 illustrates the performance of the exhaust fans by controlling the swivel shutter at every  $10^{\circ}$ . Each surface represents the character of the fan at specific shutter opening angle with pressure-voltage-flow data, and is approximated by the quadratic equation (4), in which the parameters are determined empirically from the experiments.

### III. MODEL PREDICTIVE CONTROL

The entire livestock ventilation system and indoor environment is a Multiple Input and Multiple Output (MIMO) dynamic nonlinear process and strongly coupled intrinsic

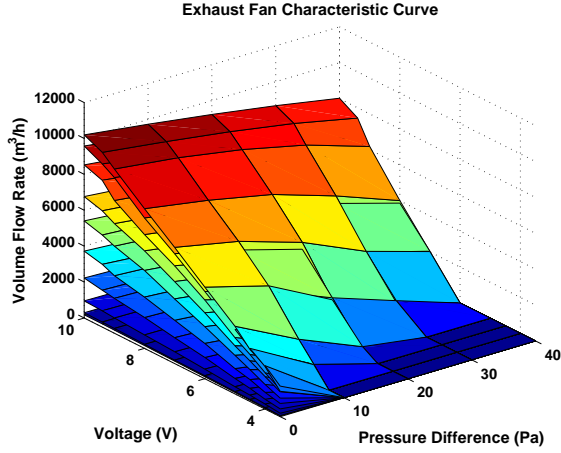

Fig. 3. Exhaust Fan Performance with Shutter Change from  $0^\circ$  to  $90^\circ$

system. It is exposed to external disturbances and noise and have actuators with saturation. Consequently, it is necessary to explore the advanced control algorithms MPC to satisfy the equilibrium between the thermal comfort and energy consumption. A predictive controller has an internal model which is used to predict the behavior of the plant, starting at the current time, over a future prediction horizon [3]. Therefore, for the entire nonlinear system, a series of Linear Time Invariant (LTI) state space models which are derived from the system linearization around the equilibrium points corresponding to different inter-zonal airflow direction need to be defined, and the Thermal Neutral Zone [9] is selected to be the criterion that represents the control objective.

#### A. Internal Modeling

We regard the livestock ventilation system as two parts by noting that the overall system consists of a static air distribution system (inlet-exhaust air flow system) and a dynamic thermal system (animal environmental zones). Fig. 4 shows the synoptic of the entire system model and the climate control variables.

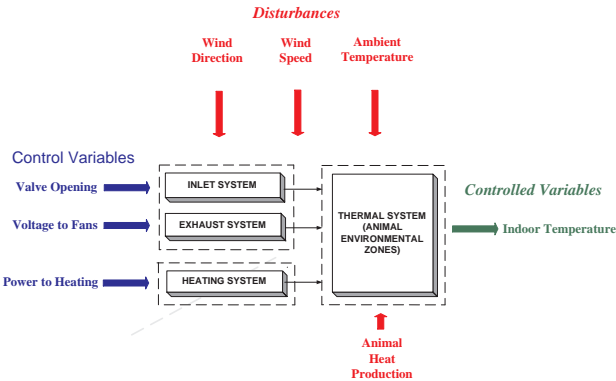

Fig. 4. Synoptic of Entire System Model and Climate Control Variables

Let the discrete time linearised dynamics of a general thermal model (1) which is represented with three coupled

equations be described in the state space form as (6):

$$\begin{aligned} x(k+1) &= A_T \cdot x_T(k) + B_T \cdot q(k) + B_{Td} \cdot d_T(k) \\ y(k) &= C_T \cdot x_T(k) + D_T \cdot q(k) + D_{Td} \cdot d_T(k) \end{aligned} \quad (6)$$

where,  $A_T, B_T, B_{Td}, C_T, D_T, D_{Td}$  are the coefficient matrices with subscript  $T$  denoting the model for the thermal system.  $k$  is the current sample number.

By applying the conservation of mass for the livestock building with one single zone concept (7), and through linearization of air flow model deduced through (2) to (5), we can derive the static equation (8).

$$\sum_{i=1}^6 q_{in}(k) \cdot \rho_o - \sum_{j=1}^3 q_{out}(k) \cdot \rho_i = 0 \quad (7)$$

$$E \cdot v(k) + F \cdot u(k) + G \cdot w(k) + K \cdot x(k) = 0 \quad (8)$$

where,  $E, F, G, K$  are coefficients matrices. The definition of  $v \in \mathfrak{R}^{9+1}$  is:  $[q_{in,m}, q_{out,n}, P_i]^T$ ,  $m = 1 \dots 6$ ,  $n = 1 \dots 3$ , where,  $[q]_{1 \times 9}^T$  is a airflow input vector which combines the actuators' signals  $u$  in (8) and the process controlled variables  $x$  in (6).  $q$  can be expressed explicitly as (9).  $P_i$  is the internal pressure which will be neglected in procedure of multiplying and substitution. The general form of a finalized LTI state space model (10) connecting the airflow model with thermal model, and representing the entire system dynamics around the equilibrium point is obtained.

$$q(k) = \begin{bmatrix} I_{9 \times 9} & 0_{9 \times 1} \\ -E^{-1} \cdot [F \cdot u(k) + G \cdot w(k) + K \cdot x(k)] \end{bmatrix} \quad (9)$$

$$\begin{aligned} x(k+1) &= A \cdot x(k) + B \cdot u(k) + B_d \cdot \begin{bmatrix} d(k) \\ w(k) \end{bmatrix} \\ y(k) &= C \cdot x(k) + D \cdot u(k) + D_d \cdot \begin{bmatrix} d(k) \\ w(k) \end{bmatrix} \end{aligned} \quad (10)$$

where,

$$B_d = \begin{bmatrix} B_{dd} & B_{dw} \end{bmatrix}, D_d = \begin{bmatrix} D_{dd} & D_{dw} \end{bmatrix} \quad (11)$$

and  $A \in \mathfrak{R}^{3 \times 3}$ ,  $B \in \mathfrak{R}^{3 \times 9}$ ,  $C \in \mathfrak{R}^{3 \times 3}$ ,  $D \in \mathfrak{R}^{3 \times 9}$ ,  $B_d \in \mathfrak{R}^{3 \times 8}$ ,  $D_d \in \mathfrak{R}^{3 \times 8}$  are the coefficient matrices at the equilibrium point.  $x, y, u, d, w$  denote the sequences of vectors representing small signal values of the process state for the indoor temperature of each conceptual zone, the controlled output which is equal to the state, the manipulated input which consists of the valve openings and voltage supplied to the fans, the disturbances of the heat generated from animals and heating system, and the disturbances of external wind speed, wind direction and ambient temperature.

$$\begin{aligned} x &= \begin{bmatrix} \bar{T}_1 & \bar{T}_2 & \bar{T}_3 \end{bmatrix}_{3 \times 1}^T, \\ u &= \begin{bmatrix} \bar{A}_{in, i=1 \dots 6} & \bar{V}_{volt, j=1 \dots 3} \end{bmatrix}_{9 \times 1}^T, \\ d &= \begin{bmatrix} \bar{Q}_1 & \bar{Q}_2 & \bar{Q}_3 \end{bmatrix}_{3 \times 1}^T, \\ w &= \begin{bmatrix} \bar{V}_{ref} & \bar{c}_{P,w} & \bar{c}_{P,l} & \bar{c}_{P,r} & \bar{T}_o \end{bmatrix}_{5 \times 1}^T \end{aligned} \quad (12)$$

Concluded from systematical analysis, the pair  $(A, B)$  is controllable, the pair  $(C, A)$  is observable, and the plant is stable. Thus, the internal modeling is accomplished and it is well prepared for solving of the optimization problem in predictive control and estimation scheme which will be discussed in next section.

## B. MPC Formulation

The constrained optimization problem is formulated by a quadratic cost function (13) on finite horizon, subjected to the system dynamics (10) and the following linear inequalities (14) imposed by the equipment limitation on the operation and slew rate, and the constraints on the controlled variables.

$$V(k) = \sum_{i=0}^{H_p} \|\hat{z}(k+i/k) - r(k+i)\|_{Q(i)}^2 + \sum_{i=0}^{H_u-1} \|\Delta u(k+i/k)\|_{R(i)}^2 \quad (13)$$

$$s.t. \begin{cases} u_{\min} \leq u \leq u_{\max} \\ \Delta u_{\min} \leq \Delta u \leq \Delta u_{\max} \\ z_{\min} \leq z \leq z_{\max} \end{cases} \quad (14)$$

where,  $V$  is the performance index to be minimized by penalizing the deviation of the predicted controlled output  $\hat{z}$  from reference trajectory  $r$  over the prediction horizon  $H_p$ , and the change of the control input  $\Delta u$  which is adjusted over the control horizon  $H_u$ . We will always assume that  $H_u \leq H_p$ , and that  $\Delta u(k+i/k) = 0$  for  $i \geq H_u$ , so that  $u(k+i/k) = u(k+H_u-1/k)$  for all  $i \geq H_u$ . The weighting matrices  $Q \in \mathfrak{R}^{3 \times 3}$  and  $R \in \mathfrak{R}^{9 \times 9}$  are positive semi-definite and act as tuning parameters which need to be adjusted in order to give a satisfactory system dynamic performances.

An additional form of the term  $\sum_{i=0}^{H_u-1} \|u(k+i/k) - u_s\|_{S(i)}^2$ ,  $S \in \mathfrak{R}^{9 \times 9}$  will be added to the cost function, which penalizes deviation of the input vector from the *ideal resting value*  $u_s$ , for there are more inputs than the controlled variables [3].

To guarantee offset-free control of the output in the presence of plant/model mismatch and/or unmeasured integrating disturbances, the system model expressed in (10) is augmented with an integrating disturbance and verified to be detectable according to the general methodology proposed in [10] and [11]. The process states are influenced by the input disturbances from animal heat production, heating system and external weather condition. In this work, the external weather for the wind and temperature is measured through a weather monitor. The resulting augmented system with state noise  $w$  and measurement noise  $v$  is:

$$\begin{aligned} \tilde{x}(k+1) &= \tilde{A}\tilde{x}(k) + \tilde{B}u(k) + \tilde{G}w(k) \\ y(k) &= \tilde{C}\tilde{x}(k) + v(k) \\ w(k) &\sim N(0, Q_w(k)) \\ v(k) &\sim N(0, R_v(k)) \end{aligned} \quad (15)$$

in which the augmented state and system matrices are defined as follows,

$$\begin{aligned} x(k) &= \begin{bmatrix} x(k+1) \\ x_{umd}(k+1) \\ x_{md}(k+1) \end{bmatrix}_{14 \times 1}, \tilde{G} = \begin{bmatrix} 0 \\ B_{umd} \\ 0 \end{bmatrix}_{14 \times 3}, \\ \tilde{A} &= \begin{bmatrix} A & B_{dd}C_{umd} & B_{d}C_{md} \\ 0 & A_{umd} & 0 \\ 0 & 0 & A_{md} \end{bmatrix}_{14 \times 14}, \\ \tilde{B} &= \begin{bmatrix} B \\ 0 \\ 0 \end{bmatrix}_{14 \times 9}, \tilde{C} = [C \ 0 \ 0]_{1 \times 14} \end{aligned} \quad (16)$$

The full process state  $x \in \mathfrak{R}^3$  and unmeasurable disturbance state  $x_{umd} \in \mathfrak{R}^3$  are estimated from the plant measurement  $y$  by means of an infinite horizon Kalman Filter.  $Q_w$  is the process noise covariance matrix and  $R_v$  is the measurement error covariance matrix. The process and measurement noise  $w$  and  $v$  are assumed to be uncorrelated zero-mean Gaussian processes. The measurable disturbance state  $x_{md} \in \mathfrak{R}^8$  is assumed to remain unchanged within the prediction horizon and equal to the constant at the last measured value, namely  $x_{umd}(k) = \hat{x}_{umd}(k+1/k) = \dots = \hat{x}_{umd}(k+H_p-1/k)$ . For time varying reference tracking, it is necessary to reformulate the system dynamics in  $\Delta u$ -form to introduce an integral controller [12] as stated in (17):

$$\begin{bmatrix} \tilde{x}(k+1) \\ u(k) \\ x_{ref}(k+1) \end{bmatrix} = \begin{bmatrix} \tilde{A} & \tilde{B} & 0 \\ 0 & I & 0 \\ 0 & 0 & I \end{bmatrix} \cdot \begin{bmatrix} \tilde{x}(k) \\ u(k-1) \\ x_{ref}(k) \end{bmatrix} + \begin{bmatrix} \tilde{B} \\ I \\ 0 \end{bmatrix} \cdot \Delta u(k) \quad (17)$$

## IV. SIMULATION RESULTS

In order to demonstrate the high potential of MPC for automatic control of the ventilation systems and the associated climate in livestock barn, the comparison between the system behaviors performed with and without controller, are presented in this section.

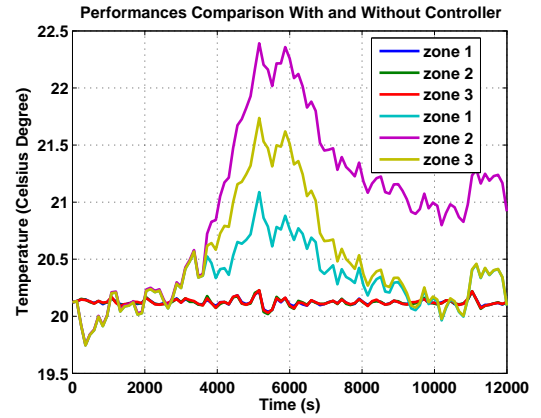

Fig. 5. Comparison of Dynamic Performances of Zonal Temperature with and without MPC

Fig. 5 is derived in the presence of stochastic disturbances from external temperature with mean value  $10^\circ\text{C}$  and wind speed with mean value  $3\text{ m/s}$ , which are both generated from random sources through low-pass filters. The heat dissipated from animals of each zone is set by pulse change, for instance, adding  $2000\text{ J/s}$  in the middle zone, and adding  $1000\text{ J/s}$  in one of the other two zones. The system initially started from operating point which is defined by heating status, shutter opening angle and outside disturbances aiming at maintaining the system behavior at the required condition with low horizontal variation. The output reference value is  $20.1^\circ\text{C}$  and the reference control signal for air inlet opening on the windward side are 0.05, 0.053, 0.05, on the leeward

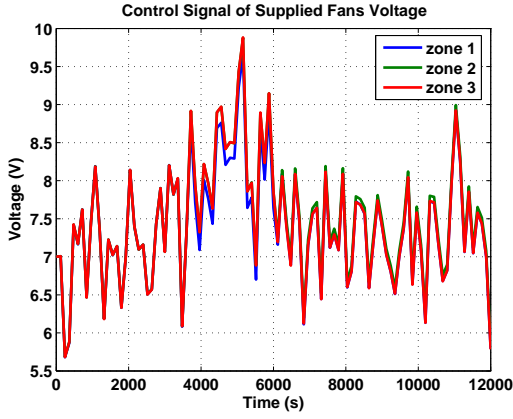

Fig. 6. Control Signals of Exhaust Fans

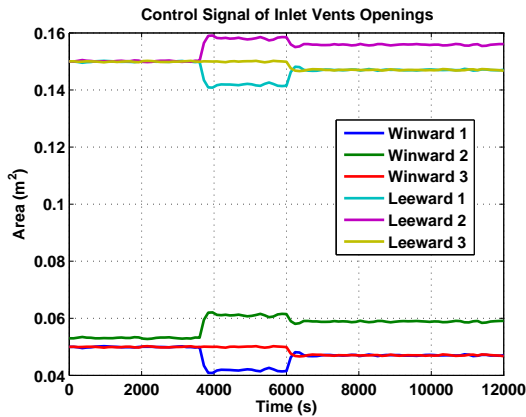

Fig. 7. Control Signals of Inlet Vents

side are 0.15, 0.15, 0.15, and supply 7 Voltage for each of the exhaust fan.

The open-loop performing curves (dashed lines) in Fig. 5 demonstrates the system dynamic performances with fixed reference control inputs to the nonlinear system, and clarifies how the indoor climate influenced by the external weather and indoor heat sources. The close-loop performing curves (solid lines) in Fig. 5 illustrates the results with updated optimum control inputs to the nonlinear system computed from optimization computations at each sample time. The control algorithm is implemented within the MATLAB programming environment applying the Multi-Parametric Toolbox [12]. Because of the slow response of the nonlinear system behavior (the time constant is around 30 min), the sampling time step is defined to be 2 min, the prediction horizon is  $H_p = 12(24\text{min})$ , and the control horizon is  $H_u = 3(6\text{min})$ . The inlet vent is limited within  $0\text{m}^2\text{-}0.3\text{m}^2$ , the supplied voltage to the fan is limited within  $0\text{V}\text{-}10\text{V}$ , the slew rate of the actuators are very fast compared with the sample time step and could be ignored. For animal thermal comfort, the indoor temperature is limited to  $\pm 1^\circ\text{C}$  around the reference value. Tracking errors are penalized over the whole prediction horizon. The weights on tracking errors  $Q$  is same at each point in the prediction horizon, the weights

on control moves  $R$  is same at each point in the control horizon.

Through comparing the simulation results, we could recognize that with the application of MPC, the system behavior has been profoundly modified, the variance of the output has been reduced considerably by adjusting the six inlet openings and three exhaust fans as shown in Fig. 6 and Fig. 7 respectively, and therefore, the majority of the outdoor disturbances to the inside temperature have been effectively rejected.

To some extent, for the above introduced magnitude of the disturbance change, none of the constraints are active at any point of the transient. Suppose now, the system is operated with some pulse changes appeared in the external temperature which will lead to the large offset from the reference value and active constraints. As described in Fig. 8, 9, Fig. 10, the indoor temperature tendency spreads smoothly around the set-point value without large variations; the voltages of the fans are immediately raised in response to the onset of the disturbance, and be ranged against the constraint, hold the value below the constraint while the disturbance is present, and finally fall down when the disturbance ceases; the inlet openings are controlled within constraints and show some similar aggressive behaviors as the fans when disturbances enter the system. Therefore, the advantage of MPC handling constraints in a natural and flexible way, is manifested through this example.

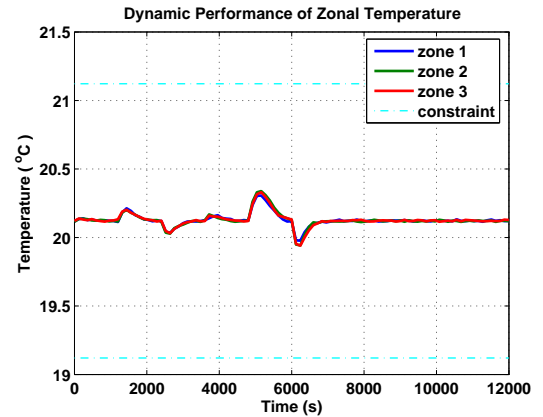

Fig. 8. Dynamic Performance of Zonal Temperature with MPC (when constraints active)

The above simulations are carried out based on one controller for nonlinear plant, by assuming that the heating system is controlled to remain at a constant value. Through step response analysis and behavior observation, we realize that, the plant nonlinearities is not very obvious. By varying the disturbances such as the zonal heat sources which cause the direction change of the inter zonal airflow, and external temperature which is the most direct influence in leading to the variation of the indoor thermal comfort, we obtain similar system performance with a serious of LTI models.

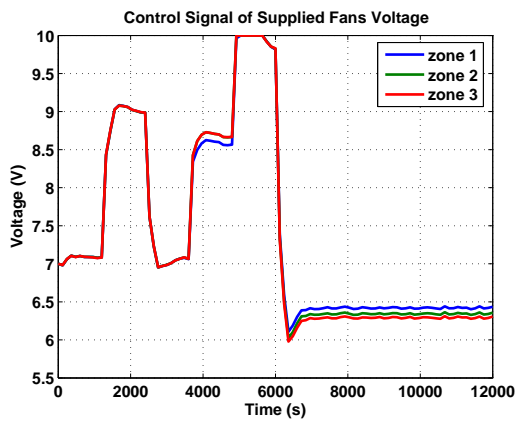

Fig. 9. Control Signals of Exhaust Fans

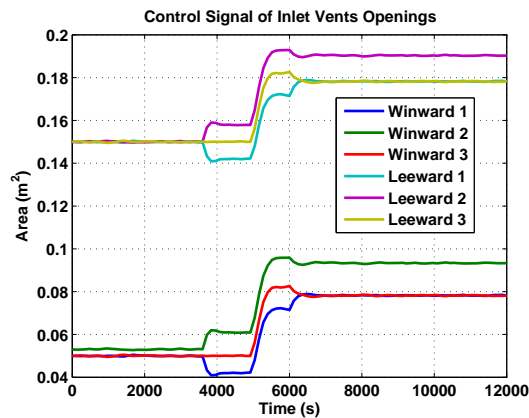

Fig. 10. Control Signals of Inlet Vents

## V. CONCLUSIONS AND FUTURE WORK

### A. Conclusions

Aiming at improvement of performances and optimization of energy, the main achievement of this work is the efficient application of MPC for livestock ventilation systems.

In this paper, through linearization of the nonlinear system, an LTI model in terms of state space representation which connected the thermal system and air distribution system is derived, and augmented by the developed unmeasured disturbance model to achieve offset-free control. The presented simulation results show the significant advantages of using MPC over linear models for control and estimation by choosing appropriate horizon length, weighting matrix and noise covariance matrix. Further more, it proves to be fruitful that the conceptual multi-zone models for thermal comfort contain significant information on horizontal variation which is not able to be captured by the single zone model with mean temperature and concentration, under the circumstances that the zonal disturbances changes.

### B. Future Work

A weather filter will be designed according to the fast and slow frequency change of the wind and temperature, so that the swivel shutter of the fan and heating system will

be controlled automatically to attenuate the wind gust and adjust the indoor thermal environment. The entire control system will be identified through experiments in a real scale livestock barn equipped with hybrid ventilation systems in Syvsten, Denmark, and the result will be compared with those obtained with currently used classical PID controller.

## VI. ACKNOWLEDGMENTS

The authors gratefully acknowledge the contribution and financial support from the Danish Ministry of Science and Technology (DMST), and Center for Model Based Control (CMBC) under Grant: 2002-603/4001-93.

## REFERENCES

- [1] J.A. Clark, *Environmental Aspects of Housing for Animal*, Butterworth Heinemann, England; 1981.
- [2] P. Heiselberg, *Principles of Hybrid Ventilation, IEA Energy Conservation in Buildings and Community Systems Program, Annex 35: Hybrid Ventilation in New and Retrofitted Office Building*, Aalborg, Denmark, 2002.
- [3] J.M. Maciejowski, *Predictive Control with Constraints*, Prentice Hall, England; 2002.
- [4] J.A. Rossiter, *Model-based Predictive Control, A Practical Approach*, CRC Press, Boca Raton, Florida; 2003.
- [5] J. Richalet, A. Rault, J.L. Testud, J. Papon, Model Predictive Heuristic Control: Applications to Industrial Processes, *Automatica*, vol. 14, 1978, pp 413-428.
- [6] G. Pannocchia, N. Laachi, J.B. Rawlings, A Candidate to Replace PID Control: SISO-Constrained LQ Control, *AIChE J.*, vol. 51, 2005, pp 1178-1189.
- [7] P. Heiselberg, *Natural and Hybrid Ventilation*, Aalborg University, Aalborg, Denmark; 2004.
- [8] Z. Wu, P. Heiselberg, J. Stoustrup, "Modeling and Control of Livestock Ventilation Systems and Indoor Environments", in *26th AIVC Conference on Ventilation in Relation to the Energy Performance of buildings*, Brussels, Belgium, 2005, pp. 335-340.
- [9] D. L. Ingram, Heat loss and its control in pigs, *Heat loss from animals and man*, pp 233-254, Butterworths, London, 1974.
- [10] G. Pannocchia, J.B. Rawlings, Disturbance models for offset-free model predictive control, *AIChE J.*, vol. 49, 2003, pp 426-437.
- [11] K.R. Muske, T.A. Badgwell, Disturbance Modeling for Offset Free Linear Model Predictive Control, *J.Proc.Control*, vol. 12(5), 2002, pp 617
- [12] M. Kvasnica, P. Grieder, M. Baoti, Multi-Parametric Toolbox (MPT), <http://control.ee.ethz.ch/~mpt/>, 2004.