



**AALBORG UNIVERSITY**  
DENMARK

**Aalborg Universitet**

## **Harmonic Domain Modelling of a Distribution System using the DigSilent PowerFactory Software**

Wasilewski, J.; Wiechowski, Wojciech Tomasz; Bak, Claus Leth

*Published in:*

Proceedings of The International conference on future Power Systems

*Publication date:*

2005

*Document Version*

Peer reviewed version

[Link to publication from Aalborg University](#)

*Citation for published version (APA):*

Wasilewski, J., Wiechowski, W. T., & Bak, C. L. (2005). Harmonic Domain Modelling of a Distribution System using the DigSilent PowerFactory Software. In Proceedings of The International conference on future Power Systems

### **General rights**

Copyright and moral rights for the publications made accessible in the public portal are retained by the authors and/or other copyright owners and it is a condition of accessing publications that users recognise and abide by the legal requirements associated with these rights.

- ? Users may download and print one copy of any publication from the public portal for the purpose of private study or research.
- ? You may not further distribute the material or use it for any profit-making activity or commercial gain
- ? You may freely distribute the URL identifying the publication in the public portal ?

### **Take down policy**

If you believe that this document breaches copyright please contact us at [vbn@aub.aau.dk](mailto:vbn@aub.aau.dk) providing details, and we will remove access to the work immediately and investigate your claim.

# Harmonic domain modeling of a distribution system using the DIgSILENT PowerFactory software

Jacek Wasilewski, Wojciech Wiechowski and Claus Leth Bak

**Abstract**—The first part of this paper presents the comparison between two models of distribution system created in computer simulation software PowerFactory (PF). Model A is an existing simplified equivalent model of the distribution system used by Transmission System Operator (TSO) Eltra for balanced load-flow calculation and stability studies. Model B is accurate model of the distribution system created on the basis of the detailed data of the investigated network and is used as a reference. The harmonic impedance of the two models is compared. In the second part of the paper, the sensitivity of the harmonic impedance to basic system parameters (load active power, motor load fraction and reactive power of PFC capacitors) is analyzed.

**Index Terms**—Harmonic analysis, frequency domain analysis, power system modeling, simulation software

## I. INTRODUCTION

SINCE some time Danish TSO Eltra has recognized that harmonic currents and voltages propagate in 400 kV transmission network. The appearance of harmonics may cause the malfunction of protective and measuring equipment. One of the reasons of the increase of harmonic level is the constantly growing number of non-linear loads connected at the lower voltage levels, as for instance computers, fluorescent lamps, arc furnaces, etc.

The whole Eltra's transmission system is modelled using a computer simulation program DIgSILENT PowerFactory (PF). This software is a computer aided engineering tool for analysis of electrical power systems. PF is equipped with ready-to-use models of different power system components. This computer model of Eltra's transmission system is presently used for load-flow and stability studies. Therefore all 400 kV and 150 kV transmission lines and cables, large generators and autotransformers are modelled in details. The lower voltage levels, i.e. 60 kV and below are represented as simplified

equivalent models. It has been decided that the existing computer model shall be extended so it could be also used for harmonic analysis.

The distribution network is connected in many places with the transmission system and that is why it is expected that their impedance will have a significant effect on the propagation of harmonics on the transmission level. The harmonic impedance of a distribution system seen from the higher voltage side varies in the frequency. Therefore distribution feeders make a harmonic filter function for flow of harmonic currents in transmission system. For that purpose one, representative part of distribution network is closely investigated.

## II. DESCRIPTION OF THE MODELLED DISTRIBUTION NETWORK

The analyzed distribution system belongs to the company Himmerlands Elforsyning (HEF) and is supplied from 150 kV busbar installed in Vilsted (VIL) substation. Such a distribution feeder is shown in Fig. 1.

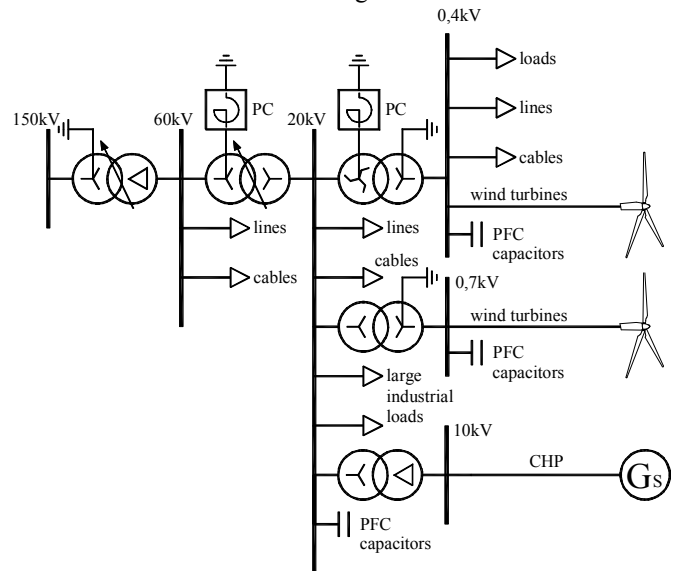

Fig. 1. Simplified diagram of investigated distribution feeder.

Analyzed distribution system contains the following 60/20 kV substations: Aggersund (AGG), Farsø (FSØ), Løgstør (LGS) and Nibe (NIB). Each 60/20 kV substation includes one or two distribution transformers (10, 16, 20 and 25 MVA), single or double 60 kV and 20 kV busbar system, and PFC

J. Wasilewski is with the Institute of Electrical Power Engineering, Warsaw University of Technology, 00661 Warsaw, Poland (e-mail: java81@o2.pl).

W. Wiechowski and C. L. Bak are with the Institute of Energy Technology, Aalborg University, 9220 Aalborg, Denmark (e-mail: wtw@iet.aau.dk, clb@iet.aau.dk).

capacitors, all of them installed on the 20 kV voltage level. To all of the 60/20 kV substations some wind turbines are connected. All of them are connected to the 0,4 kV and 0,7 kV network. Next group of distributed power generation constitutes combined heat and power plants (CHP). It is about 30% of the dispersed power generation in HEF distribution system. The 20 kV network supplies small distribution substations 20/0,4 kV and large industrial loads. The majority of the electrical energy consumers are supplied from the 0,4 kV network. Basic description of investigated distribution feeder is presented in Table I.

TABLE I  
BASIC INFORMATION ABOUT ANALYZED DISTRIBUTION SYSTEM

Rated apparent power of installed transformers in substations	150/60 kV – 80 MVA 60/20 kV – 10, 16, 20 and 25 MVA
Total length of the 60 kV overhead lines	54,5 km
Total length of the 60 kV underground cables	not appear
Installed active power of wind turbines	70 877 kW
Installed active power of CHP	19 228 kW

### III. EQUIVALENT MODEL OF A DISTRIBUTION SYSTEM – MODEL A

Existing PF model of the transmission system is presently used for load-flow and stability studies. For that purpose, it is necessary to model in detail the whole 400 kV and 150 kV grids, but it is sufficient to model all the 60 kV level and below in simplified way – using the network equivalents. This representation of a distribution system is called Model A and it is shown in Fig. 2.

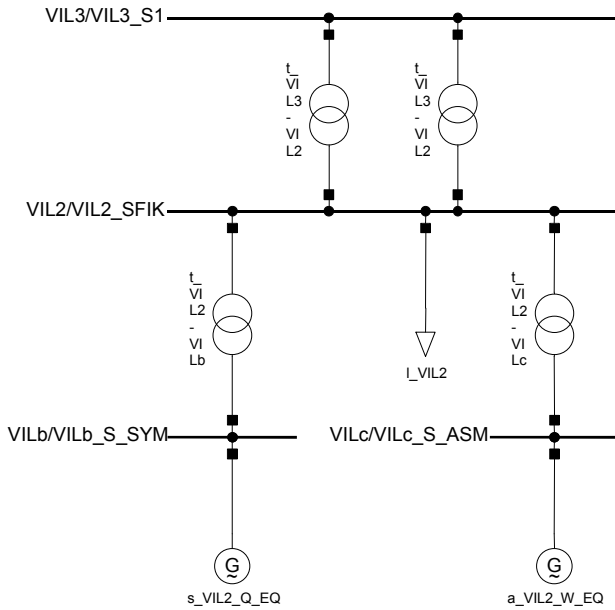

Fig. 2. Diagram of distribution system represented by Model A.

The generators and the loads are modelled as aggregated components. The equivalent synchronous generator represents

total power generation in CHP. It is connected to 10 kV busbar and supplies 60 kV busbar through an equivalent transformer representing all unit transformers installed in CHP. The equivalent induction generator represents total power generated by wind turbines. It is connected to 0,7 kV busbar and supplies 60 kV busbar through an equivalent transformer representing all transformers connected wind turbines and medium voltage network. All other domestic and industrial loads are aggregated and modelled as one resistive and inductive load and connected directly to the 60 kV busbar. The equivalent model does not include underground cables, overhead lines and PFC capacitors. Transformer windings connections and neutral system of 60 kV network are not modelled, because Model A is used for balanced positive-sequence load-flow calculations and zero-sequence impedance are of no importance for this kind of analysis.

### IV. EXACT HARMONIC DOMAIN MODEL OF THE DISTRIBUTION SYSTEM – MODEL B

In order to verify if the existing Model A sufficiently accurate represents the harmonic impedance of the distribution network seen from the transmission level, a very precise and detailed model of the distribution system has been created – Model B.

Very detailed data has been obtained from Eltra and HEF companies, and all the components have been modelled using commonly accepted theories recommended in the harmonic analysis literature [1], [6]-[8]. All of the harmonic domain models will be described in the following sections.

#### A. Overhead lines and underground cables

The overhead lines and underground cables are modelled by pi-circuit equivalent representation using distributed parameters [1]. Nominal line parameters can be expressed

$$\begin{aligned} Z' &= R' + jhX' \\ Y' &= jhB' / 2 \end{aligned} \quad (1)$$

Corrected model of line (cable) for harmonic analysis is shown in Fig. 3.

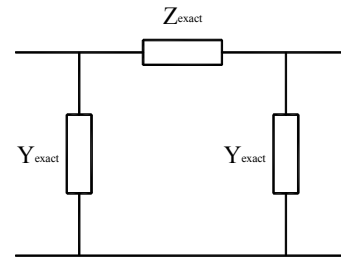

Fig. 3. Exact equivalent pi-circuit model for line and cable.

$$\begin{aligned} Z_{exact} &= Z_0 \sinh(\gamma l) \\ Y_{exact} &= \frac{1}{Z_0} \tanh \frac{\gamma l}{2} \end{aligned} \quad (2)$$

where  $\gamma = \sqrt{Z'Y'}$  is a propagation constant and  $Z_0 = \sqrt{Z'/Y'}$  is a characteristic impedance.

Due to the skin effect, the series conductor resistance is

frequency dependent. PF allows to model the frequency dependence using Frequency Polynomial Characteristic [5].

$$y(f_h) = (1-a) + a \left( \frac{f_h}{f_1} \right)^b \quad (3)$$

where the parameters  $a = 1$  and  $b = 0,5$ . The line frequency dependent resistance is expressed

$$R'(f_h) = R^1 \cdot y(f_h) \quad (4)$$

This line model is valid for positive-, negative- and zero-sequence. The long-line effect is more significant for underground cables, due to higher values of shunt capacitances in comparison with overhead lines [8].

### B. Transformers

The transformers are modelled by a T equivalent circuit. The parameters of the equivalent circuit are determined from the vector group, transformer ratio and the quantities computed from short-circuit and open-circuit measurements. Due to the fact that the natural resonant frequencies of transformers appear usually above 5 kHz [4] and the winding capacitances are relatively small compared to line capacitances, the winding capacitances are not included in calculations.

For positive- and negative-sequence, the equivalent model of transformer is shown in Fig. 4.

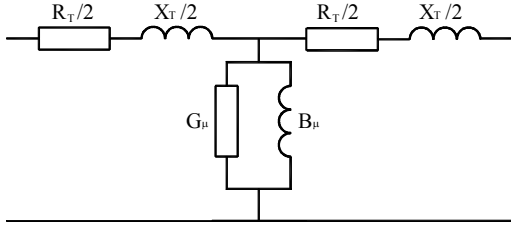

Fig. 4. The equivalent model of transformer for positive- and negative-sequence.

The equivalent transformer model for zero-sequence is dependent on the winding connections. Investigated distribution system consists of six transformers with Yy0 connection and two transformers with YNy0 connection. For Normal Operating Condition (NOC), one of the transformers operates with 60 kV neutral point compensated through Petersen Coil (PC). Except the transformer grounded through PC, the zero-sequence impedance for all other transformers approaches infinity (Yy0 winding connection blocks flow for zero-sequence currents [4]).

### C. Synchronous machines

Because of the large number of small size CHP units, it would be difficult and very time-consuming to obtain all the necessary parameters for each particular CHP unit. Therefore, equivalent models for all CHP units connected to each 20 kV substation are created. The equivalent models are connected to 20 kV busbars through 20/10 kV transformer adapted to equivalent generator rated apparent power. The unit parameters for synchronous generators are taken from Model

A and referred to their rated power value. It is assumed, that all the generators are salient pole type. In Model B, the synchronous machine is represented for positive- and negative-sequence by the stator resistance  $R_{st}$  and average subtransient reactance value  $X''_{av}$  [7].

$$X''_{av} = \frac{X''_d + X''_q}{2} \quad (5)$$

$$Z_{sg} = y(f_h)R_{st} + jhX''_{av} \quad (6)$$

The frequency dependence of stator resistance is modelled using (3).

The synchronous machines block zero-sequence harmonic currents, because their stator windings are connected in delta or ungrounded. Therefore zero-sequence impedance is infinite.

### D. Induction machines

In the investigated network, all the wind turbines are the fixed speed induction machines compensated with PFC capacitor banks [3]. In Model B, they are built as equivalent models installed to 0,7 kV busbar and connected through 20/0,7 kV transformers to 20 kV busbar in each distribution substation. The value of transformer rated apparent power and value of equivalent generator rated apparent power are equal. The reactive power consumed by induction generators is compensated by the PFC capacitor banks, which are connected to 0,7 kV busbar. The unit rotor and stator parameters, synchronous and nominal speed values are taken from asynchronous generator equivalent in Model A. It is assumed that all the induction machines are built as squirrel cage type. In Model B, the asynchronous machine is represented for positive and negative sequence by the stator resistance  $R_{st}$ , rotor resistance  $R_r$  dependent on the slip, rotor reactance  $X_{st}$  and stator reactance  $X_r$  [1]. The representation of induction machine is shown in Fig. 5.

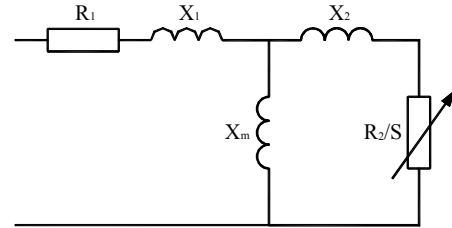

Fig. 5. The induction machine model.

The harmonic impedance is expressed as

$$Z_{ag} = R_1 + \frac{R_2}{S_h} + jh(X_1 + X_2) \quad (7)$$

$S_h$  is apparent slip at the increased frequency

$$S_h = \frac{\pm h\omega_s - \omega_r}{\pm h\omega_s} \quad (8)$$

The plus sign is for positive-sequence and the minus sign is for negative-sequence.

Due to skin effect, the resistance is dependent on frequency by  $y(f_h)$  formula, expressed in (3). The magnetizing branch is

neglected, because all the parameters are taken with the rotor locked.

The induction machines do not provide a path for zero-sequence harmonic currents, because they are connected in delta or ungrounded wye [8].

### E. Load models

The one single rule of determining load equivalents for harmonic analysis does not exist [6]. The derivation of harmonic resistance and reactance from given active  $P$  and reactive  $Q$  power flow will need additional information on the actual composition of the load. Power distribution companies should provide the information about participation for each type load in the system depending on the time of day. The domestic loads constitute not only the main element of the damping component, but may affect the resonance conditions at higher frequencies.

In Model B, a load model is represented as parallel impedance with passive (resistance  $R_2$  and reactance  $X_2$ ) and motive part (resistance  $R_1$  and reactance  $X_1$ ) [6]. Such representation is shown in Fig 6. These parameters are determined on the basis of load active power  $P$  and motor load fraction  $K$ .

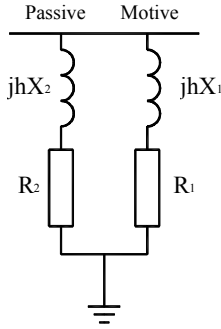

Fig. 6. Load model representation.

PF allows to model the loads by series resistance and reactance. Therefore, the load has been modelled by two separate impedances (passive and motive part).

$$R_2 = \frac{V^2}{(1-K)P} \quad (9)$$

$$X_1 = X_M \frac{V^2}{K_m K P} \quad (10)$$

$$R_1 = \frac{X_1}{K_3} \quad (11)$$

$$X_2 = 0,1R_2 \quad (12)$$

$K_m$  is install factor ( $\approx 1,2$ ),  $X_M$  is p.u. value of the motor locked rotor reactance expressed on the motor rating ( $\approx 0,2$ ) and  $K_3$  is effective quality factor of the motor circuit ( $\approx 8$ ).

Modeling the power electronic loads is a more difficult problem, because besides being harmonic sources, these loads do not present a constant RLC configuration and their non-linear characteristics cannot fit within the linear harmonic equivalent model [1]. In the absence of detailed information

the power electronic loads are neglected in the analysis.

### V. THE COMPARISON OF MODEL A AND MODEL B

The magnitude and phase angle of the harmonic impedance for Model A and Model B is shown in Fig. 7. The harmonic calculation has been carried out for positive- and negative-sequence using *frequency sweep* option [5].

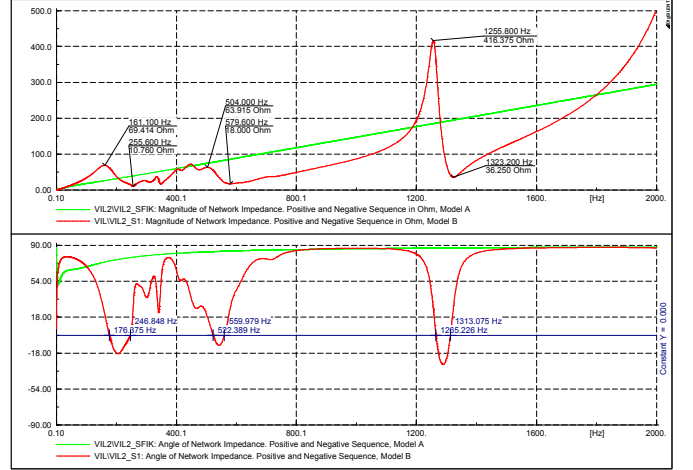

Fig. 7. Positive and negative-sequence harmonic impedance for Model A and Model B.

The values of impedance magnitude for the most frequently appearing harmonic currents are presented in Table II. The discrepancy between values of impedance for Model A and B are significant. For instance, the discrepancy of impedance magnitude for 25<sup>th</sup> harmonic is above 100%.

TABLE II  
IMPEDANCE MAGNITUDE FOR SELECTED HARMONIC ORDER

Harmonic order	Impedance magnitude	
	Model A	Model B
5	39,1Ω	13,3Ω
7	53,3Ω	18,5Ω
11	82,2Ω	28,4Ω
13	96,7Ω	26,4Ω
23	170,0Ω	142,3Ω
25	184,7Ω	397,7Ω

The curve of harmonic impedance magnitude for Model A is linear. The phase angle approaches 90°. In this case, resonance effects do not appear, because the model does not include any capacitances. All the system components are modelled by resistance and reactance, therefore the curve of harmonic impedance magnitude is linear.

Looking at the harmonic impedance for Model B, it can be seen, that in the frequency range from 80 Hz up to approx. 800 Hz significant variations of the harmonic amplitude and phase angle can be observed. It has been found out that these variations are related to the interaction between inductive system components and capacitance of PFC elements. Maximum and minimum values of harmonic impedance magnitude and zero values for phase angle of harmonic impedance are not at the same frequency value. It means that

for discussed frequency range, the main resonance for all system components does not appear. Fig. 8 shows the influence of installed PFC capacitor banks on harmonic impedance curve in mentioned frequency range. The reference curve is performed for all PFC capacitors connected to the system. In case of disconnection of PFC devices from wind turbines busbar or from 20 kV busbar, it can be observed the less number of resonances at lower frequency range compare to reference curve.

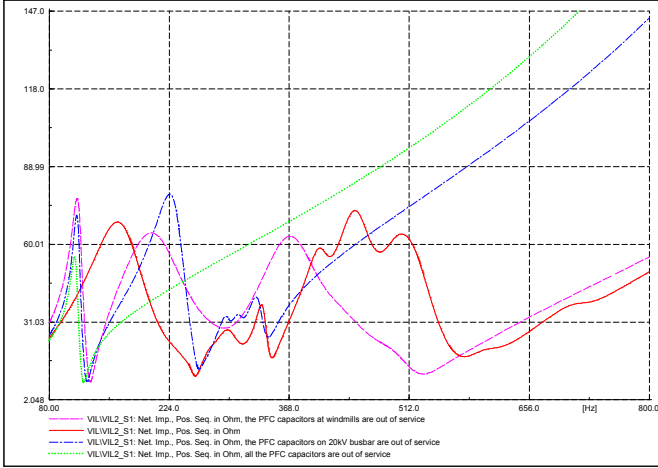

Fig. 8. The influence of installed PFC capacitors on harmonic impedance for Model B in low frequency range.

The second area consists of the resonance effects at frequencies: 1258,8 Hz (parallel resonance) and at 1323,2 Hz (series resonance). It has been revealed that it is determined by system components in one of the substations (AGG). In Fig. 9, the harmonic impedance curves for different values of reactive power of PFC capacitor connected and to 20 kV busbar are shown. If reactive power decreases, the considered resonance shifts towards the main resonance at higher frequency. The asynchronous machine equivalent includes low value of inductive reactance (in comparison with all of machine equivalent models). This inductance resonates with the PFC capacitor connected to the 20 kV busbar in the substation.

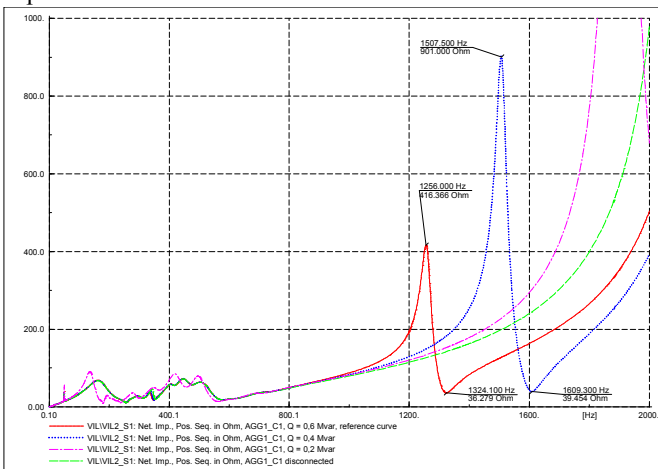

Fig. 9. The influence of PFC capacitor in AGG substation on harmonic impedance.

In the end of considered frequency range, close to 2 kHz, the trend to parallel resonance effect is observed. All the distribution system components (inductive and capacitive) resonate to each other. The resonance frequency is determined by the capacitance of 60kV lines, PFC devices and inductance of synchronous and asynchronous machines, transformers and loads.

The zero-sequence harmonic impedance for Model A and Model B is presented in the Fig. 10.

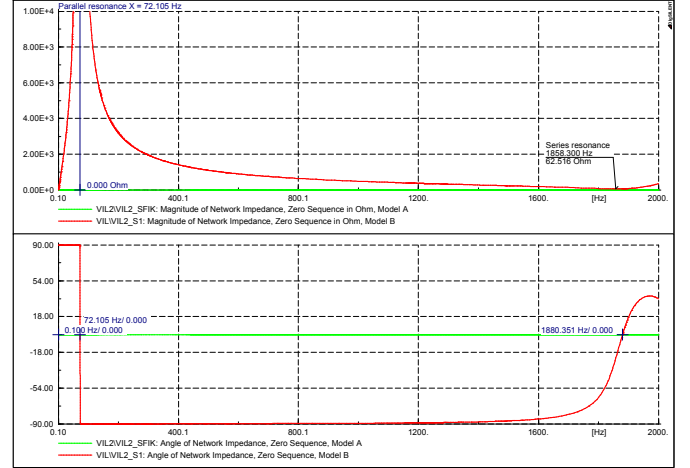

Fig. 10. Zero-sequence harmonic impedance for Model A and Model B.

Analyzing zero-sequence harmonic impedance for Model A, the impedance magnitude and angle equals zero, because the models of transformers do not include zero-sequence parameters and the both windings of transformers are wye connected with directly grounded neutral point. Therefore, the way for zero-sequence flow has zero value of impedance.

For Model B, two resonances are observed. The parallel resonance appears at 72,105 Hz frequency. It is effect of a resonance between the inductance of PC and capacitance of 60 kV lines. The inductance of PC is tuned to 50 Hz frequency.

$$L_{PC} = \frac{1}{3\omega^2 C_0} \quad (13)$$

The distribution network should not operate in overcompensated condition. Therefore the reactance value of PC is lower in comparison of total capacitive reactance of lines. This is the reason that parallel resonance appears above 50 Hz frequency. The amplitude of harmonic impedance approaches infinity, because the resistance of PC used in Model B equals zero. The series resonance at 1880,3 Hz frequency is observed. It is determined by zero sequence (inductive and capacitive) reactances of 60 kV lines.

## VI. MODIFICATION OF MODEL A

The curve of positive- and negative-sequence harmonic impedance for Model A and Model B are not close. The Model A does not include the resonance effects, because it does not consist capacitance components. The discrepancy of impedance magnitude for Model A and Model B is significant. Besides, Model A does not take the impedance for zero-

sequence into consideration. To accomplish harmonic impedance curve close to Model B, the modification of Model A for all sequences has been made. After the corrections are applied to this model, Model A can be used for detailed harmonic analysis, for instance on transmission system level as more accurate distribution feeder equivalent. The substitute capacitance for distribution system is modelled by the 60 kV line representation connected to the main 60 kV busbar and operated in no-load state. The line model includes only shunt capacitance parameters. The values of series resistance and reactance should be close to zero. The line capacitance is modelled separately for positive-, negative- and for zero-sequence. It is possible to use shunt capacitors instead, but then it would be necessary to filter the zero sequence (for example, the shunt capacitor should be also connected to the wye neutral point of transformer). For this approach, the use of two components would be needed. First, for positive- and negative-sequence and second, for zero-sequence. The susceptance for the 60 kV substitute line model can be expressed

$$B_{SL(1,2)} = k_{L(1,2)} \cdot B_{L(1,2)} \quad (14)$$

$$B_{SL(0)} = \frac{B_{L(0)}}{k_{L(0)}} \quad (15)$$

$B_{L(1,2)}$  and  $B_{L(0)}$  are positive-, negative- and zero-sequence total susceptance for all the 60 kV lines in investigated distribution system. Correction factors  $k_{L(1,2)}$  and  $k_{L(0)}$  for positive-, negative- and zero-sequence are dependent on the type and the network structure. Minimum value of average discrepancy for  $k_{L(1,2)} = 0,26$  and  $k_{L(0)} = 0,7$  was obtained. At this moment, it is difficult to state if the calculated factor is correct for each of distribution feeders. This problem should be analyzed for selected distribution networks.

Harmonic impedance curve for Model B and modified and unmodified Model A is presented in Fig. 11.

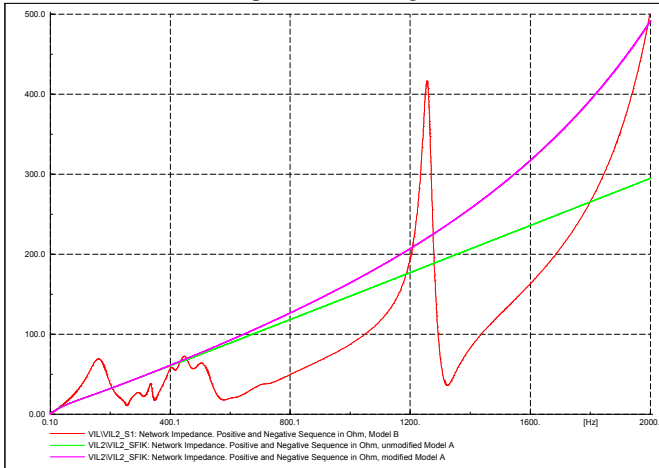

Fig. 11. The positive- and negative-sequence impedance magnitude for Model B, unmodified Model A and modified Model A.

Looking at Fig. 11, the main resonance effect (above 2 kHz) for modified Model A is observed. It is determined by total capacitance and inductance of all components in Model A.

Modified harmonic impedance curve for Model A is close to harmonic impedance curve for Model B only at higher frequencies (2 kHz). For lower values of frequency, the modification of Model A gives worse results compared to unmodified Model A. The discrepancy between impedance magnitude for unmodified and modified Model A and impedance magnitude for Model B is shown in Fig. 12.

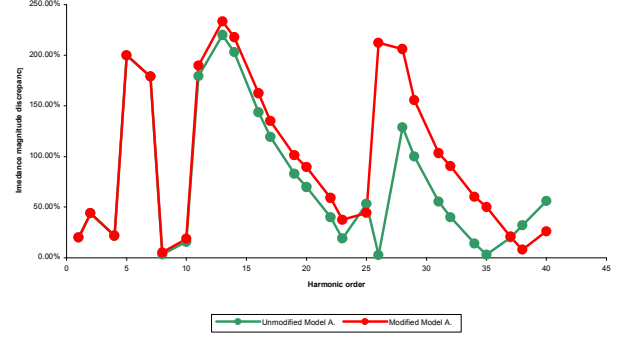

Fig. 12. The comparison of discrepancy between positive- and negative-sequence impedance magnitude for investigated cases.

Analyzing the modification test of Model A for positive- and negative-sequence, it can be concluded, that Model A should not be corrected in this way. The value of harmonic impedance discrepancy at significant frequency range for harmonic analysis (up to 25<sup>th</sup> harmonic) is higher in comparison of unmodified Model A.

In case of modification of Model A for zero-sequence, it is necessary to model the PC connected to the neutral point of wye winding in one of transformers. The value of PC inductance is the same, like in Model B. The resonance frequency is very close to the frequency for Model B (72,105 Hz). Except the lines capacitance and PC, the rest of system components should not include the flow for zero sequence. Therefore, the load model and the 60 kV side of second transformer should be ungrounded wye or delta connected. The comparison of harmonic impedance magnitude for Model B and modified on the basis of above-mentioned principles Model A is presented in Fig. 13.

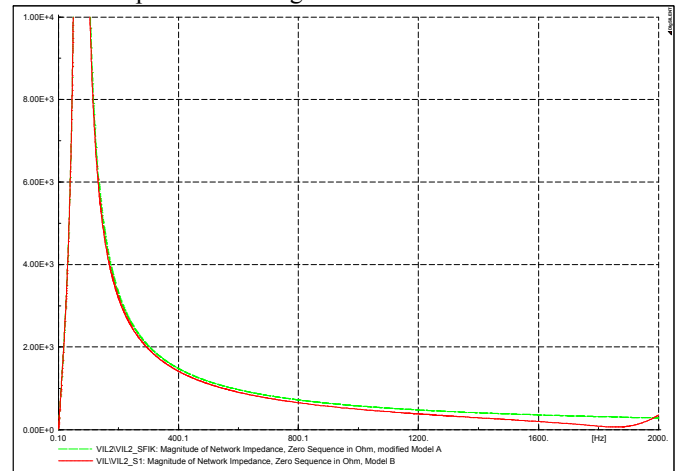

Fig. 13. Zero-sequence impedance magnitude for Model A and modified Model B.

Looking at Fig. 14, the discrepancy values for zero-sequence increase along with the frequency.

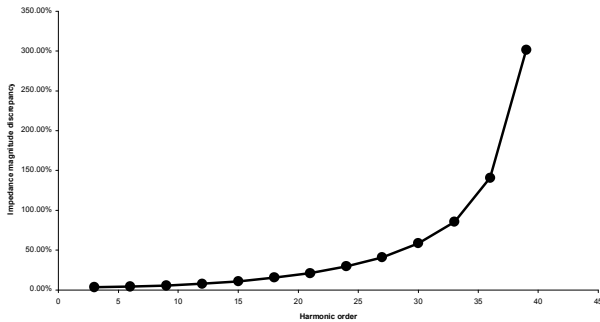

Fig. 14. The discrepancy of zero-sequence impedance magnitude between modified Model A and Model B.

For significant harmonic order (3, 9, 15, 21) the discrepancy between impedance magnitude for Model B and corrected Model A is relatively small. The most important thing for zero sequence analyzing is correct neutral system representation. For 60 kV network, the only flow for zero sequence currents is through the capacitance of 60 kV lines and PC. These system components cause the resonance effect a little bit above 50 Hz, due to the lower value of inductive reactance for PC than the value of capacitive reactance for 60kV overhead and cable lines.

## VII. CONCLUSIONS

This paper discussed and analyzed problems related to harmonic calculations in PF software. In closing of the paper, the following conclusions can be drawn:

- The detailed distribution system model (Model B) was created for harmonic analysis. Each of the system elements was created basis of the state of the art calculations of the harmonic analysis literature. PF software makes possible to model system components in harmonic domain in simple way. Model B was used as reference representation for harmonic studies. The most accurate verification of Model A is to make a measurement. Besides, more accurate system model (Model B) represents real harmonic impedance to a larger extent than Model A
- Using *frequency sweep* function in PF, the harmonic impedance (magnitude and angle) was computed for Model A and B and compared. For all sequences, harmonic impedance curves for Model A and Model B are not close (the discrepancy is significant). System components are not modelled for zero-sequence in Model A Therefore, applying Model A for harmonic analysis, it is necessary to take into account big errors in calculation.
- The modification of Model A makes a sense for only zero-sequence. For significant harmonic frequency range, the results are satisfied. The modification test for positive- and negative-sequence has not been successful. The results have been worse compared to unmodified Model A. It is very difficult to model in simple way resonance effects determined by inductive and capacitive components

installed in 60/20 kV substations and below. Therefore, the paper suggests the modification of Model A for zero-sequence only.

## VIII. ACKNOWLEDGMENT

The authors wish to gratefully acknowledge the contributions of J. Bak-Jensen from Himmerlands Elforsyng and H. Abildgaard from Eltra for help to get necessary data of investigated distribution power system.

## IX. REFERENCES

- [1] J. Arrillaga, B. C. Smith, N. R. Watson, A.R. Wood, *Power System Harmonic Analysis*, Chichester: John Wiley & Sons, 1997, p. 46, 104.
- [2] S. Bolkowski, *Teoria Obwodów Elektrycznych*, Warszawa: WNT, 1997, p. 146.
- [3] N. Jenkins, R. Allan, P. Crossley, D. Kirschen, G. Srbac, *Embedded Generation*, London: The Institution of Electrical Engineers, 2000, p.37.
- [4] S. Kujczyk, *Elektroenergetyczne Układy Przesyłowe*, Warszawa: WNT, 1997, p. 131.
- [5] PowerFactory Users Manual, ver. 13.1, 2005.
- [6] Task Force on Harmonic Modeling and Simulation, IEEE Power Eng. Soc. T&D Committee, "Impact of Aggregate Linear Load Modeling on Harmonic Analysis: A Comparison of Common Practice and Analytical Models," in *IEEE Transactions on Power Delivery*, Vol. 18, No. 2, April 2003, pp. 625-630.
- [7] A. C. Williamson: "The Effects of System Harmonics upon Machines," in *International Conference on Harmonics in Power Systems*, UMIST, 1981.
- [8] W. Xu, "Component Modeling Issues for Power Quality Assessment," in *IEEE Power Engineering Review*, November 2001, pp. 12-15.

## X. BIOGRAPHIES

**Jacek Wasilewski** was born in Elblag, Poland in 1981. He received the M.Sc. degree in electrical engineering from Warsaw University of Technology in 2005. He carried out the semester project as a M.Sc. student at the Institute of Energy Technology, Aalborg University. He manages currently the electrical systems design office.

**Wojciech Wiechowski** was born in Warsaw, Poland in 1976. He received the M.Sc. degree in electrical engineering from Warsaw University of Technology in 2001. From 2002 to 2003 he worked for HVDC SwePol Link as a technical specialist. Since 2003 he has been employed at the Institute of Energy Technology, Aalborg University, where he is currently a PhD candidate. His interests include EMC, modeling of power system components and harmonic measurements in high voltage systems.

**Claus Leth Bak** was born in Ugelbølle near Århus, Denmark, on April 13, 1965. He received the B.Sc (electrical power eng.) degree in 1992 from the engineering college in Århus and the M.Sc. (electrical power eng.) degree in 1994 from institute of energy technology, Aalborg University. From 1994 to 1999 he was working at Nordjyllandsværket power plant with planning, design operation and maintenance of 150 and 60 kV substations and relay protection. He was employed as an assistant professor at the dept. Of power systems and high voltage, institute of energy technology, Aalborg University in September 1999 and is currently holding a position as an Associate Professor. Main research areas are: High voltage engineering with focus on gaseous discharges and overhead line corona, relay protection with focus on power system simulation transient testing of relays.