

# Micro Market based Optimisation Framework for Decentralised Management of Distributed Flexibility Assets

Andrea Paladin<sup>a\*</sup>, Ridoy Das<sup>b1\*</sup>, Yue Wang<sup>c</sup>, Zunaib Ali<sup>a</sup>, Richard Kotter<sup>a</sup>, Ghanim Putrus<sup>a</sup>, Roberto Turri<sup>d</sup>  
<sup>a</sup> Northumbria University, Electrical Power and Control System Research Group, 2 Ellison Place NE1 8ST, Newcastle upon Tyne, United Kingdom.  
<sup>b</sup> Newcastle University, Power System Research Group, Newcastle upon Tyne, NE1 7RU, United Kingdom.  
<sup>c</sup> University of Chichester, Department of Engineering and Design, Upper Bognor Rd, PO21 1HR, Bognor Regis, United Kingdom.  
<sup>d</sup> University of Padova, Department of Industrial Engineering, 9 Via Francesco Marzolo, 35131, Padova, Italy.

## ABSTRACT

Continuously changing electricity demand and intermittent renewable energy sources pose challenges to the operation of power systems. An alternative to reinforcing the grid infrastructure is to deploy and manage distributed energy storage systems. In this work, a micro-energy market is proposed for smart domestic energy trading in the low-voltage distribution systems in the context of high penetration of photovoltaic systems and battery energy storage systems. In addition, a micro-balancing market is proposed to address the congestions due to unforeseen energy imbalance. Centralised and decentralised management strategies are simulated in real time, based on generation and demand forecasts. In addition, electric vehicles are also simulated as potential storage solutions to improve grid operation. A techno-economic evaluation informs key stakeholders, in particular grid operators on strategies for a sustainable implementation of the proposed strategies. The results show that the micro-energy market reduces the energy cost for all grid users by 4.1-20.2%, depending on their configuration. In addition, voltage deviation, peak electricity demand and reverse power flow have been reduced by 12.8%, 7.7% and 85.6% respectively, with the proposed management strategies. The micro-balancing market has been demonstrated to keep the voltage profile and thermal characteristic within the set limit in case of contingency.

## KEY WORDS

Micro energy market, Micro balancing market, Centralised and decentralised energy management, Real-time optimisation

## HIGHLIGHTS

- Micro energy market reduced user's electricity cost
- Micro balancing market solved the network contingency
- Micro markets reduced voltage deviation, peak demand and reverse power flow
- The system operator benefitted from the decentralised management of batteries
- Decentralised management provided optimal grid operation and benefit of users

## Nomenclature

ANN	Artificial neural network
BAU	Business as usual
BESS	Battery energy storage system

<sup>1</sup> Corresponding author: ridoy.das@newcastle.ac.uk, Newcastle University, Power System Research Group, Newcastle upon Tyne, NE1 7RU, United Kingdom.

\* Andrea Paladin and Ridoy Das contributed equally to this work.

CAPEX	Capital expenditures
DER	Distributed energy resource
DG	Distributed generation
DNO	Distribution network operator
DSO	Distribution system operator
DSR	Demand side response
EFA	Energy Flexibility asset
FAMS	Flexibility asset management strategy
FIT	Feed-in-Tariff
ICT	Information and communication technology
LCOE	Levelised cost of energy
MAE	Mean Absolute Error
MBM	Micro balancing market
MCP	Market clearing price
MEM	Micro energy market
MILP	Mixed-integer linear programming
LV	Low voltage
OPEX	Operating expenses
P2G	Peer-to-grid
P2P	Peer-to-peer
PCC	Point of common coupling
POD	Point of delivery
PV	Photovoltaic
RES	Renewable energy source
RMSE	Root Mean Square Error
RTP	Real time price
SC	Self-consumption
SOC	State of charge
SS	Self-sufficiency
TOU	Time of Use
SET	Smart energy trading
TSO	Transmission system operator
V2G	Vehicle-to-Grid
WACC	Weighted average cost of capital
<b>Parameters</b>	
$B$	Number of buses in the network
$T$	Optimisation window length
$\Delta t$	Time-step resolution
$\eta_{b_i}^{ch}, \eta_{b_i}^{dis}$	Charge/discharge efficiency of $b_i$
$P_{b_i max}^{ch}, P_{b_i max}^{dis}$	Maximum charge/discharge power of $b_i$
$E_{b_i min}, E_{b_i max}$	Minimum/maximum storage energy of $b_i$
$C_{b_i}^{degr}$	Degradation cost for charge/discharge of $b_i$
$\alpha$	Constant arbitrary value for MILP implementation
$LCOE_{PV_i}$	Levelised Cost of Energy of solar PV plant installed in bus $i$
$C_{trade}^{DSO}$	Price paid by DSO/received by the prosumers for the energy traded
$C_{selling}^{profit}$	Profit of DSO every kWh sold to customers ( $E_{sell}(t)$ ) at time $t$
$C_{sell}^{average}$	Average price at which the DSO sell $E_{buy}(t)$
$e_r$	Random error used for the household load forecast model
<b>Variables</b>	
$i$	Index referring to bus $i$
$b_i, B$	Stationary BESS installed in bus $i$ , total number of BESS in the system
$t, T$	Time slot $t$ in the optimisation window $T$
$P_{net}^{PCC}(t)$	Net power exchange at PCC at time step $t$
$p_{b_i}^{ch}(t), p_{b_i}^{dis}(t)$	Charge/discharge power of $b_i$ at time step $t$

$E_{b_i}(t)$	Energy of $b_i$ at time step $t$
$P_{net\ i}(t)$	Net power at bus $i$ without battery
$c_{p_i}^*(t), c_{s_i}^*(t)$	Forecasted price the prosumer in bus $i$ expect to purchase/sell energy at time step $t$
$x_{p_i}(t), x_{s_i}(t)$	Energy to be purchased/sold by the prosumer in bus $i$ at time step $t$
$k_{b_i}^{ch}(t), k_{b_i}^{dis}(t)$	Binary decisional variables governing the charge and discharge of $b_i$
$k_{p_i}(t), k_{s_i}(t)$	Binary decisional variables governing the energy traded by the prosumer in bus $i$
$E_{PV_i}(t)$	Energy produced by solar PV plant installed in bus $i$ at time $t$
$E_{b_i}^{ch}(t)$	Energy charged in $b_i$ at time $t$
$E_{b_i}^{dis}(t)$	Energy discharged from $b_i$ at time $t$
$E_{buy_i}(t)$	Energy bought by bus $i$ at time $t$
$E_{sell_i}^{MEM}(t)$	Energy sold by bus $i$ to the MEM at time $t$
$E_{sell_i}^{DSO}(t)$	Energy sold by bus $i$ to the DSO at time $t$
$E_{losses_i}(t)$	Losses assigned to bus $i$ for the use of the grid at time $t$
$E_{sell}(t)$	Energy sold by the DSO to the customers at time $t$
$E_{buy}(t)$	Surplus energy from micro-grid bought by the DSO at time $t$
$MCP(t)$	Market clearing price at time $t$
$C_{losses}(t)$	Cost of the losses inside the micro-grid at time $t$
$C_{spot}(t)$	Spot price at time $t$
$R_{b_i}^{MBM^A}(t)$	Revenue of the prosumer from the availability payment in the MBM at time $t$
$R_{b_i}^{MBM^E}(t)$	Revenue of the prosumer from the energy payment in the MBM at time $t$
$C^{MBM}(t)$	Cost of the DSO for the MBM
$P_{PV_i}(t)$	Power generated by PV plant in bus $i$ at time $t$
$P_{load_i}(t)$	Load power of bus $i$ at time $t$
$P_{max}^{PCC}$	Max net power demand at PCC in the simulation
$P_{R\ max}^{PCC}$	Max reverse power flow at PCC in the simulation
$e_g(t)$	Gaussian error for the household load forecast model
$V_{19}(t)$	Voltage in bus 19 at time $t$
$Std\ V_{19}$	Standar deviation of the bolvtage in bus 19
$P_{max}^{PCC}$	Maximum electricity demand at PCC
$P_{R\ max}^{PCC}$	Maximum reverse power flow at PCC

## 1 Introduction

The interest in and commitments to develop smart grids have been growing internationally over the past decade [1]. With the increased deployment of distributed generation (DG) and renewable energy sources (RES), along with the introduction of energy storage and micro-grids, the classic Distribution Network Operator (DNO) model is changing into a Distribution System Operator (DSO) [2]. A more modern approach is based on the variability of both supply and consumption, however, their integration in the power system poses new challenges that require a flexible management and control of the network [1]-[3]. In recent years, researchers and policy makers have emphasized the need of transforming the existing power grid towards a distributed smart system to enable the deployment of new low carbon technologies and several projects have been carried out to facilitate this transition [1]-[5][4]. Distributed Energy Resources (DERs) require cooperation among a variety of stakeholders, such as generation side operators, electricity market system operator, the transmission system operator (TSO), the DSO, end electricity users etc. It is important to incorporate smart changes to the existing power system in a realistic and coordinated manner. For this purpose, energy markets, active control of generation and electricity demand must also be decentralized. To this end, the concept of decentralised or Peer-to-Peer (P2P) energy trading has gained the interest of research community. The P2P energy

1 trading represents direct energy exchange between peers, where energy from small-scale DERs in dwellings, offices,  
2 factories, etc. is traded among local energy prosumers and consumers [6].

### 3 4 *Related works*

5 Several studies have investigated the topic of distributed energy management; however, it is still widely open and there  
6 is an ongoing learning on the most suitable methods and approaches. A model to representing P2P interaction for a small  
7 community with stationary storage located at customer level or a central battery shared by the community was optimised  
8 in [7]. However, it was assumed that prosumers cannot feed-in power to the grid; in addition, only decentralised control  
9 of batteries was simulated. A market procedure for a community micro-grid operating as part of a utility grid was  
10 presented in [8]. Within this micro-grid, each node had full control over its local energy resources and the energy plan  
11 is based on its own individual benefit. The study showed that under these assumptions, both sellers and buyers always  
12 benefitted from participating in this market. In [9], control strategies for stationary storage assets with multiple  
13 forecasting strategies was proposed. From a comparative analysis, it was demonstrated that a storage management  
14 system based on forecast has a higher potential to relieve the grid compared to a system that only maximises self-  
15 consumption. Three different market paradigms to apply P2P energy trading in a community micro-grid were proposed  
16 in [10]. It was observed that energy trading resulted in reduction of the community energy cost. However, batteries were  
17 not considered in their model. In [11] a model for home energy management system based on a rooftop photovoltaic  
18 (PV) system, residential battery system and electricity demand forecast was presented. Their results demonstrated  
19 correlations between the level of self-sufficiency, demand forecasting errors and the energy cost, however, no clear  
20 market proposition was made. A P2P energy sharing model for end users in a community micro-grid, overseen by a  
21 third-party entity was proposed in [12]. Their two stage approach (day ahead and real-time operation) demonstrated  
22 improved economic benefits, compared to conventional peer-to-grid (P2G) energy trading, however the authors did not  
23 include an optimal grid operation within their model. In [13], the influence of electricity pricing models on the  
24 profitability and management of residential battery storage systems was investigated. It was demonstrated that suitable  
25 structures, such as the proposed enhanced Time of Use (TOU) pricing policy, were able to drive private investments in  
26 battery storage and increase the network hosting capacity. However, grid constraints were not considered in their  
27 proposed approach. A P2P energy trading platform using game theory was proposed by [14], and it was found that P2P  
28 energy trading can improve the local balance of energy generation and consumption. The proposed approach did not  
29 include any model for balancing mechanisms, nor analysed the status of the voltage in the simulated distribution  
30 network.

31 The implementation of P2P energy trading depends mostly on national regulation as well as the enabling technology. A  
32 number of trials and projects on P2P energy trading have been carried out in recent years. Some of them focus on  
33 business models and energy market platforms. Others are targeted at local control, and Information and Communication  
34 Technology (ICT) systems for micro-grids [15],[16]. Among the technology and paradigm to realise an energy trading  
35 system, the idea of Blockchain is used some trials [16],[17] and seems to be a promising technology to regulate energy  
36 market system as per [17].

1 *Main contributions*

2 The surveyed literature mainly focused on reducing the energy utilisation cost for the participating users as well as  
3 increasing the RES utilisation. This is a natural requirement that investors in RES are facing given the phasing out of  
4 RES subsidies such as Feed-in-Tariff (FIT) for both generation and export tariff in some countries, including the UK.

5 A number of research gaps have been identified:

- 6 - Most of the reviewed research focused on cost minimisation and other objectives, however, an equally crucial issue is  
7 that of optimising the use of distribution networks with energy storage, which was not often investigated [7]-[12].
- 8 - Many studies consider peer-to-peer energy trading without proposing a holistic local market solution, especially the  
9 balancing mechanisms for local congestion management [7]-[14].
- 10 - A comparison between centralised and decentralised energy management was not found in the surveyed studies.
- 11 - No study focused on the DSO's perspective and only user's benefits were considered [7]-[14].

12  
13 Another phenomenon that augments the requirement for an efficient management of the grid is the upcoming mass  
14 adoption of electrified transportation, which can bring significant challenges to the local electricity networks due to the  
15 increased energy requirement for transportation. Consequently, there will be potential danger of overloading of the lines,  
16 curtailments of supply or demand, voltage fluctuations and potentially higher losses on the entire grid. To address these  
17 potential issues, DSOs have two main approaches in their investment plans: the first is based on the business as usual  
18 (BAU) "Fit and Forget" policy; the alternative consists of promoting distributed control of energy storage. Based on the  
19 latter and increasing economic attractiveness of battery energy storage systems (BESSs) and electric vehicles (EVs), in  
20 this paper we evaluate their impact on distribution networks. For the purpose of this study we refer to BESS and EVs as  
21 Energy Flexibility Assets (EFAs). EFAs allow a smart integration with RESs such as PV systems, and with them  
22 prosumers can actively manage the energy exchanged with the grid to improve their economic return while benefitting  
23 the network. The model proposed in this work is simulated for different flexibility asset management strategies (FAMS),  
24 under both DSO's and users/prosumers' perspectives. The main aim of this paper is to propose decentralised/local  
25 energy and balancing market strategies (FAMSs) to optimise the operation of distributed networks. This provides advice  
26 to DSOs on the alternatives to grid reinforcements and prospective deferrals. Three cases are presented: a base case, a  
27 centralised case and a decentralised case. Seven different scenarios have been created, characterised by different FAMS  
28 and market structure/architecture. A total of three different FAMS, based on the forecast generation and demand profiles  
29 with a rolling window approach, are presented. In the decentralised case, energy is traded in a micro-energy-market  
30 (MEM) to allow a smart energy trading at a price lower than the spot market, whose tariff is assumed to be a real time  
31 price (RTP). Furthermore, a micro balancing market (MBM), aimed at balancing the system and to face unforeseen  
32 events (contingencies and congestions), is introduced and resulting benefits are evaluated. The purpose of this work is  
33 thus to address the research gaps discussed above, and to propose a management framework for smart distribution  
34 networks in presence of high DER penetration.

35 The proposed methodology is applied to a of a typical UK (single phase) low-voltage distribution network. The time  
36 duration considered is a period from June 2017 to December 2017. A comparative techno-economic evaluation is  
37 performed in order to critically analyse the performance of the proposed management strategies.

38 The key contributions of this work are as follows:

- 1 - A holistic local energy market approach to optimise the operation of distributed networks.
  - 2 - A comparative analysis highlighting the benefits of decentralised management strategies over a centralised approach.
  - 3 - A techno-economic evaluation of different scenarios from the aspect of users, prosumers and DSO, highlighting the
  - 4 necessary steps for optimal investments and management of electricity distribution networks.
  - 5 - The introduction of MBM is to balance the local distribution network and to cover the contingency events using the
  - 6 energy from local prosumers, which to the best knowledge of the authors has not been previously proposed.
- 7 The rest of the paper is organized as follow: Section 2 presents the methodology adopted, starting from the management
- 8 strategies and continuing with the description of market structure and optimisation strategies. Subsequently, the
- 9 assessment metrics are presented at the end of Section 2. Section 3 discusses the case studies considered and evaluation
- 10 results are presented and discussed in section 4. In addition, we reflect on the implications of this work for the integration
- 11 of electric vehicles (EVs). Finally, the conclusions are presented in section 5.

## 12 2 Methodology

13 In this research, smart energy trading is implemented to achieve economic benefits for the key stakeholders in current

14 and future distribution systems. The main stakeholders considered are:

- 15 1) End-electricity users, with uncontrollable electricity demand
- 16 2) Prosumers that are able to benefit from local PV installation and BESS
- 17 3) DSOs, interested in optimising the grid operation by reduced peak demand and voltage deviation.

18 In this study, the connection of PV and stationary storage systems at the Point of Common Coupling (PCC) to the

19 electricity grid is defined as a micro-grid. The term micro-grid in this work refers to a subsystem of decentralised

20 generation and associated electricity loads [18]. In particular, only PV systems are considered and we assume that the

21 micro-grid always operates in a grid-connected mode. This assumption is reasonable for moderate penetration rates of

22 DERs as it is expected for 2030-2040 [19]. The smart operation of the micro-grid is enabled by introducing various

23 FAMSs. We propose multiple energy management strategies, to emphasise the benefits that can be achieved with EFAs

24 and local/micro-market approaches. Based on the FAMS and market architecture, seven scenarios are studied, as

25 outlined in Table 1.

26 Table 1 Summary of scenarios evaluated

Management strategy	Base case		Centralised case	Decentralised case			
	/	/	Centralised management	Grid support		Market approach	
Scenario	S1	S1m	S2	S3	S3e	S4	S4e
BESS	✗	✗	✓	✓	✓	✓	✓
MEM	✗	✓	✓	✓	✓	✓	✓
MBM	✗	✗	✗	✗	✓	✗	✓

27 The base case consists of two scenarios:

- 28 - S1 is the reference scenario and is characterized by no BESS and a conventional energy market. Real-time pricing of
- 29 electricity representing the wholesale market price and lack of feed-in-tariff are considered in this case.
- 30 - S1m is the reference scenario but with a MEM implemented for smart energy trading. MEM will be presented in more
- 31 detail in the following section.

1 The centralised case constitutes of one scenario:  
2 - S2 considers a hypothetical but plausible distributed deployment of BESSs with central management using an  
3 aggregated FAMS to manage all BESSs.  
4 Four different scenarios are considered for the decentralised case:  
5 - S3 is where distributed BESSs are deployed and owners independently manage these in order to provide grid support  
6 and reduce the variability of the net power exchange with the grid at the Point of Delivery (POD). The management  
7 strategy used in this scenario is described in Subsection 2.1.2.  
8 - S3e enhances grid support by implementing MBM through which prosumers contribute to the system balancing.  
9 Subsections 2.1.2 and 2.2.2 formalise the approach used in this scenario.  
10 - S4 is the market approach and provides an effective customer side FAMS based on prosumers' interest. Subsection  
11 2.1.3 provides more details for the management strategy used in this scenario.  
12 - S4e enhances the market approach by implementing MBM, as in S3e, to provide a service to DSO for the benefit of  
13 the grid. Subsection 2.1.3 presents the management strategy used in this scenario.  
14 In this work, MEM represents a platform that allows consumers and prosumers to trade energy between the participants  
15 of a micro-grid. Details of the market procedures are presented in Section 2.2.1. The platform is regulated by an  
16 aggregator and the FAMS is decentralised, with prosumers controlling their EFAs. In the present research, we assume  
17 that the aggregator does not charge for its services. This is justified by the inherent benefits on the grid operation that  
18 can be achieved with the implementation of SET. The MBM on the other hand aims to increase the active regulation of  
19 the electrical system and increase the value of all DERs. More details are provided in Section 2.2.2. Figure 1 shows the  
20 structure related to the decentralised and centralised cases.

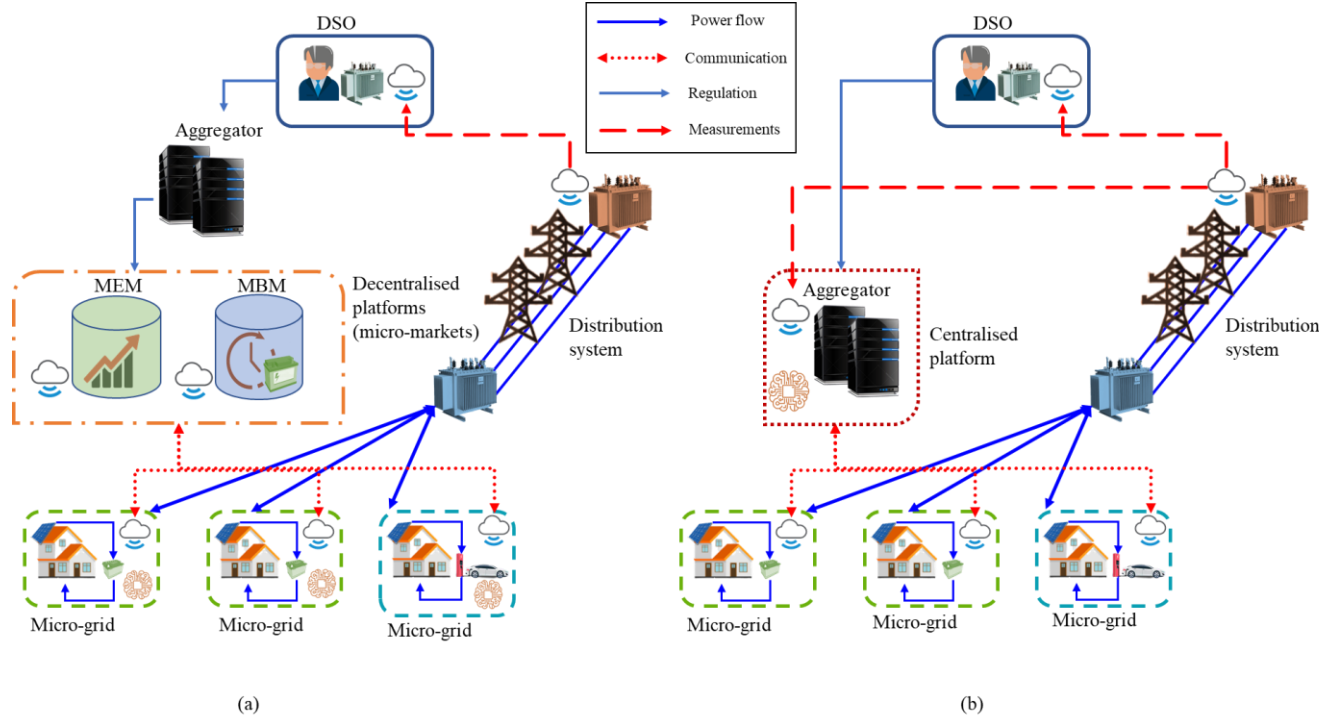

Figure 1 Schematic representation of the decentralised (a) and centralised (b) structures

It can be seen from Figure 1 that prosumers are owners of EFAs, i.e. stationary storage and EVs and they make them available for energy services to an aggregator. Under the decentralised FAMS they play an active role in deciding the operation of their EFAs in order to improve their profit by engaging in MEM and MBM, and they are decision-makers with regards to the energy and balancing services provided. On the other hand, in centralised FAMS they are controlled by the aggregator. In the decentralised FAMS, the aggregator is only the regulator of the MEM and MBM and liaises with the DSO on the rules that need to be enforced on the markets. The MEM is developed to make more use of locally generated renewable energy, either via self-consumption or by other users in the local energy market, i.e. MEM. The regulator of the MEM balances the demand and supply of energy and decides the quantities exchanged in the micro-grids. MBM procures flexibility from prosumers in order to avoid network congestions. This is done by issuing requests of flexibility in the MBM, in the form of demand reduction (or energy provision), and providing a remuneration for the service provision. The prosumers participating in this service need to make their EFAs available for the contracted period in exchange of the availability payment. Should actual energy exchanges take place in the contracted period, the prosumers will be provided with a further energy payment. This makes sure that hefty network charges are avoided and additional revenue is provided to the prosumers for their flexibility. Conversely, under centralised FAMS, the aggregator collects all the information and measurements in order to decide the charging/discharging schedules of the prosumers' EFAs. In the latter case, the prosumers only make available their assets (PV systems, EFAs) to the aggregator and agree to third-party control. In both approaches, the DSO acts as a high level regulator and reaps the benefits provided by the FAMS in terms of reduced negative impact of the distribution network. The data exchange between the different parties for decentralised and centralised FAMS is presented in Table 2.

Table 2 Exchanged data in the decentralised and centralised cases

Decentralised case			Centralised case		
From	To	Data exchanged	From	To	Data exchanged
Micro-grid	MEM	$P_{net i}, LCOE_{PV i}$	Micro-grid	Aggregator	$P_{net i}$
BESS (EV)	MBM	$P_{bi max}^{ch}, P_{bi max}^{dis}, E_{bi min}, E_{bi max}, SOC$	BESS (EV)	Aggregator	$P_{bi max}^{ch}, P_{bi max}^{dis}, E_{bi min}, E_{bi max}, SOC$
MBM	BESS (EV)	$P_{bi}^{ch}(t), P_{bi}^{dis}(t)$	Aggregator	BESS (EV)	$P_{bi}^{ch}(t), P_{bi}^{dis}(t)$

It can be seen from this table that the micro-grids in the decentralised case communicates with the markets and provides both technical parameters, i.e. capacity and power limits, and prices for the services. On the other hand, under the centralised FAMS, the micro-grid communicate with the aggregator and only technical parameters are transmitted, since the prosumer does not have decisional authority over their energy exchange.

Further reflections on the practical implementation of the proposed FAMS are presented here. It is clear that centralised management puts the prosumer in a secondary and more passive role; in fact, they only need to make the EFAs available. On the other hand, under decentralised management, the prosumers are in charge of their own benefits and the DSO benefits from an optimal network operation. The latter process promotes gamification which encourages user participation to the network services [20]. It should be noted that stimulus is not provided to the participation in the centralised management. The relevance of the proposed decentralised FAMS is higher than ever as DSOs are interested in procuring flexibility. In fact, a DSO in the UK is aiming to bring distribution system services to the market where



prosumers can participate in flexibility procurement, capacity based pricing and Time of Use DUoS services [21]. In terms of practicability, decentralised FAMS have the advantage of requiring less onerous communication system, being safer from cyber attacks and privileging privacy compared to centralised approaches [22], [23]. Additionally, in contrast to the centralised FAMS where the computational complexity increases with the number of users, the local decision-making in the case of decentralised FAMS ensures its fast response and efficient operation. These benefits make decentralised FAMS the ideal solution for the implementation of smart grids.

### 2.1 Flexibility asset management strategies

In this section, the proposed FAMS are presented and all the strategies are optimized over a period  $T$ . Three FAMS have been developed, namely centralised management, decentralised grid support and decentralised market approach for S2, S3, S3e, S4 and S4e.

#### 2.1.1 Centralised energy management

In this scenario, the batteries are centrally managed by an aggregator in order to reduce the variance of the net power exchange at the PCC. Hereafter, all the variables are assumed to be constant within a time-step  $\Delta t$ . The optimal batteries scheduling is formulated in the following optimisation problem.

$$\underset{p_{b_i}^{ch}(t), p_{b_i}^{dis}(t)}{\operatorname{argmin}} \sum_{t=1}^T \frac{\left( P_{net}^{PCC}(t) + \sum_{b_i} (p_{b_i}^{ch}(t) - p_{b_i}^{dis}(t)) \right)^2}{T} \quad (1)$$

s.t.

$$P_{net}^{PCC}(t) = \sum_{i=1}^B (P_{load_i}(t) - P_{PV_i}(t)) \quad (2)$$

$$0 \leq p_{b_i}^{ch}(t) \leq P_{b_i}^{ch_{max}} \quad \forall t, \forall b_i \quad (3)$$

$$0 \leq p_{b_i}^{dis}(t) \leq P_{b_i}^{dis_{max}} \quad \forall t, \forall b_i \quad (4)$$

$$E_{b_i \min} \leq E_{b_i}(t) \leq E_{b_i \max} \quad \forall t, \forall b_i \quad (5)$$

$$E_{b_i}(t) + \left( \eta_{b_i}^{ch} \cdot p_{b_i}^{ch}(t) - \frac{1}{\eta_{b_i}^{dis}} \cdot p_{b_i}^{dis}(t) \right) \cdot \Delta t = E_{b_i}(t+1) \quad \forall t, \forall b_i \quad (6)$$

In (1), the aim is to minimise the variance of the net power exchange at the PCC, which includes the residential electricity demand of all micro-grids and the powers exchanged by the batteries, considering the underlying constraints. Equation (2) defines the net power at PCC, expressed by the sum of all the loads and generation units within the micro-grid. Equations (3) and (4) set the limits of the charge/discharge power of batteries according to the ratings of the chargers, and (5) expresses the lower and upper bound of battery capacity. Finally, (6) defines the energy stored in the battery for each time step, which depends on the power charged in/discharged from the battery within that time-step. The objective function adopted in this scenario is non-linear, therefore convex optimisation algorithms have been employed for resolving the problem [24].

#### 2.1.2 Decentralised flexibility asset management for grid support

In this scenario, locally deployed batteries are individually managed by their owners in order to reduce the variability (or variance) of their own net power exchange at point of dispatch (POD). In each bus  $i$  that has a BESS, the following problem is optimised:

$$\begin{aligned} & \underset{p_{b_i}^{ch}(t), p_{b_i}^{dis}(t)}{\operatorname{argmin}} \sum_{t=1}^T \frac{\left( P_{net\ i}(t) + p_{b_i}^{ch}(t) - p_{b_i}^{dis}(t) \right)^2}{T} \\ & s.t. \end{aligned} \quad (7)$$

$$P_{net\ i}(t) = P_{load\ i}(t) - P_{PV\ i}(t) \quad (8)$$

$$0 \leq p_{b_i}^{ch}(t) \leq P_{b_i\ max}^{ch} \quad \forall t \quad (9)$$

$$0 \leq p_{b_i}^{dis}(t) \leq P_{b_i\ max}^{dis} \quad \forall t \quad (10)$$

$$E_{b_i\ min} \leq E_{b_i}(t) \leq E_{b_i\ max} \quad \forall t \quad (11)$$

$$E_{b_i}(t) + \left( \eta_{b_i}^{ch} \cdot p_{b_i}^{ch}(t) - \frac{1}{\eta_{b_i}^{dis}} \cdot p_{b_i}^{dis}(t) \right) \cdot \Delta t = E_{b_i}(t+1) \quad \forall t \quad (12)$$

1 The objective of the problem formulated in (7) is to minimise the standard deviation of the net power exchange of the  
2 bus with the grid. It is subject to the underlying constraints, which are equivalent to the case in 2.1.1, but referring to  
3 only one battery since decentralised management is implemented. Equation (8) defines the net power at bus  $i$  without  
4 the battery and expressed as the difference between the load and the power generated by the PV system. Equations (9)  
5 and (10) express the maximum battery power during charging and discharging mode (dependent on the rating of the  
6 charger). Equation (11) controls the operation of the battery within the allowed maximum and minimum battery  
7 capacity. Equation (12) is equivalent to (6). Similar to the centralised case, convex optimisation has been employed to  
8 deal with the non-linearity of the objective function.

### 9 2.1.3 Decentralised flexibility asset management with market approach

10 In the following optimisation problem, battery owners individually manage their assets in order to minimize their own  
11 cost function. To this end, the optimisation problem has been implemented as a mixed-integer linear programming  
12 (MILP) [25].

$$\underset{p_{b_i}^{ch}(t), p_{b_i}^{dis}(t), x_{p\ i}(t), x_{s\ i}(t)}{\operatorname{argmin}} \sum_{t=1}^T \left[ c_{p\ i}^* \cdot x_{p\ i}(t) - c_{s\ i}^* \cdot x_{s\ i}(t) + C_{b_i}^{degr} \cdot \left( p_{b_i}^{ch}(t) + p_{b_i}^{dis}(t) \right) \cdot \Delta t \right] \quad (13)$$

s.t.

$$P_{net\ i}(t) + \eta_{b_i}^{ch} \cdot p_{b_i}^{ch}(t) - \frac{1}{\eta_{b_i}^{dis}} \cdot p_{b_i}^{dis}(t) - x_{p\ i}(t) + x_{s\ i}(t) \quad (14)$$

$$= 0 \quad \forall t$$

$$E_{b_i}(t) + \left( \eta_{b_i}^{ch} \cdot p_{b_i}^{ch}(t) - \frac{1}{\eta_{b_i}^{dis}} \cdot p_{b_i}^{dis}(t) \right) \cdot \Delta t = E_{b_i}(t+1) \quad \forall t \quad (15)$$

$$E_{b_i\ min} \leq E_{b_i}(t) \leq E_{b_i\ max} \quad \forall t \quad (16)$$

$$p_{b_i}^{ch}(t) \leq P_{b_i\ max}^{ch} \cdot k_{b_i}^{ch}(t) \quad \forall t \quad (17)$$

$$p_{b_i}^{dis}(t) \leq P_{b_i\ max}^{dis} \cdot k_{b_i}^{dis}(t) \quad \forall t \quad (18)$$

$$k_{b_i}^{ch}(t) + k_{b_i}^{dis}(t) \leq 1 \quad \forall t \quad (19)$$

$$x_{p\ i}(t) \leq \alpha \cdot k_{p\ i}(t) \quad \forall t \quad (20)$$

$$x_{s_i}(t) \leq \alpha \cdot k_{s_i}(t) \quad \forall t \quad (21)$$

$$k_{p_i}(t) + k_{s_i}(t) \leq 1 \quad \forall t \quad (22)$$

Equation (13) expresses the cost function to be minimised, where the energy to be purchased or sold in each time-step is evaluated based on the corresponding forecasted cost of energy for the same time. On the other hand, the charge and discharge of the battery has a cost that depends the incurred degradation. Equation (14) expresses the load and supply balance of the single household at time step  $t$ , where the net power from residential electricity demand, PV generation, powers exchanged by the BESS and powers bought/sold from/to the local markets are considered. Equation (15) define the energy stored in the battery, equation (16) limits the energy stored to the battery capacity, whereas (17) and (18) set the maximum charge and discharge power of the battery. As in [25], the binary variables in (9),  $k_{b_i}^{ch}$  and  $k_{b_i}^{dis}$ , are introduced as charge and discharge mode of the battery and hence, they cannot coexist, which is ensured by equation (19). The parameter  $\alpha$  defined for the MILP problem in (20) and (21) is an arbitrary value that is larger than  $x_{p_i}$  and  $x_{s_i}$ , and is set to 1000. Equation (22) ensures that selling and purchasing of electricity do not coexist in the same time step.

## 2.2 Micro market

The proposed micro market is applied to the decentralised management and it is implemented in a platform coordinated by an aggregator. The market comprises two separated sections: one to allow smart energy trading and the other to allow capacity trading (MBM, reserved to prosumers that have BESSs).

### 2.2.1 Micro energy market: peer-to-peer trading

The proposed MEM platform allows prosumers to trade their surplus energy with other prosumers/users within the micro-grid. The market runs at every time step and enables smart energy trading at a price that could differ from the retail price. In the event of generation surplus, the market price will be set to a value lower than the spot price. Electricity consumers (users) communicate the power they need to buy, whereas each prosumer, after having calculated their net power, communicates the prospective energy they intend to trade. The submitted energy demands are cumulated under a demand curve that is assumed inelastic, and offers of energy are placed in ascending price order. The DSO is always the last participant in the market and is assumed to have unlimited capacity. Finally, the equilibrium in the market is found and the market-clearing price (MCP) is determined, as shown in Figure 2, where the total PV+BESS generation within the micro-grid is lower than the total demand. This represents the trading price, set for the buyers and sellers in the MEM. If any energy offer is not sold within the MEM, it is purchased by the DSO at a price lower than the clearing price. In particular, the price paid for this energy ( $C_{trade}^{DSO} = 0.046$  £/kWh) has been computed as the average of day ahead baseload contracts (reported by the UK's appointed independent regulatory authority, the Office of Gas and Electricity Markets, Ofgem, for 2017/2018) and is reduced by a 10% administrative fee as in [26]. The spot price offered in the market by the DSO is a RTP that reflects the trend of the N2EX Day Ahead Auction Prices (UK power market price), scaled to the average price of 0.16 £/kWh. This value is based on the average variable unit price of electricity in UK (0.158 £/kWh), reported by the UK's Office for National Statistics [26].

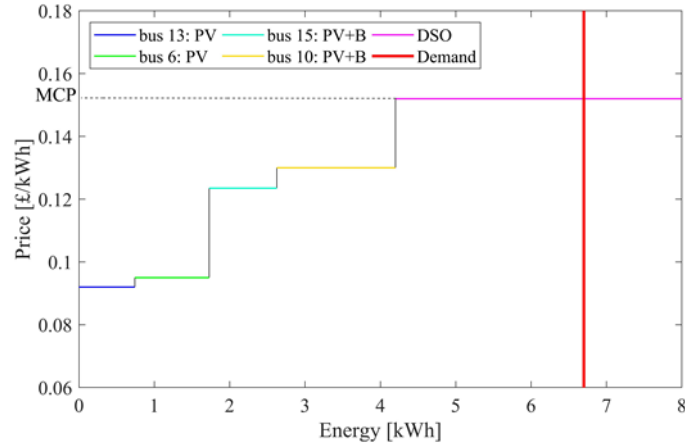

Figure 2 Example of the MEM configuration for a time step

### 2.2.2 Micro balancing market: congestions and contingencies balance

The proposed MBM is an additional platform where prosumers can subscribe the capacity of their batteries to the aggregator. The battery owners may commit all or a part of their total battery capacity in the negotiated time steps. This helps to balance the grid in case of contingencies or congestion, or any unforeseen events that need extra power. Under this strategy, equation (16) is modified as follows.

$$E_{b_i \min} + E_{b_i \text{MBM}} \leq E_{b_i}(t) \leq E_{b_i \max} \quad \forall t \quad (23)$$

Where  $E_{b_i \text{MBM}}$  represents the energy committed by prosumer  $i$  to the MBM, which augments the minimum battery capacity limit in order to reserve energy for the MBM. The prosumers participating in MBM make their EFAs available during the agreed period for the subscribed capacity. In case of contingencies, i.e. unforeseen demand spikes, the aggregator requests power provision from the available assets that can help solving the contingency. Naturally, the assets that can contribute to solving the issue are those that are downstream the line where the congestion originated. A practical demonstration of this operation will be provided in section 4.1

MBM providers are paid availability (per kW committed for all the commitment hours) and utilisation rates for the actual energy exchanged. In this work, the contracted prices have been set to 0.0043 £/kW/h for availability and 0.14228 £/kWh for utilisation. These values are set based on the average contracted price in the short-term operation reserve given in annual market report 2016/17 for the UK [27]. Further, a total of 275 interventions/year is considered in the analysis (as reported in [27]). MBM is crucial in ensuring a reliable operation of the grid, by ensuring that voltages and currents remain within the respective statutory limits. In fact, in case of a feeder overloading, only the BESSs contracted under MBM can provide energy locally to mitigate the contingency. The crucial role of MBM will be further evidenced in section 4.3 where the operation under contingency will be simulated.

### 2.3 Real-time optimisation

The real-time optimal scheduling of BESSs proposed in section 2.1 is implemented with a rolling window of length  $T$ , where  $T$  is the number of time steps. For this study,  $\Delta t=1$  hour resolution and  $T=24$  time steps have been chosen in order to cover a full day. This resolution is chosen to align with the market clearing time. As will be seen in the upcoming sections, the methods proposed in this work are computationally efficient and can be readily adapted to simulations with higher resolution, such as time steps of minutes or seconds. A graphical representation of the concept of the rolling window is shown in Figure 3. The measurements and predictions of the electricity demand and PV generation are used

to execute this process. In the first, and current time step  $t$  of the rolling window, measurements of the electricity demand and PV generation are available. On the contrary, for the remaining time steps,  $t = t+1, \dots, T$ , the aforementioned parameters are forecasted. Subsequently, an optimisation is performed over the whole window and only the scheduling for the first time step is executed. Consequently, for the following time step  $t=t+1$ , the horizon window slides one step forward and the process is repeated again.

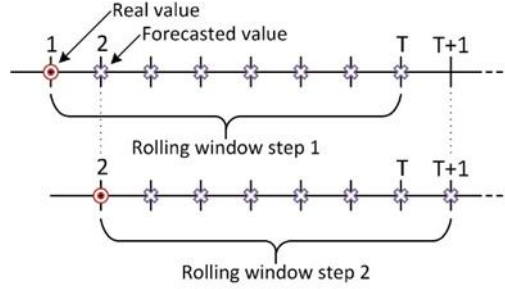

Figure 3 Schematic representation of the rolling window operation

### 2.3.1 PV generation forecast model

In our work, a feed-forward neural network with 2 layers and 12 neurons in the hidden layer is proposed to forecast the solar PV generation [28]. The input vector is composed of 49 elements: Global horizontal irradiation “1-24”, air temperature “25-48”, and a sinusoidal function as a calendar effect “49”, represented as in (24).

$$f(x) = \frac{\sin\left(\frac{2\pi}{365}(x - 91.25)\right) + 1}{2} \quad (24)$$

Equation (24) presents a sinusoidal cycle through a calendar year with the maximum value at mid-year and the minimum value at the beginning and end of the year, which provided a reference to the ANN of the solar irradiation throughout the year. To evaluate the performance of the forecast some performance metrics are used, such as correlation coefficient (R), Mean Absolute Error (MAE), and Root Mean Square Error (RMSE) [29]. The correlation coefficient of the Artificial Neural Network (ANN) resulted as 94.67%, the mean absolute error being 4.63% and RMSE of 6.50%.

### 2.3.2 Household electricity load forecast model

The forecast of the household’s electricity demand is carried out using (25).

$$P^*(t) = (1 + R\{-1; +1\} \cdot e_f) \cdot P(t) + e_g(t) \quad (25)$$

The real values  $P(t)$  are used to simulate the forecasted value  $P^*(t)$  with a random error of  $\pm e_f$ . The value of  $e_f$  used is 10%. Subsequently, a Gaussian error  $e_g(t)$  with a mean value  $\mu = 0$  and a standard deviation  $\sigma = 10\% P(t)$  is further added, as set out in [30]. It must be pointed out that for real-life applications, information on the past demand patterns should be collected and a forecast based on that should be performed.

## 2.4 Assessment metrics

This section presents the various metrics that quantify the techno/economic benefits of different scenarios. To evaluate the results from an economic point of view, two cost parameters, one for the customers and one for the DSO are defined as:

$$C_i(t) = E_{PV_i}(t) \cdot LCOE_{PV_i} + \left(E_{bi}^{ch}(t) + E_{bi}^{dis}(t)\right) \cdot C_{bi}^{degr} + E_{buy_i}(t) \cdot MCP(t) - E_{sell_i}^{MEM}(t) \cdot MCP(t) - E_{sell_i}^{DSO}(t) \cdot C_{trade}^{DSO} + E_{losses_i}(t) \cdot C_{losses}(t) - R_{bi}^{MBM^A}(t) - R_{bi}^{MBM^E}(t) \quad (26)$$

$$C_{DSO}(t) = E_{buy}(t) \cdot (C_{trade}^{DSO} - C_{sell}^{average}) - E_{sell}(t) \cdot (C_{selling}^{profit}) + C^{MBM}(t) \quad (27)$$

Subsidy schemes for renewable energy generation or any other incentives are not considered in this study. In equation (26), the PV generation is valued at the levelised cost of energy ( $LCOE_{PV_i}$ ) of the installation. Prosumers with BESS incur the cost of battery degradation, which has been quantified as  $C_{b_i}^{degr}$ . The energy purchased and sold in the MEM are valued at the MCP while the energy sold to the DSO receives a different remuneration  $C_{trade}^{DSO}$ . Subsequently, the term  $E_{losses_i}(t)$  is determined and AC power flow is computed. The losses for the  $i^{th}$  bus are a proportion of the total network losses. This term is calculated by splitting the total losses in proportion to the use of the grid, i.e. proportional to the net power exchange at the POD of bus  $i$ . The losses are valued at the spot price in the same time step. In addition, the prosumer receives a payment for making part of their flexibility available in the MBM, and an energy payment for the any actual utilisation. Regarding (27), it is assumed that the DSO has a profit of  $C_{selling}^{profit} = 0.02$  £/kWh on every kWh sold to customers. On the other hand, the surplus energy purchased from the micro-grid at  $C_{trade}^{DSO}$  is assumed to be sold at an average price of  $C_{sell}^{average} = 0.16$  £/kWh. Finally, the DSO incurs costs related to the MBM, which is represented by the sum of the availability and energy payments for all the participating prosumers.

To assess the performance of the scenarios, the technical assessment metrics for Self-Consumption (SC) and Self-Sufficiency (SS) calculated at the POD are defined by (28) and (29), and at the PCC by (30) and (31).

$$SC_{PODi} = \frac{\sum_t \min(P_{PV_i}(t), P_{load_i}(t) + p_{b_i}^{ch}(t))}{\sum_t P_{PV_i}(t)} \quad (28)$$

$$SS_{PODi} = \frac{\sum_t \min(P_{PV_i}(t), P_{load_i}(t) + p_{b_i}^{ch}(t))}{\sum_t P_{load_i}(t)} \quad (29)$$

$$SC_{PCC} = \frac{\sum_t \min(\sum_{i=1}^B P_{PV_i}(t), \sum_{i=1}^B (P_{load_i}(t) + p_{b_i}^{ch}(t)))}{\sum_t \sum_{i=1}^B P_{PV_i}(t)} \quad (30)$$

$$SS_{PCC} = \frac{\sum_t \min(\sum_{i=1}^B P_{PV_i}(t), \sum_{i=1}^B (P_{load_i}(t) + p_{b_i}^{ch}(t)))}{\sum_t \sum_{i=1}^B P_{load_i}(t)} \quad (31)$$

The SC [equations (28) and (30)] is the ratio between the energy directly consumed from the PV plants that directly consumed and the overall PV generation. The SS [equations (29) and (31)] is the ratio between the energy directly consumed from the PV plants over the total demand of the overall system.

Additional parameters are utilised in order to assess the benefits of the proposed FAMS for the distribution network. The standard deviation of the net power exchanged at PCC, namely parameter  $Std P_{net}^{PCC}$ , has been calculated given the value obtained in equation (1). The total losses of the network and voltage profiles of different nodes are the results of the corresponding AC power flow. The standard deviation of the voltage at bus 19 (as shown in Figure 5),  $Std V_{19}$ , is calculated by Equation (32).

$$Std V_{19} = \sqrt{\frac{\sum_{t=1}^T (1 - V_{19}(t))^2}{T}} \quad (32)$$

1 where  $V_{19}(t)$  is the voltage at bus 19 at time  $t$ . Bus 19 is chosen in this study since it locates at the end of the feeder and  
 2 hence represents the worse case scenario. The maximum electricity demand,  $P_{max}^{PCC}$ , and the maximum reverse power  
 3 flow,  $P_{Rmax}^{PCC}$ , at PCC are calculated in Equations (33) and (34), respectively.

$$P_{max}^{PCC} = \max\{P_{net}^{PCC}(t)\} \quad (33)$$

$$P_{Rmax}^{PCC} = -\min\{P_{net}^{PCC}(t)\} \quad (34)$$

4 where  $P_{net}^{PCC}(t)$  is the net power exchanged at PCC at time  $t$ .

### 5 3 Case study

6 In this section, the proposed FAMS have been applied to a comprehensive case study to investigate the benefits and  
 7 drawbacks of decentralised management strategies and compare to a centralised approach. The optimisation strategies  
 8 proposed in Section 2.1 and 2.3, coupled with the local market frameworks developed in Section 2.2 will be applied to  
 9 a typical distribution network. A flow diagram detailing the procedures for the simulations is shown in Figure 4.

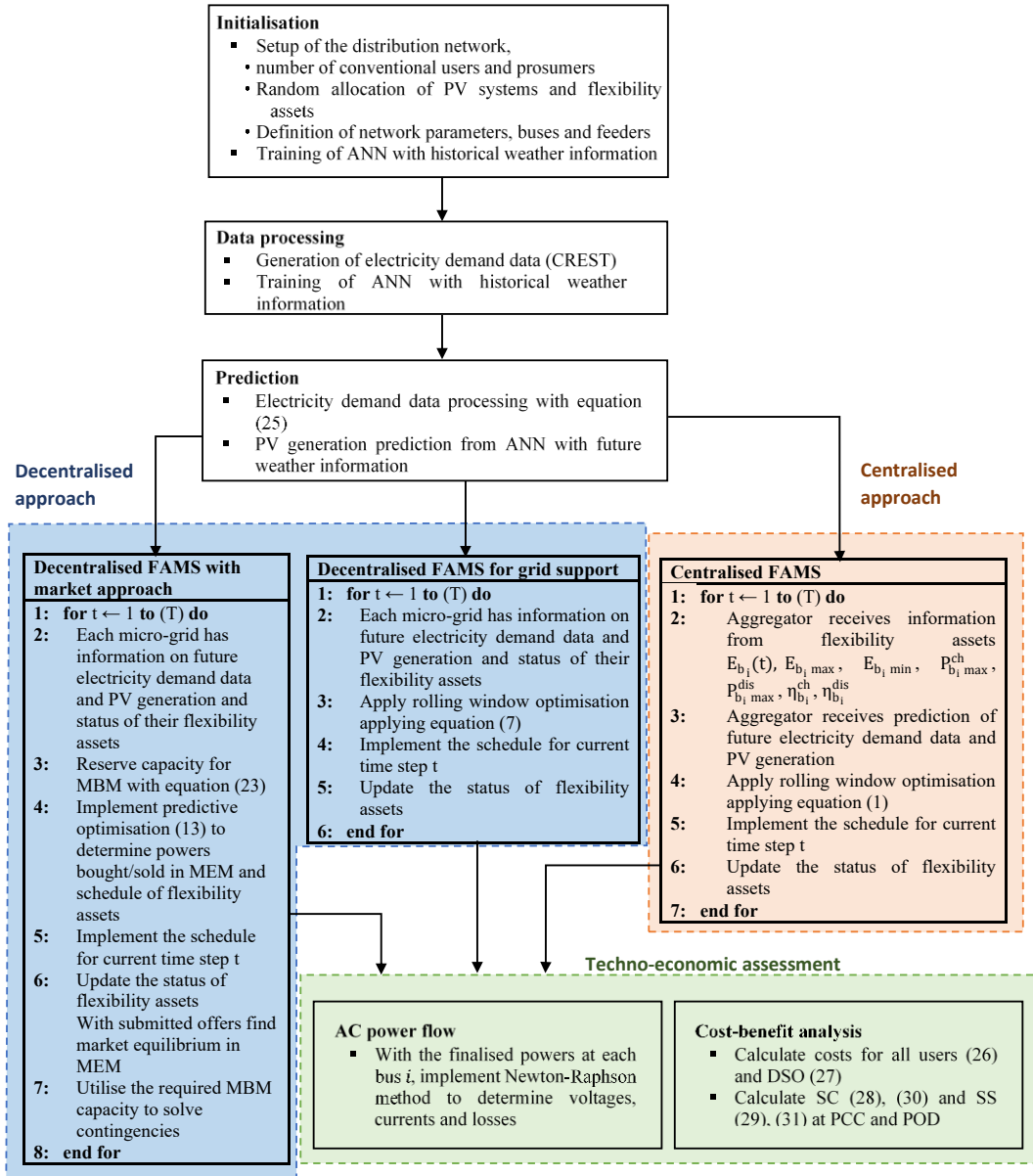

Figure 4 Flow diagram of the structure of the simulations

### 3.1 Residential LV distribution grid

The proposed method is applied to a Low Voltage (LV) feeder of a typical UK distribution network model [31]. To simplify the analysis, a single-phase equivalent circuit is considered. This approach can be extended to consider an unbalanced three-phase system. However, as the aim of this paper is to investigate decentralized energy management considering a market approach, the unbalanced operation is outside the scope of this research. As shown in Figure 5, 19 households are connected to this network, where 8 have solar rooftop PV plant and 4 of them also have stationary BESSs. The bus at the substation transformer (corresponding to the PCC) is assumed as slack bus and its voltage is fixed at 1pu. The PODs correspond to the connection points of the buses to the grid. Both active and reactive power flows are considered with a power factor  $pf=0.9$  (for every residential load). The PV output and power exchanged with BESS are assumed to have  $pf=1$ .

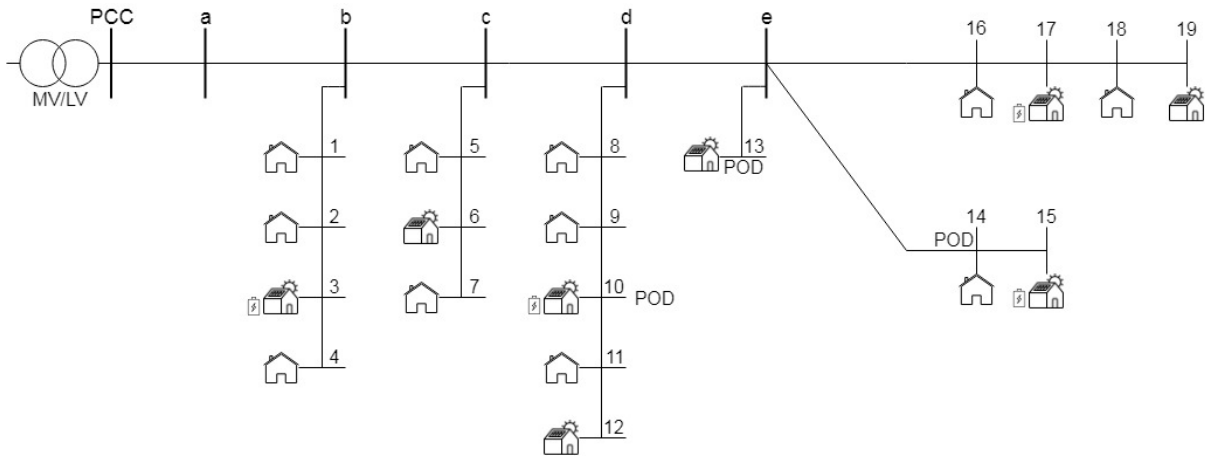

Figure 5 Schematic representation of a typical LV power distribution network.

### 3.2 Load and photovoltaic profiles

The generation profile of the PV system is the result of a one-year metering (2017) on a real rooftop solar PV system installed in a household located in the East Midlands of the UK. The daily household demand profiles are obtained from the Centre for Renewable Energy Systems Technology (CREST) demand model tool [32]. Therefore, for each of the 19 households of the network in Figure 5 and for each simulated day, a daily electricity demand profile is generated. An average number of 3 residents in the houses is chosen. The overall scenario considers 6 houses with 2 residents, 7 houses with 3 residents, 4 houses with 4 residents and 1 house with 5 residents, and they are all randomly distributed.

### 3.3 PV plants and BESSs: specifications

The PV systems and BESSs deployed in the distribution network are assumed to have same size and characteristics. The system specifications for all the network components are reported in Appendix A. An average PV installation price of 1840 £/kWp and a median value of 1700 £/kWp is adopted, which is in line with the UK government values [33]. Therefore, a range of prices between 1600 and 1900 £/kWp is chosen to give a variability to the levelised cost of energy (LCOE). Along with this an operation and management (O&M) cost of 18 £/kWp/year [34] and an expected economic system lifetime of 30 years are selected [35],[36]. An average degradation rate of 0.5% per year is considered for this paper [36]. Finally, a 4% nominal weighted average cost of capital ( $WACC_{nom}$ ), as suggested in [34], and a fixed inflation of 2.20% is chosen for the LCOE calculation. This inflation value is the computed average of the historic inflation rates of the last 10 years for the UK [37]. This is a reasonable value considering that the inflation rate in 2017 was about 2.7%



1 and in 2018 was 2.5% [38],[39]. However, recent projections show a decreasing trend for the near future [40]. Readers  
2 are directed to [34] for the definition of LCOE and  $WACC_{real}$ .

3 To account for the degradation of residential stationary BESS, current prices and future cost projections are investigated.  
4 Only stationary Li-ion batteries are considered in this study. Future trends are generated from the literature data about  
5 the expected market growth and the learning rate [41]-[48]. Finally, current and future installation costs (10 and 20  
6 years), resulting from the projections, are reported in Appendix A. The economic lifespan of the BESSs is taken as 10  
7 years, and it is assumed that they perform at their best during this period. To quantify the cost of degradation, 5000  
8 charge/discharge cycles are considered. A final average degradation cost of  $0.028 \text{ £/kWh}$  is obtained, and a  
9 conservative degradation cost of  $C_{bi}^{degr} = 0.03 \text{ £/kWh}$  is used for this study. This is in line with the current market  
10 practices, as some manufacturers already give 10 years or 10000 cycles warranty on their batteries (with an expected  
11 residual capacity of 80%) [49].

### 12 3.4 Simulation time-periods

13 A time span of June 2017 and December 2017 has been chosen for the simulations since it correspond to the duration  
14 of maximum and minimum generation of the analyzed PV system. For each month, the simulation is run for an 8 days  
15 period. The various scenarios presented at the beginning of Section 2 are simulated. The results and a comparative  
16 analysis will be presented in the subsequent section.

17 For those scenarios where the MBM is present, the contracts are stipulated for periods where critical operation can  
18 happen. In this study, a minimum SOC of 0.2 for all the BESS in the grid is reserved for the MBM from 4.0 pm to 11.0  
19 pm. All the simulations are carried out using Matlab software (version R2018a), on a PC with 3.5 GHz AMD PRO A4-  
20 8360B and 8 GB RAM. Two different solvers are employed for the optimisation. The nonlinear programming solver  
21 ‘fmincon’ [50] performing interior point algorithm for S2 and S3. The other is mixed-integer linear programming solver  
22 ‘intlinprog’ for S4 [51].

## 23 4 Results and discussion

24 As the aim of this work is to conduct a techno-economic analysis for the evaluation of different BEMS from the  
25 viewpoint of involved stakeholders, the considered scenarios are compared using the following criteria:

### 26 Technical assessment:

- 27 - The net power exchange at PCC: Total value, mean value and standard deviation
- 28 - Total micro-grid losses
- 29 - Voltage at the farthest bus (bus 19): magnitude and standard deviation
- 30 - Maximum demand peak power and reverse peak power flow at PCC
- 31 - SC and SS at POD and PCC level

### 32 Economic assessment:

- 33 - Economic benefit

1 4.1 Comparison of scheduling strategies

2 Figure 6 depicts the overall electricity demand profile, PV generation profiles and transformer loading at the PCC (see  
3 Figure 5), under S1, for 8 days in June. Considerable reverse power flow can be noticed, which is due to the excess PV  
4 generation for the summer month. The peak of electricity demand exceeds 15 kW, in the second and last day.

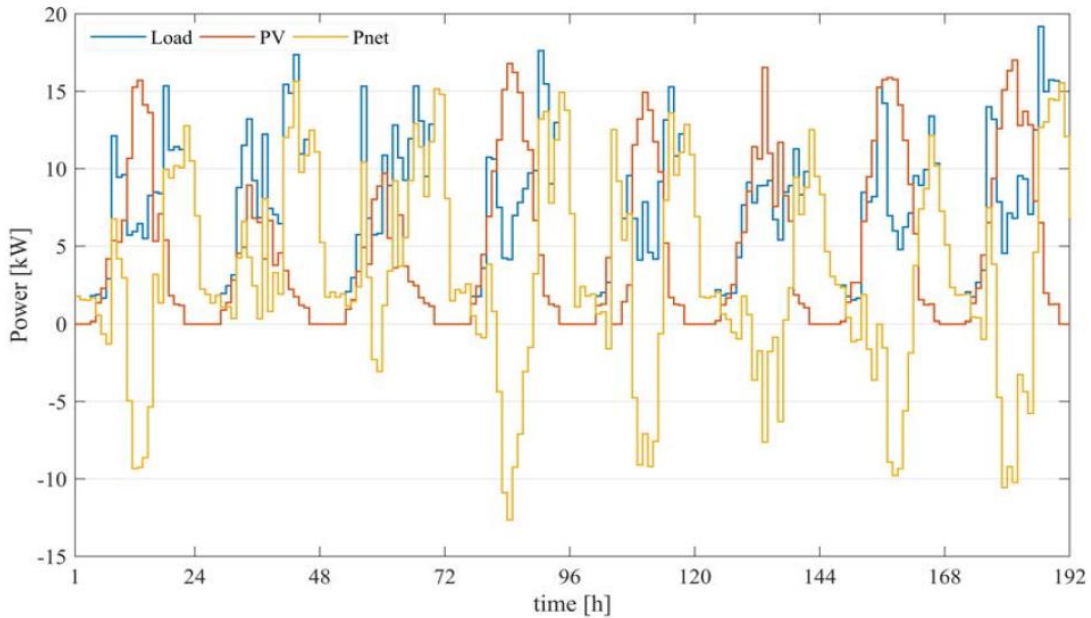

5

6

Figure 6 PCC measurements for S1 in June

7 Figure 7 shows the overall electricity demand, PV generation, battery profiles, as well as the transformer load, under S3  
8 for the same days as depicted in Figure 6. Significant improvements can be seen both in terms of reverse power flow  
9 (the maximum is just over 10 kW compared to the previous 13 kW) and peak demand (both the second and the last days  
10 are not well below 10 kW).

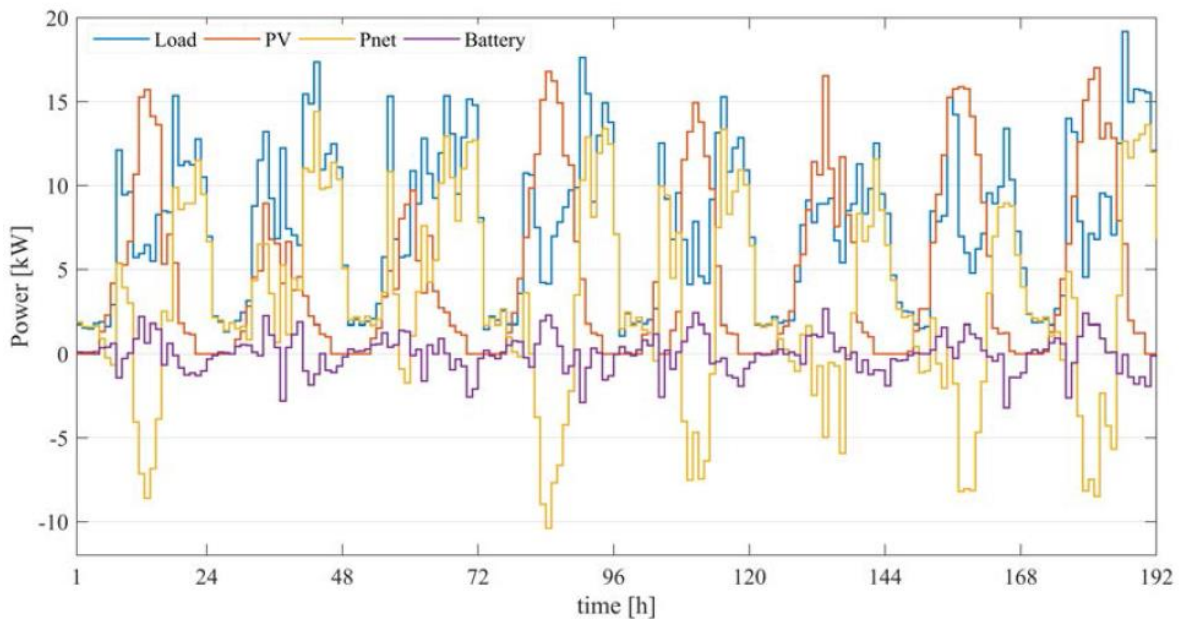

11

12

Figure 7 PCC measurements for S3 in June

1 Moreover, the different operation of BESS with and without MBM can be noticed in Figure 8, where in accordance with  
 2 equation (23), BESSs retain a 20% of their full capacity for the MBM, leaving the remaining 80% for trading in MEM.

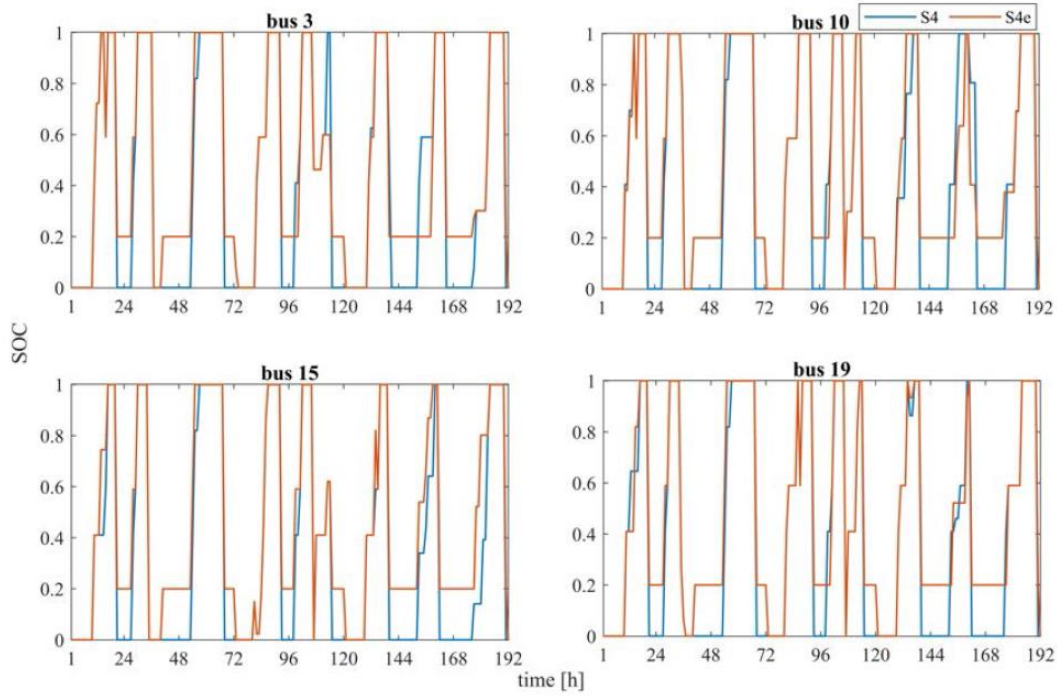

3  
 4 Figure 8 SOC of BESSs under S4 and S4e in June

5 **4.2 Evaluation of Technical performance**

6 Results from the simulation of grid under different scenarios are presented for the month of June 2017. From the initial  
 7 analysis, it seems that the total and mean value of  $P_{net}^{PCC}$  and the mean value of voltage magnitude at bus 19 are same in  
 8 all the scenarios. Thus, they are not of the interest to draw comparative conclusions and hence, they are no longer  
 9 discussed. Instead, Figure 9, focusses on the standard deviation of the net power at the PCC for the different scenarios  
 10 as clear differences are identified. The standard deviation of  $P_{net}^{PCC}$  for S2, S3 and S4 is lower compared to S1. Especially,  
 11 better results are obtained in S2, thanks to a wide view on the entire state of the grid given by the central management.  
 12 The better redistribution of power flows within the micro-grid due to the use of batteries reduces the total micro-grid  
 13 losses. The standard deviation of the voltage magnitude at bus 19 also presents a similar trend. It is visible that S2  
 14 performs better from a DSO point of view under all the assessment criteria. The S3 on the other side also brings grid  
 15 relief, but to a lesser extent, since the FAMS is performed as a decentralised case. Regarding the  $P_{max}^{PCC}$ , it can be noticed  
 16 that for S4, the management of batteries does not allow lowering the peak of demand. Under scenario S3, there is  
 17 maximum peak demand reduction, as the central controller is aware of the electricity demand profile for the whole  
 18 micro-grid. Finally, the reverse power flow at PCC is evaluated and even though S2 is the best performing, S3 and S4  
 19 also show considerable reverse power flow reduction.

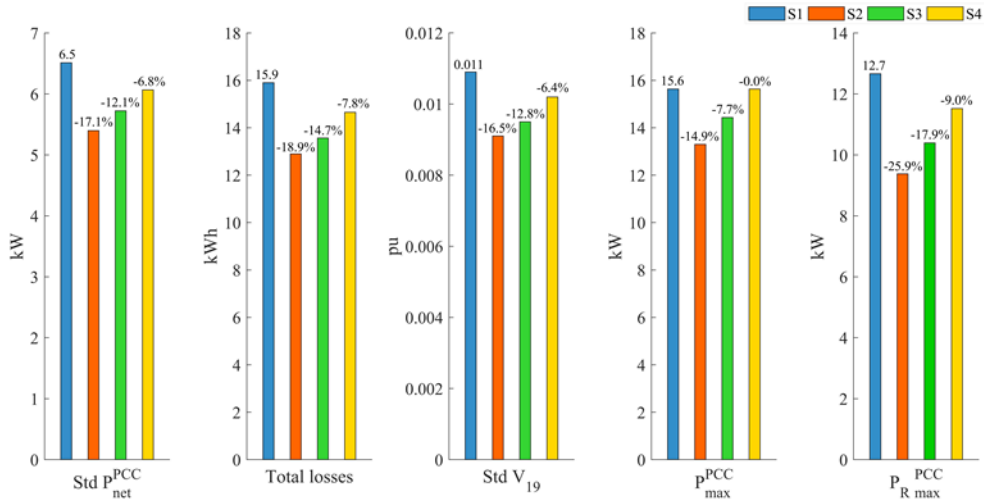

Figure 9 Comparison of main metrics for different scenarios for the month of June 2017

A similar analysis is carried out for December 2017. June and December are chosen as representatives to reflect the extreme seasonal variations. The difference between these two months can be seen in Figure 9 and Figure 10 from the parameters  $P_{max}^{PCC}$  and  $P_{R max}^{PCC}$ , which represent the maximum electricity demand and maximum reverse power flow at PCC, respectively. To be more specific,  $P_{R max}^{PCC}$  for June (Figure 9) under S1 is 12.7 kW, while in December (Figure 10), this is only 2.3 kW, indicating that in June there is considerably higher PV generation. Conversely,  $P_{max}^{PCC}$  in December is 20.76 kW under S1, whereas the same parameter is 15.6 kW in June, denoting a higher electricity consumption in winter. In general, net power in winter is more than double of the volume with respect to the period in June. Even for this case, the total and mean values of  $P_{net}^{PCC}$  are the same for all the scenarios, so therefore we do not present any figure here on this. However, the average voltage magnitude for S2, S3 and S4 improves slightly (0.2%) as compared to S1. Since they are not useful for a further comparative discussions, they are no longer considered. All the other results obtained for this case are presented in Figure 10. Likewise June, similar conclusions can be derived. Due to a higher household energy demand, the losses are much higher than the period of June. The results confirm the better performances of scenario S2 over scenario S3, thanks to the wider view of the management strategies of the batteries. S4 gives lower benefits with regards to the network parameters. In this case, the adopted FAMS with market approach is unable to decrease considerably the peak power demand at the PCC and it does not reduce the reverse power flow. This is because the price signals are not always coincident with the household peak demand. Thus, the reverse power flow is finally eliminated in the S2 scenario.

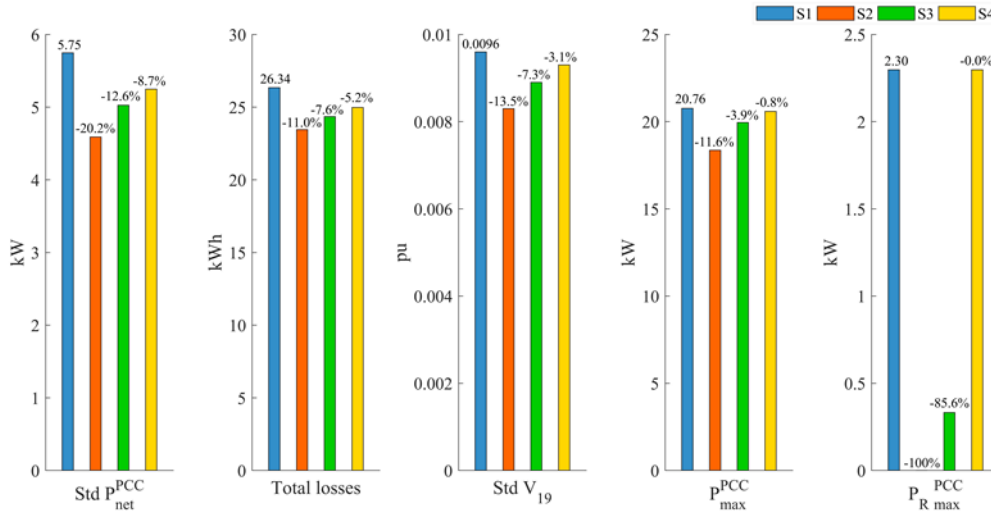

Figure 10 Comparison of main metrics for different scenarios for the month of December 2017

The results presented above in Figure 6-Figure 10 are obtained by using different FAMS that characterize the scenarios aimed to optimize different functions, and imply different batteries utilisation. Therefore, in June the BESSs are used for an average of 2.19, 1.45 and 1.19 cycles/day for scenarios S2, S3 and S4, respectively. Similarly, the utilisation in December is 2.03, 1.54 and 1 cycles/day. The centralised management strategy exploits the BESSs more for the benefit of the grid. In fact, the results obtained show that S2 is the scenario that ensures the highest grid relief.

Other aspects to be considered are the SC and SS. Table 3 shows the average value of these parameters computed at POD and PCC. Since S2 employs centralised management, SC and SS at a house level are not relevant; therefore, they are omitted here. Analyzing the two decentralised scenarios, it is clear that S3 is able to increase the SC and SS more than S4. This is due to the fact that the FAMS in S4 are driven by price signals, while under S3, as specified by equation (7), the objective is to reduce the variance of the net power profile of each household. The latter implies that both excessive power consumption (positive power exchange) and excessive power generation from PV (negative power exchange) are penalized, which leads to both improved SC and SS. At the PCC, S2 performs better than S3 and S4, both in June and December, since the aggregator has a global view on the entire grid. This fact is meaningful since it increases the energy autonomy of the micro-grid that may deliver social, financial and environmental benefits.

Table 3 Self-consumption and self-sufficiency computed at POD level and PCC level

		June				December			
		S1	S2	S3	S4	S1	S2	S3	S4
POD level	SC	36.82%	/	53.44%	48.86%	57.69%	/	91.26%	58.08%
	SS	49.64%	/	72.20%	65.89%	17.59%	/	28.17%	17.72%
PCC level	SC	71.49%	79.31%	77.22%	75.66%	98.78%	100%	99.86%	98.78%
	SS	43.14%	47.86%	46.60%	45.65%	13.71%	13.88%	13.86%	13.71%

### 4.3 Evaluation of economic impact

This subsection presents the economic analysis for S1, S3 and S4, as the economic profitability of S2 could only be assessed on a case-to-case basis and therefore is beyond the scope of this paper. For the analysis of S2, additional information regarding the investment, ownership and operation of batteries is required.

1 The first analysis determines the most beneficial scenario from the customers' perspective. Results regarding the total  
 2 cost are shown in Figure 11. For the comparative analysis, all the results are referred to Scenario S1, which is scaled to  
 3 100. The MEM is beneficial for all the customers in every scenario. Although prosumers have the highest benefits from  
 4 the introduction of a MEM, the electricity consumers also take advantage from it by purchasing the electricity from the  
 5 MEM at a lower price as compared to the utility price. This agrees with other results in the literature [8],[10],[12].  
 6 Prosumers with PV installations can achieve higher electricity bill reductions, since they have a lower LCOE than the  
 7 prosumers owning both PV and BESS. However, it should be pointed out that with a high penetration of RES there  
 8 would be significant reverse power flow if BESSs are not in place. Since the cost of degradation of the battery is included  
 9 in the objective function, a reduction in the total cost means that the BESS repays itself. It can be seen that scenario S4  
 10 is best from a customer point of view. Whereas it may be expected for prosumers to own a battery, since the management  
 11 strategy in this scenario aims to minimize a cost function, the same cannot be said for the other electricity users. Finally,  
 12 the introduction of the MBM in S3e and S4e adds a source of income for those who have a BESS without significantly  
 13 affecting the benefits of the other customers. The slight increment of expenditure for the other customers in S4e is  
 14 mainly due to the higher volume of energy purchased from the DSO instead of buying it from the prosumers that own a  
 15 BESS.

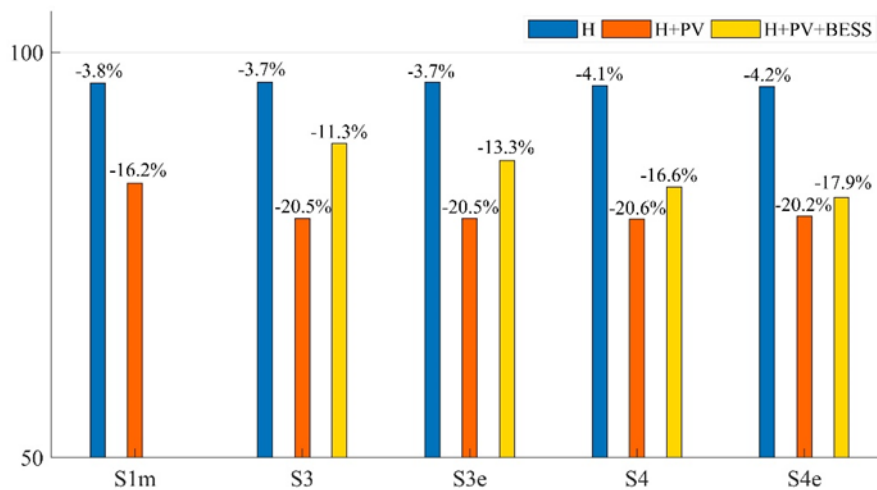

17 Figure 11 Customers' expenditures for different scenarios compared to S1 (S1=100)

18 In Figure 12, S3 and S4 are compared to S1m (which is scaled to 100). Using the MEM, the expenditure of simple users  
 19 and users with PV systems do not change significantly in all scenarios. However, the change in the expenditure of  
 20 prosumers equipped with a BESS is considerable. It is important to note that the presence of the battery in S3 results in  
 21 a higher cost of 0.8%, which means that S3 will not encourage installations of BESS in future MEM. Therefore, some  
 22 incentives would be required to make the economic case profitable for the prosumers. The introduction of the MBM  
 23 (S4e), which adds an additional source of income as can be seen in Figure 8, could be a good option to lower the energy  
 24 bill and incentivize new BESS installations. Therefore, it can be concluded that S4 is the best scenario from the point of  
 25 view of customers while S3 requires some incentives to stimulate new BESSs installations. In addition, although from  
 26 the DSO perspective S3 is the best approach for a decentralised BESSs management; however, this requires additional  
 27 incentives to encourage the participation of prosumers.  
 28

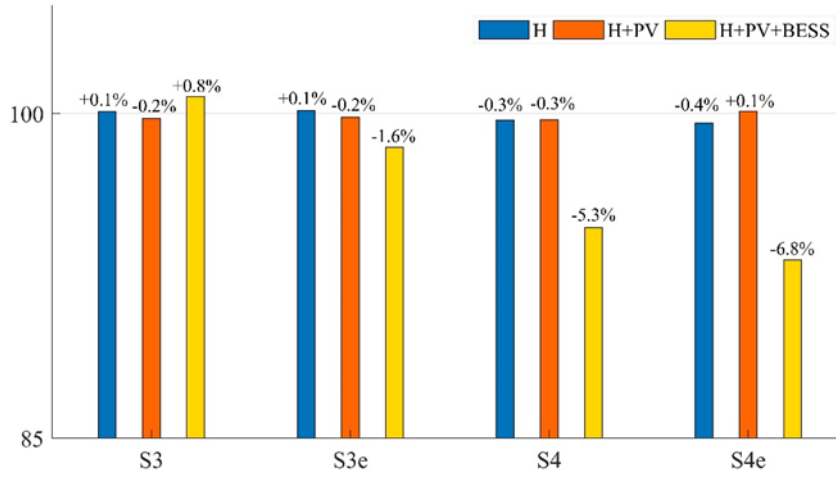

Figure 12 Customers' expenditures for different scenarios compared to S1m scenario (S1m=100)

The DSO's profit for the various case scenarios is presented in Table 4. As mentioned earlier, the economic evaluation of S2 is beyond the scope of this paper, therefore only scenarios S1, S1m, S3, S3e, S4 and S4e are analyzed here (for June and December together). The data in Table 3 refers to the items of the economic assessment in (27). The first row represents the energy provided by the DSO to the customers, and the second row shows the surplus energy purchased by the DSO from the micro-grid. In the second block, the profits and costs related to the energy purchased and sold by the DSO are presented. Finally, all the cost/revenue elements are shown in the third block and the total profit of the DSO in the last.

Table 4 DSO's profit for different scenarios

	S1	S1m	S3	S3e	S4	S4e
$E_{sell}$ (kWh)	2291.819	2291.819	2241.973	2243.835	2256.879	2262.688
$E_{buy}$ (kWh)	672.40	254.77	204.52	204.73	219.83	222.44
$C_{selling}^{profit}$ (£/kWh)	0.02	0.02	0.02	0.02	0.02	0.02
$C_{trade}^{DSO}$ (£/kWh)	0.046	0.046	0.046	0.046	0.046	0.046
$C_{sell}^{average}$ (£/kWh)	0.16	0.16	0.16	0.16	0.16	0.16
Profit from $E_{sell}$ (£)	45.836	45.836	44.839	44.877	45.138	45.254
Expense from $E_{buy}$ (£)	-30.930	-11.719	-9.408	-9.418	-10.112	-10.232
Revenue from $E_{buy}$ (£)	107.584	40.763	32.723	32.757	35.173	35.590
Expense for MBM (£)	/	/	/	-3.42	/	-3.42
Total profit (£)	122.49	74.88	68.15	64.80	70.20	67.19

As expected, the results show that S1 ensures the highest income for the DSO. However, this scenario may necessitate grid reinforcement to ensure sufficient grid capacity and a reliable electricity provision. It should be noted that under this scenario, reverse power flow and voltage variability are at their highest levels. Further, it is assumed that DSO can sell all the energy purchased from the MEM outside the micro-grid, which is not guaranteed. The presence of the MEM in S1m reduces considerably the volume of energy purchased from the micro-grid since part of the energy is now traded between prosumers and consumers. Having batteries in S3 and S4 further reduces the volume of energy purchased from the micro-grid (since BESS increases the SS at PCC level). Accordingly, the total revenue is decreased. Note that S4 leads to a higher revenue for the DSO as compared to S3. In addition, the presence of the MBM reduces the DSO's



revenues once again, but it encourages prosumers participation and avoids keeping expensive peak-plants on standby (to provide for contingencies).

From the results presented in the current section and Section 4.2, it appears that the centralised management in S2 achieved the best network operation. However, as discussed in Section 2, centralised management has severe drawbacks, in particular the lack of financial incentives in comparison to the decentralised approach. Additionally, the users under S2 are deprived of the right to manage their own assets and their interests are not fully pursued. In contrast, the decentralised FAMS provide the users with a higher degree of engagement as well as better economic benefits. In fact, S4 (market approach) attains the lowest cost for all customers (prosumers and conventional). Moreover, S4 achieves both demand and reverse power flow reduction compared to S1, as shown in Figure 9. Hence, a market approach (i.e. S4) is demonstrated to promote the utilisation of flexibility, reward the participants with a higher return, and improve the grid operation.

To demonstrate the capability of BESSs to deal with congestions, an unforeseen congestion was created in a way that the voltage magnitude at some buses dropped below the threshold of 0.94 pu. In addition, the current in the section ‘a-b’ of the network in Figure 5 exceeded the maximum capability of the feeder. The corresponding results for the scenarios S4 and S4e are presented in Table 5. The simulation indicated that distributed BESS with the presence of MBM could deal with these events and maintain the grid quantities (voltage and current magnitude) within the allowed range. Therefore, they can reduce over-capacity required from the distribution grid to face unexpected contingencies. Note that a distributed injection of power in the opposite direction of the congestion in the section ‘a-b’ is the only way to solve it.

Table 5 Quantities of the grid in the presence of an unforeseen congestion for scenarios S4 and S4e

V magnitude (pu)		
bus	S4 (✗ MBM)	S4e (✓ MBM)
16	0.9382	0.9410
17	0.9377	0.9405
18	0.9375	0.9402
19	0.9373	0.9401
I/Imax		
section	S4 (✗ MBM)	S4e (✓ MBM)
a-b	1.010	0.9639

Finally, it is worth pointing out that centralised management requires higher communications and computational costs and provides lower flexibility and reliability as compared to decentralised management [14]. In fact, the computational time to upload data and perform the optimisation problem was on average 0.2754 s, 0.1632 s and 0.1397 s for scenarios S2, S3 and S4 respectively. Moreover, whilst computational cost in S2 rise in a quadratic way with the numbers of controlled devices it does not change at all in scenarios S3 and S4. The computational effort required for S2 would constitute a major obstacle as the size of the grid increases.

The results obtained show that decentralisation of the system and the development towards a smart grid and active prosumers is an attractive investment and governance option for future energy systems with high penetration of DERs. Between the two decentralised cases considered, S3 provides better benefits for the grid, as it can defer or avoid



1 investments in grid reinforcement; however, it does not provide the same revenues as S4 for the final customer and the  
 2 DSO. Therefore, S3 would require some incentives for the prosumers to encourage new BESS installations. This is not  
 3 necessary for S4, where lower energy bills incentivize all the customers.

4 *4.4 Discussion on integration with electric vehicles*

5 The energy trading framework developed in this research also applies to innovative distributed energy resources, such  
 6 as electric vehicles (EVs). In fact, EVs can be used as storage solutions for households and the distribution network  
 7 [52]. Studies, such as [53] and [54], have demonstrated improvement in grid operation via Vehicle-to-Grid (V2G). To  
 8 this end, the framework developed in the present work is extended to include V2G by modelling as mobile energy  
 9 storage. The V2G provision is underpinned by the availability of EV at home, which was shown [55] as 60% on average.  
 10 To be more specific, the departure time and arrival time is sampled from the period of 6am-8am and 4pm-6pm,  
 11 respectively [56]. The strategies described in sections 4.2 and 4.3 are then applied to EVs in this case. Figure 13 shows  
 12 the transformer load at PCC under S1 and S2 when BESSs are employed compared to when the EVs are simulated, as  
 13 well as the different power exchanged by BESSs and EVs under S2 .

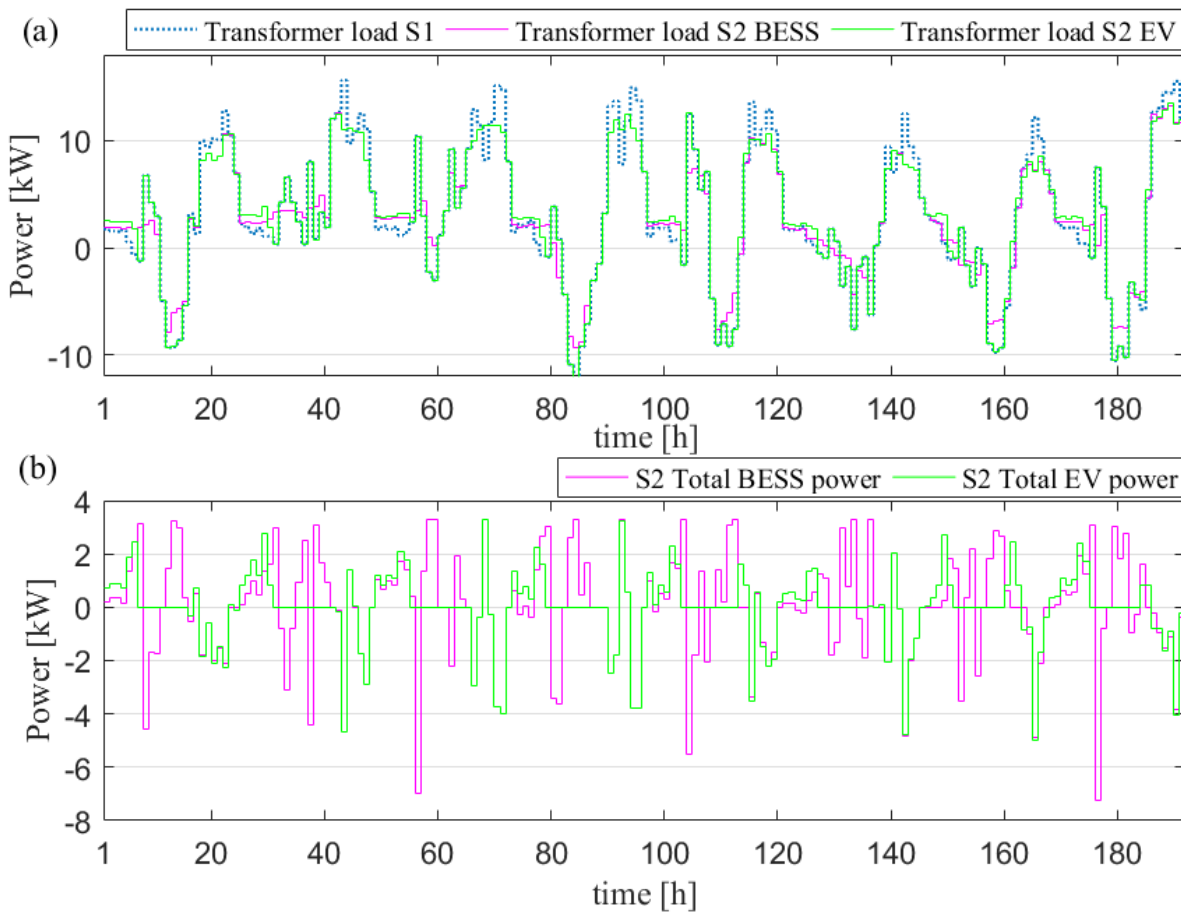

14

15 Figure 13 (a) Comparison between transformer load under S1 and S2 with BESS and EV in June, (b) comparison between the total power  
 16 exchanged by BESS and EV under S2 in June

17 As can be seen, when the EVs are unavailable during the day, they are unable to charge from the power generated by  
 18 PV (see the green curve in Figure 13.b ). Hence when EVs are simulated under S2, there is higher reverse power flow,  
 19 compared to when BESSs are simulated. There is negligible difference between the peak demand values when EVs are

1 simulated compared to BESSs, as the EVs are available in the evening to provide the electricity demand. The results in  
 2 Table 6 confirm that EVs reduced the evening peak demand whereas they did not influence reverse power flow.

3 Table 6 Comparison of peak demand and reverse power flow with S1, S2 with BESS and S2 with EV in June

Maximum peak demand (kW)		
S1	S2 with BESS	S2 with EV
15.64	13.30	13.51
Maximum reverse power flow (kW)		
S1	S2 with BESS	S2 with EV
12.66	9.38	12.66

4 It is worth mentioning that 90% of UK drivers travel less than 20 miles on a daily basis (which corresponds to 5.22 kWh  
 5 for a Nissan Leaf) [56]. Taking into account of the fore-mentioned energy required for transportation, the remaining EV  
 6 battery capacity is considerably sufficient for energy management, either under centralised control, such as what is  
 7 demonstrated here, or decentralised control such as MEM and MBM.

## 8 5 Conclusions

9 This paper proposed a framework of decentralised micro-energy and micro-balancing market in low voltage distribution  
 10 networks with high penetration of distributed energy resources. It is demonstrated that by the implementation of the  
 11 proposed micro-energy-market, the cost of energy for all users with or without DERs has been reduced. In fact, all users  
 12 can reduce their cost by at least 4.1%, prosumers with PV systems can achieve a reduction of more than 20.2% while  
 13 prosumers with both PV and battery storage systems can reduce their energy cost by at least 16.6%. Furthermore, by  
 14 applying market strategies, voltage deviation can be reduced by 6.4% and peak demand can be reduced by 0.8%, in the  
 15 best case compared to the BAU scenario. The MEM is particularly effective in reducing reverse power flow by 9%  
 16 which indicates an improved integration of renewable generation. In this case, the benefits achieved by the system  
 17 operator should be shared with the prosumers to incentivise their participation and stimulate installation of the battery  
 18 storage systems. To this end, the proposed micro-balancing-market is a suitable option since it has been demonstrated  
 19 in this simulation as a profitable service for the prosumers, and has improved grid stability in case of contingencies.  
 20 Furthermore, it has been shown that EVs, with the average UK daily travelling pattern, can be successfully integrated  
 21 in the proposed energy trading framework. The proposed framework can be extended to large three-phase systems  
 22 considering unbalanced operation of the grid without significant complications by further work beyond the scope of this  
 23 paper.

## 24 Acknowledgement

25 This work is supported in part by EU–Interreg North Sea Region programme-Smart,clean Energy and Electric Vehicles  
 26 for the City (SEEV4-City) project J-No.: 38-2-23-1.

## 27 Appendix A

PV system	
Nominal capacity	3 kWp
Yield	1000 kWh/kWp
Degradation	0.50%/year
CAPEX	1600÷1900 £/kWp

OPEX(t)	18 £/kWp/year	1	Parameters of PV systems and BESSs
Life time	30 years		
WACC <sub>nom</sub>	4%	2	
Inflation	2.20%	3	
WACC <sub>real</sub>	1.76%		
<b>BESS</b>		<b>4</b>	
Nominal capacity	2 kWh	5	
$E_{b_i max}$	2 kWh		
$E_{b_i min}$	0 kWh	6	
$P_{b_i max}^{dis}$	2 kW	7	
$P_{b_i max}^{ch}$	0.820 kW		
Efficiency	100%	8	
Life time	10 years	9	
CAPEX(0)	570 £/kWh		
CAPEX(10)	230 £/kWh		
CAPEX(20)	200 £/kWh		
OPEX(t)	0 £/kWh		

## References

- [1] Department of Energy & Climate Change (DECC), *Smart Grid Vision and Routemap*. London, February 2014. [https://assets.publishing.service.gov.uk/government/uploads/system/uploads/attachment\\_data/file/285417/Smart\\_Grid\\_Vision\\_and\\_Route\\_mapFINAL.pdf](https://assets.publishing.service.gov.uk/government/uploads/system/uploads/attachment_data/file/285417/Smart_Grid_Vision_and_Route_mapFINAL.pdf) (last accessed: 16/03/2019)
- [2] Office of Gas and Electricity Markets (Ofgem), Role of a DSO, <https://www.ofgem.gov.uk/ofgem-publications/86255/roleofthedsoslides.pdf> (last accessed: 16/03/2019)
- [3] Schneider Electric, "The Transformation from DNO to DSO", <https://blog.schneider-electric.com/electricity-companies/2014/11/27/transformation-dno-dso/> (last accessed: 16/03/2019)
- [4] House of Commons, Energy and Climate Change Committee, "Low carbon network infrastructure: First Report of Session 2016-2017", HC 267, 2016. <https://publications.parliament.uk/pa/cm201617/cmselect/cmenergy/267/267.pdf> (last accessed: 16/03/2019)
- [5] Gangale F, Vasiljevska J, Covrig F, Mengolini A, Fulli G., *Smart grid projects outlook 2017: facts, figures and trends in Europe*, JRC Science for Policy Report, EUR 28614 EN, 2017. doi:10.2760/701587. <https://ses.jrc.ec.europa.eu/smart-grids-observatory> (last accessed: 16/03/2019)
- [6] Zhang, C., Wu, J., Zhou, J., Cheng, M., Long, C. Peer-to-Peer energy trading in a Micro-grid, *Applied Energy*, 220:1-12, 2018
- [7] Lüth A, Zepter J M, Crespo del Granado P, Egging R., Local electricity market designs for peer-to-peer trading: The role of battery flexibility, *Applied Energy* 229: 1233-1243, 2018
- [8] Shamsi P, Xie H, Longe A, Joo J., 'Economic Dispatch for an Agent-Based Community Micro-grid', *IEEE Transactions on Smart Grid*, 7(5)2317-2324, 2016.
- [9] Moshövel J, Kairies K P, Magnor D, Leuthold M, Bost M, Gähns S, Szczechowicz E, Cramer M, Sauer D. U. Analysis of the maximal possible grid relief from PV-peak-power impacts by using storage systems for increased self-consumption, *Applied Energy* 137: 567-575, 2015
- [10] Long C, Wu J, Zhang C, Thomas L, Cheng M, Jenkins N., "Peer-to-Peer Energy Trading in a Community Micro-grid", *2017 IEEE Power & Energy Society General Meeting*, 2017.
- [11] Iwafune Y, Ikegami T, da Silva Fonseca Jr. J.G., Oozeki T, Ogimoto K., Cooperative home energy management using batteries for a photovoltaic system considering the diversity of households, *Energy Conversion and Management* 96: 322-329, 2015.
- [12] Long C, Wu J, Zhou Y, Jenkins N., Peer-to-peer energy sharing through a two-stage aggregated battery control in a community Micro-grid, *Applied Energy* 226: 261-276, 2018
- [13] Bignucolo F, Savio A, Turri R, Pesavento N, Coppo M. "Influence of electricity pricing models on the daily optimisation of residential end-users integrating storage systems," *2017 International Conference on Modern Power Systems (MPS)*, Cluj-Napoca, 2017, pp. 1-6
- [14] Zhang C, Wu J, Zhou Y, Cheng M, Long C. Peer-to-Peer energy trading in a Micro-grid, *Applied Energy* 220: 1-12, 2018
- [15] Zhang C, Wu J, Long C, Cheng M. 'Review of Existing Peer-to-Peer Energy Trading Projects', The 8th International Conference on Applied Energy – ICAE2016, *Energy Procedia* 105: 2563–2568, 2017
- [16] Wang N, Xu W, Xu Z, Shao W. 'Peer-to-Peer Energy Trading among Micro-grids with Multidimensional Willingness', *Energies* 11(12), 3312, 2018..
- [17] Energy Matters, a SunEdison Company (official site): <https://www.energymatters.com.au/misc/peer-to-peer-solar-energy-trading-guide/> (last accessed: 25/03/2019)
- [18] Lasseter R.. and Paigi P., "Micro-grid: a conceptual solution," *2004 IEEE 35th Annual Power Electronics Specialists Conference (IEEE Cat. No.04CH37551)*, Aachen, Germany, 2004, pp. 4285-4290 Vol.6. <http://ieeexplore.ieee.org/stamp/stamp.jsp?tp=&arnumber=1354758&isnumber=29758>
- [19] National Grid ESO, "Future Energy Scenarios", July 2019. Available at: <http://fes.nationalgrid.com/media/1409/fes-2019.pdf>
- [20] J. C. Ferreira and A. L. Martins, "Building a Community of Users for Open Market Energy", *Energies*, 11(9), 2330, September 2018. <https://doi.org/10.3390/en11092330>
- [21] A. White and S. Halsey, "Metered Demand and Distributed Energy Resources Customer Forum 26th September 2019", presentation from UK Power Networks, 2019. [Available online at [https://www.ukpowernetworks.co.uk/internet/en/have-your-say/documents/COMBINED%20Metered%20and%20DER%20forum%20Sept%202019\\_FINAL.pdf](https://www.ukpowernetworks.co.uk/internet/en/have-your-say/documents/COMBINED%20Metered%20and%20DER%20forum%20Sept%202019_FINAL.pdf)] last accessed 25/07/2020
- [22] Platt G. The decentralised control of electricity networks intelligent and self-healing systems; 2007.
- [23] M. J. Morshed, J. Ben Hmida and A. Fekih, "A probabilistic multi-objective approach for power flow optimization in hybrid wind-PV-PEV systems", *Applied Energy*, vol. 211, pp. 1136-1149, 2018. <https://doi.org/10.1016/j.apenergy.2017.11.101>
- [24] Boyd S. and Vandenberghe L, *Convex optimisation*, Cambridge: Cambridge University Press, 2004
- [25] Carrion M. and Arroyo J.M, "A computationally efficient mixed-integer linear formulation for the thermal unit commitment problem," *IEEE Transactions on Power Systems*, 21,(3), 1371-1378, 2006.
- [26] Department for Business, Energy & Industrial Strategy, Average variable unit costs and fixed costs for electricity for UK regions (QEP 2.2.4), Publication date: 20/12/2018. <https://www.gov.uk/government/statistical-data-sets/annual-domestic-energy-price-statistics> (last accessed: 16/03/2019)
- [27] National Grid Electric System Operator, *Short term operating reserve*, <https://www.nationalgrideso.com/balancing-services/reserve-services/short-term-operating-reserve-stor?market-information> (last accessed: 16/03/2019)
- [28] Park D.C, El-Sharkawi M.A, Marks R.J, Atlas L.E. and Damborg M.J. Electric load forecasting using an artificial neural network, *IEEE Transactions on Power Systems* 6(2): 442-449, 1991.
- [29] ETIP-PV, Assessing the need for better forecasting and observability of PV: A white paper by the European Technology & Innovation Platform PV working group on grid integration, 2017. <http://www.etip-pv.eu/publications/etip-pv-reports.html> (last accessed: 16/03/2019)
- [30] Nguyen H. N. T, Zhang C, Mahmud M. A. Optimal Coordination of G2V and V2G to Support Power Grids with High Penetration of Renewable Energy, *IEEE Transactions on Transportation Electrification*, 1(2): 188-195, 2015.

- 1 [31] Pillai G, Putrus G, Pearsall N, Georgitsioti T., 'The effect of distribution network on the annual energy yield and economic performance of  
2 residential PV systems under high penetration', *Renewable Energy* **108**: 144-155, 2017.
- 3 [32] McKenna E, Thomson M, Barton J. *CREST Demand Model 2019*. doi:10.17028/rd.lboro.2001129.v7.
- 4 [33] Department for Business, Energy & Industrial Strategy, "Annual Cost of Small-Scale Solar Technology Summary May 2018".  
5 <https://www.gov.uk/government/statistics/solar-pv-cost-data>. Last updated: 31 May 2018. (last accessed: 16/03/2019).
- 6 [34] Vartiainen E, Masson G, Breyer C. (2017), The true competitiveness of solar PV: A European case study, European technology & innovation  
7 platform – Photovoltaics.
- 8 [35] IEA PVPS, *Methodology Guidelines on Life-Cycle Assessment of Photovoltaic Electricity*, Report T12-03:2011, 2011. [http://www.iea-  
9 pvps.org/fileadmin/dam/public/report/technical/rep12\\_11.pdf](http://www.iea-pvps.org/fileadmin/dam/public/report/technical/rep12_11.pdf) (last accessed: 16/03/2019)
- 10 [36] International Energy Agency PVPS, Analytical Monitoring of Grid-connected Photovoltaic Systems: Good Practices for Monitoring and  
11 Performance Analysis. Report IEA-PVPS T13-03:2014, 2014 <http://www.iea-pvps.org/index.php?id=276> (last accessed: 04/01/2019).
- 12 [37] <https://www.inflation.eu/inflation-rates/great-britain/historic-inflation/cpi-inflation-great-britain.aspx> (last access: 16/03/2019)
- 13 [38] <https://www.rateinflation.com/inflation-rate/uk-historical-inflation-rate> (last accessed: 16/03/2019)
- 14 [39] Office for National Statistic, Statistical bulletin: Consumer price inflation, UK: November 2018, Release date: 19/12/2018.  
15 <https://www.ons.gov.uk/economy/inflationandpriceindices/bulletins/consumerpriceinflation/november2018> (last accessed: 04/01/2019)
- 16 [40] Statista, "United Kingdom: Inflation rate from 2012 to 2022 (compared to the previous year)"  
17 <https://www.statista.com/statistics/270384/inflation-rate-in-the-united-kingdom/> (last accessed: 16/03/2019)
- 18 [41] Fuchs G., Lunz B., Leuthold M., Sauer D.U. *Technology Overview on Electricity Storage: Overview on the potential and on the deployment  
19 perspectives of electricity storage technologies*, 2012, Institut für Stromrichtertechnik und Elektrische Antriebe, RWTH Aachen, on behalf  
20 of Smart Energy for Europe Platform GmbH
- 21 [42] Müller M, Viernstein L, Truong C.N, Eiting A, Hesse H.C, Witzmann R, Jossen A., 'Evaluation of grid-level adaptability for stationary  
22 battery energy storage system applications in Europe', *Journal of Energy Storage* **9** (2017) 1–11, 2017.
- 23 [43] Naumann M, Karl R.C, Truong C.N, Jossen A, Hesse H.C, Lithium-ion battery cost analysis in PV-household application, 9th International  
24 Renewable Energy Storage Conference (IRES 2015), *Energy Procedia* **73**: 37-47, 2015.
- 25 [44] Schmidt O, Hawkes A, Gambhir A, Staffell I. 'The future cost of electrical energy storage based on experience rates', *Nature Energy* **2**,  
26 Article number: 17110, 2017.
- 27 [45] Tesla motors. Powerwall 2. (2018), <https://www.tesla.com/powerwall> (accessed 06/11/2018)
- 28 [46] Curry C, "Lithium-ion battery costs and market: Squeezed margins seek technology improvements & new business models", July 5, 2017,  
29 Bloomberg New Energy Finance.
- 30 [47] IRENA (2017), *Electricity Storage and Renewables: Costs and Markets to 2030*, International Renewable Energy Agency, Abu Dhabi.
- 31 [48] KPMG LLP, *Development of decentralised energy and storage systems in the UK: A report for the Renewable Energy Association*,  
32 [http://www.r-e-a.net/upload/rea\\_storage\\_report-web\\_accessible.pdf](http://www.r-e-a.net/upload/rea_storage_report-web_accessible.pdf) (last accessed: 18/03/2019)
- 33 [49] Varta (official site UK). <https://www.varta-storage.com/products/energy/varta-pulse/?lang=gb> (last accessed: 22/02/2019)
- 34 [50] MathWorks Documentation 'fmincon', <https://it.mathworks.com/help/optim/ug/fmincon.html> (last accessed: 25/03/2019)
- 35 [51] MathWorks Documentation 'intlinprog', <https://it.mathworks.com/help/optim/ug/intlinprog.html> (last accessed: 25/03/2019)
- 36 [52] Y. Wang, S. Huang and D. Infield, "Investigation of the potential for electric vehicles to support the domestic peak load," 2014 IEEE  
37 International Electric Vehicle Conference (IEVC), Florence, 2014, pp. 1-8.
- 38 [53] R. Das, Y. Wang, G. Putrus, R. Kotter, M. Marzband, B. Herteleer and J. Warmerdarm, *Multi-objective Techno-Economic-Environmental  
39 Optimisation of Electric Vehicles for Energy Services*, Applied Energy, vol. 257, 2020.
- 40 [54] M. Nicoli, R. Das, Y. Wang, G. Putrus, R. Kotter and R. Turri, A Smart Grid Modelling Tool for Evaluating Optimal Control of Electric  
41 Vehicles, 53rd University Power Engineering Conference (UPEC), Glasgow, Sep 2018.
- 42 [55] Y. Wang and D. Infield, Markov Chain Monte Carlo simulation of electric vehicle use for network integration studies, International Journal  
43 of Electrical Power & Energy Systems, Vol. 99, pp. 85-94, 2018.
- 44 [56] A. Evans, J. Commings, M. Slocombe and F. Corvaglia, National Travel Survey: England 2017, Department for Transport, July 2018.  
45 Accessed online 28/01/2019. Available at  
46 ([https://assets.publishing.service.gov.uk/government/uploads/system/uploads/attachment\\_data/file/729521/national-travel-survey-  
47 2017.pdf](https://assets.publishing.service.gov.uk/government/uploads/system/uploads/attachment_data/file/729521/national-travel-survey-2017.pdf)).