



Aalborg Universitet

AALBORG UNIVERSITY
DENMARK

Potential Energy Savings in Refrigeration Systems Using Optimal Setpoints

Larsen, Lars Finn Sloth; Thybo, Claus

Published in:

Proceedings of IEEE Conference on Control Applications 2004

Publication date:

2004

Document Version

Publisher's PDF, also known as Version of record

[Link to publication from Aalborg University](#)

Citation for published version (APA):

Larsen, L. F. S., & Thybo, C. (2004). Potential Energy Savings in Refrigeration Systems Using Optimal Setpoints. In Proceedings of IEEE Conference on Control Applications 2004 (Vol. 1, pp. 701-704)

General rights

Copyright and moral rights for the publications made accessible in the public portal are retained by the authors and/or other copyright owners and it is a condition of accessing publications that users recognise and abide by the legal requirements associated with these rights.

- ? Users may download and print one copy of any publication from the public portal for the purpose of private study or research.
- ? You may not further distribute the material or use it for any profit-making activity or commercial gain
- ? You may freely distribute the URL identifying the publication in the public portal ?

Take down policy

If you believe that this document breaches copyright please contact us at vbn@aub.aau.dk providing details, and we will remove access to the work immediately and investigate your claim.

POTENTIAL ENERGY SAVINGS IN REFRIGERATION SYSTEMS USING OPTIMAL SETPOINTS

Lars S. Larsen * Claus Thybo **

* Central R&D - Refrigeration and Air Conditioning,
Danfoss A/S, Nordborg, Denmark, E-mail: lars.larsen@danfoss.com

** Central R&D - Refrigeration and Air Conditioning, Danfoss A/S,
Nordborg, Denmark, E-mail: thybo@danfoss.com

Abstract:

Energy efficiency of refrigeration systems has gradually been improved with help of control schemes utilizing the more flexible components. This paper proposes an approach in line with this trend, where a suboptimal condenser pressure is found in order to minimize the energy consumption. The objective is to give an idea of how this optimization scheme works as well as to show what amount of energy it is possible to save. A steady state model of a simple refrigeration system will be used as a basis for the optimization.

Keywords: Industrial refrigeration systems, control schemes.

1. NOMENCLATURE

N	Rotational speed [rpm]
OD	Opening Degree
P_I	Compressor inlet pressure [kPa]
P_O	Compressor outlet pressure [kPa]
Q_E	Refrigeration capacity [kW]
SH	Superheat [K]
SC	Subcooling [K]
T_A	Ambient temperature [°C]
T_E	Evaporation temperature [°C]
\dot{W}	Power consumption [kW]

Indices

C	Compressor
EF	Evaporator fan
CF	Condenser fan

Abbreviations

CCP	Constant Condenser Pressure
OCP	Optimal Condenser Pressure
OOC	Overall Optimal Control

2. INTRODUCTION

Advances in component technology, such as the electronic controllable expansion valves and variable

speed control of compressors, fans etc., makes it possible to implement more advanced control schemes that achieve a better performance and furthermore a better energy efficiency. Examples of that are given in Gruhle and Isermann [1989], Parkum and Wagner [1994] and Jakobsen et al. [2001].

The power consumption of a refrigeration system consist of contributions from the individual components, compressors, fans etc. The energy optimal control scheme operates at the minimum of the overall power consumption, using the available degrees of freedom in the system, Jakobsen et al. [2001]. The objective of this paper is to give an idea of how such an optimization scheme works as well as to indicate the potential energy savings. Yet another objective is to present an optimization scheme that reduces the energy consumption by finding a more efficient differential pressure over the compressor. Figure 1 illustrates the discussed system layout.

In Figure 2 is shown the power consumption in the compressor as a function of the pressure ratio (outlet over inlet pressure P_O/P_I). It can be seen that by reducing the ratio from for example 5 to 3 one can reduce the power consumption in the compressor with about 30 %. This reduced pressure ratio can be obtained by

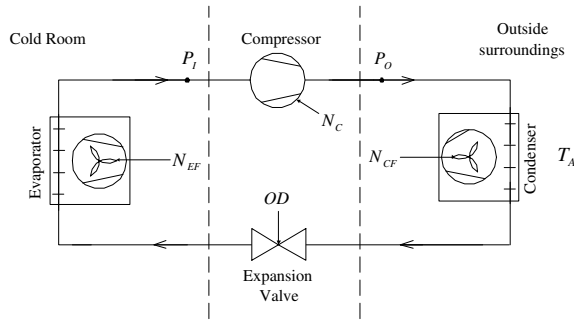

Fig. 1. The system layout.

lowering the outlet pressure from the compressor (P_o) and keeping the inlet pressure constant. An increased condenser fan speed will lower the condenser pressure and thereby the outlet pressure from the compressor as well. This of course results in an increased power consumption in the condenser fan as it is illustrated in Figure 3. It can further be seen that when the ambient temperature T_A is low, it costs less energy to obtain this reduced pressure ratio. This indicates that especially in the cold seasons it is possible to save energy by reducing the condenser pressure. In order to find the operating point, where the energy consumption is minimal an optimizing scheme must be established.

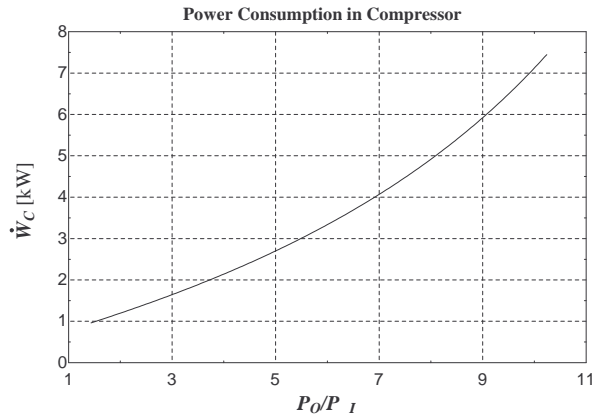

Fig. 2. Power consumption in compressor.

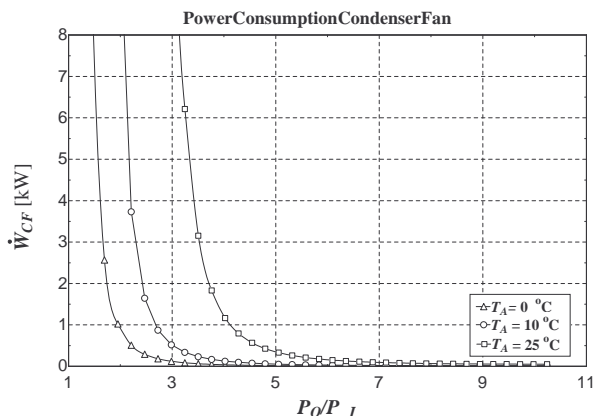

Fig. 3. Power consumption in condenser fan. It should be pointed out that the Figure has been made under the assumption that (P_i) is constant.

3. ENERGY OPTIMAL CONTROL

An energy optimal control scheme for a refrigeration system must minimize the total energy consumption and simultaneously keep up the refrigeration capacity (Q_E). By using the same terminology as in Figure 1 this can be expressed as:

$$\min_{[N_c, N_{EF}, N_{CF}, OD | Q_E = \text{Const}]} (\dot{W}_C + \dot{W}_{EF} + \dot{W}_{CF}), \quad (1)$$

where the subscript C denotes the compressor, EF the evaporator fan and CF the condenser fan. N denotes the rotational speed of the different components and OD the opening degree of the expansion valve (the valve does not consume any energy).

The optimization has 4 variables and 1 constraint, this means that it has 3 degrees of freedom, the superheat (SH), the condenser (T_C) and evaporator temperature (T_E) as indicated in Figure 4 by the arrows. The sub-cooling (SC) is not a free variable since it is determined by the operation of the system and by the shape and size of the condenser. Below in Eq. 2 is SC assumed to be constant, further more by assuming a low constant SH the optimization scheme can be reduced to 2 degrees of freedom. A low SH is assumed to be the most efficient.

$$\min_{[N_c, N_{EF}, N_{CF}, OD | Q_e = \text{Const}, SH = \text{Const}]} (\dot{W}_C + \dot{W}_{EF} + \dot{W}_{CF}), \quad (2)$$

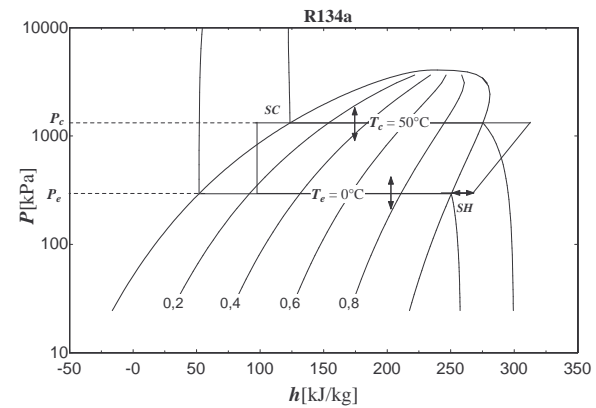

Fig. 4. The vapor compression cycle for the refrigeration system in a p-h diagram for R134a.

Since the evaporator and the condenser exchanges heat respectively with the cold room and the outside surroundings, the solution for this optimization problem does not entirely depend on the refrigeration cycle itself, but on the surrounding temperatures as well. It is obvious that the condenser/evaporator fan has to work harder to exchange heat when the temperature difference between the condenser/evaporator and their surroundings is low. To achieve an unambiguous solution, information about the surrounding temperatures therefor must be included. To illustrate the nature of the 2 degree of freedom optimization problem given by eq. 2, an example has been carried out. Figure

5 shows the surface that is created by the possible operating pressures which fulfills the constrains under the given surrounding temperatures. As the figure

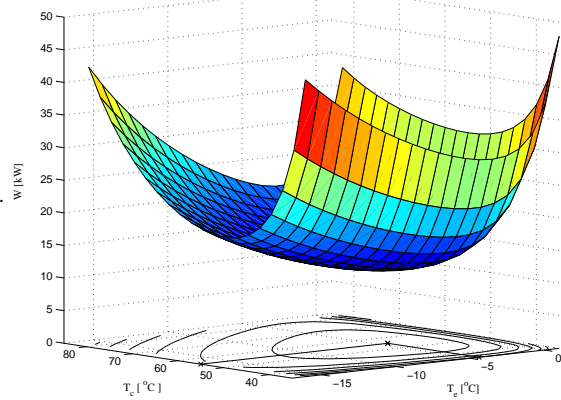

Fig. 5. The 2 degree of freedom optimization problem.

shows this results in a convex optimization problem, where the optimum (the operating point consuming the minimal amount energy) lies at the bottom of the surface.

Assuming that the superheat (SH) is controlled by the expansion valve (OD) 3 input still have to be adjusted to achieve an optimal operation of the refrigeration system. It is thus possible to achieve a suboptimal solution, where only two of the inputs is adjusted. This can be done by applying yet another constraint namely a constant evaporator temperature. This procedure will be explained below.

In a normal cooling system the pressure in the condenser is controlled by the fan to a certain predefined value. This means that in the warm seasons, where the ambient temperature (T_A) is high, the fan has to work hard to keep the pressure down. In the cold seasons the matter is reversed as the fan almost can be turned off. The compressor will work equally hard in both cases. It is though possible to save some energy, especially in the cold season, by letting the fan bring the pressure in the condenser down as previously mentioned. Since the refrigeration capacity (Q_E) as well as the evaporation temperature (T_E) is kept constant the evaporator fan will operate unchanged at a constant speed independent of the condenser fan speed. Thereby it is possible to lower the overall power consumption only by adjusting N_C and N_{CF} . The superheat is as previously mentioned controlled by the expansion valve which means that eq. 1 can be reduced to

$$\min_{[N_C, N_{CF} | Q_E = \text{const}]} (\dot{W}_C + \dot{W}_{CF}) \quad (3)$$

The optimization problem is now reduced to 1 degree of freedom.

4. CASES

An example on the optimization, given by eq. 3, will be carried out on a simple system like the one shown

in Figure 1. A steady state model of the system and all the components will be used. It is assumed that the torque in the fans have an quadratic dependency of the rotational speed and that the heat transfer coefficients in the condenser and evaporator are proportional with the air velocity. For the compressor is used catalog data for a standard scroll. The objective of the following example is to give an idea on how the optimization scheme works as well as to show what amount of energy it is possible to save.

Two different cases will be dealt with, the warm and the cold season, where the ambient temperature respectively is high and low. For both cases the optimization will be constrained by a constant refrigeration capacity and a constant evaporation temperature. Further more it is assumed that the superheat as well as the subcooling are constant. In Table 1 the values used in optimization is showed.

Refrigeration capacity	$Q_E = 8 \text{ kW}$
Evaporation temperature	$T_E = 0 \text{ }^\circ\text{C}$
Superheat	$SH = 10 \text{ K}$
Subcooling	$SC = 5 \text{ K}$
Warm season	$T_A = 25 \text{ }^\circ\text{C}$
Cold season	$T_A = 0 \text{ }^\circ\text{C}$

Table 1. Constrains used in optimization

5. RESULTS

The result achieved, by using the discussed optimization scheme and the constraints listed in Table 1, is shown in Figure 6. It can be seen that if an optimal condenser pressure (OCP) control strategy is used, it is possible to reduce the power consumption ($W_C + W_{CF}$) in the cold season ($T_A = 0 \text{ }^\circ\text{C}$) by approximately 30 % from 2,51 kW till 1,69 kW. This result is achieved by comparing with a constant condenser pressure (CCP) controlled system that runs optimally at $T_A = 25 \text{ }^\circ\text{C}$. The energy reduction is achieved by letting the fan bring the condenser pressure down from 1363 kPa to 751 kPa, as it was discussed previously in section 3. The power consumption in the evaporator fan is of course in either cases equal and constant, since Q_E as well as T_E are kept constant at all times.

To give an overall impression of the energy saving potential, a comparison between an overall optimal control (OOC), an OCP and a CCP controlled system are made. The power consumption using these three control schemes are shown in Figure 7. It is assumed that the OCP and the CCP controlled system runs optimally at $T_A = 25 \text{ }^\circ\text{C}$. As the figure shows, grows the energy saving potential for a CCP controlled system as T_A changes from the optimal point. At an ambient temperature at $T_A = 15 \text{ }^\circ\text{C}$ it is possible to reduce the power consumption in compressor and condenser fan with about 10%, at $T_A = 10 \text{ }^\circ\text{C}$ with 15% and so forth. It can further more be seen that the OOC and the OCP curve almost are equal. This means that the overall optimal evaporation pressure almost is independent

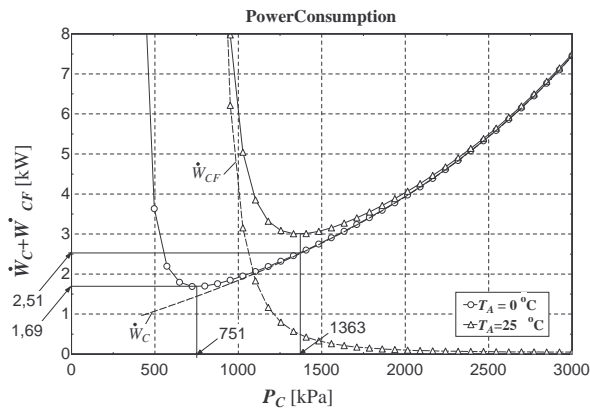

Fig. 6. Power consumption in the compressor and condenser fan, respectively with an ambient temperature on 0 °C and 25 °C .

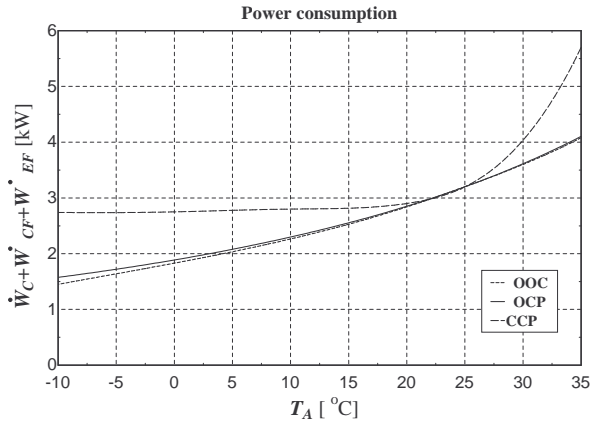

Fig. 7. The total power consumption at various ambient temperatures for an OOC, OCP and a CCP control strategy.

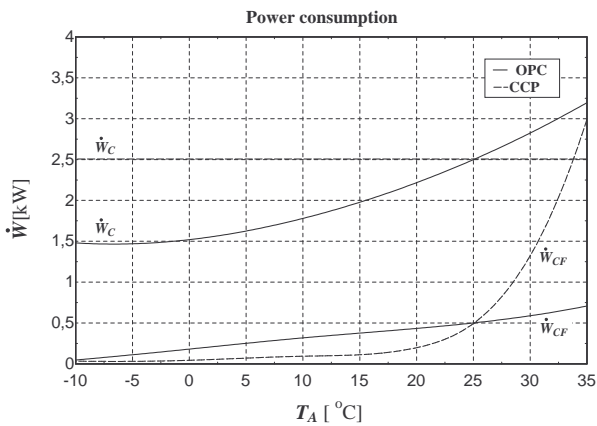

Fig. 8. Power consumption in respectively the compressor and condenser fan at various ambient temperatures for an OCP and a CCP control strategies.

of P_c . It has not been shown here but the revers also applies, that is the optimal condenser pressure almost is independent of the condenser pressure. This means that the overall optimization problem can be divided in to two independent optimizations of respectively the

condenser pressure and evaporator pressure.

In Figure 8 the power consumption in the individual components using the OPC and CCP strategies is shown. It can be seen that at low temperatures ($T_A < 25$ °C) the OCP strategy lets the fan work harder than the CCP strategy does in order to bring the condenser pressure down and thereby the power consumption in the compressor as well. At higher temperatures ($T_A > 25$ °C) it pays off to let the pressure rise and thereby letting the compressor work harder than the CCP strategy would.

The exact percentage that it is possible to save depends however not only on T_A , but on T_E and of course on the specific characteristics of the compressor and the fans as well. The above made calculations does however indicate, that a substantial reduction in the power consumption can be achieved by introducing an OCP control scheme. To achieve the potential energy saving with an OCP, one though has to apply some sort of intelligent set point control to adjust the 3 inputs N_C , N_{CF} and OD , Jakobsen et al. [2001]. The problem can however be reduced in a way such that it is possible to achieve the optimal set points only by adjusting the condenser fan speed (N_{CF}) in an intelligent way. This matter will be dealt with below.

The optimization were made under the constrains that Q_E , T_E , SH , SC and T_A were constant. If the compressor controls the suction pressure, the expansion valve controls the superheat and the cooling load is assumed to be constant, then T_E , SH and Q_E will remain unchanged (at steady state) regardless of how the condenser fan is controlled. If it furthermore is assumed that SC and T_A are independent of the condenser fan speed and constant at all time, then all of the constrains are fulfilled independently of the condenser fan speed. This means that the optimization can be carried out only by applying an optimization scheme on the condenser fan. The other inputs will automatically be controlled in such away that the optimum will be encountered. This was however under the unargued assumption that SC and T_A were independent of the condenser fan speed and constant. For T_A it seems to be a fair assumption, whereas it for SC is not quite accurate. How the SC will vary as the operating point alters depends as previously mentioned on size and shape of the condenser. The error made by this assumption will therefor be a system specific parameter.

6. CONCLUSIONS

As a step towards an overall energy optimal operation of a refrigeration system, it is shown that a substantial amount of energy can be saved by using a suboptimal control strategy. By finding an optimal condenser pressure, without changing the cooling capacity, it is possible to lower the energy consumption, especially in the cold seasons where the ambient temperature is low. This optimization scheme leads towards a more feasible control strategy, in which only a single input,

the condenser fan speed, has to be manipulated in an intelligent way in order to achieve an energy optimal operation. Furthermore this optimization scheme can be applied to a system which has a capacity and a superheat control without altering these control loops.

References

- Gruhle, W., Isermann, R., 1989. Model based design of an improved evaporator control in refrigeration cycles. *Automatisierungstechnik* (4).
- Jakobsen, A., Rasmussen, B., Skovrup, M., Fredsted, J., July 2001. Development of energy optimal capacity control in refrigeration systems. International Refrigeration Conference, Purdue.
- Parkum, J., Wagner, C., 1994. Identification and control of a dry-expansion evaporator. In: *Identification and Control of a Dry-expansion Evaporator*. 10th IFAC symposium on system identification, Copenhagen, Denmark.