



Real life test of a novel super performance dew point cooling system in operational live data centre

Xiaoli Ma^{*}, Cheng Zeng, Zishang Zhu, Xudong Zhao, Xin Xiao, Yousef Golizadeh Akhlaghi, Samson Shittu

Centre for Sustainable Energy Technologies, University of Hull, HU6 7RX, UK

HIGHLIGHTS

- An innovative dew point cooling system was designed, constructed, installed and real live tested in live data centre.
- The system can provide continuously stable cooling air and maintain the required temperature and humidity in data centre.
- The average COP of 29.7 was achieved during the testing period.
- 90 % energy saving can be achieved for data centre cooling.
- Suitability, stability and reliability of the system used in data centre environment were proved.

ARTICLE INFO

Keywords:

Dew point cooling
Coefficient of performance
Real life testing
Data centre
Energy saving

ABSTRACT

This paper presents the development and application of a super performance dew point cooling technology for data centres. The novel super performance dew point cooler showed considerably improved energy saving and carbon reduction for data centre cooling. The innovations of this technology are built upon a series of technological breakthroughs including, a novel hybrid flat/corrugated heat and mass exchanging sheets, an innovative highly water absorptive and diffusive wet-material for the sheets which enable an intermittent water supply with well-tuned water pressure and flow rate, and the optimised fan configurations. Following a list of fundamental research including theoretical, numerical and lab experimental testing of a small scale prototype system, a specialist 100 kW rated data centre dew point cooling system was dedicated designed, constructed, installed and real life tested in an operational live data centre environment, i.e., Maritime Data Centre at Hull (UK) to investigate its dynamic performance, suitability and stability for application in operational data centre environment conditions.

During the testing period, the system showed its reliability and capability to remove a tremendous amount of heat dissipated from the IT equipment and maintain an adequate space temperature in the operational live data centre. The dynamic data collection and analysis during the continuous testing and monitoring period showed the average COP of 29.7 with the maximum COP of 48.3. Compared to the existing traditional vapor compression air conditioning system in the data centre, the energy saving using the super performance dew point cooling system is around 90 %. The work presented in this paper include detailed innovation aspects of the technology and the system operation, as well as the established bridging knowledges, methodology and technical procedure for bringing this new technology into real life operation which involve in data centre survey, optimum design and modularization of the specialist cooling system for data centre application, proven system installation, operating method and cooling air management for data centre as well as the assurance of the continuous sufficient cooling supply to the data centre.

^{*} Corresponding author.

E-mail address: x.ma@hull.ac.uk (X. Ma).

<https://doi.org/10.1016/j.apenergy.2023.121483>

Received 2 March 2023; Received in revised form 6 June 2023; Accepted 15 June 2023

Available online 3 July 2023

0306-2619/© 2023 The Author(s). Published by Elsevier Ltd. This is an open access article under the CC BY license (<http://creativecommons.org/licenses/by/4.0/>).

1. Introduction

1.1. Research motivation and data centre cooling technologies

Information technology (IT) is playing a prominent role in daily life such as smart transportation and smart communication. Computing systems have been focused on performance improvements, driven by the demand of user applications in past few decades, particularly from 1990 to 2010 [1]. However, due to their ever-increasing energy demand which causes large energy bills and CO₂ emissions, over the past ten years the focus has shifted towards energy-performance aware, which has resulted in increasing interest in more advanced and energy-efficient data centres and HVAC (Heating, Ventilating and Air Conditioning) systems.

The existing data centres consume a huge amount of energy, where cooling contributes a significant share [2]. In 2016, about 416 billion kWh electrical energy was consumed by data centres, which is even more than the total energy consumption of the UK [1]. A large share of energy usage, 30 %–40 %, was consumed by the cooling systems to manage the heat produced by the servers and control the indoor temperature and humidity to maintain a suitable indoor environment for the servers [1,3]. This is because the existing cooling systems for data centre are energy intensive and they are running constantly to extract the heat from the servers. The traditional cooling equipment of data centres is a specialist computer room air conditioner (CRAC) unit, based on mechanical vapour compression refrigeration technology that currently dominates the market, can consumes 40 % of the total electrical energy of a data centre [4,5]. Using energy-efficient cooling technology is critical for reducing the energy consumptions of data centres. In recent years, several alternative cooling technologies have appeared on the market, such as adsorption, absorption, ejector, and evaporative cooling types.

Table 1 gives a general profile of the various cooling technologies.

The adsorption, absorption and ejector, can mitigate the problem of high electrical energy consumption but bring in the disadvantage of very low cooling COP and using relatively high temperature heat source, which are inapplicable to Data Centres [10,11].

Evaporative cooling technology including dew point cooling technology, making use of the latent heat of water to cool the air, can achieve

Table 1
General profile of various cooling technologies.

Cooling technologies for data centres	Features	
	Advantages	Disadvantages
Mechanical vapour compression cooling technology	Mature technology, compact and lower capital cost.	Driven by electrical energy with low COP of 2–4; high electrical energy consumption and carbon emission [6].
Absorption/adsorption cooling technology	Can be driven by low grade thermal energy, e.g., solar thermal energy, industrial waste heat; using environment friendly working fluid.	Very low COP of 0.6–0.9; higher capital cost and bulk system [7].
Ejector cooling technology	Can be driven by low grade thermal energy, e.g., solar thermal energy, industrial waste heat, few moving parts and so relatively simple structure.	Very low COP of 0.4 – 0.7, large size and high capital cost [8].
Evaporative cooling including the dew point cooling technology	Advantages: High COP of 20 in existing commercial system; using water evaporation to produce cooling and no harmful working fluid; simple system structure;	Large size and so high capital cost [9].

a high COP of 20–25 leading to significant electrical and thermal energy saving, and is a simple structure cooling technology with growing popularity for using in air conditioning [12,13,14], is a most promising technology for data centre cooling and has been applied to data centres in the UK and worldwide.

1.2. Dew point cooling technology, its state of the art and our innovations

Indirect evaporative cooler can achieve cooling air by heat transfer between the wet and dry channels, with the water evaporation on the wet channel surfaces, therefore it can reduce the temperature of air without added moisture. However, due to the theoretical constraint of the air's wet bulb temperature, this kind of cooling technology has very limited temperature reduction potential. Dew point cooling, which is a new generation of indirect evaporative cooling, can break this limit and enable air to be cooled approaching its dew point, and therefore achieving average 20–30 % higher cooling efficiency than traditional indirect evaporative cooling [15]. This technology is based on a modified heat and mass exchanger, i.e., Maisotsenko Cycle heat and mass exchanger. Due to this advantage, this technology has attracted growing attentions of researchers in recent years. The research are focused on improving the flow patterns of the existing flat-type counter and cross flow heat and mass exchangers to enhance heat transfer capability, increasing the wet surface performance to promote water retention and wicking capacity, optimal operational and geometrical conditions for the heat and mass exchanger to improve the operational cooling efficiency. [16–19].

Although many advances have been achieved in the past decade, this kind of units still have relatively low temperature reduction, leading to problems such as a larger system size, larger flow rate and higher cost [20–24]. Three challenges should be addressed to improve the evaporative cooling performance, including (1) limited heat transfer capacity of the heat and mass exchanger; (2) poor water absorption and diffusion capacity of the wet channel surface of the heat and mass exchanger; and (3) higher electrical power demand by the pump and fans.

To tackle the above problems, this research developed a novel complex heat and mass exchanger which, bring a series of technological breakthroughs, namely (1) hybrid flat/corrugated heat and mass exchanging sheets as a replacement of flat-plate sheets with increased heat transfer area; (2) Removal of the use of the channel supporting guides achieve obviously reduced air flow resistance; (2) An excellent wet material layer, i.e., Coolmax® fabric has been identified. This material having higher water absorptive capacity, higher water absorptive, diffusive and evaporative rates, higher diffusive and evaporative rates and larger capillary force, and strong binding capability with dry side material compared to other existing wet materials, showed its super performance in use for evaporative cooling (3) The high absorption capacity of the wet material layer allows the implement of the intermittent water supply scheme with well-tuned water pressure and flow rate to optimise the amount of water supply to improve the performance of the system and also minimize the water pump power consumption; (4) optimised fan configurations to minimize the fan power consumption. More details of these innovations are presented in Section 2.1.

Owing to the combination of above innovations, a super performance dew point cooler has been generated, which can achieve a COP of 52.5 in laboratory testing conditions, leading to 50 % and 90 % saving in electricity consumption compared to the similar systems and traditional mechanical vapour compression systems respectively, and consequently, a significant reduction on carbon emission. The significant leap forward in energy performance index (COP) has attracted the UK Industrial Energy Efficiency Accelerator (IEEA) research fund, supported by Department for Business, Energy and Industrial Strategy (BEIS) for a real life testing and demonstration of this novel super performance dew point cooling technology in an operational live data centre in order to investigate the dynamic performance, suitability and stability of the novel dew point cooling system in operational environment conditions.

The output and value of the completion of this IEEA (BEIS) project is presented in Section 1.3.

1.3. Output and value of the real life test of the super performance dew point cooling technology in operational live data centre

Following a list of fundamental research including theoretical, numerical, and lab experimental studies on the super performance dew point cooling technology carried out by authors [25–28], a real life testing and demonstration of this technology was carried out at Maritime Data Centre in Hull city centre UK, supported by UK IEEA (BEIS). This is the first real-life application of the super performance dew point cooling technology to data centres.

A 100 kW rated specialist dew point cooling system was designed and installed in Maritime data centre for real life testing and demonstration, the work involved in data centre survey, modular system design and optimisation of a specialist dew point cooling system for the data centre, as well as system construction and site installation, cooling air management for live data centre, real life testing and monitoring, dynamic data collection and analysis. Completion of the work has provided detailed bridging knowledges and methodology as well as technical procedure for bringing this new technology into real life operation, demonstrated real time performance of this technology in operational live data centre, and established evidence of suitability and reliability as well as 90 % of energy saving of using the super performance dew point cooler in data centres. The details are presented in this paper.

Accompanying the valuable outputs from the real life test, there is a significant value in adopting the super performance dew point cooling technology in data centres in the UK and worldwide. Statistics show there are 278 and 1763 collocation data centres in the UK and EU respectively, while the small scale “in-house” data centres are over 10,000 and 50,000 respectively [29]. As a result, the electrical energy used in the data centres in the UK and EU are around 40 TWh and 150 TWh respectively. Adopting the super performance dew point cooling technology in data centres would result in 36TWh and 135TWh energy saving in the UK and EU.

2. Description of the super performance dew point cooler and its innovations

2.1. Working principle of the dew point cooling technology

The dew point cooling process is based on an indirect evaporative cooling (IEC) heat and mass exchanger (Fig. 2.1) and the M-cycle principle. The intake air is introduced into the dry channels (product

channels) of the exchanger, where the air moves forward along the dry channel and meanwhile loses heat to the adjacent wet channels (working channels), for the temperature difference between the dry and wet channels and water evaporation on the wet channel wall. At the end of the dry channel, the air is divided into two parts. One, namely the product air, is delivered into the conditioned space for space cooling, while the second, namely the working air, is diverted into the adjacent wet channels for water evaporation. Within the wet channels, the working air moves backwards, absorbing the heat transferred from the dry channels and receiving the moisture evaporated, thus completing a heat and moisture transition process from one part of the air to another. The performance of the dew point cooling system is affected by the intaking air’s humidity and temperature, which is usually dependant on the weather conditions when the system is used as a building air conditioner.

2.2. Innovations of the super performance dew point cooler

The super performance dew point cooler presented in this paper has significantly enhanced performance compared to the existing similar systems, which contains four major innovations, detailed as follows.

2.2.1. Complex heat and mass exchanger

A traditional heat and mass exchanger comprises numerous flat-plate sheets that are stacked as a block, with the triangular air guides supporting the adjacent sheets. Each sheet is drilled with many tiny holes that allow part of airflows to divert from the dry channel to the adjacent wet channels. The flat-plate heat exchanger, either cross- or counter-flow type, has a limited temperature reduction potential due to the limited heat transfer area, resulting in problems of larger size and higher cost which have impeded its broader application.

The novel complex heat and mass exchanger developed by authors is shown in Fig. 2.2, it comprises numerous shape-changing heat and mass exchanging sheets. Each sheet has a corrugated shape in the main heat transfer portion for increasing the heat transfer area and heat transfer rate between the dry and wet channel air, and a flat shape in the air flow entry and exit portions for facilitating the water and air distribution. Comparing to a traditional flat plate heat and mass exchanger, this structure increases the heat transfer area and heat transfer rate by around 40 %, leading to the increase of the same percentage of heat transfer rate. In addition, it can remove the use of the triangular air guides in traditional flat type heat exchanger and thus reduce air flow resistance across the channels by around 50–56 %, a comparison of the cross section view of the complex exchanger and flat plate exchanger is shown in Fig. 2.3.

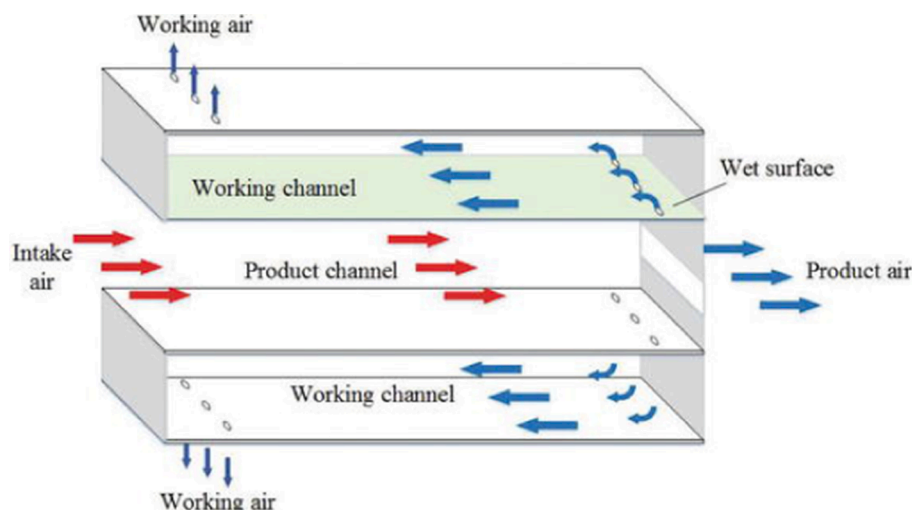


Fig. 2.1. Schematic of the traditional flat-plate heat and mass exchanger.

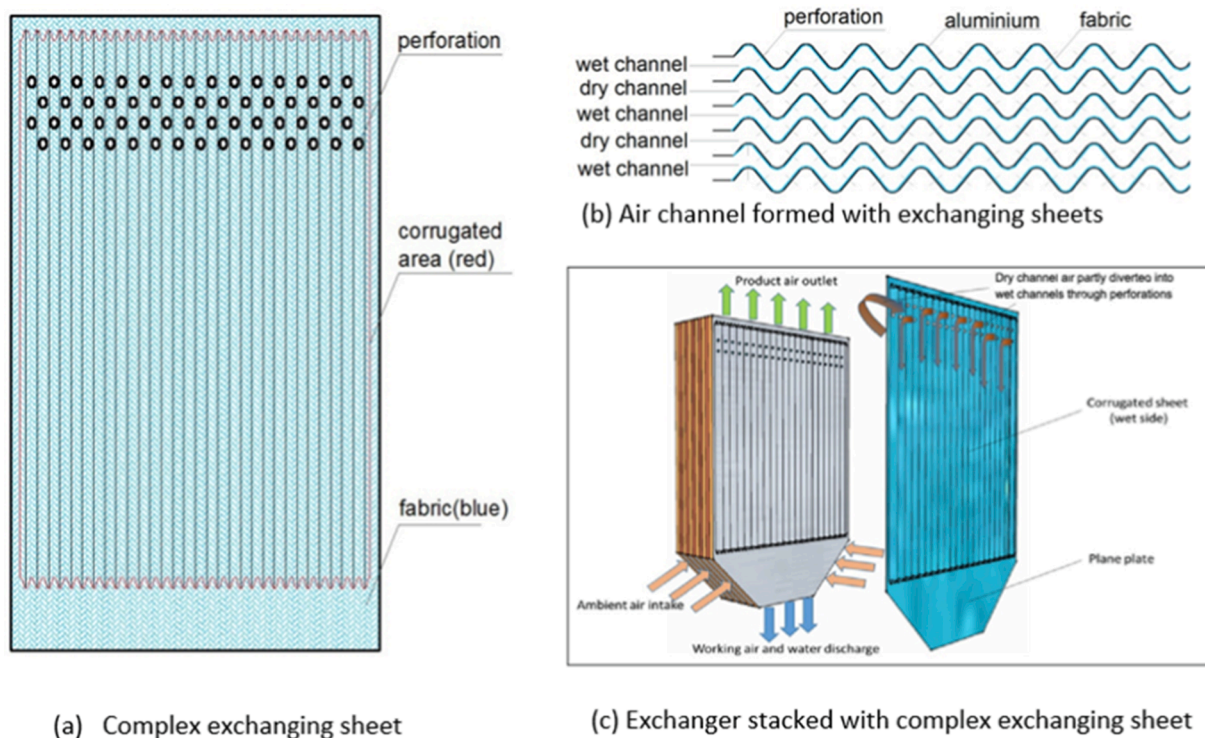


Fig. 2.2. Novel complex heat and mass exchanger.

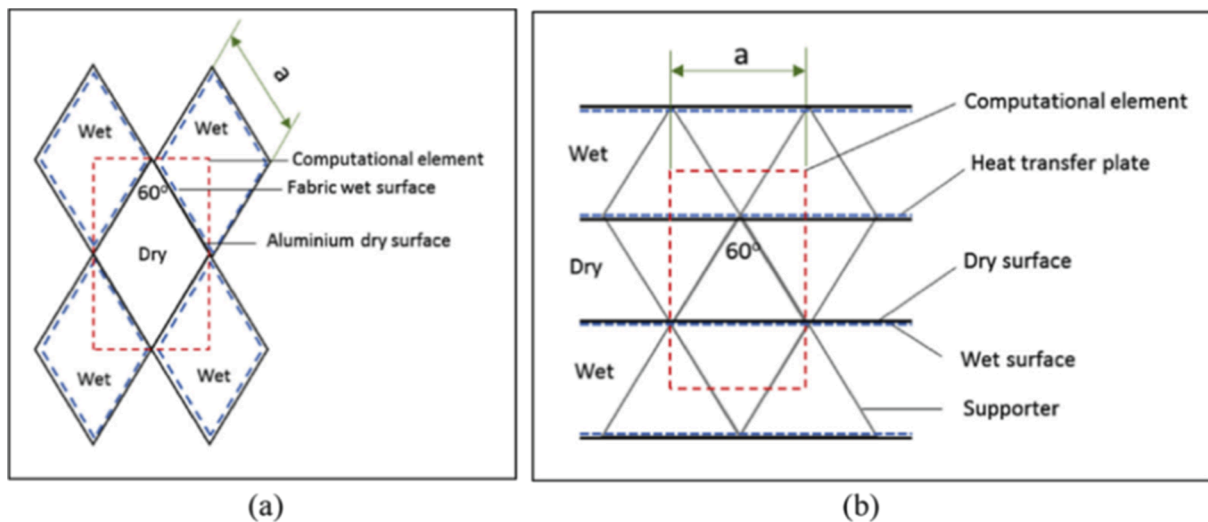


Fig. 2.3. Cross section view: (a) complex exchanger; (b) flat plate exchanger.

2.2.2. High water absorptive and diffusive wet agent

An indirect evaporative cooling heat and mass exchanging sheet consists of two materials, i.e., dry and wet agents, which are bonded together using an appropriate method. The wet agent is an element critically affecting the performance of evaporative cooling. Ideally, a wet agent should have a superior water absorptivity, a high water diffusivity, a fast evaporation rate, and strong binding effectiveness with the dry agent.

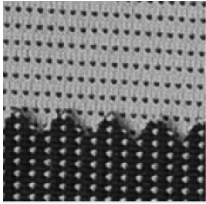
By testing a range of wet agents (textile fabrics), the best performing wet agent, i.e., Coolmax® fabric, was identified by authors. The general assessment concerning both the moisture transfer and mechanical properties (ease of adhesive bonding). The selected Coolmax® fabric has increased vertical wicking rate of 171 %, diffusion rate of 37 % and evaporation rate of 14 % compared to the conventional Kraft paper,

which creates excellent water absorption, diffusion and moisture evaporation effect on the wet surface, thus significant improving its cooling performance. In addition, the Coolmax® fabric can be well bonded with the dry agent (i.e. a specific aluminium with high malleability) using a strong marine heat transfer adhesive, the fibre has the features of high durability, easy of shaping, cleaning and replacement, and thus is particularly suitable for indirect evaporative cooling application. The specification of the Coolmax® fabric is shown in Table 2.

2.2.3. Intermittent water pump operation with well-tuned water flow rate

Water distribution and water film thickness on the wet agent are critically important to evaporative cooling. Ideally, water should be uniformly distributed across the wet agent with no dry areas remaining but also no thick film established. To achieve such an effect, the water

Table 2
Specification of the Coolmax® fabric.

Photo of the fabric	Fabric brand	Specification		
		Breadth (cm)	Weaving	Weight (g/m ²)
	Bamboo charcoal + Coolmax® active	155	75D	150

pump should be operated intermittently with tuned pressure and flow rate, and the water volume flow rate was controlled to an optimum level. The high absorption capacity of the wet agent layer (i.e., Coolmax® fabric) enables it to hold significant amount of water for a relatively longer period. This allows implementing the intermittent water supply scheme and can also minimize the water usage and water pump power consumption. To enable achieving the desired water supply and distribution, a dedicated water distributor was designed and constructed and an intermittent water supply scheme was applied. Fig. 2.4 shows the structure of the water distributor.

2.2.4. Optimised fan configuration

In our dew point cooler, the fan structure and associated motor type and two-party coupling were investigated using CFD and structure optimisation approach. This yields the optimised fan structure, most appropriate motor, and the best coupling approach between both.

Based on the above innovations, the new cooler has significantly enhanced COP of 52.5 compared to the commercial dew point air cooler (Coolerado® M30) with a COP of 18.4 for operation on the same climate conditions (dry bulb temperature of 37.8 °C, relative humidity of 21.7 %), which has been found by experimental lab testing of a small scale prototype system.

2.3. Configuration and operation of the super performance dew point cooler

The super performance dew point air cooler is composed of a heat and mass exchanger, water distributor, supply air fans, exhaust air fans, water tank, circulating water pump, and a water piping loop, the intake/supply/exhaust air vents, and controllers for the pump and fans, all of which are integrated into a metal case to form an integrated cooling unit. Fig. 2.5 shows the structural view of a constructed dew point cooler unit.

On operation, the ambient air driven by the supply air fans enters the inlet of the heat and mass exchanger, the product air is supplied from the top air supply vents of the dry channel and the exhaust air from the wet channel driven by the exhaust air fans is dissipated to the environment

through the air exhaust vents. The water sink located under the heat and mass exchanger collects the extra water falling from the wet channel and store the tap water for the system operation, the water pump located below the water tank is used to circulate the water from the water sink to the water distributor (not shown in the Figure) located on the top of the heat and mass exchanger.

3. The operational Maritime Data Centre

The real life test and demonstration site is Maritime Data Centre at Hull city centre. The super performance dew point cooling system is installed at the IT server room to provide cooling for the room. Fig. 3.1 shows the Data centre building and its IT server room.

The existing conditions in the IT server room are presented as follows.

3.1. Size, layout of the IT room and the existing air conditioning system

The dimension of the IT server room as well as the dimension and layout of each component inside the room are shown in Fig. 3.2.

The top view of the room in Fig. 3.2(a) shows the dimensions of the room of 101 m² and the size/layout of the 28 IT racks in three rows with a total maximum IT load of 150KW inside the room. In Fig. 3.2(a), the labels 1, 2 and 3 signify the three air handling units of the existing vapor compression air conditioning system, each has a cooling capacity of 90KW and four return air inlets located at the bottom of each air handling unit, shown in Fig. 3.2(b).

Fig. 3.2(c) is a 3-D drawing showing the two windows of the IT room. Fig. 3.2(d) shows the layout of ceiling grilles (cooling air outlets), which are shown in black colour in the Fig. 3.2(d). The air handling units of the existing vapor compression air conditioning system deliver cold air through ceiling grilles and intake warm air through the return air inlets at the base of the units. The chillers of the existing air conditioning unit are located at courtyard next to the IT room in the data centre.

3.2. IT load profile, cooling load and required cooling requirement

As mentioned in Section 3.1, the total maximum IT load in the room is 150 kW, which is assumed by all the servers being in operation simultaneously. However, the server’s operation is random, i.e., not all the servers are always in operation. Fig. 3.3 shows the dynamic IT load profile based on the IT room operation in a month.

This maximum 150 kW IT load can lead to an estimated maximum cooling load of 89 kW in summer (July to August), calculated based on heat gain and heat transfer to the outside environment. However, due to random operation of the server and the impact of seasonal weather the cooling requirement usually is usually far below this value of 89 kW.

For data centre cooling, it is very important to ensure continued and sufficient cooling, otherwise, the IT equipment can be damaged or its operation is failed. The existing traditional vapor compress air conditioning system in the IT server room has a far from sufficient cooling

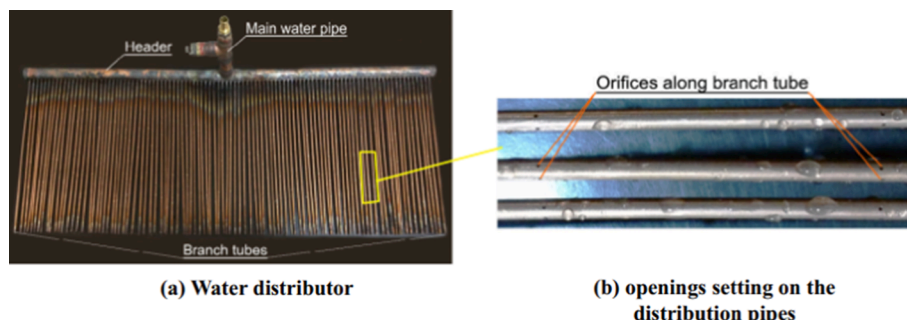


Fig. 2.4. Structure of the water distributor.

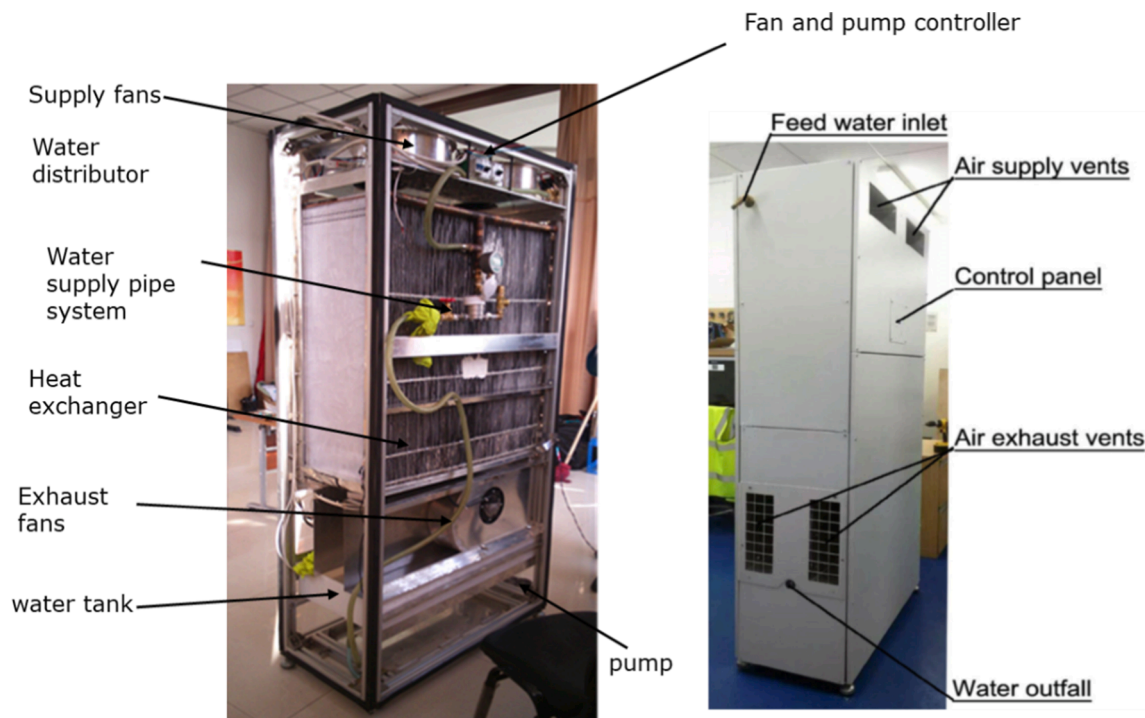


Fig. 2.5. Structural view of the dew point cooler unit (a) internal view; (b) the complete unit.



Fig. 3.1. (a) Maritime data centre building (b) IT server room of the data centre.

capacity than its current requirement (because this IT room has a potential to accommodate more IT servers). As mentioned in Section 3.1, there are three air handling units in the IT server room, each has a cooling capacity of 90 kW, wherein, one of them is currently used as a backup in maintenance period, two of them are keeping in running in order to get return air from two side of the room, although the cooling from one unit may usually satisfy the cooling requirement.

Based on the estimated maximum cooling load of 89 kW, a 100 kW specialist modular super performance dew point cooling system was dedicated designed, constructed and installed in the data centre for real-time testing and analysis. The details can be seen in Section 4.

3.3. Cooling air management

The cooling air management of the existing traditional air conditioning system in Maritime Date Centre is managing cooling air supply at room level, i.e., it distributes the cooling air on the room level evenly

through the ceiling grilles (see Fig. 3.2 (b)), which is mostly suitable for small scale data centre.

4. Dew point cooling system design, construction and installation

A 100 kW modular dew point cooling system was designed, constructed and installed at the IT server room in Maritime data centre to provide the cooling for the room and to conduct real-time testing and demonstration of the system. The modular design is necessary as large scale system is applied. The details are presented in Sections 4.1 and 4.2.

4.1. Design and construction

The 100 kW specialist modular cooling system was designed based on a numerical model (for system energy performance prediction) developed and subsequently lab experimental validated by authors

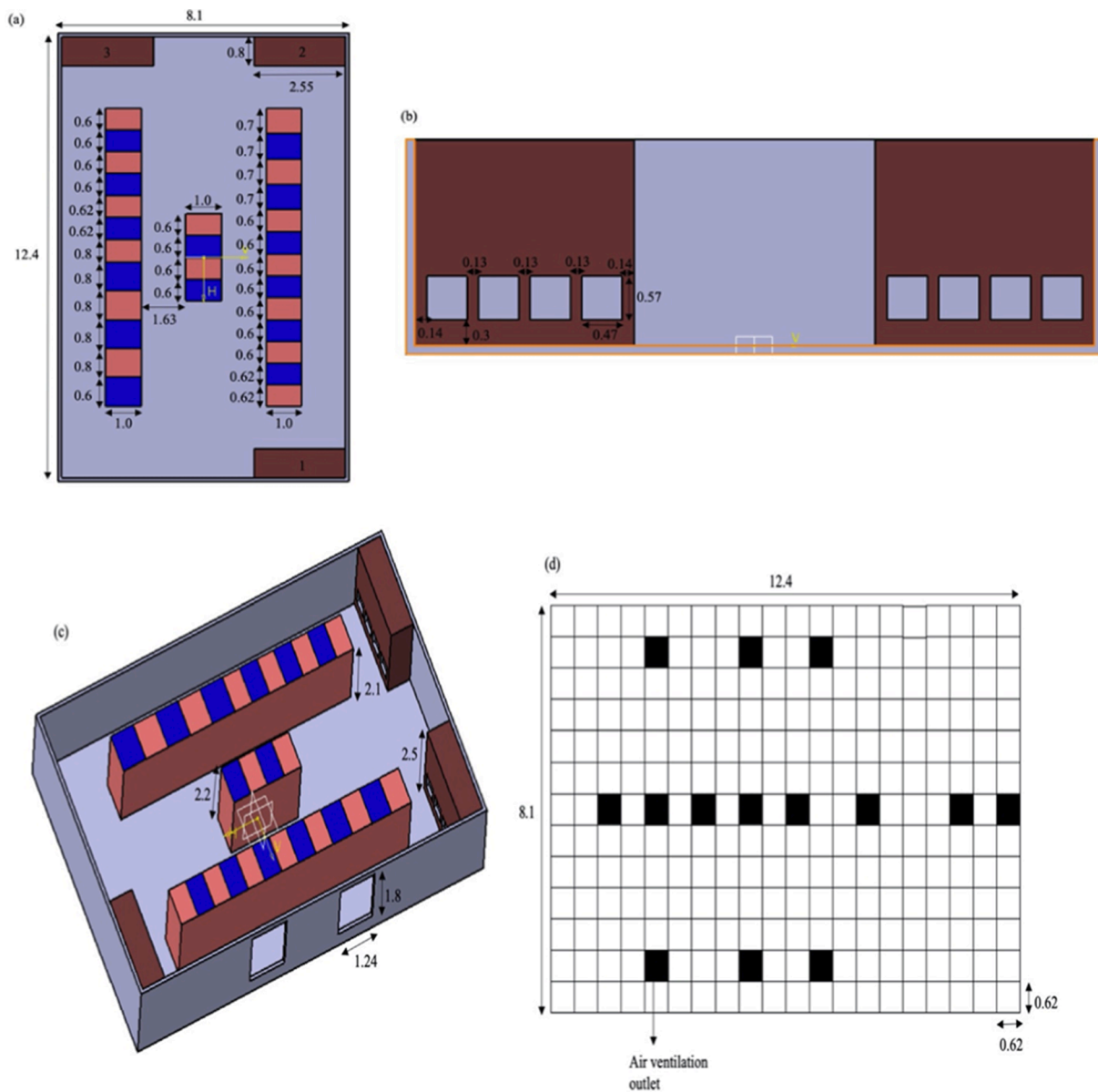


Fig. 3.2. IT server room layout and dimensions (unit: meter) (a) IT racks; (b) air handling unit; (c) IT room with windows; (d) ceiling grilles.

[25,26] and an analytical model enabling the engineering scale design and characterization of the system (by predicting the performance of the dew point cooling system in random operating and variable climate conditions) developed by authors [28].

The 100 kW modular dew point cooling system is comprised of five 20 kW cooler units. For easy of manufacture, the heat exchanger of the each 20 kW unit is divided into two 10 kW individual units and the two 10 kW individual heat exchanger units work side by side and are able to perform the same functions as the single 20 kW heat exchanger unit do, as shown in Fig. 4.1.

Fig. 4.2 shows a 3D drawing of a 20 kW cooler unit that contains two 10 kW units. Each of the 10 kW units has an individual control box and the unit operates independently, which can allow more flexible operation depending the cooling requirement.

Table 3 lists the technical specifications of the fans, pump, and associated controllers in the 20 kW cooler unit.

Fig. 4.3 is a photo of a complete 20 kW cooler unit under pre-installation testing in an environmental chamber.

4.2. System installation

The dew point cooling system can be installed indoor or outdoor to provide cooling for the room. Due to the existing traditional data centre was not designed by considering accommodating such a new technology, there are no space to install the dew point cooling system indoor. The entire 100 kW dew point cooling system, which is composed of five 20 kW cooler units, is therefore installed outside the data centre building and within a working shield. The entire ducting system of this installation include an outdoor ducting system that connects all the cooler units together, an indoor ducting system with air distributors and a cooling supply air/return air ducting system that connects the outdoor system to the indoor ducting system.

Fig. 4.4 (a) shows the outdoor ducting system that connects the cooler units together, it is seen that the outdoor fresh air and IT server room return air go into the air mixing box and are mixed in the box. The mixed air then flows to each of the 10 kW dew point cooler units as an intake air of the system. Fig. 4.4 (b) shows a schematic drawing of complete system installation. As shown in Fig. 4.4 (b), the IT room return air duct is used to conduct the IT room exhaust air from indoor to

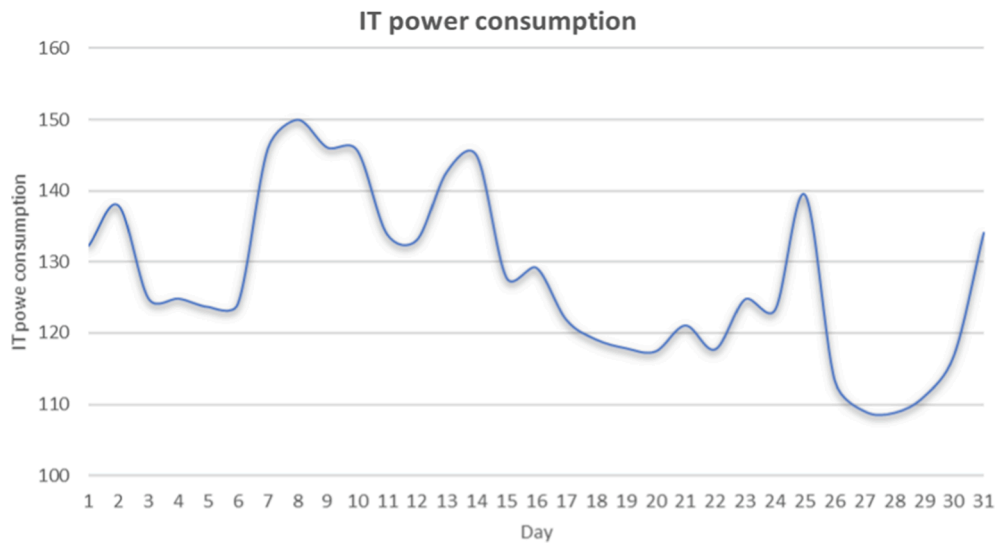


Fig. 3.3. IT load profile.

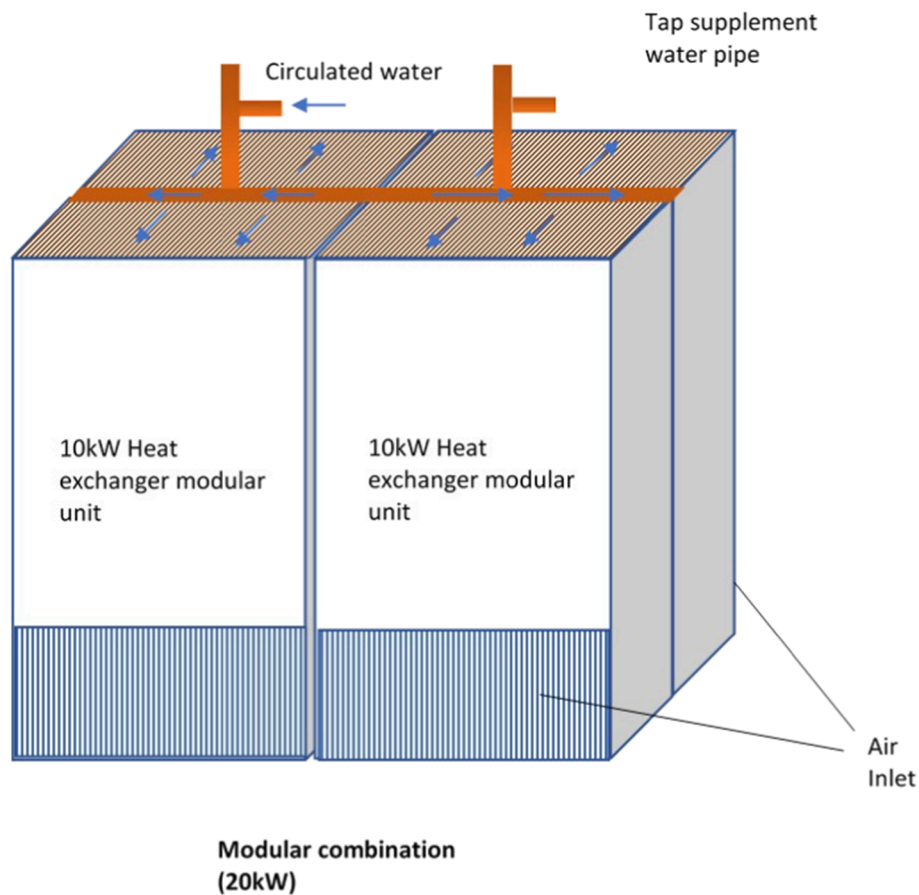


Fig. 4.1. 20 kW heat exchanger modular unit.

the outdoor air mixing box, and the supply air ducting system connecting to the product air outlet of each the 10 kW dew point cooler unit is used to supply the cooling air to the IT room. The exhaust air from the cooling system is dissipated to the outdoor environment.

Fig. 4.5 shows photos of the demonstrator installed outside the building in a work shield and IT server room indoor ducting system.

5. Real life test and results analysis

Real life test was carried out at Maritime Data Centre for continuous 6 weeks to investigate the performance and reliability of the super performance dew point cooling system operating in an operational live Data Centre. To conduct a six-week continuous system operation, the dew point cooler units was set as the main cooling units while the existing traditional vapour compression air conditioning system was set

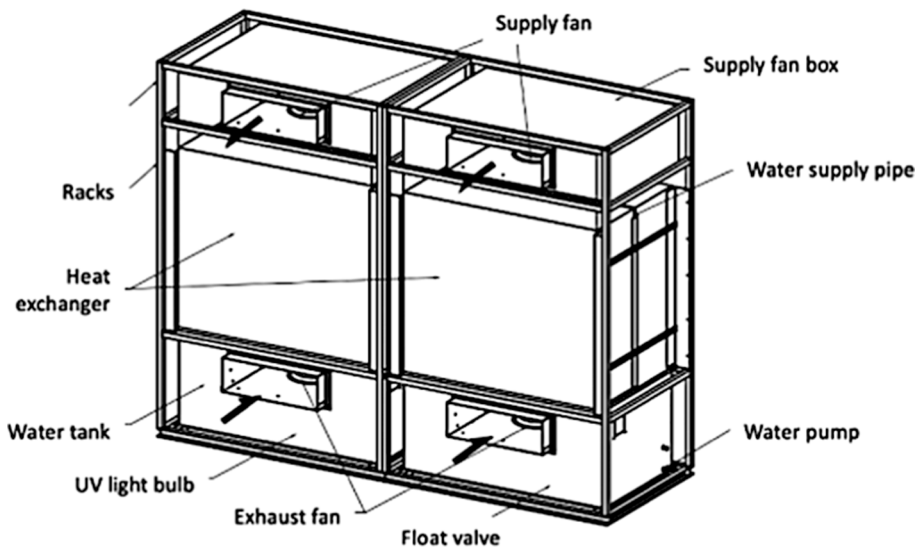


Fig. 4.2. 3D drawing of 20 kW cooler unit.

Table 3
Technical specifications of the fans, pump and associated controllers.

Component	Specification	Quantity (per20kW unit)
Intaking air fan	R3G355-AM14-61, ebm-papst Ltd	2
Exhaust air fan	R3G310-AN43-71, ebm-papst Ltd	2
Circulated water pump	DC40F-2460	2
Fan controller	980-CAS11007 – TMS Controller, ebm-papst Ltd	2
Pump controller	DH48S-S, Xinling Electrical Co. Ltd	2

On the test and monitoring period, the intake air of the dew point cooling system takes 80 % of IT room return air and 20 % of outdoor fresh air intending to reduce the affect from the variable weather conditions and ensure a stable system operation.

A measurement and control system were set up for real life performance test of the 100 kW dew point cooling in the operational live data centre, the test results are analysed and discussed. The details are presented in Sections 5.1 and 5.2.

5.1. Measurement and control system

As above mentioned, the modular dew point cooling system consists of five 20 kW coolers, each of the 20 kW coolers contains two 10 kW units, each 10 kW unit has its individual control box and can be operated independently. This setting allows the flexible system operation to meet various cooling requirements, i.e., in case of the cooling load getting lower, some of the units can stop the operation. The operation of the system can be further refined by adjusting the fan frequency inside the individual unit to vary the cooling supply rate to meet the different cooling load. The measurement and control system is PLC (COOLMAY ZX3G-24Mr-6AD4DA-A4-V-485) provided by Aolan Ltd, and also, a remote data monitoring system has been set up to allow long-term continuous monitoring, the details of the measurement, control and monitoring system are listed in Table 4.

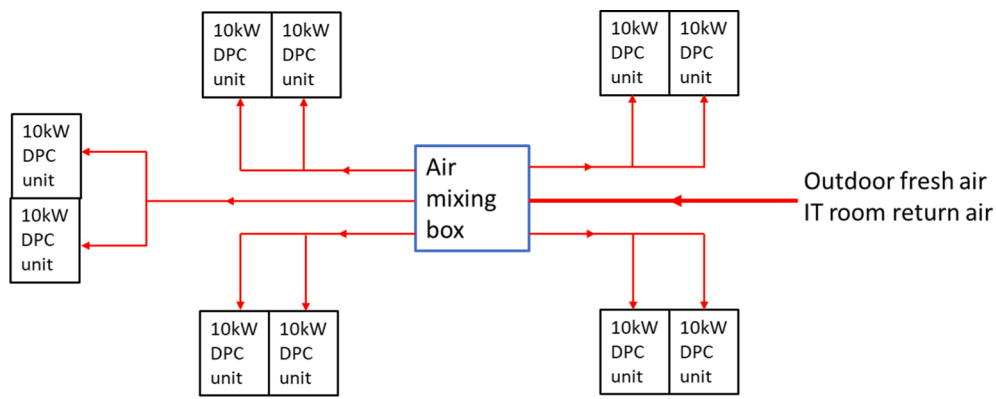
The PLC (COOLMAY ZX3G-24Mr-6AD4DA-A4-V-485) control system, includes both automatic operation module and manual operation module. In manual operation module, the operator can completely perform the operation according to the requirement. In automatic operation module, the functions of the control are performed by control logic.

The measurement and control process is: (1) To provide intermediate water supply to the wet surface of the heat exchanger to ensure the wet surface with sufficient water held and without water film formed; (2) To adjust frequency of the fans to refine the air flow rates; (3) To control the water level in the water base to protect the pump, and when the water level reaches the designed lowest level, tap water can be supplied to the water base automatically; (4) To automatically record the power consumption of the cooler, by inputting the product air flow rate through the interface, the instant cooling capacity and COP can be outputted; (5) To automatically store the testing data including product air humidity and temperature, exhaust air humidity and temperature, intake air humidity and temperature, cooling capacity, COP, total power consumption, cooler running time; (6) To record the running time by timer.

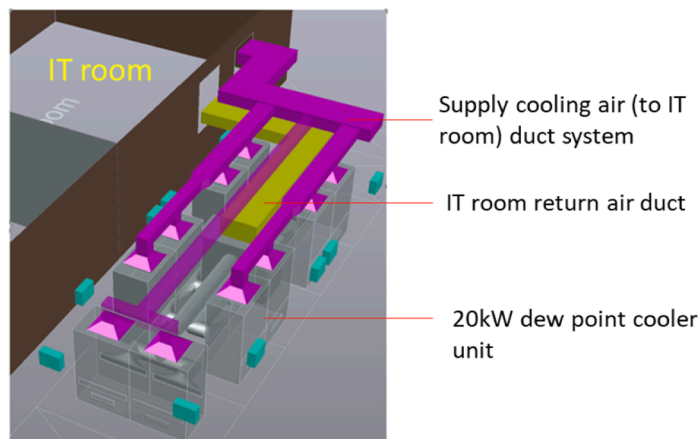


Fig. 4.3. 20 kW cooler unit under preinstallation testing.

as the standby units for any dew point cooler faults or offline during maintenance. The motivation was to ensure the continued and sufficient cooling air cooling air supplied to the data centre room throughout the demonstration stage.



(a)



(b)

Fig. 4.4. 100 kW cooler installation (a) Intake air ducting system; (b) Complete system installation.



(a)

(b)

Fig. 4.5. System installation (a) Outdoor view (b) Indoor ducting system.

The temperature and humidity sensors are installed at intaking air inlets, product air outlets and return air inlets, IT server room environment and outdoor environment for measurements. The power consumption is measured by the electricity meters installed in the dew point cooler control box. All the data were recorded every 5 s.

Dedicated on-site control settings are used for the optimal operation, especially for adjustment of working air ratio (the ratio of working air to

the cooler's intake air) to achieve maximum COP. The complete control, display, and data collection system were installed in the control box on each 10 kW cooler unit, the testing results were collected, analysed. Fig. 5.1 shows the control box and remote sensors.

Table 4
Measurement/control and remote monitoring systems.

Item	Description	Quantity
20 kW measurement and control system	A kit containing two control modules, power meter, air flow sensors, pressure sensors, water level switches, temperature and humidity sensors, LCD display, keypad, relays.	5
Remote monitoring	Master unit reading 5 × 20 kW units with two output interfaces; one serial terminal interface to connect to PC and one RS485 for network connection.	1

5.2. Testing results and discussions

The section presents the results from the six-week continuous monitoring and testing, from 17/09/2021 to 31/10/2021. Table 5 gives a summary of the dew point cooling system performance testing results during the six weeks, including the average cooling capacity, power consumption and COP as well as the maximum COP.

More details of the testing results are presented and discussed as below.

5.2.1. Indoor temperature and humidity

During the continuous monitoring and real life testing period, the cooling system maintains the IT server room’s temperature as desired by extracting the warm indoor air and supplying the cooled air. Fig. 5.2 shows the IT server room indoor temperatures where the room temperature ranges from 18.1 °C to 25.2 °C with the air temperature high in the hot aisles (left and right of the room) and lower in the cold aisle (centre of the room).

In addition to the indoor air temperature, Fig. 5.3 shows the indoor air relative humidity during the monitoring and testing period. The relative humidity ranges from around 55 %–78 %, which is within the ASHRAE recommendations [30]. The relative humidity variation is resulted from the indoor temperature fluctuations while the humidity ratio remains at around 10 g/kg. This is because the intake air contains 80 % of room return air, which leads to a relatively stable humidity ratio.

Fig. 5.4 shows the daily average temperatures of supply (product) air, return air and ambient (outdoor) air of the dew point cooling system during the monitoring and testing period. The supply air temperature is the temperature of the cooled air supplied into the IT server room. The return air temperature is the temperature of the extract air from the IT

server room tested at IT room return air duct. According to the monitoring data, the return air temperature remains relatively stable from 21 °C to 24 °C while the supply air temperature varies with the ambient air temperature in the similar trend, which indicates a lower ambient air temperature can lead to lower temperature cooling air. This is because a lower ambient temperature leads to a lower water temperature and a lower dew point temperature for the cooling process.

Fig. 5.5 shows daily maximum ambient air and supply air temperature, the monitoring shows the dew point cooling system can produce a relatively cool temperature at around 18 °C in warm days of late September where the ambient temperature during the day was around 24 °C. The maximum ambient air temperatures of 17/09/2021 to 19/09/2021 were around 25 °C while the maximum supply air temperature of the dew point cooling system was below 20 °C. Fig. 5.6 shows the three-day’s temperatures from 17/09/2021 to 19/09/2021 where the ambient air temperature varies while the dew point cooling supply temperature is relatively stable. This is also because the relatively stable humidity ratio of the intake air that contains 80 % of room return air, this greatly reduces the effect of the weather condition.

5.2.2. Cooling capacity and COP

With the test data, the cooling performance of the dew point cooling system is evaluated by its cooling capacity and coefficient of performance (COP).

The cooling capacity is calculated by:

$$Q_c = m \times C_p \times (T_r - T_s) \tag{1}$$

where,

Q_c-cooling capacity, kW;

m-supply air flow rate, kg/s;

C_p-air specific capacity, kJ/(kg·K);

T_r-dry channel return air temperature, K;

T_s-dry channel supply air temperature, K;

The COP is the ratio of the cooling capacity to the power consumption of the dew point cooling system, as expressed in equation (2).

Table 5
Summary of the dew point cooling system performance.

Average cooling capacity (kW)	Average power consumption (kW)	Average COP	Maximum COP
53.5	1.8	29.7	48.3

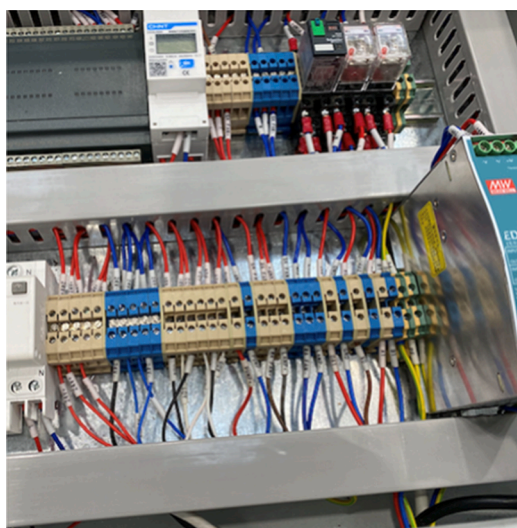


Fig. 5.1. The cooler control box (left) and the remote sensors (right).

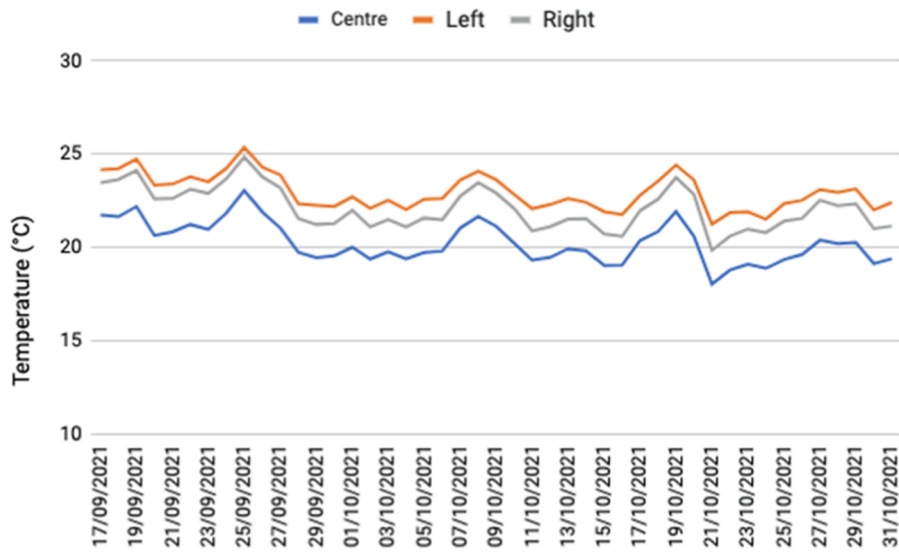


Fig. 5.2. IT server room air temperatures during the testing period.

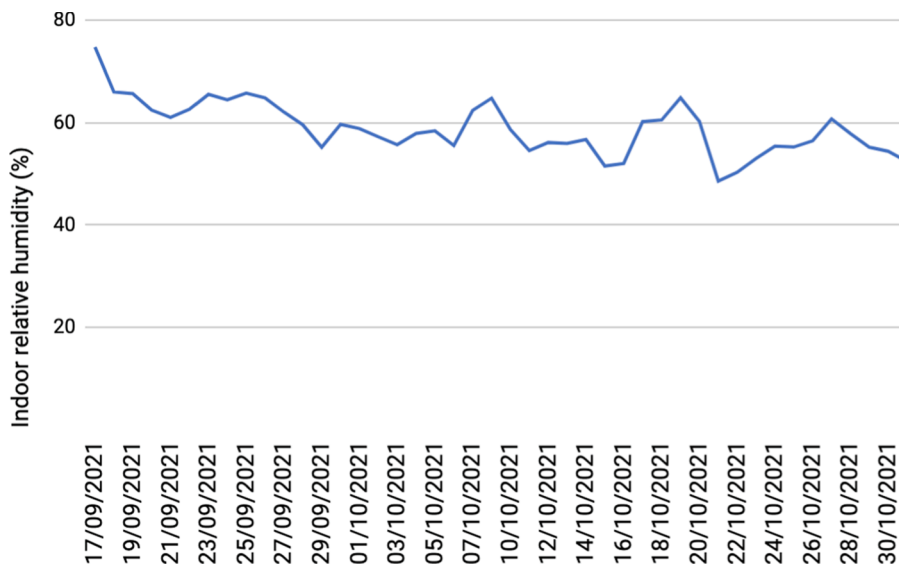


Fig. 5.3. IT server room indoor air relative humidity during the testing period.

$$COP = \frac{Q_c}{P} \tag{2}$$

Q_c -cooling capacity, kW;

P -power consumption of the dew point cooling system (it is the total power input of fan and water pump), kW;

Fig. 5.7 shows the daily average COP and cooling capacity of the dew point cooling system during the testing period. It is seen that the daily average COP varies from 25 to 34.4 with an average value of 29.7 during the testing period, and the average cooling capacity is 53.5 kW during the testing period. Due to the feature of the server’s random operation as well as the weather effect, the daily output data is dynamic. The curve shown in Fig. 5.7 is daily average data, which does not show some peak COP of up to 48 appeared in some times at the days on late October.

During the monitoring stage, it was found that the existing traditional vapor compression system, as a standby, has some amount of power consumption, which is because the existing traditional air conditioning system share the average of 17 % of the total IT room cooling. The cause of the share is the end user, new to the dew point cooling technology, set the target temperature of the existing air conditioning

system at a relatively low level intending to ensure uninterrupted cooling to provide to the IT room, which led to the standby existing air conditioning system operating intermittently. However, the dew point cooling system showed its continuous stable and reliable operating during the testing and monitoring period. Therefore, the cooling share from the existing air conditioning system can be reduced or removed with the end user’s engagement when they get familiar with new cooling facility.

As above mentioned, the average cooling capacity of the dew point cooling system is 53.5 kW, plus 17 % of cooling share from the existing vapor compression air conditioning system, the total average cooling capacity in the IT server room is 64.5 kW.

5.2.3. Energy saving

The testing and monitoring prove the dew point cooling system is highly efficient with the peak COP reaching 48 and the average power consumption of 1.8 kW for providing 53.5 kW cooling. Fig. 5.8 shows the average power consumption of 0.18 kW from a single 10 kW dew point cooler unit throughout a day. For each dew point cooler unit, the

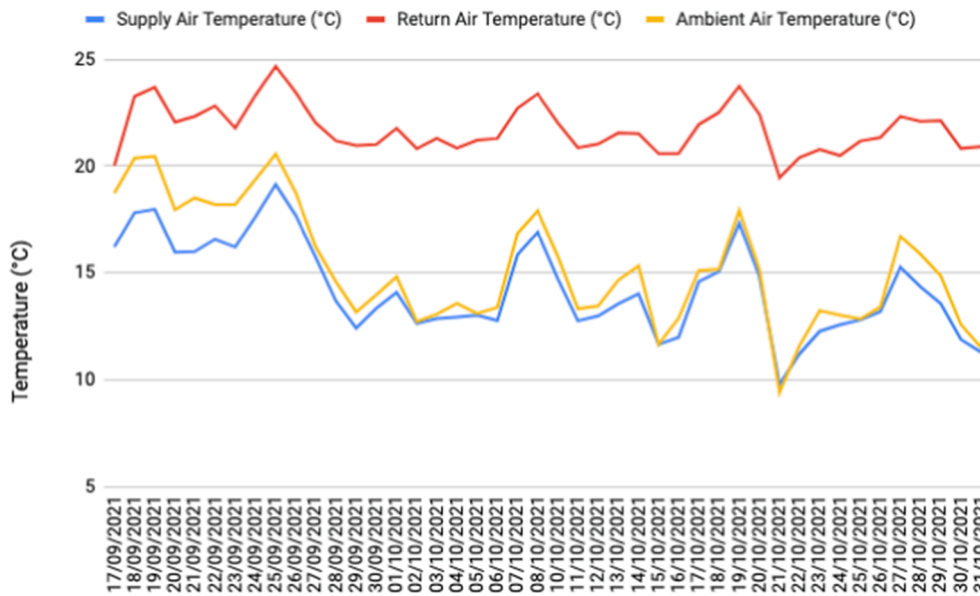


Fig. 5.4. Supply, return, and ambient air temperature of the dew point cooling system during the testing period.

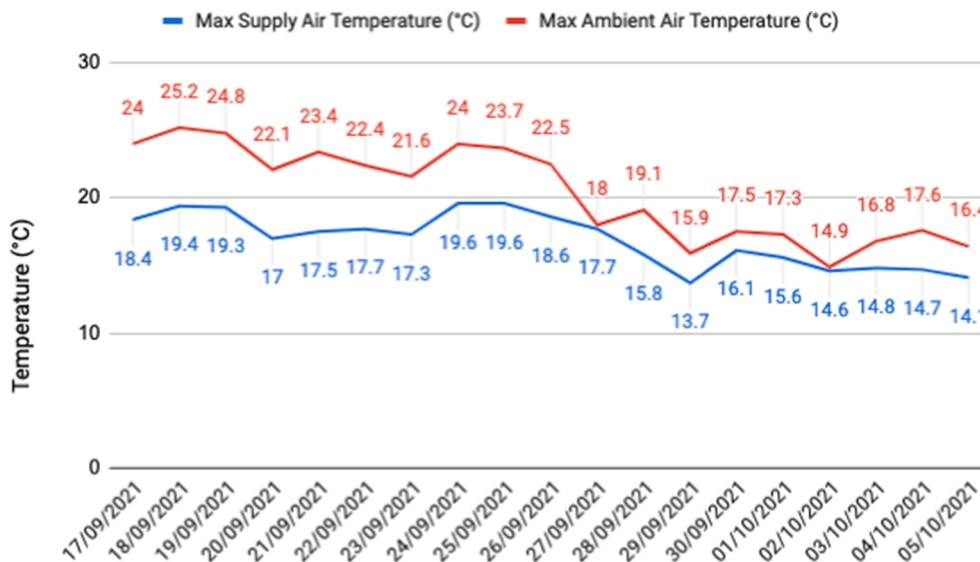


Fig. 5.5. The maximum supply and ambient air temperature in warm days from 17/09/2021 to 05/10/2021.

fan runs constantly while the water pump operates intermittently. With the pump on, the dew point cooler power consumption rises from 0.17 kW to 0.26 kW, represented by the discontinuous peaks in Fig. 5.8.

Assuming the dew point cooling system providing 100 % of the required cooling for the IT room, i.e., average 64.5 kW, and known its average COP of 29.7, its power consumption will be average 2.2 kW, which is calculated by the relation shown in equation (2).

To investigate the energy saving of the dew point cooling system operating in data centre, the work was carried out to monitor the power consumption of the existing traditional vapor compression air conditioning system on 15/09/2021 and 16/09/2021, i.e., continuous two days monitoring before the dew point cooling system testing started, while only the existing air conditioning system is in operation. It was found that the existing traditional air conditioning system consumes average 13.5 kW for the chiller and average 22 kW for the indoor air handling units, total 35.5 kW of power consumption. By comparing the power consumption of dew point cooling system with that of the existing traditional air conditioning system, it was found that around 90 % of

energy saving can be achieved by using this super performance dew point cooling system for data centre cooling.

6. Practical application and market-a discussion

The real life test of the super performance dew point cooler has been conducted in Maritime Data Centre at Hull, UK. In wide applications, the performance of dew point cooler will be affected by outdoor relative humidity. The high relative humidity can lead to reduced COP, e.g., in a very high relative humidity climate such as RH 71 % in Beijing in summer, the COP can be reduced to 9.7. The higher temperature leading to lower relative humidity is helpful for dew point cooling system operation. To ensure highly efficient and stable operation in data centre, we recommend to use 80 % of indoor return air and 20 % of outdoor fresh air as the intake air, our real life testing in Maritime data centre has verified this very effective method.

The super performance dew point cooling system can be designed and manufactured as modular systems to meet any scales of

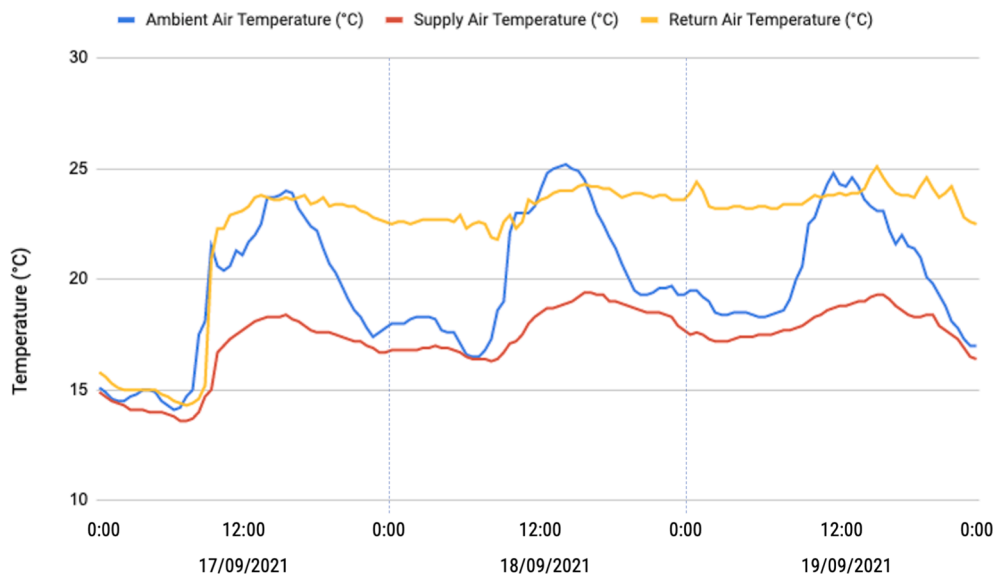


Fig. 5.6. Supply, return, and ambient air temperature of the DPC system from 17/09/2021 to 19/09/2021.

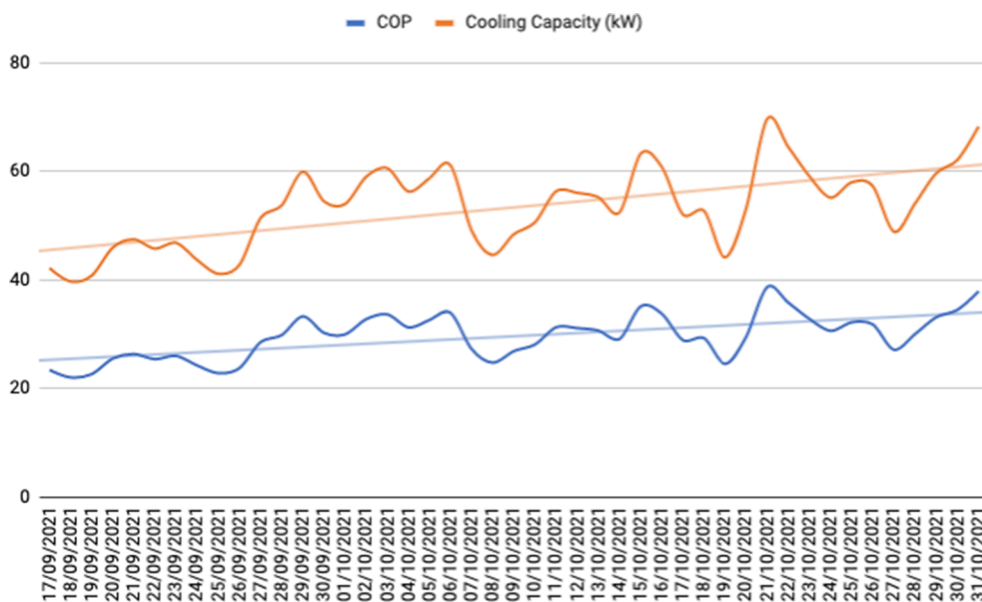


Fig. 5.7. Average daily COP and cooling capacity during the monitoring period.

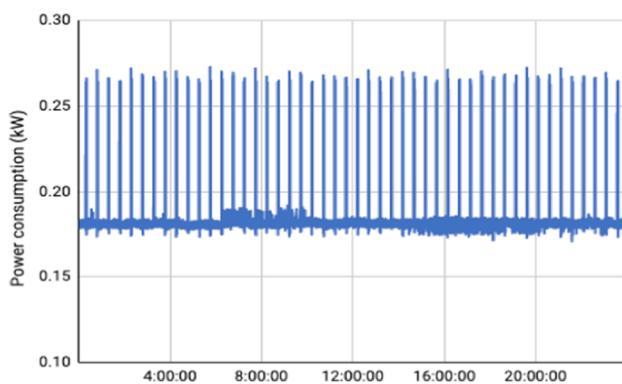


Fig. 5.8. Power consumption of a single 10 kW unit in a day.

applications, and to maximise the feasibility of installation as these modular units can be installed separately in different available spaces. In this project, the 100 kW modular system was designed in engineering practical standard. The super performance dew point cooler can be operated standalone without complement with conventional HVAC system. Actually, we have already installed an 8 kW (2 × 4 kW) pre-commercial modular system in Aura Innovation Centre data centre at hull (UK) for long term standalone operation, led to 90 % of energy saving in the data centre cooling.

The dew point cooling system has simple structure. Unlike the conventional vapor compression system with compressor, the only moving parts of the dew point cooling system are fan and water pump. Therefore, it requires less maintenance and can operate in higher reliability compared to the conventional vapor compression system. The specific maintenance for the dew point cooler is to kill the mould in wet channel when the system has stopped running for long time and restart the operation.

Information technology has brought significant changes in people's

lives. As an important part of the IT industry, the data centre market has been rapidly growing over the past 40 years. The scale of the global data centre market grew from £11.34 billion in 2009 to £34.54 billion in 2016. For data centre running, 30 %–40 % energy is currently used in operating the Data Centres' cooling systems. Within the next ten years around 5,000 new data centres will be developed in European countries, of which 1,000 will be in the UK. These will therefore secure an enormous data centre cooling market for the new super performance dew point cooling technology with extremely high energy efficiency. If the average cooling load for each new build data centre (typical mid power-density and mid-sized with 2,000 m² floor area) is 400 kW, the overall cooling capacity will be around 400 MW in the UK and 2,000 MW in Europe. This will therefore create £260 m and £1,300 m data centre cooling businesses respectively. Bringing together both the new and retrofitting Data Centres under planning, the overall market size of the data centre cooling sector in the next 10 years will reach £57 m/year and 285 m/year in the UK and EU respectively.

7. Conclusions

A specialist 100 kW rated super performance dew point cooling modular system was dedicated designed, constructed, installed and real life tested in an operational live data centre environment. During the testing and monitoring period, the dew point cooling system operated stably and reliably, and no equipment failure occurred. For the system operating, the intake air containing 80 % of IT server room return air, which can reduce effect of the climate on the system's performance and ensure relatively stable supply air temperature and the desired indoor humidity. The total average cooling requirement of the IT server room is 64.5 kW during the testing and monitoring period, wherein, the dew point cooling system provided 53.5 kW and the existing traditional vapor compression air conditioner system as a standby shared 17 % of the total cooling (i.e., 11 kW) because the end user, new to the dew point cooling technology, set the target temperature of the existing air conditioning system at a lower level to ensure uninterrupted cooling to provide to the IT server room, which causes the standby to operate intermittently. During the testing period, the average COP of the dew point cooling system operation is 29.7 with the maximum COP of 48.3. Compared to the existing vapor compression air conditioning system, the super performance dew point cooling system can save around 90 % of electrical energy for data centre cooling. The real life testing and monitoring has also verified the feasibility of the modular system operation, the applied dew point cooling system installation and system running methods. In the future operation, the standby can be removed and the super performance dew point cooling system alone can provide highly efficient and reliable cooling energy for the data centres.

CRedit authorship contribution statement

Xiaoli Ma: Conceptualization, Project administration, Funding acquisition. **Cheng Zeng:** Investigation, Formal analysis, Validation. **Zishang Zhu:** . **Xudong Zhao:** Conceptualization, Supervision. **Xin Xiao:** Investigation. **Yousef Golizadeh Akhlaghi:** Software. **Samson Shittu:** Investigation.

Declaration of Competing Interest

The authors declare that they have no known competing financial interests or personal relationships that could have appeared to influence the work reported in this paper.

Data availability

Data will be made available on request.

Acknowledgements

The authors would acknowledge our sincere appreciation to the financial supports from UK BEIS Industrial Energy Efficiency Accelerator (IEEA) 2021 project (project ID: 1635594).

References

- [1] Zakarya M. Energy, performance and cost efficient datacenters: a survey. *Renew Sustain Energy Rev* 2018;94:363–85.
- [2] Hu M, Luo L, Badiei A, Chen F, Zheng S, Wang Z, et al. Performance investigation of a micro-channel flat separated loop heat pipe system for data centre cooling. *Int J Low-Carbon Technol* 2021;16(1):98–113.
- [3] Zhan B, Shao S, Zhang H, Tian C. Simulation on vertical microchannel evaporator for rack-backdoor cooling of data center. *Appl Therm Eng* 2020;164:114550.
- [4] Zhang H, Shao S, Xu H, Zou H, Tian C. Free cooling of data centers: a review. *Renew Sustain Energy Rev* 2014;35:171–82.
- [5] Shehabi A, Masanet E, Price H, Horvath A, Nazaroff W. Data center design and location: consequences for electricity use and greenhouse-gas emissions. *Build Environ* 2011;46:990–8.
- [6] Duan Z, Zhao X, Liu J, Zhang Q. Dynamic simulation of a hybrid dew point evaporative cooler and vapour compression refrigerated system for a building using EnergyPlus. *J Build Eng* 2019;21:287–301.
- [7] Bataineh K, Taamneh Y. Review and recent improvements of solar sorption cooling systems. *Energy Build* 2016;128:22–37.
- [8] Ma X, Zhang W, Li F, Riffat SB. Solar ejector cooling technologies. *Green Energy Technol* 2019. https://doi.org/10.1007/978-3-030-17283-1_8.
- [9] Yang Y, Cui G, Lan CQ. Developments in evaporative cooling and enhanced evaporative cooling – a review. *Renew Sustain Energy Rev* 2019;113:109230.
- [10] Yapici R, Akkurt F. Experimental investigation on ejector cooling system performance at low generator temperature and a preliminary study on solar energy. *J Mech Sci Technol* 2012;26:3653–9.
- [11] N'tsoukpoe KE, Le Pierrès N, Luo L. Experimentation of a LiBr-H₂O absorption process for long-term solar thermal storage: prototype design and first results. *Energy* 2013;53:179–98.
- [12] Chen Q, Pan N, Guo ZY. A new approach to analysis and optimization of evaporative cooling system I: theory. *Energy* 2010;35(6):2448–54.
- [13] Chen Q, Pan N, Guo ZY. A new approach to analysis and optimization of evaporative cooling system II: applications. *Energy* 2011;36(5):2890–8.
- [14] Goshayshi HR, Missenden JF, Tozer R. Cooling tower—an energy conservation resource. *Appl Therm Eng* 1999;19(11):1223–35.
- [15] Chua KJ, Chou SK, Yang WM, Yan J. Achieving better energy-efficient air conditioning – a review of technologies and strategies. *Appl Energy* 2013;104:87–104.
- [16] Dean J, Herrmann L, Kozubal E, Geiger J. Dew point evaporative comfort cooling. Energy and water projects demonstration plan SI-0821, TP-7A40- 56256-1. November 2012.
- [17] Kiran TR, Rajput SPS. Energy saving potential of a novel dew point evaporative air conditioning system for Indian buildings. *Arch Appl Sci Res* 2010;2(1):376–82.
- [18] Bruno F. On site test of a novel dew point evaporative cooling. *Energy Build* 2011; 43(12):3475–83.
- [19] Lin J, Thu K, Bui TD, Wang RZ, Ng KC, Chua KJ. Study on dew point evaporative cooling system with counter-flow configuration. *Energy Convers Manage* 2016;109: 153–65.
- [20] Pandelidis D, Anisimov S. Numerical study and optimization of the cross-flow Maisotsenko cycle indirect evaporative air cooler. *Int J Heat Mass Transf* 2016;103: 1029–41.
- [21] Kabeel AE, Abdelgaied M. Numerical and experimental investigation of a novel configuration of indirect evaporative cooler with internal baffles. *Energy Convers Manage* 2016;126(15):526–36.
- [22] Sohani A, Sayyaadi H, Hoseinpoori S. Modeling and multi-objective optimization of an M-cycle cross-flow indirect evaporative cooler using the GMDH type neural network. *Int J Refrig* 2016;69:186–204.
- [23] Moshari S, Heidarinejad G. Numerical study of regenerative evaporative coolers for sub-wet bulb cooling with cross- and counter-flow configuration. *Appl Therm Eng* 2015;89(5):669–83.
- [24] Jradi M, Riffat SB. Experimental and numerical investigation of a dew-point cooling system for thermal comfort in buildings. *Appl Energy* 2014;132(1):524–35.
- [25] Xu P, Ma X, Zhao X, Fancey K. Experimental investigation of a super performance dew point air cooler. *Appl Energy* 2017;203:761–77.
- [26] Xu P, Ma X, Diallo TMO, Zhao X, Fancey K, Li D, et al. Numerical investigation of the energy performance of a guideless irregular heat and mass exchanger with corrugated heat transfer surface for dew point cooling. *Energy* 2016;109:803–17.
- [27] Xu P, Ma X, Zhao X, Fancey KS. Experimental investigation on performance of fabrics for indirect evaporative cooling applications. *Build Environ* 2016;110: 104–14.
- [28] Akhlahhi Y, Ma X, Zhao X, Shittu S, Li J. A statistical model for dew point air cooler based on the multiple polynomial regression approach. *Energy* 2019;181:868–81.
- [29] Data Centre Map, Colocation Data Centres, 2022, Available at: <https://www.datacentermap.com/datacenters.html> (Accessed:15 Feb2023).
- [30] ASHRAE T.C.9.9. Thermal guidelines for data processing environments –expanded data center. Data processing; 2011. pp. 1–45.