



Kent Academic Repository

Ahmed, Nauman, Baber, Muhammad Z., Iqbal, Muhammad Sajid, Annum, Amina, Ali, Syed Mansoor, Ali, Mubasher, Akgül, Ali and El Din, Sayed M. (2023) *Analytical study of reaction diffusion Lengyel-Epstein system by generalized Riccati equation mapping method*. *Scientific Reports*, 13 (1). ISSN 2045-2322.

Downloaded from

<https://kar.kent.ac.uk/103939/> The University of Kent's Academic Repository KAR

The version of record is available from

<https://doi.org/10.1038/s41598-023-47207-4>

This document version

Publisher pdf

DOI for this version

Licence for this version

CC BY (Attribution)

Additional information

Versions of research works

Versions of Record

If this version is the version of record, it is the same as the published version available on the publisher's web site. Cite as the published version.

Author Accepted Manuscripts

If this document is identified as the Author Accepted Manuscript it is the version after peer review but before type setting, copy editing or publisher branding. Cite as Surname, Initial. (Year) 'Title of article'. To be published in **Title of Journal**, Volume and issue numbers [peer-reviewed accepted version]. Available at: DOI or URL (Accessed: date).

Enquiries

If you have questions about this document contact ResearchSupport@kent.ac.uk. Please include the URL of the record in KAR. If you believe that your, or a third party's rights have been compromised through this document please see our [Take Down policy](https://www.kent.ac.uk/guides/kar-the-kent-academic-repository#policies) (available from <https://www.kent.ac.uk/guides/kar-the-kent-academic-repository#policies>).



OPEN

Analytical study of reaction diffusion Lengyel-Epstein system by generalized Riccati equation mapping method

Nauman Ahmed^{1,2,3}, Muhammad Z. Baber¹, Muhammad Sajid Iqbal^{4,5}, Amina Annum¹, Syed Mansoor Ali⁶, Mubasher Ali⁷, Ali Akgül^{2,3,8}✉ & Sayed M. El Din⁹

In this study, the Lengyel-Epstein system is under investigation analytically. This is the reaction–diffusion system leading to the concentration of the inhibitor chlorite and the activator iodide, respectively. These concentrations of the inhibitor chlorite and the activator iodide are shown in the form of wave solutions. This is a reaction–diffusion model which considered for the first time analytically to explore the different abundant families of solitary wave structures. These exact solitary wave solutions are obtained by applying the generalized Riccati equation mapping method. The single and combined wave solutions are observed in shock, complex solitary-shock, shock singular, and periodic-singular forms. The rational solutions also emerged during the derivation. In the Lengyel-Epstein system, solitary waves can propagate at various rates. The harmony of the system’s diffusive and reactive effects frequently governs the speed of a single wave. Solitary waves can move at a variety of speeds depending on the factors and reaction kinetics. To show their physical behavior, the 3D and their corresponding contour plots are drawn for the different values of constants.

Partial differential equations (PDEs) are widely used in sciences like mathematical physics, plasma physics, optics, quantum, mechanics, numerical analysis, and many engineering fields. The nonlinear PDEs describe the physical phenomena more accurately. Recently, it has become more important to determine the exact solutions, numerical and analytical solutions of non-linear PDEs with the help of using mathematical tools such as Maple, Mathematica, and MATLAB that ease solving complex and monotonous algebraic computations. Many mathematicians have developed methods to identify the exact solutions of nonlinear PDEs, including the Jacobi elliptic function method¹, the generalized Riccati equation mapping method², Rational Homotopy perturbation method³, and ϕ^6 -model expansion method^{4,5}, the homogeneous balance method⁶, the tanh method⁷, the inverse scattering transform⁸, the exponential-function expansion method⁹, the Backlund transform¹⁰, the modified extended Fan subequation method¹¹, the truncated Painleve expansion¹², and the auxiliary equation method¹³. Ghanbari, B., et al., used the generalized exponential rational function method^{14–22}, for the different nonlinear PDEs to investigate the different type of trigonometric, hyperbolic, exponential and rational solitary waves or soliton solutions. But in this study, the Generalized Riccati Equation Mapping (GREM) method is used. The GREM method is a powerful analytical technique for solving a wide range of differential equations, particularly nonlinear ones. It has several advantages, but it also comes with some limitations and potential disadvantages. The GREM method is a valuable analytical tool for solving a broad class of nonlinear differential equations. Its advantages include generality, nonlinearity handling, and the potential to reduce problems to simpler forms. However, its complexity, problem-specific nature, and computational demands can be disadvantages in certain

¹Department of Mathematics and Statistics, The University of Lahore, Lahore, Pakistan. ²Department of Computer Science and Mathematics, Lebanese American University, Beirut, Lebanon. ³Mathematics Research Center, Department of Mathematics, Near East University, Near East Boulevard, PC: 99138 Nicosia/Mersin 10, Turkey. ⁴Department of Humanities and Basic Science, MCS, National University of Science and Technology, Islamabad, Pakistan. ⁵Department of Academic Affairs, School of Leadership and Business, Oryx Universal College With Liverpool John Moores University (UK), Doha 12253, Qatar. ⁶Department of Physics and Astronomy, College of Science, King Saud University, P.O. BOX 2455, 11451 Riyadh, Saudi Arabia. ⁷School of Engineering and Digital Arts, University of Kent, Canterbury Kent, UK. ⁸Art and Science Faculty, Department of Mathematics, Siirt University, TR-56100 Siirt, Turkey. ⁹Center of Research, Faculty of Engineering, Future University in Egypt, New Catiro 11835, Egypt. ✉email: aliakgul00727@gmail.com

situations. Researchers should consider their familiarity with GREM, the problem's characteristics, and the desired level of analytical rigor when deciding whether to use this method. The list of actual applications of non-linear PDEs of extreme relevance and practical importance is long. One example that is plain sight is dynamic meteorology and numerical weather forecasting: the weather report you see every night on TV has been obtained from the numerical solution of a complex set of non-linear PDEs. Mathematical modeling is an essential part of simulation and design of control systems. Its main purpose is to be a simplified representation of real life, to mimic the applicable properties of the system being analyzed.

Reaction–diffusion systems are important in a wide range of disciplines. They arise naturally in chemistry and chemical engineering where they are used to represent the local mixing of different chemicals as well as the movement of substances through diffusion. However, they also have applications in the investigation of a variety of phenomena in the biological, ecological, environmental, life, and image processing sciences. There are many other types of reaction–diffusion systems in the literature, but Lengyel and Epstein's model of the chlorite-iodide malonic acid (CIMA) reaction–diffusion has garnered a lot of interest lately. The revolutionary work by Turing in 1952²³, which predicted the existence of stationary symmetry-breaking reaction–diffusion structures, also known as Turing patterns, is the foundation for the Lengyel–Epstein model. De Kepper's work in 1990, however, is the first realization of Turing's revolutionary work ever²⁴. One of the most important studies on the Lengyel–Epstein system was done by Ni and Tang²⁵, who demonstrated mathematically and experimentally that the system does not admit non-constant steady states if the initial reactant concentrations, reactor size, or effective diffusion rate are not large enough. Mahdy, A. M. investigated the existence and uniqueness of the glioblastoma multiforme (GBM) and IS interaction models²⁶, Khader, M. M., et. al., considered the fractional PDEs for the numerical investigation²⁷. The approximate analytical solutions for the time-fractional Fokker–Planck equation (TFPE) are obtained²⁸ by Mahdy, A. M. Also financial models are investigated using the Caputo's Fabrizio derivative²⁹. Gepreel, K. A., used the algebraic computational methods for the space–time fractional symmetric regularized long wave (SRLW equation), and the space–time fractional coupled Sakharov's Kuznetsov (S–K) equations³⁰ and fractional nonlinear Rubella ailment disease model are investigated by the numerical technique^{31,32}. In this study, they obtained the precise criteria on the system parameters to guarantee that the spatial homogeneous equilibrium and the spatial homogeneous periodic solutions are Turing-unstable or diffusively unstable. Through the use of a particular Lyapunov functional, Yi et al. demonstrated in 2009 that the constant equilibrium solution is globally asymptotically stable³³. The Lengyel–Epstein system's dynamics are examined in Lisená's 2014 study, which also lowers the standards for the steady-state solution's global asymptotic stability³⁴. In 2013, Wang et al. employed numerical illustrations to illustrate the bifurcation and the Hopf bifurcation theorem to pinpoint the prerequisites for the stability of the equilibrium point. Diffusion-driven instability and bifurcation in the Lengyel–Epstein system are given by Yi et al. in 2008³⁵. Computer simulations of three-dimensional Turing patterns in the Lengyel–Epstein model are given by Shoji and Ohta in 2015³⁶. Synchronization results for a class of fractional-order spatiotemporal partial differential systems based on the fractional Lyapunov approach are given by Quannas et al. in 2019³⁷. Hopf bifurcations in Lengyel–Epstein reaction–diffusion model with discrete time delay is given by Merdan in 2015³⁸. Bifurcations and pattern formation in a generalized Lengyel–Epstein reaction–diffusion model is given by Mansouri et al. in 2020³⁹.

The novelty of this work is that the Lengyel–Epstein reaction–diffusion model is considered analytically for the very first time. The generalized Riccati equation mapping technique is applied and gains the different types of wave structures analytically. In the Lengyel–Epstein system, solitary waves can propagate at various rates. The harmony of the system's diffusive and reactive effects frequently governs the speed of a single wave. Solitary waves can move at a variety of speeds depending on the factors and reaction kinetics. Another important aspect of a single wave is its breadth and amplitude. These are reliant on the reaction kinetics, activator and inhibitor concentrations, and diffusion coefficients. Solitary waves might be more dispersed and have a lower amplitude, or they can be quite localized and have a reasonably high amplitude. Solitary waves are capable of intricate interactions with one another. They can either reject one another or combine to generate larger solo waves, passing past each other unchanged. The specifics of the Lengyel–Epstein model determine the nature of the interaction. A disturbance in the system can lead to the appearance of these solitary waves. They can develop spontaneously or as a result of outside influences, and they frequently do so in areas where the activator concentration has momentarily increased. In this study, we find some new analytical wave structures by using the generalized Riccati equation mapping method.

The generalized Riccati equation mapping method

The generalized Riccati equation mapping method is define in the following steps^{40–43}.

Step I

Given nonlinear partial differential equation (NPDE) having independent variables $x = (t, x, y, z)$ and dependent variable w

$$P(w, w_t, w_x, w_y, w_z, w_{xx}, w_{zz}, w_{xy}, w_{tt} \dots) = 0, \quad (1)$$

where P is generally a polynomial function of its argument, and the subscripts of dependent variable denotes the partial derivatives.

Step II

By using the wave transformation, Eq. (1) have the following ansatz

$$w = W(\eta), \text{ where } \eta = x + y - \omega t, \quad (2)$$

where η is a real function to be determined. Substituting Eqs. (2) into (1) then we get an ordinary differential equation (ODE) as

$$Q(W, W_\eta, W_{\eta\eta}, \dots) = 0. \quad (3)$$

Step III

Suppose that the solution of Eq. (3) is in the polynomial form

$$W(\eta) = \sum_{j=0}^n a_j \phi(\eta)^j, \quad (4)$$

where a_j are constants that are determine later and n is positive integer that is obtained by the help of balancing principle. The $\phi(\eta)$ represents the solution of the given generalized riccati equation.

$$\phi'(\eta) = \tau + \rho\phi(\eta) + \chi\phi^2(\eta), \quad (5)$$

where τ , ρ and χ are all real constants. Substituting the Eqs. (4) with (5) into the regarding ODE and remove all the coefficients of ϕ will obtain a system of algebraic equations, from which we can get the parameters a_j , $(j = 1, \dots, n)$ and η . Solving the algebraic equations, with the known solutions of Eq. (4), one can be easily obtain the non-travelling wave solutions to the NPDE Eq. (1). We can obtain the following twenty seven solutions to Eq. (3) such as

Type 1: For $\rho^2 - 4\tau\chi > 0$ and $\rho\tau \neq 0$ (or $\rho\chi \neq 0$) the solutions of Eq. (5) are,

$$\phi_1 = -\frac{1}{2\chi} \left[\rho + \sqrt{\rho^2 - 4\tau\chi} \tanh\left(\frac{\sqrt{\rho^2 - 4\tau\chi}}{2}\eta\right) \right], \quad (6)$$

$$\phi_2 = -\frac{1}{2\chi} \left[\rho + \sqrt{\rho^2 - 4\tau\chi} \coth\left(\frac{\sqrt{\rho^2 - 4\tau\chi}}{2}\eta\right) \right], \quad (7)$$

$$\phi_3 = -\frac{1}{2\chi} [\rho + \sqrt{\rho^2 - 4\tau\chi} (\tanh(\sqrt{\rho^2 - 4\tau\chi}\eta) \pm \operatorname{sech}(\sqrt{\rho^2 - 4\tau\chi}\eta))], \quad (8)$$

$$\phi_4 = -\frac{1}{2\chi} [\rho + \sqrt{\rho^2 - 4\tau\chi} (\coth(\sqrt{\rho^2 - 4\tau\chi}\eta) \pm \operatorname{csch}(\sqrt{\rho^2 - 4\tau\chi}\eta))], \quad (9)$$

$$\phi_5 = -\frac{1}{4\chi} [2\rho + \sqrt{\rho^2 - 4\tau\chi} \left(\tanh\left(\frac{\sqrt{\rho^2 - 4\tau\chi}}{4}\eta\right) \pm \coth\left(\frac{\sqrt{\rho^2 - 4\tau\chi}}{4}\eta\right) \right)], \quad (10)$$

$$\phi_6 = \frac{1}{2\chi} \left[-\rho + \frac{\sqrt{(A^2 + B^2)(\rho^2 - 4\tau\chi)} - A\sqrt{\rho^2 - 4\tau\chi} \cosh(\sqrt{\rho^2 - 4\tau\chi}\eta)}{A \sinh(\sqrt{\rho^2 - 4\tau\chi}\eta) + B} \right], \quad (11)$$

$$\phi_7 = \frac{1}{2\chi} \left[-\rho - \frac{\sqrt{(A^2 + B^2)(\rho^2 - 4\tau\chi)} + A\sqrt{\rho^2 - 4\tau\chi} \cosh(\sqrt{\rho^2 - 4\tau\chi}\eta)}{A \sinh(\sqrt{\rho^2 - 4\tau\chi}\eta) + B} \right], \quad (12)$$

where A and B are two non zero real constants and satisfies $B^2 - A^2 > 0$.

$$\phi_8 = \frac{2\chi \cosh\left(\frac{\sqrt{\rho^2 - 4\tau\chi}}{2}\eta\right)}{\sqrt{\rho^2 - 4\tau\chi} \sinh\left(\frac{\sqrt{\rho^2 - 4\tau\chi}}{2}\eta\right) - \rho \cosh\left(\frac{\sqrt{\rho^2 - 4\tau\chi}}{2}\eta\right)}, \quad (13)$$

$$\phi_9 = \frac{-2\chi \sinh\left(\frac{\sqrt{\rho^2 - 4\tau\chi}}{2}\eta\right)}{\rho \sinh\left(\frac{\sqrt{\rho^2 - 4\tau\chi}}{2}\eta\right) - \sqrt{\rho^2 - 4\tau\chi} \cosh\left(\frac{\sqrt{\rho^2 - 4\tau\chi}}{2}\eta\right)}, \quad (14)$$

$$\phi_{10} = \frac{2\chi \cosh\left(\frac{\sqrt{\rho^2 - 4\tau\chi}\eta}{2}\right)}{\sqrt{\rho^2 - 4\tau\chi} \sinh(\sqrt{\rho^2 - 4\tau\chi}\eta) - \rho \cosh(\sqrt{\rho^2 - 4\tau\chi}\eta) \pm i\sqrt{\rho^2 - 4\tau\chi}}, \quad (15)$$

$$\phi_{11} = \frac{2\chi \sinh\left(\frac{\sqrt{\rho^2 - 4\tau\chi}\eta}{2}\right)}{-\rho \sinh(\sqrt{\rho^2 - 4\tau\chi}\eta) + \sqrt{\rho^2 - 4\tau\chi} \cosh(\sqrt{\rho^2 - 4\tau\chi}\eta) \pm \sqrt{\rho^2 - 4\tau\chi}}, \quad (16)$$

$$\phi_{12} = \frac{4\chi \sinh\left(\frac{\sqrt{\rho^2 - 4\tau\chi}\eta}{4}\right) \cosh\left(\frac{\sqrt{\rho^2 - 4\tau\chi}\eta}{4}\right)}{-2\rho \sinh\left(\frac{\sqrt{\rho^2 - 4\tau\chi}\eta}{4}\right) \cosh\left(\frac{\sqrt{\rho^2 - 4\tau\chi}\eta}{4}\right) + 2\sqrt{\rho^2 - 4\tau\chi} \cosh^2\left(\frac{\sqrt{\rho^2 - 4\tau\chi}\eta}{4}\right) - \sqrt{\rho^2 - 4\tau\chi}}. \quad (17)$$

Type 2: when $\rho^2 - 4\tau\chi < 0$ and $\rho\tau \neq 0$, (or $\tau\chi \neq 0$) the solutions of Eq. (5) are,

$$\phi_{13} = \frac{1}{2\chi} \left[-\rho + \sqrt{4\tau\chi - \rho^2} \tan\left(\frac{\sqrt{4\tau\chi - \rho^2}\eta}{2}\right) \right], \quad (18)$$

$$\phi_{14} = \frac{-1}{2\chi} \left[\rho + \sqrt{4\tau\chi - \rho^2} \cot\left(\frac{\sqrt{4\tau\chi - \rho^2}\eta}{2}\right) \right], \quad (19)$$

$$\phi_{15} = \frac{1}{2\chi} \left[-\rho + \sqrt{4\tau\chi - \rho^2} (\tan(\sqrt{4\tau\chi - \rho^2}\eta) \pm \sec(\sqrt{4\tau\chi - \rho^2}\eta)) \right], \quad (20)$$

$$\phi_{16} = \frac{-1}{2\chi} \left[\rho + \sqrt{4\tau\chi - \rho^2} (\cot(\sqrt{4\tau\chi - \rho^2}\eta) \pm \csc(\sqrt{4\tau\chi - \rho^2}\eta)) \right], \quad (21)$$

$$\phi_{17} = \frac{1}{4\chi} \left[-2\rho + \sqrt{4\tau\chi - \rho^2} \left(\tan\left(\frac{\sqrt{4\tau\chi - \rho^2}\eta}{4}\right) - \cot\left(\frac{\sqrt{4\tau\chi - \rho^2}\eta}{4}\right) \right) \right], \quad (22)$$

$$\phi_{18} = \frac{1}{2\chi} \left[-\rho + \frac{\pm\sqrt{(A^2 - B^2)(4\tau\chi - \rho^2)} - A\sqrt{4\tau\chi - \rho^2} \cos(\sqrt{4\tau\chi - \rho^2}\eta)}{A \sin(\sqrt{4\tau\chi - \rho^2}\eta) + B} \right], \quad (23)$$

$$\phi_{19} = \frac{1}{2\chi} \left[-\rho - \frac{\pm\sqrt{(A^2 - B^2)(4\tau\chi - \rho^2)} + A\sqrt{4\tau\chi - \rho^2} \cos(\sqrt{4\tau\chi - \rho^2}\eta)}{A \sin(\sqrt{4\tau\chi - \rho^2}\eta) + B} \right], \quad (24)$$

where A and B are two non zero real constants and satisfies $A^2 - B^2 > 0$.

$$\phi_{20} = -\frac{2\chi \cos\left(\frac{\sqrt{4\tau\chi - \rho^2}\eta}{2}\right)}{\sqrt{4\tau\chi - \rho^2} \sin\left(\frac{\sqrt{4\tau\chi - \rho^2}\eta}{2}\right) + \tau \cos\left(\frac{\sqrt{4\tau\chi - \rho^2}\eta}{2}\right)}, \quad (25)$$

$$\phi_{21} = \frac{2\chi \sin\left(\frac{\sqrt{4\tau\chi - \rho^2}\eta}{2}\right)}{-\tau \sin\left(\frac{\sqrt{4\tau\chi - \rho^2}\eta}{2}\right) + \sqrt{4\tau\chi - \rho^2} \cos\left(\frac{\sqrt{4\tau\chi - \rho^2}\eta}{2}\right)}, \quad (26)$$

$$\phi_{22} = -\frac{2\chi \cos\left(\frac{\sqrt{\rho^2 - 4\tau\chi}\eta}{2}\right)}{\sqrt{4\tau\chi - \rho^2} \sin(\sqrt{4\tau\chi - \rho^2}\eta) + \tau \cos(\sqrt{4\tau\chi - \rho^2}\eta) \pm i\sqrt{4\tau\chi - \rho^2}}, \quad (27)$$

$$\phi_{23} = \frac{2\chi \sin\left(\frac{\sqrt{4\tau\chi - \rho^2}\eta}{2}\right)}{-\rho \sin(\sqrt{4\tau\chi - \rho^2}\eta) + \sqrt{4\tau\chi - \rho^2} \cos(\sqrt{4\tau\chi - \rho^2}\eta) \pm \sqrt{4\tau\chi - \rho^2}}, \quad (28)$$

$$\phi_{24} = \frac{4\chi \sin\left(\frac{\sqrt{4\tau\chi - \rho^2}}{4}\eta\right) \cos\left(\frac{\sqrt{4\tau\chi - \rho^2}}{4}\eta\right)}{-2\rho \sin\left(\frac{\sqrt{4\tau\chi - \rho^2}}{4}\eta\right) \cos\left(\frac{\sqrt{4\tau\chi - \rho^2}}{4}\eta\right) + 2\sqrt{4\tau\chi - \rho^2} \cos^2\left(\frac{\sqrt{4\tau\chi - \rho^2}}{4}\eta\right) - \sqrt{4\tau\chi - \rho^2}}. \tag{29}$$

Type 3: when $\rho = 0$ and $\chi \tau \neq 0$, the solutions of Eq. (5) are,

$$\phi_{25} = \frac{-\rho b}{\tau[b + \cosh(\rho\eta) - \sinh(\rho\eta)]}, \tag{30}$$

$$\phi_{26} = -\frac{\rho[\cosh(\rho\eta) + \sinh(\rho\eta)]}{\tau[b + \cosh(\rho\eta) + \sinh(\rho\eta)]}, \tag{31}$$

where b is any arbitrary constant.

Type 4: When $\tau \neq 0$ and $\chi = \rho = 0$, the solutions of Eq. (5) are,

$$\phi_{27} = -\frac{1}{\tau\eta + c_1}, \tag{32}$$

where c_1 is an arbitrary constant.

Application to Lengyel-Epstein reaction diffusion system

In this section, we investigate the analytical solutions of the Lengyel-Epstein system by using the generalized Riccati equation mapping method. Here we illustrate this couple system to achieve the analytical solution of the Lengyel-Epstein system^{33,35,45,46}

$$u_t = \Delta(u) + a - u - \frac{4uv}{1 + u^2}, \tag{33}$$

$$v_t = \sigma[c\Delta(v) + b(u - \frac{uv}{1 + u^2})]. \tag{34}$$

where u and v are the concentration of the inhibitor chlorite and the activator iodide, respectively. a, b and c are the constants. By the wave transformation Eq. (2) we convert the Eqs. (33) and (34) onto the ODEs as follows

$$\omega U' - 2U' - a + U + \frac{4UV}{1 + U^2} = 0, \tag{35}$$

$$\omega V' - 2\sigma cV' - b(U - \frac{UV}{1 + U^2}) = 0. \tag{36}$$

Now, we suppose that the solution of Eqs. (35) and (36) as

$$U(\xi) = \sum_{i=0}^N \sigma_i \Omega^i(\xi), \tag{37}$$

$$V(\xi) = \sum_{i=0}^N \delta_i \Omega^i(\xi). \tag{38}$$

So, it satisfies the auxiliary ODE as

$$\Omega'(\xi) = \tau + \rho\Omega(\xi) + \chi\Omega(\xi)^2, \tag{39}$$

Now substituting the value of N by using the homogeneous balancing

$$U(\xi) = \sigma_0 + \sigma_1\Omega(\eta), \tag{40}$$

$$V(\xi) = \delta_0 + \delta_1\Omega(\eta) + \delta_2\Omega(\eta)^2. \tag{41}$$

By finding the derivatives of the Eqs. (40) and (41) along with Eq. (39) and putting in the Eqs. (35) and (36), and get the system of equations. After solving the system of equation we get the solutions as follows;

Case 1: Form the Eq. (35) we gain $\sigma_0 = -\frac{\delta_1}{\sqrt{4\delta_0\delta_2 - \delta_1^2}}, \sigma_1 = -\frac{2\delta_2}{\sqrt{4\delta_0\delta_2 - \delta_1^2}}, \omega = \frac{2\delta_2\rho^2 + \delta_1^2 - 4\delta_0\delta_2 - \delta_2}{\delta_2\rho},$

$$a = \frac{1}{\delta_2} \left(-\frac{2\delta_2\delta_1^2\tau}{\sqrt{4\delta_0\delta_2 - \delta_1^2}\rho} + \frac{8\delta_0\delta_2^2\tau}{\sqrt{4\delta_0\delta_2 - \delta_1^2}\rho} + \frac{2\delta_2^2\tau}{\sqrt{4\delta_0\delta_2 - \delta_1^2}\rho} + \frac{\delta_1^3}{\sqrt{4\delta_0\delta_2 - \delta_1^2}} - \frac{4\delta_0\delta_2\delta_1}{\sqrt{4\delta_0\delta_2 - \delta_1^2}} - \frac{\delta_2\delta_1}{\sqrt{4\delta_0\delta_2 - \delta_1^2}} \right). \text{For the Eq. (36)}$$

we gain $\delta_0 = \sigma_0^2 + 1, \delta_1 = 2\sigma_0\sigma_1, \delta_2 = \sigma_1^2, \rho = \frac{\sigma_1\tau}{\sigma_0}, \omega = \frac{4c\sigma_1\tau}{\sigma_0}.$

Type 1: When $\rho^2 - 4\tau\chi > 0$ and $\rho\chi \neq 0$ (or $\tau\chi \neq 0$), we obtained hyperbolic solutions. Substituting the values of constants in Eqs. (40) and (41) and by the help of general solution that are mentioned in methodology we obtained the different form of solutions.

By putting constant values along with Eq. (6) and wave transformation Eq. (2) in the Eqs. (40) and (41) we get the soliton solutions of Eqs. (33) and (34) such as

$$u_1(x, y, t) = -\frac{\delta_1}{\sqrt{4\delta_0\delta_2 - \delta_1^2}} + \frac{\delta_2 \left(\rho + \sqrt{\rho^2 - 4\tau\chi} \tanh \left(\frac{1}{2} \sqrt{\rho^2 - 4\tau\chi} \left(\frac{t(2\delta_2\rho^2 + \delta_1^2 - 4\delta_0\delta_2 - \delta_2)}{\delta_2\rho} + x + y \right) \right) \right)}{\sqrt{4\delta_0\delta_2 - \delta_1^2}\chi},$$

$$v_1(x, y, t) = \sigma_0^2 + 1 + \frac{\sigma_1^2}{4\chi^2} \left(\sqrt{\frac{\sigma_1^2\tau^2}{\sigma_0^2} - 4\tau\chi} \tanh \left(\frac{1}{2} \sqrt{\frac{\sigma_1^2\tau^2}{\sigma_0^2} - 4\tau\chi} \left(\frac{4c\sigma_1\tau}{\sigma_0} + x + y \right) \right) + \frac{\sigma_1\tau}{\sigma_0} \right)^2$$

$$- \frac{\sigma_1\sigma_0}{\chi} \left(\sqrt{\frac{\sigma_1^2\tau^2}{\sigma_0^2} - 4\tau\chi} \tanh \left(\frac{1}{2} \sqrt{\frac{\sigma_1^2\tau^2}{\sigma_0^2} - 4\tau\chi} \left(\frac{4c\sigma_1\tau}{\sigma_0} + x + y \right) \right) + \frac{\sigma_1\tau}{\sigma_0} \right).$$

By putting constant values along with Eq. (7) and wave transformation Eq. (2) in the Eqs. (40) and (41) we get the soliton solutions of Eqs. (33) and (34) such as

$$u_2(x, y, t) = -\frac{\delta_1}{\sqrt{4\delta_0\delta_2 - \delta_1^2}} + \frac{\delta_2 \left(\rho + \sqrt{\rho^2 - 4\tau\chi} \coth \left(\frac{1}{2} \sqrt{\rho^2 - 4\tau\chi} \left(\frac{t(2\delta_2\rho^2 + \delta_1^2 - 4\delta_0\delta_2 - \delta_2)}{\delta_2\rho} + x + y \right) \right) \right)}{\sqrt{4\delta_0\delta_2 - \delta_1^2}\chi},$$

$$v_2(x, y, t) = \sigma_0^2 + 1 + \frac{\sigma_1^2}{4\chi^2} \left(\sqrt{\frac{\sigma_1^2\tau^2}{\sigma_0^2} - 4\tau\chi} \coth \left(\frac{1}{2} \sqrt{\frac{\sigma_1^2\tau^2}{\sigma_0^2} - 4\tau\chi} \left(\frac{4c\sigma_1\tau}{\sigma_0} + x + y \right) \right) + \frac{\sigma_1\tau}{\sigma_0} \right)^2$$

$$- \frac{\sigma_1\sigma_0}{\chi} \left(\sqrt{\frac{\sigma_1^2\tau^2}{\sigma_0^2} - 4\tau\chi} \coth \left(\frac{1}{2} \sqrt{\frac{\sigma_1^2\tau^2}{\sigma_0^2} - 4\tau\chi} \left(\frac{4c\sigma_1\tau}{\sigma_0} + x + y \right) \right) + \frac{\sigma_1\tau}{\sigma_0} \right).$$

By putting constant values along with Eq. (8) and wave transformation Eq. (2) in the Eqs. (40) and (41) we get the soliton solutions of Eqs. (33) and (34) such as

$$u_3(x, y, t) = -\frac{\delta_1}{\sqrt{4\delta_0\delta_2 - \delta_1^2}} + \frac{\delta_2}{\sqrt{4\delta_0\delta_2 - \delta_1^2}\chi} \left(\rho + \sqrt{\rho^2 - 4\tau\chi} \left(\tanh \left(\sqrt{\rho^2 - 4\tau\chi} \right. \right. \right.$$

$$\left. \left. \times \left(\frac{t(2\delta_2\rho^2 + \delta_1^2 - 4\delta_0\delta_2 - \delta_2)}{\delta_2\rho} + x + y \right) \right) + \operatorname{isech} \left(\sqrt{\rho^2 - 4\tau\chi} \left(\frac{t(2\delta_2\rho^2 + \delta_1^2 - 4\delta_0\delta_2 - \delta_2)}{\delta_2\rho} + x + y \right) \right) \right),$$

$$v_3(x, y, t) = \sigma_0^2 + 1 + \frac{\sigma_1^2}{4\chi^2} \left(\frac{\sigma_1\tau}{\sigma_0} + \sqrt{\frac{\sigma_1^2\tau^2}{\sigma_0^2} - 4\tau\chi} \left(\tanh \left(\sqrt{\frac{\sigma_1^2\tau^2}{\sigma_0^2} - 4\tau\chi} \left(\frac{4c\sigma_1\tau}{\sigma_0} + x + y \right) \right) \right. \right.$$

$$\left. \left. + \operatorname{isech} \left(\sqrt{\frac{\sigma_1^2\tau^2}{\sigma_0^2} - 4\tau\chi} \left(\frac{4c\sigma_1\tau}{\sigma_0} + x + y \right) \right) \right) \right)^2 - \frac{\sigma_1\sigma_0}{\chi} \left(\frac{\sigma_1\tau}{\sigma_0} + \sqrt{\frac{\sigma_1^2\tau^2}{\sigma_0^2} - 4\tau\chi} \right.$$

$$\left. \left(\tanh \left(\sqrt{\frac{\sigma_1^2\tau^2}{\sigma_0^2} - 4\tau\chi} \left(\frac{4c\sigma_1\tau}{\sigma_0} + x + y \right) \right) + \operatorname{isech} \left(\sqrt{\frac{\sigma_1^2\tau^2}{\sigma_0^2} - 4\tau\chi} \left(\frac{4c\sigma_1\tau}{\sigma_0} + x + y \right) \right) \right) \right).$$

By putting constant values along with Eq. (9) and wave transformation Eq. (2) in the Eqs. (40) and (41) we get the soliton solutions of Eqs. (33) and (34) such as

$$u_4(x, y, t) = -\frac{\delta_1}{\sqrt{4\delta_0\delta_2 - \delta_1^2}} + \frac{\delta_2}{\sqrt{4\delta_0\delta_2 - \delta_1^2}\chi} \left(\rho + \sqrt{\rho^2 - 4\tau\chi} \left(\coth \left(\sqrt{\rho^2 - 4\tau\chi} \right. \right. \right.$$

$$\left(\frac{t(2\delta_2\rho^2 + \delta_1^2 - 4\delta_0\delta_2 - \delta_2)}{\delta_2\rho} + x + y \right) + \operatorname{csch} \left(\sqrt{\rho^2 - 4\tau\chi} \left(\frac{t(2\delta_2\rho^2 + \delta_1^2 - 4\delta_0\delta_2 - \delta_2)}{\delta_2\rho} + x + y \right) \right) \Bigg) \Bigg),$$

$$v_4(x, y, t) = \sigma_0^2 + 1 - \frac{\sigma_1\sigma_0}{\chi} \left(\sqrt{\frac{\sigma_1^2\tau^2}{\sigma_0^2} - 4\tau\chi} \left(\coth \left(\sqrt{\frac{\sigma_1^2\tau^2}{\sigma_0^2} - 4\tau\chi} \left(\frac{4c\sigma\sigma_1t\tau}{\sigma_0} + x + y \right) \right) \right) \right.$$

$$\left. + \operatorname{csch} \left(\sqrt{\frac{\sigma_1^2\tau^2}{\sigma_0^2} - 4\tau\chi} \left(\frac{4c\sigma\sigma_1t\tau}{\sigma_0} + x + y \right) \right) + \frac{\sigma_1\tau}{\sigma_0} \right) + \frac{\sigma_1^2}{4\chi^2} \left(\sqrt{\frac{\sigma_1^2\tau^2}{\sigma_0^2} - 4\tau\chi} \right.$$

$$\left. \left(\coth \left(\sqrt{\frac{\sigma_1^2\tau^2}{\sigma_0^2} - 4\tau\chi} \left(\frac{4c\sigma\sigma_1t\tau}{\sigma_0} + x + y \right) \right) + \operatorname{csch} \left(\sqrt{\frac{\sigma_1^2\tau^2}{\sigma_0^2} - 4\tau\chi} \left(\frac{4c\sigma\sigma_1t\tau}{\sigma_0} + x + y \right) \right) \right) + \frac{\sigma_1\tau}{\sigma_0} \right)^2.$$

By putting constant values along with Eq. (10) and wave transformation Eq. (2) in the Eqs. (40) and (41) we get the soliton solutions of Eqs. (33) and (34) such as

$$u_5(x, y, t) = -\frac{\delta_1}{\sqrt{4\delta_0\delta_2 - \delta_1^2}} + \frac{\delta_2}{2\sqrt{4\delta_0\delta_2 - \delta_1^2}\chi} \left(2\rho + \sqrt{\rho^2 - 4\tau\chi} \left(\tanh \left(\frac{1}{4}\sqrt{\rho^2 - 4\tau\chi} \right. \right. \right.$$

$$\left. \left. \left(\frac{t(2\delta_2\rho^2 + \delta_1^2 - 4\delta_0\delta_2 - \delta_2)}{\delta_2\rho} + x + y \right) \right) + \coth \left(\frac{1}{4}\sqrt{\rho^2 - 4\tau\chi} \left(\frac{t(2\delta_2\rho^2 + \delta_1^2 - 4\delta_0\delta_2 - \delta_2)}{\delta_2\rho} + x + y \right) \right) \right) \Bigg) \Bigg),$$

$$v_5(x, y, t) = \sigma_0^2 + 1 + \frac{2\sigma_1\tau}{\sigma_0} - \frac{\sigma_1\sigma_0}{2\chi} \left(\sqrt{\frac{\sigma_1^2\tau^2}{\sigma_0^2} - 4\tau\chi} \left(\tanh \left(\frac{1}{4}\sqrt{\frac{\sigma_1^2\tau^2}{\sigma_0^2} - 4\tau\chi} \left(\frac{4c\sigma\sigma_1t\tau}{\sigma_0} + x + y \right) \right) \right) \right.$$

$$\left. + \coth \left(\frac{1}{4}\sqrt{\frac{\sigma_1^2\tau^2}{\sigma_0^2} - 4\tau\chi} \left(\frac{4c\sigma\sigma_1t\tau}{\sigma_0} + x + y \right) \right) + \frac{2\sigma_1\tau}{\sigma_0} \right) + \frac{\sigma_1^2}{16\chi^2} \left(\sqrt{\frac{\sigma_1^2\tau^2}{\sigma_0^2} - 4\tau\chi} \right.$$

$$\left. \left(\tanh \left(\frac{1}{4}\sqrt{\frac{\sigma_1^2\tau^2}{\sigma_0^2} - 4\tau\chi} \left(\frac{4c\sigma\sigma_1t\tau}{\sigma_0} + x + y \right) \right) + \coth \left(\frac{1}{4}\sqrt{\frac{\sigma_1^2\tau^2}{\sigma_0^2} - 4\tau\chi} \left(\frac{4c\sigma\sigma_1t\tau}{\sigma_0} + x + y \right) \right) \right) \right)^2.$$

By putting constant values along with Eq. (11) and wave transformation Eq. (2) in the Eqs. (40) and (41) we get the soliton solutions of Eqs. (33) and (34) such as

$$u_6(x, y, t) = -\frac{\delta_1}{\sqrt{4\delta_0\delta_2 - \delta_1^2}} - \frac{\delta_2}{\sqrt{4\delta_0\delta_2 - \delta_1^2}\chi}$$

$$\left(\frac{\sqrt{(G^2 + H^2)(\rho^2 - 4\tau\chi)} - G\sqrt{\rho^2 - 4\tau\chi} \cosh \left(\sqrt{\rho^2 - 4\tau\chi} \left(\frac{t(2\delta_2\rho^2 + \delta_1^2 - 4\delta_0\delta_2 - \delta_2)}{\delta_2\rho} + x + y \right) \right)}{\operatorname{Gsinh} \left(\sqrt{\rho^2 - 4\tau\chi} \left(\frac{t(2\delta_2\rho^2 + \delta_1^2 - 4\delta_0\delta_2 - \delta_2)}{\delta_2\rho} + x + y \right) \right) + H} - \rho \right),$$

$$v_6(x, y, t) = \sigma_0^2 + 1 + \frac{\sigma_1^2}{4\chi^2} \left(\frac{\sqrt{(G^2 + H^2) \left(\frac{\sigma_1^2\tau^2}{\sigma_0^2} - 4\tau\chi \right)} - G\sqrt{\frac{\sigma_1^2\tau^2}{\sigma_0^2} - 4\tau\chi} \cosh \left(\sqrt{\frac{\sigma_1^2\tau^2}{\sigma_0^2} - 4\tau\chi} \left(\frac{4c\sigma\sigma_1t\tau}{\sigma_0} + x + y \right) \right)}{\operatorname{Gsinh} \left(\sqrt{\frac{\sigma_1^2\tau^2}{\sigma_0^2} - 4\tau\chi} \left(\frac{4c\sigma\sigma_1t\tau}{\sigma_0} + x + y \right) \right) + H} \right.$$

$$\left. - \frac{\sigma_1\tau}{\sigma_0} \right)^2 + \frac{\sigma_1\sigma_0}{\chi} \left(\frac{\sqrt{(G^2 + H^2) \left(\frac{\sigma_1^2\tau^2}{\sigma_0^2} - 4\tau\chi \right)} - G\sqrt{\frac{\sigma_1^2\tau^2}{\sigma_0^2} - 4\tau\chi} \cosh \left(\sqrt{\frac{\sigma_1^2\tau^2}{\sigma_0^2} - 4\tau\chi} \left(\frac{4c\sigma\sigma_1t\tau}{\sigma_0} + x + y \right) \right)}{\operatorname{Gsinh} \left(\sqrt{\frac{\sigma_1^2\tau^2}{\sigma_0^2} - 4\tau\chi} \left(\frac{4c\sigma\sigma_1t\tau}{\sigma_0} + x + y \right) \right) + H} - \frac{\sigma_1\tau}{\sigma_0} \right).$$

By putting constant values along with Eq. (12) and wave transformation Eq. (2) in the Eqs. (40) and (41) we get the soliton solutions of Eqs. (33) and (34) such as

$$u_7(x, y, t) = -\frac{\delta_1}{\sqrt{4\delta_0\delta_2 - \delta_1^2}} - \frac{\delta_2}{\sqrt{4\delta_0\delta_2 - \delta_1^2}\chi}$$

$$\left(-\frac{\sqrt{(H^2 - G^2)(\rho^2 - 4\tau\chi)} + G\sqrt{\rho^2 - 4\tau\chi} \cosh\left(\sqrt{\rho^2 - 4\tau\chi}\left(\frac{t(2\delta_2\rho^2 + \delta_1^2 - 4\delta_0\delta_2 - \delta_2)}{\delta_2\rho} + x + y\right)\right)}{\text{Gsinh}\left(\sqrt{\rho^2 - 4\tau\chi}\left(\frac{t(2\delta_2\rho^2 + \delta_1^2 - 4\delta_0\delta_2 - \delta_2)}{\delta_2\rho} + x + y\right)\right) + H} - \rho \right),$$

$$v_7(x, y, t) = \frac{\sigma_1^2 \left(-\frac{G\sqrt{\frac{\sigma_1^2\tau^2}{\sigma_0^2} - 4\tau\chi} \cosh\left(\sqrt{\frac{\sigma_1^2\tau^2}{\sigma_0^2} - 4\tau\chi}\left(\frac{4c\sigma_1 t\tau}{\sigma_0} + x + y\right)\right) + \sqrt{(H^2 - G^2)\left(\frac{\sigma_1^2\tau^2}{\sigma_0^2} - 4\tau\chi\right)}}{\text{Gsinh}\left(\sqrt{\frac{\sigma_1^2\tau^2}{\sigma_0^2} - 4\tau\chi}\left(\frac{4c\sigma_1 t\tau}{\sigma_0} + x + y\right)\right) + H} - \frac{\sigma_1\tau}{\sigma_0} \right)^2}{4\chi^2}$$

$$+ \frac{\sigma_1\sigma_0 \left(-\frac{G\sqrt{\frac{\sigma_1^2\tau^2}{\sigma_0^2} - 4\tau\chi} \cosh\left(\sqrt{\frac{\sigma_1^2\tau^2}{\sigma_0^2} - 4\tau\chi}\left(\frac{4c\sigma_1 t\tau}{\sigma_0} + x + y\right)\right) + \sqrt{(H^2 - G^2)\left(\frac{\sigma_1^2\tau^2}{\sigma_0^2} - 4\tau\chi\right)}}{\text{Gsinh}\left(\sqrt{\frac{\sigma_1^2\tau^2}{\sigma_0^2} - 4\tau\chi}\left(\frac{4c\sigma_1 t\tau}{\sigma_0} + x + y\right)\right) + H} - \frac{\sigma_1\tau}{\sigma_0} \right)}{\chi} + \sigma_0^2 + 1.$$

By putting constant values along with Eq. (13) and wave transformation Eq. (2) in the Eqs. (40) and (41) we get the soliton solutions of Eqs. (33) and (34) such as

$$u_8(x, y, t) = -\frac{\delta_1}{\sqrt{4\delta_0\delta_2 - \delta_1^2}} - \frac{4\delta_2\chi \cosh\left(\frac{1}{2}\sqrt{\rho^2 - 4\tau\chi}\left(\frac{t(2\delta_2\rho^2 + \delta_1^2 - 4\delta_0\delta_2 - \delta_2)}{\delta_2\rho} + x + y\right)\right)}{\sqrt{4\delta_0\delta_2 - \delta_1^2}\left(\sqrt{\rho^2 - 4\tau\chi} \sinh(Z) - \rho \cosh(Z)\right)},$$

where $Z = \frac{1}{2}\sqrt{\rho^2 - 4\tau\chi}\left(\frac{t(2\delta_2\rho^2 + \delta_1^2 - 4\delta_0\delta_2 - \delta_2)}{\delta_2\rho} + x + y\right)$.

$$v_8(x, y, t) = \sigma_0^2 + 1 + \frac{4\sigma_1\sigma_0\chi \cosh\left(\frac{1}{2}\sqrt{\frac{\sigma_1^2\tau^2}{\sigma_0^2} - 4\tau\chi}\left(\frac{4c\sigma_1 t\tau}{\sigma_0} + x + y\right)\right)}{\sqrt{\frac{\sigma_1^2\tau^2}{\sigma_0^2} - 4\tau\chi} \sinh\left(\frac{1}{2}\sqrt{\frac{\sigma_1^2\tau^2}{\sigma_0^2} - 4\tau\chi}\left(\frac{4c\sigma_1 t\tau}{\sigma_0} + x + y\right)\right) - \frac{\sigma_1\tau}{\sigma_0} \cosh(Z)}$$

$$+ \frac{4\sigma_1^2\chi^2 \cosh^2\left(\frac{1}{2}\sqrt{\frac{\sigma_1^2\tau^2}{\sigma_0^2} - 4\tau\chi}\left(\frac{4c\sigma_1 t\tau}{\sigma_0} + x + y\right)\right)}{\left(\sqrt{\frac{\sigma_1^2\tau^2}{\sigma_0^2} - 4\tau\chi} \sinh\left(\frac{1}{2}\sqrt{\frac{\sigma_1^2\tau^2}{\sigma_0^2} - 4\tau\chi}\left(\frac{4c\sigma_1 t\tau}{\sigma_0} + x + y\right)\right) - \frac{\sigma_1\tau}{\sigma_0} \cosh(Z)\right)^2},$$

where $Z = \frac{1}{2}\sqrt{\frac{\sigma_1^2\tau^2}{\sigma_0^2} - 4\tau\chi}\left(\frac{4c\sigma_1 t\tau}{\sigma_0} + x + y\right)$. By putting constant values along with Eq. (14) and wave transformation Eq. (2) in the Eqs. (40) and (41) we get the soliton solutions of Eqs. (33) and (34) such as

$$u_9(x, y, t) = -\frac{\delta_1}{\sqrt{4\delta_0\delta_2 - \delta_1^2}} + \frac{4\delta_2\chi \sinh\left(\frac{1}{2}\sqrt{\rho^2 - 4\tau\chi}\left(\frac{t(2\delta_2\rho^2 + \delta_1^2 - 4\delta_0\delta_2 - \delta_2)}{\delta_2\rho} + x + y\right)\right)}{\sqrt{4\delta_0\delta_2 - \delta_1^2}\left(\rho \sinh(Z) - \sqrt{\rho^2 - 4\tau\chi} \cosh(Z)\right)},$$

where $Z = \frac{1}{2}\sqrt{\rho^2 - 4\tau\chi}\left(\frac{t(2\delta_2\rho^2 + \delta_1^2 - 4\delta_0\delta_2 - \delta_2)}{\delta_2\rho} + x + y\right)$.

$$v_9(x, y, t) = \sigma_0^2 + 1 - \frac{4\sigma_1\sigma_0\chi \sinh\left(\frac{1}{2}\sqrt{\frac{\sigma_1^2\tau^2}{\sigma_0^2} - 4\tau\chi}\left(\frac{4c\sigma_1 t\tau}{\sigma_0} + x + y\right)\right)}{\sigma_1\tau \sinh\left(\frac{1}{2}\sqrt{\frac{\sigma_1^2\tau^2}{\sigma_0^2} - 4\tau\chi}\left(\frac{4c\sigma_1 t\tau}{\sigma_0} + x + y\right)\right) - \sqrt{\frac{\sigma_1^2\tau^2}{\sigma_0^2} - 4\tau\chi} \cosh(Z)}$$

$$+ \frac{4\sigma_1^2 \chi^2 \sinh^2 \left(\frac{1}{2} \sqrt{\frac{\sigma_1^2 \tau^2}{\sigma_0^2} - 4\tau \chi \left(\frac{4c\sigma \sigma_1 t \tau}{\sigma_0} + x + y \right)} \right)}{\left(\frac{\sigma_1 \tau \sinh \left(\frac{1}{2} \sqrt{\frac{\sigma_1^2 \tau^2}{\sigma_0^2} - 4\tau \chi \left(\frac{4c\sigma \sigma_1 t \tau}{\sigma_0} + x + y \right)} \right)}{\sigma_0} - \sqrt{\frac{\sigma_1^2 \tau^2}{\sigma_0^2} - 4\tau \chi \cosh(Z)} \right)^2},$$

where $Z = \frac{1}{2} \sqrt{\frac{\sigma_1^2 \tau^2}{\sigma_0^2} - 4\tau \chi \left(\frac{4c\sigma \sigma_1 t \tau}{\sigma_0} + x + y \right)}$. By putting constant values along with Eq. (15) and wave transformation Eq. (2) in the Eqs. (40) and (41) we get the soliton solutions of Eqs. (33) and (34) such as

$$u_{10}(x, y, t) = -\frac{\delta_1}{\sqrt{4\delta_0 \delta_2 - \delta_1^2}} - \frac{4\delta_2 \chi \cosh \left(\sqrt{\rho^2 - 4\tau \chi \left(\frac{t(2\delta_2 \rho^2 + \delta_1^2 - 4\delta_0 \delta_2 - \delta_2)}{\delta_2 \rho} + x + y \right)} \right)}{\sqrt{4\delta_0 \delta_2 - \delta_1^2} \left(-i\sqrt{\rho^2 - 4\tau \chi} + \sqrt{\rho^2 - 4\tau \chi} \sinh(Z) - \rho \cosh(Z) \right)},$$

where $Z = \sqrt{\rho^2 - 4\tau \chi \left(\frac{t(2\delta_2 \rho^2 + \delta_1^2 - 4\delta_0 \delta_2 - \delta_2)}{\delta_2 \rho} + x + y \right)}$.

$$v_{10}(x, y, t) = \sigma_0^2 + 1 + \frac{4\sigma_1 \sigma_0 \chi \cosh \left(\sqrt{\frac{\sigma_1^2 \tau^2}{\sigma_0^2} - 4\tau \chi \left(\frac{4c\sigma \sigma_1 t \tau}{\sigma_0} + x + y \right)} \right)}{\sqrt{\frac{\sigma_1^2 \tau^2}{\sigma_0^2} - 4\tau \chi} \sinh \left(\sqrt{\frac{\sigma_1^2 \tau^2}{\sigma_0^2} - 4\tau \chi \left(\frac{4c\sigma \sigma_1 t \tau}{\sigma_0} + x + y \right)} \right) - \frac{\sigma_1 \tau \cosh(Z)}{\sigma_0} - i\sqrt{\frac{\sigma_1^2 \tau^2}{\sigma_0^2} - 4\tau \chi}} + \frac{4\sigma_1^2 \chi^2 \cosh^2 \left(\sqrt{\frac{\sigma_1^2 \tau^2}{\sigma_0^2} - 4\tau \chi \left(\frac{4c\sigma \sigma_1 t \tau}{\sigma_0} + x + y \right)} \right)}{\left(\sqrt{\frac{\sigma_1^2 \tau^2}{\sigma_0^2} - 4\tau \chi} \sinh(Z) - \frac{\sigma_1 \tau \cosh(Z)}{\sigma_0} - i\sqrt{\frac{\sigma_1^2 \tau^2}{\sigma_0^2} - 4\tau \chi} \right)^2},$$

where $Z = \sqrt{\frac{\sigma_1^2 \tau^2}{\sigma_0^2} - 4\tau \chi \left(\frac{4c\sigma \sigma_1 t \tau}{\sigma_0} + x + y \right)}$. By putting constant values along with Eq. (16) and wave transformation Eq. (2) in the Eqs. (40) and (41) we get the soliton solutions of Eqs. (33) and (34) such as

$$u_{11}(x, y, t) = -\frac{\delta_1}{\sqrt{4\delta_0 \delta_2 - \delta_1^2}} - \frac{4\delta_2 \chi \sinh \left(\sqrt{\rho^2 - 4\tau \chi \left(\frac{t(2\delta_2 \rho^2 + \delta_1^2 - 4\delta_0 \delta_2 - \delta_2)}{\delta_2 \rho} + x + y \right)} \right)}{\sqrt{4\delta_0 \delta_2 - \delta_1^2} \left(\sqrt{\rho^2 - 4\tau \chi} - \rho \sinh(Z) + \sqrt{\rho^2 - 4\tau \chi} \cosh(Z) \right)},$$

where $Z = \sqrt{\rho^2 - 4\tau \chi \left(\frac{t(2\delta_2 \rho^2 + \delta_1^2 - 4\delta_0 \delta_2 - \delta_2)}{\delta_2 \rho} + x + y \right)}$.

$$v_{11}(x, y, t) = \sigma_0^2 + 1 + \frac{4\sigma_1 \sigma_0 \chi \sinh \left(\sqrt{\frac{\sigma_1^2 \tau^2}{\sigma_0^2} - 4\tau \chi \left(\frac{4c\sigma \sigma_1 t \tau}{\sigma_0} + x + y \right)} \right)}{\sigma_1 \tau \sinh \left(\sqrt{\frac{\sigma_1^2 \tau^2}{\sigma_0^2} - 4\tau \chi \left(\frac{4c\sigma \sigma_1 t \tau}{\sigma_0} + x + y \right)} \right) - \frac{\sigma_1 \tau \sinh(Z)}{\sigma_0} + \sqrt{\frac{\sigma_1^2 \tau^2}{\sigma_0^2} - 4\tau \chi} \cosh(Z) + \sqrt{\frac{\sigma_1^2 \tau^2}{\sigma_0^2} - 4\tau \chi}} + \frac{4\sigma_1^2 \chi^2 \sinh^2 \left(\sqrt{\frac{\sigma_1^2 \tau^2}{\sigma_0^2} - 4\tau \chi \left(\frac{4c\sigma \sigma_1 t \tau}{\sigma_0} + x + y \right)} \right)}{\left(-\frac{\sigma_1 \tau \sinh(Z)}{\sigma_0} + \sqrt{\frac{\sigma_1^2 \tau^2}{\sigma_0^2} - 4\tau \chi} \cosh(Z) + \sqrt{\frac{\sigma_1^2 \tau^2}{\sigma_0^2} - 4\tau \chi} \right)^2},$$

where $Z = \sqrt{\frac{\sigma_1^2 \tau^2}{\sigma_0^2} - 4\tau \chi \left(\frac{4c\sigma \sigma_1 t \tau}{\sigma_0} + x + y \right)}$. By putting constant values along with Eq. (17) and wave transformation Eq. (2) in the Eqs. (40) and (41) we get the soliton solutions of Eqs. (33) and (34) such as

$$u_{12}(x, y, t) = -\frac{\delta_1}{\sqrt{4\delta_0 \delta_2 - \delta_1^2}} - \frac{8\delta_2 \chi \sinh \left(\frac{1}{4} \sqrt{\rho^2 - 4\tau \chi \left(\frac{t(2\delta_2 \rho^2 + \delta_1^2 - 4\delta_0 \delta_2 - \delta_2)}{\delta_2 \rho} + x + y \right)} \right) \cosh(Z)}{\sqrt{4\delta_0 \delta_2 - \delta_1^2} \left(-\sqrt{\rho^2 - 4\tau \chi} + 2\sqrt{\rho^2 - 4\tau \chi} \cosh^2(Z) - 2\rho \sinh(Z) \cosh(Z) \right)},$$

where $Z = \frac{1}{4} \sqrt{\rho^2 - 4\tau \chi \left(\frac{t(2\delta_2 \rho^2 + \delta_1^2 - 4\delta_0 \delta_2 - \delta_2)}{\delta_2 \rho} + x + y \right)}$.

$$v_{12}(x, y, t) = \sigma_0^2 + 1 + \frac{16\sigma_1^2 \chi^2 \sinh^2 \left(\frac{1}{4} \sqrt{\frac{\sigma_1^2 \tau^2}{\sigma_0^2} - 4\tau \chi \left(\frac{4c\sigma \sigma_1 t \tau}{\sigma_0} + x + y \right)} \right) \cosh^2(Z)}{\left(2\sqrt{\frac{\sigma_1^2 \tau^2}{\sigma_0^2} - 4\tau \chi} \cosh^2(Z) - \frac{2\sigma_1 \tau \sinh(Z) \cosh(Z)}{\sigma_0} - \sqrt{\frac{\sigma_1^2 \tau^2}{\sigma_0^2} - 4\tau \chi} \right)^2}$$

$$+ \frac{8\sigma_0\sigma_1\chi \sinh\left(\frac{1}{4}\sqrt{\frac{\sigma_1^2\tau^2}{\sigma_0^2} - 4\tau\chi}\left(\frac{4c\sigma\sigma_1t\tau}{\sigma_0} + x + y\right)\right) \cosh(Z)}{2\sqrt{\frac{\sigma_1^2\tau^2}{\sigma_0^2} - 4\tau\chi} \cosh^2(Z) - \frac{2\sigma_1\tau \sinh(Z) \cosh\left(\frac{1}{4}\sqrt{\frac{\sigma_1^2\tau^2}{\sigma_0^2} - 4\tau\chi}\left(\frac{4c\sigma\sigma_1t\tau}{\sigma_0} + x + y\right)\right)}{\sigma_0} - \sqrt{\frac{\sigma_1^2\tau^2}{\sigma_0^2} - 4\tau\chi}}$$

where $Z = \frac{1}{4}\sqrt{\frac{\sigma_1^2\tau^2}{\sigma_0^2} - 4\tau\chi}\left(\frac{4c\sigma\sigma_1t\tau}{\sigma_0} + x + y\right)$.

Type 2: When $\tau^2 - 4\rho\chi < 0$ and $\tau\rho \neq 0$ ($\sigma\tau\chi \neq 0$), we obtained trigonometric solutions. Substituting the values of constants in Eqs. (40) and (41) and by the help of general solution that are mentioned in methodology we obtained the different form of solutions.

By putting constant values along with Eq. (18) and wave transformation Eq. (2) in the Eqs. (40) and (41) we get the solitary solutions of Eqs. (33) and (34) such as

$$u_{13}(x, y, t) = -\frac{\delta_1}{\sqrt{4\delta_0\delta_2 - \delta_1^2}} - \frac{\delta_2\left(\sqrt{4\tau\chi - \rho^2} \tan\left(\frac{1}{2}\sqrt{4\tau\chi - \rho^2}\left(\frac{t(2\delta_2\rho^2 + \delta_1^2 - 4\delta_0\delta_2 - \delta_2)}{\delta_2\rho} + x + y\right)\right) - \rho\right)}{\sqrt{4\delta_0\delta_2 - \delta_1^2}\chi}$$

$$v_{13}(x, y, t) = \frac{\sigma_1^2\left(\sqrt{4\tau\chi - \frac{\sigma_1^2\tau^2}{\sigma_0^2}} \tan\left(\frac{1}{2}\sqrt{4\tau\chi - \frac{\sigma_1^2\tau^2}{\sigma_0^2}}\left(\frac{4c\sigma\sigma_1t\tau}{\sigma_0} + x + y\right)\right) - \frac{\sigma_1\tau}{\sigma_0}\right)^2}{4\chi^2}$$

$$+ \frac{\sigma_1\sigma_0\left(\sqrt{4\tau\chi - \frac{\sigma_1^2\tau^2}{\sigma_0^2}} \tan\left(\frac{1}{2}\sqrt{4\tau\chi - \frac{\sigma_1^2\tau^2}{\sigma_0^2}}\left(\frac{4c\sigma\sigma_1t\tau}{\sigma_0} + x + y\right)\right) - \frac{\sigma_1\tau}{\sigma_0}\right)}{\chi} + \sigma_0^2 + 1.$$

By putting constant values along with Eq. (19) and wave transformation Eq. (2) in the Eqs. (40) and (41) we get the solitary wave solutions of Eqs. (33) and (34) such as

$$u_{14}(x, y, t) = -\frac{\delta_1}{\sqrt{4\delta_0\delta_2 - \delta_1^2}} + \frac{\delta_2\left(\rho + \sqrt{4\tau\chi - \rho^2} \cot\left(\frac{1}{2}\sqrt{4\tau\chi - \rho^2}\left(\frac{t(2\delta_2\rho^2 + \delta_1^2 - 4\delta_0\delta_2 - \delta_2)}{\delta_2\rho} + x + y\right)\right)\right)}{\sqrt{4\delta_0\delta_2 - \delta_1^2}\chi}$$

$$v_{14}(x, y, t) = \frac{\sigma_1^2\left(\sqrt{4\tau\chi - \frac{\sigma_1^2\tau^2}{\sigma_0^2}} \cot\left(\frac{1}{2}\sqrt{4\tau\chi - \frac{\sigma_1^2\tau^2}{\sigma_0^2}}\left(\frac{4c\sigma\sigma_1t\tau}{\sigma_0} + x + y\right)\right) + \frac{\sigma_1\tau}{\sigma_0}\right)^2}{4\chi^2}$$

$$- \frac{\sigma_1\sigma_0\left(\sqrt{4\tau\chi - \frac{\sigma_1^2\tau^2}{\sigma_0^2}} \cot\left(\frac{1}{2}\sqrt{4\tau\chi - \frac{\sigma_1^2\tau^2}{\sigma_0^2}}\left(\frac{4c\sigma\sigma_1t\tau}{\sigma_0} + x + y\right)\right) + \frac{\sigma_1\tau}{\sigma_0}\right)}{\chi} + \sigma_0^2 + 1.$$

By putting constant values along with Eq. (20) and wave transformation Eq. (2) in the Eqs. (40) and (41) we get the solitary wave solutions of Eqs. (33) and (34) such as

$$u_{15}(x, y, t) = -\frac{\delta_1}{\sqrt{4\delta_0\delta_2 - \delta_1^2}} - \frac{\delta_2}{\sqrt{4\delta_0\delta_2 - \delta_1^2}\chi} \left(-\rho\sqrt{4\tau\chi - \rho^2} \left(\tan\left(\sqrt{4\tau\chi - \rho^2}\right.\right.\right.$$

$$\left.\left.\left.\left(\frac{t(2\delta_2\rho^2 + \delta_1^2 - 4\delta_0\delta_2 - \delta_2)}{\delta_2\rho} + x + y\right)\right) - \sec\left(\sqrt{4\tau\chi - \rho^2}\left(\frac{t(2\delta_2\rho^2 + \delta_1^2 - 4\delta_0\delta_2 - \delta_2)}{\delta_2\rho} + x + y\right)\right)\right)\right),$$

$$v_{15}(x, y, t) = \sigma_0^2 + 1 + \frac{\sigma_1\sigma_0}{\chi} \left(\sqrt{4\tau\chi - \frac{\sigma_1^2\tau^2}{\sigma_0^2}} \left(\tan\left(\sqrt{4\tau\chi - \frac{\sigma_1^2\tau^2}{\sigma_0^2}}\left(\frac{4c\sigma\sigma_1t\tau}{\sigma_0} + x + y\right)\right)\right.\right.$$

$$\left.\left.- \sec\left(\sqrt{4\tau\chi - \frac{\sigma_1^2\tau^2}{\sigma_0^2}}\left(\frac{4c\sigma\sigma_1t\tau}{\sigma_0} + x + y\right)\right)\right) - \frac{\sigma_1\tau}{\sigma_0} + \frac{\sigma_1^2}{4\chi^2} \left(\sqrt{4\tau\chi - \frac{\sigma_1^2\tau^2}{\sigma_0^2}}\right)$$

$$\left(\tan \left(\sqrt{4\tau\chi - \frac{\sigma_1^2\tau^2}{\sigma_0^2}} \left(\frac{4c\sigma\sigma_1t\tau}{\sigma_0} + x + y \right) \right) - \sec \left(\sqrt{4\tau\chi - \frac{\sigma_1^2\tau^2}{\sigma_0^2}} \left(\frac{4c\sigma\sigma_1t\tau}{\sigma_0} + x + y \right) \right) \right) - \frac{\sigma_1\tau}{\sigma_0} \right)^2.$$

By putting constant values along with Eq. (21) and wave transformation Eq. (2) in the Eqs. (40) and (41) we get the solitary wave solutions of Eqs. (33) and (34) such as

$$u_{16}(x, y, t) = -\frac{\delta_1}{\sqrt{4\delta_0\delta_2 - \delta_1^2}} + \frac{\delta_2}{\sqrt{4\delta_0\delta_2 - \delta_1^2}\chi} \left(\rho + \sqrt{4\tau\chi - \rho^2} \left(\cot \left(\sqrt{4\tau\chi - \rho^2} \left(\frac{t(2\delta_2\rho^2 + \delta_1^2 - 4\delta_0\delta_2 - \delta_2)}{\delta_2\rho} + x + y \right) \right) - \csc \left(\sqrt{4\tau\chi - \rho^2} \left(\frac{t(2\delta_2\rho^2 + \delta_1^2 - 4\delta_0\delta_2 - \delta_2)}{\delta_2\rho} + x + y \right) \right) \right) \right),$$

$$v_{16}(x, y, t) = \sigma_0^2 + 1 - \frac{\sigma_1\sigma_0}{\chi} \left(\sqrt{4\tau\chi - \frac{\sigma_1^2\tau^2}{\sigma_0^2}} \left(\cot \left(\sqrt{4\tau\chi - \frac{\sigma_1^2\tau^2}{\sigma_0^2}} \left(\frac{4c\sigma\sigma_1t\tau}{\sigma_0} + x + y \right) \right) \right) - \csc \left(\sqrt{4\tau\chi - \frac{\sigma_1^2\tau^2}{\sigma_0^2}} \left(\frac{4c\sigma\sigma_1t\tau}{\sigma_0} + x + y \right) \right) \right) + \frac{\sigma_1\tau}{\sigma_0} + \frac{\sigma_1^2}{4\chi^2} \left(\sqrt{4\tau\chi - \frac{\sigma_1^2\tau^2}{\sigma_0^2}} \right)$$

$$\left(\cot \left(\sqrt{4\tau\chi - \frac{\sigma_1^2\tau^2}{\sigma_0^2}} \left(\frac{4c\sigma\sigma_1t\tau}{\sigma_0} + x + y \right) \right) - \csc \left(\sqrt{4\tau\chi - \frac{\sigma_1^2\tau^2}{\sigma_0^2}} \left(\frac{4c\sigma\sigma_1t\tau}{\sigma_0} + x + y \right) \right) \right) + \frac{\sigma_1\tau}{\sigma_0} \right)^2.$$

By putting constant values along with Eq. (22) and wave transformation Eq. (2) in the Eqs. (40) and (41) we get the solitary wave solutions of Eqs. (33) and (34) such as

$$u_{17}(x, y, t) = -\frac{\delta_1}{\sqrt{4\delta_0\delta_2 - \delta_1^2}} - \frac{\delta_2}{2\sqrt{4\delta_0\delta_2 - \delta_1^2}\chi} \left(\sqrt{4\tau\chi - \rho^2} \left(\tan \left(\frac{1}{4}\sqrt{4\tau\chi - \rho^2} \left(\frac{t(2\delta_2\rho^2 + \delta_1^2 - 4\delta_0\delta_2 - \delta_2)}{\delta_2\rho} + x + y \right) \right) - \cot \left(\frac{1}{4}\sqrt{4\tau\chi - \rho^2} \left(\frac{t(2\delta_2\rho^2 + \delta_1^2 - 4\delta_0\delta_2 - \delta_2)}{\delta_2\rho} + x + y \right) \right) \right) - 2\rho \right),$$

$$v_{17}(x, y, t) = \sigma_0^2 + 1 + \frac{\sigma_1\sigma_0}{2\chi} \left(\sqrt{4\tau\chi - \frac{\sigma_1^2\tau^2}{\sigma_0^2}} \left(\tan \left(\frac{1}{4}\sqrt{4\tau\chi - \frac{\sigma_1^2\tau^2}{\sigma_0^2}} \left(\frac{4c\sigma\sigma_1t\tau}{\sigma_0} + x + y \right) \right) \right) - \cot \left(\frac{1}{4}\sqrt{4\tau\chi - \frac{\sigma_1^2\tau^2}{\sigma_0^2}} \left(\frac{4c\sigma\sigma_1t\tau}{\sigma_0} + x + y \right) \right) \right) - \frac{2\sigma_1\tau}{\sigma_0} + \frac{\sigma_1^2}{16\chi^2} \left(\sqrt{4\tau\chi - \frac{\sigma_1^2\tau^2}{\sigma_0^2}} \right)$$

$$\left(\tan \left(\frac{1}{4}\sqrt{4\tau\chi - \frac{\sigma_1^2\tau^2}{\sigma_0^2}} \left(\frac{4c\sigma\sigma_1t\tau}{\sigma_0} + x + y \right) \right) - \cot \left(\frac{1}{4}\sqrt{4\tau\chi - \frac{\sigma_1^2\tau^2}{\sigma_0^2}} \left(\frac{4c\sigma\sigma_1t\tau}{\sigma_0} + x + y \right) \right) \right) - \frac{2\sigma_1\tau}{\sigma_0} \right)^2.$$

By putting constant values along with Eq. (23) and wave transformation Eq. (2) in the Eqs. (40) and (41) we get the solitary wave solutions of Eqs. (33) and (34) such as

$$u_{18}(x, y, t) = -\frac{\delta_1}{\sqrt{4\delta_0\delta_2 - \delta_1^2}} - \frac{\delta_2}{\sqrt{4\delta_0\delta_2 - \delta_1^2}\chi} \left(-\rho + \frac{\sqrt{(G^2 - H^2)(4\tau\chi - \rho^2)} - G\sqrt{4\tau\chi - \rho^2} \cos \left(\sqrt{4\tau\chi - \rho^2} \left(\frac{t(2\delta_2\rho^2 + \delta_1^2 - 4\delta_0\delta_2 - \delta_2)}{\delta_2\rho} + x + y \right) \right)}{G\sin \left(\sqrt{4\tau\chi - \rho^2} \left(\frac{t(2\delta_2\rho^2 + \delta_1^2 - 4\delta_0\delta_2 - \delta_2)}{\delta_2\rho} + x + y \right) \right) + H} \right),$$

$$v_{18}(x, y, t) = \frac{\sigma_1^2 \left(\frac{\sqrt{(G^2-H^2)\left(4\tau\chi - \frac{\sigma_1^2\tau^2}{\sigma_0^2}\right)} - G\sqrt{4\tau\chi - \frac{\sigma_1^2\tau^2}{\sigma_0^2}} \cos\left(\sqrt{4\tau\chi - \frac{\sigma_1^2\tau^2}{\sigma_0^2}} \left(\frac{4c\sigma_1 t\tau}{\sigma_0} + x+y\right)\right)}{G\sin\left(\sqrt{4\tau\chi - \frac{\sigma_1^2\tau^2}{\sigma_0^2}} \left(\frac{4c\sigma_1 t\tau}{\sigma_0} + x+y\right)\right) + H} - \frac{\sigma_1\tau}{\sigma_0} \right)^2}{4\chi^2} + \frac{\sigma_1\sigma_0 \left(\frac{\sqrt{(G^2-H^2)\left(4\tau\chi - \frac{\sigma_1^2\tau^2}{\sigma_0^2}\right)} - G\sqrt{4\tau\chi - \frac{\sigma_1^2\tau^2}{\sigma_0^2}} \cos\left(\sqrt{4\tau\chi - \frac{\sigma_1^2\tau^2}{\sigma_0^2}} \left(\frac{4c\sigma_1 t\tau}{\sigma_0} + x+y\right)\right)}{G\sin\left(\sqrt{4\tau\chi - \frac{\sigma_1^2\tau^2}{\sigma_0^2}} \left(\frac{4c\sigma_1 t\tau}{\sigma_0} + x+y\right)\right) + H} - \frac{\sigma_1\tau}{\sigma_0} \right)}{\chi} + \sigma_0^2 + 1.$$

By putting constant values along with Eq. (24) and wave transformation Eq. (2) in the Eqs. (40) and (41) we get the solitary wave solutions of Eqs. (33) and (34) such as

$$u_{19}(x, y, t) = -\frac{\delta_1}{\sqrt{4\delta_0\delta_2 - \delta_1^2}} - \frac{\delta_2}{\sqrt{4\delta_0\delta_2 - \delta_1^2}\chi} \left(-\frac{\sqrt{(G^2-H^2)(4\tau\chi - \rho^2)} + G\sqrt{4\tau\chi - \rho^2} \cos\left(\sqrt{4\tau\chi - \rho^2} \left(\frac{t(2\delta_2\rho^2 + \delta_1^2 - 4\delta_0\delta_2 - \delta_2)}{\delta_2\rho} + x+y\right)\right)}{G\sin\left(\sqrt{4\tau\chi - \rho^2} \left(\frac{t(2\delta_2\rho^2 + \delta_1^2 - 4\delta_0\delta_2 - \delta_2)}{\delta_2\rho} + x+y\right)\right) + H} - \rho \right),$$

$$v_{19}(x, y, t) = \frac{\sigma_1^2 \left(-\frac{G\sqrt{4\tau\chi - \frac{\sigma_1^2\tau^2}{\sigma_0^2}} \cos\left(\sqrt{4\tau\chi - \frac{\sigma_1^2\tau^2}{\sigma_0^2}} \left(\frac{4c\sigma_1 t\tau}{\sigma_0} + x+y\right)\right) + \sqrt{(G^2-H^2)\left(4\tau\chi - \frac{\sigma_1^2\tau^2}{\sigma_0^2}\right)} - \frac{\sigma_1\tau}{\sigma_0} \right)^2}{4\chi^2} + \frac{\sigma_1\sigma_0 \left(-\frac{G\sqrt{4\tau\chi - \frac{\sigma_1^2\tau^2}{\sigma_0^2}} \cos\left(\sqrt{4\tau\chi - \frac{\sigma_1^2\tau^2}{\sigma_0^2}} \left(\frac{4c\sigma_1 t\tau}{\sigma_0} + x+y\right)\right) + \sqrt{(G^2-H^2)\left(4\tau\chi - \frac{\sigma_1^2\tau^2}{\sigma_0^2}\right)} - \frac{\sigma_1\tau}{\sigma_0} \right)}{\chi} + \sigma_0^2 + 1,$$

where G and H are two non-zero real constants and satisfies $G^2 - H^2 > 0$.

By putting constant values along with Eq. (25) and wave transformation Eq. (2) in the Eqs. (40) and (41) we get the solitary wave solutions of Eqs. (33) and (34) such as

$$u_{20}(x, y, t) = -\frac{\delta_1}{\sqrt{4\delta_0\delta_2 - \delta_1^2}} + \frac{4\delta_2\chi \cos\left(\frac{1}{2}\sqrt{4\tau\chi - \rho^2} \left(\frac{t(2\delta_2\rho^2 + \delta_1^2 - 4\delta_0\delta_2 - \delta_2)}{\delta_2\rho} + x+y\right)\right)}{\sqrt{4\delta_0\delta_2 - \delta_1^2} \left(\sqrt{4\tau\chi - \rho^2} \sin(Z) + \rho \cos(Z)\right)}, \tag{42}$$

where $Z = \frac{1}{2}\sqrt{4\tau\chi - \rho^2} \left(\frac{t(2\delta_2\rho^2 + \delta_1^2 - 4\delta_0\delta_2 - \delta_2)}{\delta_2\rho} + x+y\right)$.

$$v_{20}(x, y, t) = \sigma_0^2 + 1 - \frac{4\sigma_1\sigma_0\chi \cos\left(\frac{1}{2}\sqrt{4\tau\chi - \frac{\sigma_1^2\tau^2}{\sigma_0^2}} \left(\frac{4c\sigma_1 t\tau}{\sigma_0} + x+y\right)\right)}{\sqrt{4\tau\chi - \frac{\sigma_1^2\tau^2}{\sigma_0^2}} \sin(Z) + \frac{\sigma_1\tau \cos(Z)}{\sigma_0}} + \frac{4\sigma_1^2\chi^2 \cos^2\left(\frac{1}{2}\sqrt{4\tau\chi - \frac{\sigma_1^2\tau^2}{\sigma_0^2}} \left(\frac{4c\sigma_1 t\tau}{\sigma_0} + x+y\right)\right)}{\left(\sqrt{4\tau\chi - \frac{\sigma_1^2\tau^2}{\sigma_0^2}} \sin(Z) + \frac{\sigma_1\tau \cos\left(\frac{1}{2}\sqrt{4\tau\chi - \frac{\sigma_1^2\tau^2}{\sigma_0^2}} \left(\frac{4c\sigma_1 t\tau}{\sigma_0} + x+y\right)\right)}{\sigma_0}\right)^2},$$

where $G = \frac{1}{2}\sqrt{4\tau\chi - \frac{\sigma_1^2\tau^2}{\sigma_0^2}} \left(\frac{4c\sigma_1 t\tau}{\sigma_0} + x+y\right)$. By putting constant values along with Eq. (26) and wave transformation Eq. (2) in the Eqs. (40) and (41) we get the solitary wave solutions of Eqs. (33) and (34) such as

$$u_{21}(x, y, t) = -\frac{\delta_1}{\sqrt{4\delta_0\delta_2 - \delta_1^2}} - \frac{4\delta_2\chi \sin\left(\frac{1}{2}\sqrt{4\tau\chi - \rho^2}\left(\frac{t(2\delta_2\rho^2 + \delta_1^2 - 4\delta_0\delta_2 - \delta_2)}{\delta_2\rho} + x + y\right)\right)}{\sqrt{4\delta_0\delta_2 - \delta_1^2}\left(\sqrt{4\tau\chi - \rho^2}\cos(Z) - \rho\sin(Z)\right)},$$

where $Z = \frac{1}{2}\sqrt{4\tau\chi - \rho^2}\left(\frac{t(2\delta_2\rho^2 + \delta_1^2 - 4\delta_0\delta_2 - \delta_2)}{\delta_2\rho} + x + y\right)$.

$$v_{21}(x, y, t) = \sigma_0^2 + 1 + \frac{4\sigma_1^2\chi^2 \sin^2\left(\frac{1}{2}\sqrt{4\tau\chi - \frac{\sigma_1^2\tau^2}{\sigma_0^2}}\left(\frac{4c\sigma_1t\tau}{\sigma_0} + x + y\right)\right)}{\left(\sqrt{4\tau\chi - \frac{\sigma_1^2\tau^2}{\sigma_0^2}}\cos\left(\frac{1}{2}\sqrt{4\tau\chi - \frac{\sigma_1^2\tau^2}{\sigma_0^2}}\left(\frac{4c\sigma_1t\tau}{\sigma_0} + x + y\right)\right) - \frac{\sigma_1\tau\sin(Z)}{\sigma_0}\right)^2} + \frac{4\sigma_1\sigma_0\chi \sin\left(\frac{1}{2}\sqrt{4\tau\chi - \frac{\sigma_1^2\tau^2}{\sigma_0^2}}\left(\frac{4c\sigma_1t\tau}{\sigma_0} + x + y\right)\right)}{\sqrt{4\tau\chi - \frac{\sigma_1^2\tau^2}{\sigma_0^2}}\cos\left(\frac{1}{2}\sqrt{4\tau\chi - \frac{\sigma_1^2\tau^2}{\sigma_0^2}}\left(\frac{4c\sigma_1t\tau}{\sigma_0} + x + y\right)\right) - \frac{\sigma_1\tau\sin(Z)}{\sigma_0}},$$

where $Z = \frac{1}{2}\sqrt{4\tau\chi - \frac{\sigma_1^2\tau^2}{\sigma_0^2}}\left(\frac{4c\sigma_1t\tau}{\sigma_0} + x + y\right)$. By putting constant values along with Eq. (27) and wave transformation Eq. (2) in the Eqs. (40) and (41) we get the solitary wave solutions of Eqs. (33) and (34) such as

$$u_{22}(x, y, t) = -\frac{\delta_1}{\sqrt{4\delta_0\delta_2 - \delta_1^2}} + \frac{4\delta_2\chi \cos\left(\sqrt{4\tau\chi - \rho^2}\left(\frac{t(2\delta_2\rho^2 + \delta_1^2 - 4\delta_0\delta_2 - \delta_2)}{\delta_2\rho} + x + y\right)\right)}{\sqrt{4\delta_0\delta_2 - \delta_1^2}\left(\sqrt{4\tau\chi - \rho^2} + \sqrt{4\tau\chi - \rho^2}\sin(Z) + \rho\cos(Z)\right)},$$

where $Z = \sqrt{4\tau\chi - \rho^2}\left(\frac{t(2\delta_2\rho^2 + \delta_1^2 - 4\delta_0\delta_2 - \delta_2)}{\delta_2\rho} + x + y\right)$.

$$v_{22}(x, y, t) = \sigma_0^2 + 1 - \frac{4\sigma_1\sigma_0\chi \cos\left(\sqrt{4\tau\chi - \frac{\sigma_1^2\tau^2}{\sigma_0^2}}\left(\frac{4c\sigma_1t\tau}{\sigma_0} + x + y\right)\right)}{\sqrt{4\tau\chi - \frac{\sigma_1^2\tau^2}{\sigma_0^2}}\sin\left(\sqrt{4\tau\chi - \frac{\sigma_1^2\tau^2}{\sigma_0^2}}\left(\frac{4c\sigma_1t\tau}{\sigma_0} + x + y\right)\right) + \frac{\sigma_1\tau\cos(Z)}{\sigma_0} + \sqrt{4\tau\chi - \frac{\sigma_1^2\tau^2}{\sigma_0^2}}} + \frac{4\sigma_1^2\chi^2 \cos^2\left(\sqrt{4\tau\chi - \frac{\sigma_1^2\tau^2}{\sigma_0^2}}\left(\frac{4c\sigma_1t\tau}{\sigma_0} + x + y\right)\right)}{\left(\sqrt{4\tau\chi - \frac{\sigma_1^2\tau^2}{\sigma_0^2}}\sin\left(\sqrt{4\tau\chi - \frac{\sigma_1^2\tau^2}{\sigma_0^2}}\left(\frac{4c\sigma_1t\tau}{\sigma_0} + x + y\right)\right) + \frac{\sigma_1\tau\cos(Z)}{\sigma_0} + \sqrt{4\tau\chi - \frac{\sigma_1^2\tau^2}{\sigma_0^2}}\right)^2},$$

where $Z = \sqrt{4\tau\chi - \frac{\sigma_1^2\tau^2}{\sigma_0^2}}\left(\frac{4c\sigma_1t\tau}{\sigma_0} + x + y\right)$. By putting constant values along with Eq. (28) and wave transformation Eq. (2) in the Eqs. (40) and (41) we get the solitary wave solutions of Eqs. (33) and (34) such as

$$u_{23}(x, y, t) = -\frac{\delta_1}{\sqrt{4\delta_0\delta_2 - \delta_1^2}} - \frac{4\delta_2\chi \sin\left(\sqrt{4\tau\chi - \rho^2}\left(\frac{t(2\delta_2\rho^2 + \delta_1^2 - 4\delta_0\delta_2 - \delta_2)}{\delta_2\rho} + x + y\right)\right)}{\sqrt{4\delta_0\delta_2 - \delta_1^2}\left(\sqrt{4\tau\chi - \rho^2} - \rho\sin(Z) + \sqrt{4\tau\chi - \rho^2}\cos(Z)\right)},$$

where $Z = \sqrt{4\tau\chi - \rho^2}\left(\frac{t(2\delta_2\rho^2 + \delta_1^2 - 4\delta_0\delta_2 - \delta_2)}{\delta_2\rho} + x + y\right)$.

$$v_{23}(x, y, t) = \sigma_0^2 + 1 + \frac{4\sigma_1\sigma_0\chi \sin\left(\sqrt{4\tau\chi - \frac{\sigma_1^2\tau^2}{\sigma_0^2}}\left(\frac{4c\sigma_1t\tau}{\sigma_0} + x + y\right)\right)}{-\frac{\sigma_1\tau\sin(Z)}{\sigma_0} + \sqrt{4\tau\chi - \frac{\sigma_1^2\tau^2}{\sigma_0^2}}\cos\left(\sqrt{4\tau\chi - \frac{\sigma_1^2\tau^2}{\sigma_0^2}}\left(\frac{4c\sigma_1t\tau}{\sigma_0} + x + y\right)\right) + \sqrt{4\tau\chi - \frac{\sigma_1^2\tau^2}{\sigma_0^2}}} + \frac{4\sigma_1^2\chi^2 \sin^2\left(\sqrt{4\tau\chi - \frac{\sigma_1^2\tau^2}{\sigma_0^2}}\left(\frac{4c\sigma_1t\tau}{\sigma_0} + x + y\right)\right)}{\left(-\frac{\sigma_1\tau\sin\left(\sqrt{4\tau\chi - \frac{\sigma_1^2\tau^2}{\sigma_0^2}}\left(\frac{4c\sigma_1t\tau}{\sigma_0} + x + y\right)\right)}{\sigma_0} + \sqrt{4\tau\chi - \frac{\sigma_1^2\tau^2}{\sigma_0^2}}\cos(Z) + \sqrt{4\tau\chi - \frac{\sigma_1^2\tau^2}{\sigma_0^2}}\right)^2},$$

where $Z = \sqrt{4\tau\chi - \frac{\sigma_1^2\tau^2}{\sigma_0^2}}\left(\frac{4c\sigma_1t\tau}{\sigma_0} + x + y\right)$. By putting constant values along with Eq. (29) and wave transformation Eq. (2) in the Eqs. (40) and (41) we get the solitary wave solutions of Eqs. (33) and (34) such as

$$u_{24}(x, y, t) = -\frac{\delta_1}{\sqrt{4\delta_0\delta_2 - \delta_1^2}} - \frac{8\delta_2\chi \sin(Z)\cos\left(\frac{1}{4}\sqrt{4\tau\chi - \rho^2}\left(\frac{t(2\delta_2\rho^2 + \delta_1^2 - 4\delta_0\delta_2 - \delta_2)}{\delta_2\rho} + x + y\right)\right)}{\sqrt{4\delta_0\delta_2 - \delta_1^2}\left(-\sqrt{4\tau\chi - \rho^2} + 2\sqrt{4\tau\chi - \rho^2}\cos^2(Z) - 2\rho\sin(Z)\cos(Z)\right)},$$

where $Z = \frac{1}{4}\sqrt{4\tau\chi - \rho^2}\left(\frac{t(2\delta_2\rho^2 + \delta_1^2 - 4\delta_0\delta_2 - \delta_2)}{\delta_2\rho} + x + y\right)$.

$$v_{24}(x, y, t) = \sigma_0^2 + 1 + \frac{8\sigma_1\sigma_0\chi \sin\left(\frac{1}{4}\sqrt{4\tau\chi - \frac{\sigma_1^2\tau^2}{\sigma_0^2}}\left(\frac{4c\sigma_1t\tau}{\sigma_0} + x + y\right)\right)\cos(Z)}{2\sqrt{4\tau\chi - \frac{\sigma_1^2\tau^2}{\sigma_0^2}}\cos^2(Z) - \frac{2\sigma_1\tau\sin(Z)\cos(Z)}{\sigma_0} - \sqrt{4\tau\chi - \frac{\sigma_1^2\tau^2}{\sigma_0^2}}} + \frac{16\sigma_1^2\chi^2\sin^2\left(\frac{1}{4}\sqrt{4\tau\chi - \frac{\sigma_1^2\tau^2}{\sigma_0^2}}\left(\frac{4c\sigma_1t\tau}{\sigma_0} + x + y\right)\right)\cos^2(Z)}{\left(2\sqrt{4\tau\chi - \frac{\sigma_1^2\tau^2}{\sigma_0^2}}\cos^2(Z) - \frac{2\sigma_1\tau\sin(Z)\cos(Z)}{\sigma_0} - \sqrt{4\tau\chi - \frac{\sigma_1^2\tau^2}{\sigma_0^2}}\right)^2},$$

where $Z = \frac{1}{4}\sqrt{4\tau\chi - \frac{\sigma_1^2\tau^2}{\sigma_0^2}}\left(\frac{4c\sigma_1t\tau}{\sigma_0} + x + y\right)$.

Type 3: When $\chi = 0$ and $\tau\rho \neq 0$, we obtained hyperbolic function solutions. By putting constant values along with Eq. (30) and wave transformation Eq. (2) in the Eqs. (40) and (41) we get the hyperbolic function solutions of Eqs. (33) and (34) such as

$$u_{25}(x, y, t) = -\frac{\delta_1}{\sqrt{4\delta_0\delta_2 - \delta_1^2}} + \frac{2d\delta_2\rho}{\sqrt{4\delta_0\delta_2 - \delta_1^2}q\left(d - \sinh\left(\rho\left(\frac{t(2\delta_2\rho^2 + \delta_1^2 - 4\delta_0\delta_2 - \delta_2)}{\delta_2\rho} + x + y\right)\right) + \cosh(Z)\right)},$$

where $Z = \rho\left(\frac{t(2\delta_2\rho^2 + \delta_1^2 - 4\delta_0\delta_2 - \delta_2)}{\delta_2\rho} + x + y\right)$.

$$v_{25}(x, y, t) = \frac{d^2\sigma_1^4\tau^2}{q^2\sigma_0^2\left(-\sinh\left(\frac{\sigma_1\tau\left(\frac{4c\sigma_1t\tau}{\sigma_0} + x + y\right)}{\sigma_0}\right) + \cosh\left(\frac{\sigma_1\tau\left(\frac{4c\sigma_1t\tau}{\sigma_0} + x + y\right)}{\sigma_0}\right) + d\right)^2} - \frac{2d\sigma_1^2\tau}{q\left(-\sinh\left(\frac{\sigma_1\tau\left(\frac{4c\sigma_1t\tau}{\sigma_0} + x + y\right)}{\sigma_0}\right) + \cosh\left(\frac{\sigma_1\tau\left(\frac{4c\sigma_1t\tau}{\sigma_0} + x + y\right)}{\sigma_0}\right) + d\right)} + \sigma_0^2 + 1.$$

By putting constant values along with Eq. (31) and wave transformation Eq. (2) in the Eqs. (40) and (41) we get the hyperbolic function solutions of Eqs. (33) and (34) such as

$$u_{26}(x, y, t) = -\frac{\delta_1}{\sqrt{4\delta_0\delta_2 - \delta_1^2}} - \frac{2\delta_2\rho\left(\sinh\left(\rho\left(\frac{t(2\delta_2\rho^2 + \delta_1^2 - 4\delta_0\delta_2 - \delta_2)}{\delta_2\rho} + x + y\right)\right) + \cosh(Z)\right)}{\sqrt{4\delta_0\delta_2 - \delta_1^2}q\left(d + \sinh\left(\rho\left(\frac{t(2\delta_2\rho^2 + \delta_1^2 - 4\delta_0\delta_2 - \delta_2)}{\delta_2\rho} + x + y\right)\right) + \cosh(Z)\right)},$$

where $Z = \rho\left(\frac{t(2\delta_2\rho^2 + \delta_1^2 - 4\delta_0\delta_2 - \delta_2)}{\delta_2\rho} + x + y\right)$.

$$v_{26}(x, y, t) = \frac{\sigma_1^4\tau^2\left(\sinh\left(\frac{\sigma_1\tau\left(\frac{4c\sigma_1t\tau}{\sigma_0} + x + y\right)}{\sigma_0}\right) + \cosh\left(\frac{\sigma_1\tau\left(\frac{4c\sigma_1t\tau}{\sigma_0} + x + y\right)}{\sigma_0}\right)\right)^2}{q^2\sigma_0^2\left(\sinh\left(\frac{\sigma_1\tau\left(\frac{4c\sigma_1t\tau}{\sigma_0} + x + y\right)}{\sigma_0}\right) + \cosh\left(\frac{\sigma_1\tau\left(\frac{4c\sigma_1t\tau}{\sigma_0} + x + y\right)}{\sigma_0}\right) + d\right)^2} + \frac{2\sigma_1^2\tau\left(\sinh\left(\frac{\sigma_1\tau\left(\frac{4c\sigma_1t\tau}{\sigma_0} + x + y\right)}{\sigma_0}\right) + \cosh\left(\frac{\sigma_1\tau\left(\frac{4c\sigma_1t\tau}{\sigma_0} + x + y\right)}{\sigma_0}\right)\right)}{q\left(\sinh\left(\frac{\sigma_1\tau\left(\frac{4c\sigma_1t\tau}{\sigma_0} + x + y\right)}{\sigma_0}\right) + \cosh\left(\frac{\sigma_1\tau\left(\frac{4c\sigma_1t\tau}{\sigma_0} + x + y\right)}{\sigma_0}\right) + d\right)} + \sigma_0^2 + 1.$$

Type 4: When $\rho \neq 0$ and $\tau\chi = 0$, we obtained rational solutions. By putting constant values along with Eq. (32) and wave transformation Eq. (2) in the Eqs. (40) and (41) we get the rational solutions of Eqs. (33) and (34) such as

$$u_{27}(x, y, t) = -\frac{\delta_1}{\sqrt{4\delta_0\delta_2 - \delta_1^2}} + \frac{2\delta_2}{\sqrt{4\delta_0\delta_2 - \delta_1^2} \left(d_1 + q \left(\frac{t(2\delta_2\rho^2 + \delta_1^2 - 4\delta_0\delta_2 - \delta_2)}{\delta_2\rho} + x + y \right) \right)},$$

$$v_{27}(x, y, t) = \sigma_0^2 + 1 - \frac{2\sigma_1\sigma_0}{q \left(\frac{4c\sigma_1 t \tau}{\sigma_0} + x + y \right) + d_1} + \frac{\sigma_1^2}{\left(q \left(\frac{4c\sigma_1 t \tau}{\sigma_0} + x + y \right) + d_1 \right)^2},$$

where d_1 is an arbitrary constant⁴⁴.

Graphical behaviors

In this section, we discuss the graphical behavior of the solutions that are successfully obtained by using the GREM method for the reaction–diffusion Lengyel–Epstein system. In summary, the GREM technique is a useful tool to obtain the exact solitary wave solutions and control theory, especially for linear time-invariant systems. Its applicability to a wide variety of control issues is constrained by the linearity assumption, complexity, and limits mentioned earlier. When selecting whether to adopt GREM or look into other control approaches, engineers should take into account the unique characteristics of their systems and the issue at hand. Many physical significances are explained by sketching some three-dimensional diagrams and their corresponding contours for the acquired solutions. These figures give us a better understanding of the behavior of these solutions. The different solutions are plotted in 3D and their corresponding contour representations on the MATHEMATICA 11.1 for the different values of constants. These results are very helpful in the dynamic study of this chemical reaction model. The Figs. 1, 2, 3 and 4 show the kink type soliton behavior for the inhibitor chlorite using the range of space and temporal parameters $[-10, 10]$ and $[-2, 2]$ respectively. The Figs. 5, 6, 7, 8 and 9 show the solitary wave behaviors for the range of space and temporal parameters $[-1, 1]$. The Figs. 10 and 11 are the lump

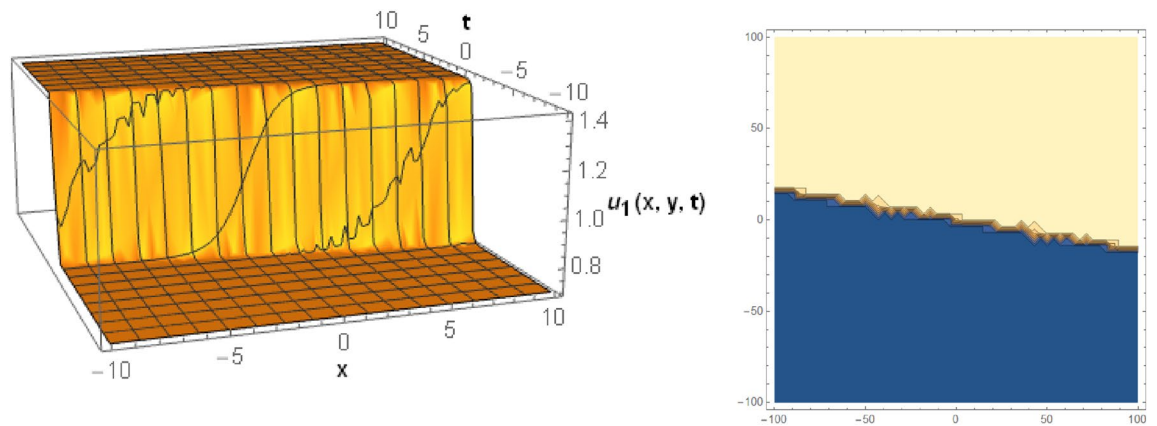

Figure 1. The plots u_1 for the values of constants $\delta_0 = 1.995, \delta_1 = 0.209, \delta_2 = 2.1, \rho = 4.1, \tau = 1.98, \chi = 1.9$ and $y = 1$.

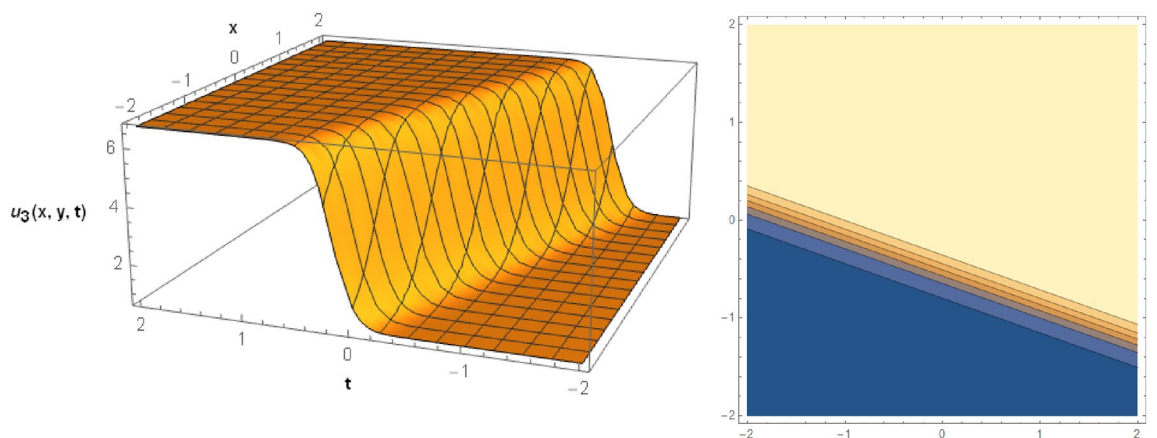

Figure 2. The 3D and 2D graphs for the values of u_3 for the values of parameters $\delta_0 = 1.909, \delta_1 = 0.00209, \delta_2 = 10.1, \rho = 2.9, \tau = 0.8, \chi = 0.9,$ and $y = 1.3$.

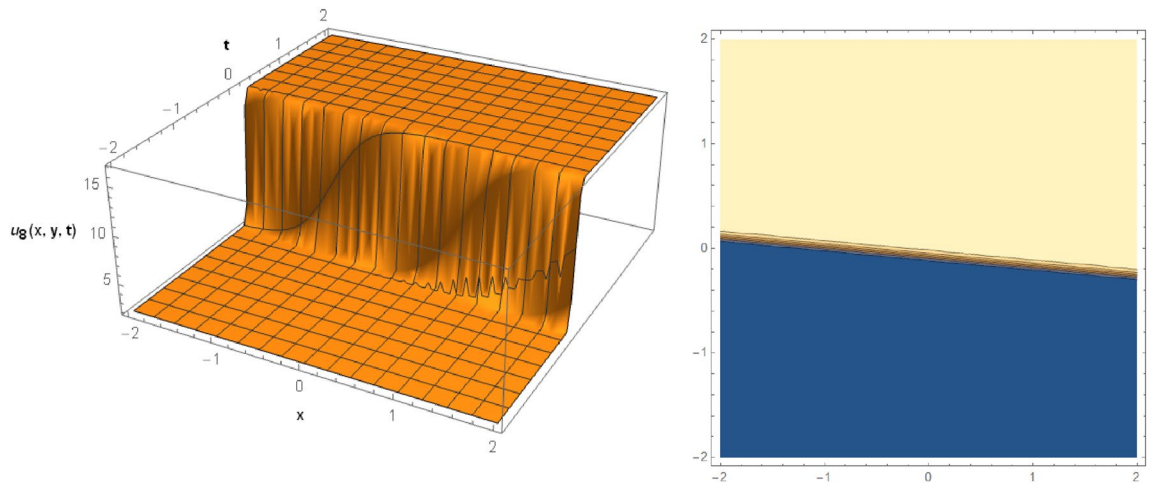

Figure 3. The plots u_8 for the values of constants $\delta_0 = 0.9, \delta_1 = 0.9, \delta_2 = 30.1, \rho = 5.9, \tau = 1.8, \chi = 1.9,$ and $y = 1.3.$

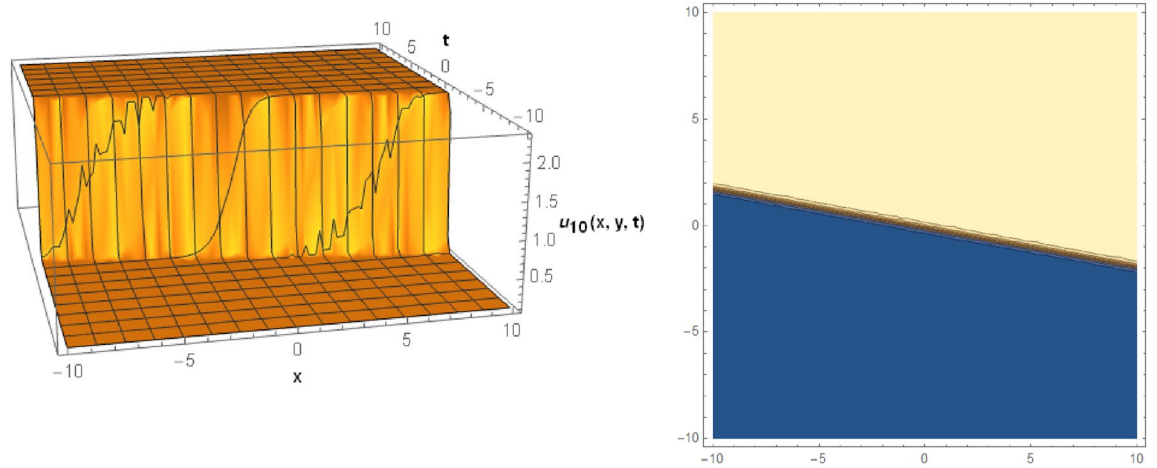

Figure 4. The plots u_{10} for the values of constants $\delta_0 = 0.01, \delta_1 = 0.09, \delta_2 = 0.1, \rho = 2.9, \tau = 1.8, \chi = 0.9,$ and $y = 1.$

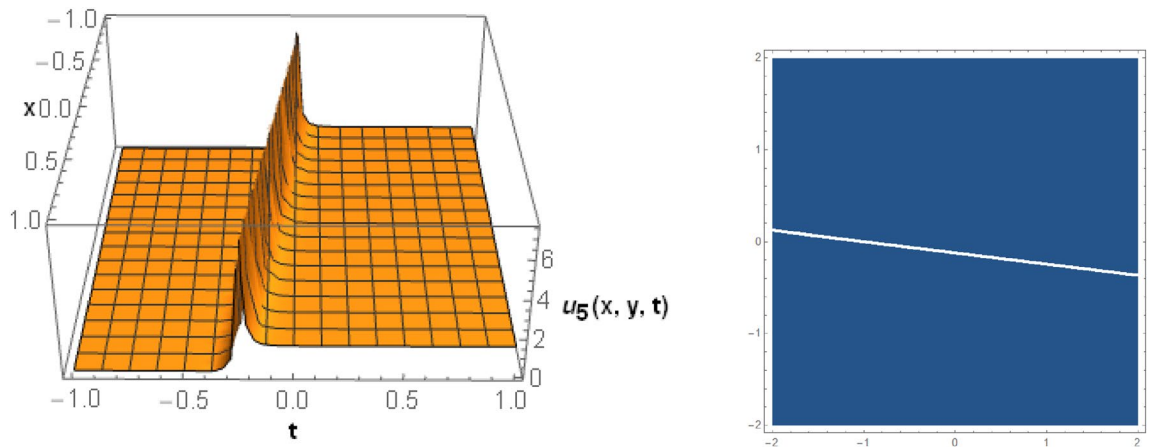

Figure 5. The plots u_5 for the values of constants $\delta_0 = 1.909, \delta_1 = 0.9, \delta_2 = 1.1, \rho = 4.9, \tau = 1.8, \chi = 1.9,$ and $y = 1.$

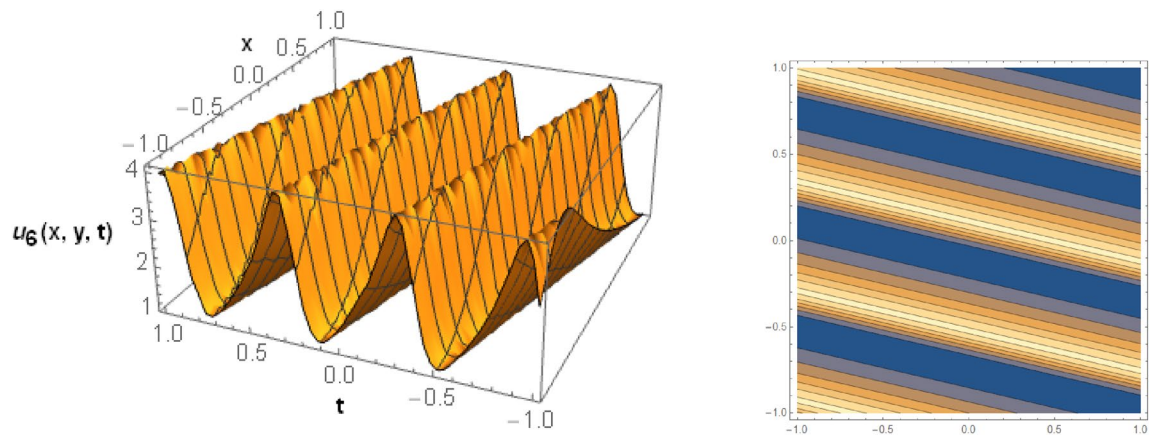

Figure 6. The plots u_6 for the values of constants $\delta_0 = 1, \delta_1 = 1.9, \delta_2 = 5.1, \rho = 2.9, \tau = 1.8, \chi = 1.9, y = 1$ and $H = G = 2$.

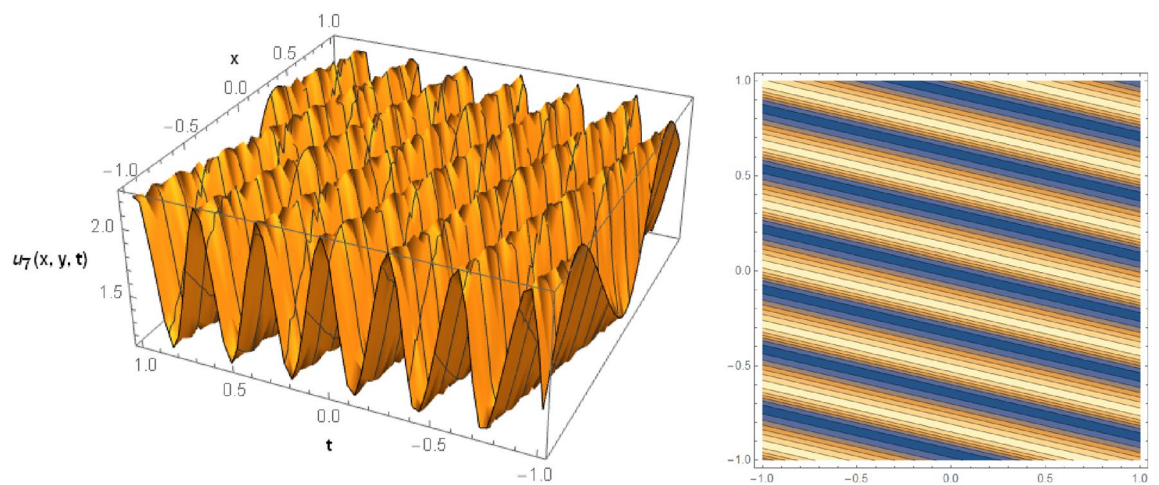

Figure 7. The plots u_7 for the values of constants $\delta_0 = 1, \delta_1 = 1.9, \delta_2 = 5.1, \rho = 2.9, \tau = 1.8, \chi = 1.9, y = 1$, and $H = G = 2$.

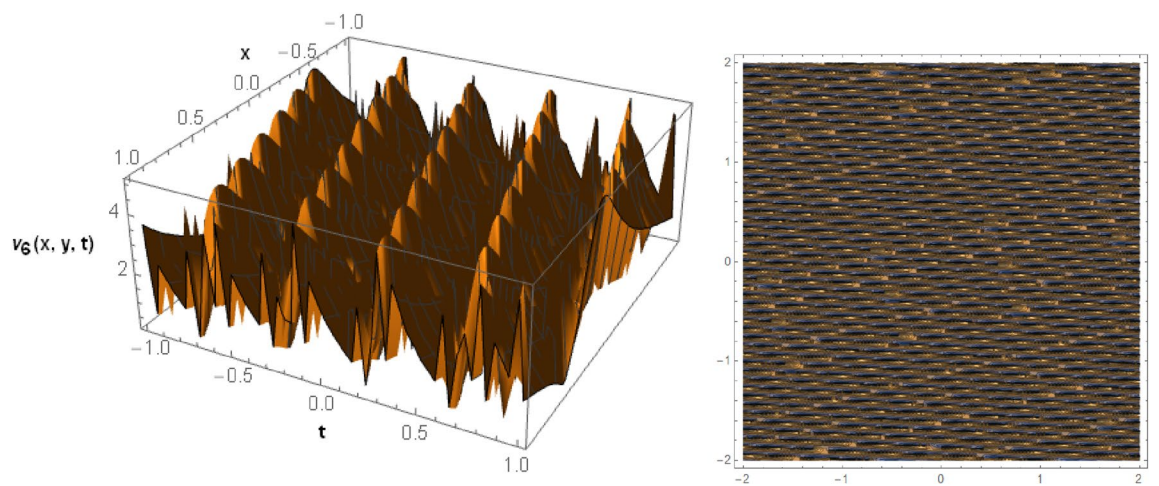

Figure 8. The plots v_6 for the values of constants $c = 2.1, \rho = 2.9, \sigma = 1.9, \sigma_0 = 1.2, \sigma_1 = 0.9, \tau = 1.8, \chi = 1.9, y = 1, H = G = 3$.

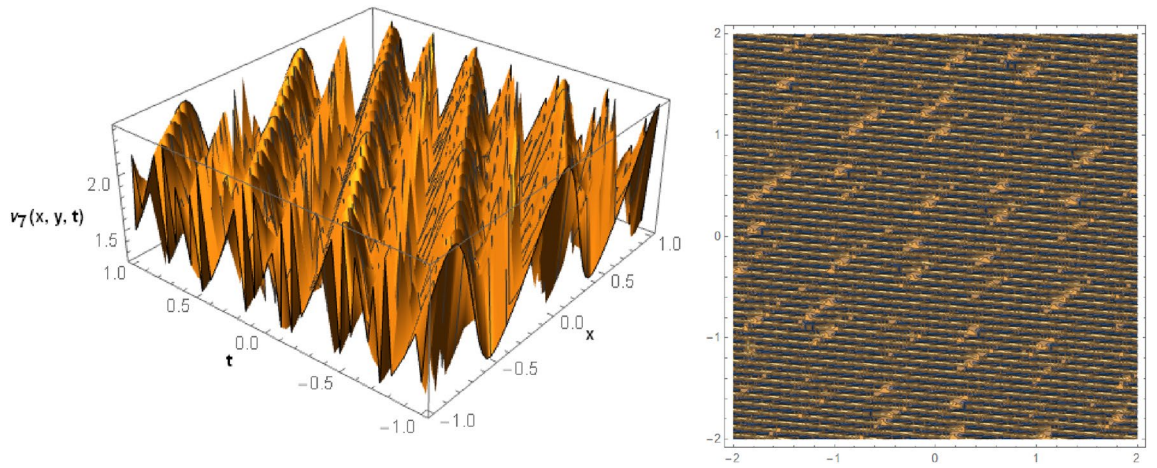

Figure 9. The plots v_7 for the values of constants $c = 1.1, \rho = 2.9, \sigma = 1.9, \sigma_0 = 1.2, \sigma_1 = 0.9, \tau = 1.8, \chi = 1.9, y = 1,$ and $H = G = 3.$

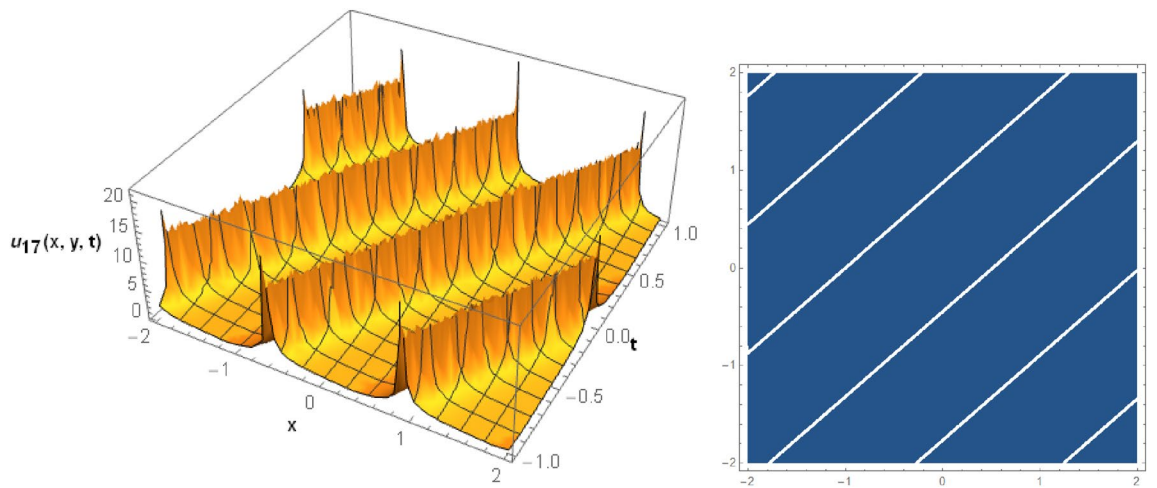

Figure 10. The plots u_{17} for the values of constants $\delta_0 = 2.1, \delta_1 = 0.009, \delta_2 = 1.1, \rho = 1.9, \tau = 1.8, \chi = 2.9,$ and $y = 1.$

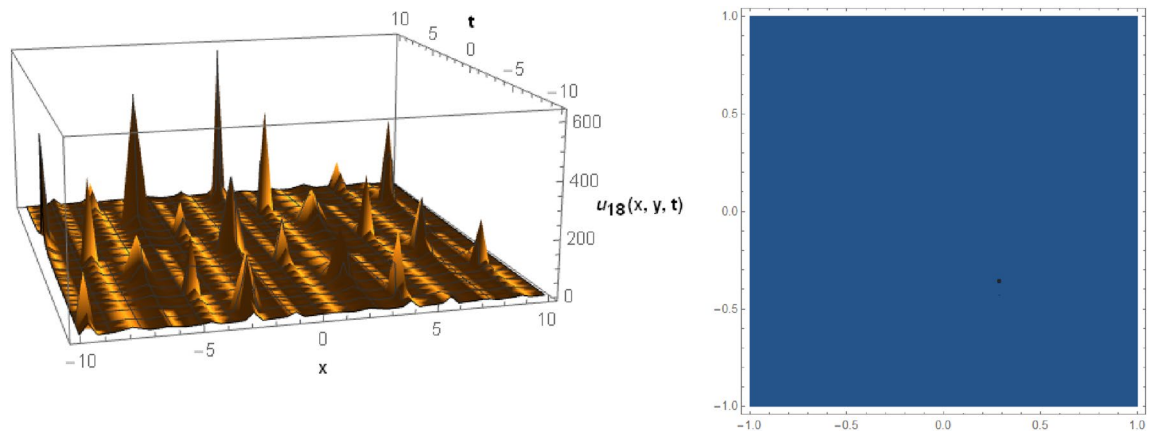

Figure 11. The plots u_{18} for the values of constants $\delta_0 = 2.2, \delta_1 = 2.9, \delta_2 = 1.1, \rho = 0.09, \tau = 1.8, \chi = 1.9, y = 1,$ and $H = G = 3.$

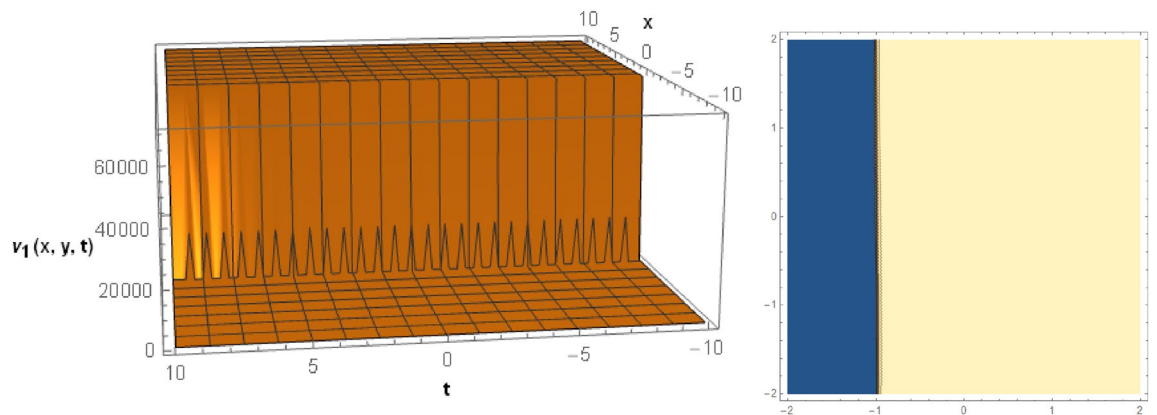

Figure 12. The plots v_1 for the values of constants $c = 0.00001$, $\rho = 3$, $\sigma = 0.9$, $\sigma_0 = 0.01$, $\sigma_1 = 1.9$, $\tau = 0.8$, $\chi = 1.09$, and $y = 1$.

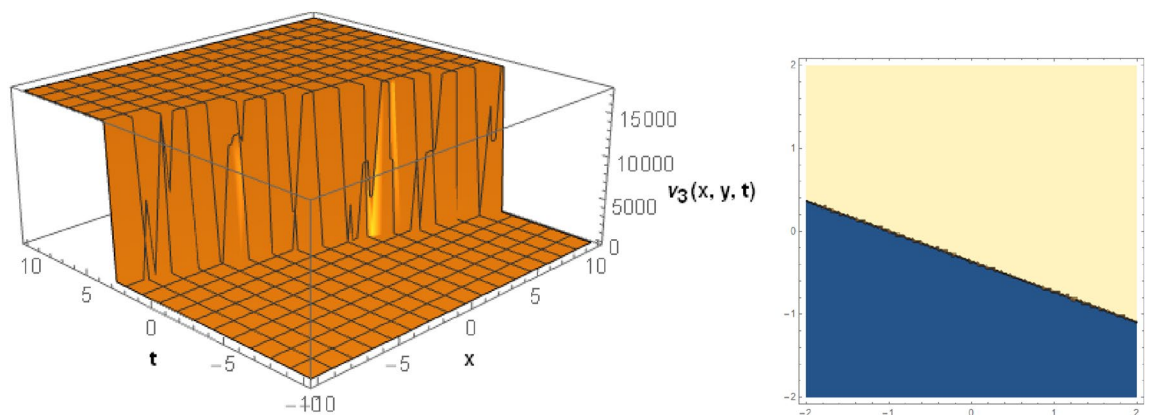

Figure 13. The plots v_3 for the values of constants $c = 0.01$, $\rho = 3$, $\sigma = 0.9$, $\sigma_0 = 0.02$, $\sigma_1 = 1.9$, $\tau = 0.8$, $\chi = 1.09$, and $y = 1$.

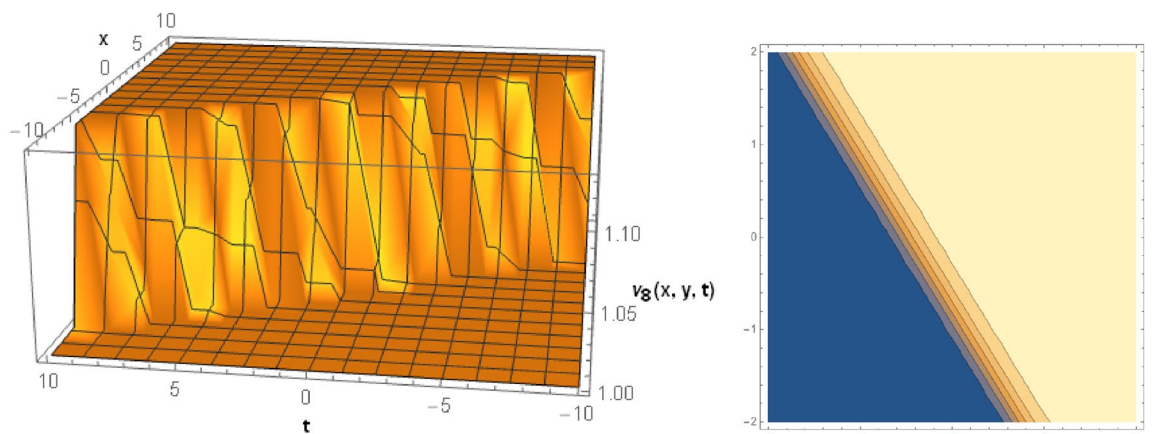

Figure 14. The plots v_8 for the values of constants $c = 0.01$, $\rho = 2.9$, $\sigma = 1.9$, $\sigma_0 = 0.02$, $\sigma_1 = 0.09$, $\tau = 1.8$, $\chi = 1.9$, and $y = 1$.

solitons using the range of space and temporal parameters $[-2, 2]$ and $[-10, 10]$ respectively. The Figs. 12, 13, 14 and 15 are plotted for the range of space and temporal parameters $[-10, 10]$.

Conclusions

In this study, we find the analytical wave solutions for the Lengyel-Epstein reaction–diffusion system. The reaction–diffusion The Lengyel-Epstein model represents the concentration of the inhibitor chlorite and the activator iodide, respectively. These concentrations of the inhibitor chlorite and the activator iodide are shown in the form

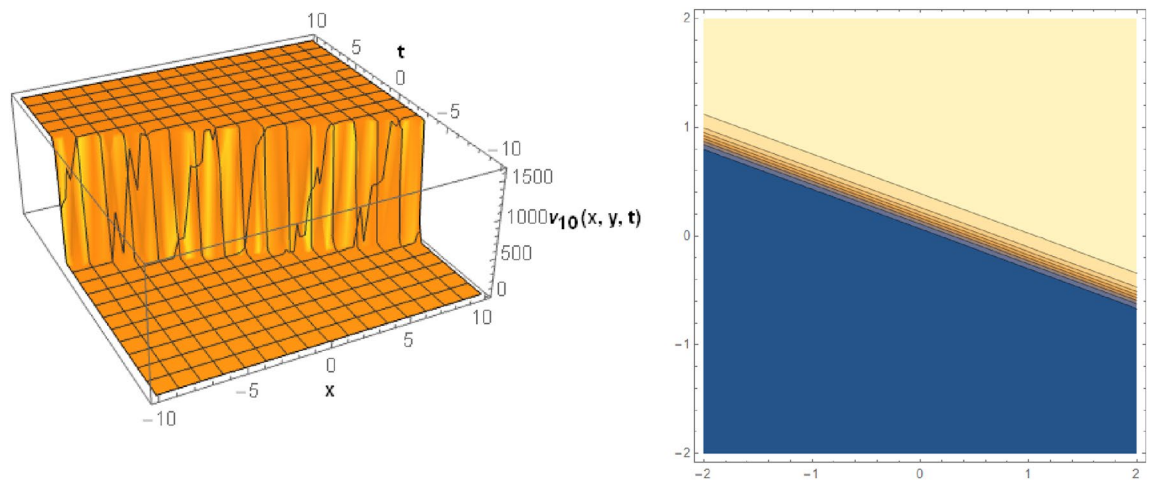

Figure 15. The plots v_{10} for the values of constants $c = 0.1$, $\rho = 4.9$, $\sigma = 1.9$, $\sigma_0 = 0.02$, $\sigma_1 = 0.9$, $\tau = 0.08$, $\chi = 0.9$ and $y = 1$.

of wave solutions. The generalized Riccati equation mapping method is used to find the analytical solutions. The Generalized Riccati Equation Mapping (GREM) method is a powerful analytical technique for solving a wide range of differential equations, particularly nonlinear ones. The shock, complicated solitary-shock, shock singular, and periodic-singular wave solutions are seen for both single and mixed wave solutions. The derivation also leads to reasonable solutions. Solitary waves in the Lengyel-Epstein system can spread at different rates. The balance between a system's diffusive and reactive effects typically controls how quickly a single wave travels. Depending on the variables and the kinetics of the response, solitary waves can move at a variety of speeds. Many physical significances are explained by sketching some three-dimensional diagrams and their corresponding contours for the acquired solutions. These figures give us a better understanding of the behavior of these solutions. These results are very helpful in the dynamic study of this chemical reaction model.

Data availability

The datasets used and/or analysed during the current study available from the corresponding author on reasonable request.

Received: 4 October 2023; Accepted: 10 November 2023

Published online: 16 November 2023

References

1. Fan, E. & Zhang, J. Applications of the Jacobi elliptic function method to special-type nonlinear equations. *Phys. Lett. A* **305**(6), 383–392 (2002).
2. Malwe, B. H., Betchewe, G., Doka, S. Y. & Kofane, T. C. Travelling wave solutions and soliton solutions for the nonlinear transmission line using the generalized Riccati equation mapping method. *Nonlinear Dyn.* **84**, 171–177 (2016).
3. Biazar, J., Asadi, M. A. & Salehi, F. Rational Homotopy Perturbation Method for solving stiff systems of ordinary differential equations. *Appl. Math. Model.* **39**(3–4), 1291–1299 (2015).
4. Yao, S. W. *et al.* Extraction of soliton solutions for the time-space fractional order nonclassical Sobolev-type equation with unique physical problems. *Results Phys.* **45**, 106256 (2023).
5. Seadawy, A. R. *et al.* Soliton behavior of algae growth dynamics leading to the variation in nutrients concentration. *J. King Saud Univ. Sci.* **34**(5), 102071 (2022).
6. Salman, F., Raza, N., Basendwah, G. A. & Jaradat, M. M. Optical solitons and qualitative analysis of nonlinear Schrödinger equation in the presence of self steepening and self frequency shift. *Results Phys.* **39**, 105753 (2022).
7. Wazwaz, A. M. The tanh method for traveling wave solutions of nonlinear equations. *Appl. Math. Comput.* **154**(3), 713–723 (2004).
8. Li, Y., & Tian, S. F. Inverse scattering transform and soliton solutions of an integrable nonlocal Hirota equation. *Commun. Pure Appl. Anal.* **21**(1), (2022).
9. Shakeel, M., Alaoui, M. K., Zidan, A. M., & Shah, N. A. Closed form solutions for the generalized fifth-order KDV equation by using the modified exp-function method. *JOES*, (2022).
10. Yin, Y. H., Lü, X. & Ma, W. X. Bäcklund transformation, exact solutions and diverse interaction phenomena to a (3+ 1)-dimensional nonlinear evolution equation. *Nonlinear Dyn.* **108**(4), 4181–4194 (2022).
11. Iqbal, M. S., Seadawy, A. R., Baber, M. Z., Yasin, M. W. & Ahmed, N. Solution of stochastic Allen–Cahn equation in the framework of soliton theoretical approach. *Int. J. Mod. Phys. B* **37**(06), 2350051 (2023).
12. Zhou, T. Y., Tian, B., Chen, Y. Q. & Shen, Y. Painlevé analysis, auto-Bäcklund transformation and analytic solutions of a (2+ 1)-dimensional generalized Burgers system with the variable coefficients in a fluid. *Nonlinear Dyn.* **108**(3), 2417–2428 (2022).
13. Akram, G., Sadaf, M. & Zainab, I. The dynamical study of Biswas–Arshed equation via modified auxiliary equation method. *Optik* **255**, 168614 (2022).
14. Ghanbari, B. & Gómez-Aguilar, J. F. Optical soliton solutions for the nonlinear Radhakrishnan–Kundu–Lakshmanan equation. *Mod. Phys. Lett. B* **33**(32), 1950402 (2019).
15. Ghanbari, B. & Gómez-Aguilar, J. F. New exact optical soliton solutions for nonlinear Schrödinger equation with second-order spatio-temporal dispersion involving M-derivative. *Mod. Phys. Lett. B* **33**(20), 1950235 (2019).
16. Ghanbari, B. & Baleanu, D. New optical solutions of the fractional Gerdjikov–Ivanov equation with conformable derivative. *Front. Phys.* **8**, 167 (2020).

17. Khater, M. & Ghanbari, B. On the solitary wave solutions and physical characterization of gas diffusion in a homogeneous medium via some efficient techniques. *Eur. Phys. J. Plus* **136**(4), 1–28 (2021).
18. Ghanbari, B. Abundant soliton solutions for the Hirota–Maccari equation via the generalized exponential rational function method. *Modern Mod. Phys. Lett. B* **33**(09), 1950106 (2019).
19. Ghanbari, B., Baleanu, D. & Al Qurashi, M. New exact solutions of the generalized Benjamin–Bona–Mahony equation. *Symmetry* **11**(1), 20 (2018).
20. Ghanbari, B. & Akgül, A. Abundant new analytical and approximate solutions to the generalized Schamel equation. *Phys. Scr.* **95**(7), 075201 (2020).
21. Ghanbari, B. & Kuo, C. K. New exact wave solutions of the variable-coefficient (1+ 1)-dimensional Benjamin–Bona–Mahony and (2+ 1)-dimensional asymmetric Nizhnik–Novikov–Veselov equations via the generalized exponential rational function method. *Eur. Phys. J. Plus* **134**(7), 334 (2019).
22. Ghanbari, B. & Baleanu, D. New solutions of Gardner’s equation using two analytical methods. *Front. Phys.* **7**, 202 (2019).
23. Turing, A. M. & Brooker, R. *Programmers’ Handbook for the Manchester Electronic Computer Mark II* (University of Manchester, 1952).
24. Castets, V., Dulos, E., Boissonade, J. & De Kepper, P. Experimental evidence of a sustained standing Turing-type nonequilibrium chemical pattern. *Phys. Rev. Lett.* **64**(24), 2953 (1990).
25. Ni, W. M. & Tang, M. Turing patterns in the Lengyel–Epstein system for the CIMA reaction. *Trans Am Math Soc.* **357**(10), 3953–3969 (2005).
26. Mahdy, A. M. Stability, existence, and uniqueness for solving fractional glioblastoma multiforme using a Caputo–Fabrizio derivative. *Math. Methods Appl. Sci.* (2023).
27. Khader, M. M., Sweilam, N. H. & Mahdy, A. M. S. Two computational algorithms for the numerical solution for system of fractional differential equations. *Arab J. Math. Sci.* **21**(1), 39–52 (2015).
28. Mahdy, A. M. Numerical solutions for solving model time-fractional Fokker–Planck equation. *Numer. Methods Partial Differ. Equ.* **37**(2), 1120–1135 (2021).
29. Mahdy, A. M., Amer, Y. A. E., Mohamed, M. S. & Sobhy, E. General fractional financial models of awareness with Caputo–Fabrizio derivative. *Adv. Mech. Eng.* **12**(11), 1687814020975525 (2020).
30. Gepreel, K. A. & Mahdy, A. M. Algebraic computational methods for solving three nonlinear vital models fractional in mathematical physics. *Open Phys.* **19**(1), 152–169 (2021).
31. Mahdy, A. M. S. *et al.* Numerical solution and dynamical behaviors for solving fractional nonlinear Rubella ailment disease model. *Results Phys.* **24**, 104091 (2021).
32. Mahdy, A. M., Lotfy, K. & El-Bary, A. A. Use of optimal control in studying the dynamical behaviors of fractional financial awareness models. *Soft Computing* **26**(7), 3401–3409 (2022).
33. Yi, F., Wei, J. & Shi, J. Diffusion-driven instability and bifurcation in the Lengyel–Epstein system. *Nonlinear Anal. Real World Appl.* **9**(3), 1038–1051 (2008).
34. Lisená, B. On the global dynamics of the Lengyel–Epstein system. *Appl. Math. Comput.* **249**, 67–75 (2014).
35. Yi, F., Wei, J. & Shi, J. Global asymptotical behavior of the Lengyel–Epstein reaction–diffusion system. *Appl. Math. Lett.* **22**(1), 52–55 (2009).
36. Shoji, H. & Ohta, T. Computer simulations of three-dimensional Turing patterns in the Lengyel–Epstein model. *Phys. Rev. E.* **91**(3), 032913 (2015).
37. Ouannas, A., Wang, X., Pham, V. T., Grassi, G. & Huynh, V. V. Synchronization results for a class of fractional-order spatiotemporal partial differential systems based on fractional Lyapunov approach. *Bound. Value Probl.* **2019**(1), 1–12 (2019).
38. Kayan, S. & Merdan, H. An algorithm for Hopf bifurcation analysis of a delayed reaction–diffusion model. *Nonlinear Dyn.* **89**, 345–366 (2017).
39. Mansouri, D., Abdelmalek, S. & Bendoukha, S. Bifurcations and pattern formation in a generalized Lengyel–Epstein reaction–diffusion model. *Chaos Solit. Fractals* **132**, 109579 (2020).
40. Zhu, S. D. The generalizing Riccati equation mapping method in non-linear evolution equation: Application to (2+ 1)-dimensional Boiti–Leon–Pempinelle equation. *Chaos Solit. Fractals* **37**(5), 1335–1342 (2008).
41. Naher, H. & Abdullah, F. A. The modified Benjamin–Bona–Mahony equation via the extended generalized Riccati equation mapping method. *Appl. Math. Sci.* **6**(111), 5495–5512 (2012).
42. Yasin, M. W. *et al.* Numerical scheme and analytical solutions to the stochastic nonlinear advection diffusion dynamical model. *Int. J. Nonlinear Sci. Numer.* **24**(2), 467–87 (2021).
43. Younis, M. *et al.* Nonlinear dynamical study to time fractional Dullian–Gottwald–Holm model of shallow water waves. *Int. J. Mod. Phys. B* **36**(01), 2250004 (2022).
44. Naher, H., & Abdullah, F. A. New Traveling Wave Solutions by the Extended Generalized Riccati Equation Mapping Method of the-Dimensional Evolution Equation. *J. Appl. Math.* (2012).
45. Du, L. & Wang, M. Hopf bifurcation analysis in the 1-D Lengyel–Epstein reaction–diffusion model. *J. Math. Anal. Appl.* **366**(2), 473–485 (2010).
46. Merdan, H. & Kayan, S. Hopf bifurcations in Lengyel–Epstein reaction–diffusion model with discrete time delay. *Nonlinear Dyn.* **79**, 1757–1770 (2015).

Acknowledgements

The authors would like to extend their sincere appreciation to the Researcher supporting program at King Saud University, Riyadh, for funding this work under project number (RSPD2023R699).

Author contributions

N.A. and M.Z.B. and M.S.I. and A.A. wrote the main manuscript text and S.M.A. and M.A. and A.A. and S.M.E.D. prepared Figs. 1, 2, 3, 4, 5, 6, 7 and 8. All authors reviewed the manuscript.

Competing interests

The authors declare no competing interests.

Additional information

Correspondence and requests for materials should be addressed to A.A.

Reprints and permissions information is available at www.nature.com/reprints.

Publisher’s note Springer Nature remains neutral with regard to jurisdictional claims in published maps and institutional affiliations.



Open Access This article is licensed under a Creative Commons Attribution 4.0 International License, which permits use, sharing, adaptation, distribution and reproduction in any medium or format, as long as you give appropriate credit to the original author(s) and the source, provide a link to the Creative Commons licence, and indicate if changes were made. The images or other third party material in this article are included in the article's Creative Commons licence, unless indicated otherwise in a credit line to the material. If material is not included in the article's Creative Commons licence and your intended use is not permitted by statutory regulation or exceeds the permitted use, you will need to obtain permission directly from the copyright holder. To view a copy of this licence, visit <http://creativecommons.org/licenses/by/4.0/>.

© The Author(s) 2023