



Quantitative Prediction of Air Entrainment Defects in Casting Filling Process

Yajun Yin ^{a,*}, Yao Xie ^b, Yingchen Song ^a, Xu Shen ^a, Xiaoyuan Ji ^a, Jianxin Zhou ^a

^a Huazhong University of Science and Technology, China

^b State Key Laboratory of Special Rare Metal Materials, China

* Corresponding author: E-mail address: yinyajun436@hust.edu.cn

Received 02.08.2023; accepted in revised form 03.11.2023; available online 22.12.2023

Abstract

Air entrainment defect is a common type of defect in the casting process, which will seriously affect the quality of the casting. Numerical simulation technology can predict the occurrence of casting defects according to the evolution law of liquid metal in the process of filling and solidification. The simulation of air entrainment process is a hot and difficult issue in the field of numerical simulation. The evolution law of air entrainment and the tracking of induced bubbles in the process of metal filling are still lacking. So is the quantitative prediction of entrained gas. In this paper, based on the numerical simulation software of Inte CAST, this paper proposes an algorithm for air entrainment search and tracking, which is used to develop a quantitative prediction system for air entrainment. The feasibility of the system is verified through the simulation calculation of the typical test pieces of the air entrainment and the prediction of air entrainment defects of the casting in the process of filling is obtained through the simulation calculation of the actual casting, which can provide a certain guiding role for the optimization of the process in the production practice.

Keywords: Casting, Numerical simulation, Gas entrainment defect, Filling process

1. Introduction

Air entrainment defect is a kind of defect that often occurs in the casting process, which will have a great impact on the performance of the casting. During the filling process, due to the high flow rate of the liquid metal, jets and splashes often occur, and the liquid metal will roll or convect, which will cause a large amount of gas in the cavity to be entrained into the liquid metal. If the gas entrained by the liquid metal cannot be discharged in time, the gas will remain inside the metal, forming an entrained gas defect [1]. At present, people have done a lot of research on the formation mechanism of entrained air and the prediction of entrained air defects in castings [2-4], but the quantitative prediction of entrained air in the metal mold filling process is still lacking [5]. Accurately predicting the amount of entrained gas during the metal filling process is of great significance for in-

depth understanding of the formation and movement mechanism of entrained gas, accurate prediction of pore defects caused by entrained gas during the filling process, and accurate prediction of oxidation inclusions and other defects during the filling process.

Aiming at the numerical simulation and prediction of entrained gas defects, many experts and scholars at home and abroad have done related research and obtained a lot of research results. Chen Yunxiang et.al [6] established a gas entrainment defect prediction model based on gas phase tracking and bubble breakage criteria. Bi Cheng et.al [2] established a numerical simulation model of the filling process considering surface tension in the die-casting filling process, and modeled the evolution process of gas entrapment based on surface tension as the main judgment basis. Caboussat et.al [7] proposed a fragmentation criterion for gas bubbles within the fluid and performed simulations for defect prediction, which showed that the bubbles involved in the metal fluid have a significant effect on



the liquid-gas free surface shape. Kimatsuka et.al [8] used gas conservation to construct equations to simulate the distribution of bubbles during the filling process. The accuracy of the model was confirmed by comparing it with conventional experimental results. Yang et.al [9] developed an oxide film entrapment tracking algorithm for numerical modeling of liquid aluminum flow and motion, folding, and oxide film entrapment during mold filling of aluminum castings. Dai et.al [10] proposed a free-surface folding method for predicting the timing of the occurrence of volume gas. Critical velocity was used as a criterion for the occurrence of cirrus. Reilly et.al [11-12] proposed a method to determine whether free surface meshes collide with each other in conjunction with a free surface transport algorithm and used it to predict the location of cirrus. Majidi et.al [13] developed a model for predicting the rate of localized air entrainment on the free surface and implemented the model in a casting filling simulation program. Cao Liu et.al [14] simulated gas entrapment defects in zinc alloys during high-pressure die casting based on a gas-liquid multiphase flow model and compared rolled gas defects based on simulation and experimental results.

Many studies have been done on the formation mechanism of air rolls and the prediction of air roll defects in castings, and a large number of validation experiments have been carried out, and fruitful research results have been achieved. However, most of the current research is aimed at the establishment of the air roll model, the criteria for the occurrence of air roll defects and the prediction of the location of air roll defects, etc., and the quantitative prediction of air rolls in the metal filling process is still lacking. In this study, we propose to develop a quantitative air roll prediction system based on Inte CAST, to understand the formation principle of casting air roll defects and make accurate prediction of them, so as to provide guidance for production practice.

2. Research on Core Algorithm of Air Entrainment Quantitative Prediction System

2.1. Realization of the core algorithm of the air entrainment prediction system

The core algorithm of the air entrainment prediction system uses an array to implement a tree-shaped data structure. After being optimized by rank merging and path compression algorithms, each element stores two data, one is the root node of the element, and the other is the rank of the element.

The core algorithm steps of the air entrainment prediction system are as follows:

- (1) Initialize, define an array to store the root node of each element, which is the element itself during initialization, and this operation is only performed once;
- (2) Query, searching for the root node of the element;
- (3) Merging, merging two disjoint sets into one set, sharing a root node.

At the beginning, assuming that there are m elements, first initialize the number for each element, the number is $1-m$, and

this number is the root node of the element. After initialization, the root node of each element is the element itself, that is, each element is a separate collection. Then, according to the rules of adjacent elements, the elements belonging to the same set are merged. To merge two collections, set the root node of one collection as the root node of one collection, and then the two tree-structured collections can be merged. When judging whether two elements are in the same collection, it is only necessary to judge whether the root nodes of the two elements are the same.

At the same time, in order to improve the query efficiency, the collection is compressed by path compression and rank merging technology, which greatly improves the search efficiency in the next query. The flowchart of the algorithm solution is shown in Figure. 1:

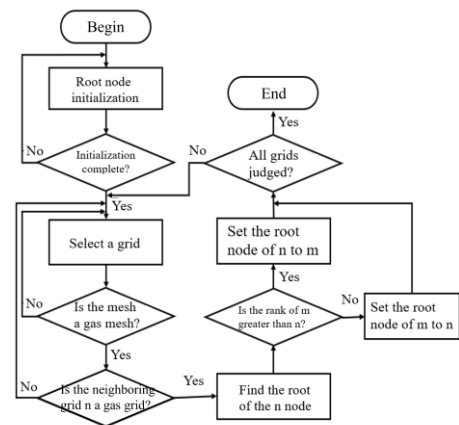

Fig. 1. Flow chart of the algorithm of the air entrainment prediction system

2.2. Liquid-phase connectivity domain search for volume air entrainment prediction systems

Before searching for isolated gas-connected connected domains in the flow field, it is necessary to verify the correctness of the written marking algorithm for the connected domains in the casting filling process. In the Inte CAST, the number and coordinates of the isolated liquid phase connected domains are displayed, so the search algorithm for the isolated liquid phase connected domain can be written first and compared with the Inte CAST to verify the correctness of the written algorithm.

When searching for isolated gas-connected communication domains, S-shaped castings that are prone to gas entrapment are usually used for testing. In this paper, S-shaped test pieces are also selected for program inspection. The dimensions of the test pieces are shown in Figure 2 (unit: mm). Filling with 20 steel metal liquid. Among them, the molten metal is filled from the bottom inlet upwards, and it will be curled and folded at the corner of the channel, resulting in obvious gas entrapment. In this paper, the flow field file at a certain moment in the filling process of the S-shaped test piece is selected for testing, and the number and coordinates of the isolated liquid phase connected domains at this moment are found.

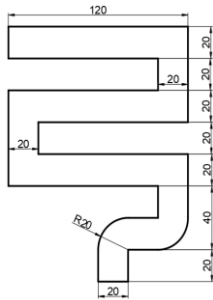

Fig. 2. S-shaped test piece size (Unit : mm)

Carry out the simulation calculation of the filling process for the test piece, select a moment in the filling process, judge the isolated liquid phase connected domain, and output the number and coordinates of the isolated liquid phase connected domain. The program operation results are compared with Inte CAST as follows:

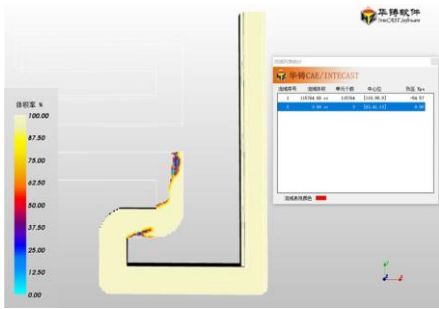

Fig.3: A moment in the filling process (Pouring duration 0.30 seconds)

Table 1. Operation results of search program for isolated liquid phase connected area (partial)

Number of isolated liquid phase regions: 2	
Grid clique coordinates (x, y, z) of isolated liquid phase region 1:	Grid clique coordinates (x, y, z) of the isolated liquid phase region 2:
Coordinates: 61 6 1	Coordinates: 83 41 13
Coordinates: 61 6 2	Coordinates: 83 41 14
Coordinates: 61 6 3	Coordinates: 84 41 14
Coordinates: 61 6 4	
Coordinates: 61 6 5	
Coordinates: 61 6 6	
...	
Coordinates: 119 99 8	
Coordinates: 119 99 9	
Coordinates: 119 99 10	
Coordinates: 119 99 13	
...	
Coordinates: 178 198 8	
Coordinates: 178 198 9	
Coordinates: 178 198 10	
Coordinates: 178 198 11	
Coordinates: 178 198 12	
Coordinates: 178 198 13	

From Figure 3 that, according to the statistical function of the watershed list of Inte CAST, it is concluded that there are two isolated liquid phase connected domains in the casting cavity at this moment, and the center position coordinates of each connected domain and the number of cells contained in each connected domain, that is, the number of grids, are given. Among them, the No. 2 watershed contains three grid units, and the coordinates of the center are (83, 41, 13). According to the program running results shown in Table 1, the second isolated liquid-connected domain has three grids, and the coordinates are also correct. Watershed No. 1 contains a large number of grid cells, and only some of the grid coordinates are listed in Table 1. After inspection, the grid number and coordinates output by the program are correct. From the above comparison, it can be seen that the number and coordinates of the isolated liquid phase connected domains searched by the connected domain marking algorithm in the casting filling process written in this paper are correct, which verifies the correctness of the connected domain marking algorithm in the casting filling process in this paper.

2.3. Searching for gas phase connected domains in the air entrainment prediction system

After correctly searching for isolated liquid-phase connected domains, the program can be modified to search for isolated gas-phase connected domains. The test piece is still selected for the simulation calculation of the filling process, and the filling process time shown in Figure 3 is selected to judge the isolated gas-phase connected domain and output the number and coordinates of the isolated gas-phase connected domain, and the number of isolated gas-phase areas is calculated to be 49. The program operation results are shown in Table 2.

Table 2. Operation results of search program for isolated gas phase connected area (partial)

Number of isolated gas phase regions: 49	
Grid clique coordinates (x, y, z) of isolated gas phase zone 1:	Grid clique coordinates (x, y, z) of the isolated liquid phase region 32:
Coordinates: 1 80 1	Coordinates: 81 40 6
Coordinates: 1 80 2	Coordinates: 81 40 7
Coordinates: 1 80 3	Coordinates: 81 40 8
Coordinates: 1 80 4	...
Coordinates: 1 80 5	Grid clique coordinates (x, y, z) of the isolated liquid phase region 40:
Coordinates: 1 80 6	Coordinates: 97 47 9
Coordinates: 1 80 7	Coordinates: 98 47 9
Coordinates: 1 80 8	Coordinates: 99 47 8
Coordinates: 1 80 9	Coordinates: 99 47 9
Coordinates: 1 80 10	
Coordinates: 1 80 11	
...	Grid clique coordinates (x, y, z) of the isolated liquid phase region 49:

Coordinates: 117 87 12
 Coordinates: 117 88 12
 Coordinates: 117 89 12
 Coordinates: 117 90 12

From the running results of the search program for isolated gas-connected domains shown in Table 2, it can be seen that when the casting is filled up to this moment, the mold contains a total of 49 isolated gas-connected domains, and a large number of fine air bubbles are involved.

2.4. Searching for the missing gas phase connected domain of the air entrainment prediction system

Since the Inte CAST uses single-phase flow simulation, it considers the cavity part wrapped by the molten metal to be a vacuum and does not calculate the pressure and movement trend of the gas involved, so the cavity will gradually disappear in the molten metal during subsequent calculations. Therefore, it is necessary to compare the files of the two time periods before and after, and search for the disappearing isolated gas phase connection domain.

In order to correct this point, it is necessary to find out the disappearing isolated gas connection domain at first. The basic idea is to first find the isolated gas phase connected domain in the flow field file at the previous moment, and store and record it, and then read the flow field file at the next time moment to judge whether the grid where the isolated gas phase connected domain in the file at the previous moment is located is filled at the next moment. If it is filled, it is considered that the isolated gas-connected domain has disappeared, and the disappeared isolated gas-connected domain needs to be recorded; if it is not filled, it is considered that the isolated gas-connected domain still exists, and it will not be processed temporarily.

Still select the test piece for the simulation calculation of the filling process and find the typical moment when the entrained gas is filled during the filling process. As shown in Figure 4, the pouring duration of the previous flow file is 0.30 seconds and the pouring duration of the next flow file is 0.32 seconds. Search the two files separately by writing the search algorithm for connected domains in the casting process and find out the isolated gas-phase connected domains that disappear without reason by comparing the two files and output the number and coordinates of the gas-phase connected domains. The program operation results are shown in Table 3:

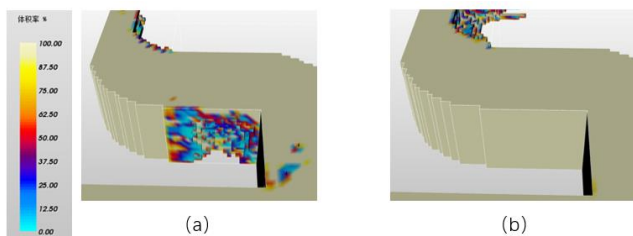

Fig.4. The disappearance process of the entrained gas

Table 3 lists the search results of two vanishing isolated gas-connected domains (No. 1 and No. 28), and lists some grid coordinates contained in these two connected domains, as follows:

Table 3.

Operation results of domain search procedure for disappeared isolated gas connection (partial)

Coordinates (x, y, z) of the disappearing isolated gas connection domain 1:	28 coordinates (x, y, z) of the disappearing isolated gas phase communication domain:
Coordinates: 71 33 6	Coordinates: 81 40 6
Coordinates: 72 31 6	Coordinates: 81 40 7
Coordinates: 72 31 7	Coordinates: 81 40 8
Coordinates: 72 32 6	Coordinates: 81 40 9
Coordinates: 72 32 7	Coordinates: 81 41 8
Coordinates: 72 33 6	Coordinates: 81 41 9
Coordinates: 72 33 7	Coordinates: 81 42 9
Coordinates: 72 34 6	Coordinates: 81 42 10
Coordinates: 72 34 7	Coordinates: 81 42 11
Coordinates: 72 35 6	Coordinates: 81 43 9
...	...

3. Realization of Quantitative Air Entrainment Prediction System

3.1. Grid data of the original isolated gas phase connected domain

The Inte CAST uses a single-phase flow model and does not consider the gas involved in the molten metal filling simulation process. Therefore, at the last moment of filling, the casting is completely filled. In the last chapter, by comparing the flow field files at the two moments before and after, it was found that the isolated gas phase connection domain that disappeared during the filling process was not considered because the velocity and pressure of the gas involved were not considered. For this disappearing isolated gas-phase connected domain, it needs to be retained in the flow field file at the next moment, so as to predict the location of the gas entrainment defect, so the flow field file should be corrected.

Firstly, the grid data of the disappearing isolated gas-phase connected domain is corrected, and the grid of the isolated liquid-phase connected domain is filled at a later moment, so the grid of this region should be reset to the gas-phase region at the later moment. According to the data structure, the data in each grid includes not only the filling state data, but also the velocity and pressure values in the three directions of X, Y, and Z, so the velocity and pressure values in the three directions of the grid in this area need to be reset to 0.

Still taking the S-shaped test piece as an example, find the typical moment when the gas involved in the mold filling process is fully filled. The pouring duration at the previous filling moment is 0.30 seconds, and the pouring duration at the next filling moment is 0.32 seconds, and the grid data of the disappearing

isolated gas phase connection domain is modified. The modified flow field file data at the next moment is displayed on the Inte CAST as shown in Figure 5:

From Figure 5 that after the core algorithm of the gas entrainment prediction system is used to search for the isolated gas-connected domain and the flow field file is modified, the unconsidered disappearing entrained gas can be retained for subsequent prediction of gas entrainment defects.

As can be clearly observed in Fig. 5, the core algorithm of the convoluted gas prediction system successfully achieves the detection and identification of the isolated gas-phase connected domains and further makes the necessary modifications to the flow field file. The importance of this critical step lies in its ability to effectively retain previously unconsidered involved gases, thus providing a solid foundation for the subsequent prediction of rolled gas defects.

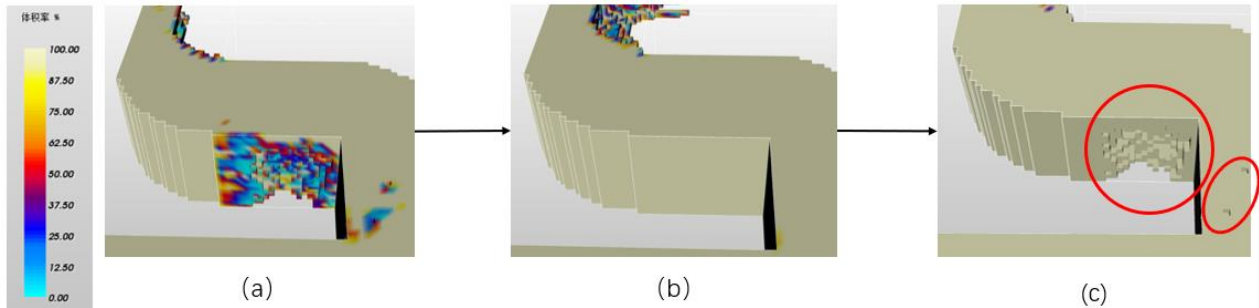

Fig. 5. Schematic diagram of grid data modification in connected domain of disappeared isolated gas (a) the previous moment, (b) the next moment, before modification, (c) the next moment, after modification

3.2. Redistribution of liquid volume in the original isolated gas phase connected domain

Retaining the isolated gas-connected domain that disappeared at the previous moment will cause the liquid volume of the flow field file at the later moment to be different before and after modification, that is, the liquid metal in the grid of the disappeared isolated gas-connected domain is cleared. Therefore, in order to ensure the volume conservation of the liquid metal before and after modification, the volume of the liquid in the previously disappeared isolated gas-phase communication domain should be redistributed.

The distribution strategy adopted in this paper is to evenly distribute this part of the volume of molten metal to the interface grid, that is, to distribute evenly to the front of the molten metal

flow. Therefore, it is necessary to first calculate the value of the original disappearing isolated gas-connected domain grid cluster, then find out the grid of the molten metal flow front, read the grid value of each interface grid and the total number of interface grids, and finally evenly distribute the values of the original disappeared isolated gas-connected domain grid cluster to the interface grid.

Still taking the S-shaped test piece as an example and taking the two adjacent moments shown in Figure 4, the metal liquid corresponding to the original disappearing isolated gas-phase connection domain is distributed to the interface grid, and the flow field file at the next moment is modified. The modified flow field file data is displayed on the Inte CAST, as shown in Figure 6:

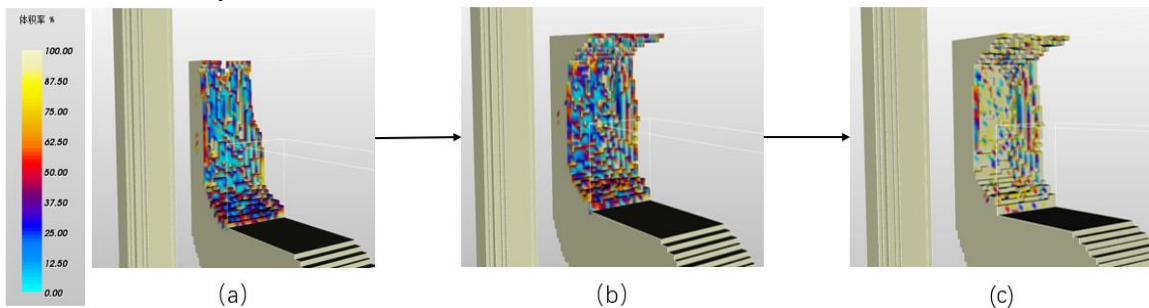

Fig. 6. Schematic diagram of volume redistribution of molten metal (a) Flow interface at the previous moment, (b) Flow interface at the next moment, before modification, (c) Flow interface at the next moment, after modification

From Figure 5 that the molten metal originally filled in the isolated gas-phase communication domain is distributed to the front of the flow interface, which ensures the constant volume of

the molten metal before and after the modification of the flow field file.

3.3. Correction of the speed value of the air entrainment quantitative prediction system

According to the discussion in the previous section, in the process of redistribution of the liquid in the disappearing isolated gas-phase connected domain, the value of the interface grid overflows. The method adopted in this paper is to distribute the overflowed grid data to the grid adjacent to the grid. Then this part of the overflowed grid data may be allocated to a new empty grid. For a new grid, according to the data structure of the flow field file, each casting grid has velocity values and pressure values in three directions in addition to filling state data. Therefore, in addition to modifying the interface grid data, it is also necessary to assign velocity values and pressure values in three directions to the newly filled grids, that is, to correct the velocity values of the gas entrainment quantitative prediction system.

When correcting the velocity value, there are two correction methods for the new grid, one is to find the filled interface grid adjacent to the new grid, and assign the velocity values in three directions of the filled interface grid to the grid; the other is to use the interpolation method to find two or more filled interface grids adjacent to the new grid, and interpolate the new grid according to the velocity values of these grids to obtain the velocity value of the grid. Obviously, it is more accurate to modify the speed value of the new grid by using the interpolation method, that is, the second method, so this paper intends to use the linear interpolation method to modify the speed value of the new grid.

Therefore, the specific operation of speed value correction using linear interpolation is as follows:

- 1) Determine whether the grid receiving overflow grid data is an empty grid.
- 2) If it is not an empty grid, no correction is necessary.
- 3) If it is an empty grid, find two grids adjacent to the grid in three directions, do linear interpolation on the empty grid, and calculate the velocity values in the three directions of the empty grid. The following formula is used to correct the velocity value:

$$V_x = \frac{V_{x+1} - V_{x-1}}{2} \quad (1)$$

$$V_y = \frac{V_{y+1} - V_{y-1}}{2} \quad (2)$$

$$V_z = \frac{V_{z+1} - V_{z-1}}{2} \quad (3)$$

Where: V_x , V_y , V_z are the velocity values of mesh M in x, y, z direction respectively, V_{i+1} , V_{i-1} ($i=x, y, z$) are the velocity values of the neighboring meshes to mesh M in x, y, z direction respectively.

After the above operations, the velocity values in the three directions of the new grid can be corrected more accurately, so that the subsequent calculation and simulation process is more accurate.

3.4 Correction of the pressure value of air entrainment quantitative prediction system

According to the data structure of the flow field file, each casting grid includes not only filling state data and velocity values in three directions, but also pressure values at the grid location. For the correction of the pressure value of the new grid, according to the discussion in Section 3.3, a more accurate interpolation method should still be used for correction. Therefore, the linear interpolation is used to correct the pressure value according to the same method as the correction of the velocity value. Therefore, the specific operation of the correction of the pressure value using linear interpolation is as follows:

- 1) Determine whether the grid receiving overflow grid data is an empty grid.
- 2) If it is not an empty grid, no correction is necessary.
- 3) If it is an empty grid, find two grids adjacent to the grid in three directions, do linear interpolation on the empty grid, and calculate the velocity values in the three directions of the empty grid. The following formula is used to correct the pressure value:

$$P = \frac{P_{x+1} + P_{y+1} + P_{z+1} - (P_{x-1} + P_{y-1} + P_{z-1})}{6} \quad (4)$$

Where: P is the pressure value of grid M, P_{i+1} , P_{i-1} ($i=x, y, z$) are the pressure values of the neighboring grids to grid M, respectively.

After the above operations, the pressure value of the new grid can be corrected more accurately. Since then, the correction of liquid volume, velocity, and pressure values in the gas entrainment quantitative prediction system has been completed, and the recalculation function of Inte CAST can be used to recalculate the modified flow field file to verify the correctness of the algorithm.

4. Verification and Application of Air Entrainment Prediction System

4.1 Verification of air entrainment prediction system

S- shaped test piece that can produce gas entrainment defects, as shown in Figure 1. The number of subdivided grids is 180 in the X direction, 200 in the Y direction, and 20 in the Z direction, and the total number of grids is 720,000. The pouring temperature of the casting is 1580 degrees Celsius, and the initial temperature of the mold is 20 degrees Celsius. Firstly, use the Inte CAST to carry out conventional filling simulation, and observe the movement state of the molten metal during the filling process. The pouring duration of the filling process 1 is 0.23 seconds to 0.33 seconds, and the pouring duration of the filling process 2 is 0.56 seconds to 0.73 seconds, as shown in Figure 7:

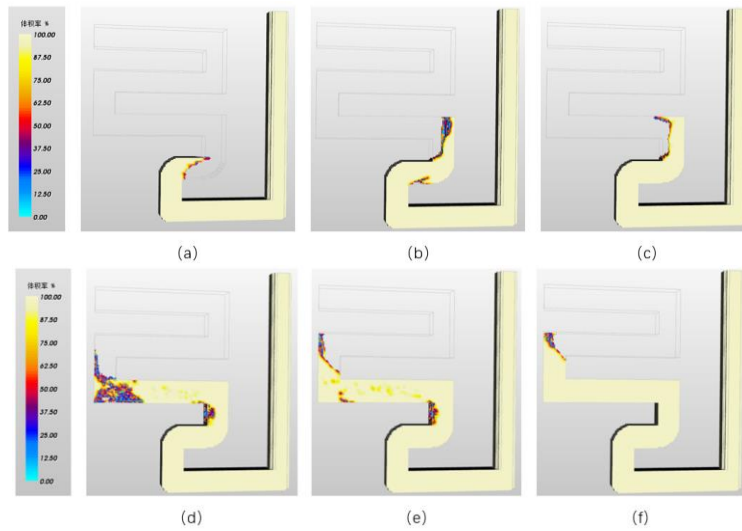

Fig. 7. Partial filling process of S-shaped test piece
(a) (b) (c) filling process 1, (d) (e) (f) filling process 2

From the two filling processes in Figure 7, it can be seen that during the filling process of the S-shaped test piece, a strong gas entrainment phenomenon occurred at the corner of the casting. However, because the Inte CAST uses a single-phase flow model, the entrained gas was not considered during the molten metal filling simulation process. Therefore, it can be seen that as the calculation continues, the gas entrained in the molten metal gradually disappears in the molten metal.

The entrained gas defect prediction system implemented in this paper can search and mark the gas involved in molten metal and keep it. The specific operation is to use Inte CAST continuous calculation function. After the Inte CAST calculates the one-step

flow field file, use this algorithm to compare the two files before and after, find out and retain the gas that disappeared in the molten metal, and correct the velocity value and pressure value at the same time; then continue to calculate based on the modified flow field file, and then use this algorithm to correct after calculating a new flow field file, and so on until the filling is completed. The partial mold filling process after applying the entrainment prediction system is shown in Figure 8. The pouring duration of the filling process 1 is 0.30 seconds to 0.36 seconds, and the pouring duration of the filling process 2 is 0.98 seconds to 1.13 seconds.

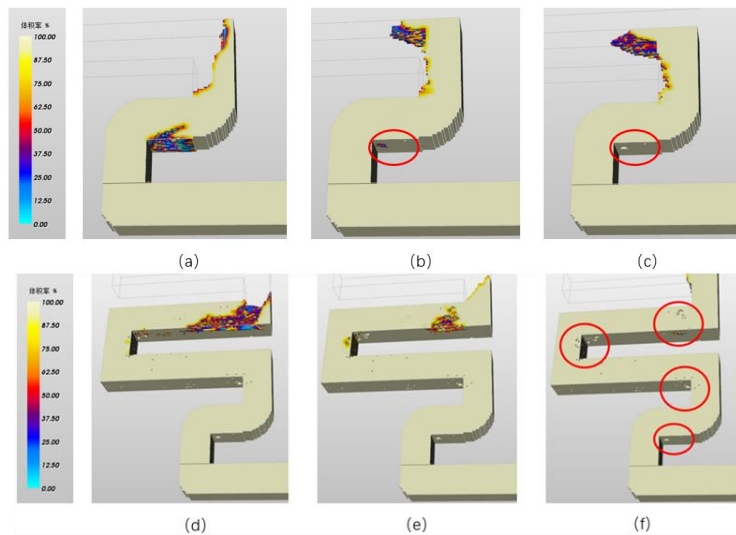

Fig. 8. Partial filling process after application of air entrainment prediction system
(a) (b) (c) filling process 1, (d) (e) (f) filling process 2

From the two mold filling processes in Figure 8, it can be seen that after using the continuous calculation function of Inte CAST to continue the calculation of the flow field file modified by the application of the gas entrapment defect prediction system, the gas involved in the molten metal can be retained in the subsequent calculation process, and the location of the gas entrapment defect can be predicted, thereby providing certain guidance for the prediction of the gas entrapment defect, and also verified the feasibility of the gas entrapment defect prediction system.

4.2 Application of gas entrapment prediction system

In actual production and life, the shape of castings is often complex. In order to further verify the gas entrapment prediction system in the casting process, this paper selects the actual casting—shell to apply the gas entrapment prediction system. The casting geometry is shown in Figure 9.



Fig. 9. 3D schematic diagram of shell

From the casting geometry in Figure 8, it can be seen that the internal structure of the casting is relatively complex, with more mold wall barriers, the molten metal enters the mold cavity from below, and there are many pouring inlets, and air entrapment is prone to occur at the intersection of several metal liquid flows and at the pouring inlet. The overall casting geometry is: 86mm X 470mm X 330mm, the number of subdivision grids is 57 grids in the X direction, 3 to 13 grids in the Y direction, 220 grids in the Z direction, and the total number of grids is 3,925,020. The material is Al - Si alloy, the pouring temperature of the casting is 700 degrees Celsius, and the initial temperature of the mold is 20 degrees Celsius.

The filling calculation simulation of the casting is carried out to obtain a series of flow field data. Input these data into the air entrapment prediction system for calculation, and then use the continuous calculation function of Inte CAST to continue the calculation, select a typical filling stage, and compare the calculation results of the air entrapment prediction system with the original calculation results of Inte CAST.

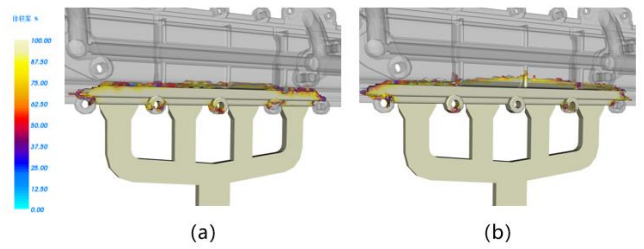

Fig. 10. Filling process without air entrapment prediction system (partial). (a) Pouring 0.012 seconds (b) Pouring 0.013 seconds

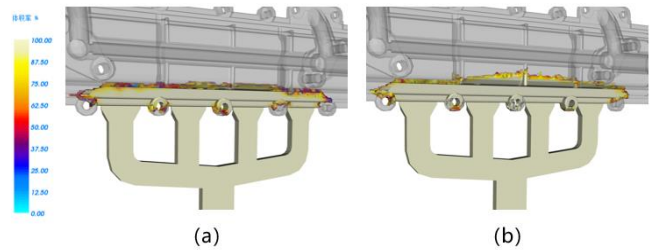

Fig. 11. Filling process of applying air entrapment prediction system (partial) (a) Pouring 0.012 seconds (b) Pouring 0.013 seconds

By comparing the two filling processes in Figure 10 and Figure 11, it can be seen that since there are many ingates and they are all at the bottom of the casting, there is a hole structure between the inlets of the ingate, and when the molten metal enters the cavity from the runner, the molten metal will meet at the hole structure to form entrained gas. When the gas entrapment prediction system was not applied, these gases disappeared in the molten metal during the subsequent calculation process, but after the gas entrapment prediction system was applied, the gases involved in the molten metal were searched and retained, providing a way to predict possible gas entrapment defects in castings.

The prediction results of casting entrapment defects are shown in Figure 12, and the quantitative prediction results are shown in Table 4:

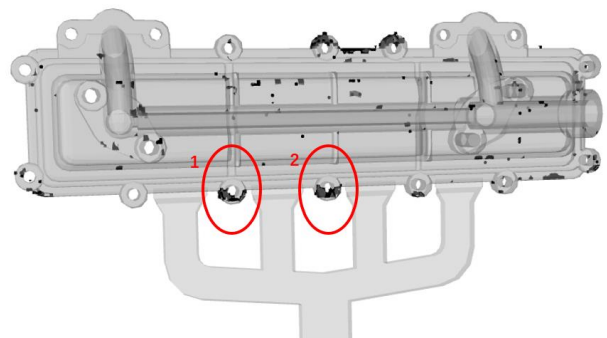

Fig. 12. Prediction results of shell entrapment defects

Table 4.

Result of quantitative prediction of entrapment defects (partial)

serial number	Number of grids (pieces)	Volume (cc)
1	86	0.69
2	101	0.81

From the above comparison, it can be seen that the entrained gas prediction system can search for the gas involved in the molten metal to prevent it from being ignored in the subsequent simulation calculations and can predict the possible location of the entrained gas defect, which has a certain guiding role in preventing the occurrence of the entrained gas defect and improving the pouring process.

5. Conclusions

The purpose of this paper is to develop a quantitative prediction system for rolled gas based on Inte CAST. The core algorithm of the volume gas quantitative prediction system is studied, and the accuracy of the algorithm is verified by searching for liquid-phase connectivity domains; the basic functions of the volume gas quantitative prediction system are realized, and the unconsidered and disappeared isolated gas-phase connectivity domains are retained for subsequent calculations, and the liquid volumes of the unconsidered and disappeared isolated gas-phase connectivity domains are redistributed, which ensures that the liquid volumes are conserved before and after the modification; the velocity values and pressure values are corrected by using interpolation for the volume gas quantitative prediction system, and the system is verified and applied. The velocity and pressure values of the quantitative gas prediction system are corrected by the interpolation method, and the quantitative gas prediction system is validated and applied. Two actual castings were selected for simulation, and the air entrainment phenomenon occurred at the place where the metal liquids intersected each other, which led to the possible location of the air entrainment defects in the casting and verified the effectiveness of the gas-rolling prediction system.

The prediction of entrained air defects is a difficult problem in the research of casting mold filling simulation process, and there are still many problems to be solved urgently for the accurate prediction of entrained air defects. For this paper, the gas entrainment defect prediction system established in this paper still has certain defects. In the follow-up research, it is necessary to comprehensively consider the velocity and pressure changes of the bubbles to predict the movement and evolution of the bubbles in the molten metal. For the problem of liquid redistribution in the original disappearing and isolated gas-connected domain, the distribution should be carried out according to the filling law of the molten metal, so as to obtain more accurate calculation and simulation results.

References

- [1] Hu, L., Feng, Z.P., Feng, L., Duan, S.P. & Liang, S.P. (2016). Numerical simulation of porosity defects in casting filling process. DOI:10.16410/j.issn1000-8365.2016.02.030. (in Chinese)
- [2] Bi, C. (2016). *Study on numerical simulation of gas entrapment and external solidified crystals during mold filling of high pressure die casting process*. Doctoral dissertation, Tsinghua University. (in Chinese).
- [3] Yu, M.Q., Xia, W., Cao, W.J. & Zhou, Z.Y. (2010). Numerical simulation of filling process and air entrapment condition of Al alloy die-casting. *Hot Working Technology*. 01, 36-39. DOI:10.14158/j.cnki.1001-3814.2010.01.039. (in Chinese).
- [4] Hernández-Ortega, Juan, J., Zamora, Rosendo, & Palacios, et al. (2007). Experimental and numerical study of air entrapment during the filling of a mould cavity in die casting. In 10th Esaform Conference on Material Forming, 18-20 April 2007 (1430-1435). Zaragoza, Spain.
- [5] Guerra, F.V., Archer, L., Hardin, R.A & Beckermann C. (2019). Measurement of air entrainment during pouring of an aluminum alloy. *Shape Casting*. 80, 31-40. <https://doi.org/10.1007/s11663-020-01998-3>.
- [6] Chen, Y.X., Chen, Z. & Liao, D.M. (2021). Prediction of air entrapment defect in casings based on gas phase tracking and bubble breaking criterion. *Foundry*. 70(07), 806-812.
- [7] Caboussat, A., Picasso, M. & Rappaz, J. (2005). Numerical simulation of free surface incompressible liquid flows surrounded by compressible gas. *Journal of Computational Physics*. 203(2), 626-649. <https://doi.org/10.1016/j.jcp.2004.09.009>.
- [8] Kimatsuka, A., Ohnaka, I., Zhu, J.D., Sugiyama, A. & Kuroki, Y. (2006). Mold filling simulation for predicting gas porosity. *IHI Engineering Review*. 40(2), 83-88.
- [9] Yang, X., Huang, X., Dai, X., Campbell, J. & Tatler, J. (2004). Numerical modelling of entrainment of oxide film defects in filling of aluminium alloy castings. *International Journal of Cast Metals Research*, 17(6), 321-331. <https://doi.org/10.1179/136404604225022748>.
- [10] Dai, X., Jolly, M., Yang, X., & Campbell, J. (2012). Modelling of liquid metal flow and oxide film defects in filling of aluminium alloy castings. *IOP Conference Series Materials Science and Engineering*, 33(1), 2073.
- [11] Reilly, C., Green, N.R., Jolly, M.R. & Gebelin, J.C. (2013). The modelling of oxide film entrainment in casting systems using computational modelling. *Applied Mathematical Modelling*, 37(18-19), 8451-8466. <https://doi.org/10.1016/j.apm.2013.03.061>.
- [12] Reilly, C., Green, N.R. & Jolly, M.R. (2013). The present state of modeling entrainment defects in the shape casting process. *Applied Mathematical Modelling*. 37(3), 611-628. <https://doi.org/10.1016/j.apm.2012.04.032>.
- [13] Majidi, Hojjat, S., Beckermann, & Christoph. (2017). Modelling of air entrainment during pouring of metal castings. *International Journal of Cast Metals Research*. 30(5), 301-315. <https://doi.org/10.1080/13640461.2017.1307624>.

[14] Cao, LiuLiao, DunmingSun, FeiChen, TaoTeng, ZihaoTang, Yulong. (2018). Prediction of gas entrapment defects during zinc alloy high-pressure die casting based on gas-liquid multiphase flow model. *The International*

Journal of Advanced Manufacturing Technology. 94, 807-815. <https://doi.org/10.1007/s00170-017-0926-5>.