

Battery Powered Grass Trimmer Life Cycle Assessment – Case Study

Goran Rozing, Dina Jukić, Hrvoje Glavaš*, Mirko Karakašić

Abstract: Batteries as a power source are the basis for all major hand tool manufacturers as wide variety of portable products became battery powered for more convenient usage. Manufacturers disable unapproved battery applications in their products by designing batteries specific for these products. In practice, the life of power tool batteries depends on two parameters: natural aging and the type of use. In a case study of a Battery Powered Grass Trimmer which battery broke after four years, the repair procedure for the package is shown. However, shortly after the repair, the Battery Powered Grass Trimmer suffered a bearing deformation that rendered it unusable. Due to its age and the unavailability of replacing electric engine, the Trimmer was scrapped and a detailed Life Cycle Analysis (LCA) applying SimaPro methodology is provided. Since the product under study is no longer on the market, a properly functioning, refurbished battery with significantly increased capacity is used in a new battery-powered grass trimmer from another manufacturer. The paper's final consideration underscores the need for an international standard that regulates battery compatibility and reduces waste, especially electronic waste.

Keywords: battery; battery protection; Life Cycle Analysis; maintenance; SimaPro; trimmer

1 INTRODUCTION

Power-driven hand tools are relying on Li-Ion batteries, increasingly. The main reason for this transition is elimination of a connection cord without significant increase of the mass that is characteristic for other battery forms, as illustrated in Fig. 1.

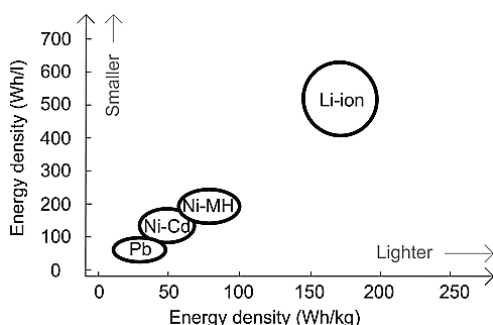

Figure 1 Energy densities of technical solutions for some common batteries, [1].

Manufacturers have been compelling customers into using their battery packs, and offering a variety of products powered by one battery solution, [2]. Most manufacturers have their own patents on contacts; some have even introduced multiple contacts to prevent users from easily using other batteries. Small manufacturers have teamed up and formed the Cordless Alliance System [3], but the big ones hold the patent rights to the battery pack designs. These patents also extended to battery pack connections to improve output of a power tool by using battery packs which users have already had [4], as Fig. 2 shows.

To enable the adaptation of the device to receive batteries from different manufacturers, adapters such as the MakitaBL1830 battery conversion device [5] were patented. However, the Makita patent prevented wider use of adapters, and consequently prevented the idea advocated by the Cordless Alliance System. Within the European Union (EU), awareness of the problem is slowly growing, and the solution has started at the level of small devices such as mobile

phones. The EU has published its new 'Common Charger' directive, [6].

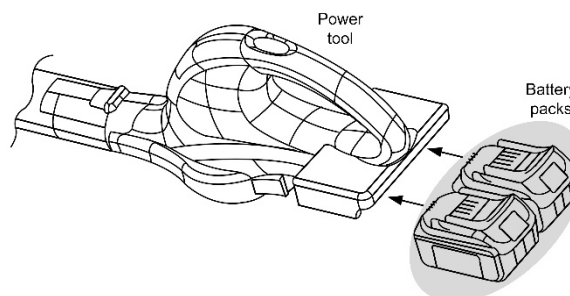

Figure 2 Power tool using plural battery packs as power source, [4].

Starting December 28, 2024, every phone, tablet, camera, pair of headphones and earbuds, headset, handheld videogame console, portable speaker, e-reader, keyboard, mouse, and portable navigation system sold in the EU must have a USB Type-C port. If charging is higher than 15 W, it is also required to incorporate USB Power Delivery. One hopes that some form of the directive will be transferred to all battery-powered devices as to reduce the amount of electronic waste.

Note that this case study was carried out over 3 years course, while the need of unified standard was recognized as soon as the study began. Recently, the new Batteries Regulation [7] was brought to authors attention, which indicates that starting from 2025, "waste batteries will have to be recycled and high levels of recovery will have to be achieved, in particular of critical raw materials such as cobalt, lithium and nickel". In addition, batteries will be removable and replaceable starting from 2027 [7].

Motivation for the analysis presented in this paper is the failure of grass trimmer battery pack, which is no longer in production. The battery pack went through a repair process, but shortly after battery cells replacement, bearing of the electric engine was deformed, resulting with unusable device. Replacement engine was not available, whereas

adaptation of different engine was not economically viable as a new trimmer would cost less.

A new trimmer was adapted to the old battery, while the old trimmer was disassembled, and recyclability analysis as well as Life Cycle Analysis (LCA) were performed. The work presented in the paper follows the timeline of procedures mentioned in the previous paragraph and is divided into three parts of maintenance: repairment of the existing battery, adaptation of the battery to the new trimmer, and analysis of the old trimmer recyclability. Analyses were performed within the frame of the SimaPro software.

2 RESEARCH METODOLOGY

The trimmer under study is MEROX, model MX-CL-18, shown in Fig. 3. It was purchased in 2013 for the price of 100.75 € and was provided with two batteries. Specification of the trimmer are: 18 V d.c. / 1.5 Ah rot 9000 m^{-1} \varnothing 260 mm. After 4 years of use, it was determined that battery pack is damaged. Prior to battery pack replacement, housing was never altered due to warranty. The battery pack was replaced with newly purchased one which provided 13 % more capacity (based on comparison of data provided by the manufacturers). However, opting for new battery pack was not determined on the basis of higher capacity, rather it was the most cost-efficient option.



Figure 3 Subject of the study MEROX MX-CL-18 grass trimmer. Enlarged details show battery pack features.

After little over a year of use with the new battery pack, damages of the head support were noticed; in other words, engine was not operational. Investigation of prices and available battery-powered trimmers in chain stores revealed that MEROX MX-CL-18 was not available for purchase. Optimal option was to purchase new trimmer with no battery included, as often power tools are sold in this manner in the chain stores, and adapt previously repaired battery pack to the newly purchased trimmer. Lack of battery standard made

the adaptation challenging as new trimmer had different battery connections in comparison to the old one. Technical realization of devices found in patent databases [8, 9] indicated that the additional contact on the new trimmer battery pack usually represents the thermistor protective element, which can be Negative Temperature Coefficient (NTC) or Positive Temperature Coefficient (PTC). To determine whether it is NTC or PTC, trimmer needed to be powered on, [10]. However, further research of patents showed that short-circuiting could damage semiconductors element in the start-up system, [11]. Therefore, it was opted for incorporating a common resistor instead of PTC. Trimmer was then in use until it reached end of its life cycle.

Widely favorable LCA [12-14] was applied to determine the environmental impact of the analyzed grass trimmer. To prepare the trimmer for the LCA as suggested in [15, 16], it was disassembled into elements which masses were determined using analytical laboratory scale. Eco-indicators were assigned to each element based on their materials in the SimaPro 9 ecoinvent 3.5 software, [17]. Product development as well as sustainability objectives' environmental impact can be measured with the aid of Simapro, Life Cycle Assessment programme. According to ISO14040, LCA is a compilation and evaluation of inputs, outputs, and possible environmental effects of a product system during its life cycle, [18]. Numerous uses for the SimPro exist, including environmental protection, eco-design of products, carbon and water analyses, and Key Performance Indicators for ecological performance. For this contribution version SimaPro 9 with ecoinvent 3.5 database was used. Within the SimaPro software, we investigated recyclability of trimmer, environmental impact of the trimmer production, and environmental impact of trimmer life cycle based on eco-indicators, [19].

Trimmer recyclability was determined as follows, [20]:

$$R = \frac{\sum_{i=1}^n m_i \cdot b_i \cdot r_i}{M \cdot r_{\max}} = \frac{9830.3}{2173.1 \cdot 5} = 0.9047, \quad (1)$$

where m_i is the mass of the i^{th} part expressed in grams, b_i is the number of repetitions of the i^{th} part in the product, r_i is the recyclability rating of the i^{th} part, M is the total mass of the trimmer expressed in grams, and r_{\max} the highest recyclability rating.

Two sets of parameters were made in the SimaPro software interface's "Calculation setups" section in order to examine the environmental effects of trimmer production. The first set dealt with production, and the findings show how each material used to make the trimmer affects the environment. The second set made it possible to compare the product's environmental impact at every step of its life. The stages that were studied were: trimming tool production, trimming tool use, trimming tool disposal, and recycling of materials.

Lastly, trimmer life cycle was divided into four phases to investigate life cycle environmental impact: manufacturing, use, disposal, and material reuse.

3 TRIMMER BATTERY REPAIRMENT AND ADAPTATION

Grass trimmers are ideal for maintenance of sloped terrains impractical to approach with riding lawn mowers, and necessary for maintenance of marginal areas which the lawn mower cannot approach. As trimmers are small in mass, ones that are powered via connection cords are less versatile than the battery-powered trimmers. Cords may even cause disturbance in terrain maintenance. In addition, battery-powered trimmers guarantee ease of use without the worry about tilting which accompanies gasoline-powered solutions.

3.1 Battery Pack Repairment

The MEROX trimmer under study was sold with two included batteries of 1.5 Ah capacity, which used to provide up to 45 minutes of autonomy. Fig. 4 shows the charger JLH302101500G1 240 V/50 Hz 45 W and the battery BP09Li-180 18 V.

Li-Ion batteries have limited lifespan which does not necessarily depend on the declared number of charge and discharge cycles, [21]. Different configurations of battery packs are formed according to the required voltage for which the device is designed and the energy on which the autonomy of the device's operational state depends. Battery packs for almost all hand tools, electric bicycles, and certain cars are made of Li-Ion cells 18650 by the spot-welding process, [22].



Figure 4 Charger and battery of the trimmer under study.



Figure 5 Repairment of the defective battery pack with a nominal capacity of 1.5 Ah with new cells with a capacity of 3.4 Ah.

Reparation procedure by cell replacement is relatively simple and fast. Fig. 5 shows the inside of the battery pack. The original 18650 cells with capacity of 1500 mAh, after 4 years of use, were replaced with Panasonic NCR18650B

18650 cells with capacity of 3400 mAh, which is 13 % more capacity than both original batteries used to provide. Therefore, there was no need to renew the second battery. The cost of renovation was 36 €. For comparison, the EINHELL battery Power-X-Change Plus 18 V 3.0 Ah is 54.90 €, which renders maintaining the existing battery more cost-efficient.

3.2 Trimmer Adaptation

After battery repairment, the trimmer was in operation for a little over a year. After 5 years of overall usage, wear of the brass friction bearing was noticed. During the replacement procedure, the part of the head support that is pressed onto the shaft was damaged, as seen in Fig. 6.



Figure 6 Damages on the head support of the trimmer under study.

Replacing the HRS775S-6221F.DC 18 V/R, 2011.01 engine which corresponds to the MEROX trimmer under study should be a simple procedure. However, the engine produced in 2011 was no longer available in 2019 when damages occurred. A similar engine that would require an additional adjustment costs 19 €, delivery included. A brand-new trimmer with a three-year warranty, but no battery included, was offered in store for 33.18 €. Eventually, it was bought for discounted price of 26.54 €. Unfortunately, the renewed battery pack of the MEROX trimmer did not fit the purchased trimmer as, instead of two contacts, the new trimmer had three, which is illustrated in Fig. 7.

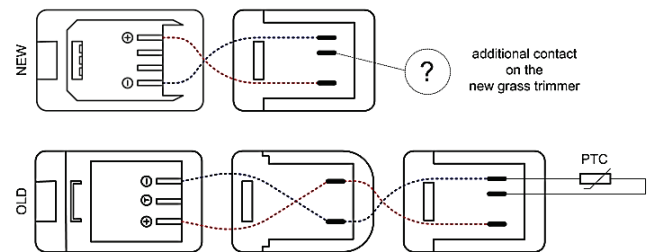

Figure 7 Contact arrangement of the new and old battery (left), contact arrangement of the head support (middle), and arrangements of the protective element (right).

The purchased trimmer is powered by battery of up to 8 Ah capacity, whereas the MEROX trimmer was powered by battery of 1.8 Ah capacity. The additional contact usually represents the thermistor protective element, which can be Negative Temperature Coefficient (NTC) or Positive Temperature Coefficient (PTC). Sometimes, even more contacts can be found on the battery packs. For example, patent [8] from 2013 requests 5 contacts. That said, most of

simple devices like trimmers use only power supply and overheating protection [9], as they do not have regulations. Fig. 8 shows battery connections and how the third connector was used to connect the thermistor.

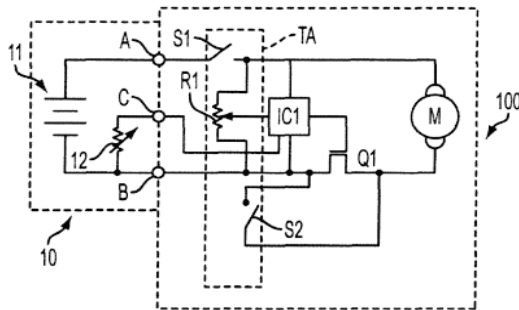

Figure 8 Application of the third connection as a thermistor connection, patent drawing, [9].

Patent [9] explains Fig. 8 in detail: The conventional power tool battery pack 10 comprises a housing 13, cells 11 connected between first and second terminals A, B of the housing, and a thermistor 12 also connected between first and third terminals A, C of the housing. The drill 100 can be connected to such a power tool battery pack 10 via the terminals A and B.

The patent database with patent applications and approved patents represents a valid source of information on the technical realization of devices. However, for further insights devices have to be powered on. Specifically, when connecting the positive and negative poles of the new battery to the trimmer, device should be turned on. This provides following information: if device is turned on and immediately turns off, then the installed element is PTC; if NTC is installed then the device will continue running, as indicated in Fig. 8.

However, short-circuiting during the trimmer start-up test with an old battery is not an option, because damage to the device of the semiconductor elements in the start-up system are likely to occur in the case of incorrect termination, [11]. Based on information from the manufacturer of protective equipment [23], that the expected value of PTC resistance at ambient temperature is known to be 10 k Ω (Fig. 9).

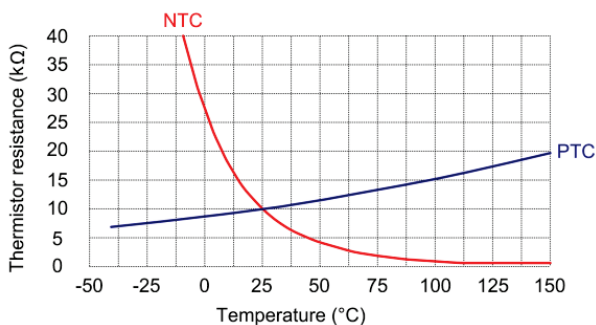

Figure 9 Resistance characteristic of the protective element.

Instead of incorporating a PTC, a common resistor was placed and the trimmer was successfully running on the old

battery. To preserve the warranty, the battery holder of the old trimmer was attached to the new one. The contacts secure it, springs and hilum in strips were used, as shown in Fig. 10. Fig. 10 shows the apparel of the new trimmer with the old battery and wiring. As the old battery has a unique layout, 3D printing of the adapter would take a lot of time. In the case of the Einhell battery on the new trimmer, one can obtain pre-made solutions which are visually and practically better than the realization shown in Fig. 10. In addition, numerous platforms for exchanging 3D models of layouts exist. For example, adapters can be found on the Thingiverse design community for making and sharing 3D printable things, [24]. The price of printed 3D adapters on the eBay platform ranges from 25 € to 37 €.



Figure 10 New trimmer with the old battery. Enlarged detail shows the wiring.

4 LIFE CYCLE ASSESSMENT OF GRASS TRIMMER

The MEROX MX-CL-18 grass trimmer under study in this contribution has reach the end of its life cycle (Fig. 11). To determine its impact on the environment, the Life Cycle Analysis methodology was applied. To show the impact of specific materials on the environment as consistently as possible, it was necessary to record their entire life cycle cradle-to-grave by listing and analyzing all the elements shown in Fig. 11. Elements and their ratios are listed in Tab. 1. After this step, eco-indicators were defined. Application of the SimaPro software package allowed us to qualitatively assign the dimensionless eco-indicators corresponding to individual materials in a manner that higher indicator suggests greater environmental impact, [20].

Table 1 Relative ratios of trimmer MX-CL-18 materials.

Material	Mass (g)	Ratio (%)
Polymer-ABS	1118.11	51.45
Steel	287.80	13.21
Aluminum	263.60	12.13
Li-Ion battery	207.00	9.53
Polymer-PC	110.17	5.07
Cooper	93.02	4.28
Magnet-Ferrite	86.27	3.97
Graphite	8.00	0.37



Figure 11 Trimmer under study disassembled and prepared for LCA.

4.1 Recyclability of Trimmer Elements

Masses of elements were determined by analytic scale Kern ALS 220-4N, sensitivity 0.01 g, before listing in SimaPro software. Furthermore, material types were chosen from predefined software resources, as well as ratings of recyclability. Analyzed trimmer has 41 elements of joined mass $M = 2173.1$ grams. Tab. 2 shows 12 out of total 41 elements.

Obtained value of trimmer recyclability upon accounting all trimmer elements is as high as 90 %, which is not surprising as half of trimmer total mass is due to Polymer-acrylonitrile butadiene styrene (ABS), highly recyclable and reusable material (Tab. 1).

Table 2 Recyclability analysis of trimmer MX-CL-18 elements.

Ordinal number	Element	Material	Mass of elements (g)	Pieces per product	Rating of recyclability
i			m_i	b_i	r_i
1	Trimmer handle	Polymer ABS	279.62	1	5
2	Speed controller	Polymer ABS	10.31	1	5
6	Handle	Aluminum	264.00	1	5
10	Screw M6	Steel	19.03	1	5
16	Shaft	Steel	13.54	1	5
18	Crank adjustment	Polymer PC	6.88	1	5
22	Rotating silk head	Polymer PC	77.43	1	5
24	Motor windings	Cooper	88.00	1	5
36	Tile	Cooper	5.00	1	5
37	Sliding contact	Graphite	8.00	1	5
38	Motor magnet	Ferrite	86.27	1	5
41	Battery	Hazardous	336.00	1	0

4.2 Environmental Impact of Trimmer Production

To analyze the environmental impact of trimmer production two sets of settings were created in the "Calculation setups" of the SimaPro software interface. First set was related to production, the results of which represent environmental impact of individual material from which the trimmer is made. The second set allowed for comparison of all life stages of the product, and their impact on the environment. The observed phases were: production of

trimmer, use of trimmer, disposal of trimmer, and reuse of recycled materials.

Fig. 12 illustrates process three with mass balances for trimmer production. The thickness illustrates material negative impact on environment during manufacturing process. Greater thickness indicates higher impact. Process three shows that the magnet-ferrite, although not largest in mass, has the highest negative impact on the environment. On the other hand, polymer-ABS, has about three times less impact on the environment despite its mass which is 1.12 kg of total trimmer mass 2.17 kg.

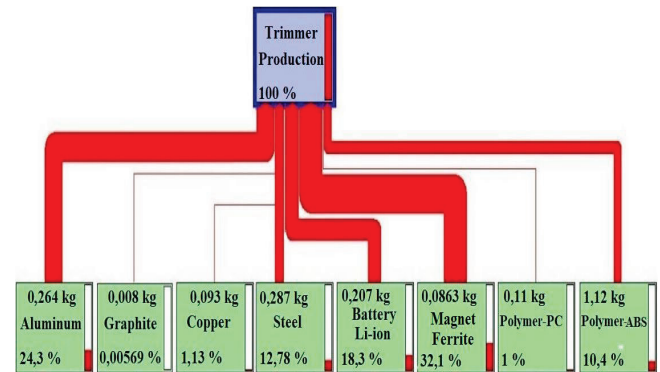

Figure 12 Trimmer production process three.

Fig. 13 shows how each material impacts, relative to each other, three possible and different areas: human health, ecosystem, and resources.

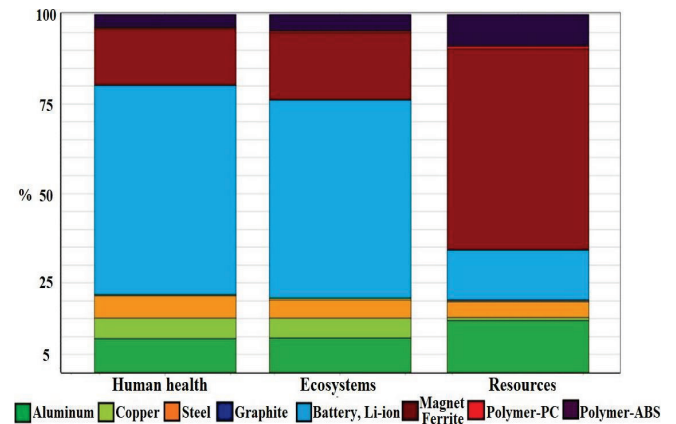

Figure 13 Impact of materials on three areas of possible damage.

In Fig. 13, lighter shade of blue visualizes Li-Ion battery impact on these areas. As seen in Fig. 13, impact of the battery on first two is more than double of other elements combined. This is expected as toxic materials which are contained in batteries, such as lithium, cobalt and lead, could lead to serious health consequences to humans or any other exposed life form.

Dark shade of red corresponds to the magnet-ferrite, which significantly less, but still to a large extent, impacts the environment. Of the three areas of possible damage, the magnet-ferrite has the least impact on human health as exposure to the magnetic field, even for longer periods, does not have any long-term health consequences. Magnet

production affects resource consumption almost three times more than human health or ecosystem area. The reason for this is that magnets are made from different metals that are easy to magnetize (iron, cobalt, nickel), as well as from alloys of certain rare earth metals. Additionally, metals are not renewable resources.

Aluminum, indicated by color green, impacts the environment similarly as the magnet-ferrite, but in much smaller quantity. It has the least impact on human health, but frequent and long-term exposure to large amounts of aluminum, as well as inhalation of aluminum particles, still have negative effect on health. As it is often necessary to clear large areas of forest in order to build an aluminum mine, it impacts the ecosystem area to a slightly greater extent than the magnet-ferrite. Additionally, after extraction from the ground, aluminum processing plants can release harmful emissions into the atmosphere. Like other metals, it is a non-renewable resource; for the extraction and processing of aluminum it is necessary to invest a lot of electricity, which results in a greater consumption of resources.

Purple color indicates the Polymer-ABS which carries the most mass in the analyzed electric trimmer. However, it impacts the environment through all three areas to a much lesser extent than the previously mentioned materials of lower mass. As the polymer-ABS is a type of plastomer that does not burn when exposed to high temperatures, it does not cause emissions of harmful gases or other chemical compounds. In addition, it can be melted by heating and reshaped into a new product, making it almost 100 % recycled material.

Results of the analysis are often conveniently presented in the form of millipoints or points. Comparison of all the materials from which the trimmer was made in three areas of possible damage, and the comparison values are expressed in points (Pt), can be seen in Fig. 14.

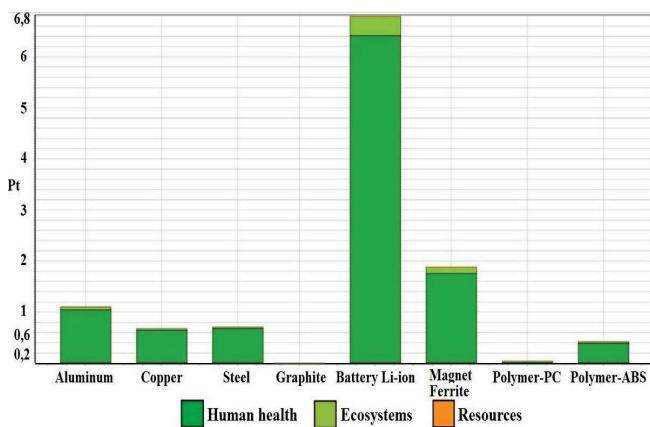

Figure 14 Eco-indicators of individual materials in production.

At first glance, it is apparent from the graph that all materials have the greatest impact on human health, significantly less on the ecosystem and almost negligible on the consumption of resources. Since this is an "isolated case", i.e., only one trimmer, it is expected that the impact of all materials and their production processes is much smaller than the impact on human health. The impact of the Li-Ion battery

on human health, as well as on the ecosystem, stands out due to the high toxicity of the materials from which it is made, and the unreliable or incorrect disposal methods.

4.3 Environmental Impact of Trimmer Life Cycle

Trimmer life cycle was analyzed in four phases, which are production of trimmer, usage, disposal and reuse of its materials. Results of the analysis can be seen in Fig. 15.

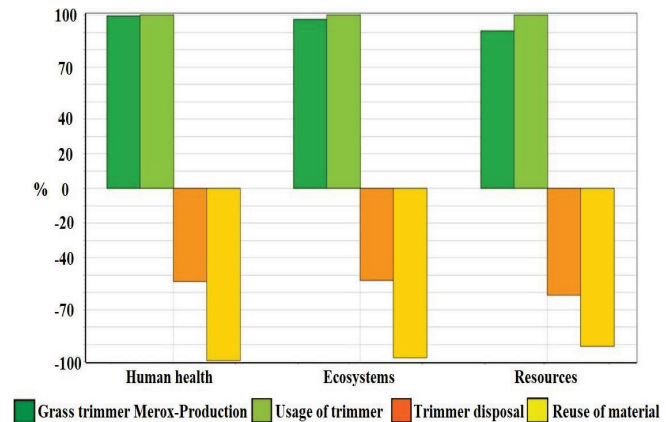

Figure 15 Impact of trimmer life cycle phases on three areas of possible damage.

In Fig. 15, green illustrates values which impact the environment negatively, but they are expressed as positive numbers, whereas orange illustrate values which impact the environment oppositely, but they are expressed as negative numbers. Phases of production and usage of the analyzed trimmer have almost maximum values in all three areas of possible damage as they impact the environment negatively to the greatest extent. Furthermore, trimmer disposal phase includes transporting the disassembled parts of the trimmer to a location suitable for their disposal and the environmental burden of that disposal, therefore the load reduction in the trimmer disposal phase is slightly less than the phase of reuse of the material. Since the total trimmer recyclability is around 90 %, reuse of recycled material reduces environmental load through all three phases. This reduction is slightly less in the area of resource reuse due to battery, magnet-ferrite, and aluminum which are made from non-renewable resources.

Points which correspond to the impact of trimmer life cycle phases on three areas of possible damage are presented in Fig. 16.

Throughout all life stages shown in Fig. 16, the most accentuated category is human health, ecosystem category is gravely less, and the resource category is almost not visible on the graph. The stages of production and use of trimmer have approximately the same value as the stage of reuse of recycled material through all three areas of possible damage, but with opposing signs. These two phases individually increase the burden on the environment to almost the same extent that the reuse of recycled material reduces it due to high recyclability of trimmer.

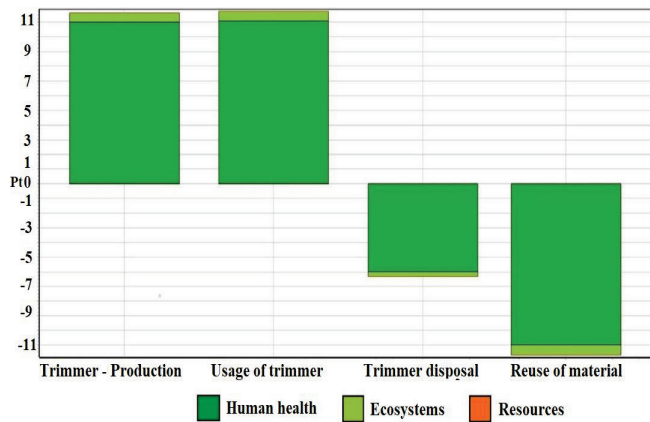

Figure 16 Eco-indicators of trimmer life cycle phases on three areas of possible damage.

5 RECAPITULATION ANNOTATION

As the availability of lithium batteries increases, so does the number of devices which use them as power sources. Low mass and high energy density per unit of mass further promotes their usage. Different patent solutions complicate application compatibility, condemning users to follow one manufacturer as they invested in one type of battery holder. This problem is recognized on a global level, and the research presented in this paper has a positive epilogue. In August 2023, the European Union adopted the first provision related to the regulation of the battery market and unification of its application.

The Battery Powered Grass Trimmer presented in this paper, underwent battery repairment due to impossibility of buying a new one. Then, while attempting to repair the friction bearing, trimmer reached the end of its life cycle and was used for recyclability analysis. The battery, which was practically new at the end of trimmer life cycle, could not be used in other devices, and adapter was made from the old battery in order to use it on the new trimmer. During the adjustment process, effort was put towards bypassing the limitations of the trimmer manufacturer, which was reflected in the safety function of protection against overheating. The old solution did not have protection against overheating as the potential threat was smaller due to the capacity of the battery. Nevertheless, the new device did not lead to overheating either, so the same solution was bypassed. All procedures are described in detail and are applicable to most new devices.

A special part of this contribution is dedicated to the LCA of the trimmer, which was carried out using SimaPro, one of the most popular tools. Analyzed trimmer consisted mostly of plastic, followed by metals. Trimmer recyclability is relatively high at 90.47 %. The biggest negative impact on the environment is delivered by engine magnets, aluminum, and battery. In terms of impact on health and ecosystem, the battery represents the greatest threat, and should be disposed of properly. Therefore, the cells were replaced in the repairment stage and handed over to an authorized recycling company. The eco indicators of the battery are the highest, which is evident from the data presented in the paper. The

second eco indicator corresponds to magnet-ferrite, and third to aluminum. Eco indicators for iron and copper are lower than aluminum, but higher than polymer.

The above indicators confirm the justification for the adoption of new European guidelines regarding the regulation of the battery market, but they also provide guidance on the possibility of maintaining and repairing battery-powered devices. A significant source of information on technical implementations is the patent database as detailed technical solutions can rarely be found in scientific papers. Initially battery-powered tools manufacturers also produced and sold battery adapters. At that time, battery powered tools were made in small numbers, hence only several manufacturers existed. With technological advancements, retail companies which own chain stores, like Lidl where trimmer under study was purchased, began to manufacture, and sell their own brands of battery powered tools. To protect their products, retail companies relied on patent rights. As a result, there are hundreds of distinct battery patents that may be found in patent databases and are hardly ever referenced in academic journals. Therefore, in this contribution we express a need for battery standard, which we show on an example of battery powered grass trimmer life cycle.

6 REFERENCES

- [1] Warner, J. (2015). *The handbook of lithium-ion battery pack design chemistry, components, types and terminology*. Elsevier. <https://doi.org/10.1016/B978-0-12-801456-1.00001-4>
- [2] Einhell, Ein Akku für über 250 Geräte für Werkstatt und Garten, <https://www.einhell.de/akkusystem/> (Accessed April 30, 2023).
- [3] Cordless Alliance System, <https://www.cordless-alliance-system.com/> (Accessed April 30, 2023).
- [4] Makita Corp, JP2014100785A power tool using plural battery packs as power source, 2014-06-05.
- [5] Shenzhen City Waitley Power CO LTD, CN209232850U, MakitaBL1830 battery conversion device, 2019-08-09.
- [6] Directive (EU) 2022/2380, amending the Radio Equipment Directive 2014/53/EU, The ‘common charging’ solution, <https://www.einhell.de/akkusystem/>, accessed April 30, 2023.
- [7] Circular economy: New law on more sustainable, circular and safe batteries enters into force, https://environment.ec.europa.eu/news/new-law-more-sustainable-circular-and-safe-batteries-enters-force-2023-08-17_en (Accessed August 30, 2023).
- [8] Noda et al. (2013). Battery pack for electric power tool, control circuit, tand program. Makita COP., Patent Application Publication, Pub. No.: US2013/0033233A1 Feb. 7, 2013.
- [9] Brotto, D. C. (2010). Battery pack lockout arrangement for cordless power tools. Black & Decker Inc., US7759898B2.
- [10] Shawky, M. (2022). Temperature and humidity sensing, using thermistors to enhance thermal protection for battery management systems. Texas Instruments.
- [11] Furu et al. (2017). Portable battery pack charging system, method for recharging a battery pack, and adapter therefor. Makita COP., Patent No.: US9780583B2.
- [12] Sivaraman, D. & Lindner, A. S. (2004). A comparative life cycle analysis of gasoline-, battery-, and electricity-powered lawn mowers. *Environmental engineering science*, 21(6), 768-785. <https://doi.org/10.1089/ees.2004.21.768>

- [13] Nakamura, S. & Kondo, Y. (2006). A waste input–output life-cycle cost analysis of the recycling of end-of-life electrical home appliances. *Ecological Economics*, 57(3), 494-506. <https://doi.org/10.1016/j.ecolecon.2005.05.002>
- [14] Fleck, B. & Huot, M. (2009). Comparative life-cycle assessment of a small wind turbine for residential off-grid use. *Renewable energy*, 34(12), 2688-2696. <https://doi.org/10.1016/j.renene.2009.06.016>
- [15] Guinée, J. B., Heijungs, R., Huppes, G., Zamagni, A., Masoni, P., Buonamici, R., & Rydberg, T. (2011). Life cycle assessment: Past, present, and future. *Environmental Science & Technology*, 45(1), 90-96. <https://doi.org/10.1021/es101316v>
- [16] Marijić, J., Vilić, M., Grgić, I., Karakašić, M., Ivandić, Ž., & Komarčić, D. (2022). Analysis of the impact of smartphones on the environment using the LCA method. *The 32nd International Conference on Organization and Technology of Maintenance (OTO 2023)*, Osijek, Croatia, Springer.
- [17] SimaPro LCA Software for informed changemakers, <https://simapro.com> (Accessed November 6, 2023).
- [18] ISO14040:20068(en), <https://www.iso.org/obp/ui/en/#iso:std:iso:14040:ed-2:v1:en> (Accessed November 6, 2023).
- [19] J Eco-indicator 99 manual for designers, https://presustainability.com/legacy/download/EI99_Manual.pdf (Accessed June 1, 2023).
- [20] Pintarić A. (2015). Assessment of recyclability for electrical waste. *The 13th International Symposium on Waste Management*, Zagreb, Croatia.
- [21] Glavaš, H., Barić, T., Karakašić, M., & Keser, T. (2022). Application of infrared thermography in e-bike battery pack detail analysis—Case study. *Applied Sciences*, 12(7), 3444. <https://doi.org/10.3390/app12073444>
- [22] Masomtob, M., Sukondhasingha, R., Becker, J., & Sauer, D. U. (2017). Parametric study of spot welding between Li-ion battery cells and sheet metal connectors. *Engineering Journal*, 21(7), 457-473. <https://doi.org/10.4186/ej.2017.21.7.457>
- [23] Chastas, P., Theodosiou, T., & Bikas, D. (2016). Embodied energy in residential buildings-towards the nearly zero energy building: A literature review. *Building and Environment*, 105, 267-282. <https://doi.org/10.1016/j.buildenv.2016.05.040>
- [24] Roy Meissner, Parkside PAB-18 1.5 A1 Adapter (to Einhell PXC 18V), <https://www.thingiverse.com/thing:4664184/files>. (Accessed April 30, 2023).

Authors' contacts:

Goran Rozing, Assistant professor, PhD
Faculty of Electrical Engineering, Computer Science and Information Technology
Osijek, University of Osijek
Kneza Trpimira 2B, 31000 Osijek, Croatia
E-mail: goran.rozing@ferit.hr

Dina Jukić, Senior Assistant, PhD
Faculty of Electrical Engineering, Computer Science and Information Technology
Osijek, University of Osijek
Kneza Trpimira 2B, 31000 Osijek, Croatia
E-mail: dina.jukic@ferit.hr

Hrvoje Glavaš, Full professor, PhD
(Corresponding author)
Faculty of Electrical Engineering, Computer Science and Information Technology
Osijek, University of Osijek,
Kneza Trpimira 2B, 31000 Osijek, Croatia
E-mail: hrvoje.glavas@ferit.hr

Mirko Karakašić, Full professor, PhD
University of Slavonski Brod, Mechanical Engineering Faculty in Slavonski Brod,
Trg Ivane Brlić-Mažuranić 2, 35000 Slavonski Brod, Croatia
E-mail: mirko.karakasic@unisb.hr