

STRUCTURE OPTIMIZATION OF LADLE ROTARY TABLE MOUNTING DEVICE

Received – Priljeno: 2023-08-28

Accepted – Prihvaćeno: 2023-11-10

Original Scientific Paper – Izvorni znanstveni rad

As a widely used equipment in continuous casting process, the installation process of ladle rotary table is complicated and requires many installation equipment. According to the practical engineering application, this paper takes the installation device as the research object, and optimizes the original structure of the installation device. SolidWorks software was used to model the overall structure of the installation device, and the established model was imported into Hypermesh for mesh division, and finally into ANSYS for finite element analysis to compare the stress and deformation of the structure before and after optimization. The results show that the stress of the optimized structure is reduced to some extent, and the practical application requirements are met.

Keywords: steel, continuous casting, ladle rotary table, mounting device, structure optimization

INTRODUCTION

Continuous casting steel is often called continuous casting, which is a production method that continuously casts molten steel into billets with a certain cross-section shape and size specifications [1]. Ladle rotary table is an important part of continuous casting machine. Its function is to rotate the full ladle of molten steel at the receiving position by 180° to the pouring steel position and park it above the tundish for pouring. Meanwhile, the empty ladle of molten steel after firing is rotated by 180° to the receiving position for transport, thus realizing the rapid replacement of full ladle and empty ladle and ensuring the continuous pouring of the continuous casting machine [2].

As the core equipment of continuous casting machine, the normal operation of ladle rotary table is the necessary condition for the smooth production of continuous casting machine. The rapid and accurate installation and adjustment method of the core equipment is particularly important in the current installation process. Pang Zunfu and Yang Jing used the wagons of the pouring span and the receiving span of the steel to install the ladle rotary table equipment with the help of hoisting, jacks and special spenders, which was easy to operate and safe to construct [3]. Lv Shijin et al. cleverly used the rotating cylinder assembly of ladle turning table and related auxiliary parts to realize the rapid overall lifting of ladle turning table, providing reference for similar inter-span lifting projects [4]. In order to ensure the smooth installation process, it is usually necessary to evaluate the

installation equipment. As a convenient method, finite element analysis is widely used. Zhang Xinyu et al used finite element to conduct contact analysis on the rotary bearing of the ladle rotary table, providing a foundation for improving its bearing capacity, service life, optimization design and dynamic analysis [5].

In this paper, the installation equipment of a ladle rotary table is taken as the analysis object, and the stress situation of each component in the device is obtained by finite element analysis, and the stress of each component is reduced by optimizing the structure, so as to meet the use requirements.

INSTALLATION DEVICE 3D MODEL

The ladle turntable installation device is to place the ladle turntable on the jacking frame, lift the ladle turntable through a synchronous jack, and then install the handling tank under the jacking frame, and lay a channel steel directly welded to the H-shaped steel track to ensure that the handling tank can run straight. Using two

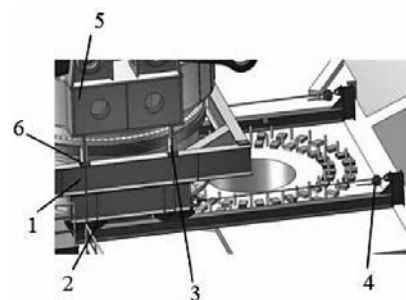

1 -- lifting bracket 2 -- Handling tank truck
3 -- synchronous jack 4 -- 10t hand hoist
5 -- large bag rotary table 6 -- Jack block

Figure 1 Structure of the transverse movement device

Z. Cui, H.Y. Long, R. Q. Gong, (E-mail cuizhe@ncst.edu.cn) College of Mechanical Engineering, North China University of Science and Technology, Hebei, Tangshan, China. F. Y. Zhu, W. Z. Yan, China MCC22 GROUP CORPORATION LYD

10t hoist to drag the lifting frame, the head of the hoist is hung on the lifting lug of the transverse platform, and the tail is hung on the lifting lug of the lifting frame, so that the main body of the ladle rotating table moves slowly to the installation position. In order to ensure the safety of the transverse movement, a 100mm high stop block is welded on the lifting frame to prevent the four jacks from moving. Below is the transverse device structure diagram (see Figure 1).

FINITE ELEMENT ANALYSIS

Simplification of three-dimensional model

Generally speaking, the first step of finite element analysis is to establish the finite element model. Because the structure involved in the project is more complex, it is necessary to establish the geometric model of the mechanical structure with the help of professional three-dimensional solid modeling software (such as Pro/E, solidworks, UG, etc.). Then the geometric model is imported into the finite element analysis software (such as Ansys, Abaqus, etc.) for grid division to generate the finite element model. For small and simple components, this finite element modeling method is very efficient, and can finally complete the calculation and obtain the results. For large and complex components to generate finite element models by this method, it is necessary to do a lot of simplification of the geometric model, import the simplified geometric model into the finite element analysis software, and delete the parts in the model that do not affect the stress analysis, such as short railings, columns, etc. the simplified model is shown in Figure 2. In addition, in order to simplify the operation, the whole ladle turntable is processed together with nodes, which can also save the operation time to a great extent, and will not affect the results of subsequent analysis.

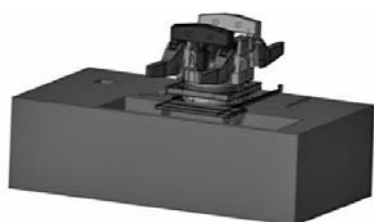

Figure 2 Simplified diagram of ladle turntable

Material allocation and grid division

First of all, the simplified assembly should be opened in HyperMesh, and then the material should be assigned to each part, that is, the elastic modulus, density and Poisson's ratio of the material should be defined. The specific material information is shown in Table 1.

Therefore, tetrahedral mesh is mostly used when dividing meshes in HyperMesh. Because the lower half of the foundation does not affect material deformation and stress, the lower half of the foundation is simplified into

Table 1 Lists the material properties of each component

Unit	Modulus of elasticity /MPa	Poisson's ratio	Density /kg/mm ³
foundation	3E+4	0,2	2,35E-6
Embedded iron	2E+5	0,3	7,85E-6
H-shaped steel track	2E+5	0,3	7,85E-6
Jacking bracket	2E+5	0,3	7,85E-6
Revolving table	2E+5	0,3	7,85E-6

a large hexahedral mesh for simple calculation. The embedded iron in the foundation is the focus of analysis, so the mesh division of embedded iron is 10 mm mesh. This greatly reduces the operation time, but also reduces the grid partition time. The H-shaped steel track is divided by a 15 mm grid because of the large deformation gravity. In the jacking support, four jacks mainly bear the gravity of the rotary table. Therefore, the grid selected for the main jack is 10 mm and 15 mm for the jacking support, and 15 mm for the rotary table. The partitioning results are shown in Figure 3 below.



Figure 3 Meshing result

Assembly of Finite Element Model

The assembly of finite element model refers to importing the finished mesh of each structure in HyperMesh into Ansys for component assembly and constraint: the foundation and ground are subject to fixed constraint; Common node processing is adopted for each part of the large ladle rotary table. The four jacks on the jacking support and the big bag rotary table are treated with node coupling; The tank roller adopts contact treatment with the track; H-type track is directly connected with the foundation and the embedded iron and also adopts contact treatment; The right end of

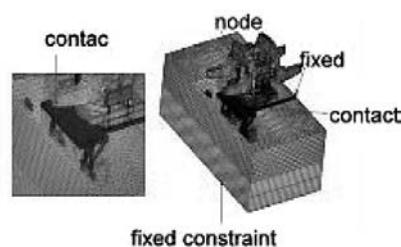

Figure 4 Assembly of finite element model

H-type track is fixed and constrained; Apply a displacement in the X direction to the jacking bracket. The assembly of the finite element model is shown in Figure 4.

Analysis results

According to the transverse movement of the ladle rotary table installation device, the working conditions are divided into three working conditions, and the time and displacement of each working condition are shown in Table 2.

Table 2 Time and displacement corresponding to each working condition

Working condition	Time/s	Displacement in X direction/mm
Working condition one	5	0
Working condition two	222	1 232
Working condition three	600	3 800

According to the working conditions, the finite element analysis of the model is carried out to obtain the stress of the transverse device under different working conditions. ANSYS post-processing results show that it is calculated based on the fourth strength theory, and the calculation formula is as follows :

$$\sigma_c = \sqrt{(\sigma_1 - \sigma_2)^2 + (\sigma_2 - \sigma_3)^2 + (\sigma_3 - \sigma_1)^2} / 2 \leq \sigma_s$$

σ_1 , σ_2 , and σ_3 are the three principal stresses, and σ_s is the yield strength of the material.

The equivalent stress cloud diagram of H-shaped steel track under different working conditions is shown in Figure 5:

As can be seen from Figure 5, the maximum equivalent stress of working conditions 1 to 3 is distributed on the H-shaped steel near the rail, and its maximum equivalent stress values are 459 MPa, 437 MPa and 218

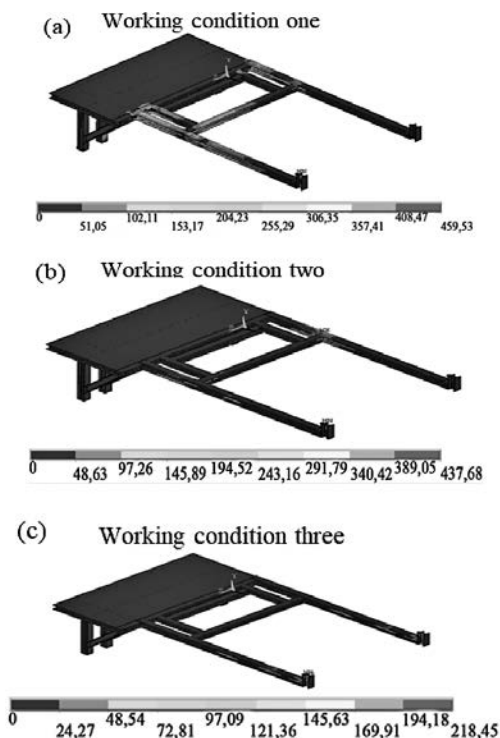

Figure 5 Equivalent stress nephogram of H-shaped steel track under three working conditions

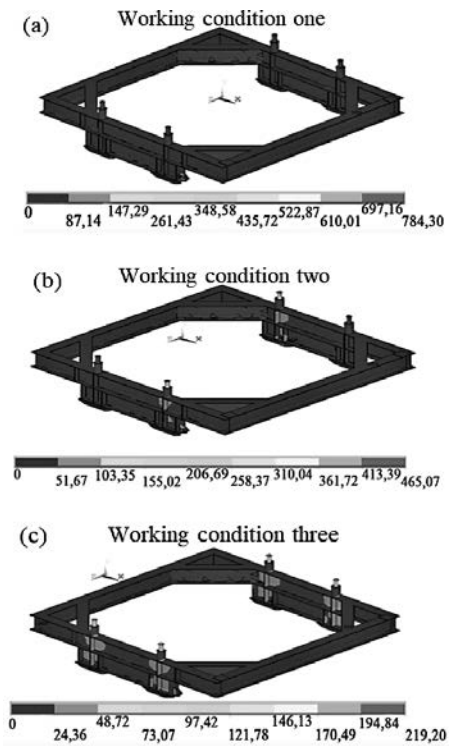

Figure 6 Equivalent stress nephogram of jacking support under three working conditions

MPa respectively. The allowable stress value of H-shaped steel track material is 157 MPa. So the structure needs to be improved.

The equivalent stress cloud diagram of the jacking support under different working conditions is shown in Figure 6:

According to Figure 6, the maximum equivalent stress of working condition 1 and working condition 3 of the jacking support is 176 MPa, the allowable stress value of the material of the jacking support is 784 MPa, 465 MPa and 219 MPa respectively, so the maximum equivalent stress is greater than the allowable stress value.

STRUCTURE OPTIMIZATION

As the equivalent stress of some working parts is greater than the allowable stress, structural optimization should be carried out. The optimized structure diagram is shown in Figure 7.

After optimization, the equivalent stress cloud diagram of H-shaped steel track under different working conditions is shown in Figure 8:

As can be seen from Figure. 8, the maximum equivalent stress of working conditions 1, 2 and 3 are distributed on the H-shaped steel near the rail, and their maxi-

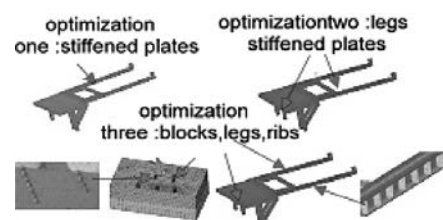

Figure 7 Optimized models of different structures

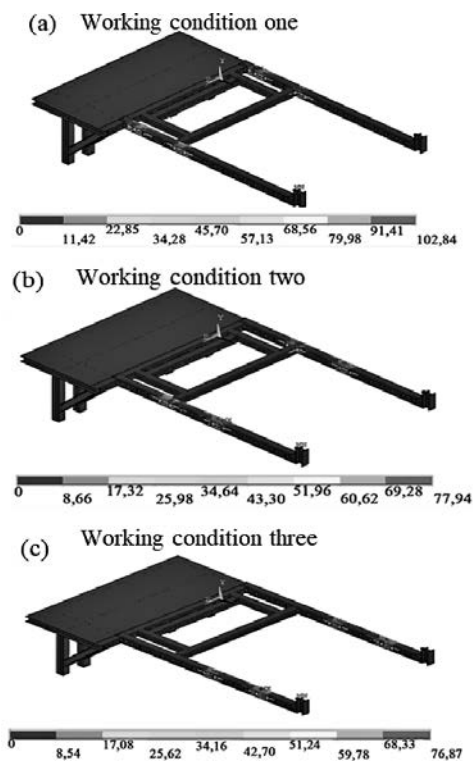

Figure 8 The equivalent stress nephogram of optimized H-shaped steel track under three working conditions

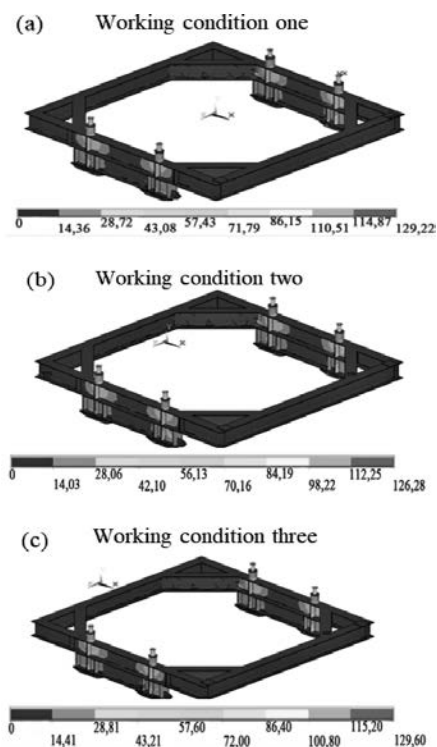

Figure 9 The equivalent stress nephogram of the optimized jacking support under three working conditions

imum equivalent stress values are 102 MPa, 77 MPa and 76 MPa respectively. The allowable stress value of H-shaped steel track material is 225 MPa. It is obvious that the maximum equivalent effects of conditions 1, 2 and 3 are less than their allowable stress values.

After optimization, the equivalent stress cloud diagram of the lifting support under different working conditions is shown in Figure 9.

According to Figure 9, the equivalent stress of the jacking support is 129 MPa, 126 MPa and 129 MPa respectively, and the allowable stress value of the material of the jacking support is 176 MPa, so the maximum equivalent stress value of working condition 1 to working condition 3 is less than the allowable stress value.

The maximum equivalent stress pairs of each component before and after optimization are shown in Table 3.

Table 3 Comparison table of equivalent stress before and after optimization

Unite	Maximum stress/MPa		Data comparis-on
	Initial model	post- -optimization	
H-shaped steel track	472	102,8	- 78 %
Jacking bracket	784	132	- 83 %

After comparison, the equivalent stress of H-shaped steel track and the equivalent stress of jack-up support before and after optimization are reduced by 78 % and 83 %, so the optimization is more reasonable.

CONCLUSION

In this paper, the installation device of ladle rotary table is taken as the research object, the finite element analysis of the device is carried out by ANSYS, and the stress and deformation of the device in the actual installation process is analyzed. In order to ensure the safety of the installation device and make its force in the bearable range, the structure of the original installation device is optimized. The results after optimization are compared with those before optimization, and the deformation and stress of each component are reduced correspondingly, which ensures the safety of the device during use. The research results provide some theoretical guidance for the design and manufacture of the installation device of ladle rotary table.

REFERENCE

- [1] L.Chen. Continuous Casting Steel [M]. Beijing: Metallurgical Industry Press,8(1998),1-3.
- [2] P.J.Wang..Billet Continuous casting [M]. Chinese Society of Metals Continuous Casting Branch,(1998).
- [3] Z.F.Pang J.Yang. Installation Technology of large ladle Rotary Equipment for 2150 slab continuous casting Machine [J].Metallurgical Equipment (2009)S1,110-11,1+142.
- [4] S.J.Lv C.H.Xiao , N.Wang.Rapid integral lifting technique of typical Butterfly ladle rotary table [J]. Continuous Casting 44(2019)02,66-68.
- [5] X.Yu. Zhang L.K.Guan Z.X.Li Finite Element Contact Analysis of Slewing Support of Ladle Slewing Table [J]. Machinery Design & Manufacture (2016)01,130-132.

Note: The responsible translator for English language is R.Q.GONG-North China University of Science and Technology, China