



Research Article

Techno-Environmental Analysis of Facade Integrated Photovoltaics and Electric Vehicle Charging for University Building

Sanjay Khan ^{1,2}, K. Sudhakar ^{1,3,4} and Mohd Hazwan bin Yusof ¹

¹Faculty of Mechanical and Automotive Engineering Technology, Universiti Malaysia Pahang, 26600 Pekan, Pahang, Malaysia

²Automotive Engineering Centre, Universiti Malaysia Pahang, 26600 Pekan, Pahang, Malaysia

³Centre of Excellence for Advancement Research Fluid Flow (CARIFF), Universiti Malaysia Pahang, 26300 Kuantan, Pahang, Malaysia

⁴Energy Centre, Maulana Azad National Institute of Technology, Bhopal 462003, India

Correspondence should be addressed to K. Sudhakar; sudhakar@ump.edu.my

Received 28 May 2022; Revised 2 July 2022; Accepted 6 July 2022; Published 10 August 2022

Academic Editor: Rui Wang

Copyright © 2022 Sanjay Khan et al. This is an open access article distributed under the Creative Commons Attribution License, which permits unrestricted use, distribution, and reproduction in any medium, provided the original work is properly cited.

Electric vehicles (EV) are a relatively contemporary and emerging technology in the transportation and power sectors, with several economic and environmental advantages. However, there are still challenges associated with EV charging depending on on-grid electricity. University buildings that consume a lot of energy continue to rely on the grid and/or conventional fuel for consumption. In addition, EV Charging will create more challenges in meeting the demand; therefore, utilizing university rooftops for EV charging has high prospects of meeting the additional energy demand. In Malaysia, no such research has been presented that has explored the possibility of using academic institute rooftops for BIPV installation for EV Charging in terms of energy and environmental standpoint. The current study analyzes and evaluates a rooftop grid-connected Building Integrated photovoltaic (BIPV) system for generating electricity and EV charging at the University Malaysia Pahang, Malaysia, for EV charging. The system's energy output has been simulated using the PVSyst in two scenarios, i.e., fully integrated with no ventilation and free mounted with air circulation. It was found that 7000 m² of the selected building's rooftop area could be used for panel installation. The panels' total capacity was 1.069 MW, with total annual electricity production of 1587 MWh and 1669 MWh in respective scenarios. The proposed BIPV plant would reduce GHG emissions of 60,031 tons of CO₂e in scenarios 1 and 61,191 tons of CO₂ in scenario 2 compared to the emission produced by coal plants for the same amount of annual energy generation.

1. Introduction

Electric vehicles (EVs) are developing as an effective answer to pollution issues in transportation. However, increasing EV penetration causes grid issues such as power losses [1], voltage variations [2], and decreased power quality [3]. In this context, developing alternative, energy-efficient sources for EV charging to avoid extra burden on the grid, particularly private vehicles, must be prioritized. The building already accounts for around 28% of overall energy-related CO₂ emissions, with two-thirds coming from electricity production for building use. The use of fossil fuels in buildings contributes about 9% of global energy-related CO₂

emissions [4], whereas the primary source of transportation energy is gasoline and other liquid fuels [5], which accounts for 24% of direct CO₂ emissions [6]. With the pace of urbanization, many countries will face challenges in meeting the needs of their growing urban populations, including housing, transportation, energy systems, and other infrastructure [7]. Due to that, the global passenger car fleet is projected to double by 2050, with the majority of growth in developing markets, where an estimated three out of four cars will be found [8]. To accomplish a cleaner transportation sector, electric vehicles are being encouraged. In 2020, there will be 1.7 million Passenger EV which is expected to reach 25 million by 2030 [9]. According to the

Stated Policies Scenario, in 2030, global electricity demand from electric vehicles for LDV will reach 377 TWh, about a seventeen-fold rise from 2019 levels of 21 TWh [10]. Electric vehicles promote a shift away from CO₂-emitting fossil fuels, and solar-powered EV Charging reduces dependency on energy derived from electrical power sources generated through fossil fuels. Much technological and regulatory work has been done in recent years to increase EV adoption [11]. Recently, Government in Malaysia announced Electric cars to be exempted from all import, registration, and sales taxes, and individuals will be eligible for up to RM2,500 in income tax relief on the cost of EV charging infrastructure acquisition, installation, rent, hire purchase, and subscription fees [12], which will increase the EV adoption rate. However, higher pricing, a lack of charging infrastructure, and ambiguous regulation are said to be limiting the adoption of EV's in Malaysia. By decarbonizing the transport sector including EVs and charging through renewable energy, e-mobility will create a cleaner, healthier, and more affordable future for everyone [13].

Higher education institutions play a significant role in developing and promoting renewable and sustainable energy sources. Sustainable development must be integrated into all campus activities, which is the job and obligation of institutions [14]. The university has a multifaceted objective in attaining the educational system's aims; many approaches incorporate environmental education in their curriculum and support a sustainable way of life on campus, such as using renewable energy sources for power generation [15]. With their vast surface area on flat rooftops, industrial sites and office buildings have a lot of potential for photovoltaic (PV) panels. Examples are warehouses, industrial buildings, institutions, factories, and other structures. This potential is now mostly untapped [16]. Institutional solar projects, on the one hand, save electricity costs by utilizing available space on campus, and on the other side, they help the institute's reputation. There has been a lot of research done on the subject of large-scale photovoltaics all around the world, and some of it has included university institutions as well [17]. Parks, woodlands, and an artificial lake make up the majority of campus landscapes, which are also an excellent example of establishing the notion of sustainable development known as a green campus [18].

There have been previous studies regarding large-scale PV plants for power generation and voltage stability improvements of weak national grids [19]. Various studies have been carried out on large-scale SPV integration into the power grid. A review of important power system stability issues associated with large-scale SPV integration into the power grid has been carried out in [20]. The authors in [21] proposed a techno-economic approach to enhance solar PV connectivity. Furthermore, the study carried out in [22] indicates that solar PV systems with improved controllers can improve dynamic reactive power response, thereby enhancing the long-term voltage stability of the grid. Data-driven intelligent and sensor-based models are increasingly being used to monitor electrical power systems, DC microgrids, converters, and piping systems [23–25]. Such techniques can also be applied to EV Charging and large-

scale PV systems for energy management [26, 27]. Also, different authors have studied the feasibility of large-scale PV plant Installation on universities campus to meet the building demand, as represented in Table 1.

This study focuses on the feasibility of the BIPV system's energy generation potential on the rooftop of Universiti Malaysia Pahang (UMP), which is located in Pekan, Malaysia, with a large area (652 acres) [33] can be made "net positive campuses" or "green campus" to become more self-sustainable. Based on internal electricity consumption data, UMP consumed 25,290,106 kWh of power between October 2018–September 2019 and 29,785,332.20 kWh of electricity in 2020 [34]. UMP Campus can accommodate nearly 10000 students and 2000 staffs [33]. Assuming that the total number of 2000 parking slots is available. Charging the EVs will increase the energy consumption, increasing the additional burden on the grid. Also, most of the staff cars are parked at the university for 7 to 8 hours, which provides an opportunity to design a system suitable to meeting EV Charging, and any excess energy can be supplied to the grid. Selected building of Faculty of Mechanical and Automotive Engineering Technology Kampus UMP, the university has been considered in this study which is located in the south of campus. Many studies have focused on BIPV energy potential in residential and nonresidential buildings, but most studies were limited to building energy consumption. There is limited research available on EV charging in the university campus.

1.1. EV Charging. Researchers have emphasized the benefits of switching from ICE-powered cars to Electric Vehicles (EVs) to reduce the transportation sector's greenhouse gas emissions. Many environmental and financial benefits come with the paradigm change from conventional to electric vehicles. One of the biggest obstacles to the adoption of e-mobility is the absence of sufficient infrastructures, such as stations for charging. The demand for charging, however, is rising along with the growth in EVs. However, the construction of charging stations adds to the demand on the power grid because the distribution network's operating characteristics will deteriorate due to the high charging loads of fast EV charging stations [35]. The most popular parking lots, such as garages, eateries, lodging facilities, cottages, campgrounds, shopping malls, business parks, sports facilities, or other establishments with parking, are undoubtedly preferable places to install charging stations [35, 36]. Depending on the availability of charging stations at work [37] or at their university may help the driver choose an EV and reduce driving range anxiety. The key to extending the range of EVs is strategically placing public charging stations [38–40] and enabling and promoting EV use in the neighborhood [39–41].

Additionally, the owner must pay a significant premium for the tariff if billing occurs during peak hours. A PV-grid charging system is suggested [36] to ease this burden. When PV power is available, the spinning reserve capacity decreases, and grid stability increases [37]. Additionally, in the absence of a vehicle, the PV system's electricity can be sent to

TABLE 1: Summary of relevant studies and outcomes.

Location	Findings	Reference
Technical University of Crete Campus, Greece	Area: 13950.2 m ² , polycrystalline solar panels: 8206 Installed capacity: 2.01 MWp Annual energy generation: 1898.8 MWh, could meet 47% of university consumption, with an estimated payback period of 4.2 years with LCOE 11 c€/kWh	[15]
Sultan Qaboos University, Oman	98 kW on-grid solar plant can fulfill the demand of complex (78.6 MWh/year) and additionally export 56 MWh/year of electricity to the utility grid	[28]
MANIT Campus, India	5 MW solar-based PV plant expects to produce 8,000 MWh/year of electricity with an annual reduction of 173,318 carbon footprint.	[29]
Purvanchal Campus, Nepal	Area: 6,157 m ² rooftop solar panels: 3176, installed capacity: 1 MWp, annual electricity production: 1660 MWh per year and could supply 95% to the grid and produce 97% of lesser emissions than diesel generator	[30]
University of New Haven (UNH), Connecticut	Area: 30172 m ² , solar panels: 3147, annual electricity saving of 5.2 million dollars over its lifetime	[31]
University Campus Buildings in Surabaya, Indonesia	Area: 10,353 m ² , rooftop solar panels: 2,070 kWp Annual electricity production: 3,180 MWh per year and could supply up to 80% of the campus energy demand. CO ₂ emission savings: 3,367.6, 2,477.2, or 1,195.7 tons of CO ₂	[32]

the grid for financial advantage [42]. Hence, developing a sustainable solar-powered charging infrastructure without affecting the grid operation has become necessary to meet the requirements of EVs. To move toward an entirely carbon-free future by integrating e-mobility into the transportation sector, it is crucial to allow the integration of renewable energy sources in the growing need for electric vehicle charging infrastructure.

1.2. EV Charging Infrastructure. EV charger specifications have been defined in standards SAEJ1772 and IEC62196 [35, 36], which specify that a dedicated EV socket-outlet and plug must be permanently installed with control and protection functions. Level 1 charging is inexpensive since it uses a regular 110-volt outlet, allowing EV owners to use the charging wire set that comes standard with most electric vehicles practically anywhere. This charging method takes the longest and is typically used as a backup or emergency charging solution [37]. Depending on the 1.4 kW power a typical 120 V wall socket offers at 12 amps, recharge durations are 3 to 5 miles of range per hour [42]. Level 2 chargers are specific solutions for residential and commercial/workplace settings. Most offer higher power output than Level 1 chargers and have additional functionality not available with Level 1 chargers [37]. Level 2 chargers are the most common type found at public charging stations. 220–240 V plugs usually offer around 40 amps and are traditionally more specifically placed in homes [42]. DC fast chargers are the most influential electric vehicle chargers available. They are frequently utilized as range extenders for long-distance excursions and in urban locations to help drivers who do not have access to home charging or who drive a lot. Most DC fast chargers on the market charge at 25–50 kW. DC fast chargers that are now available require inputs of 480+ volts and 100+ amps (50–60 kW) and can charge an EV with a 100-mile range battery in less than 30 minutes (178 miles of electric drive per hour of charging). New generations of DC fast chargers,

which can provide 150–350 kW of power, are gaining favor [42].

It is clear from the context of the previously mentioned literature that there is a sizable gap in designing a solar-powered EV charging station. To close those gaps, this article will focus primarily on the following goals:

1.3. Objective of Research. This paper aims to provide the feasibility of BIPV installation in the university FTKMA building, UMP, and thus specifically focus on the following objectives:

- (i) To design a sustainable grid-connected system suitable for Charging EVs at the university campus.
- (ii) To analyze and compare the techno-environmental performance for two installation scenarios

Scenario 1. BIPV fully integrated with roof with no Ventilation

Scenario 2. BIPV Free mounted—with air circulation

- (iii) To optimize the number of level 2 Electric vehicle charging stations.

2. Methodology

The design methodology, parameters, and technical specifications for the solar BIPV in the university campus for EV Charging have been discussed in this section. The detailed methodology of the study is presented in Figure 1. UMP is situated on the east coast of Peninsular Malaysia, in the state of Pahang, which is the largest of Peninsular Malaysia's state.

2.1. Site Selection and Climate Profile. The site UMP-Pekan has been taken into consideration for analysis. The daily average solar radiation at the site, as per the solar radiation

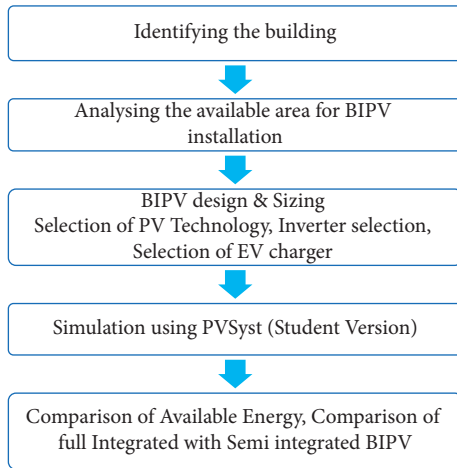

FIGURE 1: Flow chart illustrating the simulation procedure for the analysis.

map of Malaysia is around $4.8 \text{ kWh/m}^2/\text{day}$ (Figure 2). In this study, the university FTKMA faculty building has been chosen (Figure 3), with a sloped roof 10° and a few flat roof buildings with a total area of approximately 7000 m^2 .

Pahang has a Tropical rainforest climate (Classification: Af). The city's yearly temperature is 28.05°C (82.49°F), which is -0.23% lower than Malaysia's average. Pahang typically receives about 138.06 millimeters of precipitation and has 235.09 rainy days annually. Malaysia benefits from ample sunshine and hence high solar radiation. The geographical location of the city, weather data, and solar related parameters are presented in Tables 2–4.

2.2. BIPV System Design. Figure 4 represents selected buildings to include sloped roofs in the study, and Table 5 provides the available area for each structure and the direction of each top facing. It can be analyzed from Table 6; the building's roofs are facing in 2 directions East of North East (ENE), West of South West (WSW).

2.2.1. BIPV Module Selection. CIGS thin-film has been chosen for the study with 360 Wp . The technical specification of the panel is presented in Table 7. CIGS Thin-film panels have high light absorptivity and can absorb up to 90% of the solar spectrum, high electricity-generation capacity and stability, low production cost, and short energy recovery period [46]. AM1.5 cell efficiencies for CIGS of up to 22.6 percent, as certified in 2016, are the result of ongoing research and development [47]. The CIGS-based PV technology has not yet reached its full potential despite its high-efficiency level. An efficiency level close to 30% would be technically possible if all loss mechanisms were addressed simultaneously [48]. A global record for any thin-film technology, the CIGS solar cell efficiency of 22.6 percent is even greater than that of polycrystalline silicon (21.9 percent) [49]. Preliminary data has shown that CIGS has lesser Global warming potential (GWP) than other technologies. The average values for GWP CIGS are $23.92 \text{ gCO}_2\text{eq/kWh}$,

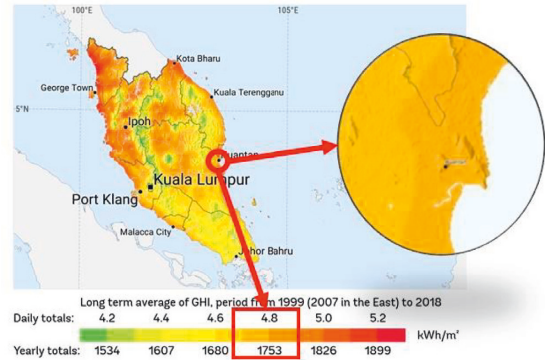

FIGURE 2: Solar radiation map of Pekan, Malaysia [43].



FIGURE 3: Selected location and building.

for a si is $31.5 \text{ gCO}_2\text{eq/kWh}$, for CdTe is $24.1 \text{ gCO}_2\text{eq/kWh}$, for Mono-Si, the average values for GWP is $64.8 \text{ gCO}_2\text{eq/kWh}$ and for poly-si is $54.6 \text{ gCO}_2\text{eq/kWh}$ [50]. Penetration of thin film is currently 5% of the total PV market share [38].

2.3. BIPV Plant Capacity. Installation Method:

Two different installation methods will be analyzed in this paper, as represented in Figure 5.

Scenario 1: BIPV integrated with fully insulated back (No ventilation).

Scenario 2: Free mounted modules with air circulation.

The input data for the simulation of the BIPV system is presented in Table 8.

2.3.1. Thermal Loss Factor and Cell Temperature. The cell temperature of PV modules affects its operational efficiency

TABLE 2: Site selection data.

Location name	Latitude and longitude	Climate zone
UMP-Pekan, Pahang, Malaysia	3°32'15"N 103°25'48"E	Tropical rainforest

TABLE 3: Weather data, pekan [44].

Weather parameters	Min. Temp °C	Max. Temp °C	Avg. Sun hours
Jan	24.2	27	8
Feb	24.4	27.7	8.4
Mar	24.8	28.6	8.6
Apr	25.2	29.4	9.3
May	25.6	29.8	9.9
Jun	25.4	29.5	10.1
Jul	25.2	29.2	10
Aug	25.1	29.2	10
Sep	24.9	29.2	10.1
Oct	24.8	28.9	9.5
Nov	24.6	28	8.4
Dec	24.4	27.3	7.8

TABLE 4: Site solar parameters [45].

Parameters	Pahang, Malaysia
Direct normal irradiation	1111.1 kWh/m ² /Year
Global horizontal irradiation	1780.0 kWh/m ² /Year
Diffuse horizontal irradiation	937.1 kWh/m ² /Year
Global tilted irradiation at an optimum angle	1782.1 kWh/m ² /Year
Optimum Tilt	3/180
Air temperature	26.9°C
Terrain elevation	9 m



FIGURE 4: Selected building of the university [Image from Google Earth].

and the thermal loss in the PV array due to the difference between the cell temperature and the ambient temperature of the PV array. The thermal loss factor (U) is connected to the cell temperature (T_{cell}) and the ambient temperature (T_a)

TABLE 5: Available area for BIPV Installation [Measurement taken from Google Earth].

Building	Area (m ²)	Roof slope	Roof orientation
1	2000	5°	13° ENE and 13° WSW
2	2000	5°	13° ENE and 13° WSW
3	1000	5°	13° WSW
4	2000	5°	13° ENE and 13° WSW
Total area	7000		

TABLE 6: Available area with respect to direction.

Direction	ENE	WSW
Area	3000 m ²	4000 m ²

TABLE 7: Specification of the selected panel.

Brand	Eterbright
Country of origin	Taiwan
Models	CIGS-3600A1
Cell type	CIGS thin-film
Dimensions (mm)	1901 × 1237 × 45
Nominal power PMPP (W)	355
Open circuit voltage VOC (V)	74.1
Short circuit current ISC (A)	6.96
Voltage at Pmax VMPP (V)	57
Current at Pmax IMPP (A)	6.32
Module efficiency (%)	≥15.3
Degradation per year	0.8%

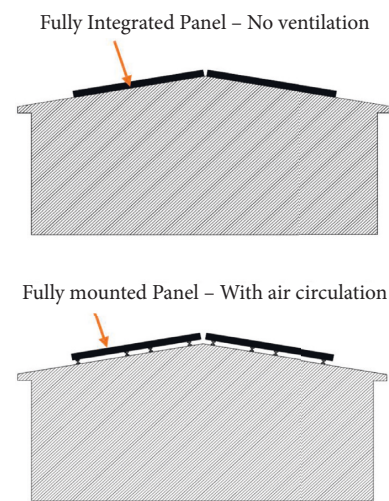

FIGURE 5: BIPV mounting in Scenario 1 and Scenarios 2.

according to the models used in PVsyst for the thermal behavior of PV module are as follows [39]:

TABLE 8: BIPV system-inputs for simulation.

BIPV system	Roof A	Roof B
Area (m ²)	3000	4000
Roof facing direction	13° WSW	13°ENE
Number of modules	1278	1692

$$U = \frac{\alpha(G)(1 - \eta)}{T_{\text{cell}} - T_{\alpha}}, \quad (1)$$

where U is the thermal loss factor, α is the absorption coefficient, η is the efficiency of PV at the Standard testing condition, and G in W/m^2 is the solar radiance on the tilted plane of the module. Furthermore, U consists of constant loss factor (U_0) and wind loss factor (U_v). In PVSyst, U_v is set to 0, ($U_v = 0$) hence $U = U_0$. Therefore, PV cell temperature can be found as per the below equation:

$$T_{\text{cell}} = T_{\alpha} + \frac{\alpha(G)(1 - \eta)}{U}, \quad (2)$$

$$T_{\text{cell}} = T_{\alpha} + \frac{\alpha(G)(1 - \eta)}{U_0}.$$

Default values in PVSyst are as follows: $U_0 = 15$, $U_1 = 0$ for integration with a fully insulated back, $U_0 = 29$, $U_1 = 0$ for free mounted modules with air circulation [39].

2.3.2. BIPV Module Installation Layout. The design of the PV power system examined in this study is depicted in Figure 6. The Maximum BIPV panel installed in each structure is shown in Figure 7.

Total number of panels required for the 1.069 MW system is 2970 covering a module area of 6984 m² having array configuration as shown in Figure 8. The total number of modules in series 9 and the number of strings 330 are considered for the BIPV design. The operating characteristics of the array at 50° are $U_{\text{mpp}} 482^\circ\text{V}$ and $I_{\text{mpp}} 2065 \text{ A}$ with $P_{\text{mpp}} 995 \text{ kWp}$.

2.4. Inverter Selection. For the above configuration of arrays, Siemens Sinvert 1000 MS inverter has been selected, which matches the specification's requirements. The inverter's power must be chosen according to the sum of all loads' power. It must not exceed the rated capacity of the inverter. Also, the inverter must supply 1.069 MW power to BIPV-powered EV charging parking. Table 9 refers to the inverter specification.

2.5. Daily EV Charging Energy Requirement. Presently, several EVs are available in the Malaysian market supporting Type 2 charging. To estimate number of EV's that can be charged, the parameters shown in Table 10 have been assumed, e.g., car model, Daily commute distance, number of parking slots available on the university campus, and EV battery size. where BC is Battery capacity, D is daily commute distance, and R is EV range.

$$E_{\text{EV Daily}} = \frac{BC \times D}{R}. \quad (3)$$

Based on the above calculation, the daily EV charging requirement is approximately 2.44 kWh. The total energy required by 2000 EVs is approximately 4.88 MWh.

3. Result

PVSyst (Student) software was used to analyze the input data for yearly energy generation. Available energy has been simulated to be used for EV charging in both scenarios. Table 11 below depicts the actual energy available at Array output after considering the losses for both Scenario 1 and Scenario 2.

3.1. BIPV Energy Performance. The simulation results that annual energy production from the system is 1587 MWh and 1669 MWh for respective scenarios. Figure 9 shows monthly energy generation, monthly user consumption, and energy supply to the grid at inverter output for both systems. For the user, energy consumption only on weekdays has been considered, and excess energy generated during weekends has been deemed to be fed to the grid.

3.1.1. Performance Ratio. Performance ratio (PR) is the ratio of measured output to expected output for a given reporting period based on the system name-plate rating. Performance ratios of the two scenarios have been estimated by PVSyst and compared in Figure 10. This enables the system quality to be compared between installation methods.

3.1.2. Capacity Utilization Factor. The Capacity Utilization Factor (CUF) for a Solar Photovoltaic (PV) project is the ratio of actual energy generated by the PV project over the year to the equivalent energy production at its rated capacity. The number of clear sunny days and solar radiation, measured in kWh/sq m/day, determine the amount of energy generated by the SPV project. Solar Cell output is measured in Watt Peak (Wp) and corresponds to nominal power under Standard Test Conditions (STC) (1000 W/m², 250C, 1.5 AM) [51].

$$\text{CUF} = \frac{P_{\text{OUT}}}{P_{\text{Cap}}} \times 100, \quad (4)$$

$$P_{\text{Cap}} = P_{\text{SIZE}} \times 365 \times 24,$$

where P_{Cap} is plant capacity operated for 24 hours and 365 days, P_{Size} is Plant size in kW, P_{OUT} Actual output of the plant in kWh, CUF of the BIPV plants is estimated using the above equation, which is 16.9% and 17.8% in case of scenario 1 and 2.

3.2. Mobility Demands: EV Charging Potential. As shown in Figure 9, energy generated monthly by the two BIPV scenarios, further evaluation of EV charging has been done using energy generated daily shown in the table below.

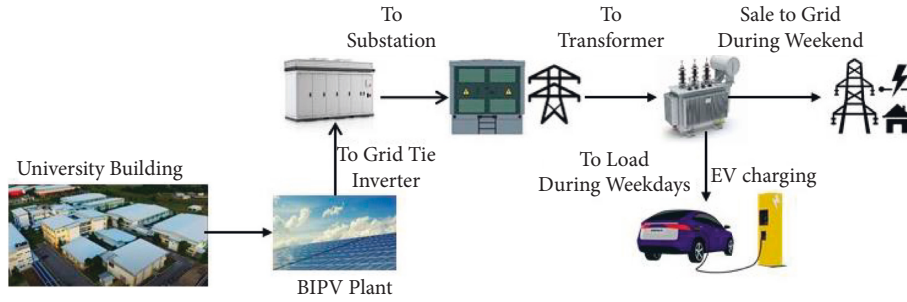

FIGURE 6: Detailed layout of grid-connected with BIPV-powered EV Charging system.

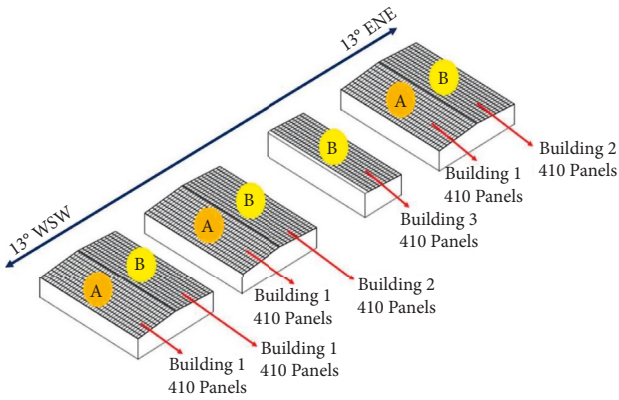

FIGURE 7: Module Layout-Maximum number of the panel which can be installed.

Minimum daily energy production happens in November, which has been used for estimating the number of EV's charging potential. Considering the number of parking available in the university, which is 2000, the daily requirement energy is 4.88 MWh.

3.2.1. *Number of Charging Stations.* The proposed BIPV plant can meet the energy requirement of 2000 EV's. Two cases have been studied to optimize the charging conditions further. Level 2 charging can supply 6.2 kW to 7.7 kW, which can meet the charging energy requirement in 15 minutes for each Car. Therefore, the below case has been studied for optimizing the number of charging points.

Case 1. If all the cars are connected at the same time

$$P_1 = P_{\text{Charger}} \text{ (kW)} \times N_1, \tag{5}$$

$$P_1 = 6.2 \text{ kW} \times 2000 = 12,400 \text{ kW},$$

where P_1 is the power requirement when all the EV's are connected, P_{Charger} is Charger output, and N_1 is the number of EV, which is 2000 for case 1.

The power requirement for charging for all cars is very high and exceeds the system size and not a feasible solution. Therefore, several charging stations should be optimized to utilize the system. Since it is a grid-connected system, all excess energy will be taken from the grid.

Time required to charge each car.

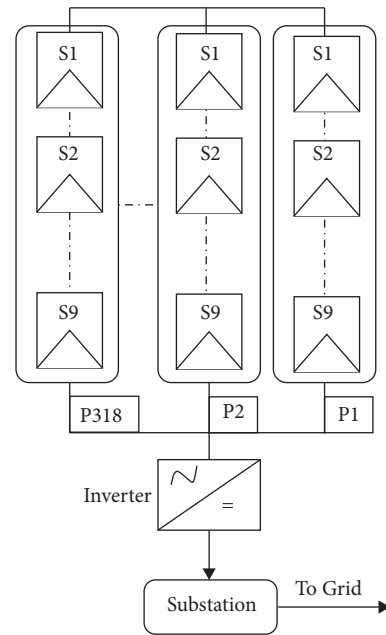

FIGURE 8: Array configuration.

$$t = \frac{E_{\text{EV-daily}} \text{ (kWh)}}{P_{\text{charger}} \text{ (kW)}}, \tag{6}$$

where t is time required to charge each EV which is approximately $0.25 \text{ hr} = 23 \text{ minutes}$ considering no losses. The case is not a feasible solution as after 15 minutes. All the charging stations will become idle. There will be a sudden peak in power demand. Therefore, Case 2 has been proposed for optimizing the number of charging stations and utilizing its full potential.

Case 2. If the cars are charged based on need.

Charging stations can be separated into Zones to balance the load. As the staff or student's cars will be parked for 6 to 7 hours, the number of charging stations can be optimized as below:

$$N = \frac{\text{Car parking hours}}{t}, \tag{7}$$

$$N = \frac{6}{0.39} = 15.3 \sim 16,$$

TABLE 9: Inverter specifications for Siemen Sinvert 1000 MS.

Input		Output	
Recommended max. PV power	1119 kWp	Rated output power	1071 kW
Max. Operating voltage	820 V	Grid Connection	3–230 V/400 V
Nominal voltage	360 V	Rated AC grid frequency	50 Hz/60 Hz
Start-up voltage	100 V	Max. Output current	1554 A
MPPT voltage range	450 V~750 V	Adjustable power factor	0.8 leading ...0.8 lagging
Number of MPPT Tracker	12	AC grid connection type	Single Phase
Rated input current	2460	Max. total harmonic distortion	≤3%
Max. Current per DC input	250 A	Efficiency	
Eta EU	96.10%	Max. efficiency	96.50%

TABLE 10: List of assumptions.

Parameters	Value
Average daily commute distance [40]	19 km
EV battery size [41]	39.2 kWh
Range	305 km
EV charging requirement/day	2.44 kWh
Number of parking slots assumption	2000

where N is the number of charging station zones is approximately 16 with 125 Charging points (total 2000).

Power requirement for 125 EV at the time of connection

$$P_2 = P_{\text{Charger}} (\text{kW}) \times N_2, \quad (8)$$

$$P_2 = \frac{6.2 \times 125}{1000} = 0.775 \text{ MW},$$

where P_2 is the power required by the EV at the time of connection which is 0.775 MW, which is lower than the size of the system. N_2 is the number of EV connected in 125 charging points. This scenario provides an optimized solution for EV charging. Intelligent charging can also be introduced to balance the power output from the BIPV plant and input to the EV charging [52].

Figure 11 compares the daily energy requirement for 2000 EV's and average daily energy generation in both scenarios 1 and 2 and excess energy to/from to grid.

3.2.2. Energy Supply to Grid. From the above figure, it is clear that the energy generation is positively impacting the overall consumption and can meet the energy requirement of 2000 EV's for daily charging and any excess energy fed to the grid. Consumption on weekends (Saturday and Sunday) has been assumed to be zero. There all energy will be supplied to the grid on weekends. The total annual energy fed to the grid for both scenarios has been plotted in Figure 12 to analyze the overall positive impact of the system. The number of working days is considered 261, excluding all weekends.

$$E_{\text{EV-Total}} = E_{\text{EV-Daily}} \times 261, \quad (9)$$

$$E_{\text{EV-Total}} = 4.88 \times 261 = 1273.68 \text{ MWh},$$

where $E_{\text{EV-Total}}$ is the annual energy required for EV charging.

Annual energy for scenario 1 is 1587 MWh and for Scenario 2 is 1669 MWh. 0.8% panel degradation has been applied for 25 years to analyze total energy generation for a lifetime, as shown in Figure 12. The power drawn or fed to the grid can be expressed as given below:

$$E_{\text{grid}} = E_{\text{PV-Total}} - E_{\text{EV-Total}}, \quad (10)$$

where E_{Grid} is Energy fed to the grid.

$E_{\text{PV-Total}}$ is total annual energy generated by the plant. Total energy supplied to the grid during the lifetime of 25 years will be 4247 MWh for Scenario 1 and 6112 MWh for scenario 2.

3.3. Environment Analysis. The most significant environmental advantage of using solar power to generate clean electricity is that it substitutes energy from conventional power plants. Also, charging EV through PV power helps in achieving net-zero transportation. Since the BIPV Plant uses solar energy to meet the EV charging need, the carbon-dioxide emissions reductions from not utilizing grid electricity are calculated using emission factors. An emission factor is the average rate of a particular GHG emission for a specific source in terms of units of activity [53]. The grid emission factor for Malaysia is expected to rise from 570 gCO₂e/kWh to 622 gCO₂e/kWh between 2018 and 2023 because of the addition of new coal and gas electricity-generation plants [54].

3.3.1. GHG Savings. Total annual GHG savings for the Scenario 1 and Scenario 2 comprise GHG savings due to the BIPV system and the use of EV is presented in Figure 13. Grid emission of 622 gCO₂e/kWh has been used for GHG emission savings. Total energy generation over the lifetime of 25 years in Scenario 1 is 36,089 MWh, and scenario 2 is 37,954 M. The equivalent saved CO₂ emissions for BIPV System has been calculated using the below formula:

$$\text{GHG}_{\text{BIPV}} = E_{\text{Service}} \times F_{\text{Grid}}, \quad (11)$$

TABLE 11: Available energy after losses for both scenarios (data from PVSystem).

Parameters	Scenario 1	Scenario 2
Global horizontal irradiation	1813 kWh/m ²	1813 kWh/m ²
Global incident in coll. Plane	-0.13%	-0.13%
Far Shading/Horizon	-0.12%	-0.12%
Near Shading irradiation loss	-0.03%	-0.10%
IAM factor global	-2.09%	-3.32%
Effective irradiation on collectors	1770 kWh/m ² × 6984 m ²	1770 kWh/m ² × 6984 m ²
Efficiency at STC	15.32%	15.32%
Array nominal energy (at STC)	1894 MWh	1894 MWh
Module degradation loss(For 1st Year)	-0.80%	-0.80%
PV loss due to irradiance level	-1.65%	-1.65%
PV loss due to temperature	-10.30%	-5.67%
Spectral correction	-1.39%	-1.39%
Light soaking for CIS	3.50%	3.50%
Module quality loss	0.63%	0.63%
Mismatch loss, modules and strings	-2.10%	-2.10%
Ohmic wiring losses	-1.02%	-0.99%
Mixed orientation mismatch loss	-0.03%	-0.02%
Array virtual energy at MPP	1649 MWh	1734 MWh
Inverter loss during operation	-3.70%	-3.70%
Inverter loss due to voltage threshold	-0.04%	-0.04%
Available energy at inverter output	1587 MWh	1669 MWh

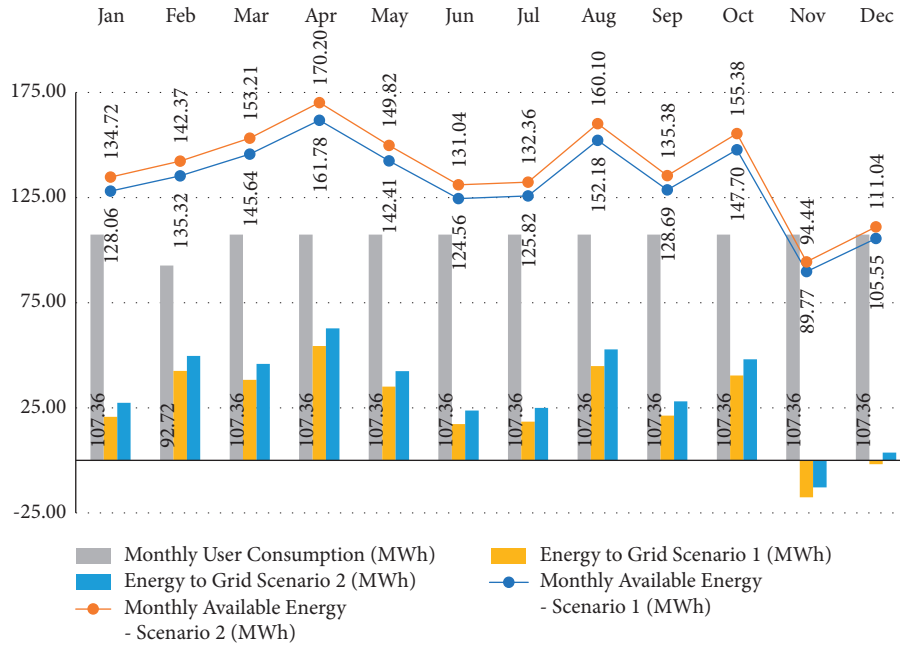

FIGURE 9: Comparison of monthly available energy at inverter output, monthly consumption, and monthly supply to the grid.

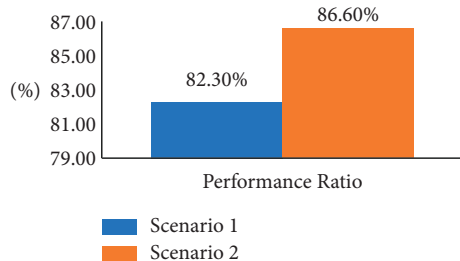

FIGURE 10: Comparison of performance ratio.

where GHG_{BIPV} is GHG savings from BIPV Plant, $E_{Service}$ is Energy generation over 25 year's service of plant, F_{Grid} is grid emission factor.

An average consumption of 5 liters/100 km then corresponds to $5 l \times 2392 g/l/100 \text{ per km} = 120 g \text{ CO}_2/\text{km}$ [55]. For estimation of GHG savings due to gasoline avoidance, 2000 cars, 24 km daily for 261 days has been considered for 25 years.

$$GHG_{EV} = \frac{F_{Gas} \times N \times D_{com} \times 261 \text{ days} \times Y}{1000}, \quad (12)$$

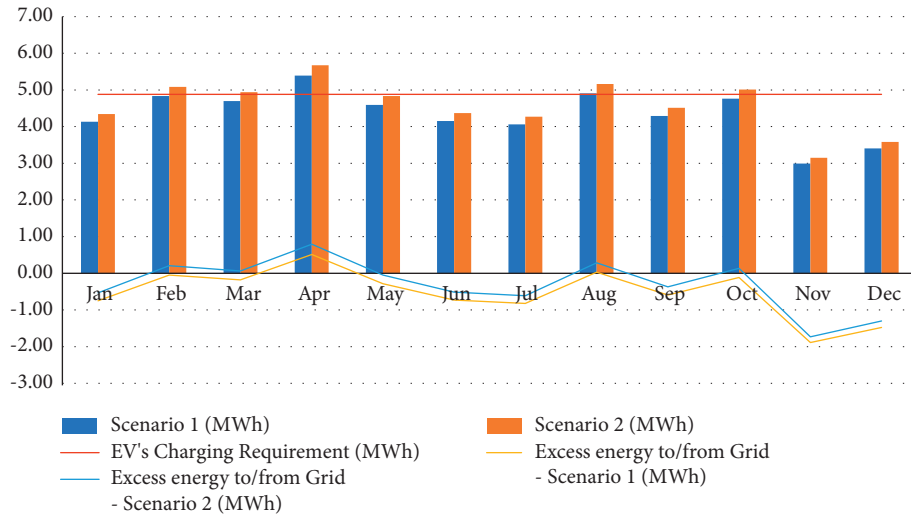

FIGURE 11: Average daily energy generation, energy consumption and excess energy to/from grid.

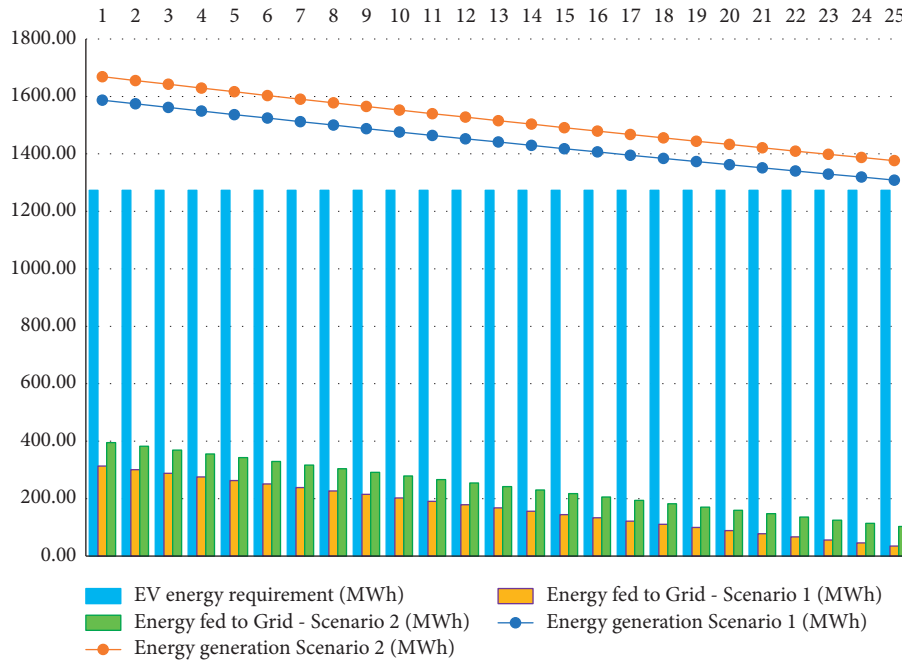

FIGURE 12: Comparison of Annual energy generation, annual EV energy requirement, and energy fed to the grid in MWh for 25 years.

where GHG_{EV} is $GHG_{savings}$ by using EV avoiding gasoline in (tCO_2e), N is the number of cars, D_{Com} is $daily_{commute}$ distance, F_{Gas} is $CO_{2emission}/Kilometer$, and Y is number of years.

The limitation of the GHG emission includes the GHG emitted during the fabrication of PV modules cells; BOS transportation and disposal are not considered here. Also, emission during the production of EV has been excluded from the study.

4. Discussion

The paper presented the full potential of the selected building in Universiti Malaysia Pahang, Pekan campus. Two

scenarios were analyzed: scenario 1 having a BIPV system fully integrated (No ventilation) and scenario 2 having BIPV with air circulation, which generated higher annual energy than scenario 1. Figure 11 compares the daily energy requirement with the energy requirement for EV charging, where higher daily energy was generated during April, and the lowest energy was generated in November. Both proposed systems can nearly meet the daily charging requirement of 2000 EV's with the amount of daily energy generation. During November, excess energy will be required from the grid to meet the demand of EV charging, with 38% in scenario 1 and 35% in scenario 2. On an annual basis, both systems could supply the excess energy to the grid. From Figure 13, it can be concluded that there is a

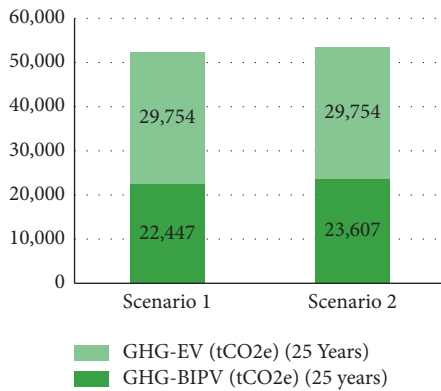

FIGURE 13: Total GHG savings for the BIPV Plant and avoiding gasoline by using EV.

significant reduction in CO₂ emission compared to the CO₂ emitted if the same amount of energy is generated by a coal plant. There are a few limitations to the research, as shown below:

- (i) Minor inaccuracies could be possible due to manual measurement using the Google Earth tool. Little variation in total energy generation is possible.
- (ii) The cost of the system has been excluded in the study as this study focuses on the energy generation potential for the number of EV charging and the environmental impact of the installed BIPV plant.
- (iii) Losses during EV charging have not been considered in the study.
- (iv) The scope is limited to studying the energy potential of roof-mounted BIPV.
- (v) The generalizability of the findings in this work to other universities is unknown, even though the procedure can be used at other campuses.
- (vi) Another limitation to the study is the number of variables that can affect EV charging requirements, i.e., Battery state of charge at the time of charging.
- (vii) Moreover, this study considered only a few possible assumptions, such as commute distance and car battery size.

This research provides an opportunity to contribute towards achieving sustainable development goal, which is SDG 7 “affordable and clean energy, SDG11 “sustainable cities and communities and SDG 12 “responsible consumption and production” [56]. It will serve as baseline data for practical implementation and may invoke enormous interest among the research community and stakeholders. Charging electric vehicles using renewable energy decreases the grid’s excess load and helps achieve net-zero mobility.

5. Conclusion and Future Scope

Charging electric vehicles at a university campus or workplace using solar energy gives a long-term sustainable mobility solution. It allows for direct use of BIPV electricity

throughout the day and uses the solar potential of university building rooftops. The energy and environmental performances of the BIPV Plant for the EV charging system have been evaluated for UMP, Pekan Campus. For the proposed BIPV system, two different installation method was studied—Scenario 1 Fully Integrated Panel with No ventilation and Scenario 2 Free mounted with Air circulation with the same panel rating of 360 kWp. The results from the study include the following.

- (i) The maximum annual energy yield of the 1 MW BIPV Plant was estimated to be 1587 MWh and 1669 MWh for Scenario 1 and Scenario 2.
- (ii) BIPV System in scenario 2 has a 50% lesser loss due to temperature because air ventilation underneath the BIPV panels affects the final output.
- (iii) The performance ratio of the two BIPV Plant is between 82.6% and 86%. The system in Scenario 2 has higher PR.
- (iv) Capacity utilization is between 16.9% and 17.8%, where the BIPV plant in scenario 2 has a higher CUF than in scenario 1.
- (v) The project can meet the charging requirement for 2000 EVs, which is 80% of total annual generated energy in scenario 1 and 76% in scenario 2. Available excess energy is considered to be fed to the grid.
- (vi) Despite having the same panel in both scenarios, the BIPV system in scenario 2 has better performance in terms of energy generation; both systems in scenario 1 and scenario 2 have shown a significant impact on the environment GHG emission savings of 52.201 tCO₂e for scenario 1 and 53,361 tCO₂e for scenario 2 compared to grid emission over the lifetime of the system.
- (vii) The scope of this paper is limited to the FTKMA Building only, which can be extended to other Faculty buildings to evaluate the full potential of the campus to meet the total energy requirement of the campus.
- (viii) The future scope of this paper may include a Battery storage system to avoid grid dependence and intelligent charging of EVs for load scheduling that can solve the issue of system overloading.

Data Availability

The data used to support the findings of this study are included within the article.

Disclosure

This manuscript’s opinions, facts, insights, and discussions solely involve the authors. It does not necessarily reflect the policy and standpoint of any organization directly or indirectly. The authors are not responsible for any consequences of the information presented in this work.

Conflicts of Interest

The authors declare that they have no conflicts of interest.

Acknowledgments

The authors are grateful for the PGRS 210349 grant by the Universiti Malaysia Pahang.

References

- [1] K. Clement-Nyns, E. Haesen, and J. Driesen, "The impact of Charging plug-in hybrid electric vehicles on a residential distribution grid," *IEEE Transactions on Power Systems*, vol. 25, no. 1, pp. 371–380, 2010.
- [2] G. Wang, Z. Xu, F. Wen, and K. P. Wong, "Traffic-constrained multiobjective planning of electric-vehicle charging stations," *IEEE Transactions on Power Delivery*, vol. 28, no. 4, pp. 2363–2372, 2013.
- [3] R. Mostafa, E. Mohsen, and M. H. Amini, "A Bi-layer multi-objective techno-economical optimization model for optimal integration of distributed energy resources into smart/micro grids," 2022, <https://ideas.repec.org/a/gam/jeners/v13y2020i7p1706-d341214.html>.
- [4] Iea, "Tracking buildings 2021 – analysis - IEA," 2022, <https://www.iea.org/reports/tracking-buildings-2021>.
- [5] Eia, "Transportation sector energy consumption Figure 8-1. Delivered transportation energy consumption by country grouping," 2012, <https://www.eia.gov/outlooks/ieo/pdf/transportation.pdf>.
- [6] Iea, "Tracking transport 2020 – analysis - IEA," 2021, <https://www.iea.org/reports/tracking-transport-2020>.
- [7] Un, "68% of the world population projected to live in urban areas by 2050, says UN | UN DESA | United Nations Department of Economic and Social Affairs," 2021, <https://www.un.org/development/desa/en/news/population/2018-revision-of-world-urbanization-prospects.html>.
- [8] Unep, "Why does electric mobility matter? | UNEP - UN environment programme," 2021, <https://www.unep.org/explore-topics/transport/what-we-do/electric-mobility/why-does-electric-mobility-matter>.
- [9] Bnef, "EVO report 2021 | BloombergNEF | bloomberg finance LP," 2021, <https://about.bnef.com/electric-vehicle-outlook/>.
- [10] International Energy Agency, "Global EV Outlook 2020 Entering the decade of electric drive?" IEA, 2020, <https://www.iea.org/reports/global-ev-outlook-2020>.
- [11] "Global EV outlook 2020 – analysis - IEA," 2021, <https://www.iea.org/reports/global-ev-outlook-2020>.
- [12] Paultan, "Budget 2022: EVs in Malaysia to be completely tax free soon - zero import and excise duties, free road tax! - paultan.org," 2022, <https://paultan.org/2021/10/29/budget-2022-evs-in-malaysia-to-be-completely-tax-free-soon/>.
- [13] Danfoss, "What is E-mobility? – all you need to know about electromobility | Danfoss," 2022, <https://www.danfoss.com/en/about-danfoss/insights-for-tomorrow/e-mobility/>.
- [14] J. M. Pearce, "Catalyzing mass production of solar photovoltaic cells using university driven green purchasing," *International Journal of Sustainability in Higher Education*, vol. 7, no. 4, pp. 425–436, 2006.
- [15] D. Hasapis, N. Savvakis, T. Tsoutsos, K. Kalaitzakis, S. Psychis, and N. P. Nikolaidis, "Design of large scale prosuming in Universities: the solar energy vision of the TUC campus," *Energy and Buildings*, vol. 141, pp. 39–55, 2017.
- [16] G. R. Chandra Mouli, P. Bauer, and M. Zeman, "System design for a solar powered electric vehicle charging station for workplaces," *Applied Energy*, vol. 168, pp. 434–443, 2016.
- [17] Y. Krishna, M. F. Fauzan, and N. B. Muhammad Nurhisham Gan, "Design and simulation of a rooftop PV system in taylor's university lakeside campus," *J Phys Conf Ser*, vol. 2120, no. 1, Article ID 012035, 2021.
- [18] R. Thiab, M. Amudy, and T. A. Rizal, "Study on implementation of rooftop photovoltaic power plant as an effort to attain a sustainable campus," *European Journal of Engineering Research and Science*, vol. 4, no. 11, pp. 21–25, 2019.
- [19] B. B. Adetokun, J. O. Ojo, and C. M. Muriithi, "Application of large-scale grid-connected solar photovoltaic system for voltage stability improvement of weak national grids," *Scientific Reports*, vol. 11, Article ID 24526, 2021.
- [20] R. Shah, N. Mithulananthan, R. C. Bansal, and V. K. Ramachandaramurthy, "A review of key power system stability challenges for large-scale PV integration," *Renewable and Sustainable Energy Reviews*, vol. 41, pp. 1423–1436, 2015.
- [21] A. R. Othman and A. T. Rushdi, "Potential of building integrated photovoltaic application on roof top of residential development in shah alam," *Procedia - Social and Behavioral Sciences*, vol. 153, pp. 491–500, 2014.
- [22] E. Munkhchuluun, L. Meegahapola, and A. Vahidnia, "Long-term voltage stability with large-scale solar-photovoltaic (PV) generation," *International Journal of Electrical Power & Energy Systems*, vol. 117, Article ID 105663, 2020.
- [23] R. Wang, Q. Sun, P. Tu, J. Xiao, Y. Gui, and P. Wang, "Reduced-Order aggregate model for large-scale converters with inhomogeneous initial conditions in DC microgrids," *IEEE Transactions on Energy Conversion*, vol. 36, no. 3, pp. 2473–2484, 2021.
- [24] X. Hu, H. Zhang, D. Ma, and R. Wang, "A tnGAN-based leak detection method for pipeline network considering incomplete sensor data," *IEEE Transactions on Instrumentation and Measurement*, vol. 70, pp. 1–10, 2021.
- [25] X. Hu, H. Zhang, D. Ma, R. Wang, and P. Tu, "Small leak location for intelligent pipeline system via action-dependent heuristic dynamic programming," *IEEE Transactions on Industrial Electronics*, vol. 69, no. 11, Article ID 11723, 2022.
- [26] D. Fuselli, F. De Angelis, M. Boaro et al., "Action dependent heuristic dynamic programming for home energy resource scheduling," *International Journal of Electrical Power & Energy Systems*, vol. 48, pp. 148–160, 2013.
- [27] M. El-Shimy, A. Sharaf, H. Khairy, and G. Hashem, "Reduced-order modelling of solar-PV generators for small-signal stability assessment of power systems and estimation of maximum penetration levels," *IET Generation, Transmission & Distribution*, vol. 12, no. 8, pp. 1838–1847, 2018.
- [28] R. Ahshan, R. Al-Abri, H. Al-Zakwan, N. Ambu-saidi, and E. Hossain, "Design and economic analysis of a solar photovoltaic system for a campus sports complex," *International Journal of Renewable Energy Resources*, vol. 10, pp. 67–78, 2020.
- [29] A. S. Baitule and K. Sudhakar, "Solar powered green campus: a simulation study," *International Journal of Low Carbon Technologies*, vol. 12, no. 4, pp. 400–410, 2017.
- [30] B. Paudel, N. Regmi, P. Phuyal et al., "Techno-economic and environmental assessment of utilizing campus building

- rooftops for solar PV power generation,” *International Journal of Green Energy*, vol. 18, pp. 1469–1481, 2021.
- [31] J. Lee, “Economic feasibility study of photovoltaic system on UNH campus,” 2015, https://www.newhaven.edu/_resources/documents/academics/surf/past-projects/2015/jongsung-lee-paper.pdf.
- [32] E. Tarigan, “Simulation and feasibility studies of rooftop PV system for university campus buildings in Surabaya, Indonesia,” *International Journal of Renewable Energy Resources*, vol. 8, pp. 895–908, 2018.
- [33] Ump, “Laporan tahunan 2019,” 2019, <https://www.ump.edu.my/publication/annual-report/ump-annual-report-2019.pdf>.
- [34] Ump, “Univerisi Malaysia Pahang. Sustainability report 2019/2020,” 2020, <https://mygreen.ump.edu.my/index.php/report-2019-2020>.
- [35] S. Deb, K. Tammi, K. Kalita, and P. Mahanta, “Impact of electric vehicle charging station load on distribution network,” *Energies*, vol. 11, no. 1, p. 178, 2018.
- [36] C. Hamilton, G. Gamboa, J. Elmes et al., “System architecture of a modular direct-DC PV charging station for plug-in electric vehicles,” in *Proceedings of the IECON 2010 - 36th Annual Conference on IEEE Industrial Electronics Society*, pp. 2516–2520, Glendale, AZ, USA, November 2010.
- [37] Uhero, “Statewide economy and electricity-sector models for assessment of Hawai‘i energy Policies · UHERO,” 2022, <https://uhero.hawaii.edu/statewide-economy-and-electricity-sector-models-for-assessment-of-hawaii-energy-policies/>.
- [38] Detollenaere - Becquerel Institute, “A Snapshot of Global PV Markets 2020 PVPS Task 1 Strategic PV Analysis and Outreach,” 2020, https://iea-pvps.org/wp-content/uploads/2020/04/IEA_PVPS_Snapshot_2020.pdf.
- [39] Pvsyst, “Project design > Array and system losses > Array Thermal losses,” 2022, https://www.pvsyst.com/help/thermal_loss.htm.
- [40] numbeo, “Traffic in kuala lumpur,” 2021, <https://www.numbeo.com/traffic/in/Kuala-Lumpur>.
- [41] Paultan, “Hyundai Kona Electric launched in Malaysia - three variants, 305 to 484 km range, fr. RM150k to RM200k - paultan.org,” 2022, <https://paultan.org/2021/11/23/hyundai-kona-electric-launched-in-malaysia-three-variants-305-to-484-km-range-fr-rm150k-to-rm200k/>.
- [42] N. Naghizadeh and S. S. Williamson, “A comprehensive review of power electronic converter topologies to integrate photovoltaics (PV), AC grid, and electric vehicles,” in *Proceedings of the IEEE Transp Electrification Conf Expo Components, Syst Power Electron - From Technol to Bus Public Policy ITEC*, Detroit, MI, USA, June 2013.
- [43] Solargis, “Solar resource maps and GIS data for 200+ countries | Solargis,” 2022, <https://solargis.com/maps-and-gis-data/download/malaysia>.
- [44] En.Climate-Data, “Pekan climate: average Temperature, weather by month, Pekan weather averages - climate-Data.-org,” 2022, <https://en.climate-data.org/asia/malaysia/pahang/pekan-25988/>.
- [45] Gsa, “Global solar atlas,” 2022, <https://globalsolaratlas.info/map?s=3.490073,%20103.393699&m=site&c=3.490073,%20103.393699,%2011>.
- [46] L. L. Kazmerski, F. R. White, and G. K. Morgan, “Thin-film CuInSe₂/CdS heterojunction solar cells,” *Applied Physics Letters*, vol. 29, no. 4, pp. 268–270, 1976.
- [47] P. Jackson, R. Wuerz, D. Hariskos, E. Lotter, W. Witte, and M. Powalla, “Effects of heavy alkali elements in Cu(In, Ga)Se₂ solar cells with efficiencies up to 22.6%,” *Physica Status Solidi (RRL) – Rapid Research Letters*, vol. 10, no. 8, pp. 583–586, 2016.
- [48] S. Siebentritt, “What limits the efficiency of chalcopyrite solar cells?” *Solar Energy Materials and Solar Cells*, vol. 95, pp. 1471–1476, 2011.
- [49] Fraunhofer Ise, “Multicrystalline silicon solar cell with 21.9 percent efficiency: fraunhofer ISE again holds world record - fraunhofer ISE,” 2022, <https://www.ise.fraunhofer.de/en/press-media/press-releases/2017/multicrystalline-silicon-solar-cell-with-21-point-9-percent-efficiency-fraunhofer-ise-again-holds-world-record.html>.
- [50] M. M. Lunardi, P. R. Dias, R. Deng, and R. Corkish, “Life cycle environmental assessment of different solar photovoltaic technologies,” *Photovoltaic Sustainability and Management*, AIP Publishing, Melville, NY, USA, pp. 1–34, 2021.
- [51] Central Electricity Regulatory Commission, *Explanatory Memorandum for Tariff Norms for Solar Power Projects*, New Delhi, India, 2022.
- [52] Z. Moghaddam, I. Ahmad, D. Habibi, and Q. V. Phung, “Smart charging strategy for electric vehicle charging stations,” *IEEE Transactions on Transportation Electrification*, vol. 4, no. 1, pp. 76–88, 2018.
- [53] Unfccc, “Climate change annual report 2017,” 2021, <https://toolkit.climate.gov/reports/united-nations-climate-change-annual-report-2017>.
- [54] worldbenchmarkingalliance, “Climate and energy benchmark - electric utilities,” 2022, <https://www.worldbenchmarkingalliance.org/publication/electric-utilities/companies/tenaga-nasional/>.
- [55] Ecoscore, “How to calculate the CO₂ emission from the fuel consumption?,” 2022, <https://ecoscore.be/en/info/ecoscore/co2>.
- [56] Sdgs, “THE 17 GOALS | sustainable development,” 2022, <https://sdgs.un.org/goals>.