



## Review article

## Sustainability of multifaceted usage of biomass: A review



A.A. Adeleke<sup>a</sup>, P.P. Ikubanni<sup>a</sup>, T.A. Orhadahwe<sup>b</sup>, C.T. Christopher<sup>a,\*</sup>, J.M. Akano<sup>c</sup>,  
O.O. Agboola<sup>a</sup>, S.O. Adegoke<sup>d</sup>, A.O. Balogun<sup>a</sup>, R.A. Ibikunle<sup>a</sup>

<sup>a</sup> Department of Mechanical Engineering, Landmark University, Kwara State, Nigeria

<sup>b</sup> Department of Mechanical Engineering, University of Ibadan, Oyo State, Nigeria

<sup>c</sup> Department of Pharmacognosy, University of Ibadan, Oyo State, Nigeria

<sup>d</sup> Department of Petroleum Engineering, University of Ibadan, Oyo State, Nigeria

## ARTICLE INFO

## Keywords:

Biomass  
Multifaceted  
Construction  
Energy  
Traditional medicine  
Direct reduced iron  
Metal matrix composite

## ABSTRACT

The paper focuses on collection of information on recent multifaceted usage of biomass materials with critical examination on its sustainability. The use of biomass is becoming popular, with wide global acceptance as it is considered as green technology. The use of biomass products across industrial parallels, the material combination and production processes were elucidated in this paper. Biomass materials are seen as affordable alternative to conventional materials for domestic and industrial applications. The multifaceted use of biomass, which includes, energy generation, metallurgical applications, construction purposes, reinforcement in metal matrix composite, microelectromechanical system, biochemical and traditional medicine were discussed. This underscores the need to develop a sustainable plan to meet with its diverse usage to be beyond laboratory efforts. This paper examined whether the availability of biomass can sustain its multifaceted usage or not. It also examined the modalities to ensure sustainable use of biomass. Different policies were highlighted and discussed in line with continuous multifaceted use of biomass.

## 1. Introduction

There have been growths in scholarly research on the production, processing, characterization and use of biomass wastes for various applications in recent decades (Adeleke et al., 2019a, 2020a). Biomass are non-fossil resources of organic origin that are available on renewable, sustainable, clean and recurring bases (Adeleke et al., 2019b, 2021). Biomass are also referred to as waste materials derived from living organisms. Yadav et al. (2015a, b) described biomass materials as organic materials that stores energy from the sun as carbon, hydrogen, oxygen, nitrogen, and little sulphur content. Biomass materials include leaves, stalk, stem, husk, saw dust, peelings obtained from plants, dungs of animal and human, bones, scales and shells of animals. They are waste products obtained from the use of organic materials. For instance, saw dust is a byproduct for sawing logs of wood into planks. The planks can be used for construction and furniture works, while the sawdust can be utilized in composite material formation or energy generation (Ibikunle et al., 2020). The sawdust often contributes to waste generation that constitutes unsightly scene and environmental degradation (Adeleke et al., 2019a, b, c; Odusote et al., 2019). Similarly, periwinkle shell is

obtained from the consumption of periwinkle (Taulbee et al., 2009; Nwabue et al., 2017) and rice husk is derived from the processing of rice (Ikelle et al., 2017). Studies have shown that when these materials are compacted, they can be highly beneficial to many domestic and industrial processes (Kulkarni et al., 2019; Sundari et al., 2019). Biomass waste have been considered as a renewable alternative source of energy, which will reduce dependency on fossil fuel (Adeleke et al., 2021). Fossil fuel has many harmful impacts on the environment due to the production of greenhouse gases (GHGs) such as SO<sub>x</sub> and NO<sub>x</sub>, which contribute to Ozone depletion and consequential global warming. Consumption of fossil fuel is one of the major anthropoidal causes of global warming due to huge release of carbon monoxide (CO) gas into the air, which combines with the excess oxygen in the higher part of the atmosphere (stratosphere), leading to ozone layer depletion. The ozone layer acts as a shield that prevents the ultraviolet radiation of the sun from reaching the earth surface. The depletion of the ozone layer due to the formation of carbon dioxide when carbon monoxide (chemically unstable gas) combines with excess oxygen reduces the protection effect of the ozone layer thereby leading to some health issues such as skin burns and skin cancers. Carbon dioxide is also a warm gas, and its formation leads to the warming

\* Corresponding author.

E-mail address: [christophechiebuka.tim@gmail.com](mailto:christophechiebuka.tim@gmail.com) (C.T. Christopher).

up of the atmosphere that leads to global warming. The effects of global warming include, thinning away of the ice in the cold regions of the earth, climate change issues like excessive rainfall and excessive heats (Poudel et al., 2011; Gaballah et al., 2015; Odusote et al., 2019; Adeleke et al., 2019a, b, c; 2020a, b). Droughts are more prolonged in the southwest region and there is a global sea level rise. Researchers are of the opinion that the loose biomass when compacted is a cleaner source of energy supply when compared to fossil fuel due to the low carbon content of these materials. Yadav et al. (2015a, b) stated that one of the advantages of biomass, as a reliable energy source is that its production can be domesticated as such, the fluctuations in price of commodities in the international market does not affect it. The various energy products that can be derived from biomass include solid fuel, bioethanol, biogas and biodiesel (Adeleke et al., 2020a, b; Ikubanni et al., 2021). Biomass is also a reliable raw material for the production of biochemical, biopolymer poly-hydroxyalkanoates, biopolymer and biocatalysts (Liu et al., 2021). Biomass is the fourth largest source of energy in the world following coal, oil, and natural gas. In developing countries, about 2.4 billion people depend on biomass as their primary source of energy (IEA, 1998).

It has also been discovered that agro-based biomasses are economically viable source for graphite production. Graphite is one of the allotropes of crystalline carbon is known for its good electrical properties and high melting point which make it suitable for casting and moulding applications. This has led scientists to explore synthesizing graphite from several other sources to complement its natural source due to increased demand (Raghavan et al., 2017; Joseph and Babaremu, 2019). Samsul et al. (2020) conducted a robust review on the production of synthetic graphite from biomass and posited that biomass availability, process sustainability and cost effectiveness are factors for consideration in its use. Several other studies have also examined the use of biomass materials as strengthening agents in material processing. Orhadahwe et al. (2020) reviewed the use of agricultural wastes such as groundnut shell ash, coconut shell ash and rice husks as reinforcement materials in the strengthening of aluminum. The reviewed paper revealed the possibility of using synthetic ceramics ( $Al_2O_3$ ,  $Al_3Ni$ ,  $Mg Al_2O_4$ ,  $SiC$ ,  $TiC$  and so on) and agro waste ash as reinforcement for the production of aluminum matrix composite. Secondary treatment was suggested for these Al matrix composites. Similarly, Ikubanni et al. (2020a) examined the production of hybrid composites comprising ceramic and bio-based materials usually obtained from biomass waste materials. Bio-based fibers of diverse origin used in the development of aluminum metal composites (AMCs) were reviewed. Stir casting was projected as a major route for the production of composites with good physico-mechanical and wear resistance properties. The AMCs from the combination of Al alloy and bio-based fibers were suggestively useful in automobile, aerospace and aviation industries. These works among several other similar studies showed an improvement of the base material properties by the addition of the biomass materials.

Biomass-based industries help in job creation, enterprise development and generation of income in rural areas (Goldemberg et al., 2001; Karekezi, 2002). Biomass are composed of cellulose, hemicelluloses, lignin, extractives, lipids, proteins, simple sugars, starches, water-soluble substances, hydrocarbons, ash and other compounds. The various chemical compositions and structure of biomass are greatly influenced by origin, climatic conditions, age and the location of the plants and these compositions determine the value of the biomass (Vo and Navard, 2016).

Despite the numerous benefits of biomass, there is need to search and research on biomass to know whether the quantities of biomass can sustain these multifaceted benefits. If yes, how can this production be sustained and if no, what can be done to ensure improvement in that regard or should researchers just jettison the idea of biomass utilization at industrial and commercial scale? This review is designed to explore these issues vis-à-vis the production levels across regions, countries and continents of the world. Recent studies on the production of biomass are beginning to give credence to the volume of biomass production rather than just the concept of producing biomass. Martins et al. (2019)

conducted a study on the management of the supply chain for energy generation in United States, England, Brazil, India, Italy and Spain. The report emphasized the needs for researchers to focus on issues that evolve around the production of biomass such as the supply chain and its sustainability. The next sections discuss extensively the use of biomass in various area of applications.

## 2. Biomass and energy production

Energy is very essential for economic growth, development, comfortability and wellbeing of everyone in the society (Kheybari et al., 2019). The negative implication of the use of fossil fuel on the climate has caused a shift to more ecofriendly and renewable energy sources such as solar, wind and biofuels (Ahiduzzaman and Islam, 2011). According to the U.S. Energy Information Administration world energy outlook for the year 2020 and beyond, the world energy consumption would rise by nearly 50% by 2050. There would also be a rapid increase for global demand for renewable energy sources by the year 2050. Different countries continue to take proactive measures to curb the adverse effect of global warming and climate change due to the use of fossil fuel. Thus, renewables energy source will be the most demanded compared to petroleum, natural gas, coal and nuclear by 2050 (EIA, 2020). The use of biomass, which is a key member of the renewable source for energy generation, is already gaining global acceptance. As vast as the opportunities are for biomass in energy field, it still carries some degree of limitations. These limitations include poor grindability (Toklu, 2017), low energy content (Adeleke et al., 2019a), high moisture content, high volatile matter (Adeleke et al., 2019b) and bulkiness. There are different routes to upgrade and generate energy feed stock from biomass (Figure 1). Researchers have drifted more of their attention towards biomass in recent years via upgrading, pyrolysis, conversion, storage and many more activities on its application for energy purpose (Balogun et al., 2014; Balogun et al., 2021a; 2021b). Muraina et al. (2017) produced fuel briquettes from palm kernel shell and mesocarp fibre. The raw materials were blended and bonded with cassava peel gel. The best briquette had a fixed carbon of 19.90% that resulted in calorific value of 18.1063 kJ/kg. The fuel briquettes were recommended as energy source for domestic and industrial applications. Ajimotokan et al. (2019) did similar work on agglomeration of charcoal fine and sawdust as fuel briquettes using gelatinized cassava peel as binder. The briquettes from charcoal fines were reported to have the highest heating value of 24.9

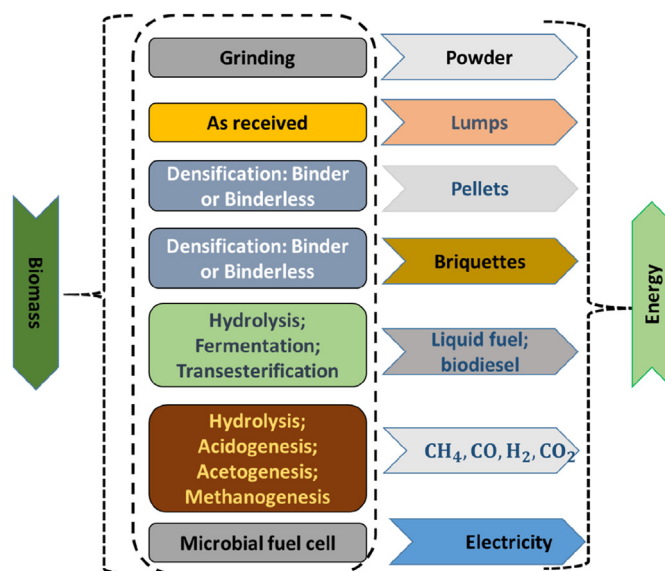

Figure 1. Biomass route to different sources of energy (Adeleke et al., 2020a, b).

MJ/kg. These briquettes were reported fit as energy fuel for industrial and domestic purposes. De la Rubia et al. (2018) worked on mesophilic anaerobic co-digestion of the organic fraction of municipal and solid waste with liquid fraction from hydrothermal carbonization of sewage sludge. Methane production increased at 2.4-fold when co-digestion was done for pretreated municipal solid waste and carbonization sewage sludge. The method produced at this point was 453 l/kg. There is huge potential with this co-digestion process for bio-oil production. Park et al. (2019) produced bio-oil using fast pyrolysis on biomass through pilot-scale circulating fluidized bed reactor. Three biomass materials (sawdust, empty fruit bunch, and giant miscanthus) were used as carbon substrate. Maximum yield (60%) was achieved while pyrolyzing at 500°C. The bio-oil samples were dependent on the raw materials used. The study further recommended additional operations for char and metal removal to achieve an effective and efficient energy source. Kumar et al. (2019) investigated the effect of mono- and bimetallic/zeolite catalysts on hydrocarbon production during bio-oil upgrading from ex-situ pyrolysis. It was reported that CuNi/Zeolite catalytic pyrolysis of biomass yielded an improved bio-oil in terms of quality compared to the mono-metallic catalysts. Adeleke et al. (2019a, b, c) upgraded *Tectonas grandis* using torrefaction technology to produce a better solid fuel at a temperature range of 240–300°C with a residence time of 30–60 min. The thermochemical properties of the biomass were reportedly improved with the calorific value rising from 18.73 to 23.10 MJ/kg Adeleke et al. (2020a) also examined the ignitability, fuel ratios and ash fusion temperature of torrefied biomass. Melina and teak wood waste were subjected to torrefaction technology under 220–320°C at 60 min residence time. The fuel ratio and ignitability index of the biomass were increased with temperature treatment. The ash fusion analyses also showed that the pretreatment process does not influence the ash content of the biomass. This made it feasible feedstock for co-firing with coal as partial or total replacement in existing coal-fired plants. These are few works out of hundreds recently published on bio-oil, gas and char generation from various biomass. Further efforts on various biomass for solid, liquid and gas energy and different route of their generation are presented in Table 1. The researchers reported various physical and energy properties of liquid, solid and gases product from different biomass processing methods. There is a vast opportunity on biomass to energy generation (Figure 2). However, several factors affect the production of biomass. These factors include the source of biomass materials, cost of production, production process and process parameters.

Yadav et al. (2015a, b) explained that the choice of biomass material and the production process determine the usage and economic value of biomass. The authors examined six different criteria which are the total availability of biomass, technology for conversion, efficiency of the process, cost of acquiring the biomass materials, cost of production and level of emission generated. It was submitted that the cost of acquisition of biomass resources and cost of production were the two most important criteria. This shows that the economic impact of biomass renewable energy resource is a critical factor to consider when deciding on what material or method to deploy during its production. Similarly, Kaliyan & Vance Morey (2009) opined that the constituents of biomass feed used in densification process such as starch, protein, fibre, fat and lignin, as well as the process parameters like feeding temperature, feed particle size, type of binder and the densification equipment have specific impact on the strength and durability of the products which also affect the economic value. Frei (2013) decried the ambivalent impact of lignin component of biomass waste on its energy generation capability emphasizing the criticality of the conversion route to the quality of the energy product. High lignin content favours direct combustion methods but this is not needed for biological conversion methods. Manzone et al. (2017) reported that one of the major setbacks for bioenergy production is the availability of biomass. The implication is that the available biomass cannot sustain its energy demand to rival the use of fossil fuel. This underscores the need for concerted efforts by researchers and key industry players to examine critically what measures to ensure the

sustainable availability of biomass. In the same vein, Torquati et al. (2016) noted that process of generating energy from pruning of vineyard and olive grove cannot be sustained from the economic and environmental perspectives.

The method of processing these biomass materials to generate energy is also crucial to the availability, sustainability and affordability of biomass energy. For instance, biodiesel can be obtained by filtration drying and oil extraction while biogas is produced by gasification process. Bioethanol involves the processes of milling, heating, water addition, fermentation and distillation of biomass materials especially agrowastes. Some of these processes pose environmental threat and involve the use of expensive technology, hence the need to consider technology and cost as drivers for sustainable bioenergy production (Yadav et al., 2015b; Khan et al., 2017; Kheybari et al., 2019). Bamboo is a broad group of woody grass with over 1250 species that can be used for bioenergy production but just like every other bioenergy material, the constant supply chain remains a major issue. Scurlock et al. (2008) posited that the difficulty of selective breeding of bamboo to assure its constant availability is a major drawback to energy production from the material. In a quest to proffer solution to the problem of availability of biomass materials, Sathre et al. (2010) highlighted the relevance of forest fertilization to boosting biomass production. Morato et al. (2019) posited the optimal location of biomass collection points to enhance biomass supply and bioenergy generation. By optimal location, it means that bioenergy production facilities should be set-up in areas with huge biomass availability. Schröder et al. (2018) explained that the use of marginal land for the purposeful cultivation of biomass as a visionary measure to increase biomass production and supply. The method, which is ecosystem friendly, would also lead to social and economic growth of most country. However, there are numerous challenges of intensifying marginal land for biomass production as stated in some reviewed articles on bioenergy listed in Table 2.

Figure 3 shows the sources of biomass energy supply for domestic use across the different continents. The figure shows that Asia is the world largest producer of biomass energy. Asia is also the world largest producer of biogas and solid biofuels. However, Asia has not really benefited from extracting energy from municipal waste. The figure also shows that municipal waste accounts for a fraction of the bioenergy in the Americas, Europe and Oceania but not in Africa. Africa majorly produce biogases and solid biofuels, while America, Asia and Europe derive bioenergy from liquid biofuels. The International Energy Agency (2019) gave outlook of energy situation in Africa. There has been a steady rise in energy demand in Africa since 2000. However, due to population growth, there has also been a significant rise in the percentage of the African population without access to electricity; a rise from 30% in 2000 to 70% in 2018. This underscores the need for diversified efforts to increase the energy generation in Africa. There has been an improvement in level of investment in alternate sources of energy aside fossil fuel in the last decade but Africa still lags other countries in the volume of renewable energy especially biofuels generated annually. The International Energy Agency report (2019) revealed that bioenergy makes up to 60% of the total energy usage in Sub-Saharan Africa at 2018. Over 800 MW of electricity can be generated from current installed bioenergy stations in East and South Africa, but cost of operations is high compared to other energy sources.

### 3. Biomass use in biochemical production

The drive for sustainability of the environment has led many researchers to examine alternative ways of generating feedstock for the biochemical industry. Through various mechanical, biological and thermochemical processes, biomass can be converted into three main products; electrical/heat energy, fuel for transportation and feedstock for chemical industry (Saxena et al., 2009). Other materials that can be obtained from biomass include bioplastics and bio-composites which are applicable in the textile, electronic and healthcare industries (Okolie

**Table 1.** Properties of solid, liquid and gaseous product of different biomass subject to various treatments.

S/N	Biomass Type	Process	Product Type	Energy/other Properties	Recommended usefulness	Ref.
1	Melina	Torrefaction and agglomeration with coal fines	Solid	Density of 1.18–1.32 g/cm <sup>3</sup> , drop to fracture that is greater than 100 (times/2 m), impact resistance index well above 6000, water resistance index of 99% and cold crushing strength of 9 MPa	Feedstock for rotary kiln direct reduced iron and COREX iron-making processes as well as fuel for thermal operations.	Adeleke et al., (2019a)
2	Melina and Teak wood	Torrefaction	Solid	Proximate, ultimate, 33–56 % increment in higher heating value was observed for severe treatment conditions as against 11–17 % of mild treatment condition	Can be suitable as feedstock in thermal or metallurgical applications.	Adeleke et al. (2019b)
3	Palm Kernel Shell (PKS) and Mesocarp Fibre (MF) Fuel Briquette	Densification	Solid	Proximate/physical analysis, highest fixed carbon and calorific value of 19.90% and 18.1063 kJ/g, respectively.	Could serve as alternative source of energy for domestic and industrial applications.	Muraina et al. (2017)
4	Woody biomass <i>Soberlinia doka</i> (ID) and <i>Pinus ponderosa</i> (PP)	Fourier transform infrared (FTIR) spectroscopy, thermogravimetric analysis, and analytical pyrolysis gas chromatography/mass spectrometry (Py-GC/MS).	Solid	The apparent activation energy recorded values of 202–365 kJ mol <sup>-1</sup> for ID and 205–583 kJ mol <sup>-1</sup> for PP	They have potential uses as feedstocks for pyrolysis.	Balogun and McDonald, 2016
5	<i>Musa spp.</i> (banana and plantain) residues	Fourier transform infrared (FTIR) spectroscopy, X-ray diffraction (XRD), analytical pyrolysis, and physicochemical analysis.	solid	Ash content (<12.30 wt %) in the <i>Musa spp.</i> , Activation energy reaching a peak of >290 kJ/mol.	They have potential uses as feedstocks for pyrolysis.	Balogun et al. (2018)
6	Tomato peels (TP) and virgin Olive husk (OH)	Torrefaction	Solid	Heating value, Proximate, ultimate, and SEM analyses	They have potential uses as feedstocks for pyrolysis.	Brachi et al. (2017)
7	Wheat straw	biological pretreatment using solid-state fermentation	Solid	SEM, moisture content	Relatively loose single fibers improve the physical quality of the compressed pellets which is better for feedstocks purposes.	Gao et al. (2017)
8.	soybean culture, sugarcane bagasse and eucalyptus wood	Densification	Solid	Heating value, bulk density, energetic density and proximate analysis	Suitable for heat energy generation and commercial purposes	Scatolino et al. (2018)
9	Teak and Melina	Torrefaction	Solid	calorific value, fuel ratio, ignitability index, ash compositions and ash fusion temperatures	These solid fuels properties met with the conditions required for energy generation in thermal plants	Adeleke et al. (2020a), b
10	Rice husk	Wet Torrefaction	Solid	Physicochemical properties	It can be used as the feedstock for preparation of nanosilica.	Zhang et al., (2017)
11	Oak wood	Ether treatment	Liquid	Viscosity, moisture content and HHV of 44.32 MJ/kg	Suitable for the present transportation fuel infrastructure	Farooq et al. (2019)
12	Pine wood	Ultrasound and Mechanical agitation	Liquid	HHV of 19.5 MJ/kg	It can be used for transportation fuel infrastructure.	Zhang et al. (2018)
13	Saccharina japonica	Fast Pyrolysis	Liquid	HHVs of the organic and aqueous bio-oils were 31.47 and 5.41 MJ/kg	Suitable for application in a commercial 100 MWe generation plant.	Choi et al. (2017)
14	Wall nut shell	Combination of Ultrasonic Treatment and Mutual Solvent	Liquid	HHV of 18.87 MJ/kg	Can be used as a renewable fuel and chemical feedstock.	Xu et al. (2018)
15	Rice husk	Untreated Wet Torrefaction	Liquid	HHV of -12.2 MJ/kg	The bio-oil obtained can be directly used as a fuel oil for combustion in a boiler or a furnace without any upgrading. Alternatively, the fuel can be refined to be used by vehicles.	Zhang et al., 2016
16	Cultivar Willow	Untreated wet Torrefaction (conventional heating using a micropyrolyzer, Py-GC/MS) and microwave-assisted heating using a laboratory scale microwave reactor and activated charcoal as an added microwave absorber).	Liquid	HHV of 29.5 MJ/kg	It can be suitable for energy generation.	Tarves et al. (2017)
17	Trembling aspen	Fast pyrolysis	Liquid	HHV of 13.1 MJ/kg	It is a genuine alternative to fossil resources	Le Roux et al. (2015)
18	Napier grass	Extraction of mineral retardants using deionized water, dilute sodium hydroxide and sulfuric acid and	Liquid	HHV of 22.22, 27.96, 21.94 and 20.97 MJ/kg respectively.	It can support a large energy project to create more energy security.	Mohammed et al. (2017)

(continued on next page)



Table 1 (continued)

S/N	Biomass Type	Process	Product Type	Energy/other Properties	Recommended usefulness	Ref.
		subsequent pyrolysis in a fixed bed reactor				
19	<i>Saccharina japonica</i>	Pyrolysis	Liquid	HHV of 35.0 MJ/kg	Suitable for hydrocarbon production for energy generation	Choi et al. (2014)
20	Rice husk	Fast Pyrolysis	Liquid	HHV of 22.99 MJ/kg	The results indicated that the rice husk bio-oil is a valuable liquid fuel but with some undesired properties.	Zhang et al. (2014)
21	Wheat straw	Fungal pretreatment ( <i>Polyporus brumalis</i> BRFM 985 strain)	Biomethane	280.5 (mL/g VS)	Suitable for fuel for heating purposes and energy conversion from gas to electricity.	Rouches et al. (2016)
22	Rice straw	Fungal pretreatment with <i>Pleurotus ostreatus</i> and <i>Trichoderma reesei</i> .	Bio methane	219.2 (mL/g VS)	Suitable for heat generation	Ahmed et al. (2016)
23	Non sterile, rotten Maize straw	Microbial pretreatment	Biomethane	304 (mL/g VS)	Suitable for cooking purposes	Binbin et al. (2016)
24	Rice straw	Physical (milling) and Biological (fungal) pretreatment	Bio methane	299 (mL/g VS)	Suitable for heat generation	Ahmed et al. (2017)
25	Microalgae	Enzymatic pretreatment	Biomethane	217.3 (mL/g VS)	Suitable for heat generation	Fabiana et al. (2016)
26	Algae ( <i>Ulva rigida</i> )	ultrasonic, acid, thermo-alkaline and enzymatic pre-treatments	Biomethane	626.5 (mL/g VS)	Suitable for heat and energy generation	Raida et al. (2015)
27	Paper mill sludge	Microbial pretreatment	Biomethane	429.1 (mL/g VS)	Suitable for heat and energy generation	Yunqin et al. (2017)
28	Sewage sludge	Microaerobic pretreatment	Biomethane	833.5 (mL/g VS)	Suitable for heat and energy generation	Montalvo et al. (2016)
29	Wheat straw	Micro-aeration pretreatment	Biomethane	264 (mL/g VS)	Suitable for heat and energy generation	Tsapekos et al. (2017)
30	municipal solid waste	Microbial consortium pretreatment	Biomethane	89.8 (mL/g VS)	Suitable for heat and electricity generation	Ge et al., 2016
31	Citrus waste	biodegradation pretreatment	Biomethane	308.9 (mL/g VS)	Suitable for heat and electricity generation	Haifeng et al., 2016

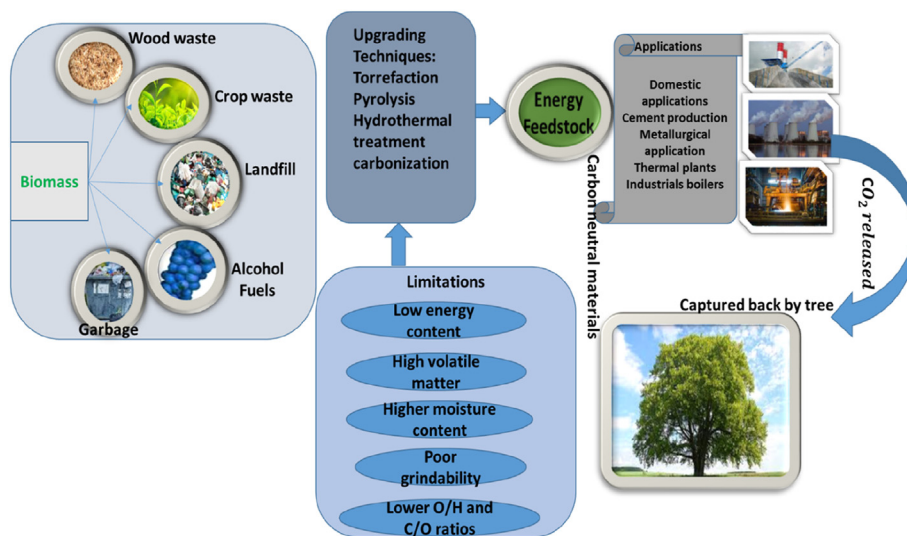

Figure 2. Biomass upgrade as feedstock for energy usage.

et al., 2020). The production of polyhydroxyalkanoates (PHA) has been viewed as a good replacement for polypropylene and polystyrene derived from petroleum. Khatami et al. (2020) established that PHA can be derived from cellulose biomass as a biopolymer that can be used in the biochemical industry. However, the authors highlighted that low production yield and inconsistencies of obtaining biopolymers have necessitated bioaugmentation and metabolic engineering to ensure sustainability of producing PHA at commercial level. The process of metabolic engineering involves the deliberate change in the cellular network of organisms to boost the production of metabolic substances

that can be used in biochemical processes while bioaugmentation involves adding culture of microorganisms to soils and groundwater to enhance biodegrading of contaminants. According to Khatami et al. (2020), the combined effect of mixed microbial culture and metabolic engineering will assure the future of PHA production.

Over the last decades, new pretreatment methods have been discovered including supercritical fluid based, low temperature steep delignification, cosolvent-enhanced lignocellulosic fractionation and ionic lignification (Patel et al., 2019). Despite the success recorded using these methods including maximizing sugar yield and minimizing the

**Table 2.** Some reviewed articles on bioenergy and its challenges by country.

Biomass Material used/Process	Country (ies)	Challenges	Reference
Kiwi	Italy	Transportation distance, production technique, production cost	Manzone et al. (2017)
Vineyard and Olive grove	Italy		Torquati et al. (2016)
Bamboo	USA	High production cost due to fragmentation of farms, environmental impact of production process	Scurlock et al. (2008)
Rice husk	Turkey	Production process, research and design	Toklu (2017)
Agricultural residue	Bolivia	Location of biomass facility	Morato et al. (2019)
Wood and municipal sources	Poland	Difficulty in combustion, need to optimize combustion parameters	Greinert et al. (2019)
Analytical hierarchy process	Iran	Water use, production technology	Kheybari et al. (2019)
Animal and plant wastes, municipal waste	Ethiopia	Value chain issues	Gabisa & Gheewala (2018)
Intensifying biomass production by using marginal lands	Germany, Spain, Ireland, Italy and Norway	The low use of marginal land for agricultural activities	Schröder et al. (2018)
Biodiesel from Algae	China	Identification of suitable specie, technical expertise	Khan et al. (2017)
Tree species	Spain	Selection of the right specie, biomass fraction in use	Álvarez-Álvarez et al. (2018)

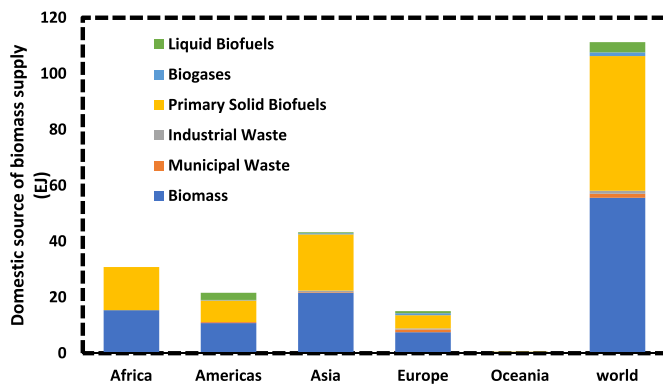
**Figure 3.** Biomass sources across continents as at 2017 (World Bioenergy Association, 2019).

production of inhibitors, there is still a need for improvement in the production process. Yu et al. (2020) carried out a comparison study on different routes of producing chemicals from lignocellulosic biomass. The various routes identified are biochemical, microwave and thermochemical conversion methods. Biochemical conversion involves the disruption of biomass structure by enzymatic hydrolysis whereby polysaccharides are converted to monosaccharides and disaccharides. Thermochemical conversion methods deploy the use of pyrolysis to break down lignocellulosic biomass into useful chemical products for industrial application. Such processes include conventional pyrolysis, and hydrothermal processes. Pyrolysis takes place in the absence of air while hydrothermal conversion occurs in the presence of water. Microwave processing requires the use of microwave irradiation which ensures effective

distribution of heat to molecules through ionic conduction. The study emphasized on the importance of microwave processing over the other two methods. The reaction time in microwave processing is shortened and energy consumption cost is reduced. Some of the chemical products of the conversion of lignocellulosic biomass include; levoglucosan, levoglucosenone, furfural, phenol, syngas, gluconic acid, xylan and so on.

Similarly, Ahorsu et al. (2018) examined the significance and challenges of producing feedstock from biomass materials. It was stated that the availability of biomass in our environment makes it a suitable option for sustainable production of feedstock for bioenergy and biochemical industries. However, the challenges associated with depolymerization of biomass and the high energy consumption are critical issues that can be addressed by the improvement on the production process, provision of financial incentives and supportive regulations for commercial scalability.

This view is shared by Cherubini (2010) who discussed the importance of biorefinery as a replacement for oil refinery and a platform for commercialization of the production of biochemicals and biofuels. While stating the disadvantages of biorefinery which basically are the wide range of feedstock and the seasonality of biomass, it was stated that there are more viable range of products from biorefinery than oil refinery. The development of technical capacity for biorefineries to handle wide range of feedstock, carryout depolymerization and deoxygenation will make the process of refining seamless and similar to the conventional oil refinery. To this extent, research should focus on developing methods and techniques that can assure sustainable biomass conversion for biochemical application.

#### 4. The use of biomass in construction

The construction industry is a very large industry with high demand for diverse materials including granite, cement, tiles, wood, steel, sand, water, and bricks. Some of these materials are produced locally, others are imported. The supply of these materials is often influenced by the fluctuation of prices in global market. Biomass is useful as raw material in its as-received or ash forms. Figure 4 shows some routes to the utilization of biomass for various construction purposes. Biomass ash could be obtained from thermal plants or other metallurgical processes (Adeleke et al., 2021). However, the ash can be used directly into cement aggregates, a better route to its usefulness is now in vogue in the scientific world. This route is geopolymers. It is useful for various construction applications such as particleboard, ceiling board, tiles, cements, adhesive and more as shown in Figure 4. In a quest for minimizing the cost of construction and turning waste into wealth, researchers have examined the production of construction materials from biomass. Several authors have examined the use of biomass as construction materials in various countries of the world. Table 3 presents some of the biomass used in their raw form or ashed for different construction purposes. Ikubanni et al. (2018) produced particleboards from locally sourced materials. The particleboards were formulated from the blend of sawdust and rice husk with the inclusion of metallic chips and adhesives. The highest modulus of rupture and modulus of elasticity were 26.08 and 412.4 MPa, respectively. The particleboards could be used for indoor and outdoor purposes. Wood-polypropylene plastic-cement composite board was developed and characterized by Ohijeagbon et al. (2020). The board was developed from the blend of sawdust and polypropylene plastic wastes using cement and expanded polystyrene as adhesives. The developed composites were recommended as partitioning wall based on the highest flexural (7.10 MPa), tensile (1.52 MPa) and compressive (3.72 MPa) strengths. Expanded polystyrene waste was also reported as good adhesive for the board. Ohijeagbon et al. (2021) did another work on cement bonded ceiling board developed from teak and African locust bean wood residue. The attempt was to reduce environmental pollution while turning the biomass waste to wealth. The ceiling board was produced at various

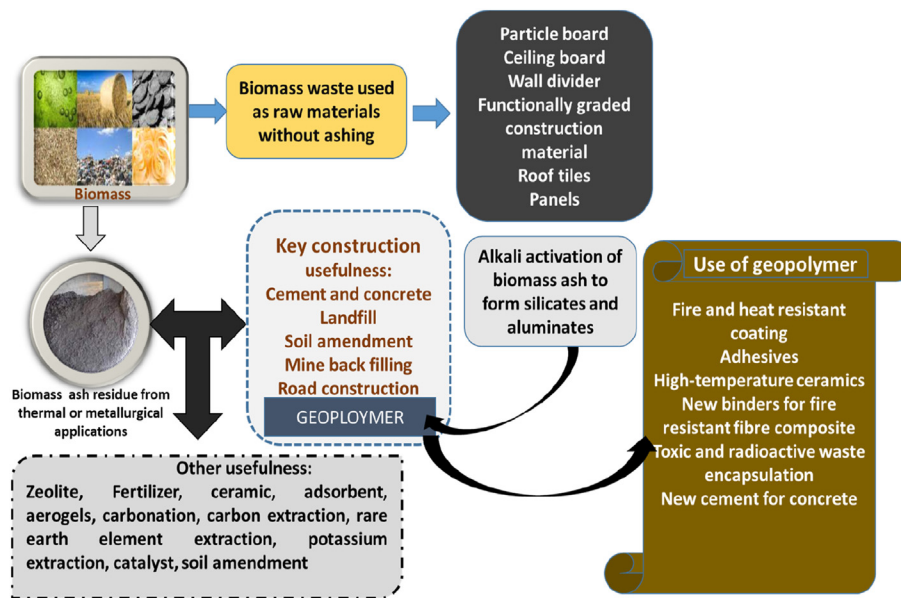

Figure 4. Biomass for construction purposes.

ratios of the raw materials. The authors reported that the highest tensile, compressive and flexural strengths were 1.09, 0.82 and 0.56 MPa. The composites were deemed fit for interior usage. [Lasode et al. \(2021\)](#) produced and characterized composite tiles from granite dusts and municipal wastes. The work utilized tree pruning and bamboo wastes as partial replacement for granite dusts in producing composite tiles. The aggregates were blended with cement binder. Maximum flexural (1.53 MPa) and compressive (1.12 MPa) were reported for samples produced with 70% granite dust, 10% tree pruning and 20% cement. The tiles had low thermal conductivities (0.02197–0.022313 W/mk) that made them suitable as low load bearing insulating construction materials. [da Costa et al. \(2019\)](#) examined the use of woody biomass ash as a construction material. The authors assess the impact of incorporating woody biomass ash into cement mortars, adhesive mortars, concrete blocks and bituminous asphalts on the environment. It was noted that the biomass ash can replace either the aggregate or binder in cement production depending on the type of ash used. Four types of biomass ash were obtained from two production processes; fly and bottom ash obtained from a vibrating grate and fly and bottom ash obtained from a fluidized bed process. The results of the study showed that only the use of woody biomass ash for landfilling posed a major threat to the environment. By implications, it can be asserted that the use of woody biomass ash in construction materials is environmentally safe. In a similar study, [Nagroekienė and Daugėla \(2018\)](#) partially replaced cement in the production of concrete in the range of 5–30% volume and carried out compressive strength analysis. The researchers used 7 days and 28 days as curing periods. The results of the compressive strength test are as shown in [Figure 5](#). There was an increase in the compressive strength of concrete from 0% vol to 5% vol of biomass combustion fly ash. The compressive strength increased from 32.4 to 39.4 MPa for samples cured for 7 days and 36.6–48.5 MPa for samples cured for 28 days. Further increase in the volume of biomass fly ash led to decrease in the compressive strength in both sets of samples. However, it can also be observed that the samples cured for 28 days had higher compressive strengths at all vol% addition of the biomass fly ash. This shows that curing for 28 days and 5% replacement of cement in concrete production is enough to increase the compressive strength. The study also highlighted the need for parametric optimization in the process of using biomass as a partial replacement in construction materials. Biomass has been effective and efficiently used in construction purposes. Biomass is

also useful in development of metal matrix composite as discussed in the next section.

## 5. Biomass materials utilization as reinforcements in metal matrix composite

Biomasses in recent years have also been used extensively in the production of metal matrix composite (MMC) due to some useful elemental oxides that are present in their ash content. They are used as reinforcements alongside with synthetic reinforcing materials such as SiC, Al<sub>2</sub>O<sub>3</sub>, B<sub>4</sub>C, and so on, in MMC production ([Alaneme et al., 2013](#); [Ikubanni et al., 2020a](#)). The combustion of biomass produces very rich residual ash. The enrichment contains silica (SiO<sub>2</sub>) as the main constituent, which can be used as reinforcement in MMCs. Biomass materials (bio-materials) or their derivatives utilization for MMCs production could be due to some of the following reasons. Biomaterials are good and cheap source of silica and carbon as well as other strength giving oxides. Biomaterials and their derivate could provide unique structures that are not obtainable using conventional ceramic processing methods ([Bahrami et al., 2016](#)). Of all the ceramics derivatives obtainable from bio-materials, the most investigated of them all is silicon carbide synthesized from various plants ([Bahrami et al., 2016](#); [Aigbodion and Ezema, 2019](#)). Most of the oxides present in the derivatives of biomaterials are strengtheners in MMCs ([Ikubanni et al., 2020b](#)). Hence, the continual delving of more research into their usage as partial replacement of conventional ceramic materials in MMCS. Some agro-wastes and their derivatives that have been used in the development of MMCs are discussed in this section. More so, how sustainable these agro-wastes would be considering other competing interest in the application of these wastes for other uses are discussed.

### 5.1. Utilization of rice husk and its derivatives

Rice husk is a renewable energy source and very abundant in rice producing areas of the world such as Indian, China, USA, and so on. Rice husk has been reported to be a potential source of energy as well as a value-added byproduct ([Alaneme et al., 2013](#); [Soltani et al., 2014](#)). Rice gain plant contains 20% husk, which could be combusted to form ash. Both organic and inorganic substances are present in rice husk. Due to the abundant nature of rice husk, its residue after combustion is rice husk ash

**Table 3.** Biomass type and construction purposes.

Biomass Type	Ashing process	Chemical properties	Construction purposes	Ref.
Sawdust	N/A	N/A	Composite boards as partitioning wall in building	Ohijeagbon et al. (2020)
Sawdust and rice husk	N/A	N/A	For indoor and outdoor purposes	Ikubanni et al. (2018)
Teak and African locust bean tree wood residue	N/A	N/A	Cemented bonded ceiling board	Ohijeagbon et al. (2021)
Biomass fly ash	N/A	SiO <sub>2</sub> (68.53%); Al <sub>2</sub> O <sub>3</sub> (6.51%); Fe <sub>2</sub> O <sub>3</sub> (2.15%); CaO (9.96%); K <sub>2</sub> O (7.16%); SO <sub>2</sub> (1.04%); Na <sub>2</sub> O (0.98%); P <sub>2</sub> O <sub>5</sub> (2.09%); MgO (1.14%); MnO <sub>2</sub> (0.33%); and Cl (0.11%)	For construction works	Nagrockiėnė and Daugėla (2018)
Rice husk ash	Burnt in laboratory mill under 600 °C temperature for 5 h	SiO <sub>2</sub> (86.73%); Al <sub>2</sub> O <sub>3</sub> (0.04%); Fe <sub>2</sub> O <sub>3</sub> (0.61%); CaO (0.39%); K <sub>2</sub> O (0.01%); SO <sub>3</sub> (1.32%); Na <sub>2</sub> O <sub>3</sub> (9.76%); MgO (0.08%); LOI (0.54%)	Construction work	Zareei et al. (2017)
Rice husk ash	Uncontrolled temperature	SiO <sub>2</sub> (96.20%); Al <sub>2</sub> O <sub>3</sub> (0.26%); Fe <sub>2</sub> O <sub>3</sub> (0.57%); CaO (0.47%); K <sub>2</sub> O (0.67%); SO <sub>3</sub> (0.15%); Na <sub>2</sub> O (0.12%); (MgO (0.35%); LOI (1.15%)	Building construction work	Amin and Abdesalam (2019)

\*N/A means “Not Applicable”.

(RHA). This have found utilization in some industries including cement industry, pigments, coatings, rubber filler, and so on (Lee et al., 2013; Saleh, 2015; Bahrami et al., 2016; Adediran et al., 2018). It is very important to investigate the chemical composition of RHA. Table 4 gives some chemical composition of RHA from previous studies for various applications ranging from cement to composites.

Table 3 shows that silica which gives strength to MMCs as reinforcement is the major constituent present in the RHA. Numerous researchers have studied the use of RHA as reinforcement in MMCs. Adediran et al. (2018) investigated the processing and structural characterization of Si-based carbothermal derivatives of rice husk. In a controlled environment, the processing temperature window was between 900 and 1900 °C at 10 °C/min heating rate. The functional groups, crystalline and amorphous phases, and the morphological characteristics of the products were done using Fourier transform infrared (FTIR) spectroscopy, X-ray diffractometer (XRD), and scanning electron microscopy (SEM), respectively. Hydroxyl, siloxane, and Si–C groups are reported to be present in the rice husk as the major functional groups with different polytype of silicon carbide (SiC). The XRD identified the crystalline phases of SiC. It was reportedly concluded that the carbothermal treatment is viable in the production of Si-based refractory compounds. Prasad et al. (2016) studied the damping behaviour of hybrid composite when RHA and SiC were used as hybrid reinforcement for the production

of the MMCs. Aluminium served as the matrix metal, while two stage stir casting technique was employed for the production. All the samples were subjected to damping measurement using the dynamic mechanical analyzer at different frequencies. The damping capacity of the composites was greatly influenced due to the thermal mismatch that occurred between the matrix and the reinforcement as well as the porosity. Alumina, graphite, and RHA were experimentally mixed in various weight ratios to develop hybrid aluminium matrix composite (AMC) using Al–Mg–Si alloy as the matrix by Alaneme and Sanusi (2015). The development of the AMCs was done using the two-step stir casting. The rice husk was obtained from a rice processing plant, burnt to ash in an incinerator, conditioned by heat-treating in a furnace, and then sieved. It was reported that the increment of RHA and graphite weight ratio reduced the hardness of the composites. The tensile strength of the composite was higher when up to 50% RHA and 0.5 wt.% of graphite were used. However, the toughness values of the composites were lower than that of other composites with the increment in RHA content.

Aluminium hybrid composite with equal amount of RHA and SiC incorporation from 2 to 8% was produced via stir casting route. The reinforcement was homogeneously distributed in the metal matrix. All the mechanical properties increased with the reinforcement increment except for the percentage elongation, which reduced. More so, the coefficient of thermal expansion reduced with rising reinforcement (Prasad et al., 2016). The thermal mismatch that led to the increment in the dislocation density due to the reinforcement increase was the strengthening mechanism. The tensile, yield, and specific strengths of hybrid composites made from Al 6063 with 5, 7.5, and 10 wt% reinforcement (SiC and RHA) showed increment with increment in the reinforcements' weight percentage. However, the fracture toughness declined as the weight percentage of the reinforcing materials increased (Alaneme and Adewale, 2013). The study revealed that there was reduction in the yield, ultimate tensile, and specific strength of the composites as the RHA content increases in the reinforcements. The reduction observed was suggested to be as a result of the lower hardness as well as the modulus of elasticity of the

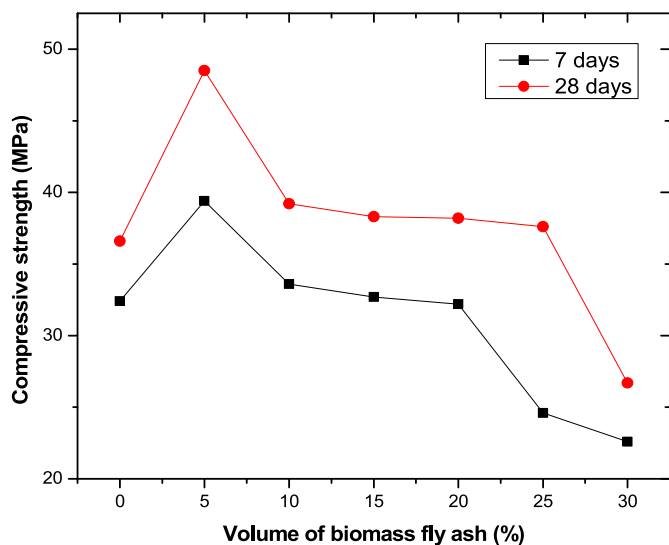

**Figure 5.** Compressive strength of biomass combustion fly ash (Nagrockiėnė and Daugėla, 2018).

**Table 4.** Chemical composition of RHA based on some studies.

Chemical composition (%)	Alaneme and Sanusi (2015)	Prasad et al. (2016)
Silica (SiO <sub>2</sub> )	91.56	90.23
Carbon	4.8	4.77
Calcium oxide (CaO)	1.58	1.58
Magnesium oxide, MgO	0.53	0.53
Potassium oxide (K <sub>2</sub> O)	0.39	0.39
Hematite (Fe <sub>2</sub> O <sub>3</sub> )	0.21	0.21
Others	0.93	-



silica that is present in the RHA when compared to the hardness of SiC. It is noteworthy to state that, the study observed that the hybrid composites with RHA gave better fracture toughness as a result of the reduction of the hard SiC particles. Alaneme et al. (2013) produced hybrid composites having 10 wt.% reinforcement with SiC and RHA in weight ratios of 1:0, 3:1, 1:1, 1:3, and 0:1, respectively. The produced composites were subjected to thermal cycling and the corrosion behaviour of the hybrid composites were investigated using potentiodynamic polarization measurement. It was reported that there was lower corrosion tendency for the hybrid composites with a higher RHA content in comparison with other composite grades. Investigation was carried out by Prasad and Krishna (2010a, b) on characterizing and examining the mechanical properties of A356-RHA composite fabricated by stir casting. RHA used was produced from rice husk and it was incorporated into the A356 at different weight percentages. It was revealed that RHA particles weight percentage increment led to an increase in the hardness and UTS of the composites. However, density of composite decreased with RHA particles increment.

Deshmukh et al. (2012) produced AMCs reinforced with RHA and metallurgical grade SiO<sub>2</sub>. Varying amount of Mg in weight percentage (0.5, 1, 2.5, and 5 wt.%) were also added in the production of the AMCs. The mechanical properties of AMCs produced were examined based on standard ASTM protocol. The particle size for the RHA was between 32 and 56 nm, while 10 mm average size was used for metallurgical grade SiO<sub>2</sub>. Stir casting route was used in the production of the AMCs. The study reported increment in hardness values in the developed AMCs as the weight percentage of the Mg increased up to 2.5 wt.%. This was considered to be the result of a better SiO<sub>2</sub> particles wettability as well as hard phase spinel formation. This led to the extreme lattice distortion of the Al alloy, which metamorphosed into finer grain formation with higher hardness. Furthermore, SiO<sub>2</sub> obtained from RHA is more reactive and with higher surface area with molten alloy than the metallurgical grade SiO<sub>2</sub>. The wear loss of AMC with 2.5 wt.% Mg composite reinforced with RH silica was also found to be minimum than that of other samples of composites. Combined reinforcements such as RHA, SiC, and graphite particles in varying weight ratios were employed in the development of Zn–27Al based composites. The mechanical properties and the microstructure of the composites were examined. The microstructural examination revealed the fine distribution of the reinforcing particles and the dendritic structure of the Zn–27Al alloy matrix. With a corresponding decrease in SiC and increase of RHA particles, the composites showed decline in hardness values. More so, there was slight decrease in the yield and tensile strengths of the composites with RHA weight ratio increment. Percentage elongation was observed to be invariant to the composite RHA content; however, composites with RHA particulates had percentage elongation slightly higher those without RHA. More so, with increment in RHA content, the fracture toughness value of the composite increases. In the study of Dinaharan et al. (2017), 18 vol% RHA was used in the development of AMCs via friction stir processing route. The matrix used was AA6061. The produced composites were characterized and microstructural examination was performed. The microstructure showed homogeneously distributed RHA particles in the composites with no agglomeration or segregation. More so, fine and equiaxed grain structure was observed from the composite microstructure. There was an improvement in the tensile strength due to the RHA particles reinforcement addition. Among other works that have been done using RHA as reinforcing material in MMCs production include Saravanan et al. (2013); Saravanan & Kumar (2013); Prasad and Krishna (2010a, 2010b, 2012a, 2012b), and so on.

### 5.2. Utilization of groundnut shell and its derivatives

Groundnut is a leguminous crop, which is nutritious and mainly grown for seed and oil worldwide. It is more abundant in India, China, and Nigeria. In Nigeria, the amount of groundnut production between 2011 and 2018 are displayed in Figure 6. Groundnut seeds are enclosed in groundnut shells (pods). After groundnuts are removed from the pods, the leftover products are the groundnut shells (Duc et al., 2019). Zheng

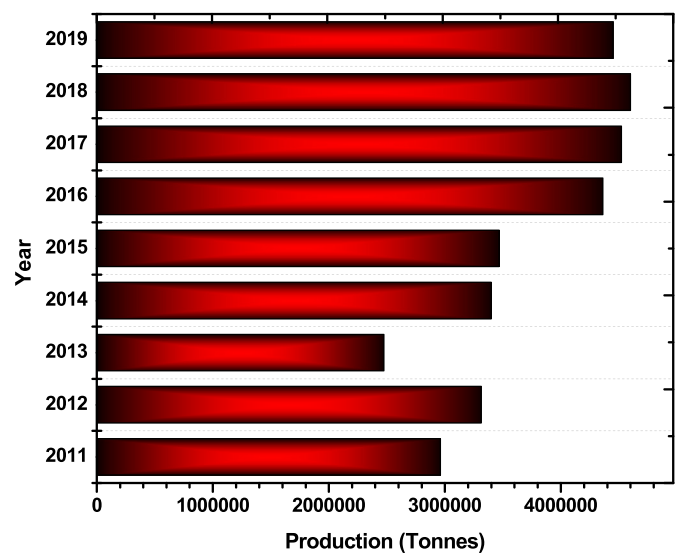

Figure 6. Groundnut production in Nigeria (Food and Agriculture Organization, 2020).

et al. (2013) reported that groundnut shell is an abundant agro-waste in which the rate of degradation is very slow. Groundnut shells have numerous benefits due to bioactive and functional components (Duc et al., 2019). With the abundance of these groundnut shells, they have become pollution to the environment. Hence, to reduce these environmental wastes, they have been meaningfully used in different applications by obtaining its derivative as ash, which is used as reinforcement particulates in metal matrix composites (Ajibola and Fakeye, 2016; Alaneme et al., 2015; Joseph and Babaremu, 2019). The ash is produced by carbonizing the groundnut shell and conditioning it in a furnace. Groundnut shell ash (GSA), in line with RHA, contains chemical compositions such as SiO<sub>2</sub>, Al<sub>2</sub>O<sub>3</sub>, CaO, MnO, K<sub>2</sub>O, and so on, which them find usefulness in metal matrix production. Most of these chemical oxides affect the properties of metal alloys including aluminium. The chemical composition of GSA used in the study of Alaneme et al. (2018) consists of: SiO<sub>2</sub> (34.2 wt.%), Al<sub>2</sub>O<sub>3</sub> (12.42 wt.%), Fe<sub>2</sub>O<sub>3</sub> (14.0 wt.%), CaO (14.3 wt.%), MgO (2.0 wt.%), Na<sub>2</sub>O (0.048 wt.%), K<sub>2</sub>O (15.46 wt.%), P<sub>2</sub>O<sub>3</sub> (2.1 wt.%), MnO (0.36 wt.%), SO<sub>3</sub> (0.64 wt.%), and LOI (4.85 wt.%). The SiO<sub>2</sub> content of the GSA was very low and have high Fe<sub>2</sub>O<sub>3</sub>, CaO, Al<sub>2</sub>O<sub>3</sub>, and Al<sub>2</sub>O<sub>3</sub> compared to what was obtainable for the RHA. In the quest to investigate the influence of GSA blended with SiC reinforcement on the mechanical properties of Al–Mg–Si alloy. The different mix ratios of the GSA and SiC are: 10:0, 7.5:2.5, 5.0:5.0, 2.5:7.5, and 0:10, which made up 6 and 10 wt.% of the reinforcing phase. For the production of the AMCs, two-step stir casting technique was utilized. For both the 6 and 10 wt.% reinforced Al–Mg–Si based composites, the hardness, ultimate tensile strength, and specific strength slightly reduced as the GSA content of the reinforcing phase was increased. Meanwhile, the fracture toughness varies directly with the increment of the GSA content, while the percentage elongation improved marginally. The influence of the GSA content on the AMCs was due to the amount of the oxides of Si, Mg, Al, Ca, and K present in its composition. More so, the corrosion behaviour of the produced hybrid reinforced AMCs in 3.5% NaCl and 0.3M H<sub>2</sub>SO<sub>4</sub> solutions, as studied by Alaneme et al. (2015) showed that the hybrid composites were more susceptible to corrosion in 0.3M H<sub>2</sub>SO<sub>4</sub> solution than in 3.5% NaCl solution.

Groundnut shell powder and ash forms were used particulate reinforcements in the development of composite using Al–Mg–Si alloy. The alloy was reinforced with between 2 and 10 wt.% of the groundnut shell particulates and the composites were developed using the stir-casting method. Tensile strength, impact strength, hardness, and microstructure of the different developed composites were investigated by Tile et al.

(2018). The mechanical properties investigated were improved with the inclusion of the groundnut shell particulate. Naidu et al. (2013) investigated the mechanical properties of polymer metal matrix composites reinforced with groundnut shell fiber (coir) and epoxy resin. The composites were developed using between 0 and 6 wt. % variation of the groundnut shell. The samples were heat-treated and experimental data were obtained before and after the heat-treatment. The composites properties were improved. However, due to the heat-treatment, it was concluded that the composites cannot last during long heating period. Jadhav et al. (2019) investigated the microstructural influence of hybrid ash of groundnut and coconut shells as reinforcement in A356 alloy matrix composite. There was uniform distribution of the particulates in the alloy, which led to the increment in the hardness value as the reinforcement increased.

### 5.3. Utilization of coconut shell and its derivatives as reinforcement

In tropical countries of the world, amongst the agricultural wastes found in huge quantities are coconut shell and coir (Bahrami et al., 2016). Coconut production in Nigeria as given by Food and Agriculture Organization (2020) between 2011 and 2018 are displayed in Figure 7. Coconut shell and coir are obtained from coconut. The coconut shell is the hard core of the coconut, which is non-edible. The notable way of disposing coconut shell is through burning indiscriminately; hence, contributing to the greenhouse gas effect through the release of significant CO<sub>2</sub> and other gases. However, coconut shell is fast becoming a new biomass source of renewable energy (biofuel) after undergoing densification or using it without densifying. Aside other usefulness of coconut shell such as source of fuel for castings and forging by Blacksmiths (Bamgboye and Jekayinfa, 2006), functional filler in polyolefin for properties enhancement, road maintenance in rural areas in filling swampy roads, handicraft application, and so on (Bahrami et al., 2016; Bamgboye and Jekayinfa, 2006); coconut shell after being carbonized and transformed into ash have found usefulness in the development of MMCs. The coconut shell ash (CSA) is used as partial reinforcement material in combination with synthetic reinforcements like SiC, B<sub>4</sub>C, TiC, and so on, in the MMCs development. The potential utilization of CSA in MMCs for automotive applications was investigated by Madakson et al. (2012). The density, particle size, refractoriness, chemical composition, functional groups, crystallinity, and its microstructure were studied. It was revealed that the density was 2.05 g/cm<sup>3</sup> while XRD showed silica (SiO<sub>2</sub>) as the primary compound present in the CSA with diffraction peaks and phases at the peaks to be quartz (SiO<sub>2</sub>), cordierite

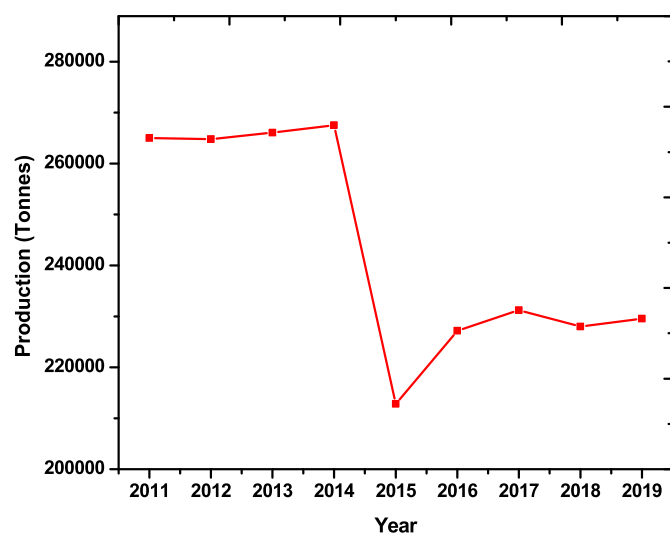

Figure 7. Coconut production in Nigeria (Food and Agriculture Organization, 2020).

(Mg<sub>2</sub>AlSi<sub>5</sub>O<sub>18</sub>), and moissanite (SiC). Hard phases, such as SiO<sub>2</sub> (45.05%), Al<sub>2</sub>O<sub>3</sub> (15.6%), MgO (16.2%), and Fe<sub>2</sub>O<sub>3</sub> (12.4%), are present through the XRF analysis done. Other oxides such as CaO (0.57%), K<sub>2</sub>O (0.52%), Na<sub>2</sub>O (0.45%), MnO (0.22%), and ZnO (0.3%) are found to be in traces. The FTIR results showed quartz, mullite and vitreous, carbon phases to be present in the CSA. The CSA particles under the back scattered electron (BSE) were observed to be solid and irregular in size. CSA was concluded to be a low cost, light-weight material that could potentially serve as reinforcement in MMCs.

The study of Kumar et al. (2019) aimed at understanding the microstructure and mechanical properties of Al 6082 matrix composites with zirconium oxide (ZrO<sub>2</sub>) and CSA particles as reinforcement varying from 0 to 10%. The fabrication technique employed was stir casting process. The presence of ZrO<sub>2</sub> and CSA were confirmed through XRD and SEM utilization. The results of the mechanical properties tests showed that the hardness reduced when adding 10% CSA while the addition of ZrO<sub>2</sub> increased the hardness. The reduction in the hardness when CSA was added was attributed to the lubrication effect of the fine CSA. More so, the addition of both reinforcing materials increased the ultimate tensile and yield strength. However, the ductility of the composites reduced. The addition of both reinforcements reduced both the impact strength and fracture toughness of the composites. The CSA lubrication effect was suggested to be the reason for the impact strength reduction, while plastic deformation energy reduction, fracture consumption energy rise, and increment in debonding between the aluminium alloy and the reinforcement. Varalakshmi et al. (2019) characterized MMCs produced via stir casting method. CSA was reinforced into Al 6061 alloy at a proportion of 1, 3, and 5% of the synthesized CSA. The mechanical properties were found to improve as the CSA content increased. Some other studies on the usage of CSA as reinforcing material in MMCs include the studies of Raju et al. (2019); Poornesh et al. (2017); Lakshmiathan and Prabu (2016); Pinto et al. (2016), Daramola et al. (2015), and so on.

### 5.4. Utilization of bamboo leaf and its derivatives as reinforcement

Bamboos are evergreen perennial flowering plants, with some species growing as much as 30 cm per day. Bamboo, one of the fastest growing plants, has become one of the most essential non-woody forest products in the world (Kumar and Birru, 2017). In Nigeria, two varieties of bamboo exist, which are *Bambusa vulgaris* and *Oxytenanthera abyssinica*. Bamboo grows mostly around river courses since there is no specific established bamboo plantation yet in the country. Bamboo has been utilized in numerous areas. Some of the applications of bamboo are in construction works (building, roads and bridges), medicines, clothes, food, fuel, furniture, scaffolding, rugs and textiles, paper making, and many more. These applications involved the use of the bamboo stems, while the bamboo leaves become environmental wastes. In a bid to reduce the bamboo leaves residue in the environment, many researchers have worked on obtaining hard phases that would be useful as reinforcing materials in MMCs. These leaves are subjected to carbonization to obtain ash known as bamboo leaf ash (BLA) (Alaneme et al., 2014, 2018; Alaneme and Adewuyi, 2013). The chemical composition of BLA as reported by Alaneme et al. (2014a,b) was SiO<sub>2</sub> (75.9 wt.%), Al<sub>2</sub>O<sub>3</sub> (4.13 wt.%), CaO (7.47 wt.%), MgO (1.85 wt.%), K<sub>2</sub>O (5.62 wt.%), Fe<sub>2</sub>O<sub>3</sub> (1.22 wt.%), and TiO<sub>2</sub> (0.20 wt.%), while the chemical composition reported by Alaneme and Adewuyi (2013), showed the main components of BLA to be SiO<sub>2</sub> (76.4 wt.%), Al<sub>2</sub>O<sub>3</sub> (5.04 wt.%), MgO (2.05 wt.%), K<sub>2</sub>O (5.76 wt.%), CaO (6.68 wt.%), and Fe<sub>2</sub>O<sub>3</sub> (1.82 wt.%). The variation between these two chemical compositions of BLA might be due to the source of the bamboo leaf used. However, BLA was used as a complementing reinforcing material along with alumina in the development of AMCs using Al-Mg-Si as the matrix material. The influence of the BLA on the mechanical properties of the developed AMCs was examined. The BLA constitutes 2, 4, and 6 wt.% of the total 10 wt.% of the reinforcements. The BLA increment in the reinforcement affects the tensile strength, yield strength, and specific strength by reducing these properties. There was an

increase in ductility as the BLA content increases in the reinforcements used since the fracture toughness was improved (Alaneme and Adewale, 2013). Hence, BLA introduction as complementing reinforcing material does not have substantial effects on the hybrid AMCs performance. In a related study by Alaneme et al. (2013), the mechanical properties and corrosion behaviour of hybrid AMCs reinforced with SiC and BLA were investigated. Such as BLA was used as a complementing reinforcing material with alumina in the study of Alaneme and Adewuyi (2013), it was utilized with silicon carbide. The BLA particulates added to the SiC to make 10 wt.% of the reinforcing phase were 0, 2, 3, and 4 wt.%, while Al–Mg–Si alloy was used as the matrix. Two-step stir casting method was used for the development of the composites. As the BLA content increases in the reinforcing phase of the composites, the mechanical properties such as hardness, ultimate tensile strength, and % elongation decreased. However, superior fracture toughness was observed for the hybrid reinforcing materials than that of the single reinforcing material (Al-10 wt.%) used. The microstructure showed that the BLA and SiC particulates were visibly delineated and fairly well distributed in matrix alloy (Al–Mg–Si alloy) with minimal clustering of the particulates. The hybrid reinforced AMCs showed higher corrosion resistance than the single reinforced AMCs. The presence of silica in the BLA as the major constituent was attributed to be the reason for the corrosion resistance improvement. This silica has the tendency of inhibiting  $Al_4C_3$  phase formation due to the adverse effect  $Al_4C_3$  phase has on the corrosion resistance of AMCs (Alaneme et al., 2013). This shows that the usage of BLA as a reinforcing material has good usage in improving both the mechanical properties and the corrosion behaviour of the matrix alloy it is incorporated into, to form AMCs.

##### 5.5. Utilization of bean pod and its derivatives as reinforcement

Bean is a leguminous plant seeds available for consumption by both human and animals. Beans seeds are covered in a housing known as the pod. After the harvest of green beans, it is usually allowed to dry (sundry) before removing the pods. Beans pods are agro-wastes product obtained after the seeds have been separated from the pods. Most times, these beans pod are burnt in open air contributing to environmental pollution and ozone layer depletion. Hence, in an effort to recycling them, they have found applications in AMCs development as a complementing reinforcing material. Bean pod is recycled by carbonizing it to form bean pod ash (BPA). BPA has been considered to be a promising reinforcement for the bio-composites production due to its low density, cheapness, and availability in huge amount (Aigbodion, 2019). The BPA used in the study of Aigbodion (2019) was obtained using sol-gel method after the bean pod has been calcined at 850 °C for 5 h. The AMCs produced was developed using double stir casting method and double layer feeding method, where the BPA particulates (1–4 wt.%) were incorporated into the A2009 aluminium alloy. The XRD results for the BPA particulates showed the formation of  $SiO_2$ ,  $NaAlSi_3O_8$ ,  $CaCO_3$ , and  $Al_4O_4C$  of nano-structure. The micrograph of the AMCs showed uniform distribution of the reinforcement particulates in which better wettability between the matrix and reinforcement was reported since pores were not observed. The hardness and tensile strength of the AMCs increased as the BPA particles increase. The fracture toughness also increased with BPA particle increase. This implied that the reinforced alloy showed better properties than the unreinforced alloy. However, the impact energy and wear reduced with BPA particulates increase. The composite with the best properties was used to produce a connecting rod for Toyota Carina one. It was reported that the connecting rod developed fuel consumption is lower as the running engine duration increased. Further analysis of the connecting rod produced using Al–Cu–Mg alloy and BPA nanoparticles was examined by Aigbodion et al. (2016). More so, the effect of particle size on the fatigue behaviour of composites produced from Al–Cu–Mg and BPA nanoparticles reinforcement was investigated by Aigbodion et al. (2015). It was reported that BPA nanoparticles are promising bio-ceramics that could improve the properties of AMCs.

##### 5.6. Utilization of palm kernel shell and its derivatives as reinforcement

The oil palm trees plantations are cultivated for a long period of time in Nigeria, Malaysia, and other parts of the world. They have moisture contents that ranged between 11–13% (Ikumapayi and Akinlabi, 2018). The oil palm trees produce oil palm fruits. These palm fruits have palm kernel shells that are covered by the fleshy red parts that could be referred to as the mesocarp. After the process of oil derivation from the oil palm fruits, the remaining part is a hard shell that contains kernel inside of it. The hard shell is referred to as the palm kernel shell (PKS), which contain high lignocellulose content. The PKS is the shell that is left after the removal of the nut (kernel) after it has been forcefully crushed (Ibikunle et al., 2018; Ikubanni et al., 2020b; Ikumapayi and Akinlabi, 2018). The PKS is found in abundance as wastes in palm oil producing areas and has been a biomass waste of choice interest amongst other biomass wastes from oil palm trees. Its abundance nature in palm oil producing areas will continually results in major environmental challenges (Ikubanni et al., 2020b; Ikumapayi and Akinlabi, 2018). Some applications of PKS were reported by Ikumapayi and Akinlabi (2018). The applications include concrete reinforcement, aggregate and additives, energy and fuel production, water purification, and so on. When PKS are used for energy and fuel production, the residue obtained is known as palm kernel shell ash (PKSA). They can be scientifically generated through carbonization in an electric furnace at 900 °C for about 4–5 h (Aigbodion and Ezema, 2019). The PKSA has been found to be useful in the development of MMCs as partial reinforcement with synthetic ceramic materials such as  $SiO_2$ ,  $Al_2O_3$ , and so on. Sol gel method has also been used in obtaining PKSA in nanoparticle forms (Aigbodion and Ezema, 2019). The chemical composition of the PKSAmp obtained by Sol gel method showed the value of  $SiO_2$  to be 96.09 wt.%, CaO (0.30 wt.%),  $Fe_2O_3$  (0.39 wt.%),  $K_2O$  (0.32 wt.%),  $Na_2O$  (0.1 wt.%),  $SO_3$  (0.05 wt.%), MnO (0.06 wt.%), and  $Cr_2O_3$  (0.001 wt.%) (Aigbodion and Ezema, 2019). However, the chemical composition of the PKSA obtained in the study of Oladele and Okoro (2016) are  $SiO_2$  (31.73 wt.%), CaO (20.27 wt.%),  $Fe_2O_3$  (1.78 wt.%),  $K_2O$  (1.51 wt.%),  $Na_2O$  (1.38 wt.%),  $Al_2O_3$  (3.46 wt.%),  $TiO_2$  (12.39 wt.%), MnO (1.27 wt.%).  $SiO_2$  content in the PKSA has been observed from other studies (Aigbodion and Ezema, 2019; Ikubanni et al., 2020b; Oladele and Okoro, 2016) to be higher than other contents. However, variations exist in the chemical compositions from different studies. These variations could be attributed to the kind of method used in obtaining the ash, and the environmental condition where the oil palm tree was planted.

Some of the studies on the utilization of PKSA as partial reinforcement in AMCs are highlighted in this section. Single reinforcement of PKSA nanoparticles was incorporated into A356 alloy for the development of AMCs in the study of Aigbodion and Ezema (2019). The weight percentage of the PKSAmp incorporated into the matrix alloy ranged from 1–4 wt.%, and double layer feeding stir casting method was utilized in the production of the composites. It was observed from the morphology examination that there was uniform distribution of the reinforcement particles in the matrix alloy. The mechanical properties of the composites developed showed improvement as the reinforcement contents increased in the alloy. It was concluded that the developed composites could find multifunctional applications in areas where toughness and strength are crucial. Hybrid reinforcement of PKSA and SiC was utilized in the production of AMCs using Zinc-Aluminium alloy matrix. The PKSA content was varied between 0.2 and 1.0 wt.% with an interval of 0.2 wt.%, while the SiC content was made to be constant. As the wt.% of the PKSA increased in the composition formulation, the hardness and tensile strength increased while the impact energy reduced (Ajibola and Fakeye, 2016). Oladele and Okoro (2016) examined the effect of using PKSA as reinforcement upon the mechanical properties of recycled aluminium alloy obtained from an automobile engine block's cylinder. A portion of the PKSA used was treated with NaOH solution while the other was untreated. The chemically treated and untreated PKSA were incorporated into the as-cast aluminium with wt.% ranging from 5 to 15%,



respectively. Increasing the wt.% of the PKSA beyond 5 wt.% reduced the hardness of the developed composites. Generally, the mechanical properties of the developed composites were improved. Hence, PKSA was suggested to be useful as potential reinforcing material in automobile application. The influence of temperature variation of PKSA produced from PKS at temperatures 900, 1000, and 1100 °C, respectively was investigated by [Ikubanni et al. \(2020b\)](#). The results obtained were compared with raw PKS. It was reported that there were changes in the colours of the ash formed as the temperature was increased. The presence of silica content was the highest amongst all the oxides present in the ash. A trace of SiC was confirmed through the FTIR conducted. It was concluded that temperature 900 °C was enough to produce ash from PKS. Temperature increment beyond 900 °C could lead to the formation of some geological minerals. The produced PKSA was said to be useful in the development of MMCs as partial reinforcing material. More studies are on-going to confirm the effects of PKSA addition as reinforcement on metal matrix alloy for the production of AMCs. Furthermore, hybrid reinforcement of PKSA and SiC at some varied ratios were incorporated into Al6063 matrix for the production of Aluminium matrix composites. The incorporated PKSA particulates helped to obtain reduced weight and improved strength in the composites ([Ikubanni et al., 2021a](#)), while the tribological properties of the composites synthesized from the usage of the PKSA particulates as well as SiC were optimized ([Ikubanni et al., 2021b](#)). [Table 5](#) shows some other studies that have been done using agro-wastes as reinforcements in AMCs, their compositions, method of production of the AMCs, and the general remarks.

## 6. Microelectromechanical system

Sensors of high sensitivity are needed in many applications to sense small biological entities such as low concentrated solution and stiffness of object ([Nnodim et al., 2019a, 2019b](#)). Further miniaturization using nanofabrication techniques allows for higher mass sensitivity but includes low device-to-device reproducibility and electrical interface difficulties to measuring equipment ([Grieshaber et al., 2008](#); [Nnodim et al., 2021](#); [Okolie et al., 2017](#)). [Heidari et al. \(2011\)](#) developed a biomass sensor with ultrasensitive dielectric filled Lamé mode. Compared to previous biomass sensors, the sensor demonstrated a high potential for detecting small biological agents by providing a high-quality output signal at atmospheric pressure. A biomass sensor comprise of micro-machined silicon squared plate that is excited in the Lamé bulk acoustic resonant mode with a mass sensitivity of -400 Hz/pg, at a frequency of 37.8 MHz, and quality factor of 10,000 as shown in [Figure 8](#). The resonators were manufactured using the MEMS silicon on insulator process. The micro-resonator consists of a square plate, backed by four beams from the corners connected to it. For Lamé-mode square resonator, the measurements were performed to obtain the motion resistance, Rx, quality factor Q, and resonance frequency. The findings obtained indicate greater sensitivity of the mass for smaller resonators. A 100µm approximate sensitivity to the mass is -400 Hz/pg. These findings open up new possibilities for biomass sensors of higher sensitivity and even multi-arrayed parallel mass detection.

[Chudnovsky et al. \(2018\)](#) monitored complex mixtures of monosaccharides extracted from macroalgae biomass by incorporating micro-electromechanical and optical techniques. The study was intended to encourage the production of macroalgal biomass for applications in the biorefinery. The authors tested two orthogonal techniques for rapid phenotyping of the green macroalga *Ulva* based on its content of glucose, rhamnose, xylose and glucuronic acid as obtained by acid hydrolysis for comparison. Partial Least Squares (PLS) regression analyzes, slope calculations and correlations through various spectral ranges/frequencies were used to predict monosaccharide content using two complementary methods: Near Infrared Reflection Spectroscopy (NIRS) and Resonant Membrane Vibrometry Microelectromechanical System (MEMS). The best estimate for the contents of rhamnose and glucose was made. In estimating the concentrations, greater accuracy for MEMS was obtained. This result is

crucial to opening new perspectives for the development of simple, multifunctional sensors for downstream processing control of biomass in biorefinery and biometric applications. [Takei \(2012\)](#) conducted a UV nanoimprint lithography using plant resistance materials with biomass and medicinal derivative lactulose. In the specified UV nanoimprint conditions of multilayer etching processes using silicon-based middle layer and novolac-based bottom layer, authors demonstrated seventy nanometers of half pitch line patterning. Their research aimed at investigating a new chemical approach to resistant material derived from biomass and medicinal drugs and providing precise UV nanoimprint process conditions semiconductor and bio-nanoelectronic lithography for next-generation manufacture. For UV nanoimprint lithography a high-resolution plant-based resistant material that had unique desired properties has been successfully demonstrated. This result will assist in generating MEMS biomass sensors with high resolution.

## 7. The use of biomass in traditional medicine

Biomass especially the lignocellulosic types such as wood dust, agricultural residues and herbaceous (grasses) are ancient raw materials that are natural ingredient for traditional medicine. Biomass contains cellulose, hemicellulose, lignin, and some natural or extractive compounds. The key links and procedures from extraction to construction of drug/medicine deliveries are shown in [Figure 9](#) ([Si, 2019](#)). The role of lignocellulosic biomass is increasingly receiving much attention in medicine/drug development amidst researchers in the last decades. For example, [Kopania et al. \(2014\)](#) extracted galactoglucommas (GMMs) from spruce sawdust for medical applications. The GGMs were extracted using thermal enzymatic treatment in aqueous environment. The biopolymer composite obtained with the combination of GGMs with microcrystalline chitosan was reported suitable for wound dressing in form of sponges. The spruce sawdust which is a reliable source of energy and can be applied in construction is also a confirm ingredient as wound dressing materials. [Panee \(2015\)](#) examined the potential medicinal application of bamboo extracts and its toxicity. Bamboo was evaluated to have wide range of protective effects such as protection against oxidative stress, cancer, inflammation, lipotoxicity and cardiovascular diseases. Extracts from bamboo parts such as stems, shoots and leaves were found effective in the regards of the stated medical functions. Researches are still vastly pinned on the use of bamboo vigor to cure skin diseases. Lemon grass, a lignocellulosic biomass applicable for other purposes, was suggested for medicinal application because of its therapeutic values: anticulicid, anti-cancer, hypoglycemic, hypolipidemic, anti-viral, anxiolytic, anti-inflammatory, anti-microbial and hypercholesteremic ([Ranade and Thiagarajan, 2015](#)). There are vast arrays of ethnopharmacological applications of lemon grass. The grass contains bioactive compounds such as flavonoids, phenols, saponins and tannis. These makes it a potent herb for pharmacognostic application. [Kumar et al. \(2020a,b\)](#) developed Zinc-loaded nano particles hydrogel from sugarcane bagasse for special medical applications. It was developed through an in-situ method. ZnO-NPs hydrogels extracted showed a great antibacterial action through Gram-positive and negative bacterial. The ZnO-NPs hydrogel was recommended for biomedical applications. Another work on sugarcane bagasse by [Harish et al. \(2020\)](#) centered on facile synthesis of SiO<sub>2</sub>/CMC/Ag hybrids derived from biomass waste (sugarcane bagasse) for special medical applications. The research used sol gel technique to synthesize amorphous SiO<sub>2</sub> hybrids from lab-made CMC using sugarcane bagasse and tetraethoxysilane comprising silve nano particles. Different bacterial tests were carried out and the Ag-NPs hybrids performed better compared with synthetic CMC from the market. Lignocellulosic biomass are useful for medical purposes in terms of tissue engineering, drug delivery (hydrogel, membranes, nanoparticles, and microcapsules), biosensor and so on. Biomass have great potential as they continue to be explored for biological applications. Thus, making biomass valuably needed in several sphere.



**Table 5.** Chemical compositions and MMCs production method of some agro-wastes.

Agro waste/ Reference	Main Chemical Composition (wt.%)									Production method	General remarks	Reference
	SiO <sub>2</sub>	Al <sub>2</sub> O <sub>3</sub>	Fe <sub>2</sub> O <sub>3</sub>	CaO	MgO	K <sub>2</sub> O	TiO <sub>2</sub>	Na <sub>2</sub> O	MnO			
Coconut shell ash (CSA)	36	23	7	3.2	2.5	0.75	-	-	-	Compo casting	5, 10, and 15% of CSA was used in Al-1100 alloy for the production of the MMC using compo-casting. The hardness and tensile strength increase while density and percentage elongation reduced as CSA particles increased. The wear parameters were optimized.	Rallabandi and Rao (2019)
Coconut shell ash (CSA)	36–40	23–25	11–16	3–5	2–3	0.7–0.95	-	-	-	Stir casting	The particulates of CSA at 5, 10, 15 wt.% were incorporated into Al-1100 alloy. The study optimized the wear behaviour of the composites developed using the load, CSA wt.% and sliding distance to obtain responses and such as wear, wear rate, and coefficient of friction.	Raju et al. (2019)
Lemon Grass ash (LGA)	57.9	0.17	-	6.45	3.55	29.7	-	-	-	Compo casting	MMC was fabricated using Al 6061 alloy and reinforced with LGA at 3, 5, and 7 wt.%. The mechanical properties tested showed linear improvement at the optimum LGA reinforcement addition.	Jose et al. (2018)
Rice husk ash (RHA)	93.4	0.238	0.167	0.82	0.53	1.94	-	0.25	-	Stir casting	Al–Si alloy was incorporated separately with RHA and fly ash (FA). Mechanical tests carried out on the samples developed showed improvement when RHA and FA were added.	Ajit et al. (2017)
Bamboo leaf ash (BLA)	75.9	4.13	1.22	7.47	1.85	5.62	0.2	-	-	Double stir casting	Hybrid reinforcement of BLA and SiC was utilized in the MMCs development using Zn–27Al alloy as matrix. The mechanical and corrosion behaviour of the composites were examined.	Alaneme et al. (2014)
Corn cob ash (CCA)	77.1	5.64	2.97	2.45	1.71	3.81	0.25	0.49	0.23	Two-step stir casting	Hybrid reinforcement (SiC and CCA) was utilized to develop MMCs using as Al–Si–Mg alloy as matrix at 10 wt.% of the reinforcement. The mechanical properties of the developed MMCs were characterized as well as the microstructure. The usage of CCA was concluded to have great potential as reinforcing material for AMCs development.	Fatile et al. (2014)
Rice husk ash (RHA)	90.2	3.54	0.21	1.23	0.53	-	-	-	-	Double stir casting	The AMCs were produced using hybrid reinforcement of RHA and FA. The study majorly studied the tribological characteristics of the reinforcements in the Al–7Si–0.3Mg matrix.	Vinod et al. (2019)
Coconut shell ash (CCA)	44.1	14.6	13.4	0.67	17.2	0.42	-	0.35	0.22	Squeeze casting	LM 24 alloy was reinforced with hybrid SiC and CSA reinforcements. The developed composites were characterized for physico-mechanical properties, wear characteristics, and the process was optimized. The usage of CSA was found useful in MMCs development.	Arulraj (2019)
Bamboo leaf ash (BLA)	76.2	4.13	1.32	6.68	1.85	5.62	-	-	-	Stir casting	BLA particles of 2, 4, and 6 wt.% were used as reinforcement in Al-4.5%Cu alloy. The developed AMCs were characterized for the physical and mechanical properties. The density reduced as BLA content increased and the hardness and tensile strength increased up to 4 wt.% BLA.	Kumar and Birru (2017)
Bagasse ash (BA)	77.3	10.95	3.66	2.09	1.49	3.16	-	0.381	-	Stir casting	BA was used as reinforcement in the composite developed using Al as the base metal. The results showed better mechanical properties improvement. The obtained results were compared with the AMCs developed using RHA as reinforcement.	Usman et al. (2014)
Sugar cane bagasse ash (SCBA)	71.1	1.8	1.28	4.02	4.96	10.7	0.11	1.02	-	Vacuum-assisted stir casting	Al 6061 hybrid composites were produced using alumina and SCBA as reinforcements. The development MMCs were characterized to indicate	Chandla et al. (2020)

(continued on next page)

Table 5 (continued)

Agro waste/ Reference	Main Chemical Composition (wt.%)									Production method	General remarks	Reference
	SiO <sub>2</sub>	Al <sub>2</sub> O <sub>3</sub>	Fe <sub>2</sub> O <sub>3</sub>	CaO	MgO	K <sub>2</sub> O	TiO <sub>2</sub>	Na <sub>2</sub> O	MnO			
											improvement of properties over un-reinforced alloy.	
Groundnut shell ash (GSA)	17.6	5.93	3.43	9.89	9.79	18.3	0.22	4.85	0.08	Stir casting	Al 6063 alloy was reinforced GSA at 3, 6, 9, 12 wt.% of the ash. The mechanical properties were observed to be improved as a result of the GSA addition.	Singh et al. (2015)
Groundnut shell ash (GSA)	41.4	11.75	12.6	11.2	3.51	11.9	0.63	1.02	0.23	Two-step stir casting	The mechanical and corrosion behaviour of SiC and GSA reinforced Zn-s7Al alloy composites were studied.	Alaneme et al. (2014)
Palm kernel shell (PKS)	55.7	9.43	3.32	11.2	4.85	9.71	-	1.76	0.72	Stir casting	Monolithic reinforcement of PKS particulate ranging between 2.5 and 15 wt.% was incorporated into Al 6063 matrix. The composites developed were characterized to obtain different parameters.	Edoziuno et al. (2020)
Palm kernel shell ash (PKSA)	31.7	3.46	1.78	20.3	1.01	1.51	12.4	1.38	1.27	-	The impact of age-hardening on the mechanical properties of as-cast aluminium alloy composites obtained from cylinders of automobile engine block was reinforced with PKSA.	Oluwole and Okoro (2016)
Melon shell ash (MSA)	75.3	2.67	1.3	2.11	0.37	4.7	0.16	0.53	0.37	Stir casting	MSA was used as reinforcement in the production of MMC using Al-7%Si-0.3Mg base alloy. The microstructure and thermal behavioural studies were investigated. The study showed improved property of Al-Si-Mg alloy up to 20 wt.%.	Abdulwahab et al. (2017)
Melon shell ash (MSA)	84.3	3.54	1.3	2.11	0.37	4.7	-	0.53	0.36	Gravity die stir casting	MMCs were developed using Al-12%Si matrix and MSA reinforcement particulates. The mechanical, microstructure, and wear behaviours of the developed composites were examined.	Suleiman et al. (2018)

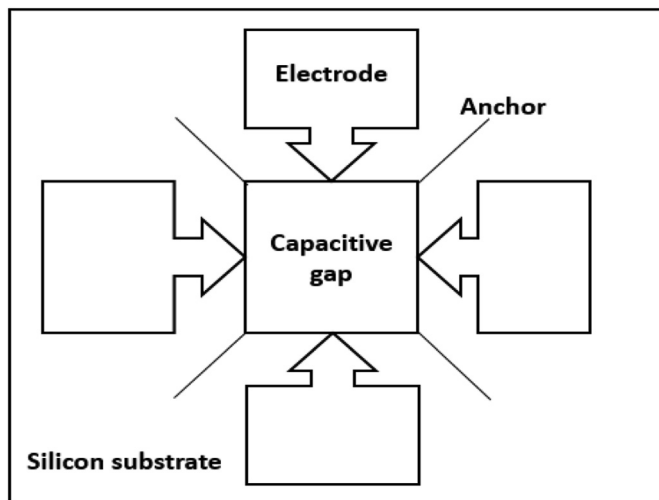

Figure 8. Schematic image of the biomass sensor.

## 8. The sustainability of multifaceted use of biomass

Despite the numerous applications of biomass, the volume of biomass produced cannot sustain its multifaceted usage. Considering the power sector for instance, biomass is viewed as an alternative to fossil fuel. If the whole world were to abandon other means of energy supply and rely massively on biofuels, then there will be pronounced shortage of energy globally. In Sweden alone, the demand for forests fuels is expected to rise to 40 TW h by 2050 (Börjesson et al., 2017). Similarly, if limestone were to be replaced by periwinkle shell ash, or snail shell ash or other biomass substitutes in the production of cement, there would not be enough to meet its

demands. This implies that there is need to either streamline the usage of biomass to certain applications or make deliberate efforts to improve the supply chain of biomass to meet its multifaceted usage. Several researchers have attempted to postulate measures to increase the supply of biomass. The use of municipal wastes has been viewed as an option. Only a few countries derive biomass from municipal wastes. Many countries, particularly Africa, are yet to maximize municipal wastes for various purposes. Municipal wastes will always be generated based on daily activities of man. It can be a steady supply of biomass for energy generation and other usages if collected and segregated appropriately. Bacha et al. (2011) postulated the deliberate production of yeast from agro-waste for food formulation. Agro-waste is one of the numerous wastes generated from man activities, which are usually dumped in municipal refuse dump sites (Massaro et al., 2014; Gabisa and Gheewala, 2018; Wang et al., 2018).

Also, deliberate cultivation of certain crops and trees in forest areas and unused or marginal lands for the purpose of biomass generation is a way to improve and ensure steady supply of biomass materials for diverse uses. Similarly, the practice of ranching will ensure that animal wastes are collected in quantities large enough for biomass application as against the open grazing method practiced in many African countries. This view was supported by Guldhe et al. (2017) who proposed the cultivation of microalgae in waste aquatic water and the setting up of biorefinery for the sustained production of biomass and nutrient recirculation. Mehmood et al. (2017) proposed the use of marginal lands for intentional cultivation of biomass for its multipurpose usage. The setting up of biomass conversion plants in specific locations will create a value chain industry that is capable of self-sustainability. Tan et al. (2012) posited the multi-regional input-output model for biomass production, which implies that each region should cultivate and grow biomass crops specific to them in order to reduce the cost of trading or importing and the impact of overdependence on one region for biomass supply on the climate of that region. By implication, siting of local biomass conversion factories on regional basis is one way to ensure the sustainability of

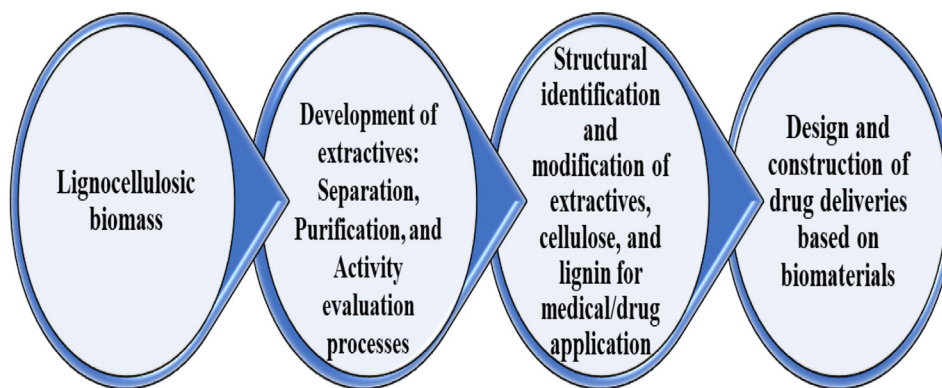

Figure 9. Links from extraction to deliveries of drug/medicine using biomass.

biomass production without negatively affecting climatic conditions. Few factories work on biomass wastes in most countries. This makes the collection of biomass wastes unattractive to citizens. Most biomass products in Nigeria for instance are by research organizations and universities, which often end at that level. Commercialization of biomass products will bring out its economic relevance and create a supply chain that will readily sustain the production of biomass products (Manzone et al., 2017; IEA, 2019). Sherwood (2020) viewed biomass production as minimizing food and agricultural wastes and returning value to the economy. By this, biomass production is a way of maintaining a circular economy with minimal loss of resources.

One of the major challenges to the use of biomass products that affects its sustainability is the issue of public acceptance of biomass materials and products as reliable alternatives to the conventional ones. Robust public awareness campaign and proper productization in terms of packaging of biomass products can be deployed to eradicate this challenge. Bhattacharya et al. (2003) analyzed the financial prospects of biomass production for energy generation in specific Asian countries. It was discovered that investment cost for producing a hectare of biomass ranges from US\$381 to 1842 within the selected countries. The study also discovered that biomass plantation is a major source of biomass supply and the major barrier to the expansion of these plantations is the low commercial demand for biomass. The authors recommended the need for public policies to promote the use of biomass utilities in order to drive demand. Börjesson et al. (2017) decried the rising future demand for biomass production and proposed combined regulation and incentive approach to motivate key players in the sector. Daioglou et al. (2019) stated that biomass production requires land and also emphasized that strict mitigation targets are vital on the availability of advanced technologies in the use of biomass fuel for energy generation. In the study carried out by Sherwood (2020), it was stated that enhancing cooperation among value chain actors is one of measures that can sustain biomass supply for its multifaceted demands.

### 9. Some recommended policies and future work

Biomass multipurpose utilization has come to stay. The set policies suggested by the European Union (EU) on energy should be spread to all arms of its application. Maximum use of biomass should be encouraged to deliver robust and verifiable greenhouse gas savings. This will enable fair competition between various uses of biomass materials. Thus, an encompassing sustainable use of land and forest management. Five key strategies, which were developed from EU's recommendations are; ensure the use of biomaterials to mitigate climate change, avoid direct and indirect land use change, minimize biodiversity impacts, ensure biomass multifaceted usage and discourage trade barriers of biomass world widely. In order to facilitate these suggestions, facing the following risks will help develop policies by stakeholders across the globe. These includes supply chain rated greenhouse gas emission, greenhouse gas

emission related to biogenic carbon stocks, greenhouse has emission related to indirect use of land change, impact on biodiversity, soil and water, impact on air, efficiency of biomass conversion, competition amidst multiusers and distortion of single market. These factors will help in developing a robust policy by stakeholders (Banja et al., 2019).

The research works hitherto on biomass is encouraging across the globe in using it for various application. Future works that have been found across this review effort is the necessity for pilot scale studies on various laboratory efforts from different researchers on the specific use they worked on. There should be more research work on biomass energy application in terms of liquid, gas and solid products. The use of biomass in construction is also viable. Thus, the need for pilot scale studies in geopolymer production, tiles development, interior building materials and others. Research works should also focus on pilot scale work on the use in the development of aluminum alloy matrix. These efforts will ensure its commercialization across continents.

### 10. Conclusion

The review work brought out the multifaceted use of biomass. Biomass has been successfully utilized as energy source. Solid liquid and gas products have formed from various biomass types at laboratory scale. Methods such as torrefaction, carbonization, densification, hydrolysis, fermentation, transesterification, acetogenesis and pyrolysis are common for biomass energy extraction. The reviewed heating value for liquid product from biomass processing varied from 12.2 to 35 MJ/kg. Biomass are useful for construction work as raw materials in tiles, concrete aggregate and geopolymer production. The recent advent is biomass use for geopolymer based on biomass ash composition that is rich in SiO<sub>2</sub> and Al<sub>2</sub>O<sub>3</sub> (aluminosilicate). The review also conclude that is useful as reinforcement for the development of metal matrix composites. Significantly, the ash of various biomass are cogent in this application. Biomass is also a raw material for microelectromechanical system and traditional medicine. Based on the current supply chain, biomass multifaceted use may still end at the laboratory stage. Advances in technology of production and public policies on biomass utilities will translate to sustained biomass demands that will indirectly drive supply.

### Declarations

#### Author contribution statement

All authors listed have significantly contributed to the development and the writing of this article.

#### Funding statement

This research did not receive any specific grant from funding agencies in the public, commercial, or not-for-profit sectors.

**Data availability statement**

Data will be made available on request.

**Declaration of interests statement**

The authors declare no conflict of interest.

**Additional information**

No additional information is available for this paper.

**References**

- Abdulwahab, M., Umaru, O.B., Bawa, M.A., Jibo, H.A., 2017. Microstructural and thermal study of Al-Si-Mg/melon shell ash particulate composite. *Result Phys.* 7, 947–954.
- Adeiran, A.A., Alaneme, K.K., Oladele, I.O., Akinlabi, E.T., 2018. Processing and structural characterization of Si-based carbothermal derivatives of rice husk. *Cogent Eng.* 5, 1–12.
- Adeleke, A.A., Odusote, J.K., Lasode, O.A., Ikubanni, P.P., Madhurai, M., 2019a. Evaluation of thermal decomposition characteristics and kinetic parameters of melina wood. *Biofuels* 10 (4), 1–7.
- Adeleke, A.A., Odusote, J.K., Lasode, O.A., Ikubanni, P.P., Malathi, M., Paswan, D., 2019b. Densification of coal fines and mildly torrefied biomass into composite fuel using different organic binders. *Heliyon* 5 (7), e02160.
- Adeleke, A.A., Odusote, J.K., Paswan, D., Lasode, O.A., Malathi, M., 2019c. Influence of torrefaction on lignocellulosic woody biomass of Nigerian origin. *J. Chem. Technol. Metall.* 54 (2), 274–285.
- Adeleke, A.A., Odusote, J.K., Ikubanni, P.P., Lasode, O.A., Malathi, M., Paswan, D., 2020a. The ignitability, fuel ratio and ash fusion temperatures of torrefied woody biomass. *Heliyon* 6 (3), e03582.
- Adeleke, A.A., Odusote, J.K., Ikubanni, P.P., Lasode, O.A., Malathi, M., Paswan, D., 2020b. The ignitability, fuel ratio and ash fusion temperatures of torrefied woody biomass. *Heliyon* 6 (3), e03582.
- Adeleke, A.A., Odusote, J.K., Ikubanni, P.P., Orhadahwe, T.A., Lasode, O.A., Ammasi, A., Kumar, K., 2021. Ash analyses of bio-coal briquettes produced using blended binder. *Sci. Rep.* 11, 547.
- Ahiduzzaman, M., Islam, A.K.M.S., 2011. Greenhouse gas emission and renewable energy sources for sustainable development in Bangladesh. *Renew. Sustain. Energy Rev.* 15 (9), 4659–4666.
- Ahmed, M.M., Tjalfé, G.P., Kuichuan, S., 2016. Fungal pretreatment of rice straw with *Pleurotus ostreatus* and *Trichoderma reesei* to enhance methane production under solid-state anaerobic digestion. *Appl. Energy* 180, 661–671.
- Ahmed, M.M., Tjalfé, G.P., Yihua, X., Kuichuan, S., 2017. Combinations of fungal and milling pretreatments for enhancing rice straw biogas production during solid-state anaerobic digestion. *Bioresour. Technol.* 224, 174–182.
- Ahoru, R., Medina, F., Constanti, M., 2018. Significance and challenges of biomass as a suitable feedstock for bioenergy and biochemical Production : a review. *Energies* 11 (3366).
- Aigbodion, V.S., 2019. Bean pod ash nanoparticles a promising reinforcement for aluminium matrix biocomposites. *J. Mater. Res. Technol.* 8 (6), 6011–6020.
- Aigbodion, V.S., Ezema, I.C., 2019. Multifunctional A356 alloy/PKSAnp composites: microstructure and mechanical properties. *Defence Technol.* 1–6.
- Aigbodion, V.S., Atuanya, C.U., Obiorah, S.O., Isah, L.A., Neufe, S.I., Omah, A.D., 2015. Effect of particle size on the fatigue behaviour of Al-Cu-Mg/Bean pod ash particulates composites. *Trans. Indian Inst. Met.* 68 (3), 495–499.
- Aigbodion, V.S., Agunsoye, O.J., Edokpia, R.O., Ezema, I.C., 2016. Performance analysis of a connecting rod produced with Al-Cu-Mg/Bean pod ash nanoparticles. *Silicon* 10, 107–113.
- Ajibola, W.A., Fakeye, A.B., 2016. Production and characterization of zinc-aluminium, silicon carbide reinforced with palm kernel shell ash. *Int. J. Eng. Trends Technol.* 41 (6).
- Ajit, K.S., Shantannu, K.S., Saylesh, S., Sudhakar, S., Pratyush, R.P., Nitesh, S., 2017. A comparative investigation on physical and mechanical properties of MMC reinforced with waste materials. *Int. J. Eng. Adv. Technol.* 6 (4), 161–169.
- Ajimotoke, H.A., Ehindero, A.O., Ajao, K.S., Adeleke, A.A., Ikubanni, P.P., Shuaib-Babata, Y.L., 2019. Combustion characteristics of fuel briquettes made from charcoal particles and sawdust agglomerates. *Sci. Afr.* 6, e00202.
- Alaneme, K.K., Adewale, T.M., 2013. Influence of rice husk ash-silicon carbide weight ratios on the mechanical behaviour of Al-Mg-Si alloy matrix hybrid composites. *Tribol. Indust.* 35 (2), 163–172.
- Alaneme, K.K., Adewuyi, E.O., 2013. Mechanical behaviour of Al-Mg-Si matrix composites reinforced with alumina and bamboo leaf ash. *J. Inst. Eng.* 19 (3), 177–187.
- Alaneme, K.K., Sanusi, K.O., 2015. Microstructural characteristics, mechanical and wear behaviour of aluminium matrix hybrid composites reinforced with alumina, rice husk ash and graphite. *Eng. Sci. Technol. Int. J.* 18, 416–422.
- Alaneme, K.K., Akintunde, I.B., Olubambi, P.A., Adewale, T.M., 2013. Fabrication characteristics and mechanical behaviour of rice husk ash-alumina reinforced Al-Mg-Si alloy matrix hybrid composites. *J. Mater. Res. Technol.* 2, 60–67.
- Alaneme, K.K., Adama, S.I., Oke, S.R., 2014a. Mechanical properties and corrosion behaviour of Zn-27Al based composites reinforced with silicon carbide and bamboo leaf ash. *Leonardo Electron. J. Pract. Technol.* 25, 58–71.
- Alaneme, K.K., Olubambi, P.A., Afolabi, A.S., Bodunrin, M.O., 2014b. Corrosion and tribological studies of bamboo leaf ash and alumina reinforced Al-Mg-Si alloy matrix hybrid composites in chloride medium. *Int. J. Electrochem. Sci.* 9, 5663–5674.
- Alaneme, K.K., Eze, H.I., Bodunrin, M.O., 2015. Corrosion behaviour of groundnut shell ash and silicon carbide hybrid reinforced Al-Mg-Si alloy matrix composites in 3.5% NaCl and 0.3M H<sub>2</sub>SO<sub>4</sub> solutions. *Leonardo Electron. J. Pract. Technol.* 14 (26), 141–158.
- Alaneme, K.K., Bodunrin, M.O., Awe, A.A., 2018. Microstructure, mechanical and fracture properties of groundnut shell ash and silicon carbide dispersion strengthened aluminium matrix composites. *J. King Saud Univ. Eng. Sci.* 30 (1), 96–103.
- Álvarez-Álvarez, P., Pizarro, C., Barrio-Anta, M., Cámara-Obrigón, A., María Bueno, J.L., Álvarez, A., Gutiérrez, I., Burslem, D.F.R.P., 2018. Evaluation of tree species for biomass energy production in Northwest Spain. *Forests* 9 (4), 1–15.
- Amin, M., Abdelsalam, B.A., 2019. Efficiency of rice husk ash and fly ash as reactivity materials in sustainable concrete. *Sustain. Environ. Res.* 29.
- Arulraj, M., 2019. Experimental Studies on Squeeze Casting of Hybrid Aluminium Matrix Composite Reinforced with Silicon Carbide and Coconut Shell Ash. Thesis faculty of Mechanical Engineering.
- Bacha, U., Nasir, M., Khaliq, A., Anjum, A.A., Jabbar, M.A., 2011. Comparative assessment of various agro-industrial wastes for *Saccharomyces cerevisiae* biomass production and its quality evaluation as single cell protein. *J. Anim. Plant Sci.* 21 (4), 844–849.
- Bahrami, A., Soltani, N., Pech-Canul, M.L., Gutiérrez, C.A., 2016. Development of metal-matrix composites from industrial/agricultural waste materials and their derivatives. *Crit. Rev. Environ. Sci. Technol.* 46 (2), 143–207.
- Balogun, A.O., McDonald, A.G., 2016. Decomposition kinetic study, spectroscopic and pyrolytic analyses of *Isobertia doka* and *Pinus ponderosa*. *Biomass Convers. Bioref.* 6, 315–324.
- Balogun, A.O., Lasode, O.A., McDonald, A.G., 2014. Devolatilisation kinetics and pyrolytic analyses of *Tectona grandis* (teak). *Bioresour. Technol.* 156, 57–62.
- Balogun, A.O., Lasode, O.A., McDonald, A.G., 2018. Thermochemical and pyrolytic analyses of *Musa* spp. residues from the rainforest belt of Nigeria. *Environ. Prog. Sustain. Energy* 37, 1932–1941.
- Balogun, A.O., Adeleke, A.A., Ikubanni, P.P., Adegoke, S.O., Alayat, A.M., McDonald, A.G., 2021a. Physico-chemical characterization, thermal decomposition and kinetic modeling of *Digitaria sanguinalis* under nitrogen and air environments. *Case Stud. Thermal Eng.* 26, 101138.
- Balogun, A.O., Adeleke, A.A., Ikubanni, P.P., Adegoke, S.O., Alayat, A.M., McDonald, A.G., 2021b. Kinetic modeling, thermodynamics and thermal performance assessments of pyrolytic decomposition of *Moringa oleifera* husk and *Delonix regia* pod. *Sci. Rep.* 11 (1), 1–12.
- Bamgboye, A., Jekayinfa, S., 2006. Energy consumption pattern in palm kernel oil processing operations. *Agric. Eng. Int.* 8, 1–11.
- Banja, M., Sikkema, R., Jégard, M., Motola, V., Dallemand, J.F., 2019. Biomass for energy in the EU—The support framework. *Energy Pol.* 131, 215–228.
- Bhattacharya, S.C., Salam, P.A., Pham, H.L., Ravindranath, N.H., 2003. Sustainable biomass production for energy in selected Asian countries. *Biomass Bioenergy* 25 (5), 471–482.
- Binbin, H., Jiali, D., Bin, L., Huan, Z., Xufeng, Y., Xiaofen, W., Zongjun, C., 2016. Pretreatment of non-sterile, rotted silage maize straw by the microbial community MCI increases biogas production. *Bioresour. Technol.* 216, 699–705.
- Börjesson, P., Hansson, J., Berndes, G., 2017. Future demand for forest-based biomass for energy purposes in Sweden. *For. Ecol. Manag.* 383, 17–26.
- Brachi, P., Miccio, F., Ruoppolo, G., Miccio, M., 2017. Pressurized steam torrefaction of biomass: focus on solid, liquid, and gas phase distributions. *Ind. Eng. Chem. Res.* 56 (42), 12163–12173.
- Chandla, N.K., Yashpal, Kant, S., Goud, M.M., Jawalkar, C.S., 2020. Experimental analysis and mechanical characterization of Al 6061/alumina/bagasse ash hybrid reinforced metal matrix composite using vacuum-assisted stir casting method. *J. Compos. Mater.* 54 (27), 4283–4297.
- Cherubini, F., 2010. The biorefinery concept : using biomass instead of oil for producing energy and chemicals. *Energy Convers. Manag.* 51 (7), 1412–1421.
- Choi, J., Choi, J.W., Suh, D.J., Ha, J.M., Hwang, J.W., Jung, H.W., Lee, K.Y., Woo, H.C., 2014. Production of brown algae pyrolysis oils for liquid biofuels depending on the chemical pretreatment methods. *Energy Convers. Manag.* 86, 371–378.
- Choi, J.H., Kim, S.S., Ly, H.V., Kim, J., Woo, H.C., 2017. Effects of water-washing *Saccharina japonica* on fast pyrolysis in a bubbling fluidized-bed reactor. *Biomass Bioenergy* 98, 112–123.
- Chudnovsky, A., Golberg, A., Linzon, Y., 2018. Monitoring complex monosaccharide mixtures derived from macroalgae biomass by combined optical and microelectromechanical techniques. *Process Biochem.* 68, 136–145.
- da Costa, T.P., Quinteiro, P., Tarelho, L.A.C., Arroja, L., Dias, A.C., 2019. Environmental assessment of valorisation alternatives for woody biomass ash in construction materials. *Resour. Conserv. Recycl.* 148, 67–79.
- Daiglou, V., Doelman, J.C., Wicke, B., Faaij, A., van Vuuren, D.P., 2019. Integrated assessment of biomass supply and demand in climate change mitigation scenarios. *Global Environ. Change* 54, 88–101.
- Daramola, O.O., Adediran, A.A., Fadumiye, A.T., 2015. Evaluation of the mechanical properties and corrosion behaviour of coconut shell ash reinforced aluminium (6063) alloy composites. *Leonardo Electron. J. Pract. Technol.* 14 (27), 107–119.
- De la Rubia, M.A., Villamil, J.A., Rodriguez, J.J., Borja, R., Mohedano, A.F., 2018. Mesophilic anaerobic co-digestion of the organic fraction of municipal solid waste



- with the liquid fraction from hydrothermal carbonization of sewage sludge. *Waste Manag.* 76, 315–322.
- Deshmukh, P., Bhatt, J., Peshwe, D., Pathak, S., 2012. Development and characterization of Al based MMC by using RHA and metallurgical grade SiO<sub>2</sub> with varying percentage of Mg. *J. Nanotechnol. Appl.* 12, 1–10.
- Dinakaran, I., Kalaiselvan, K., Murugan, N., 2017. Influence of rice husk ash particles on microstructure and tensile behavior of AA6061 aluminum matrix composites produced using friction stir processing. *Comp. Commun.* 3, 42–46.
- Duc, P.A., Dharanipriya, P., Velmurugan, B.K., Shanmugavadivu, M., 2019. Groundnut shell -a beneficial bio-waste. *Biocatal. Agricult. Biotechnol.* 20, 1–5 (101206).
- Edoziuno, F.O., Adediran, A.A., Odoni, B.U., Utu, O.G., Olayanju, A., 2020. Physico-chemical and morphological evaluation of palm kernel shell particulate reinforced aluminium matrix composites. *Mater. Today Proc.*
- Fabiana, P., Andrea, H.D., Paqui, B., Teresa, V., Ivet, F., 2016. Improving biogas production from microalgae by enzymatic pretreatment. *Bioresour. Technol.* 199, 347–351.
- Farooq, A., Shafaghath, H., Jae, J., Jung, S.C., Park, Y.K., 2019. Enhanced stability of bio-oil and diesel fuel emulsion using Span 80 and Tween 60 emulsifiers. *J. Environ. Manag.* 231, 694–700.
- Fatle, O.B., Akinruli, J.I., Aa, A., 2014. Microstructure and mechanical behaviour of stir-casting Al-Mg-Si alloy matrix hybrid composites reinforced with corn cob ash and silicon carbide. *Int. J. Eng. Technol. Innovat.* 4 (4), 251–259.
- Food and Agriculture Organization, 2020. FAO STAT. [www.fao.org/faostat/en/#data/QC](http://www.fao.org/faostat/en/#data/QC).
- Frei, M., 2013. Lignin: characterization of a multifaceted crop component. *Sci. World J.* 1–25, 2013.
- Gaballah, N.M., Zikry, A.A.F., El-Hussiny, N.A., Khalifa, M.G.E.D., Farag, A.E.F.B., Shallabi, M.E.M.H., 2015. Reducibility mill scale industrial waste via coke breeze at 850–950°C. *Sci. Sinter.* 47 (1), 95–105.
- Gabisa, E.W., Gheewala, S.H., 2018. Potential of bio-energy production in Ethiopia based on available biomass residues. *Biomass Bioenergy* 111, 77–87.
- Gao, W., Tabil, L.G., Dumonceaux, T., Ríos, S.E., Zhao, R., 2017. Optimization of biological pretreatment to enhance the quality of wheat straw pellets. *Biomass Bioenergy* 97, 77–89.
- Ge, S., Liu, L., Xue, Q., Yuan, Z., 2016. Effects of exogenous aerobic bacteria on methane production and biodegradation of municipal solid waste in bioreactors. *Waste Manag.* 55, 93–98.
- Goldemberg, J., Johansson, T.B., Reddy, A.K.N., Williams, R.H., 2001. Energy for the new millennium. *AMBIO A J. Hum. Environ.* 30 (6), 330–337.
- Greinert, A., Mrówczyńska, M., Szefer, W., 2019. The use of waste biomass from the wood industry and municipal sources for energy production. *Sustainability* 11 (11), 2111.
- Grieshaber, D., MacKenzie, R., Voros, J., Reimhult, E., 2008. Electrochemical biosensors - sensor principles and architectures. *Sensors* 8, 1400–1458.
- Guldhe, A., Ansari, F.A., Singh, P., Bux, F., 2017. Heterotrophic cultivation of microalgae using aquaculture wastewater: a biorefinery concept for biomass production and nutrient remediation. *Ecol. Eng.* 99, 47–53.
- Haifeng, S., Furong, T., Yuanjian, X., 2016. Enhancement of biogas and methanization of citrus waste via biodegradation pretreatment and subsequent optimized fermentation. *Fuel* 181, 843–851.
- Harish, K., Avneesh, K.G., Ankur, G., Park, J.W., Sanjeev, M., et al., 2020. Facile synthesis of SiO<sub>2</sub>/CMC/Ag hybrids derived from waste biomass (Sugarcane bagasse) having special medical application. *J. Nanosci. Nanotechnol.* 20, 6413–6421.
- Heidari, A., Yoon, Y.J., Park, M.K., Park, W.T., Tsai Ming Lin, J., 2011. Ultrasensitive Dielectric Filled Lamé Mode Biomass Sensor. *2011 16th International Solid-State Sensors, Actuators And Microsystems Conference. TRANSDUCERS'11*, 2259–2262.
- Ibukunle, R.A., Ikubanni, P.P., Agboola, O.O., Ogunsemi, B.T., 2018. Development and performance evaluation of palm kernel nut cracker. *Leonardo J. Pract. Technol.* 33, 219–234.
- Ibukunle, R.A., Titiladunayo, I.F., Lukman, A.F., Dahunsi, S.O., Akeju, E.A., 2020. Municipal solid waste sampling, quantification and seasonal characterization for power evaluation: energy potential and statistical modelling. *Fuel* 277, 118122 (2020).
- IEA, I.E.A., 1998. *World Energy Outlook, 1998 Edition*.
- IEA, I.E.A., 2019. *Africa Energy Outlook*.
- Ikelle, I.I., Nworie, F.S., Ogah, A.O., Ilochi, N.O., 2017. Study on the combustion of bio-coal briquette blends of cassava stalk. *Chem. Search J.* 8 (2), 29–34.
- Ikubanni, P.P., Adeleke, A.A., Adediran, A.A., Agboola, O.O., 2018. Physico-mechanical properties of particleboards produced from locally sourced materials. *Int. J. Eng. Res. Afr.* 39, 112–118.
- Ikubanni, P.P., Oki, M., Adeleke, A.A., 2020a. A review of ceramic/bio-based hybrid reinforced aluminium matrix composites. *Cogent Eng.* 7 (1), 1727167.
- Ikubanni, P.P., Oki, M., Adeleke, A.A., Adediran, A.A., Adesina, O.S., 2020b. Influence of temperature on the chemical compositions and microstructural changes of ash formed from palm kernel shell. *Result Eng.* 8, 1–9.
- Ikubanni, P.P., Adeleke, A.A., Agboola, O.O., Adesina, O.S., Nnodim, C.T., Balogun, A.O., Okonkwo, C.J., Olawale, A.O., 2021. Characterization of some commercially available Nigerian coals as carbonaceous material for direct reduced iron production. *Mater. Today: Proc.* 44 (1), 2849–2854.
- Ikubanni, P.P., Oki, M., Adeleke, A.A., Omoniyi, P.O., 2021a. Synthesis, physico-mechanical and microstructural characterization of Al6063/SiC/PKSA hybrid reinforced composites. *Sci. Rep.* 11, 14845.
- Ikubanni, P.P., Oki, M., Adeleke, A.A., Agboola, O.O., 2021b. Optimization of the tribological properties of hybrid reinforced aluminium matrix composites using Taguchi and Grey's relational analysis. *Scient. African* 12, e00839.
- Ikumapayi, O.M., Akinlabi, E.T., 2018. Composition, characteristics and socioeconomic benefits of palm kernel shell exploitation-an overview. *J. Environ. Sci. Technol.* 11, 220–232.
- Jadhav, S., Aradhya, A., Kulkarni, S., Shinde, Y., Vaishampayan, V., 2019. Effect of hybrid ash reinforcement on microstructure of A356 alloy matrix composite. *AIP Conf. Proceed.* 2105, 20010–20011, 8.
- Jose, J., Chirsty, T.V., Eby, P.P., Feby, J.A., George, A.J., Joseph, J., Chandra, R.G., Benjie, N.M., 2018. Manufacture and characterization of a novel agro-waste based low cost metal matrix composite (MMC) by compo-casting. *Mater. Res. Express* 5 (6), 66530.
- Joseph, O.O., Babaremu, K.O., 2019. Agricultural waste as a reinforcement particulate for aluminium metal matrix composite (AMMCs): a review. *Fibers* 7 (4).
- Kaliyan, N., Vance Morey, R., 2009. Factors affecting strength and durability of densified biomass products. *Biomass Bioenergy* 33 (3), 337–359.
- Karekezi, S., 2002. Poverty and energy in Africa - a brief review. *Energy Pol.* 30 (11–12), 915–919.
- Khan, S., Siddique, R., Sajjad, W., Nabi, G., Hayat, K.M., Duan, P., Yao, L., 2017. Biodiesel production from algae to overcome the energy crisis. *HAYATI J. Biosci.* 24 (4), 163–167.
- Khatami, K., Perez-zabaleta, M., Owusu-agyeman, I., Cetecioglu, Z., 2020. Waste to bioplastics : how close are we to sustainable polyhydroxyalkanoates production ? Waste to bioplastics : how close are we to sustainable polyhydroxyalkanoates production ? *Waste Manag.* November.
- Kheybari, S., Rezaie, F.M., Najji, S.A., Najafi, F., 2019. Evaluation of energy production technologies from biomass using analytical hierarchy process: the case of Iran. *J. Clean. Prod.* 232, 257–265.
- Kopania, E., Wiśniewska-Wrona, M., Wietecha, J., 2014. Galacto glucomannans (GGMs) extracted from spruce sawdust for medical applications. *Fibres Text. East. Eur.* 22 (2), 29–34.
- Kulkarni, P.P., Siddeswarappa, B., Kumar, K.S.H., 2019. A survey on effect of agro waste ash as reinforcement on aluminium base metal matrix composites. *Open J. Compos. Mater.* 9 (3), 312–326.
- Kumar, B.P., Birru, A.K., 2017. Microstructure and mechanical properties of aluminium metal matrix composites with addition of bamboo leaf ash by stir casting method. *Trans. Non-Ferr. Metal Soc. China* 27, 2555–2572.
- Kumar, K.R., Pridhar, T., Balaji, V.S.S., 2019. Mechanical properties and characterization of zirconium oxide (ZrO<sub>2</sub>) and coconut shell ash (CSA) reinforced aluminium (Al 6082) matrix hybrid composite. *J. Alloys Compd.* 765, 171–179.
- Kumar, R., Strezov, V., Kan, T., Weldekidan, H., He, J., Jahan, S., 2019. Investigating the effect of mono- and bimetallic/zeolite catalysts on hydrocarbon production during bio-oil upgrading from ex situ pyrolysis of biomass. *Energy Fuels* 34 (1), 389–400.
- Kumar, H., Gehlaut, A.K., Gaur, A., Park, J.W., Maken, S., 2020a. Facile synthesis of SiO<sub>2</sub>/CMC/Ag hybrids derived from waste biomass (sugarcane bagasse) having special medical application. *J. Nanosci. Nanotechnol.* 20 (10), 6413–6421.
- Kumar, H., Gehlaut, A.K., Gaur, A., Park, J.W., Maken, S., 2020b. Development of zinc-loaded nanoparticle hydrogel made from sugarcane bagasse for special medical application. *J. Mater. Cycles Waste Manag.* 22 (6), 1723–1733.
- Lakshminathan, P., Prabu, B.D., 2016. Mechanical and tribological behaviour of aluminium Al6061-coconut shell ash composite using stir casting pellet method||. *J. Balkan Tribolog. Assoc.* 22, 4008–4018.
- Lasode, O.A., Abdulganiny, H., Balogun, A.O., Ohijeagbon, I.O., Adeleke, A.A., Ikubanni, P.P., Adewuyi, O.A., 2021. Physico-mechanical properties of composite tiles produced from granite dusts and municipal wastes. *Innov. Infrastruct. Solut.* 6 (2), 1–8.
- Le Roux, E., Chaouch, M., Diouf, P.N., Stevanovic, T., 2015. Impact of a pressurized hot water treatment on the quality of bio-oil produced from aspen. *Biomass Bioenergy* 81, 202–209.
- Lee, T., Othman, R., Yeoh, F.-Y., 2013. Development of photoluminescent glass derived from rice husk. *Biomass Bioenergy* 59, 380–392.
- Liu, H., Kumar, V., Jia, L., Sarsaiya, S., Kumar, D., Juneja, A., et al., 2021. Biopolymer poly-hydroxyalkanoates (PHA) production from apple industrial waste residues: a review. *Chemosphere* 131427.
- Madakson, P., Yawas, D., Apasi, A., 2012. Characterization of coconut shell ash for potential utilization in metal matrix composites for automotive applications. *Int. J. Eng. Sci. Technol.* 4, 1190–1198.
- Manzone, M., Gioelli, F., Balsari, P., 2017. Kiwi clear-cut: first evaluation of recovered biomass for energy production. *Energies* 10 (11), 1–12.
- Martins, L.O.S., Carneiro, R.A.F., Torres, E.A., Silva, M.S., Iacovidou, E., Fernandes, F.M., Freires, G.M., 2019. Supply chain management of biomass for energy generation: a critical analysis of main trends. *J. Agric. Sci.* 11 (13), 253–273.
- Massaro, M.M., Son, S.F., Groven, L.J., 2014. Mechanical, pyrolysis, and combustion characterization of briquetted coal fines with municipal solid waste plastic (MSW) binders. *Fuel* 115, 62–69.
- Mehmod, M.A., Ibrahim, M., Rashid, U., Nawaz, M., Ali, S., Hussain, A., Gull, M., 2017. Biomass production for bioenergy using marginal lands. *Sustain. Product. Consump.* 9, 3–21.
- Mohammed, I.Y., Abakar, Y.A., Kazi, F.K., Yusuf, S., 2017. Effects of pretreatments of Napier grass with deionized water, sulfuric acid and sodium hydroxide on pyrolysis oil characteristics. *Waste Biomass Valoriz.* 8, 755–773.
- Montalvo, S., Huilini, C., Ojeda, F., Castillo, A., Lillo, L., Guerrero, L., 2016. Microaerobic pretreatment of sewage sludge: effect of air flow rate, pretreatment time and temperature on the aerobic process and methane generation. *Int. Biodeterior. Biodegrad.* 110, 1–7.
- Morato, T., Vaezi, M., Kumar, A., 2019. Developing a framework to optimally locate biomass collection points to improve the biomass-based energy facilities locating procedure – a case study for Bolivia. *Renew. Sustain. Energy Rev.* 107, 183–199.

- Muraina, H.O., Odusote, J.K., Adeleke, A.A., 2017. Physical properties of biomass fuel briquette from oil palm residues. *J. Appl. Sci. Environ. Manag.* 21 (4), 777–782.
- Nagrockienė, D., Daugėla, A., 2018. Investigation into the properties of concrete modified with biomass combustion fly ash. *Construct. Build. Mater.* 174, 369–375.
- Naidu, A.L., Sudarshan, B., Krishna, K.H., 2013. Study on mechanical behavior of groundnut shell fiber reinforced polymer metal matrix composites. *Int. J. Eng. Res. Technol.* 2 (2), 1–6.
- Nnodim, C.T., El Bab, A.M.R.F., Ikua, B.W., Sila, D.N., 2019a. Estimation of the modulus of elasticity of mango for fruit sorting. *Int. J. Mech. Mechatron. Eng.* 19 (2), 1–10.
- Nnodim, C.T., El-Bab, A.M.R.F., Ikua, B.W., Sila, D.N., 2019b. Design and simulation of a tactile sensor for fruit ripeness detection. *Proc. World Cong. Eng. Comp. Sci.* 390–395. October 22–24, 2019, San Francisco, USA.
- Nnodim, C.T., Arowolo, M.O., Agboola, B.D., Ogundokun, R.O., Abiodun, M.K., 2021. Future trends in mechatronics. *IAES Int. J. Rob. Autom.* 10 (1), 24–31.
- Nwabue, F.I., Unah, U., Itumoh, E.J., 2017. Production and characterization of smokeless bio-coal briquettes incorporating plastic waste materials. *Environ. Technol. Innov.* 8, 233–245.
- Odusote, J.K., Adeleke, A.A., Lasode, O.A., Malathi, M., 2019. Thermal and compositional properties of treated *Tectona grandis*. *Biomass Convers. Bioref.* 9 (3), 511–519.
- Ohijeagbon, I.O., Adeleke, A.A., Mustapha, V.T., Olorunmaiye, J.A., Okokpujie, I.P., Ikubanni, P.P., 2020. Development and characterization of wood-polypropylene plastic-cement composite board. *Case Stud. Construct. Mater.* 13, e00365.
- Ohijeagbon, I.O., Bello-Ochende, M.U., Adeleke, A.A., Ikubanni, P.P., Samuel, A.A., Lasode, O.A., Atoyebi, O.D., 2021. Physico-mechanical properties of cement bonded ceiling board developed from teak and African locust bean tree wood residue. *Mater. Today: Proc.* 44, 2865–2873.
- Okolie, P.C., Nwadike, E.C., Chukwunke, J.L., Nnodim, C.T., 2017. The analysis of cigarette production using double exponential smoothing model. *Acad. J. Sci.* 7 (2), 293–308.
- Okolie, J.A., Nanda, S., Dalai, A.K., Kozinski, J.A., 2020. Chemistry and Specialty Industrial Applications of Lignocellulosic Biomass. *Waste and Biomass Valorization*, 0123456789.
- Oladele, I.O., Okoro, A.M., 2016. The effect of palm kernel shell ash on the mechanical properties of as-cast aluminium alloy matrix composites. *Leonardo J. Sci.* 28, 15–30.
- Oluwole, O.I., Okoro, A.M., 2016. Assessment of the impact of age-hardening on the mechanical properties of as-cast aluminium composites based on palm kernel shell ash. *Am. J. Mater. Sci. Technol.* 5 (1), 11–29.
- Orhadahwe, T.A., Ajide, O.O., Adeleke, A.A., Ikubanni, P.P., 2020. A review on primary synthesis and secondary treatment of aluminium matrix composites. *Arab J. Basic Appl. Sci.* 27 (1), 389–405.
- Panee, J., 2015. Potential medicinal application and toxicity evaluation of extracts from bamboo plants. *J. Med. Plants Res.* 9 (23), 681.
- Park, J.Y., Kim, J.K., Oh, C.H., Park, J.W., Kwon, E.E., 2019. Production of bio-oil from fast pyrolysis of biomass using a pilot-scale circulating fluidized bed reactor and its characterization. *J. Environ. Manag.* 234, 138–144.
- Patel, A.K., Pant, D., Banu, J.R., Rao, C.V., 2019. Recent developments in pretreatment technologies on lignocellulosic biomass: effect of key parameters, technological improvements, and challenges. *Bioresour. Technol.* 122724.
- Pinto, J.W., Sujaykumar, G., Sushiledra, R.M., 2016. Effect of heat treatment on mechanical and wear characterization of coconut shell ash and E-glass fiber reinforced aluminum hybrid composites. *Am. J. Mater. Sci.* 6 (4A), 15–19.
- Poornesh, M., Saldanha, J.X., Singh, J., Pinto, G.M., 2017. Effect of coconut shell ash and SiC particles on mechanical properties of aluminium based composites. *Am. J. Mater. Sci.* 7 (4), 112–115.
- Poudel, B.C., Sathre, R., Gustavsson, L., Bergh, J., Lundström, A., Hyvönen, R., 2011. Effects of climate change on biomass production and substitution in north-central Sweden. *Biomass Bioenergy* 35 (10), 4340–4355.
- Prasad, D.S., Krishna, A.R., 2010a. Fabrication and characterization of A356.2-rice husk ash composite using stir casting technique. *Int. J. Eng. Sci. Technol.* 2, 7603–7608.
- Prasad, S.D., Krishna, R.A., 2010b. Characterization and fabrication of rice husk ash-A356.2 composite using stir casting. *Int. J. Eng. Sci. Technol.* 2 (12), 7603–7608.
- Prasad, S.D., Krishna, R.A., 2012a. Production and mechanical properties of A356.2/RHA composites. *International Journal of Advanced Science and Technology* 33, 51–58.
- Prasad, S.D., Krishna, R.A., 2012b. Tribological properties of A356.2/RHA composites. *J. Mater. Sci. Technol.* 28 (4), 367–372.
- Prasad, D.S., Shoba, C., Ramanaiah, N., 2016. Investigations on mechanical properties of aluminium hybrid composites. *J. Mater. Res. Technol.* 3 (1), 79–85.
- Raghavan, N., Thangavel, S., Venugopal, G., 2017. A short review on preparation of graphene from waste and bioprecursors. *Appl. Mater. Today* 7, 246–254.
- Raida, K., Manel, H., Sami, S., 2015. Evaluation of ultrasonic, acid, thermo-alkaline and enzymatic pre-treatments on anaerobic digestion of *Ulva rigida* for biogas production. *Bioresour. Technol.* 187, 205–213.
- Raju, R.S.S., Panigrahi, M.K., Ganguly, R.I., Rao, G.S., 2019. Tribological behaviour of Al-1100-coconut shell ash (CSA) composite at elevated temperature. *Tribol. Int.* 129, 55–66.
- Rallabandi, S.R., Rao, G.S., 2019. Assessment of tribological performance of Al-coconut shell ash particulates-MMCs using grey-fuzzy approach. *J. Inst. Eng. (India): Ser. C* 100, 13–22.
- Ranade, S.S., Thiagarajan, P., 2015. Lemon grass. *Int. J. Pharmaceut. Sci. Rev. Res.* 35, 162–167.
- Rouches, E., Zhou, S., Steyer, J.P., Carrere, H., 2016. White-Rot Fungi pretreatment of lignocellulosic biomass for anaerobic digestion: impact of glucose supplementation. *Process Biochem.* 51 (11), 1784–1792.
- Saleh, A.M., 2015. Activation of granulated blast-furnace slag using lime rich sludge in presence and absence of rice husk ash. *Int. J. Technol. Explorat. Eng.* 5 (3), 43–51.
- Samsul, A., Othman, R., Jabarullah, N.H., 2020. Preparation and synthesis of synthetic graphite from biomass waste : a review. *Sys. Rev. Pharm.* 11 (2), 881–894.
- Saravanan, S.D., Senthilkumar, M., Shankar, S., 2013. Effect of particle size on tribological behavior of rice husk ash-reinforced aluminum alloy (AlSi10Mg) matrix composites. *Tribol. Trans.* 56, 1156–1167.
- Saravanan, S.D., Kumar, M.S., 2013. Effect of mechanical properties on rice husk ash reinforced aluminum alloy (AlSi10Mg) matrix composites. *Proc. Eng.* 64, 1505–1513.
- Sathre, R., Gustavsson, L., Bergh, J., 2010. Primary energy and greenhouse gas implications of increasing biomass production through forest fertilization. *Biomass Bioenergy* 34 (4), 572–581.
- Saxena, R.C.A., Adhikari, D.K., Goyal, H.B., 2009. Biomass-based energy fuel through biochemical routes : a review. *Renew. Sustain. Energy Rev.* 13, 167–178.
- Scatolino, M.V., Neto, L.F.C., Protásio, T.d.P., Carneiro, A.C.O., Andrade, C.R., Júnior, J.B., Mendes, L.M., 2018. Options for generation of sustainable energy: production of pellets based on combinations between lignocellulosic biomasses. *Waste Biomass Valoriz.* 9, 479–489.
- Schröder, P., Beckers, B., Daniels, S., Gnädinger, F., Maestri, E., Marmiroli, N., Mench, M., Millan, R., Obermeier, M.M., Oustriere, N., Persson, T., Poschenrieder, C., Rineau, F., Rutkowska, B., Schmid, T., Szulc, W., Witters, N., Sæbø, A., 2018. Intensify production, transform biomass to energy and novel goods and protect soils in Europe—a vision how to mobilize marginal lands. *Sci. Total Environ.* 616–617, 1101–1123.
- Scurlock, J.M.O., Dayton, D.C., Hames, B., 2008. Bamboo: an overlooked biomass resource? *Biomass Energy* 19, 229–244 (2000).
- Sherwood, J., 2020. The significance of biomass in a circular economy. *Bioresour. Technol.* 300, 122755.
- Si, C., 2019. The development of lignocellulosic biomass in medicinal applications. *Curr. Med. Chem.* 26 (14), 2408–2409.
- Singh, J., Suri, M.M., Verma, A., 2015. Affect of mechanical properties on groundnut shell ash reinforced Al6063. *Int. J. Technol. Res. Eng.* 2 (11), 2619–2623.
- Soltani, N., Bahrami, A., Pech-Cantul, M.I., González, L.A., 2014. Review on the physicochemical treatments of rice husk for production of advanced materials. *Chem. Eng. J.* 264, 899–935.
- Suleiman, I.Y., Salihu, S.A., Mohammed, T.A., 2018. Investigation of mechanical, microstructure, wear behaviours of Al-12%Si/reinforced with melon shell ash particulates. *Int. J. Adv. Manuf. Technol.* 97 (9–12), 4137–4144.
- Sundari, Papuanga, N., Jabid, A.W., 2019. Pre-design of bio-briquette production using Kenari shell. *IOP Conf. Ser. Earth Environ. Sci.* 276 (1).
- Takei, S., 2012. UV nanoimprint lithography of 70nm half pitch line pattern using plant-based resist material with lactulose derivative derived from biomass and medicinal drugs. *Micro & Nano Lett.* 7 (8), 822–825.
- Tan, R.R., Aviso, K.B., Barilea, I.U., Culaba, A.B., Cruz, J.B., 2012. A fuzzy multi-regional input-output optimization model for biomass production and trade under resource and footprint constraints. *Appl. Energy* 90 (1), 154–160.
- Tarves, P.C., Serapiglia, M.J., Mullen, C.A., Boateng, A.A., Volk, T.A., 2017. Effects of hot water extraction pretreatment on pyrolysis of shrub willow. *Biomass Bioenergy* 107, 299–304.
- Taulbee, D., Patil, D.P., Honaker, R.Q., Parekh, B.K., 2009. Briquetting of coal fines and sawdust part I: binder and briquetting-parameters evaluations. *Int. J. Coal Prep. Utiliz.* 29 (1), 1–22.
- Tile, J.M., Nyior, G.B., Sidi, M.S., 2018. Mechanical properties of Al-Mg-Si/Groundnut shell particulate composite produced by stir casting method. *Am. J. Eng. Res.* 7 (5), 247–252.
- Toklu, E., 2017. Biomass energy potential and utilization in Turkey. *Renew. Energy* 107, 235–244.
- Torquati, B., Marino, D., Venanzi, S., Porceddu, P.R., Chiorri, M., 2016. Using tree crop pruning residues for energy purposes: a spatial analysis and an evaluation of the economic and environmental sustainability. *Biomass Bioenergy* 95, 124–131.
- Tsapokos, P., Kougiyas, P.G., Vasileiou, S.A., Lyberatos, G., Angelidaki, I., 2017. Effect of micro-aeration and inoculum type on the biodegradation of lignocellulosic substrate. *Bioresour. Technol.* 225, 246–253.
- U.S. Energy Information Administration (EIA), 2020. International Energy Outlook 2020 (IEO2020) United States Milestones in Meeting Global Energy Consumption.
- Usman, A.M., Raji, A., Hassan, M.A., Waziri, N.H., 2014. A comparative study on the properties of Al-7%Si-Rice husk ash and Al-7%Si-Bagasse ash composites produced using stir casting. *Int. J. Eng. Sci.* 3 (8), 1–7.
- Varalakshmi, K., Kumar, K.C.K., Babu, P.R., Sastry, M.R.C., 2019. Characterization of Al 6061-coconut shell ash metal matrix composites using stir casting. *Int. J. Latest Eng. Sci.* 2 (3), 41–49.
- Vinod, B., R. S., Anandajothi, M., 2019. A novel approach for utilization of agro-industrial waste materials as reinforcement with Al-7Si-0.3Mg matrix hybrid composite on tribological behaviour. *SN Appl. Sci.* 62 (1), 1–15.
- Vo, L.T., Navard, P., 2016. Treatments of plant biomass for cementitious building materials—a review. *Construct. Build. Mater.* 121, 161–176.
- Wang, T., Zhai, Y., Zhu, Y., Li, C., Zeng, G., 2018. A review of the hydrothermal carbonization of biomass waste for hydrochar formation: process conditions, fundamentals, and physicochemical properties. *Renew. Sustain. Energy Rev.* 90, 223–247.
- World Bioenergy Association, 2019. Global Bioenergy Statistics 2019. World Bioenergy Association (WBA).
- Xu, X., Li, Z., Sun, Y., Jiang, E., Huang, L., 2018. High-quality fuel from the upgrading of heavy bio-oil by the combination of ultrasonic treatment and mutual solvent. *Energy Fuels* 32, 3477–3487.

- Yadav, S., Srivastava, A.K., Singh, R.S., 2015a. Selection and ranking of multifaceted criteria for the prioritization of most appropriate biomass energy sources for the production of renewable energy in Indian perspective using analytic hierarchy process. *Int. J. Eng. Res. Sci. Technol.* 2 (Special Issue), 89–98.
- Yadav, S., Srivastava, A.K., Singh, R.S., 2015b. Selection and ranking of multifaceted criteria for the prioritization of most appropriate conversion technology for biomass to biofuel in Indian perspective using analytic hierarchy process. *Int. J. Adv. Technol. Eng. Sci.* 3 (1), 869–881.
- Yu, I.K.M., Chen, H., Abeln, F., Auta, H., Fan, J., Vitaly, L., Clark, J.H., Parsons, S., Chuck, C.J., Luo, G., Tsang, D.C.W., Yu, I.K.M., Chen, H., Abeln, F., Auta, H., Fan, J., Vitaly, L., Clark, J.H., Parsons, S., Luo, G., 2020. Technology Chemicals from lignocellulosic biomass : a critical comparison between biochemical , microwave and thermochemical conversion methods Chemicals from lignocellulosic biomass : a critical comparison between biochemical , microwave and. *Crit. Rev. Environ.*
- Yunqin, L., Jiajin, L., Chao, Z., Dehan, W., Huanjia, L., 2017. Anaerobic digestion of pulp and paper mill sludge pretreated by microbial consortium OEM1 with simultaneous degradation of lignocellulose and chlorophenols. *Renew. Energy* 108, 108–115.
- Zareei, S.A., Ameri, F., Dorostkar, F., Ahmadi, M., 2017. Rice husk ash as a partial replacement of cement in high strength concrete containing micro silica: evaluating durability and mechanical properties. *Case Studies Constr. Mat.* 7, 73–81.
- Zhang, L., Liu, R., Yin, R., Mei, Y., Cai, J., 2014. Optimization of a mixed additive and its effect on physicochemical properties of bio-oil. *Chem. Eng. Technol.* 37, 1181–1190.
- Zhang, S., Dong, Q., Zhang, L., Xiong, Y., 2016. Effects of water washing and torrefaction on the pyrolysis behavior and kinetics of rice husk through TGA and Py-GC/MS. *Biores. Technol.* 199, 352–361.
- Zhang, S., Chen, T., Xiong, Y., Dong, Q., 2017. Effects of wet torrefaction on the physicochemical properties and pyrolysis product properties of rice husk. *Energy Convers. Manag.* 141, 403–409.
- Zhang, M., Yewe-Siang, L.S.W.M., Wu, H., 2018. Direct emulsification of crude glycerol and bio-oil without addition of surfactant via ultrasound and mechanical agitation. *Fuel* 227, 183–189.
- Zheng, W., Phoungthong, K., Lü, F., Shao, L.M., He, P.J., 2013. Evaluation of a classification method for biodegradable solid wastes using anaerobic degradation parameters. *Waste Manag.* 33 (12), 2632–2640.