



University of HUDDERSFIELD

University of Huddersfield Repository

Aldawi, Fouad, Longstaff, Andrew P., Fletcher, Simon, Mather, Peter and Myers, Alan

A high accuracy ultrasound distance measurement system using binary frequency shift-keyed signal and phase detection

Original Citation

Aldawi, Fouad, Longstaff, Andrew P., Fletcher, Simon, Mather, Peter and Myers, Alan (2007) A high accuracy ultrasound distance measurement system using binary frequency shift-keyed signal and phase detection. In: Proceedings of Computing and Engineering Annual Researchers' Conference 2007: CEARC'07. University of Huddersfield, Huddersfield, pp. 1-7.

This version is available at <http://eprints.hud.ac.uk/3789/>

The University Repository is a digital collection of the research output of the University, available on Open Access. Copyright and Moral Rights for the items on this site are retained by the individual author and/or other copyright owners. Users may access full items free of charge; copies of full text items generally can be reproduced, displayed or performed and given to third parties in any format or medium for personal research or study, educational or not-for-profit purposes without prior permission or charge, provided:

- The authors, title and full bibliographic details is credited in any copy;
- A hyperlink and/or URL is included for the original metadata page; and
- The content is not changed in any way.

For more information, including our policy and submission procedure, please contact the Repository Team at: E.mailbox@hud.ac.uk.

<http://eprints.hud.ac.uk/>

A high accuracy ultrasound distance measurement system using binary frequency shift-keyed signal and phase detection

F. J. Aldawi, A. P. Longstaff, S. Fletcher, P. Mather, A. Myers.
School of Computing and Engineering, University of Huddersfield.

Abstract

A highly accurate binary frequency shift-keyed ultrasonic distance measurement system for use in air is described. This paper presents an efficient algorithm which combines both the time-of-flight method and the phase-shift method. The method used will allow a larger range measurement than the phase-shift method and also result in higher accuracy compared with time-of-flight method. The simulation in air uses BFSK with the frequencies of 40 and 40.7 KHz. The system will give a resolution of 0.0231mm/° at different temperature and humidity. The main advantages of this system are high resolution, low cost narrow bandwidth requirement and ease of implementation.

Introduction

The techniques of distance measurement using ultrasound in air include the time-of-flight (TOF) Technique,¹⁻² signal-frequency continuous wave phase shift,³ two-frequency continuous wave method,⁴ combining methods of TOF and phase-shift,⁵ multifrequency continuous wave phase shifts,⁶⁻⁷ and a multifrequency AM-based ultrasound system.⁸ In the TOF method, the pulse propagates through the transmission medium and is reflected by a suitable reflector. The time taken for the pulse to propagate from transmitter to receiver is proportional to the reflectors range. In this case, system errors are primarily due to amplitude degradation of the received signal. The TOF method of range measurement is subject to high levels of error when used in an air medium, thus limiting its applications.

In order to obtain accurate distance estimations, a superior system choice is the phase data of a steady-state frequency received signal with reference to its transmitted signal. This is because the distance information is derived from the phase difference of a repeating signal which is sampled for a statistically significant number of wave periods. Thus, the random variations in phase shift (from turbulence, environmental noise, electronic noise, etc.) tend to cancel themselves out in an averaging process. Most applications of range measurement in air using ultrasound apply a phase shift analysis of single-frequency continuous-wave transmission.³⁻⁹ If the transmitter is energized with a continuous sinusoidal signal, the signal corresponding to the received acoustic wave can be written as $V_r(t) = A_r \sin(\omega t + \theta)$. Here A_r is the peak value of the received signal, ω is the resonant angular frequency of the transducer, and θ is the phase shift. The range or distance d can be determined by the phase shift θ of a signal frequency if the maximum range distance does not exceed a full wavelength; otherwise a phase ambiguity will occur.

The maximum achievable range for a transducer with a resonant frequency of 40 KHz is about 8.5 mm which is usually too short for most ranging application. Although this disadvantage can be improved by a multiple-frequency continuous wave technique,⁶ which calculates the target distance at ranges much greater than one wavelength, the range of measurement is still too short-only 1500mm.

Present an algorithm for range measurement, which combines both the pulse TOF method and the phase-shift method,⁵ and can obtain accurate distance measurement (better than 1mm). The technique is based on a particular signal processing method which determines the approximate TOF by computing the cross correlation between the envelope of the transmitted and received signals. The carrier phase shift between emission and reception is then computed in order to retain the final result. The accuracy of this computed phase shift is limited by the amplitude accuracy of the samples and the resolution of the analog to digital (A/D) converter and the refined range does not exceed a wavelength of the transmitted signals. Webster⁹ presents a method that is based upon the binary frequency shift keyed (BFSK) signal (with two frequencies of f_1 and f_2) followed by data acquisition and signal processing of phase shift digitized information from the received signal.⁹ The method can reduce many of the problems that arise when dealing with the non-ideal behavior of ultrasound transducers. The TOF is estimated by the time at which the transition between f_1 and f_2 occurs and is determined from the phase data, which are easily influenced by noise, and errors arise. This paper also uses a combined method to achieve more accurate distance measurements than previous methods¹⁰. The algorithm in this paper will measure the distance in different temperature and humidity

conditions with two independent parts. One part estimates the TOF, and the other part calculates the phase shift difference between the transmitted and received signal. The new method is based upon the transmission of a BFSK signal.⁹ After reception of the pulse, the TOF is computed by the time at which the change between each discrete frequency occurs and two phase shift between the transmission and reception signals are detected to enhance the accuracy of the time measurement. The algorithm in this paper is developed to calculate the distance, and the proposed range measurement system that can obtain accuracy and resolution which will be higher than previous methods.⁵⁻⁶⁻⁹⁻¹⁰

2. Method

2.1. Transmitter and receiver

The transmitted and received signals are shown in Fig. 1. The S_T is the transmission signal of a BFSK it has two frequencies f_1 and f_2 as shown in Fig. 1(a). T_r is the period of S_T . S_R is the received signal corresponding to the transmitted signal in Fig. 1(b).

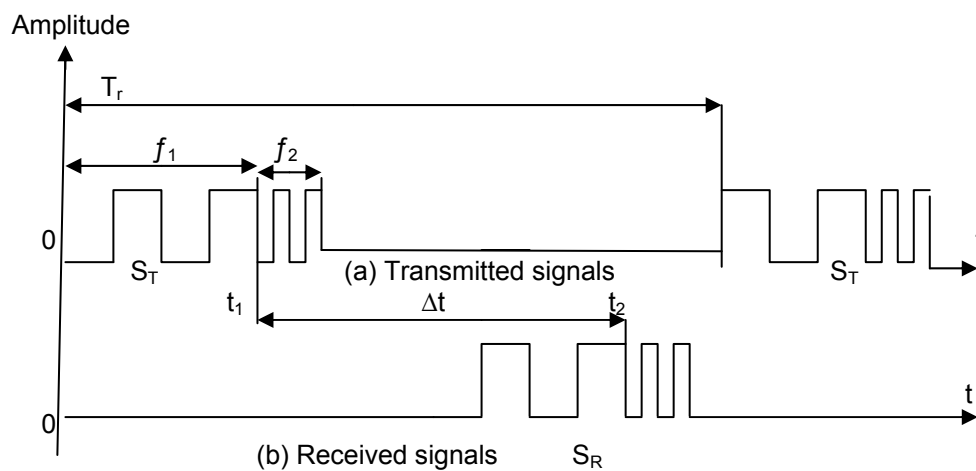

Fig. 1. Transmitted and received signals.

2.2. Signal processing of received signal

There are two steps to processing of the received signal.

1. TOF Calculation

In Fig. 1 the elapsed time Δt , which is the travel time of the signal from the transmitter to the receiver, can be calculated as $\Delta t = t_2 - t_1$ where t_1 is the time when transmitted signal changes frequency from f_1 to f_2 , and t_2 is the time when the corresponding received signal changes frequency from f_1 to f_2 . The distance between two transducers can be expressed as $d = c/\Delta t$, where c is the speed of sound.

2. Phase shift calculation

The detection of the phase shift is based on two frequency continuous wave method of ultrasound distance measurement. The phase shift of θ_1 and θ_2 can be detected by the received signals corresponding to the transmit signals. A continuous wave with frequency f_1 and f_2 are shown in Fig. 2. The phase shift θ_1 and θ_2 can be detected by the received signals corresponding to transmit signals.

The phase θ_1 can be written as $\theta_1 = 2\pi (t_2 - t_1) / T_1$, Where T_1 is the period of the received Signal of f_1 , also Phase θ_2 can be written as $\theta_2 = 2\pi (t_2 - t_1) / T_2$, Where T_2 is the period of the received signal of f_2 .

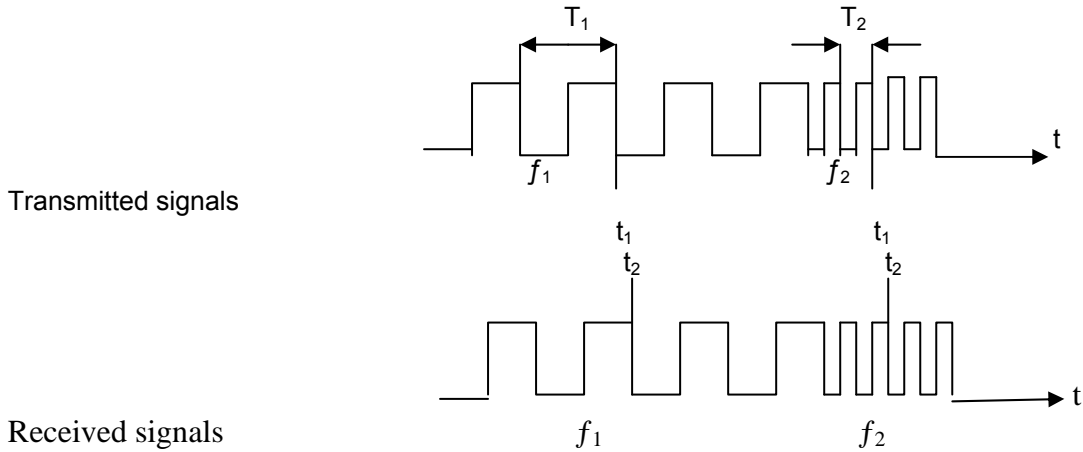

Fig. 2. Ultrasound of the phase shift θ_1 and θ_2

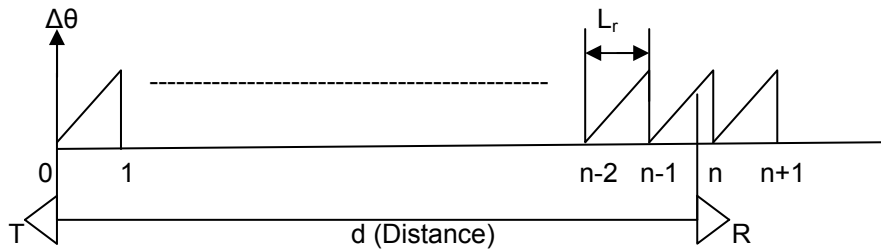

Fig. 3. Relation between $d = c \cdot \Delta t$ and $d = (n-1) \cdot L_r + (\Delta\theta/2\pi) \cdot L_r$.

Comparison of the two phase shifts allows calculation of target range shown in Fig. 3. The formulas can be written as

$$d = (n_1 + \theta_1/2\pi) \cdot \lambda_1 \dots \dots \dots (1)$$

$$\lambda_1 = c/f_1$$

$$d = (n_2 + \theta_2/2\pi) \cdot \lambda_2 \dots \dots \dots (2)$$

$$\lambda_2 = c/f_2$$

Here d is the distance between the receiver and the transmitter, λ_1, λ_2 are the wavelengths of the ultrasound, n_1, n_2 are integers, and θ_1, θ_2 are the phase shifts.

Due to the difference in frequencies, the phase shift can be deduced from Eqs. (1) and (2) as follows:

$$d = \Delta\theta/2\pi \cdot c/\Delta f \dots \dots \dots (3)$$

$$\Delta f = f_2 - f_1$$

The integers n_1 and n_2 in Eqs.(1) and (2) have only two possible values: $n_1 = n_2$ and $n_1 = n_2 + 1$. So the difference of the phase shift can be defined by following algorithm:

If $\theta_1 > \theta_2, \Delta\theta = \theta_1 - \theta_2$
 If $\theta_1 < \theta_2, \Delta\theta = \theta_1 + 2\pi - \theta_2$.

The range distance d can be uniquely determined by the difference of the phase shifts $\Delta\theta$ ($\Delta\theta = \theta_1 - \theta_2$) if the maximum ranging distance does not exceed one period of the difference frequency (Δf); otherwise a phase ambiguity will occur. The maximum achievable detecting range with Eq. (3) is about 500mm (taking $c=350$ m/s, $f_1=40$ KHz, $f_2=40.7$ KHz)

3. Distance calculation

The distance d can be expressed as $d = c \cdot \Delta t$ where Δt is TOF. The distance d is divided into regions $[(n-1)L_r, nL_r]$ ($n = 1, 2, 3, \dots$) in Fig. 3, L_r is the wavelength of Δf . The distance d can be expressed as $d = [(n-1) + \Delta\theta/2\pi] \cdot c/\Delta f$. The $n-1$ integer can be obtained by an integer operation $\text{Int}(\Delta t \cdot \Delta f)$. The distance can then be expressed as

$$d = [\text{Int}(\Delta t \cdot \Delta f) + \Delta\theta/2\pi] \cdot c/\Delta f \dots \dots \dots (4)$$

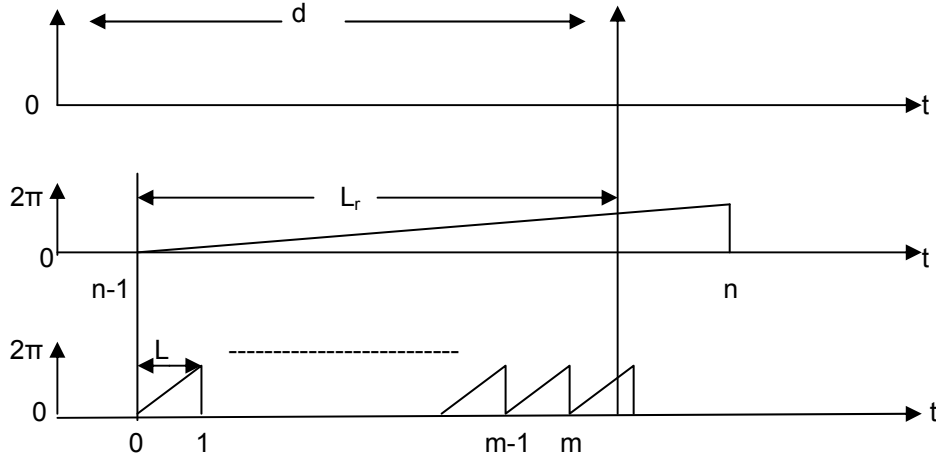

Fig. 4. Relation of d, L_r, L .

In order to increase the accuracy, the number n region can be divided by L , where $L = \lambda_1 = c/f_1$ in Fig. (4), and the fine scale measurement of $(\Delta\theta/2\pi) \cdot (c/\Delta f)$ can be replaced as $(m + \theta_1/2\pi) \cdot c/f_1$, where the integer m can be gotten by $\text{int}(\Delta\theta/2\pi \cdot f_1/\Delta f)$. The final estimate of distance can be expressed as

$$L = \text{Int}(\Delta t \cdot \Delta f) \cdot c/\Delta f + [\text{int}(\Delta\theta/2\pi \cdot f_1/\Delta f) + \theta_1/2\pi] \cdot c/f_1 \dots \dots \dots (5)$$

The θ_1 phase shift data is used to yield the highest level of resolution (determined by $(c/f_1) \cdot (1/360)$ mm/degree), 0.0243 mm/degree.

4. Environmental effects on the speed of sound

4.1. General Equations

The theoretical expression for the speed of sound c in an ideal gas is

$$c = \sqrt{\mu P/\rho} \dots \dots \dots (6)$$

Where P is the ambient pressure, ρ the gas density, and μ the ratio of the specific heat of gas at constant pressure to that at constant volume. The term μ is dependent upon the number of degrees of freedom of they gaseous molecule. The number of degrees of freedom depends upon the complexity of the molecule,

- $\mu = 1.67$ for monatomic molecules
- $\mu = 1.40$ for diatomic molecules
- $\mu = 1.33$ for triatomic molecules.

Since air is composed primarily of diatomic molecules, the speed of sound in air is

$$c = \sqrt{1.4P/\rho} \dots \dots \dots (7)$$

4.2. Temperature dependence

Substituting the equation of state of air of an ideal gas ($PV = RT$) and the definition of density ρ (mass per unit volume), equation (7) may be rewritten as

$$c = \sqrt{1.4RT/M} \dots \dots \dots (8)$$

Where R is the universal gas constant ($R = 8.315410 \text{ J. mol}^{-1} \cdot \text{K}^{-1}$), T the absolute temperature in Kelvins, and M the mean molecular weight of gas at sea level.

$$T = t + 273.15$$

Where t is the temperature in degrees Celsius.

$$c = 331.3 \sqrt{1 + t/273.15} \dots\dots\dots (9)$$

Graph of Eq. (9) shown in Fig. 5.

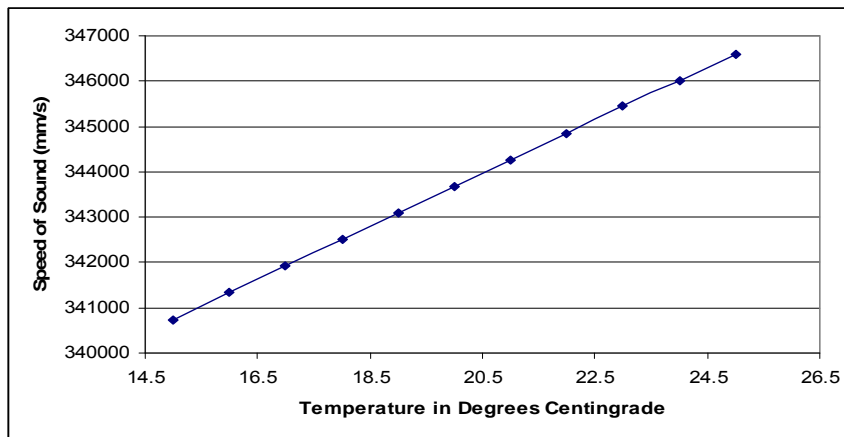

Fig. 5. Temperature versus speed of sound in dry air.

From Fig. 5. A change of air temperature by 1°C, for example from 20 to 21 °c, increases c by 585 mm/s. Even without any humidity information. Eq. (5). May be rewritten as

$$d = \text{Int}(\Delta t * \Delta f) * (331.3 \sqrt{1 + t/273.15}) / \Delta f + [\text{int}(\Delta \theta / 2\pi * f_1 / \Delta f) + \theta_1 / 2\pi]$$

$$(331.3 \sqrt{1 + t/273.15}) / f_1 \dots\dots\dots (10)$$

From Eq. (10) it is clear how the temperature affects measured distance. The graph of Eq. (10) is shown in Fig. 6.

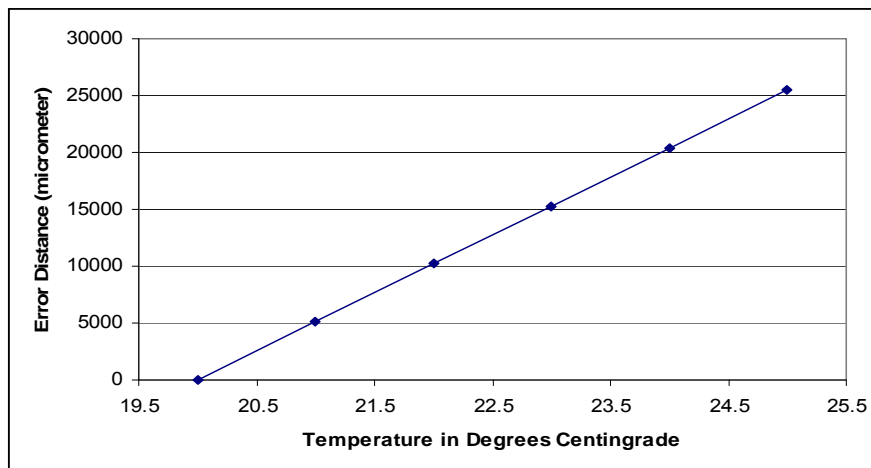

Fig. 6. Temperature versus Error Distance in dry air.

From Fig. 6 it is clear that an increase in t from 20 to 21°C caused an increase in distance by 5 mm.

4.3. Humidity dependence

All previous discussion assumed dry air. Attention turns now to the effects of moisture on the speed of sound. Moisture affects the density of air hence, the specific –heat ratio and molecular weight can now be rewritten to include the effects of moisture for air as

$$\mu_w = 7 + h/ 5 + h \dots\dots\dots (11)$$

$$M_w = 29 - 11h \dots\dots\dots (12)$$

Eqs. (11) And (12) modify the two terms from Eq. (8) affected by the addition of water vapor to air. Both are a function of the introduced water molecule fraction h . Relative humidity RH (expressed as a percentage) is defined such that

$$h = 0.01 * RH e(t) / P \dots\dots\dots(13)$$

Where P equals ambient pressure ($1.013 * 10^5$ Pa) and $e(t)$ is the vapor pressure of water at temperature t . To express the percentage increase in the speed of sound due to relative humidity all that remains is to take the ratio of the wet and dry speed, subtract 1, and multiply by 100. Since both wet and dry speed terms involve the same constant terms (R and T), their ratio will cause these to cancel, giving the increase in sound speed Δc (%)

$$\Delta c = (455.13 \sqrt{\mu_w / M_w}) - 100 \dots\dots\dots (14)$$

Eq. (14) is plotted in Fig. 7 as a function of relative humidity for six temperature values. Fig. 7 shows the percentage increase in sound speed due to relative humidity only.

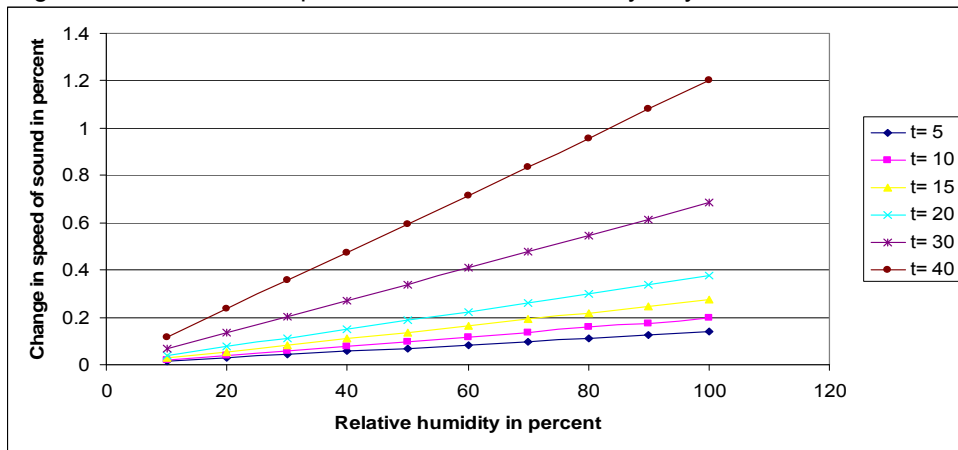

Fig. 7. Relative humidity versus percentage change in speed of sound as a function of temperature.

In Fig. 7. An increase in humidity from 0% to 100% increase °C by 1.2 m/s. Eq. (10) can now be rewritten include the effects of moisture also for as

$$d = \text{Int}(\Delta t * \Delta f) * \sqrt{(\mu_w * R * T / M_w)} / \Delta f + [\text{int}(\Delta \theta / 2\pi * f_1 / \Delta f) + \theta_1 / 2\pi] * \sqrt{(\mu_w * R * T / M_w)} / f_1 \dots\dots\dots (15)$$

Fig. 8. Show the results of Eq. (15) with fixed humidity and distance. A change of the relative humidity by 10 %, for example from 50 to 60 %, increases distance by 1.125 mm.

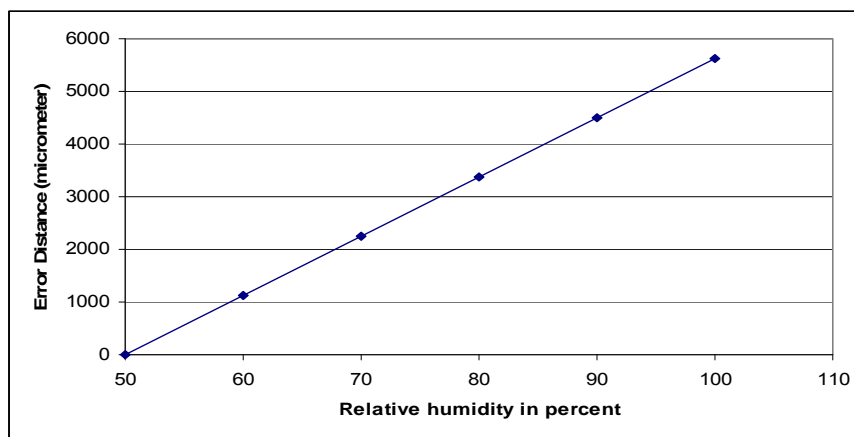

Fig. 8. Relative humidity versus Error distance at 20 °C

5. Conclusion

A new algorithm for using ultrasound to measure high accurate distance by considering change in temperature and humidity will successfully combines both the TOF method and the phase shift method. The technique is based on the BFSK transmitted signal. On reception of the pulse, approximate TOF is computed by the time at which the change between each discrete frequency occurs. Two phase shift between the transmission and reception signals will be computed in order to enhance the accuracy of the result. The system will consider the change in temperature after every 0.02°C to cancel any resulting measuring distance error and will also consider the change in humidity after every 0.1%.

References

- ¹D. Marioli, IEEE Trans Instrum. Meas. 41, 93 (1992).
- ²G. Tardajos, G. G. Gaitano, and F. R. M. de Espinosa, Rev. Sci. Instrum. 65, 2933 (1994).
- ³M. S. Young and Y. C. Li, Rev. Sci. Instrum. 63, 5435 (1992).
- ⁴J. S. Shoenwald and C. V. Smith, Jr, Proceedings of the IEEE Ultrasonic Symposium, P. 469, (1984).
- ⁵F. E. Gueuning, M. Varlan. C. E. Eugene, and P. Dupuis, IEEE Trans. Instrum. Meas. 46, 1236 (1997).
- ⁶C. F. Huang, M. S. Young, and Y. C. Li, Rev. Sci. Instrum. 70, 1452 (1999).
- ⁷T. Kimura, S. Wadaka, K. Misu, T. Nagatsuka, T. Tajime, and M. Koike, IEEE Ultrasonic Symposium, p. 737 (1995).
- ⁸M. Yang, S. L. Hill, and J. O. Gray, IEEE Trans. Instrum. Meas. 43, 861 (1994).
- ⁹D. Webster, IEEE Trans. Instrum. Meas. 43, 578 (1994).
- ¹⁰S. S. Huang, C. F. Huang, K. N. Huang and M. S. Young, A high accuracy ultrasound distance measurement system, 73, (2002).