

# THE WELD SEAM DETECTION METHOD BASED ON THE INFOCRNET MODEL

Received – Primljeno: 2023-11-14

Accepted – Prihvaćeno: 2023-12-28

Original Scientific Paper – Izvorni znanstveni rad

Weld seam detection is particularly crucial within industrial systems, as it promptly reflects the quality of product fabrication and performance, ensuring the final metallurgical product's quality while mitigating potential losses stemming from product quality issues. This paper proposed the InfoFPN Cross Refinement Network (InfoCRNet) for the weld seam detection, achieving an accuracy rate of 98,90% and F1 score of 98,85 %.

*Keywords:* metallurgical production, weld seam detection, InfoCRNet, network model method

## INTRODUCTION

Weld seam detection is vital for ensuring the integrity, reliability, safety, and usability of welded structures and products. While mechanized welding technology has reached a relatively mature stage, welding defects may still arise due to improper manual operation, unstable environmental conditions, and welding equipment issues. Accurate localization of weld seam is essential for assessing the quality of the welding process, thereby enhancing manufacturing productivity, expediting high-quality product production, and reducing labor costs. Traditional welding inspection methods rely on experienced professionals who visually and manually inspect welds, which is not only inefficient but also demands a significant workforce. Additionally, visual fatigue from extended work periods may compromise inspection accuracy. Thus, precise detection of the weld seam is imperative.

Weld seam detection methods can be categorized into two types: contact and non-contact methods. Contact methods involve using guide rods or guide wheels to determine the weld's position, while non-contact methods encompass those based on physical signals and machine vision. With the rapid advancement of deep learning methods based on feature extraction networks, contact methods may not adequately meet the demands of diverse welding scenarios. To improve the precise localization and detection of welding positions, this paper proposed a multi-level feature map-based model (InfoCRNet) for the welding inspection.

To assess the performance of the InfoCRNet model in welding inspection, we evaluate our deep learning approach on the LSWD (Large-scale Welding Defects) challenge dataset [1].

## RELATED WORK

Due to the complexity of welding processes, the uncertainty in welding environments, and variations in personnel expertise, accurate detection of welding positions during welding is paramount for improving product quality and increasing the yield of good-quality products. Currently, the development of deep learning technology is maturing, and deep learning has demonstrated superior performance in welding image detection compared to traditional machine learning methods. To achieve precise welding position detection, this paper propose a Weld Seam detection Network model with InfoFPN Cross Refinement Network (InfoCRNet).

To assess the performance of the InfoCRNet model in welding position detection, we conducted tests on a challenging dataset, the LSWD (Large-scale Welding Defects) dataset. With the rapid evolution of deep learning, the field of weld seam detection is transitioning from traditional methods to deep learning-based approaches. In 2016, Wang and colleagues [2] proposed a weld seam recognition algorithm based on subregion BP neural networks. In 2020, Li and his team [3] introduced a deep learning-based weld seam image recognition algorithm, utilizing an adaptive threshold-based approach for weld seam extraction. In the same year, Tian et al. [4] employed a bidirectional deviation search method based on stripe mapping images to determine mapping regions and used convolutional neural networks (CNN) for weld seam recognition. Researchers have found that detectors can place a series of anchor points on the original image, using convolutional neural networks to classify and regress anchor points to obtain candidate positions.

In order to accurately locate welding positions, reduce welding errors, and enhance product yield, we propose a Weld Seam detection Network model InfoCRNet with cross refinement block. It can be used to

J. P. Hui, G. Y. Lian, J. S. Wu, School of Computer Science and Software Engineering, University of Science and Technology Liaoning, China. Corresponding author: G. Y. Lian (lianguoyun@szpt.edu.cn)

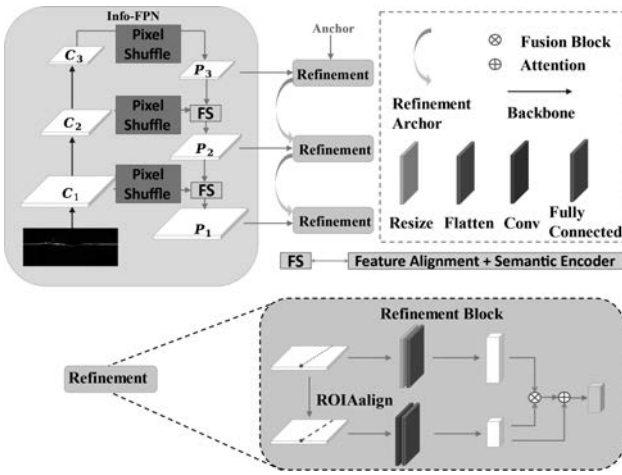

Figure 1 The structure of InfoCRNet

weld seam detection in metallurgical production’s welding processes.

### InfoCRNet MODEL

The InfoCRNet model, as illustrated in Figure 1, comprises two main components: the InfoFPN module and the Cross-Refinement module. The distinction between InfoFPN and the original FPN lies in InfoFPN’s ability to eliminate aliasing effects while fully preserving channel information in the feature pyramid. The model structure of InfoFPN is depicted in Figure 2.

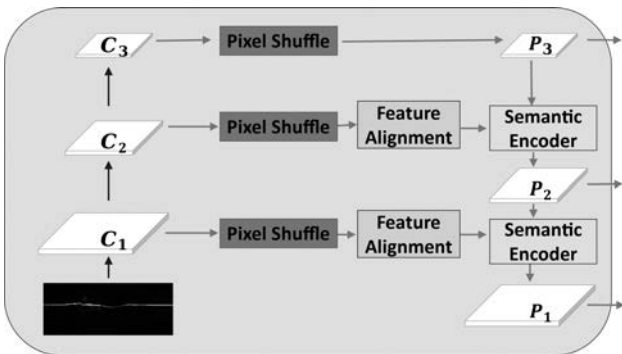

Figure 2 The structure of InfoFPN

$$L_i = \begin{cases} f^{4 \times 4} (f^{1 \times 1} (PS_{r=2}(C_i))) & i = 3 \\ f^{2 \times 2} (f^{1 \times 1} (PS_{r=2}(C_i))) & i = 1, 2 \end{cases} \quad (1)$$

$$y = PS_{r=2} (f^{1 \times 1} (L_{i+1})) \quad (2)$$

$$L'_{i+1} = y_{C_{i+1} \rightarrow 2} \otimes SoftMax(y_{1 \rightarrow c}) \quad (3)$$

$$\Delta'_{i+1} = f^{1 \times 1} (\sigma(BN(f^{3 \times 3} (cat(L_i, L'_{i+1})))) \quad (4)$$

$$L'_{i+1, off} = \sum_{h=1}^{H'_{i+1}} \sum_{w=1}^{W'_{i+1}} L'_{i+1, h'w'} \max(0, 1 - |h + \Delta^{1hw} - h'|) \max(0, 1 - |w + \Delta^{2hw} - w'|) \quad (5)$$

$$F_i = \begin{cases} S_i \oplus S_{i+1} & i = 2, 3, 4 \\ S_i & i = 5 \end{cases} \quad (6)$$

$L_i$  represents the feature map that has been enlarged through pixel shuffling and convolution operations, while  $y$  signifies the combination of upsampled feature maps. At this stage,  $L'_{i+1}$  denotes the low-resolution upsampled features, and  $\Delta'_{i+1}$  represents the offset mapping obtained after feature matching. Furthermore,  $L'_{i+1, off}$  is used to align the results using a spatial transformation function. Subsequently, the aligned feature maps are input into the Semantic Encoding Module (SEM), where the distribution of fused features in the frequency domain is standardized before feature fusion. Ultimately, through the feature fusion step, the optimized feature map  $F_i$  is obtained for use in the refinement block detection. The structure of the refinement block is shown in Figure 3.

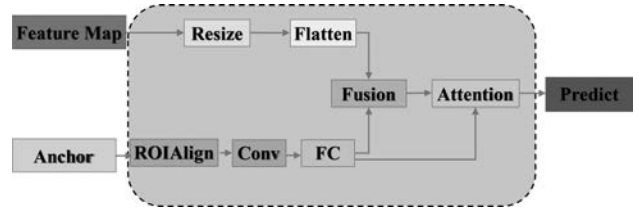

Figure 3 The structure of Refinement Block

$$W = f \left( \frac{X_p^T X_t}{\sqrt{C}} \right) \quad (7)$$

$$G = WX_t^T \quad (8)$$

The feature maps and predefined anchors are subjected to a series of refinement steps for model prediction. These anchors undergo a three-stage refinement process, culminating in the generation of prediction results. The feature maps undergo dimension and size adjustments, including resizing and flattening, to facilitate subsequent processing. After that, the anchors undergo bilinear interpolation and are then input into convolutional and fully connected layers, after that anchors map to the feature maps undergo an attention operation. After filtering, the anchor outputs the prediction result.  $W$  represents the feature maps where the anchors are integrated, and  $G$  represents the results after undergoing an attention mechanism. During the model train-

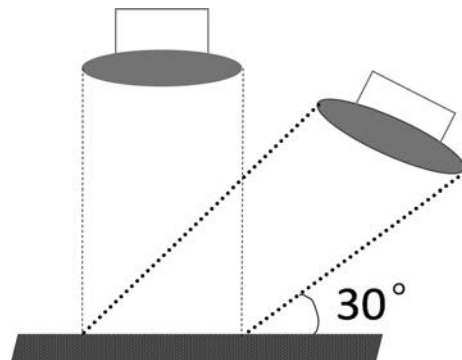
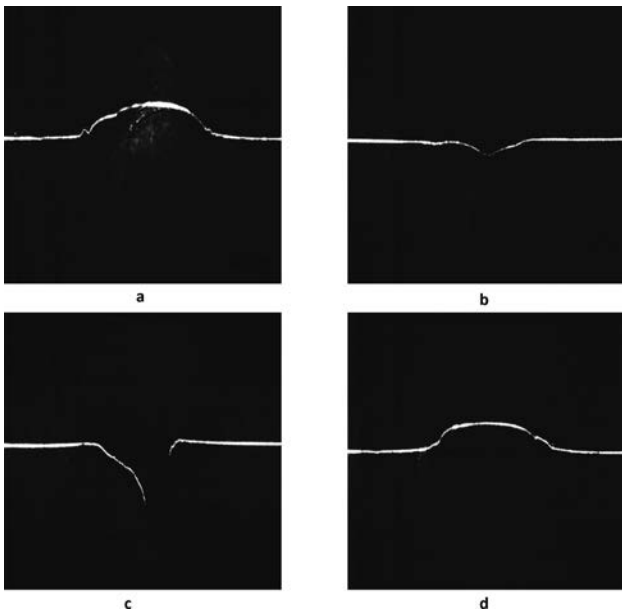

Figure 4 Weld Seam acquisition description

ing process, predictions are generated at each layer, while during the testing phase, only the final layer produces prediction results.

**EXPERIMENT AND ANALYSIS**

The dataset of weld seam structured light images was collected in two stages, as described in reference [1]. As shown in Figure 4, in the first stage, data was collected with line-structured light oriented vertically to the weld seam, and in the second stage, data was collected with line-structured light at a 30-degree angle to the weld seam. After processing and expansion, a total of 6 720 original weld seam structured light images were obtained.



**Figure 5** WELDSEAM sample

The laser’s measurement range was 50 millimeters, with a horizontal resolution of 0,06 millimeters and a height data resolution of 0,001 millimeters. The generated images had dimensions of 1 080 × 520 pixels. Figure 4 illustrates two-dimensional grayscale structured light images for four different categories of welding defects. Figure 5(a) displays images of spatter, Figure 5(b) shows images of a concave surface, Figure 5(c) presents images of pores, and Figure 5(d) depicts images conforming to the standard structured light pattern.

To reduce the impact of classification accuracy by randomness, each baseline model was run 10 independent experiments each, the models were written using the pytorch=1,8 framework, and all experiments were run on a RTX3 080 machine. The learning rate (lr) was set to 0,0001, and the optimizer was Adam. We use two loss, classification loss (cls loss) and corresponds loss (xylt loss). The batch training size was 64 and the epoch was set to 100. To prevent overfitting during training we use the Early Stopping method and end the training when the loss value of the validation set does not decrease for 10 consecutive times. In this paper, ACC and

F1 are chosen as the evaluation metric for InfoCRNet, ACC and F1 is mathematically defined as follows.

$$Acc = \frac{TP + TN}{TP + FP + FN + TN} \tag{9}$$

$$F1 = \frac{2 \times T_p^2}{(T_p + F_n)(T_p + F_p)} \tag{10}$$

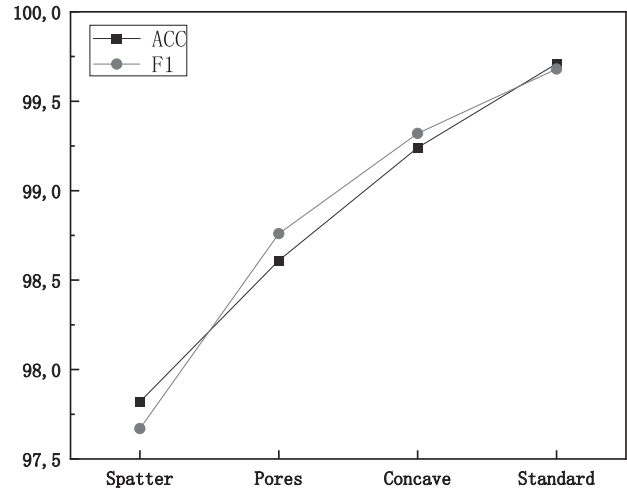

**Figure 6** Comparison of accuracy on the LSWD challenge dataset

In Figure 6, it have compared the accuracy of the InfoCRNet model across four detection categories in the challenging LSWD dataset. The model performs best under standard conditions, achieving a remarkable 99,68 % accuracy and a 99,71 % F1 score. However, in the case of spatter, its accuracy is relatively lower, with an accuracy of 97,67 % and an F1 score of 97,82 %. To ensure the completeness and robustness of our experimental data, we conducted three separate cross-validations and plotted detection accuracy graphs for comparative analysis. Overall, our designed model demonstrates an average accuracy of 98,90 % ±0.05 and F1 of 98,85 % ±0.05 across the four detection categories.

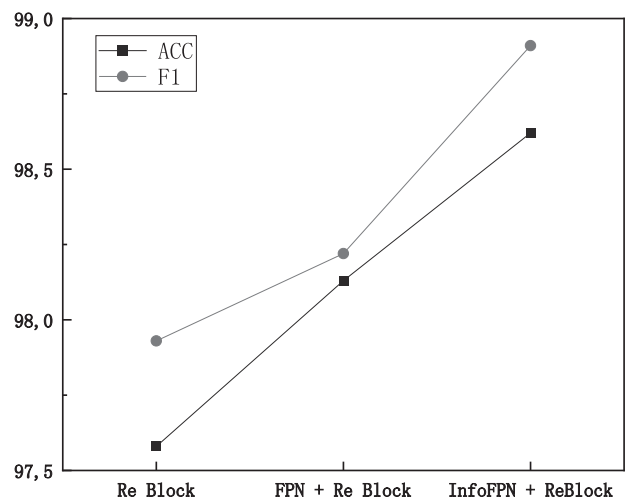

**Figure 7** Baseline model comparison

In Figure 7, we also compared models employing only the Refinement block, FPN + Refinement block, and InfoFPN + Refinement block. The results indicate that our proposed model (InfoCRNet) achieves the highest detection accuracy, successfully capturing and accurately representing the shape features of weld seams.

## CONCLUSION

This paper proposed a weld seam detection method based on the InfoCRNet network model, which effectively extracts shape data of weld seams. We conducted comparative experiments for four data categories and compared to two baseline models on the LSWD dataset. The results confirm that the InfoCRNet metallurgical weld seam detection exhibits outstanding detection accuracy.

## Acknowledgments

This work was supported by the Project of Educational Commission of Guangdong Province (Grant 2021ZDZX1090, 2023ZDZX1082), China University Innovation Fund (Grant 2021ITA02023), Shenzhen Po-

lytechnic Project (Grant 6021310017K, 6022310032K, 6021210065K), Opening Foundation of State Key Laboratory of Cognitive Intelligence, iFLYTEK (Grant COGOS-2023HE07), Science and Technology Innovation Project of University of Science and Technology Liaoning (Grant LKDYC202219).

## REFERENCES

- [1] Liu Y, Yuan K, Li T, et al. NDT Method for Line Laser Welding Based on Deep Learning and One-Dimensional Time-Series Data[J]. *Applied Sciences* 16 (2022), 12, 7837.
- [2] Wang S, Wang X. Existing weld seam recognition based on sub-region BP\_Adaboost algorithm[C]//2016 23rd International Conference on Mechatronics and Machine Vision in Practice (M2VIP). IEEE, 2016: 1-6.
- [3] Tian Y, Liu H, Li L, et al. Automatic identification of multi-type weld seam based on vision sensor with silhouette-map\*\*[J]. *IEEE Sensors Journal* 21(2020), 4, 5402-5412.
- [4] Li Y, Hu M, Wang T. Weld image recognition algorithm based on deep learning[J]. *International Journal of Pattern Recognition and Artificial Intelligence* 34, (2020), 08, 2052004.

**Note:** The responsible translators for English language is J. P. Hui – University of Science and Technology Liaoning, China