

**Manokhin Andriy**  
**Sergiyovich**

Senior researcher  
V. Bakul Institute for Superhard Materials\*  
National Academy of Sciences of  
Ukraine

**Klymenko Sergii**  
**Anatoliyovich**

Full professor\*

**Melniychuk Yuriy**  
**Oleksiyovich**

Senior researcher\*

**Klymenko Sergii**  
**Anatoliyovich**

Senior researcher\*

**Pasichnyi Oleg**  
**Olegovich**

Senior researcher\*

**Xin Li**

Student  
Harbin Institute of Technology,  
Center for Precision Engineering  
China

**Kamchatnaya-Stepanova**

**Kateryna Valeriivna**

Associate professor  
Kharkiv Polytechnic Institute National  
Technical University  
Ukraine

**Osipov Oleksandr**  
**Sergiyovich**

Senior researcher\*

# Intermittent Machining of Hardened Steels with Different Types of PcBN Cutting Tools

*The paper discusses the results of the experimental investigation of the performance of several grades of PcBN cutting composites in conditions of the interrupted machining of hardened steel. Both BH and BL types of PcBN indexable inserts with additions of  $\text{Si}_3\text{N}_4$ , TiC, and TiCN were tested, and cutting speed varied to assess the possibility of applying these cutting tools in different conditions. It has been shown that BL PcBN can be utilized for turning with shock loads in case of high cutting speed and low depth of cut (0,2 mm). While in the range of comparatively low cutting speeds BL cutting tools are actually inoperable, and because of microchipping of polycrystalline fragments and brittle destruction of the cutting edge, an increase of the cutting speed to 210 m/min changes wear pattern and formation of the wear land.*

*As well as this, measurement of the form and values of the cutting forces impulses revealed the effect of their peak growth by up to 40%. The danger of shock impulses was analyzed by FEM modeling, and it was demonstrated that during impacts, the maximal value of the third Principal stress exceeds the average level of compressive stresses during continuous cutting by 1.6 times, which can cause damage to the cutting tool. The data on the estimation of tool fracture probability depending on loading conditions are presented, and the possibility of reducing such probability is shown.*

**Keywords:** Interrupted machining, composite structure, PcBN cutting tools, wear

## 1. INTRODUCTION

The improvement of machining technologies for products made from modern structural materials is associated with an increase in productivity and a decrease in the cost of processing due to an intensification in cutting conditions, which, in turn, is due to the development of new cutting tools, such as polycrystalline superhard materials based on cubic boron nitride (PcBN) [1].

A challenging task in many industrial applications is the interrupted machining of difficult-to-process materials like hardened steel. This is often needed when facing gears or turning spline shafts [2,3]. PcBN composites are widely known as the most effective tool materials for specified types of applications [4, 5]. But even such efficient tools can face rapid deterioration if interrupted machining is conducted at conditions of

high-speed cutting [6, 7]. To solve this problem, regularities of application of different PcBN types are studied in a number of investigations [8–10]. The present research also aims to reveal peculiarities of interrupted machining of hardened steel with PcBN composites to address the issue of increase of efficiency during this type of processing.

## 2. LITERATURE REVIEW

According to the standard ISO 513-2012, composites based on cubic boron nitride are divided into different groups: – with a content of 40–65% (here in after vol.%) cBN in the matrix based on ceramic compounds TiC, TiCN, etc. (BL group); – with a content of 70–90% cBN mainly in a metal matrix based on Co, Ni, and Al (BH group); each type has its own assignment and optimal conditions for application.

An overview of the research of the wide range of PcBN cutting tools application in different conditions [3–5] of machining has shown that the tool with composites of BH group is better suited for work in the conditions of interrupted cutting, and with composites of group BL – for continuous turning. It was estimated that the tool with

Received: May 2023, Accepted: August 2023

Correspondence to: Prof. Sergii Klymenko, V. Bakul Institute for Superhard Materials, National Academy of Science of Ukraine, Kyiv, Ukraine.

E-mail: [atmu@meta.ua](mailto:atmu@meta.ua)

doi: 10.5937/fme2304504S

© Faculty of Mechanical Engineering, Belgrade. All rights reserved

FME Transactions (2023) 51, 504-511 504

materials of group BL had increased wear on the clearance face during heavy intermittent cutting. In contrast, tools with materials of group BH are less sensitive to dynamic loads but wear faster at high cutting speeds [3, 4]. Unlike the previous works, the authors of [14] demonstrate effective hard-interrupted high-speed machining technology. Also, it should be noted that PcBN tools are far more effective in these conditions in comparison with ceramics inserts [15].

To compare the performance of tools equipped with composites of groups BH and BL, in [4], studies on the turning of hardened steel using a water-oil cooling mixture (6% oil) have been performed. The depth of cut and feed were 0.2 mm and 0.3 mm/rev, respectively. The 200 m/min cutting speed was the same for all tools. A number of composites of groups BH and BL with a ceramic matrix with compounds TiN, TiC, Ti(C, N), (Al, Co), TiN, Al, and others were investigated. The grain size of the cBN component in the composite structure was 2–8  $\mu\text{m}$ . The main conclusion drawn from the results of comparative tests - tools equipped with composites of group BL (with low content of cBN) shows much longer tool life on finishing operations compared to the tools equipped with composites of group BH.

A significant increase in the wear resistance of the tool with a decrease in the particle size of cBN in the composites of the BL group (60 vol.% CBN) was reported in Chou Y., Evans C. J. [8]. Thus, the use of submicron cBN powders with a particle size of 0.5  $\mu\text{m}$  instead of a micron (1–3  $\mu\text{m}$ ) allows almost to halve the amount of wear of the cutting edge when processing tool steel.

In [10–12], the mechanism of wear and the reasons for the behavior of the tool with materials of groups BL and BH under different cutting conditions were studied. Cutting tools with composites were used: 50% cBN in TiC bond, 65% cBN in TiCN bond, and 90% cBN in Co-Ni bond. It is established that in the machining of AISI 4340 (52 HRC) tool, wear occurs as a result of chemical interaction that is thermally activated at the contact areas - the higher the volume content of BN in the composite, the greater the rate of wear in continuous turning, especially at high cutting speeds. When treated with shock load, the intensity of thermally caused wear of grains with BN decreases, and the constituent bonds in the composite wear out at high speed. In such conditions, the tool equipped with a composite with 90% of BN has the greatest working capacity.

Apart from chemical interaction affecting the wear of PcBN composites, brittle fracture of the cutting tool is one of the major reasons leading to its failure. Experiments in [13] demonstrated the BH PcBN cutting tool edge chipping while bearing steel milling, characterized by interrupted cutting mode. Experimental results [14] also show that failure types of PCBN tools at the low range of milling velocities include chipping and flank wear, and the failure modes at high speed are flank wear, surface spalling of the rake face, and fatigue failure. To tackle the problem of cutting tool failure, a

new PCBN can be developed. Namely, very fine and homogeneous microstructure increases the toughness of composites and provides a reliable tool life for heavy interrupted cutting [15].

Obviously, the extreme loads in interrupted machining make the task of composite materials' mechanical properties improvement extremely challenging [16, 17].

In a number of publications [18–23], it was shown that this aim could also be achieved by adding whisker components, which increase the bending strength and fracture toughness of composites. For example, in [19], hBN phases were successfully fabricated via the high-pressure sintering of a mixture of  $\text{SiC}_w$  and cBN nanopowders. Nanocomposites with 25 wt.%  $\text{SiC}_w$  exhibited optimal comprehensive mechanical properties with Vickers hardness of 36.5 GPa, fracture toughness of 6.2  $\text{MPa}\cdot\text{m}^{0.5}$ , and flexural strength of 687.4 MPa. At the same time, [20] paper reports on an investigation of PCBN materials sintered with varying cBN content when using nitride-based NbN binder and  $\text{Al}_2\text{O}_3$  or  $\text{Si}_3\text{N}_4$  additives in power or whisker form. The best reinforcement for cBN-based material is  $\text{Al}_2\text{O}_3$  whiskers due to the higher chemical stability of such composites in high-speed applications compared to other types of components.

Authors of [21] admit that after adding 10 vol.%  $\text{SiC}_w$  to the content of a cBN- $\text{Si}_3\text{N}_4$  composite, the interrupted turning of hardened steel results in a flank wear reduction of up to 20%. Apart from whisker doping, another component can also contribute to enhancing the cutting tools' properties [24]. For instance, the results of [25] show that the presence of  $\text{TiB}_2$  nanoparticles uniformly distributed in the interface inhibits crack propagation and increases mechanical properties: cBN composites incorporating 6 wt%  $\text{TiB}_2$  nanoparticles exhibited bending strength of 731 MPa, hardness of 49.5 GPa, and fracture toughness of 7.4  $\text{MPa}\cdot\text{m}^{0.5}$ .

The authors [26] have shown that the serviceability of a friction pair can be effectively controlled by creating roughness on the surface of its elements and in the surface layer of the stress state that meets the conditions of operational loading. Such an approach can be used in the case of considering such a specific friction pair as the system "front surface of the tool-chip" and "rear surface of the tool-workpiece".

Taking into account the above, it is possible to suggest several ways to increase the efficiency of processing with PcBN tools: – the first is related to the targeted change in the chemical composition of PcBN throughout the composite; – the second is the optimization of conditions of cutting tool application at processing with shock loading; - the third is due to the possibility of reducing contact loads on the tool by preparing its working surfaces. This increases the interrupted processing efficiency while ensuring the cutting tool's strength and high stability.

Such studies are particularly interesting to consider using tools equipped with BL PcBN in intermittent cutting applications.

**Table 1 - The composition and hardness of PcBN**

№	Content, vol. %					Hardness, HV <sub>10</sub> , GPa
	cBN	Si <sub>3</sub> N <sub>4</sub>	TiC	TiCN	Al	
Type 1	60	–	35	–	5	28.3 ± 1.2
Type 2	90	–	–	7	3	34.3 ± 1.9
Borsinit	96.4	3.6	–	–	–	36.2 ± 2.6

**3. RESEARCH METHODOLOGY**

In this research, the performance of PcBN tools was studied. The assessment of the effectiveness of composites was carried out in terms of their workability in conditions of interrupted cutting of hardened steel workpieces. The estimation of the cutting forces characterized the peculiarities of the machining process. As well as this, the wear morphology of PcBN tools was investigated.

Composites of group BL – 60%cBN-35%TiC-5%Al and group BH – 90%cBN-7%TiCN-3%Al were developed and manufactured for research of high-speed processing of hardened steels, the hardness of which is given in Table 1. For comparison, it was used PcBN borsinite – a composite of the BH group.

These tool materials are characterized by a structure and chemical composition optimized based on the requirement to improve mechanical properties. As can be seen in the SEM images, the main feature of the structures of the composites is different amounts of ceramic additions (light inclusions in Fig. 1 a, b) and grain size of cBN and ceramic phases. While at Type 1 and Type 2 composites crosssections, the grain boundaries and TiC and TiCN inclusions can be easily detected, the Borsinit material has a tight and smooth intergranular structure (fig. 1 c).

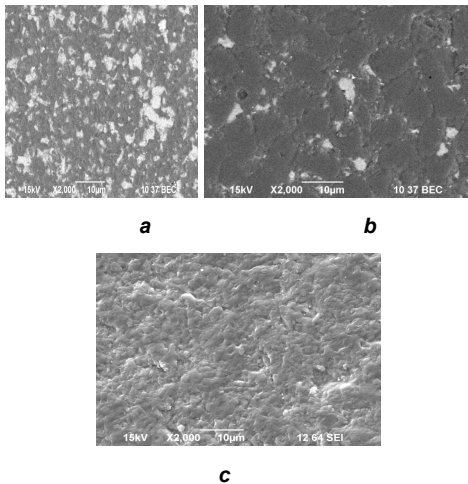

**Figure 1 – SEM images of structures: a – Type 1, b – Type 2, c - Borsinit**

The cutting forces were measured by a UDM-600 dynamometer with an ADA-1406 ADC (fig.2, a). The data acquisition frequency for each of the three channels was 100 kHz, which made it possible to record shock pulses under conditions of interrupted cutting of workpieces with grooves in a wide range of rotational speeds. The length of the section of the workpiece on which processing was carried out is 75 mm. The workpiece geometries are machined from a single batch

of ShKh-15 (analog of AISI 52100 steel) hardened to HRC 60-62. Six longitudinal grooves (10 mm wide and 10 mm deep) were made on the workpieces to ensure the presence of shock loads in machining.

In this work, in the study of hardened steels turning TRDNN 2525M07 tool holder was used with mechanical fastening of cutting inserts RNMN 070300T. Chamfer land width,  $b_g = 0.2$  mm angle of chamfer,  $g_f = 20^\circ$ . Rake angle of tool  $\gamma = -10^\circ$ , clearance angle  $\alpha = 10^\circ$ . The condition of the tool's cutting edge after operation was assessed by images taken with a microscope (magnification x100). The figure shows the images of the cutting edges of the tools obtained for working conditions with different modes and with different total cutting times.

Cutting conditions: cutting speed,  $v = 120$  m/min, 210 m/min, depth of cut,  $t = 0.2$  mm, 0.4 mm, feed rate,  $f = 0.1$  mm/rev.

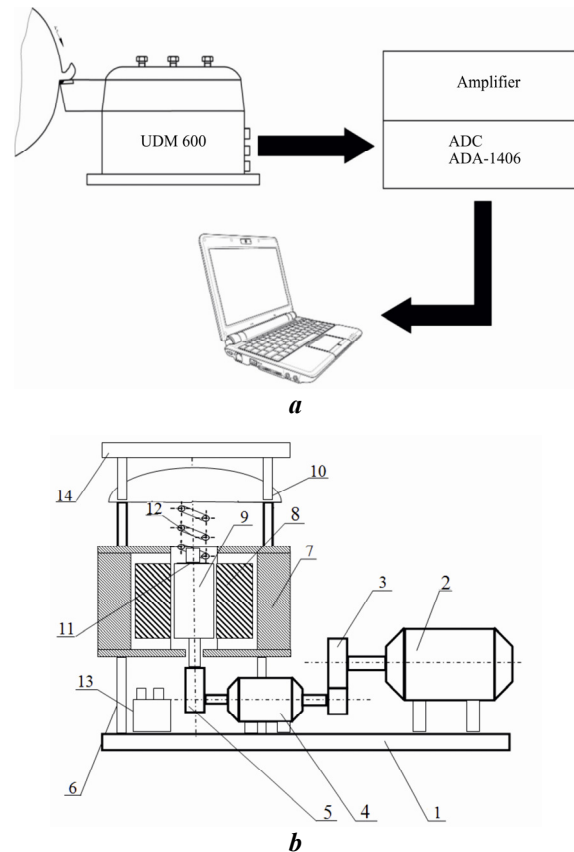

**Figure 2 – SEM images of structures: a – scheme of research to determine the components of cutting forces; b – schematic diagram of the vibration-magnetic-abrasive blasting plant (1 – frame, 2 – electric motor, 3 – gearbox, 4 – bearing unit, 5 – eccentric, 6 – rack, 7 – housing, 8 – stator, 9 – working chamber, 10 – cap, 11 – cover, 12 – spring, 13 – input automatic machine, 14 – fan)**

The finishing treatment (surface modification) of PcBN cutting inserts was performed by vibro-magnetic-

abrasive machining, which is based on the removal of material from the surfaces of the inserts during their reciprocating movement through a columnar medium formed by abrasive particles under the influence of a magnetic field (fig. 2, *b*) [27]. As the basis of the working medium, we used ferromagnetic powder FERROMAP 200/100 with the addition of diamond powder ASM 28/20.

The characteristics of the working surfaces of PcBN plates are regulated by changing the vibration frequency and characteristics of the electromagnetic field. As a result of the vibration-magnetic-abrasive treatment, a 30 mm radius of the cutting edge was formed on the cutting inserts, and the roughness of the working surfaces was  $Ra$  0.04.

#### 4. RESULTS

Analysis of experimental results shows that in the range of comparatively low cutting speeds ( $v = 120$  m/min.) BL (Type 1) composites and BH (Type 2) are actually inoperable and already at a depth of cut  $t = 0.2$  mm, there is microchipping of polycrystalline fragments, which with an increase of cutting depth to 0.4 mm leads to brittle destruction (breakage) of the cutting edge on the contact area of the tool. Microchipping and breakage are observed at the initial processing stage, in the first 20 sec of the cutting process (fig. 3, *b, c, e, f*).

An increase in cutting speed to a value of 170 m/min is characterized by the stable performance of new modifications of polycrystals (Type 1 and Type 2) at a small load with cutting depth  $t = 0.2$  (Fig. 3, *h, i*). In contrast, for a larger value of depth of cut ( $t = 0.4$  mm), the destruction of the cutting edge of the tool is still observed with the loss of its workability (fig. 3, *k, l*).

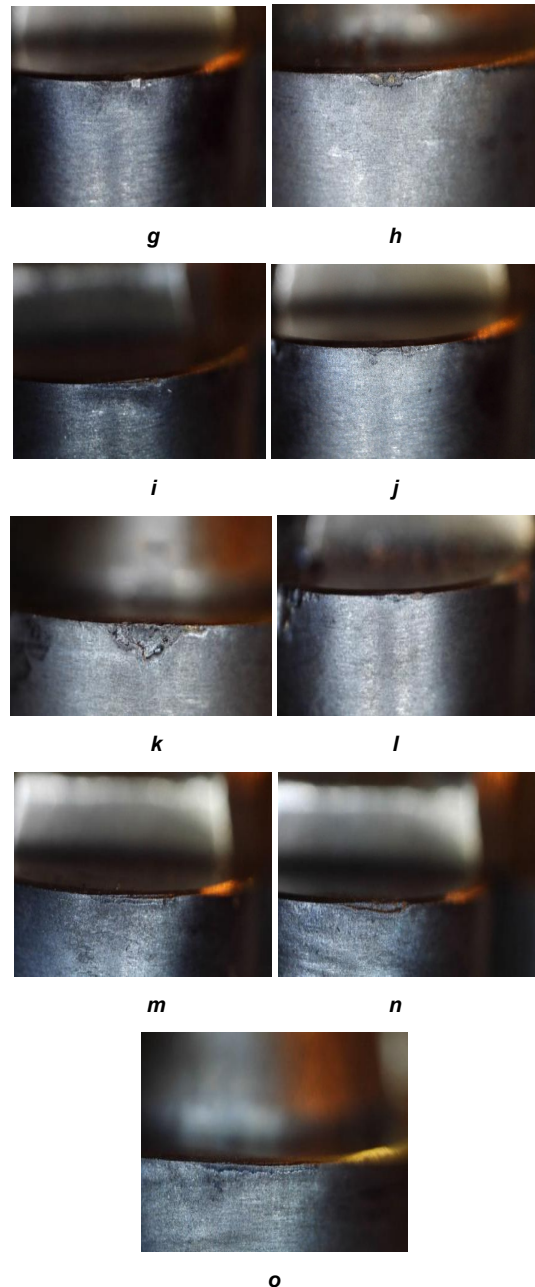
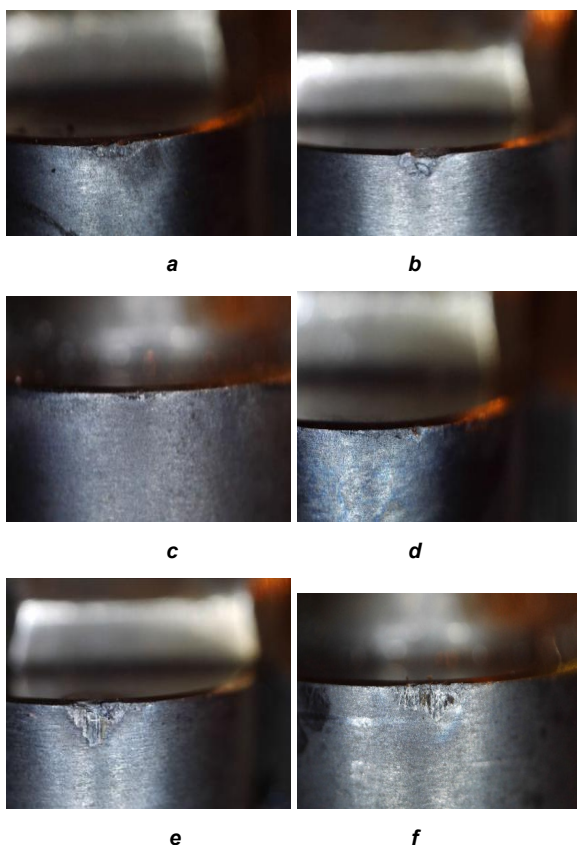

Figure 3 – Morphology of the cutting tools wear in interrupted cutting ( $f = 0,1$  mm/rev) [4]: *a, b, c* –  $t = 0.2$  mm;  $v = 100$  m/min (*a* – Borsinit,  $\tau = 540$  s; *b* – Type 1,  $\tau = 20$  s; *c* – Type 2,  $\tau = 20$  s); *d, e, f* –  $t = 0.4$  mm;  $v = 100$  m/min (*d* – Borsinit,  $\tau = 400$  s; *e* – Type 1,  $\tau = 20$  s; *f* – Type 2,  $\tau = 20$  s); *g, h, i* –  $t = 0.2$  mm;  $v = 170$  m/min (*g* – Borsinit,  $\tau = 450$  s; *h* – Type 1,  $\tau = 540$  s; *i* – Type 2,  $\tau = 150$  s); *j, k, l* –  $t = 0.4$  mm;  $v = 170$  m/min (*j* – Borsinit,  $\tau = 300$  s; *k* – Type 1,  $\tau = 150$  sec; *l* – Type 2,  $\tau = 150$  s); *m, n, o* –  $t = 0.4$  mm;  $v = 210$  m/min (*m* – Borsinit,  $\tau = 480$  s; *n* – Type 1,  $\tau = 480$  s; *o* – Type 2,  $\tau = 480$  s)

In the entire range of noted cutting depths and cutting speeds, the Borsinit composite retains its performance in the presence of individual micro-chipping areas on the cutting edge, which nevertheless retains straightness (fig. 3, *a, d, g, j, m*). On the clearance face of the tools, the formation of a wear chamfer is observed. Measurement of  $VB$  values of tested composites after 480 s of turning with a high cutting speed of 210 m/min shows that for Type 1, Type 2, and Borsinit, this parameter is equal to 0.2, 0.16, and 0.15 mm correspondently. At the same, it should be admitted that in the



case of continuous machining with all other cutting modes being equal, according to our experimental data, after the specified cutting length, the width of the wear land on BH-type of composites is significantly higher, and for Borsinit is equal to 0.25 mm.

The high-speed machining experiments showed that even at a speed of 210 m/min, the use of the studied tools is still possible. Fig. 3, *m*, *n*, *o* shows pictures of cutting inserts made of PcBN Borsinit and with a ceramic matrix containing 35% TiC and 5% Al<sub>2</sub>O<sub>3</sub> (Type 1). For Borsinit (fig. 3, *m*), more intense wear on the rake face and crater formations with «lowering» of the cutting edge is inherent. The same effect is also observed for a BL-type tool with a TiC content of 35% (fig. 3, *n*), which in this case is directly related not to crater formation, but to the lower strength of the composite compared to Borsinit.

As for flank wear land width, it should be admitted that VB width of PcBN Type 2 (fig. 3, *o*) is almost the same as for Borsinit (fig. 3, *m*), while the cutting edge remains straight due to the less intensity of the crater formation on the rake face of the tool with 90% cBN and 7% TiCN. According to the graph in Fig. 3, *n*, the highest wear intensity demonstrates composite Type 1 with 60% of cBN.

Somewhat unexpected is the fact of comparatively low wear of Borsinit demonstrated at  $v = 170$  m/min and  $v = 210$  m/min. Usually, for this type of composite, which belongs to the BH type of polycrystals, at high (more than 150 m/min) cutting speed, the rapid growth of the wear land width on the clearance surface of the tool is inherent. These results demonstrate that the wear of BH-type inserts under interrupted cutting conditions significantly differs from the wear patterns of such tools during continuous cutting.

Examples of the diagrams of the components of the cutting force impulses measured in interrupted machining with a shock load using a sharp Borsinit cutting tool are shown in Fig. 4.

Each impulse corresponds to the period when the cutting tool is in contact with the processed material of the workpiece with gaps. The graphs also allow us to estimate the magnitude of the dynamic effect, which is manifested in the peak growth by up to 40% of the values of the components  $P_z$  (cutting force) and  $P_y$  (thrust force), which is observed at the moments of penetration of the cutting tool in the processed material. Increasing in cutting speed up to 210 m/min promotes a decrease in the values of cutting force components (Fig. 4, *b*, *d*), which corresponds to the traditional concepts of cutting theory [28] and is associated with changes in the mechanical properties of the machined material under the effect of temperature in the cutting zone.

The cutting force's peak growth phenomenon should be considered one of the main dangerous effects of destroying the cutting tool composites. Simulation of intermittent processing at  $v = 100$  m/min,  $t = 0.4$  mm,  $f = 0.1$  mm/rev (corresponds to an undeformed chip thickness of 30  $\mu$ m) by the FE method (Fig. 5) shows that at the moment of entry of the cutting edge into the processed surface the highest value of the 3<sup>rd</sup> Principal Stress in PcBN reaches -2.5 GPa. That peak at 0.0004 s is when the tool is immersed in the workpiece for the second time.

That value exceeds the average level of compressive stresses during cutting by 1.6 times. Although the nominal value of the compressive strength of PcBN is higher (for Borsinit, for example, it equals 3,10 with a standard deviation of 0,28 GPa), due to the variance of the properties of the composite, the probability of their destruction under these conditions is quite high.

The danger of shock impulses was analyzed by FEM modeling, and it was demonstrated that during impacts, the maximal value of the third Principal stress exceeds the average level of compressive stresses during continuous cutting by 1.6 times.

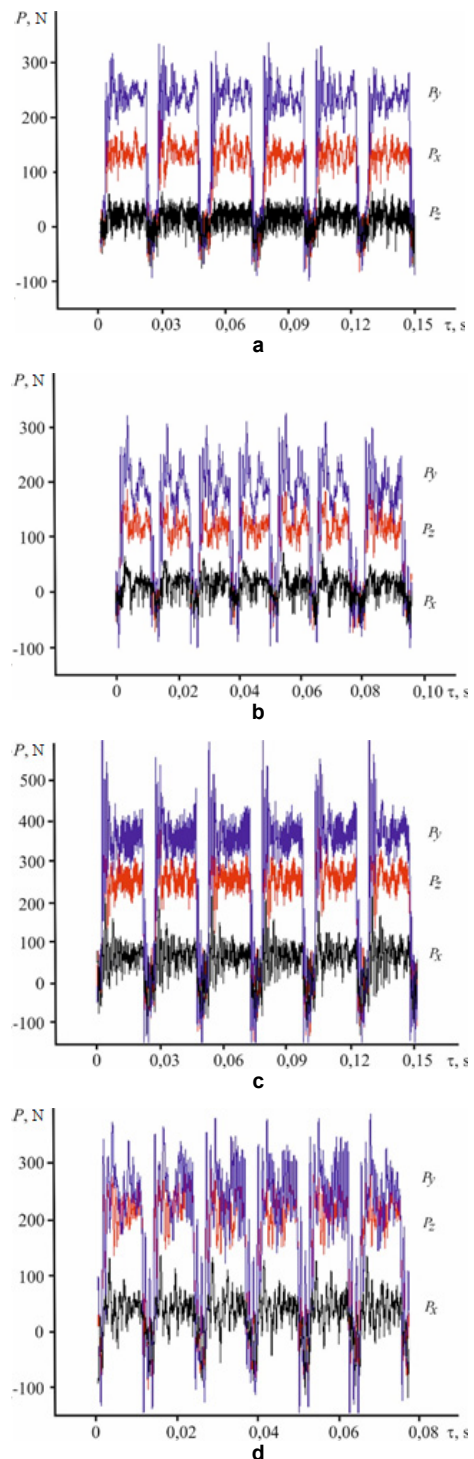
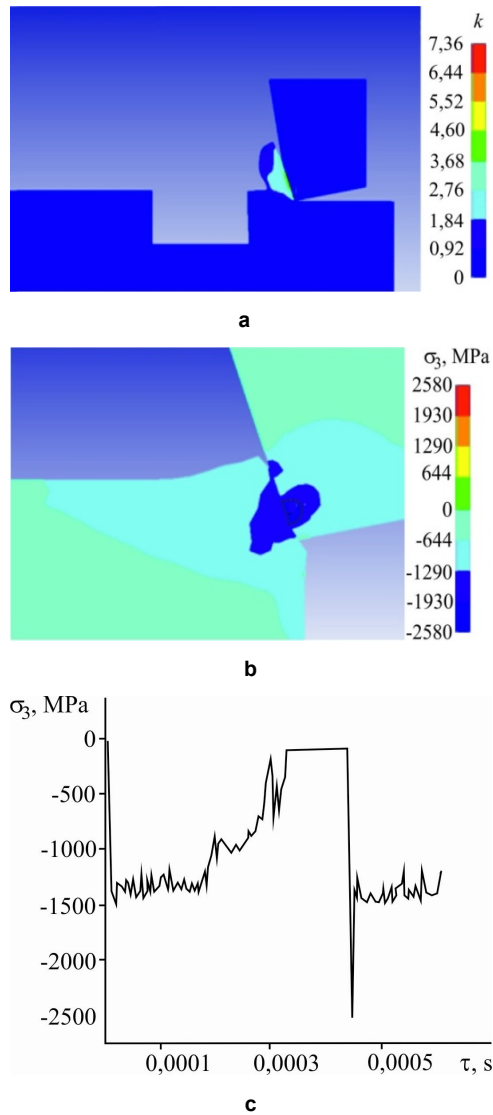

Figure 4 – Cutting force components when machining with Borsinit PcBN: a –  $v = 120$  m/min,  $t = 0.2$  mm; b –  $v = 210$  m/min,  $t = 0.2$  mm; c –  $v = 120$  m/min,  $t = 0.4$  mm; d –  $v = 210$  m/min,  $t = 0.4$  mm

Based on the data obtained from the study of contact stresses and the value of the compressive strength of PcBN of the BH and BL groups, the probabilities of tool fracture during impact machining were calculated. It was established that the probability of fracture for tools of the BH group is 0.1 %, for tools of the BL cBN—68.9 %, given the dispersion of the properties of the BL group composite, the probability of their fracture under the considered conditions is quite high.



**Figure 5 – FEM of the impact ( $v = 100$  m/min.,  $t = 0,4$  mm,  $f = 0,1$  mm/rev) friction coeff.  $\mu = 0,8$ : a – general view; b – the moment on the strike and stresses appearance; c – 3<sup>rd</sup> Principal Stress as a function of cutting time**

For the case of a tool equipped with PcBN inserts of group BL after vibromagnetic abrasive treatment, the fracture probability was also calculated. It was found that in this case, the probability of tool fracture is 30%, which is two times lower than for tools after standard finishing. Reducing the probability of tool fracture during impact machining is due to a decrease in the level of the third principal stress at the moment of tool penetration into the material being machined.

Analysis of the obtained experimental results shows that in the range of cutting speeds up to  $v = 210$  m/min, the modified tools equipped with PcBN of group BL, in comparison with tools with PcBN of group BH, are

characterized by stable operation of polycrystals at low load (cutting depth up to  $t = 0.2$ ).

The generalization of the obtained experimental data characterizing the conditions under which the fracture of CBN polycrystals was observed made it possible to construct a diagram of the ranges of cutting modes in the coordinates cutting speed - cutting depth at which the effective use of modified tools made of CBN of the BL and BH groups is possible (Fig. 6).

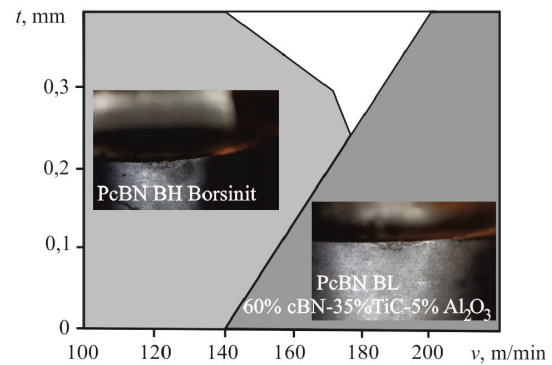

**Figure 6 – Diagram of the conditions for the effective use of BH and BL polycrystals in the processing of hardened CVG steel**

## 5. CONCLUSION

In interrupted machining of hardened steel, a tool equipped with PcBN BH Borsinit composite has a lower wear rate compared to continuous turning in the cutting speed range of 120-210 m/min.

In the conditions of intermittent machining of hardened steel with a tool equipped with PcBN BL with a TiC bond: – at a cutting speed of 120 m/min, microfracture of the tool occurs; - with an increase in cutting speed to 210 m/min, gradual wear of the contact areas of the tool occurs.

The machining process is accompanied by impulsive loading of the cutting tool - during impacts, the maximum value of the third principal stress exceeds the average level of compressive stress during continuous cutting by 1.6 times, which can lead to damage to the cutting tool.

The probability of destruction of a tool equipped with PcBN BL can be reduced by up to 2 times due to additional vibro-magnetic-abrasive treatment of its working surfaces with a decrease in their roughness and the formation of the required radius of the cutting edge. At the same time, when operating at a cutting speed of 210 m/min, the modified tools equipped with PcBN of the BL group, in comparison with tools made of PcBN of the BH group, are characterized by stable operation at low values of the cutting depth.

The generalization of the obtained experimental data made it possible to construct a diagram of the ranges of cutting modes in the coordinates "cutting speed-depth of cut", at which the effective use of tools equipped with PcBN of BH and BL groups is possible.

Further development of works on the considered subject is connected with the study of contact phenomena in the zone of high-speed cutting with shock loads and the development of new cBN-based composites.

## REFERENCES

- [1] Abrao, A.M., Aspinwall, D.K. and Wise, M.L.H.: A Review of Polycrystalline Cubic Boron Nitride Cutting tool Developments and Application, in: *Proceedings of the Thirtieth International MATADOR Conference*, 2019, London, pp.169-180.
- [2] Samantaraya, D., Lakade, S.: Optimization of Machining Parameters in Hard Turning of Automotive Gears with PCBN tool using Taguchi Method, *International Review of Mechanical Engineering (IREME)*, Vol. 15, No. 5, 2021.
- [3] Fleming, M.: Tooling concepts for gear turning with PCBN, *Industrial Diamond Review*, 2004.
- [4] Клименко, С.А., Манохин, А.С., Копейкина, М.Ю., Клименко, С.Ан., Мельничук, Ю.А., Чумак А.А.: *Высокопроизводительная чистовая лезвийная обработка деталей из сталей высокой твердости*. ИСМ им. В.Н. Бакуля НАН Украины, pp. 1-304, 2018.
- [5] Hooper, R. M., Brookes, C. A., Almond, E. A.: *Proc. 2th International Conference on the Sci. of Hard Materials*, Rhodes, pp. 23–28, 1984
- [6] Kevin, Y.C.: Hard turning of M50 steel with different microstructures in continuous and intermittent cutting, *Wear*, Vol. 255, pp. 1388 - 1394, 2003.
- [7] Kevin, Y.C., Evans, C.J.: Cubic boron nitride tool wear in interrupted hard cutting, *Wear*, Vol. 255-229, pp. 234 - 245, 1999.
- [8] Kevin, Y.C. Evans, C.J., Barash, M.M.: Experimental investigation on CBN turning of hardened AISI 52100 steel, *Journal of Materials Processing Technology*, Vol. 124, pp. 274-283, 2002.
- [9] Deniz, A., E., Gomes, D.M., Braghini, A., Turning of hardened steel with interrupted and semi-interrupted cutting, *Journal Of Materials Processing Technology*, Vol. 129, pp. 240-248, 2004.
- [10] Halpin, T., Byrne, G., Barry, J., Ahearne, E.: The performance of polycrystalline cubic boron nitride tools in continuous, semi-interrupted, and interrupted hard machining, *Proceedings of the Institution of Mechanical Engineers, Part B: Journal of Engineering Manufacture*, Vol. 223, pp. 947-953, 2009.
- [11] Costes, J.P., Yoann, G., Poulachon, G., Dessoly, M.: Tool-life and wear mechanisms of CBN tools in machining of Inconel 718, *International Journal of Mach. Tools & Manufacture*, Vol. 47, pp. 1081-1087, 2007.
- [12] Klimentenko, S.A., Kopeikina, M.Y., Tanovic, L.: Wear of superhard cutting tools, *FME Transactions*, Vol. 31, pp. 1-6, 2003.
- [13] Kirin B., Nagaraju D.: Comparative Analysis of Process Parameters in Wear Properties of Coated and Uncoated Tool Inserts during Machining of Hastellou C-276, *FME Transactions*, Vol. 48, pp. 651-666, 2020.
- [14] Wang, G., Zhou, X., Wu, X., Ma, J.: Failure and Control of PCBN Tools in the Process of Milling Hardened Steel, *Metals*, 2019.
- [15] Okamura, K., Kukino, S., Fukaya, T.: New Pcbn for Heavy Interrupted Cutting of Hardened Steel, *Materials Science Forum*, Vol. 534-536, pp. 1117 - 1120, 2007.
- [16] Kanada, Y., Fukaya, T., Wakabayashi, T., Shiraishi, J., Tomita, K., Nakai, T.: High Precision Cutting and High Speed Interrupted Cutting of Hardened Steel With PCBN Tools, *Materials Science*, 1999.
- [17] Godoy, V.A.A., Diniz, A.E.: Turning of interrupted and continuous hardened steel surfaces using ceramic and CBN cutting tools, *Journal of Materials Processing Technology*, Vol. 211, pp. 1014-1025, 2011.
- [18] Tiegs, T.: SiC Whisker Reinforced Alumina, *Handbook of Ceramic Composites*, pp. 307-323, 2005.
- [19] Sun., L., Zou, Y., Ma, M., Li, G., Wang, X., Zhang, X., Zhuge, Z., Liu, B., Wu, Y., Li, B., Zhao, Z.: Synthesis of cBN-hBN-SiCw Nanocomposite with Superior Hardness, Strength, and Toughness, *Nanomaterials*, Vol. 13, 2022.
- [20] Rumiantseva, Yu.Yu., Bushlya, V.N., Turkevich, V.Z. The Influence of SiC and Al<sub>2</sub>O<sub>3</sub> Whiskers on the Properties of Whisker-Reinforced cBN-Based Composites. *Journal of Superhard Materials*. 14(46), pp. 22230–22238, 2019.
- [21] Rumiantseva, Yu.Yu., Bushlya, V.N., Petrusha, I.A., Turkevich, V.Z. Influence of the reinforcement by the whiskers of Si<sub>3</sub>N<sub>4</sub> and Mg<sub>2</sub>B<sub>2</sub>O<sub>5</sub> on the properties of cBN-based composites. *Rock cutting and metal-working tools – a technique and technology of his making and application*. 22, pp. 260–270, 2019.
- [22] Olivera, A.J., Diniz, A.E., Ursolino, D.J.: Hard turning in continuous and interrupted cut with PCBN and whisker-reinforced cutting tools, *Journal of Materials Processing Technology*, Vol. 209, pp. 5262-5270, 2009.
- [23] Purnomo, P., Setyarini, P.H, Anggono, A.D. Fiber orientation effect on fracture toughness of silk fiber-reinforced zeolite/HDPE composites. *FME Transaction*, Vol. 49(1), p.p. 128-134, 2021.
- [24] Mo, P., Chen, J., Chen, C., Hu, Q., Pan, X., Xiao, L., Lin, F.: Study on the composition, microstructure and mechanical properties of PCBN composites synthesized by TiN–AlN–Ti combined with cBN, *Journal of Materials Science*, Vol. 57, pp. 17481-17490, 2022.
- [25] Ji, H, Li, Z., Sun, K., Zhu, Y.: Assessment of the performance of TiB<sub>2</sub> nanoparticles doped cBN-TiN-Al-Co composites by high temperature high pressure sintering, *Materials Chemistry and Physics*, Vol. 223, pp. 46-51, 2019.
- [26] Суслов, А.Г.: *Качество поверхностного слоя деталей машин*. Машиностроение, pp.. 1-320, 2000.

- [27] Chumak A.O., Klimenko S.A., Klimenko S.An., Manokhin A.S., Naydenko A.G., Kopiekina M.Y., Bondarenko M.O., Burikin V.V., Burlakov V.I. Finish machining of the cutting inserts from cubic borine nitride BL group composite. *Cutting & Tools in Technological System*. 94, pp. 102–114, 2021.
- [28] Arnarego, E.J. Brown, R.H.: The cutting of metals. Prentice-Hall. Inc., pp. 1-325, 1969.

---

#### **ОБРАДА СТРУГАЊЕМ КАЉЕНИХ ЧЕЛИКА АЛАТИМА ОД PсBN**

**А.С. Манохин, С.А. Клименко, Ј. Мелничук,  
С.Ан. Клименко, А.О. Чумак, О.О. Пасични,  
Xin Li, К.В. Камчатна-Степанова, А.С. Осипов**

У раду су анализирани резултати истраживања процеса стругања каљеног челика алатима на бази кубног борнитрида (PсBN). У истраживањима су коришћени алати од PсBN ознака ВН и ВL, који у себи садрже Si<sub>3</sub>N<sub>4</sub>, TiC и TiCN, при брзини резања  $v = 120-210$  m/min. Показано је да се ВL PсBN може користити при прекидном резању (резању са ударима) у опсегу режима дубине до 0,2 mm и велике брзине. При мањим брзинама ( $v = 120$  m/min) уочава се појава крзања резног сечива, а са повећањем брзине долази до интензивнијег хабања површине алата. Мерењем сила уочава се њихов пораст до 40% при уласку алата у обрађивани материјал. Анализа FEM показује пораст напона за 1.6 пута при прекидном у односу на непрекидно стругање, а тиме и могућност оштећења алата. Приказани су подаци о процени вероватноће лома алата у зависности од услова оптерећења и приказана је могућност смањења те вероватноће.