



LJMU Research Online

Naser, MH, Falah, MW, Naser, FH, Nasr, MS, Hashim, TM and Shubbar, A

The effect of industrial and waste fibres on concrete strength and structural behaviour of rc short columns

<http://researchonline.ljmu.ac.uk/id/eprint/22196/>

Article

Citation (please note it is advisable to refer to the publisher's version if you intend to cite from this work)

Naser, MH, Falah, MW, Naser, FH, Nasr, MS, Hashim, TM and Shubbar, A (2024) The effect of industrial and waste fibres on concrete strength and structural behaviour of rc short columns. IIUM Engineering Journal, 25 (1). pp. 87-101. ISSN 1511-788X

LJMU has developed [LJMU Research Online](#) for users to access the research output of the University more effectively. Copyright © and Moral Rights for the papers on this site are retained by the individual authors and/or other copyright owners. Users may download and/or print one copy of any article(s) in LJMU Research Online to facilitate their private study or for non-commercial research. You may not engage in further distribution of the material or use it for any profit-making activities or any commercial gain.

The version presented here may differ from the published version or from the version of the record. Please see the repository URL above for details on accessing the published version and note that access may require a subscription.

For more information please contact researchonline@ljmu.ac.uk

<http://researchonline.ljmu.ac.uk/>

THE EFFECT OF INDUSTRIAL AND WASTE FIBERS ON CONCRETE STRENGTH AND STRUCTURAL BEHAVIOR OF RC SHORT COLUMNS

MARYAM H. NASER¹, MAYADAH W. FALAH², FATIMAH H. NASER¹,
MOHAMMED SALAH NASR^{3*}, TAMEEM MOHAMMED HASHIM²
AND ALI ABDULHUSSEIN SHUBBAR⁴

¹College of Engineering, Al-Qasim Green University, Babylon, Iraq

²Building & Construction Techniques Engineering Department,
Al-Mustaqbal University College, Babylon, Iraq

³Technical Institute of Babylon, Al-Furat Al-Awsat Technical University, Babylon, Iraq

⁴School of Civil Engineering and Built Environment, Liverpool John Moores University,
Liverpool, UK

*Corresponding author: mohammed.nasr@atu.edu.iq

(Received: 25 April 2023; Accepted: 2 September 2023; Published on-line: 1 January 2024)

ABSTRACT: Concrete is a brittle substance; thus, it is reinforced with rebars and fibers to enhance its ductility. On the other hand, the presence of waste from various industries negatively impacts the environment. The ongoing reconstruction in Iraq has resulted in an abundance of locally produced rebar-connecting wire (RCW) and copper electric wire (CEW) waste. To minimize the environmental impact of these wastes, they can be reused in other industries, such as the concrete industry. Few studies have dealt with concrete's structural and mechanical properties containing these local residues. Therefore, this study included an experimental investigation of concrete columns with and without various types of industrial and waste fibers. Two types of industrial fibers (macro hooked-end; CH, and micro straight; CS) steel fibers and two types of waste fibers (RCW and CEW) were utilized. Six reinforced concrete (RC) columns ($150 \times 150 \times 450 \text{ mm}^3$) were cast: one control column without fibers and five columns with fibers. The fiber content within the columns was fixed at 0.75% of the concrete volume. The cracks pattern, load-deflection behavior and concrete strain for RC columns were investigated. Moreover, the mechanical properties in terms of compressive, splitting tensile, and flexural strengths tests were also conducted. The results revealed that all types of fibers used improved the mechanical and structural properties of the concrete. Moreover, although the hybrid synthetic fibers gave the best improvement compared to the reference sample, the waste fibers (especially RCW) showed a significant improvement that reached 30.91% in relation to the ultimate load and (10.1, 10.8 and 14.4%) in relation to the compressive, tensile, and flexural strengths respectively.

ABSTRAK: Konkrit adalah material rapuh; oleh itu ianya dikuatkan dengan besi dan fiber bagi menguatkan kekuatannya. Dalam masa sama, kehadiran bahan buangan dalam pelbagai industri memberi kesan negatif kepada persekitaran. Penstrukturan semula Iraq yang sedang berlangsung memberi kesan kepada kebanjiran bahan buangan seperti besi penghubung litar (RCW) dan litar elektrik tembaga (CEW) buatan tempatan. Bagi mengurangkan kesan pencemaran terhadap alam sekitar,

bahan-bahan ini boleh diguna balik dalam industri berbeza, seperti industri konkrit. Terdapat banyak kajian terhadap buangan tempatan yang melibatkan struktur bahan konkrit dan sifat mekanikal. Oleh itu, kajian ini merupakan kajian eksperimen pasak konkrit dengan atau tanpa pelbagai jenis industri dan fiber buangan. Dua jenis fiber industri iaitu fiber besi (mikro hujung-penyangkut; CH dan mikro lurus; CS) dan dua jenis fiber buangan (RCW dan CEW) dipakai. Enam RC pasak konkrit ($150 \times 150 \times 450 \text{ mm}^3$) dihasilkan: satu pasak kawalan tanpa fiber dan lima pasak dengan fiber. Kandungan fiber dalam pasak di tetapkan pada 0.75% isipadu konkrit. Corak rekahan, ciri-ciri kesan beban dan tekanan konkrit pada pasak RC dikaji. Tambahan, kajian terhadap ciri-ciri mekanikal berdasarkan tekanan, rekahan tensil dan kekuatan anjalan telah dijalankan. Dapatan kajian menunjukkan kesemua fiber yang digunakan menambah baik ciri-ciri mekanikal dan struktur konkrit. Tambahan lagi, walaupun fiber sintetik hibrid menunjukkan paling baik berbanding sampel contoh, fiber buangan (terutama RCW) menunjukkan pembaharuan ketara mencapai 30.91% berbanding beban maksimum dan masing-masing menunjukkan 10.1, 10.8 dan 14.4% pada tekanan, rekahan tensil dan kekuatan anjalan.

KEYWORDS: *industrial and waste fibers; RC columns; mechanical properties; structural behavior*

1. INTRODUCTION

Concrete is a vastly employed building substance all over the world [1]. However, it begins to lose its bearing capacity as cracks start and gradually continues with the growth of cracks which may eventually lead to failure. Normal concrete is characterized by its low tensile and cracking resistance and limited ductility [2]. Therefore, different types of fibers (such as natural, synthetic and steel fibers) are integrated into the concrete to improve the mechanical characteristics and resistance against cracking of cement-concrete composites [3,4]. Concrete made with steel fiber has been efficiently used in precast products, slabs on grade, architectural panels, shotcrete, marine structures, thin and thick repairs, structures in seismic zones, crash barriers, hydraulic structures, foundations, and many other structures [5]. Depending on its properties, the utilization of fibers in a concrete structural member may enhance ductility performance and limit the crack generation and overall strength and toughness [6,7]. Moreover, fiber-reinforced concrete can improve the compressive behavior of concrete pillars. This improvement is attributed to the effect of confinement of these fibers, which leads to superior performance in terms of resistance and ductility compared to ordinary concrete [8]. In this context, several previous studies investigated the effect of fibers on reinforced concrete columns. Some of these studies [9-11] have found that adding steel fibers increased the strength of columns and showed higher levels of ductility when compared with columns that did not contain steel fibers. Mahdi [12] presented an analytical and experimental evaluation of the ductility and strength of high-performance and normal concrete columns with/without polypropylene and steel fibers confined by tie reinforcement. It was found that adding fibers to high-performance and normal concrete short columns improves their behavior and increases the ultimate strength. Moreover, the results showed that the percentage increase in the peak strength when breaking the fixed steel fiber volume decreases slightly with the increase in the aspect ratio of the fibers. Balanji et al. [13] researched the behavior of hybrid steel fiber-reinforced (HSF) high-strength concrete circular columns under various loading situations. The hybrid steel fiber is composed of a mixture of fine and large steel fibers. Results demonstrated that reinforced concrete columns with HSF realized higher ductility and strength under

different loading conditions than RC columns without HSF. Also, it was revealed that the cracks of the concrete cover were delayed due to the presence of fibers.

On the other hand, the use of metallic waste fibers, especially steel ones, in concrete and their comparison with industrial fibers have been investigated in the literature. For example, Domski et al. [14] conducted an experimental study to investigate the impact of waste steel fibers (WSF) from tire recycling on concrete properties and compared the results with conventional engineered steel fibers (ESF). The results indicated that the concrete containing WSF achieved higher ductility and tensile strength than that made with ESF. Moreover, Samindi et al. [15] researched the mechanical performance of concrete produced with waste (recovered from tires) and manufactured steel fibers. It was found that the compressive strength of concrete was improved by 17–20% in the presence of manufactured fibers compared to 5–12% enhancement for waste fibers. Moreover, a similar ductile behavior was observed for both types of fibers when used separately at a rate of 0.5%. Furthermore, Sofi and Gopu [16] explored the compressive, splitting tensile and flexural characteristics of concrete made from industrial and waste fibers (electrical waste glass fiber, EWGF, and electrical waste copper wire fiber, EWCWF). Results revealed that the industrial, EWGF and EWCWF fibers improved the compressive, splitting tensile and flexural strengths by (42.6%, 81.6% and 46.1%), (15.35%, 90.1 and 31.7%) and (23.76, 46.4 and 38.8%), respectively.

The volume of fibers in a mixture plays a crucial role in determining its various properties. A study conducted by Soulioti et al. [17] focused on the mechanical behavior of reinforced concrete that was reinforced with steel fibers of varying geometries (hooked ends and waved) and volumes (0.5%, 1%, and 1.5%). The findings showed that the mechanical properties, flexural toughness, and peak strength of the concrete improved as the fiber content increased. Additionally, the geometry of the fibers was found to have a significant impact on the material's mechanical performance. On the other hand, Gao et al. [18] studied the compressive behavior of RC columns under uniaxial compression in recycled aggregate concrete incorporated steel fibers in proportions of 0.5%, 1%, and 1.5% (by volume). They found that the optimum percentage for steel fiber was 1%. A study was conducted by Attia [19] to investigate the impact of different types (steel and polypropylene) and amounts of fibers (0.5% and 0.75%) with different aspect ratios (100 and 667) on the strength of RC columns. The results indicated that adding fibers, particularly at a percentage of 0.75% with an aspect ratio of 100, improved the mechanical properties and structural behavior of the concrete columns.

The waste, especially solid waste, constitutes a problem facing governments in developing countries because of its negative impact on the environment. It occupies large areas in landfills in addition to the fact that its decomposition takes a long time. Therefore, one of the methods to reduce this environmental damage is to reuse the waste in other industries (for example, concrete manufacturing) and convert it into valuable materials. Among these waste materials are rebar-connecting wires (RCW) and copper electric wires waste (CEW). These wastes are produced locally (in Iraq) in significant quantities as a result of the reconstruction of destroyed buildings due to wars and military operations in recent years. Few studies have dealt with using these local wastes as fibers in concrete. Moreover, few studies have examined four distinct types of fibers and compared them in terms of mechanical and structural performance. Furthermore, limited studies have dealt with the mechanical behavior of concrete columns containing hybrid fibers and compared it with the control (fiber-free) and that containing synthetic or waste fibers. In addition, the significance of this research stands out as it enhances sustainability and the management of solid waste by transforming non-valuable materials into valuable ones that can be utilized successfully in the construction industry. Accordingly, this study aims to investigate the mechanical and structural properties of reinforced concrete

columns containing locally produced (RCW and CEW) fibers along with industrial hooked-end and straight steel fibers. The results of the study are considered promising, not only in improving the above properties but also contributing to enhancing the production of green concrete as a result of reusing these wastes and reducing their harmful environmental impact.

2. EXPERIMENTAL WORK

2.1 Properties of Concrete Materials

The components used in the production of the concrete mixtures for plain and reinforced specimens were lime cement, natural fine and coarse aggregates, superplasticizer, and tap water. The cement was CEM II/A-L-42.5R in type and conformed to BS EN 197-1 [20]. Tables 1 and 2, respectively, illustrate the physical and chemical characteristics of the cement.

Table 1: Chemical analysis of the cement

Oxide, %	Percentage by Weight
CaO	59.89
SiO ₂	20.8
Al ₂ O ₃	5.50
Fe ₂ O ₃	5.1
MgO	3.81
Free CaO	0.67
SO ₃	1.8
Loss on Ignition	2.2
Insoluble Residue	1.1

Table 2: Physical properties of the cement

Physical Properties	Test Results	
Specific Gravity	3.15	
Fineness (Blaine) (m ² /kg)	346	
Time of Setting (Vicat) (minute)	Initial time	180
	Final time	205
Compressive Strength (MPa)	3 days	20.50
	7 days	27.00

The fine aggregate (natural sand) met Iraqi Standard No.45, zone 2 [21]. The fineness modulus of sand was 2.94. Natural gravel with a maximum size of 10 mm was employed as a coarse aggregate. The sieve analysis results of fine and coarse aggregates are presented in Tables 3 and 4, respectively. SikaViscocrete-5930, which conformed to ASTM C494 (types F and G) [22], was utilized as a workability adjuster. Four types of steel fibers (see Fig. 1) were added to the concrete mixtures to improve their properties. Two types of these fibers are considered conventional (purchased from the market): one was macro hooked-end (CH), and the other was micro straight-end (CS). In contrast, the other types of fibers were waste. The source of one of the waste fibers was from the rebar-connecting wires (RCW), and the other was from the copper electric wires waste (CEW). The wires were cut to the required size manually. The properties of all types of fibers are given in Table 5.

Table 3: The sieve analysis results of the fine aggregate

Sieve Size (mm)	Passing %	Limits of the Iraqi Standard, Zone 2
10	100	100
4.75	100	90-100
2.36	82.5	75-100
1.18	60.9	55-90
0.60	49.4	35-59
0.30	11.3	8-30
0.15	2.3	0-10

Table 4: The sieve analysis results of the fine aggregate

Sieve Size (mm)	Passing, %	Limits of the Iraqi Standard
14	100	100
9.5	100	85-100
4.75	20.7	0-25
2.36	2.5	0-5

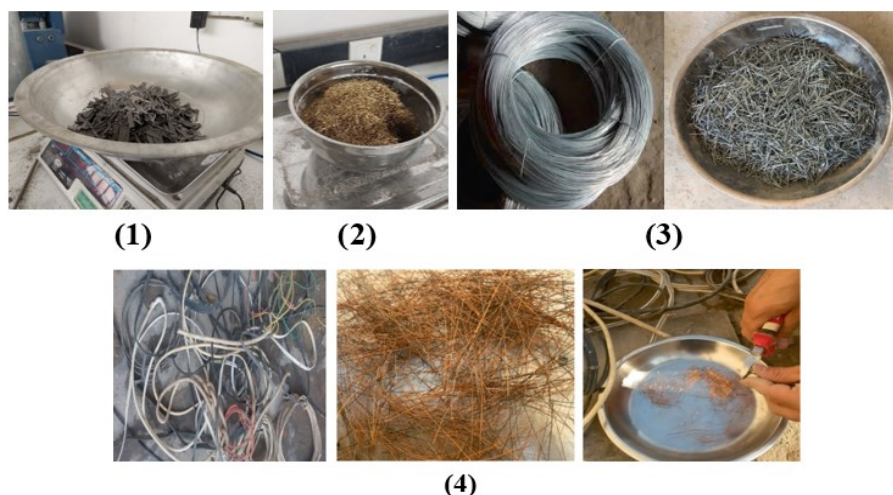

Fig. 1: The fibers used (1) CH; (2) CS; (3) RCW; and (4) CEW.

Table 5: The properties of fibers

Fiber Designation	Tensile Strength (MPa)	Density (kg/m ³)	Length (mm)	Diameter (mm)	Aspect ratio (L/D)
CH	1300	7500	35	0.5	70
CS	2300	7860	13	0.2	65
RCW	510	7500	20	0.8	25
CEW	387	8760	10	0.17	59

2.2 Mix proportions, Casting, and Curing

The mix proportions that were adopted for this study were 1:1.25:2 (cement: sand: gravel) with a W/C ratio of 0.35. For the concrete mixes, all parameters were fixed except for the type of fibers. The fibers were added in proportions of 0.75% by volume of concrete. One reference mix (control), four mixtures containing a single type of fiber (CH, CS, RCW, or CEW) and

one mix incorporating hybrid fibers (CH + CS) were executed for this study. For the hybrid fibers mixture, the addition percentage for each the micro and macro steel fibers was 0.375% (0.75% in total). Table 6 shows the details of mix proportions for all mixes. After mixing, the fresh concrete was cast in standard and column molds. After about 24 hours of casting, specimens were lifted from molds. Thereafter, the specimens were placed in water until the testing time (28 days).

Table 6: Mix proportion details of concrete mixes

Mix Designation	Fiber Type	Cement (kg/m ³)	Sand (kg/m ³)	Gravel (kg/m ³)	Fiber, %	Super-Plasticizer (kg/m ³)	Water (kg/m ³)
M1	---	450	563	900	0.75	4.5	157.5
M2	CH	450	563	900	0.75	4.5	157.5
M3	CS	450	563	900	0.75	4.5	157.5
M4	CH+CS	450	563	900	0.375+0.375	4.5	157.5
M5	RCW	450	563	900	0.75	4.5	157.5
M6	CEW	450	563	900	0.75	4.5	157.5

2.3 Reinforced Concrete Specimens

This study included the preparation and testing of six columns under static load. The cross-section for all columns was 150 × 150 mm, and the columns have a total length of 450 mm. The columns were reinforced with four (Ø6 mm) longitudinal bars and Ø4 @ 50 mm stirrups. Figure 2 shows the details of the geometry and reinforcement of the columns.

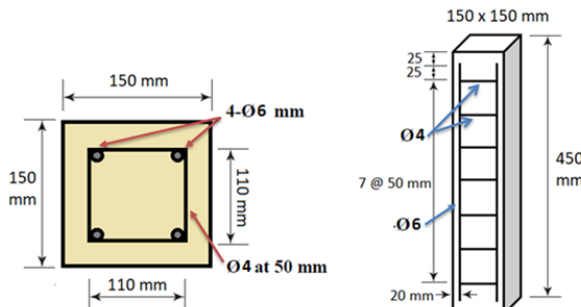

Fig. 2: Geometry and reinforcement details of the tested specimens.

Six samples were cast for this study: one control column without steel fibers for comparison with other columns, and five specimens containing 0.75% steel fibers with different types: macro, micro, and hybrid (conventional and waste). All columns are identified in Table 7.

Table 7: Designation of the RC Columns

Column Name	Identification of Fibers
C1	Column without fibers
C2	Column with macro steel fibers
C3	Column with micro steel fibers
C4	Column with hybrid (50% macro+ 50% micro) steel fibers
C5	Column with rebar-connecting waste wires
C6	Column with copper electric waste wires

Deformed steel bars (6 and 4 mm) in diameter were used as shown in Fig. 3. Bars of size Ø6 mm were utilized as a longitudinal reinforcement and bars of size Ø4 mm were used as a stirrup reinforcement. Table 8 shows the results of testing steel reinforcement according to ASTM A615 [23].

Table 8: Strength of steel reinforcement used.

Nominal Diameter (mm)	4	6
Fy (MPa)	412	423



Fig. 3: Steel reinforcement of RC columns.

2.4 Tests

Several mechanical tests were performed for this study. The mechanical test types and specimen details are presented in Table 9. The modulus of elasticity was determined depending on (ACI 363R) [24] from Eq. 1:

$$E_c = 3320 \sqrt{f_c'} + 6900 \quad (1)$$

Besides, reinforced concrete (RC) columns were tested for crack pattern, ultimate load, load-deflection and strain behavior.

Table 9: Mechanical tests details

Test	Specimen shape	Dimensions, mm	Standard
Compressive strength	Cube	150×150×150	BS 1881 Part 116 [25]
Splitting tensile strength	Cylinder	100×200	ASTM C496 [26]
Modulus of rupture	Prism	100×100×400	ASTM C78 [27]

3. RESULTS AND DISCUSSION

3.1 Mechanical Properties

3.1.1 Compressive strength

The results of the compression test for all the mixtures are shown in Fig. 4. The results generally showed that the added fibers of all types improved compressive strength. The percentage of improvement was within the range of 3.9 to 27% compared to the reference mixture (without fibers). This is due to these fibers' role in arresting the growth of cracks within the concrete matrix [28]. Moreover, the results clearly showed that the best compressive strength (59.34 MPa, which represents a 27% improvement related to plain concrete) was

recorded when using hybrid fibers. The reason for this behavior can be attributed to the fibers' ability to restrict cracking on both the micro and macro levels [29]. Furthermore, the waste fibers gave an improvement of 3.9% for RCW fibers and 10.1% for CEW fibers, which represented (especially for CEW fibers) a significant increase related to the reference sample.

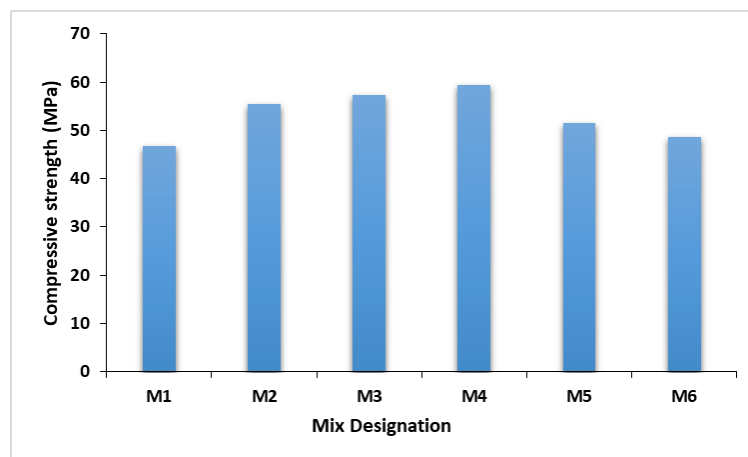

Fig. 4: Compressive strength results of plain and fiber reinforced specimens.

3.1.2 Splitting Tensile Strength

Figure 5 presents the splitting tensile strength of concrete cylinders. The results illustrated, as in the case of the compressive strength test, that the presence of fibers contributed to an increase in the tensile strength of concrete in proportions differing according to the type of fibers. Also, the highest improvement value (35.3%) was obtained after using the hybrid fibers (CH+CS), followed by the hooked-end fibers. The ability of hybrid fibers to effectively bridge cracks, and thus the micro-mechanical features of crack bridging, work from the stage of damage development to after final loading [30]. On the other hand, the increase in the tensile strength in the hooked-end fibers mixture results from the increase in the value of the bonding strength between the fibers and the concrete due to the hooked ends [31]. Furthermore, the waste fibers showed strength exceeding the reference mixture by 10.8 and 7% for CH and CS fibers, respectively, which indicates the ability of these fibers to bridge the cracks and increase the collapse resistance of the concrete.

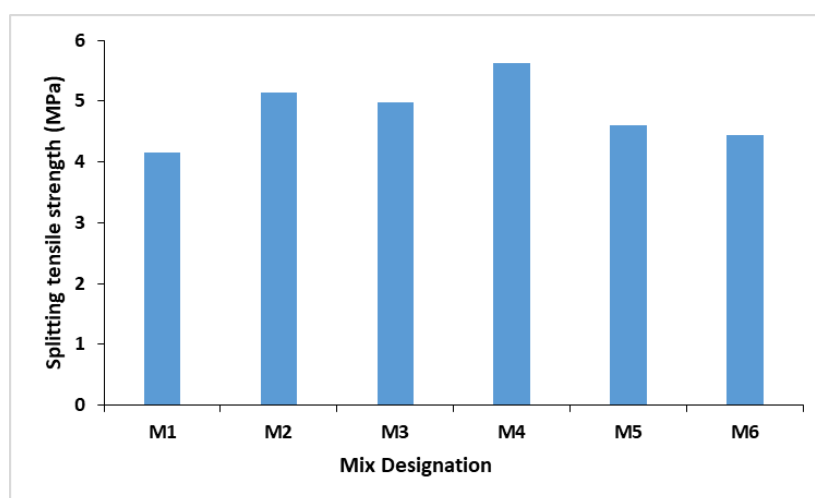

Fig. 5: Splitting tensile strength results of concrete mixtures.

3.1.3 Flexural Strength

The results of flexural strength for the reference and fiber-reinforced mixes are displayed in Fig. 6. In general, the flexural strength results were in the same trend as the compressive and tensile strength tests. Where the mixtures incorporating fibers demonstrated higher strength than those without them. Moreover, the mixture containing the hybrid of micro and macro fibers recorded the highest flexural strength (improvement percentage was 37.3%). The improvement in flexural length of the hybrid fiber-based concrete is due to the ability of the fine steel fibers to control micro-cracking in the early stages of loading and hooked-end fibers are larger, providing a bridge mechanism across large (macro) cracks [32]. Also, the waste fibers increased strength by 11.2% and 14.4% (over the control sample) for CH and CS fibers, respectively. This indicates the effectiveness of crack-bridging action for these waste fibers.

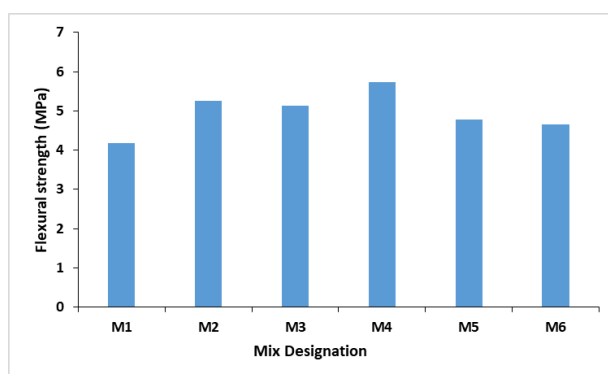

Fig. 6: Flexural strength results of concrete mixtures.

Furthermore, according to the above, it can be noticed that the CH fibers had a superior performance than CS fibers in compressive, splitting tensile and flexural strengths tests. The reason beyond that may be attributed to the bond increasing between the fibers and concrete matrix as a results of fiber length (CH fibers are twice as long as CS fibers) [33].

3.2 Flexural Properties of RC Columns

3.2.1 First Crack and Cracks Pattern

The load was applied to the centerline of the columns as previously described. The member condition, cracks extension, behavior, or any damage from loading to failure was observed. Concrete cracks were observed to show the damage process during each column's testing phases. Table 10 and Fig. 7, respectively, show the results of first crack loads and crack patterns for all columns.

Table 10: First crack load, ultimate load and deflection results

Column	Fiber Type	First Crack Load (kN)	Ultimate Load (kN)	Increase Rate in Ultimate Load %	Max. Deflection (mm)
C1	---	335.37	619.61	-----	1.10
C2	CH	404.99	794.19	28.18	1.79
C3	CS	410.34	883.72	42.63	2.22
C4	CH+CS	471.13	914.21	47.54	2.01
C5	RCW	398.14	811.12	30.91	1.64
C6	CEW	404.12	784.23	26.56	1.48

The results of the control (without steel fibers) column (C1) showed that the first crack was observed at (335.37 kN). Upon further loading, new cracks extending on both sides to deform the column, were recorded. As the loading increased, cracks appeared in the concrete at the column supports. With continued loading, the deformation of the column grew. Finally, the concrete split and failed in shear on all four sides at the bottom of the column.



Fig. 7: Crack patterns for columns with different steel fibers.

On the other hand, the presence of fibers delayed the appearance of the first crack compared to the reference sample. Where the results showed that the presence of hybrid fibers (C4) contributed to improving the load of the first crack by 40.48%, while the waste fibers (RCW; C5, and CEW; C6) showed superiority in the load of the first crack by 18.72 and 20.50%, respectively compared to the reference column. Furthermore, the results indicated that the primary cracks were noticed at the beginning of loading for fibers containing columns. As the load increased, new cracks extended from both sides in the center of the column depth. Because of shearing, new cracks extended diagonally at the top of the column. As the loading continued, new cracks also showed up in the column and the concrete cover breakage happened in the mid-span. The width of the main crack increased at the mid-span of the column. Finally, the column failed.

Moreover, in the case of the control column without steel fiber, the failure was mainly caused by cracks spreading parallel to the direction of the load through the coarse aggregate particles, known as a splitting crack. It was also found that the failure pattern under compressive load is a combination of tensile split failure and shear failure when adding the fibers to reinforced concrete columns. The presence of fiber changed how the reinforced concrete columns failed from a brittle to a more ductile failure. For columns with fibers, the vertical cracks that appeared in tested specimens were generally held together by the fibers. Also, the implication of fibers prevented the concrete from spalling. The cracks were distributed uniformly and extended along the length of the member. Their number is more, which indicates the usefulness of using these fibers in the distribution of stresses along the column [34]. This indicates the increase in ultimate strength and ductility of columns made with fiber.

3.2.2 Load – Deflection Behavior

Figure 8 shows load–deflection curves (the values can be seen in Table 10) of the specimens used in this study. In general, it was found that adding metallic fibers to reinforced concrete columns increased the ultimate load compared to fiber-free columns. Furthermore, the column behavior containing fibers had more deformability and ductility than those without fibers. These results agree with those in the literature [35].

Additionally, results revealed that specimen C1 (the control) gave a lower value in ultimate load when compared with other columns with fiber. Also, it exhibited a brittle failure mechanism, while the reinforced concrete columns with metallic fiber were quite ductile in the compression test (which was observed through the development of cracks and the final shape of columns in addition to the values of the ultimate loads at the failure). Hence, the fibers have been very successful in confining concrete internally.

Moreover, column C4, made with hybrid (CH+CS) fibers, showed significant enhancement in ultimate load and ductility compared to other metallic fiber types. The ultimate load of the hybrid fiber-based column was superior to the control one by 47.63%. This behavior can be interpreted as follows [36]; under loading, the microfibers avoid expansion of the structure by bridging the microcracks. Once the microfibers are affected, the larger fibers will continue to bridge the cracks until the damage is corrected, which enhances the load-deflection property. Furthermore, waste fibers enhanced the RC columns' load-carrying capacity. The recorded load improvements for RCW and CEW, respectively, were 30.91% and 26.56% compared to the control column, which indicates the efficiency of these fibers in bridging cracks and improving the load-deformation behavior.

Also, it was found that short fibers had a greater effect on the primary part of matrix cracking. Thus, it contributes more to enhancing the strength of the composite compared to long fibers. Thereby, the initiation and propagation of primary cracks are controlled by short fibers earlier and more actively than long fibers. Accordingly, short fibers appear larger in number as a result of their proximity to each other [37].

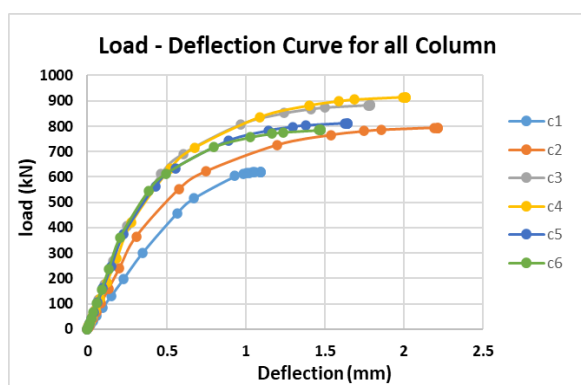

Fig. 8: Load – deflection curves for columns with and without fibers.

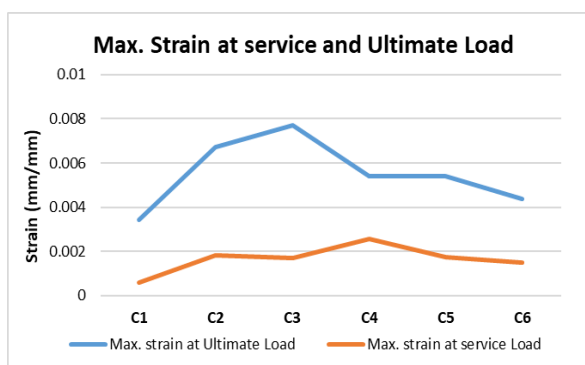

Fig. 9: Maximum strain at service and ultimate loads for all columns.

3.2.3 Concrete Strains

The strain in the concrete was measured at different load levels, at mid-span for all columns, using demec discs located 50 mm along the column length. It was measured using a Digital Vernier Caliper. The concrete strain at service and ultimate loads are presented in Fig. 9. Results revealed that a similar behavior with low strain values for all columns was observed,

consistent with the high stiffness of the uncracked section. When the crack occurred, the differences between them increased significantly.

It was observed that the maximum compressive strain ϵ_{\max} at ultimate load (P_u) ranged between 0.0034 to 0.0077 while the maximum strain ϵ_{\max} at service load (at 0.7 P_u) from 0.00056 to 0.0025 as shown in Fig. 9. The maximum strain ϵ_{\max} at service load values were below the normal ones prescribed by the American Code of Practice (ACI Committee 363), ϵ_{cu} , which is 0.003. Figure 10 shows the strain distribution of concrete for all columns in different load stages.

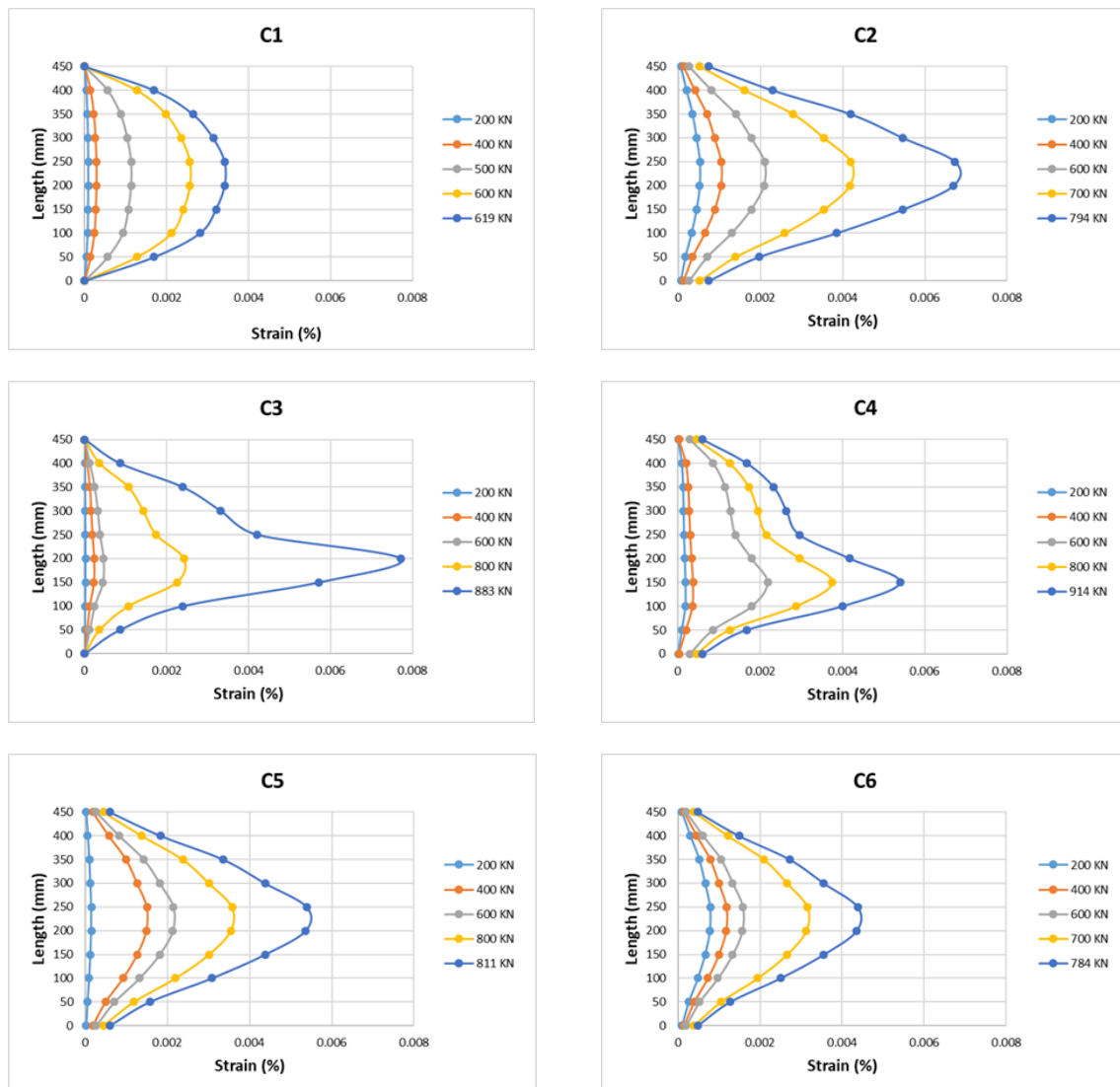

Fig. 10: Concrete strain distribution for all columns in different load stages.

4. CONCLUSIONS

According to what was obtained in this experimental study for RC columns with different types of metallic fibers under static loading, the conclusions shown below can be stated:

1. Industrial and waste fibers showed a clear improvement in the mechanical properties of concrete, where the percentages of increments were within the ranges of 3.9-27%,

- 7-35.5%, and 11.2-37.3% for compressive, splitting tensile, and flexural strengths, respectively.
2. The most remarkable improvement for industrial fibers was recorded in the mixture containing hybrid fibers, while for waste fibers, RCW fiber-based mixture showed better performance than CEW in the all-mechanical examinations performed.
 3. The behavior of the columns with metallic fibers was more deformable than columns without fibers. Moreover, in the presence of industrial and waste fibers, the distribution of cracks was uniform and extended along the member length, and its number was greater.
 4. The column with hybrid steel fiber had a load-carrying capacity greater than the control column by about 47.54 %. On the other hand, the improvements for waste fibers-based columns were 30.91% and 26.56% for RCW and CEW fibers, respectively.
 5. The maximum strain ϵ_{\max} at service load (at 0.7 ultimate loads) was between 0.00056 to 0.0025, less than the allowable strain according to ACI Committee 363 (0.003) for all columns.

In summary, considering all mechanical and structural tests, it is noted that the best performance was recorded when using hybrid fibers (macro and microfibers). Despite this, the waste fibers recorded a clear improvement in all concrete properties, and the performance of (RCW) was better than (CEW) compared to the reference sample. Moreover, waste disposal is another benefit of using these fibers, as it contributes to reducing environmental damage and thus is considered a promising solution in the field of green concrete technology.

ACKNOWLEDGEMENT

The authors give their heartfelt thanks to Al-Mustaqbal University College for providing technical support for this research.

REFERENCES

- [1] Nasr MS, Hussain TH, Najim WN. (2018) Properties of Cement Mortar Containing Biomass Bottom Ash and Sanitary Ceramic Wastes as a Partial Replacement of Cement. *International Journal of Civil Engineering and Technology (IJCIET)*, 9(10): 153-165.
- [2] Tokoda A, Chagweda F. (2020) Formulation Of Fiber Reinforced Concrete. Abou Bekr Belkaid University - Tlemcen, Algeria
- [3] Khan K, Ahmad W, Amin MN et al. (2022) Compressive Strength Estimation of Steel-Fiber-Reinforced Concrete and Raw Material Interactions Using Advanced Algorithms. *Polymers*, 14(15): 3065.
- [4] Cao M, Khan M. (2021) Effectiveness of multiscale hybrid fiber reinforced cementitious composites under single degree of freedom hydraulic shaking table. *Structural Concrete*, 22(1): 535-549.
- [5] Hadi MNS. (2007) Using fibres to enhance the properties of concrete columns. *Construction and Building Materials*, 21(1): 118-125.
- [6] Smarzewski P. (2019) Analysis of failure mechanics in hybrid fibre-reinforced high-performance concrete deep beams with and without openings. *Materials*, 12(1): 101.
- [7] Abdulridha SQ, Nasr MS, Al-Abbas BH, Hasan ZA. (2022) Mechanical and structural properties of waste rope fibers-based concrete: An experimental study. *Case Studies in Construction Materials*, 16e00964.

- [8] Rivera JE, Eid R, Paultre P. (2021) Influence of synthetic fibers on the seismic behavior of reinforced-concrete circular columns. *Engineering Structures*, 228111493. doi: <https://doi.org/10.1016/j.engstruct.2020.111493>.
 - [9] Hadi MNS. (2009) Reinforcing concrete columns with steel fibres. *Asian Journal of Civil Engineering*, 10(1): 79-95.
 - [10] Ikponmwosa EE, Salau MA. (2011) Effect of short steel fibre reinforcement on laterized concrete columns. *Journal of Sustainable Development*, 4(1): 230.
 - [11] Al-Shamma YM. (2011) Strength and Ductility of Confined Steel Fiber Reinforced Concrete Short Columns. MSc. Struct. Eng. Al-Mustansiriya Univ. Baghdad 113
 - [12] Mahdi ZR. (2012) Behavior of fiber reinforced high performance concrete columns. Sc Thesis Univ. Technol. Baghdad Iraq
 - [13] Balanji EKZ, Sheikh MN, Hadi MNS. (2016) Performance of high strength concrete columns reinforced with hybrid steel fiber under different loading conditions.
 - [14] Domski J, Katzer J, Zakrzewski M, Ponikiewski T. (2017) Comparison of the mechanical characteristics of engineered and waste steel fiber used as reinforcement for concrete. *Journal of Cleaner Production*, 15818-28. doi: <https://doi.org/10.1016/j.jclepro.2017.04.165>.
 - [15] Samarakoon SMSMK, Ruben P, Wie Pedersen J, Evangelista L. (2019) Mechanical performance of concrete made of steel fibers from tire waste. *Case Studies in Construction Materials*, 11e00259. doi: <https://doi.org/10.1016/j.cscm.2019.e00259>.
 - [16] Sofi A, Gopu GN. (2019) Influence of steel fibre, electrical waste copper wire fibre and electrical waste glass fibre on mechanical properties of concrete. In: *IOP Conf. Ser. Mater. Sci. Eng.* IOP Publishing. p 12023.
 - [17] Soulioti D V, Barkoula NM, Paipetis A, Matikas TE. (2011) Effects of fibre geometry and volume fraction on the flexural behaviour of steel-fibre reinforced concrete. *Strain*, 47e535–e541.
 - [18] Gao D, Li W, Pang Y, Huang Y. (2021) Behavior analysis and strength prediction of steel fiber reinforced recycled aggregate concrete column under axial compression. *Construction and Building Materials*, 290123278. doi: <https://doi.org/10.1016/j.conbuildmat.2021.123278>.
 - [19] Atea RS. (2019) A Case Study On Concrete Column Strength Improvement with Different steel fibers and polypropylene fibers. *Journal of Materials Research and Technology*, 8(6): 6106-6114. doi: <https://doi.org/10.1016/j.jmrt.2019.10.005>.
 - [20] BS EN 197-1. (2011) Cement, Composition, Specifications and Conformity Criteria for Common Cements. London, England: British Standards Institution-BSI and CEN European Committee for Standardization.
 - [21] Iraqi Standard No.45. (1984) Aggregate from Natural Sources for Concrete and Building Construction. Central Organization for Standardization and Quality Control, Baghdad, Iraq.
 - [22] ASTM C494/C494M, ASTM 494/C 494M. (2013) Standard Specification for Chemical Admixtures for Concrete. ASTM International, West Conshohocken, PA.
 - [23] ASTM A615. (2009) Standard specification for deformed and plain carbon-steel bars for concrete reinforcement. ASTM International, West Conshohocken, PA.
 - [24] ACI 363R. (2010) Report on High-Strength Concrete.
 - [25] BS 1881: Part 116. (2003) Method for determination of compressive strength of concrete cubes. British Standards Institution, UK.
 - [26] ASTM C496. (2011) Standard Test Method for Splitting Tensile Strength of Cylindrical Concrete Specimens. ASTM International, West Conshohocken, PA.
 - [27] ASTM C78. (2015) Standard test method for flexural strength of concrete (using simple beam with third-point loading). ASTM International, West Conshohocken, PA.
 - [28] Abbass W, Khan MI, Mourad S. (2018) Evaluation of mechanical properties of steel fiber reinforced concrete with different strengths of concrete. *Construction and building materials*, 168556-569.
 - [29] Mohammad SA, Krishna TNC, Saketh T, Ganesh CY, Sathyan D. (2022) Fresh and hardened state properties of waste tire fiber and steel fiber reinforced concrete. *Materials Today: Proceedings*, 80: 443–448.
-

- [30] Dawood ET, Ramli M. (2011) High strength characteristics of cement mortar reinforced with hybrid fibres. *Construction and building materials*, 25(5): 2240-2247.
 - [31] Khabaz A. (2016) Monitoring of impact of hooked ends on mechanical behavior of steel fiber in concrete. *Construction and Building Materials*, 113857-863.
 - [32] Ramkumar KB, PR KR. (2022) Impact of hybrid steel fibres on fresh and mechanical properties of Self-compacting concrete. *Case Studies in Construction Materials*, 17e01274.
 - [33] Sengul O. (2018) Mechanical properties of slurry infiltrated fiber concrete produced with waste steel fibers. *Construction and Building Materials*, 1861082-1091.
 - [34] Bhargava P, Sharma UK, Kaushik SK. (2006) Compressive stress-strain behavior of small scale steel fibre reinforced high strength concrete cylinders. *Journal of advanced concrete technology*, 4(1): 109–121.
 - [35] Tokgoz S, Dundar C. (2010) Experimental study on steel tubular columns in-filled with plain and steel fiber reinforced concrete. *Thin-Walled Structures*, 48(6): 414-422.
doi: <https://doi.org/10.1016/j.tws.2010.01.009>.
 - [36] Dhanapal J, Jeyaprakash S. (2020) Mechanical properties of mixed steel fiber reinforced concrete with the combination of micro and macro steel fibers. *Structural Concrete*, 21(1): 458-467.
 - [37] Naser MH, Naser FH, Dhahir MK. (2020) Tensile behavior of fiber reinforced cement mortar using wastes of electrical connections wires and galvanized binding wires. *Construction and Building Materials*, 264120244.
-