

6144  
7  
45  
48

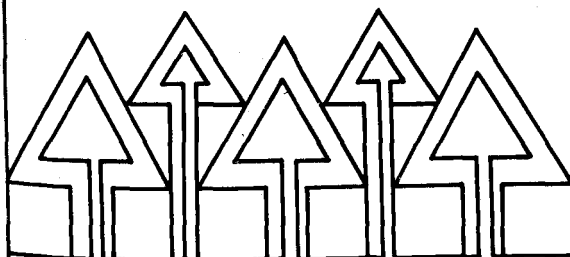

# MARINE WOOD MAINTENANCE MANUAL: A GUIDE FOR PROPER USE OF DOUGLAS-FIR IN MARINE EXPOSURES

JEFFERY J. MORRELL  
GUY G. HELSING  
ROBERT D. GRAHAM



**FOREST RESEARCH LAB**

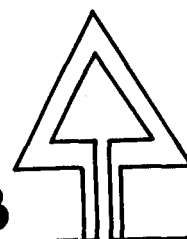

The Forest Research Laboratory of Oregon State University was established by the Oregon Legislature to conduct research leading to expanded forest yields, increased use of forest products, and accelerated economic development of the State. Its scientists conduct this research in laboratories and forests administered by the University and cooperating agencies and industries throughout Oregon. Research results are made available to potential users through the University's educational programs and through Laboratory publications such as this, which are directed as appropriate to forest landowners and managers, manufacturers and users of forest products, leaders of government and industry, the scientific community, and the general public.

As a research bulletin, this publication is one of a series that comprehensively and in detail discusses a long, complex study or summarizes available information on a topic.

## **DISCLAIMER**

The mention of trade names or commercial products in this publication does not constitute endorsement or recommendation for use.

## **TO ORDER COPIES:**

Copies of this and other Forest Research Laboratory publications are available from:

Forestry Business Office  
College of Forestry  
Oregon State University  
Corvallis, Oregon 97331

Please include author(s), title, and publication number if known.

## **THE AUTHORS**

Jeffrey D. Morrell is assistant professor, Department of Forest Products, College of

Forestry, Oregon State University, Corvallis, OR 97331. Guy G. Helsing is president, National Wood Treating Co., P.O. Box 1946, Corvallis, OR 97339. Robert D. Graham is professor emeritus, Department of Forest Products, College of Forestry, Oregon State University.

## **LEGAL NOTICE**

The Forest Research Laboratory at Oregon State University (OSU) prepared this manual with the support of the Sea Grant College Program of OSU. Neither OSU nor Sea Grant nor any person acting on behalf of such: (a) makes any warranty or representation, express or implied, with respect to the accuracy, completeness, or usefulness of the information contained in this report; (b) claims that the use of any information, apparatus, method, or process disclosed in this report does not infringe privately owned rights; or (c) assumes any liabilities with respect to the use of, or for damages resulting from the use of, any information, apparatus, method, or process disclosed in this report.

## **ACKNOWLEDGMENTS**

The authors wish to acknowledge the Sea Grant College Program of Oregon State University (Grant R/CP-18) for providing financial support; John D. Lew, University of California Forest Products Laboratory, for his instructions on culturing fungi from wood; and the American Wood-Preservers' Association for permitting us to reprint its standards. This manual could not have been completed without the careful review and useful suggestions of Dr. Robert A. Zabel, SUNY College of Environmental Science and Forestry, Syracuse, New York; Dr. Thomas O'Neill, Naval Construction Battalion Center, Port Hueneme, California; and Paul F. Coyne, Manager, Port of Siuslaw, Florence, Oregon. We appreciate their efforts to make this manual a more useable tool for marine wood maintenance.

---

# **MARINE WOOD MAINTENANCE MANUAL: A GUIDE FOR PROPER USE OF DOUGLAS-FIR IN MARINE EXPOSURES**

**JEFFERY J. MORRELL  
GUY G. HELSING  
ROBERT D. GRAHAM**

# **CONTENTS**

---

- 4 FOREWORD**
- 4 INTRODUCTION**
- 5 BACKGROUND**
- 5 CHARACTERISTICS OF DOUGLAS-FIR WOOD**
  - 7 DURABILITY**
  - 7 DENSITY**
  - 7 MOISTURE CONTENT**
  - 8 PERMEABILITY**
  - 9 SHRINKAGE AND CHECKING**
  
- 10 PROPER DESIGN AND CONSTRUCTION**
  - 10 KEEP THE WOOD DRY**
  - 10 USE PRESERVATIVE-TREATED WOOD**
  - 10 AVOID LARGE TIMBERS**
  - 10 MAKE FIELD CUTS PRIOR TO TREATMENT**
  - 10 AVOID HANDLING PILES ROUGHLY**
  
- 11 PRESSURE TREATMENT BEFORE INSTALLATION**
- 12 WOOD-INHABITING ORGANISMS**
  - 12 MARINE BORERS**
  - 16 WOOD-INHABITING FUNGI**
  - 19 BACTERIA**
  - 19 INSECTS**
  - 19 SEABIRDS**
  
- 20 OTHER WOOD-DAMAGING AGENTS**
  - 20 WOOD-METAL CORROSION**
  - 21 SALT DEGRADATION**
  - 21 CHAFING OF TIMBERS**
  
- 22 DETERIORATION: PATTERNS OF DECAY**
  - 22 DECAY OF PILE TOPS**
  - 22 SEASONING CHECKS AND CRACKS**
  - 22 JOINTS**
  - 22 BOATS**
  - 22 BOLT HOLES**
  
- 23 METHODS OF DETECTING DECAY**
  - 23 SCRAPING DEVICES**
  - 24 PICK TEST**
  - 24 PILODYN**
  - 25 SONIC INSPECTION**
  - 25 INCREMENT BORER**
  - 26 BRACE AND BIT**
  - 26 SHELL-THICKNESS INDICATOR**

- 
- 27 POWER AUGER**
  - 28 SHIGOMETER**
  - 29 MOISTURE METER**
  - 29 CULTURING**
  - 29 X-RAYS**

**29 METHODS OF DETECTING MARINE BORERS**

- 29 INTERTIDAL INSPECTION**
- 29 SACRIFICIAL TEST BLOCKS**
- 30 SONIC TESTING**
- 30 X-RAYS**

**30 INSPECTING**

**31 REMEDIAL TREATMENT AFTER INSTALLATION**

- 31 PRESERVATIVE APPLICATION**
- 32 PILE CAPPING DEVICES**
- 34 BRUSH TREATMENT FOR DECKING**

**34 PREVENTING BORER ATTACK**

- 34 TREATED AND RESISTANT WOOD**
- 35 BARRIERS**
- 35 WOOD REINFORCEMENT**
- 36 CONCRETE REINFORCEMENT**
- 36 PLASTIC WRAPS**
- 37 TREATMENT WITH FUMIGANTS**

**40 PRECAUTIONS**

**42 LITERATURE CITED**

**44 CHECKLIST FOR PILE INSPECTION AND TREATMENT**

**47 APPENDIX A: ADDITIONAL REFERENCES**

**53 APPENDIX B: AMERICAN WOOD-PRESERVERS' ASSOCIATION  
STANDARD C18-77, STANDARD FOR PRESSURE  
TREATED MATERIAL IN MARINE CONSTRUCTION**

**55 APPENDIX C: CULTURING FUNGI FROM WOOD TO DETECT  
EARLY DECAY**

**59 APPENDIX D: SOURCES OF EQUIPMENT AND SERVICE FOR  
PROTECTING POLES**

**60 APPENDIX E: AMERICAN WOOD-PRESERVERS' ASSOCIATION  
STANDARD M4-80, STANDARD FOR THE CARE  
OF PRESERVATIVE-TREATED WOOD PRODUCTS**

# FOREWORD

---

Because of its high strength, renewability, and relatively low cost, Douglas-fir is an ideal choice for many important uses. Properly designed, constructed, and maintained, structures of this wood can provide long service, even in the ocean's harsh environment.

This manual, cosponsored by the Forest Research Laboratory and the Sea Grant College Program of Oregon State University, is a companion to the previously published "Wood Pole Maintenance Manual" (Graham and Helsing 1979). It is directed to inspectors of marine wood and provides basic information on wood

and wood-destroying organisms that harbor-masters, port managers, and maintenance personnel can use in making wise decisions on maintaining the waterfront structures in their charge. Designers and builders may also find this manual helpful in avoiding construction practices that contribute to wood deterioration. The savings could amount to many millions of dollars annually.

You, the well-trained inspector, play a major role in achieving these savings. Early recognition of deterioration leads to more economical repairs and remedial treatments to control the problem.

## INTRODUCTION

---

The West Coast maritime industry includes extensive docks, pilings, and other marine structures, many built with wood. Their sound design and proper maintenance is essential to the safe and economical operation of the industry. To be effective, this maintenance requires efficient inspection programs so that deteriorating structures are both detected and protected before replacement becomes necessary. Inspection of wood structures should be a continuing responsibility of port personnel at about 5-year intervals.

Although detecting badly deteriorated wood is fairly straightforward, determining whether wood is in earlier decay stages is more difficult. The success or failure of the maintenance program will rest squarely upon you, the inspector, and your ability to assess the condition of the wood before serious damage has occurred. This is no easy task.

This manual has been developed in response to the need for information on maintaining wood structures in marine environments. Although it presupposes that the reader is familiar with the care of land-based poles as outlined in the "Wood Pole Maintenance Manual" (Graham and Helsing 1979), it examines in detail the many problems of controlling wood deterioration in maritime settings.

In this manual, you will learn about:

- Wood characteristics of Douglas-fir
- Designs that prevent damage by wood-destroying organisms

- Wood-destroying organisms and evidences of their damage
- Other wood-destroying agents and how to recognize them
- Inspection methods for determining wood condition above and below the waterline
- Remedial treatments for controlling deterioration of wood already in service

After studying this material, you should read the references cited in the text, as well as those listed in Appendix A, so that you can select the inspection and maintenance procedures best suited to the waterfront structures in your charge.

Before inspecting wood structures in place, we recommend that you carefully inspect members removed from service. Pay particular attention to the location of deteriorated areas; these can indicate problems in construction and maintenance that need to be corrected. The best way to learn how to inspect wood in service is to cut up members from sound and failing structures. Cut these members into short sections and longitudinally split each section so that you can see the patterns of preservative penetration, decay, and marine borer attack. Sacrificing a few good members is a small price to pay for a valuable experience that will help you make better-informed decisions later. Informed decisions can save lives and reduce costs; incorrect decisions can endanger lives and waste money.

Finally, as a reminder of the safe practices you should follow when inspecting and treating waterfront structures, we have included a

---

checklist at the end of this manual that can be reproduced and carried by maintenance personnel. And when you have finished reading

this manual, take the time to test your knowledge of waterfront maintenance by reviewing the key words in the Glossary.

---

## **BACKGROUND**

Since people first ventured forth on the seas in wooden ships to fish and trade, they have been accompanied by organisms that feed on and live in wood. The struggle to prevent marine borers and decay fungi from consuming wood used in marine environments has continued, with varying degrees of success, for thousands of years. Nearly 2,000 years ago, builders already knew the importance of keeping wood dry and using durable heartwoods. They were aware of marine borers and decay and attempted to protect wood by treating it with crude extracts and chemicals. As the world drifted into the Dark Ages, even this knowledge was lost, and it was not until the 18th and 19th centuries that the study of wood preservation was revived. This renewed interest was due, in part, to the deterioration of wooden pilings in the dikes protecting Holland and the prevalence of decay and marine borers in the fighting ships of England, whose navy at that time was supreme.

The emergence in the 19th century of creosote, a byproduct of the destructive distillation of coal, helped usher in a renaissance in wood preservation. Noteworthy achievements in this period included the development of pressure-treating with creosote by John Bethel, the development of the germ theory of disease by Pasteur, and improved microscopes that permitted Hartig to associate fungi with wood decay.

In the 20th century, a virtual information explosion has led to effective wood designs and improved protection practices that minimize biodeterioration. This information, however, is of little value unless it is disseminated to architects and engineers who design wooden structures, contractors who build them, and those who own and maintain them. It is especially important that this information be disseminated to those who use wood under the adverse conditions of the marine environment.

---

## **CHARACTERISTICS OF DOUGLAS-FIR WOOD**

Because of its availability, workability with simple tools, and superior strength properties, Douglas-fir is the principal wood used for marine construction in the western United States. This species is not resistant to marine borers or decay fungi, and treatments with preservatives under pressure and heat are required to protect the wood from deterioration. Those with a thorough understanding of wood properties, agents of deterioration, and methods of preventing their attack can design, construct, and maintain Douglas-fir structures to withstand harsh conditions for long periods. Improper use of wood, whether from lack of knowledge or from compromise for short-term economic gain, can result in staggering annual losses to fungal decay, insect damage, and marine borer attack. The U.S. Navy (1965) estimates that damage by these three agents costs \$500 million annually along the coasts of the United States.

The wood of Douglas-fir, which consists of a thin outer zone of whitish sapwood surrounding an inner zone of reddish heartwood (Fig. 1), is described in the "Wood Pole Maintenance Manual" (Graham and Helsing 1979). In Douglas-fir, sapwood thickness increases with tree diameter, ranging from about an inch in small piles to about 2 inches in large ones (Fig. 2).

### **DURABILITY**

Unprotected sapwood of virtually all wood species deteriorates rapidly in warm, moist soil or in salt water. The presence of toxic chemicals renders the heartwood of a few native species resistant to attack by decay fungi and insects and that of a few foreign species resistant to marine borers (Table 1). Most native species, including Douglas-fir,

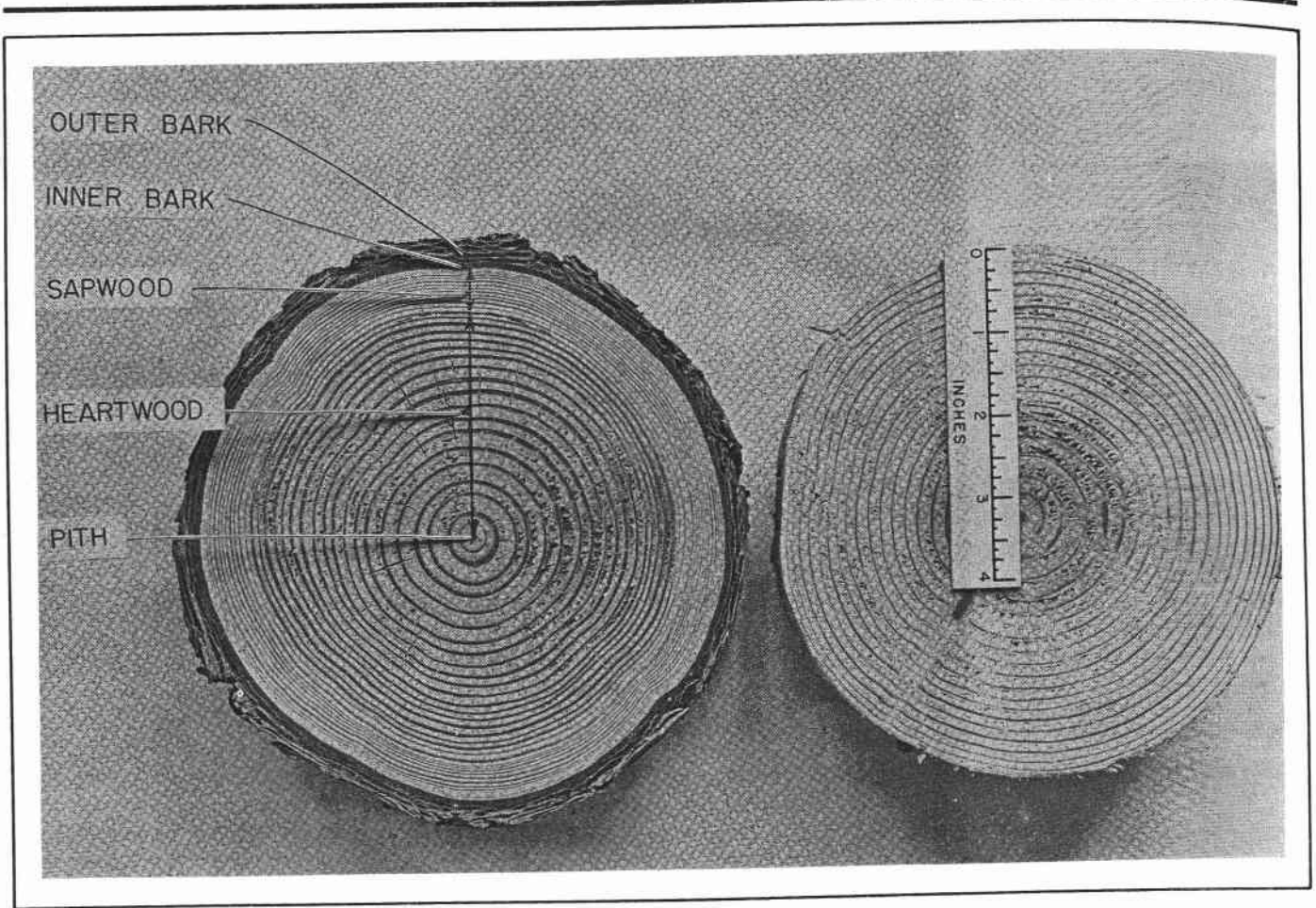

FIGURE 1.  
 VARIOUS PORTIONS OF A DOUGLAS-FIR CROSS-SECTION. FROM GRAHAM AND HELSING (1979).

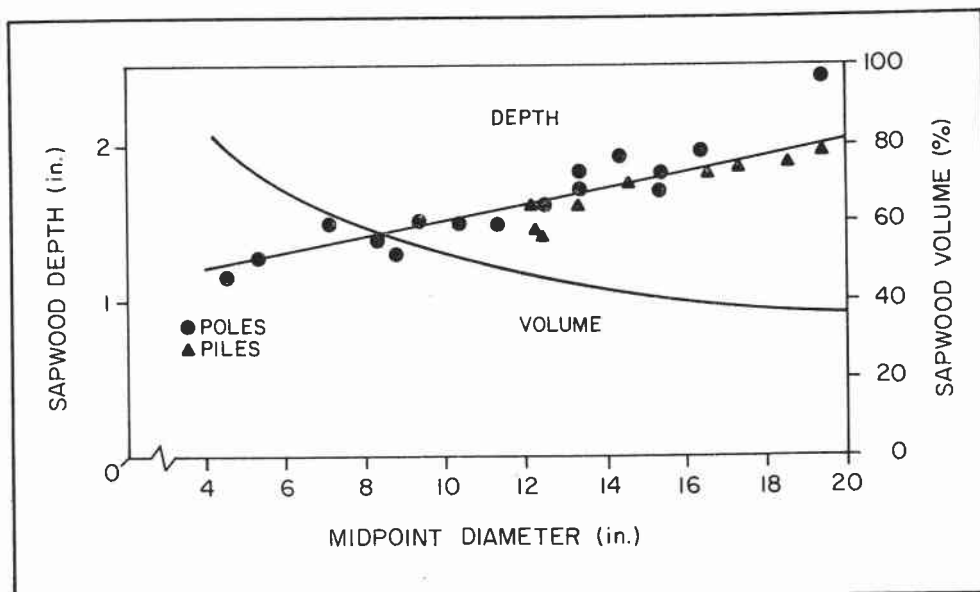

FIGURE 2.  
 VARIATION IN DEPTH AND VOLUME OF SAPWOOD WITH INCREASING POLE DIAMETER OF COAST DOUGLAS-FIR. FROM GRAHAM AND HELSING (1979).



have less durable heartwood. In Oregon coastal waters, Douglas-fir piles may serve a few years when untreated and up to 30 or 40 years when pressure-treated. Greenheart, a tropical timber with heartwood resistant to marine borer attack, lasted only 6 years when used as piling in Oregon marine waters because shipworms became established in the untreated sapwood and then riddled the durable heartwood. Similar damage results if untreated wood susceptible to marine borers is fastened to resistant or preservative-treated wood. The scarcity, expense, and variable performance of resistant timbers have necessitated the increased use of preservative-treated wood of nonresistant species.

TABLE 1.

SOME WOOD SPECIES WHOSE HEARTWOOD IS RESISTANT TO DECAY FUNGI AND INSECTS (\*) OR MARINE BORERS (#). FROM WANGAARD (1953).

Origin		Species and resistance
Foreign	Native to U.S.	
X		Greenheart ( <i>Ocotea rodiaei</i> )#
X		Angelique ( <i>Dicorynia paraensis</i> )#
X		Turpentine wood ( <i>Syncarpia laurifolia</i> )#
X		Lignum vitae ( <i>Gualacum guatamalense</i> )#
	X	Western redcedar ( <i>Thuja plicata</i> )*
	X	Redwood ( <i>Sequoia sempervirens</i> )*#
	X	Pacific yew ( <i>Taxus brevifolia</i> )*
	X	Oregon white oak ( <i>Quercus garryana</i> )*
	X	Alaska-cedar ( <i>Chamaecyparis nootpatensis</i> )*
	X	Black locust ( <i>Robinia pseudoacacia</i> )*
X		Acapú ( <i>Vouacapoua americana</i> )#
X		Manbarklak ( <i>Eschweilera longipes</i> )#
X		Jarraah ( <i>Eucalyptus marginate</i> )#

Even among trees with durable heartwood, resistance to deterioration varies greatly between trees of the same species and within trees. Within a tree, heartwood durability generally decreases with increasing height and with distance outward from the sapwood-heartwood boundary toward the pith. The current timber practice of short rotations results in the use of products with less durable heartwood and thus in the need for preservative treatment.

## DENSITY

Nature designed trees very well: wood with the highest density is in the lower stem where tensile strength is needed, and density

decreases as one nears the top. Wood density also varies between trees within a species because of differences in cell-wall thickness, void spaces, and extractive contents.

At a given moisture content, wood strength increases with wood density. For example, a beam of western redcedar, which has a low density (19 lb/ft<sup>3</sup>), must be larger in diameter than a beam of Douglas-fir, which has a higher density (28 lb/ft<sup>3</sup>), in order to support the same load. This property must be considered in design of marine structures, especially when heavy loads are involved, and may also be a factor in the driving and setting of piles.

## MOISTURE CONTENT

Moisture content of wood and its determination have been discussed in the "Wood Pole Maintenance Manual" (Graham and Helsing 1979). Basically, moisture content (MC) of wood is expressed as a percentage of the wood's oven-dry weight (water-free) weight. For the convenience of the reader, the calculations are reprinted from the previous manual:

$$MC = \frac{\text{initial weight}}{\text{oven-dry weight}} - 1 \times 100$$

or

$$MC = \frac{\text{initial weight} - \text{oven-dry weight}}{\text{oven-dry weight}} \times 100$$

For example, if 1 ft<sup>3</sup> of Douglas-fir sapwood weighs 60.2 lb and its oven-dry weight is 28.0 lb, the calculations would be:

$$MC = \frac{\text{initial weight}}{\text{oven-dry weight}} - 1 \times 100$$

$$= \frac{60.2}{28.0} - 1 \times 100$$

$$= 115\% \text{ MC}$$

or

$$MC = \frac{\text{initial weight} - \text{oven-dry weight}}{\text{oven-dry weight}} \times 100$$

$$= \frac{60.2 - 28.0}{28.0} \times 100$$

$$= 115\% \text{ MC}$$

## PERMEABILITY

The ability of liquids to move through wood cells is of great importance in treating wood and in designing wood structures. Wood is much more permeable to fluids through the end grain than through side grain. Thus, structures in which end grain is placed in exposed positions will result in wetter wood than will those in which side grain is exposed. Because they contain extractives and tyloses that may plug pores and other openings, heartwoods are generally less permeable than sapwood and some are virtually impermeable.

The permeability of Douglas-fir heartwood varies according to geographic source. Six-inch-long blocks of coast Douglas-fir heartwood can frequently be completely penetrated from the ends by pressure treatment with creosote, whereas those of heartwood from trees grown in the interior are nearly impermeable (Fig. 3).

Douglas-fir logs used as floats for docks gradually sink as water penetrates from the ends. Water movement radially into coast Douglas-fir was restricted to the outer 1 to 2 inches in both untreated piles in service

for 12 years and creosote-treated piles in service for 30 years (Fig. 4).

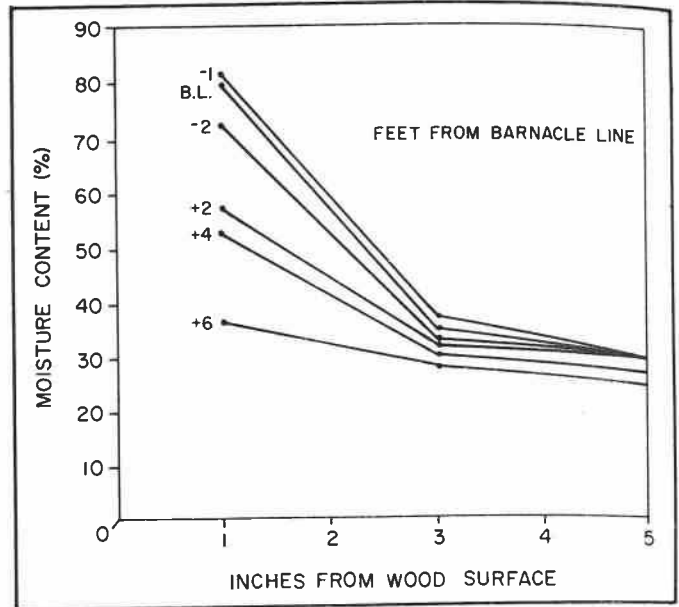

FIGURE 4.

MOISTURE CONTENT OF CREOSOTE-TREATED MARINE PILING AT VARIOUS DISTANCES FROM THE BARNACLE LINE AND DEPTHS FROM THE WOOD SURFACE.

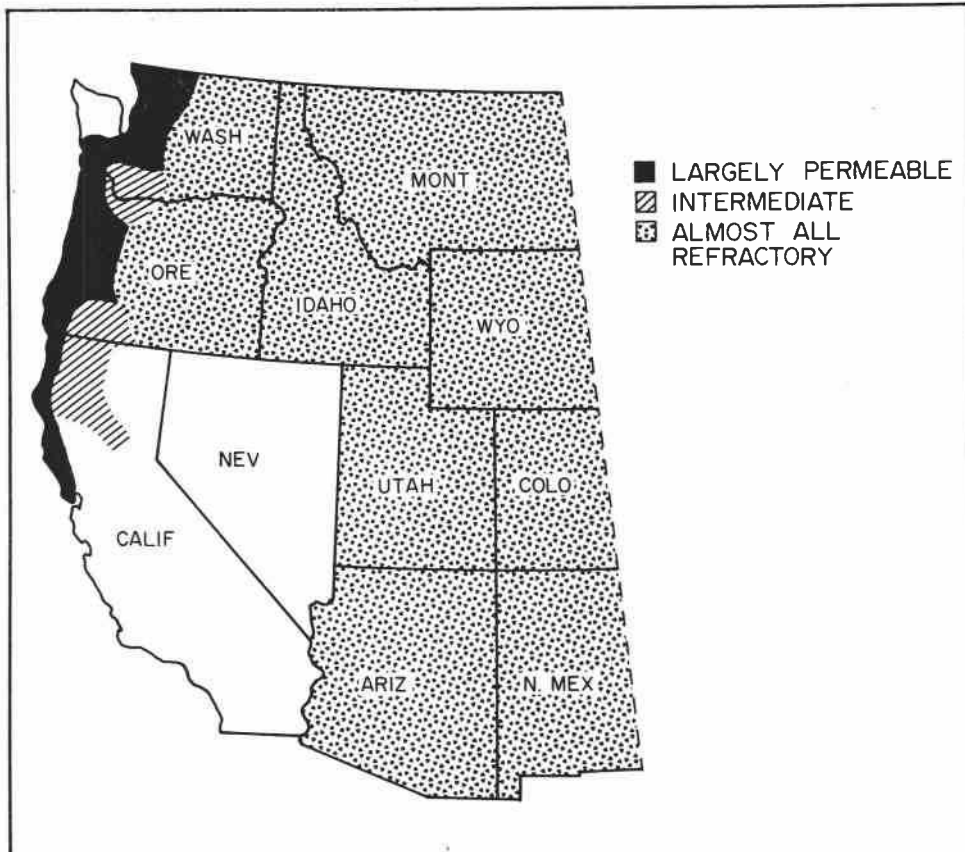

FIGURE 3.

HEARTWOOD PERMEABILITY OF DOUGLAS-FIR VARIES WITH GEOGRAPHIC SOURCE. GENERALLY, COASTAL SOURCES ARE PERMEABLE, CASCADE MOUNTAIN SOURCES ARE MODERATELY IMPERMEABLE, AND INTERMOUNTAIN SOURCES ARE IMPERMEABLE (REFRACTORY). FROM GRAHAM (UNDATED).

## SHRINKAGE AND CHECKING

When freshly cut timbers dry or season, they lose water initially from the surface and then at increasing depths so that a moisture gradient is formed. As the wood declines in moisture content below 30 percent, it begins to shrink and check. While drying to a moisture content of 12 percent, a typical piece of Douglas-fir shrinks about 3 percent across the growth rings (radially), 4 percent along the rings (tangentially), and 0.1 percent along the length of the timber. Because wood shrinks more along than across the growth rings, numerous small V-shaped checks form near the wood surface as it dries. As the interior of the wood dries, many small surface checks close, but one or more of these checks may widen and penetrate deep into the wood (Fig. 5). Timbers containing heartwood from the center of the tree are especially susceptible to deep checks. Shrinkage tends to increase with increasing wood density. Although deep checks to the center indicate a well-seasoned pole, numerous small checks do not necessarily indicate a poorly seasoned one,

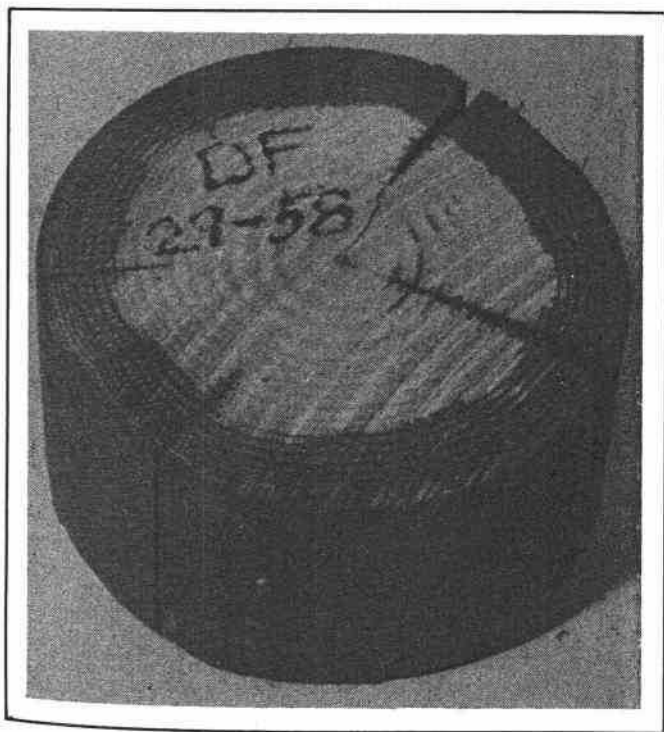

FIGURE 5.

CROSS-SECTION OF DOUGLAS-FIR WITH SEVERAL DEEP CHECKS THAT FORMED AS THE WOOD DRIED AFTER PRESERVATIVE TREATMENT.

because some timbers check very little as they dry.

Although dry wood is easier to treat with preservatives (to be discussed later), even under ideal conditions large round or sawn timbers (greater than 5 inches in width) require excessively long kiln drying (Graham and Womack 1972) or air-seasoning (2 years or more). As a result, large timbers are preservative-treated and placed into service while still at relatively high internal moisture contents. As they season, these timbers may develop deep checks, which will eventually expose untreated interior wood to potential attack by wood-destroying organisms (Fig. 6). Dissection of many timbers has shown the unreliability of visibly assessing the exposure of untreated wood in checks as well as the inaccuracy of probing their depth with a thin blade. These techniques will provide only a partial measure of check depth and do not separate checks that expose untreated wood from those that do not.

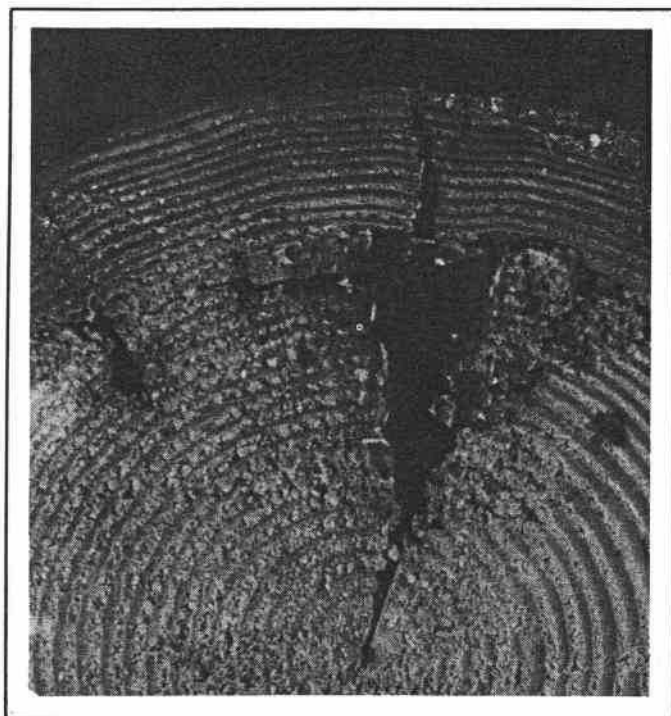

FIGURE 6.

NARROW CHECKS THAT DEEPENED AFTER PRESERVATIVE TREATMENT, EXPOSING THE UNTREATED HEARTWOOD OF THIS DOUGLAS-FIR PILE TO ATTACK BY DECAY FUNGI. FROM GRAHAM AND HELSING (1979).

# PROPER DESIGN AND CONSTRUCTION

Knowledge of wood characteristics is to no avail if it is not supplemented by familiarity with proper design and construction practices. Frequently ignored fundamentals of good design and construction include the following:

## KEEP THE WOOD DRY

Wood below the fiber saturation point is not attacked by most fungi. Dryness is best achieved by structures designed to shed water, drain water away rapidly, prevent water from collecting on or in the wood, and protect cut off ends of timbers.

## USE PRESERVATIVE-TREATED WOOD

Whenever possible, select wood that has been pressure-treated with preservatives. If feasible, order timbers cut to length, shaped for attachments, and drilled for bolts prior to pressure treatment with a preservative appropriate for the site.

## AVOID LARGE TIMBERS

Instead of selecting one large, sawn, treated timber, bolt together two or more narrow timbers in which bolt holes have been drilled before treatment. Large timbers are more susceptible to checking.

## MAKE FIELD CUTS PRIOR TO TREATMENT

During construction, cuts and bolt holes frequently expose untreated wood (Fig. 7). These areas become ideal sites for colonization by decay fungi above the waterline and marine borer attack below. Cutting and drilling prior to preservative treatment, a common practice of electric companies, is the most effective long-term solution for this problem. Capping the cut ends with water-impermeable barriers such as coal tar-cement in a fiberglass patch can also effectively protect wood when field cuts must be made. Drilling bolt holes smaller in diameter than the bolt being used is an old but excellent practice for preventing decay and marine borer attack in these zones.

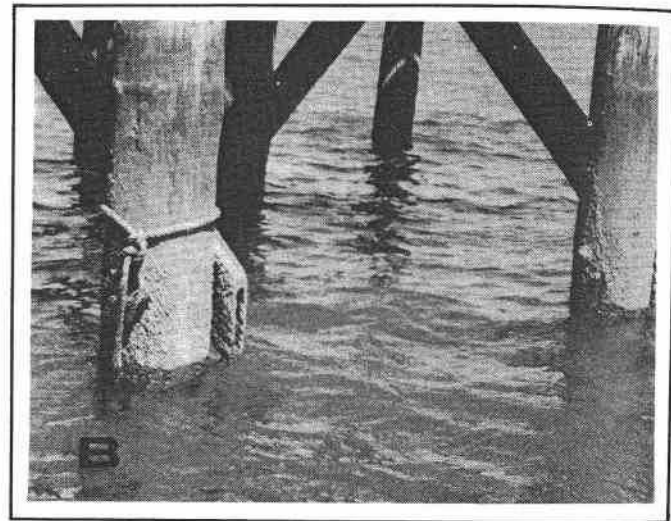
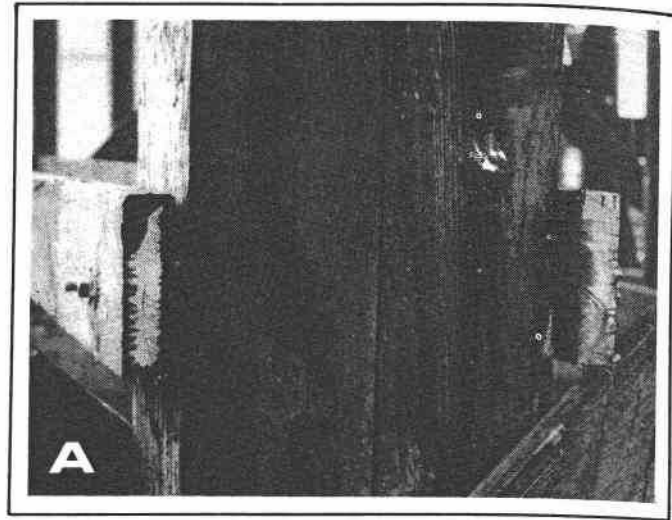

FIGURE 7.

A: DURING CONSTRUCTION, WOOD BRACING IS OFTEN CUT, EXPOSING THE UNTREATED WOOD WITHIN TO DECAY FUNGI OR INSECTS ABOVE THE WATERLINE. B: BELOW THE WATERLINE, SUCH SITES BECOME IDEAL ENTRY POINTS FOR MARINE BORERS.

## AVOID HANDLING PILES ROUGHLY

Rough handling can cause damage that exposes untreated wood. Such damage is especially common when piles are handled with pointed tongs that pierce the treated shell, creating entry points for marine borers. Dragging piles before they are driven and dumping rip-rap about them can damage the treated shell.

# PRESSURE TREATMENT BEFORE INSTALLATION

Before installation in a structure, sawn timbers and pilings of Douglas-fir should be pressure-treated with preservatives according to the standards of the American Wood-Preservers' Association (1983) or the latest revision of federal specification TT-W-571 (U.S. Department of Defense 1974), which are usually identical. The technical details of procuring properly treated wood for various uses and geographic locations are discussed in a very helpful Forest Service publication (Gjovik and Baechler 1977).

Material intended for marine construction should be treated according to American Wood-Preservers' Association (AWPA) standard C18-77 (Appendix B), which summarizes the specific treating requirements for various marine exposures. Because it is not economical to season large timbers completely before pressure treatment, timbers usually are treated at higher moisture contents and gradually season after being placed in service. This is not a problem below the waterline because wood in this zone remains swollen. However, wood above the waterline continues to season and shrink, and it may develop deep checks that expose untreated wood to decay fungi and insects (Fig. 6).

One method used to reduce the development of deep checks after treatment involves sawing a kerf to the center of the timber prior to preservative treatment (Graham 1973, Helsing and Graham 1976, Ruddick and Ross 1979) (Fig. 8). This kerf creates a well-treated, deep check. A full-length kerf to the center has been found to prevent deep checks in Douglas-fir crossarms (Graham and Estep 1966), cross-ties, and guardrail posts (Chandler 1968). In horizontal members, care should be taken to ensure that the kerf is oriented downward to prevent water from collecting. Strength loss as a result of kerfing is minimal except where spiral grain is excessive.

Because of the difficulty of penetrating Douglas-fir heartwood with preservative, the use of incising prior to preservative treatment is necessary to meet the AWPAs requirements on preservative penetration and retention (Appendix B). Incising exposes the ends of the tracheids, permitting more preservative to flow along the wood grain. It aids penetration in coast Douglas-fir but not in interior Douglas-fir from east of the Cascade Mountains (Miller and Graham 1977). Service-

ability of transmission poles is improved by drilling parallel rows of holes through the groundline zone (Graham et al. 1969) or by making numerous 2.5-inch-deep slits at the groundline or full length (Best and Martin 1969). Because bending strength is largely determined by the outer circumference of the wood, incising can help ensure the presence of a thick shell of preservative-treated wood to support loads even if the untreated wood inside the structure decays (Fig. 9). When designing with incised timber, be sure to allow for a 10 to 15 percent strength loss; slightly larger timber may be required.

A wise precaution, especially with large quantities of pressure-treated wood, is to have an independent inspector determine if the material and its preservative penetration and retention meet the AWPAs standards for the intended use. The inspection involves appraisal of the external condition of the timbers for deformities and damage, removal of increment cores for field measurement of preservative penetration, and laboratory determination of preservative retention.

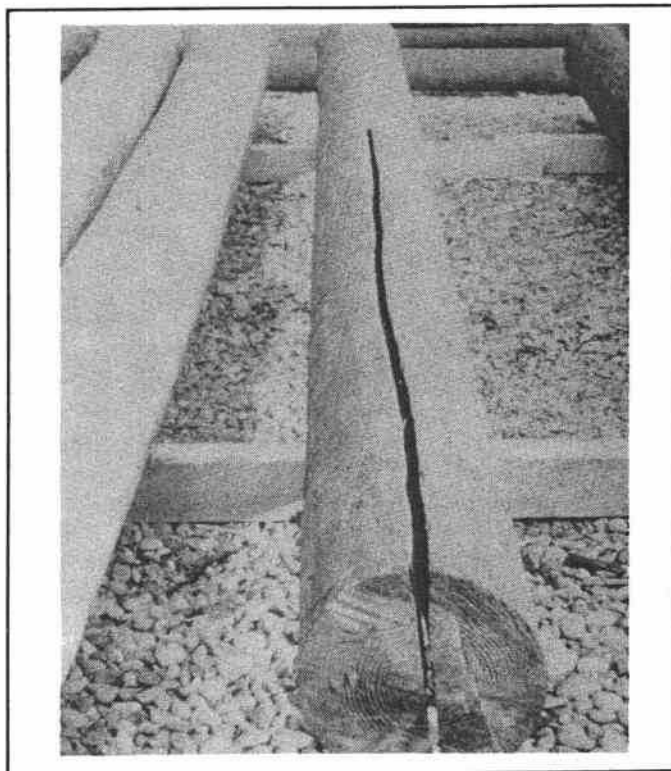

FIGURE 8.

MAKING A SAW KERF TO THE CENTER AND ALONG THE LENGTH OF THE TIMBER BEFORE PRESSURE TREATMENT CAN EFFECTIVELY LIMIT THE AMOUNT OF CHECKING AND REDUCE THE CHANCE OF DECAY.

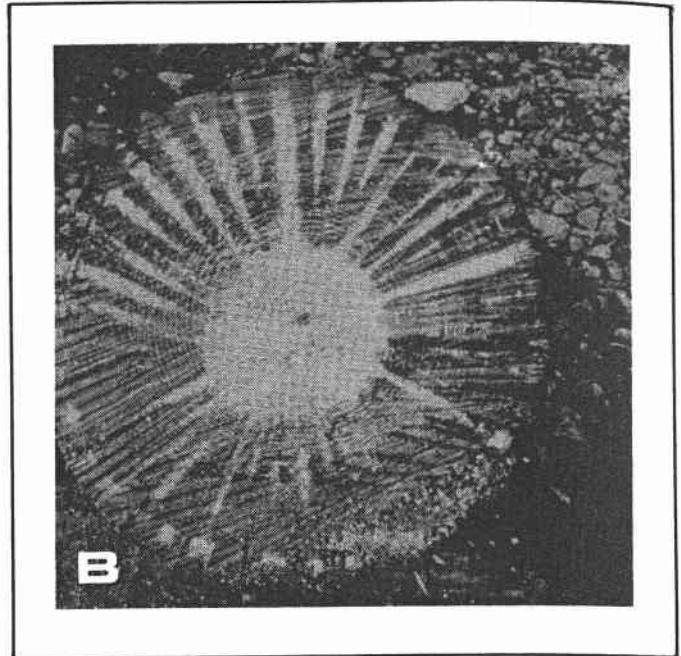
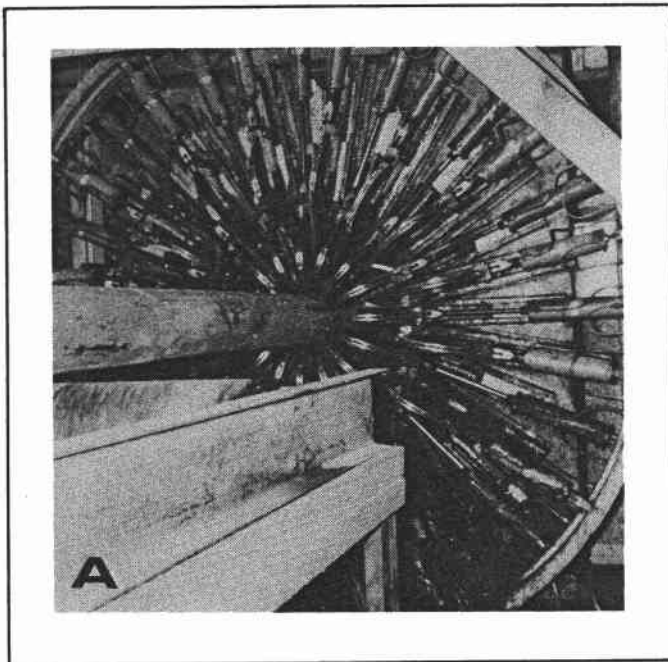

FIGURE 9.

A: INCISING TEETH ARE FORCED INTO PILES AND CUT END-GRAIN. B: EXPOSING END-GRAIN BY DRILLING SEVERAL HOLES INTO THE PILE ALLOWED PRESERVATIVE TO PENETRATE FOR SEVERAL INCHES.

## WOOD-INHABITING ORGANISMS

Wood-inhabiting organisms include the broad categories of marine borers, fungi, bacteria, insects, and--to speak loosely--seabirds.

### MARINE BORERS







Three groups of marine borers are of major economic importance in West Coast waters--gribbles, shipworms, and pholads (Fig. 10). Each differs in its biology and in the type of damage it causes. Although mariners consider them enemies, these organisms play a major role in carbon and nutrient cycling by breaking down driftwood into its components.

#### LIMNORIA

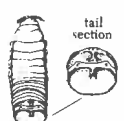
Gribbles, which are members of the genus Limnoria, are destructive crustaceans that burrow into the wood surface. Unlike other marine borers, gribbles are free-swimming and can move from infested to sound pieces of wood, which are apparently used for food as well as shelter. As waves and debris wear

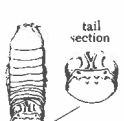
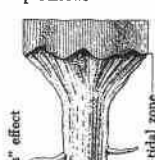
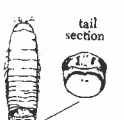
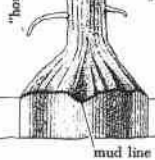
away the weakened wood, these organisms burrow deeper into the sound wood beneath. Although gribbles burrow to only a shallow depth, collectively they can reduce pile diameter by 1 inch per year. Thus, gribble-infested piles typically have an hour-glass shape at the tide line (Fig. 11). In general, gribble attack is accelerated in warm, tropical waters, where breeding occurs year-round, and slowed in cooler northern waters, where breeding is seasonal.

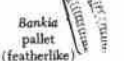
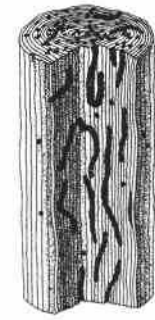
Three major species of Limnoria exist in West Coast waters--L. tripunctata, L. quadripunctata, and L. lignorum. Because of their small size (1/8 to 1/4 inch long) and similar appearances, species of Limnoria are not easily distinguished without the aid of a trained taxonomist. Limnoria tripunctata is of most interest because it can attack creosote-treated wood in exposures southward from San Francisco Bay, California. Although it is found in estuaries as far north as the Straits of Georgia northwest of Puget Sound, in these areas it is apparently incapable of

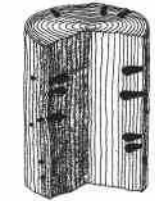
Popular and generic names	Appearance	Geographical distribution	Wood-damage characteristics	To detect presence	To prevent attack	To stop attack
<b>Gribbles</b> <i>Limnoria lignorum</i> (Rathke)	$\frac{1}{4}$ to $\frac{1}{2}$ inch (3 to 6 mm) long; no tubercles. 	Found principally in cold waters of North America, generally north of San Francisco Bay.	Attacks untreated wood. 	At low tide, check wood for thinning, accompanied by a network of interlacing tunnels, each $\frac{1}{8}$ inch (1.5 mm) in diameter, usually not deeper than $\frac{1}{4}$ inch (12 mm).	Where attack of creosoted wood is not prevalent: 20 to 25 lbs of marine-grade creosote or creosote-coal tar per cubic foot of wood or 2.5 lbs of ACA or CCA per cubic foot of wood. Where attack of creosoted wood is prevalent: Dual treatment* or 2.5 lbs of ACA or CCA per cubic foot of wood.	
<i>Limnoria quadripunctata</i> Holthuis	$\frac{1}{4}$ to $\frac{1}{2}$ inch (3 to 6 mm) long; 4 tubercles. 	Inhabits temperate water.	$\frac{1}{4}$ - to $\frac{1}{2}$ -inch (6- to 12-mm) deep burrows. 	Attacks untreated wood.		
<i>Limnoria tripunctata</i> Menzies	$\frac{1}{4}$ to $\frac{1}{2}$ inch (3 to 6 mm) long; 3 tubercles. 	Present as far north as the Straits of Georgia. Attack on creosoted wood is prevalent from San Francisco Bay south.	Attacks untreated and creosoted wood. 			
<b>Shipworms</b> <i>Teredo navalis</i> Linné	Adults can grow 1 to 2 feet (30.5 to 70 cm) long; $\frac{1}{4}$ -inch (12-mm) diameter. 	Warm seawater, San Francisco Bay and south, but also in some British Columbia localities. Can withstand lowest salinity of all borers, reportedly as low as 5 parts per 1000 (seawater is 30 to 35 parts per 1000).	Usually, little external evidence can be found to indicate shipworm attack. Entrance holes remain $\frac{1}{16}$ inch (1.5 mm) or less in diameter while this clam's body enlarges as it enlarges its burrow. 	1. Sounding devices used by divers can detect damage in 25% increments. 2. Immerse untreated wood test panels and cut up at monthly intervals to see if borers are present. Remember: wood floats, so attach a sinker.	1. 20 to 25 lbs of marine-grade creosote or creosote-coal tar per cubic foot of wood. or 2. 2.5 lbs of ACA or CCA per cubic foot of wood.	OR 2. Reinforce pile with a concrete jacket.
<i>Bankia setacea</i> Tryon	The major shipworm north of San Francisco. Much more sensitive to salinity changes than <i>Teredo</i> , so many northern estuaries are free of shipworm attack in their upper reaches. 		Adults can grow 5 to 6 feet (1.5 to 1.8 m) long; $\frac{3}{4}$ -inch (22-mm) diameter. 			
<b>Pholads</b> <i>Martesia striata</i> Linné	2 to 2 $\frac{1}{2}$ inches (50 to 63 mm) long; 1-inch (25.4-mm) diameter. 	Inhabits tropical waters; a severe problem in both untreated and inadequately treated wood in Hawaii and off the Mexican coastline. They also burrow into rock.	Unlike the shipworm's, the size of the entrance hole increases to about $\frac{1}{2}$ inch (6 mm), making it possible to notice their presence. 	1. Look for entrance holes. 2. Sounding devices used by divers can detect damage before the item is destroyed.	1. 20 to 25 lbs of marine-grade creosote or creosote-coal tar per cubic foot of wood. or 2. Dual treatment.	

DRAWINGS BY DONNA KLENZ

FIGURE 10.

THE THREE GROUPS OF MARINE BORERS: HOW TO RECOGNIZE THEM AND PREVENT THEIR ATTACK. FROM HELSING (1979, REV. 1981). REPRINTED WITH PERMISSION FROM OREGON STATE UNIVERSITY EXTENSION SERVICE.

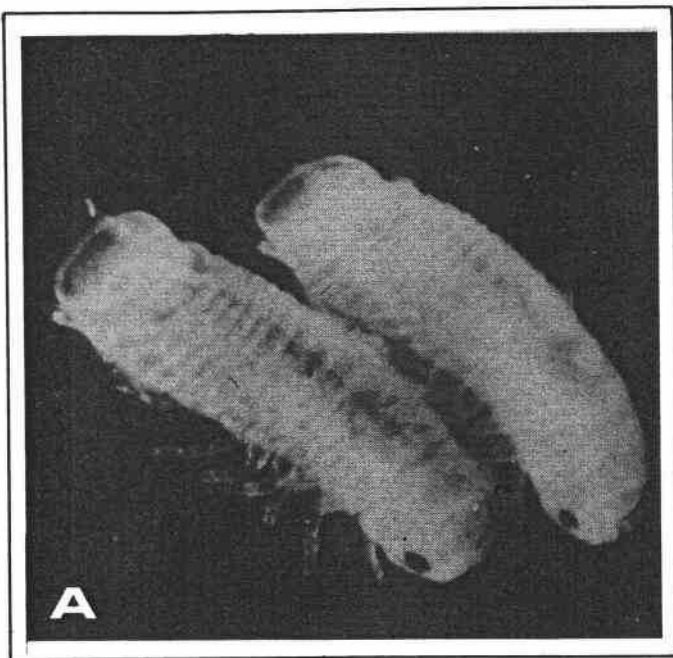

attacking wood properly treated with creosote. Studies of differences between L. tripunctata populations in northern and southern bays and between environmental conditions in the two areas may provide clues leading to safer, more effective control measures.

Limnoria quadripunctata and L. lignorum also commonly occur in marine waters of the Pacific Northwest. However, in the absence of attack by L. tripunctata, they can be effectively controlled by the use of wood pressure-treated with creosote.

Detection of Limnoria damage requires examination of the wood for diameter reductions associated with networks of 1/6-inch-diameter tunnels penetrating only a short distance into the wood. These inspections are most easily accomplished at low tide, from a small skiff or by wading.

#### SHIPWORMS

A shipworm is a clam-like mollusk that burrows deeply into submerged wood by rasping with a pair of finely serrated shells on its head (Fig. 12). Although piles attacked by shipworms may appear sound on the surface, they may be completely riddled with a maze of tunnels.

The two major species of shipworms--Teredo navalis and Bankia setacea--have different hydrological (water) requirements. The first is found in the warmer waters extending southward from San Francisco Bay. Its ability to withstand broad salinity ranges permits it to survive in the upper reaches of many estuaries. Bankia setacea, on the other hand, is found all along the Pacific coast, but the only estuaries in which it can survive have salinities above 20 parts per 1,000.

Shipworms can spread to new wood only when they are in the free-swimming larval stage. Once they attack and bore into the wood, they become imprisoned within it. Ancient mariners, realizing that shipworms were imprisoned in the wood of their ships, would sail far up river and remain in fresh water for a number of months to kill the shipworms.

Adults of T. navalis range from 1 to 2 feet in length and are about 1/2 inch in diameter, while adults of B. setacea can grow up to 5

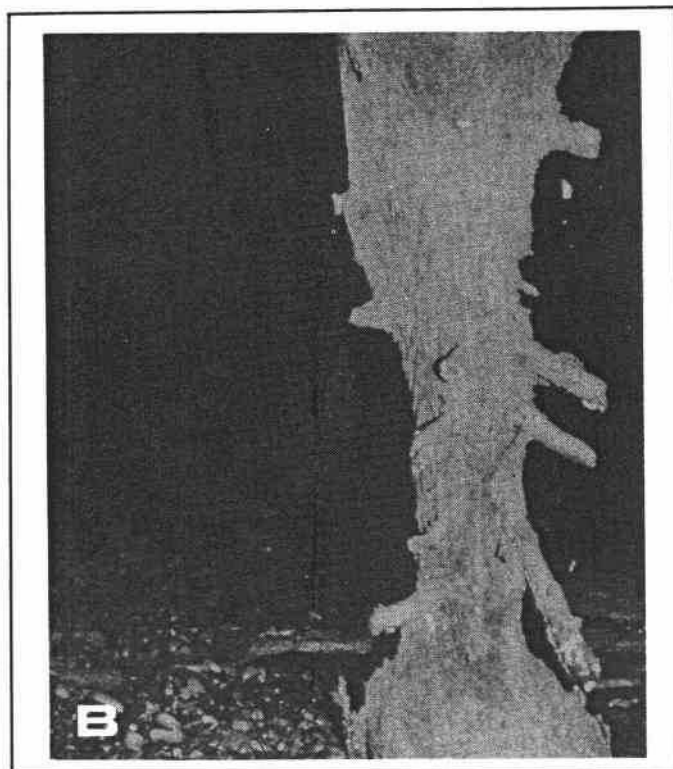

FIGURE 11.

A: LIMNORIA SPP. ARE SMALL, MOBILE CRUSTACEANS THAT FEED ON OR BORE INTO THE WOOD SURFACE. B: SEVERE EXAMPLE OF PILE WITH HOUR-GLASS SHAPE TYPICAL OF ATTACK BY LIMNORIA SPP. AND WAVE ACTION AGAINST THE WEAKENED WOOD.



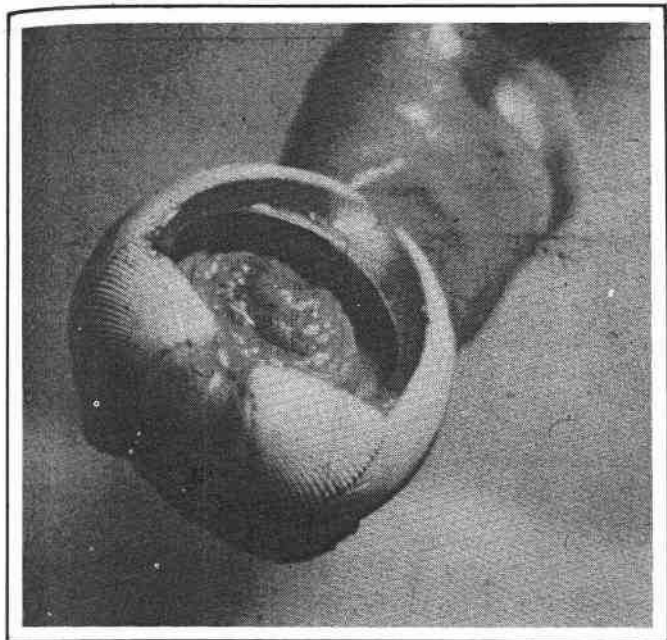

FIGURE 12.

THE HEAD OF A SHIPWORM WITH THE PAIR OF RASPING SHELLS THAT AID IN WOOD BORING. NOTE THE ELONGATED WORM-LIKE BODY EXTENDING INTO THE BACKGROUND.

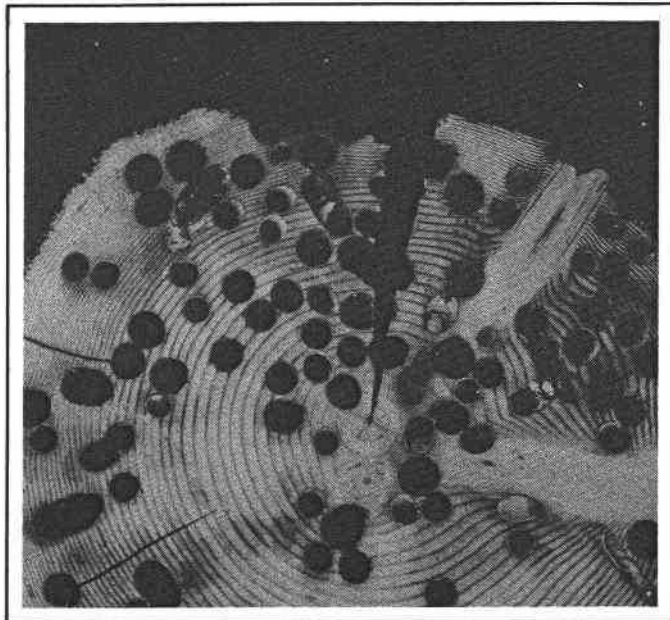

FIGURE 13.

WOOD CROSS-SECTION WITH NUMEROUS SHIPWORM TUNNELS IN THE INTERNAL PORTION OF THE WOOD. THE SURFACE OF THIS PILE WAS ALSO ATTACKED BY LIMNORIA SPP.

to 6 feet long and to a diameter of  $7/8$  inch. As the shipworm grows, its tunnel increases in length, while the entrance hole remains approximately  $1/16$  inch in diameter. Through this entrance hole, the animal extends a pair of siphons that absorb oxygen from surrounding seawater while discharging waste and reproductive products. When danger threatens, the shipworm retracts the siphons and plugs the hole with hardened structures termed pallets.

Because external damage is minimal, detecting shipworm damage is difficult (Fig. 13). Experienced divers look for siphons that project from the wood or use sonic devices to estimate the extent of internal damage. Shipworm and gribble attack can also be detected by immersing untreated wood panels and destructively sampling them at monthly intervals. With this method, regular inspections are necessary.

## PHOLADS

Pholads, rock-burrowing clams, burrow into and damage untreated wood in warmer waters near Hawaii and Mexico. They are also a common sight along Oregon beaches. Although related to shipworms, pholads resemble ordinary clams: their bodies are entirely enclosed within a pair of shells. Like shipworms, these organisms become imprisoned within their burrows after entering wood. Unlike shipworms, however, pholads bore only into the surface, enlarging their pear-shaped burrows as they grow in size (Fig. 14). Because pholads enlarge their entrance holes to a diameter of about  $1/4$  inch, their colonization of wood is more readily detectable than is shipworm attack. Martesia striata is the pholad species most associated with wood attack; adults are 2 to  $2-1/2$  inches long by 1 inch in diameter.

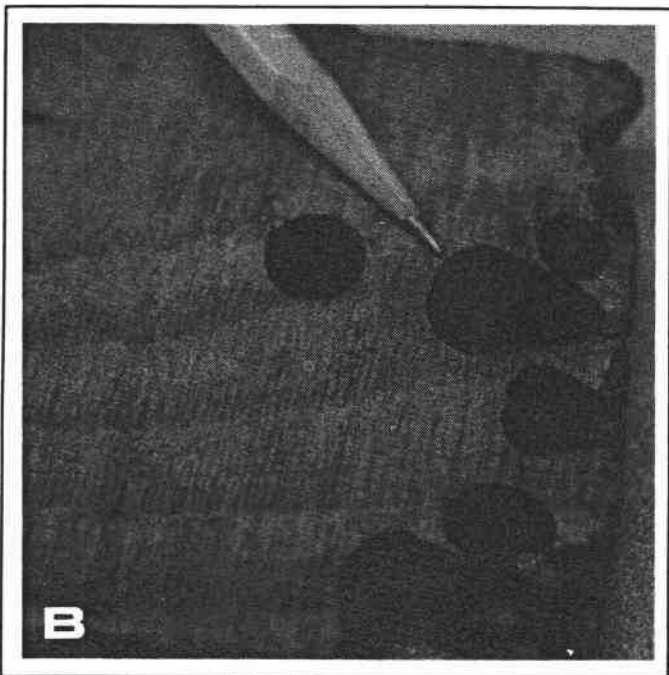
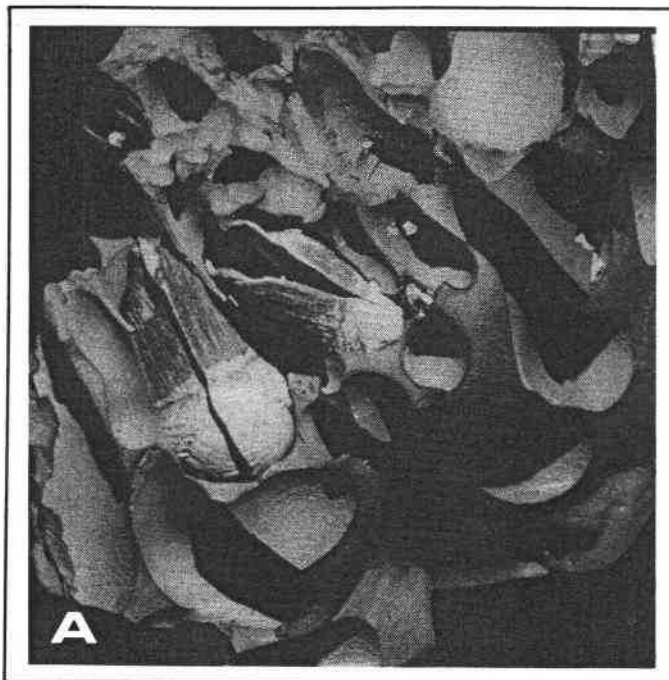

FIGURE 14.

A: PHOLADS ARE FREQUENTLY FOUND BURROWING IN ROCKS ALONG THE OREGON COAST AND CAN ALSO BE FOUND IN WOOD. B: A FAR MORE SERIOUS PROBLEM IN TROPICAL ENVIRONMENTS, PHOLADS FORM PEAR-SHAPED CAVITIES NEAR THE WOOD SURFACE.

## OTHER MARINE WOOD BORERS

In addition to the three groups mentioned above, there are three less economically important genera of marine borers--Sphaeroma spp., Chelura spp., and Xylophaga spp.--along the West Coast. Sphaeroma spp., 3/8-inch-long organisms resembling pill-bugs and related to the genus Limnoria, may be more destructive than we realize. Although their burrows are larger than those associated with attack by Limnoria spp., they burrow just below the wood surface, prefer softer woods, and are less numerous and destructive. Members of the genus Chelura are small amphipods that sometimes browse on wood and feed on the feces of Limnoria spp. By doing so, they help to enlarge and clean the burrows of the other species, increase oxygen flow, and permit deeper burrowing. Borers of the genus Xylophaga are present deep in the Atlantic and Pacific Oceans (2,500 to 6,800 feet) and are believed to burrow into mud on the bottom. They will also colonize wood within 1 to 2 feet of the mud line. Because these genera are of minor economic importance, control measures for them will not be considered.

## WOOD-INHABITING FUNGI

The structural integrity of wood can also be destroyed by certain fungi. These filamentous organisms, which lack chlorophyll, feed on wood to obtain energy. Like all organisms, they require free water, air, favorable temperatures, and nutrients to survive (Fig. 15). Wood with a moisture content below 28 percent (ovendry basis) is usually safe from fungal attack; however, above the 25 to 30 percent fiber saturation point, the cell lumens accumulate free water and most decay fungi can degrade wood. High wood moisture contents (>70 percent) restrict the amount of air in the wood, decrease oxygen levels, and limit fungal growth. Lack of oxygen explains why wood submerged in water or buried underground decays very slowly or not at all.

The temperature requirements of most wood-inhabiting fungi are broad: temperatures below freezing (32°F) inhibit growth but do not kill them. Above freezing, fungal activity increases, peaking at 50 to 80°F and decreasing as temperatures approach 100°F. Most fungi are killed at temperatures above 150°F after brief exposures (Chidester 1935).

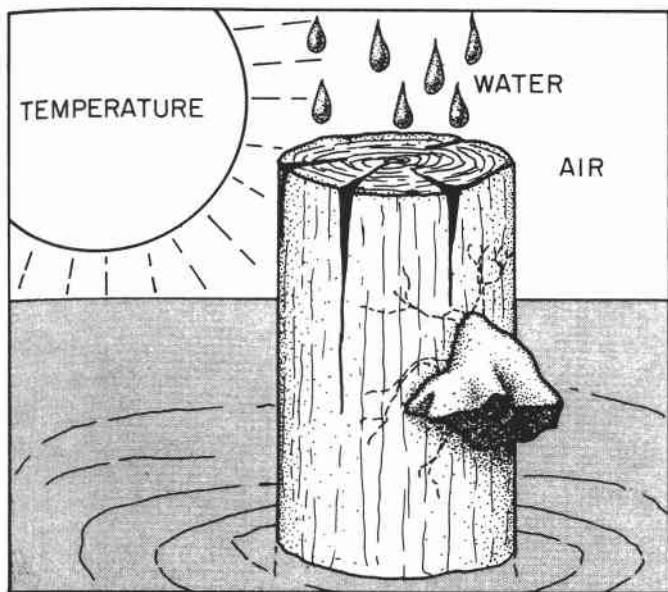

FIGURE 15.

WOOD-DECAY FUNGI, LIKE MOST LIVING THINGS, REQUIRE AIR, MOISTURE, FAVORABLE TEMPERATURES, AND A SUITABLE FOOD AS AN ENERGY SOURCE. FROM GRAHAM ET AL. (UNDATED).

A wide variety of fungi colonize wood. Some fungi digest the wood cell wall, causing decay, but large numbers of fungi colonize wood with little or no effect on its strength properties. These fungi metabolize simple carbon compounds, extractives, or storage cells (parenchyma) with minimal effect on wood. Studies are underway on the interactions between these fungi and on their roles in the decay process, but the complexity of wood and the number of organisms present make such studies exceedingly difficult and time-consuming.

### DECAY FUNGI

Mushrooms and conks are the typical fruiting bodies of decay fungi. Each produces billions of seed-like spores (Fig. 16). Although fruiting structures are the most visible decay indicators, in reality they are the result of an invasion and digestive process that occurs, unseen, under the wood surface in a series of events that may take months or years to complete.

The process begins when a spore lands on a wood surface and, under favorable conditions,

germinates to produce microscopic, tubular cells, called hyphae, which penetrate the wood. As the hyphae move through the wood, they secrete enzymes that dissolve the cell walls (cellulose, hemicellulose, and lignin), transforming the wood into simpler chemicals that the fungus can absorb and use as food.

The term decay describes wood in all stages of fungal attack, from the initial invasion of hyphae into the cell walls to the complete destruction of the wood. Early fungal attack, also termed incipient decay, can only be detected by microscopic examination or, as described in Appendix C, by incubating the wood on nutrient agar and determining whether a decay fungus grows (Fig. 17). If decay fungi can be cultured from wood that appears sound (free of decay), then that wood is considered to be in the incipient stage of decay. During the early stages of decay, some fungi may discolor the wood or substantially decrease its toughness. As decay proceeds, wood becomes brash (breaking abruptly across the grain), loses luster, changes color, and loses strength. Wood that is visibly decayed,

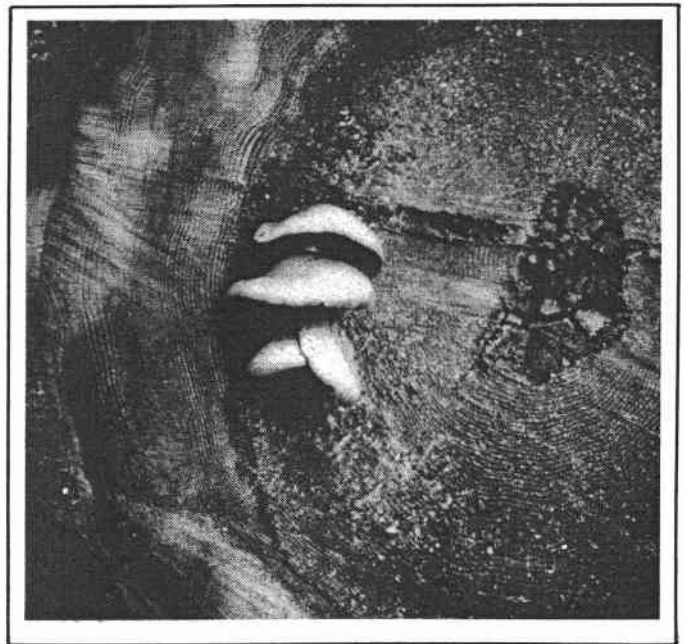

FIGURE 16.

FRUITING BODIES, SUCH AS THE ONES ON THE END OF THIS LOG, MAY BE THE FIRST SIGN OF A DECAY PROBLEM. REMOVING THE FRUITING BODIES WILL NOT PREVENT THE DECAY FROM CONTINUING.

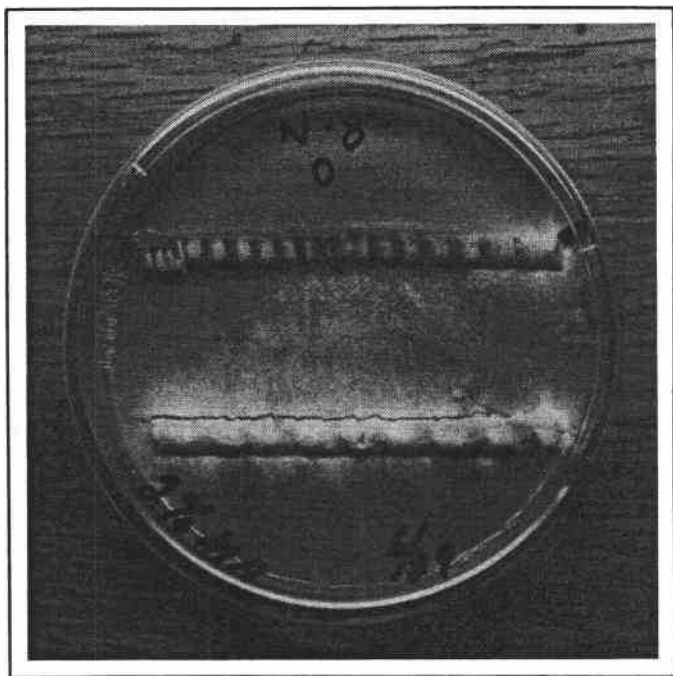

FIGURE 17.

DECAY FUNGUS CULTURED FROM AN APPARENTLY SOUND INCREMENT CORE INDICATES THAT DECAY IS PRESENT. FROM GRAHAM AND HELSING (1979).

greatly weakened, and conspicuously soft or brash is in the advanced stages of decay, which are termed rot.

There are three types of decay: white and brown rots, generally caused by fungi classified as Basidiomycetes, and soft rot, caused by fungi classified as Ascomycetes and Fungi Imperfecti (Fig. 18). Brown rots are so called because of the brown color the wood acquires from the predominantly lignin residue left after fungal metabolism. Such rots occur most commonly on softwoods and are characterized by utilization of the carbohydrate fraction and modification of the lignin. Wood attacked by brown rot fungi has markedly reduced strength even when weight losses are slight; maximum weight losses in such wood often reach 60 to 70 percent. Wood

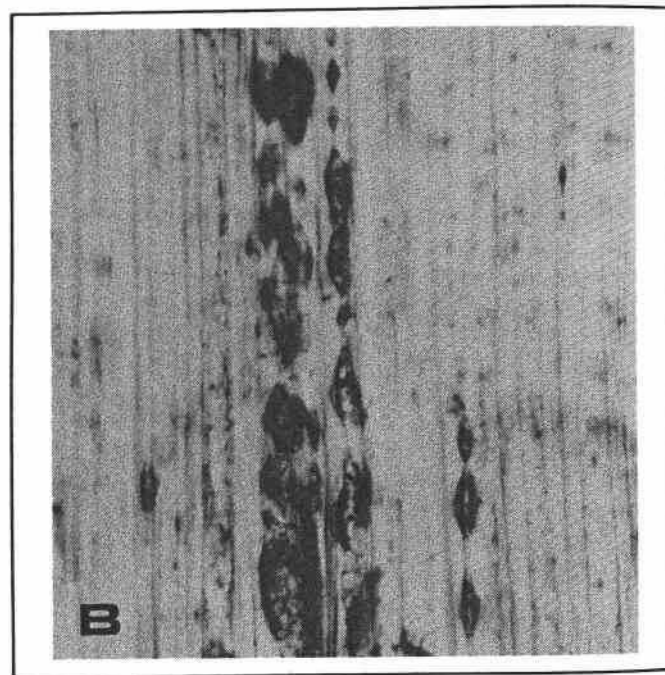
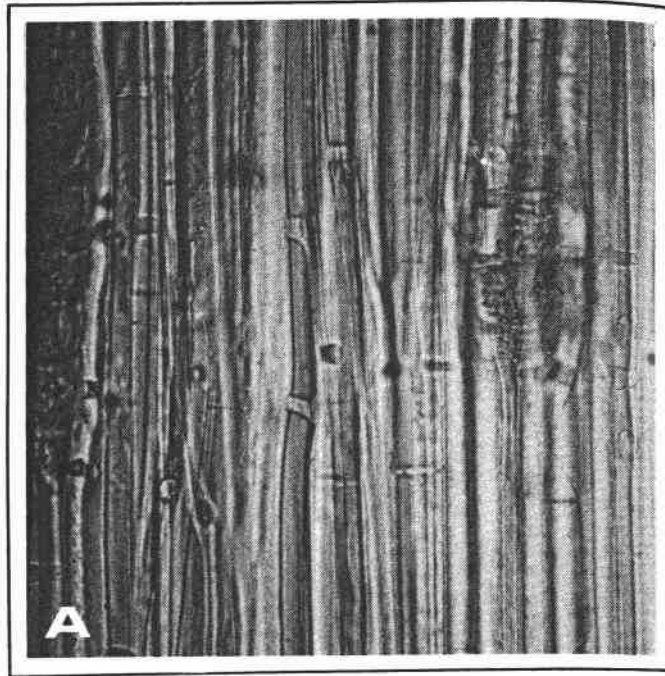

FIGURE 18.

MICROPHOTOGRAPHS OF LONGITUDINAL SECTIONS OF WOOD DAMAGED BY (A) BASIDIOMYCETOUS DECAY FUNGUS AND (B) SOFT ROT FUNGUS. PHOTO A COURTESY OF DR. BARRY GOODSELL, UNIVERSITY OF MAINE, ORONO.

attacked by white rot fungi appears bleached or whitened in the advanced stages of decay because of the predominantly cellulosic residue left after fungal metabolism. Although these fungi cause less loss in strength than do brown rot fungi, they eventually cause weight losses up to 90 percent. Soft rot fungi cause a gradual softening and degradation of the wood surface and are important in areas where high moisture levels restrict attack by brown and white rots. Attack by soft rot, which occurs at high moisture levels, significantly reduces strength properties even when weight losses are slight and can be associated with weight losses up to 60 percent.

## NON-DECAY FUNGI

Numerous non-decay fungi also inhabit the wood above and below the waterline. They feed on cell contents, certain components of the cell wall, and byproducts of decay by other fungi. Frequently, only non-decay fungi can be isolated from wood in advanced stages of decay. These fungi may be responsible for detoxifying preservatives, making wood more permeable to water, and inhibiting slower-growing decay fungi. They may also act as food sources for wood-attacking marine borers. Certain non-decay fungi known as sapstain fungi discolor sapwood blue, brown, or black. Heavily stained wood may be reduced in wood toughness.

## BACTERIA

Other microscopic organisms--bacteria--are also present in wood, especially in the marine environment. While many of their roles in wood deterioration remain unclear, bacteria are known to attack the cell wall, detoxify preservatives, and increase wood permeability. They may also condition wood for decay fungi. Bacteria are highly resistant to many wood preservatives and may aid in colonization of wood by marine borers. One

unusual marine bacterium, *Pseudomonas creosotensis*, is capable of degrading substantial amounts of creosote in warmer climates (O'Neill et al. 1961). As scientists learn more about wood-inhabiting microbes, bacteria will probably be found to play an important role in wood breakdown.

## INSECTS

Wood above the waterline may be attacked by a number of insects, including termites, carpenter ants, and beetles. Characteristic damage by each of these groups has been described in the "Wood Pole Maintenance Manual" (Graham and Helsing 1979).

One beetle that has become increasingly important is the wharf borer, *Nacodes melanura*. This species, which was originally imported from Europe, can attack untreated hardwoods and conifers with moisture contents above the fiber saturation point. Its larvae, which tunnel extensively and leave behind dark brown fecal matter or frass, are invariably associated with decay fungi that further degrade the wood.

## SEABIRDS

Although not inhabitants of wood nor direct factors in the deterioration of marine piles, seabirds may increase the amount of nitrogen in the wood by perching on top of pilings and depositing their unsightly feces on the surface. Because wood normally contains very little available nitrogen, this added nitrogen may stimulate fungal decay. Cutoff tops of piles should be treated with a preservative and capped to prevent the entry of water and nutrients into the wood. Cone-shaped caps can prevent perching (Fig. 19).

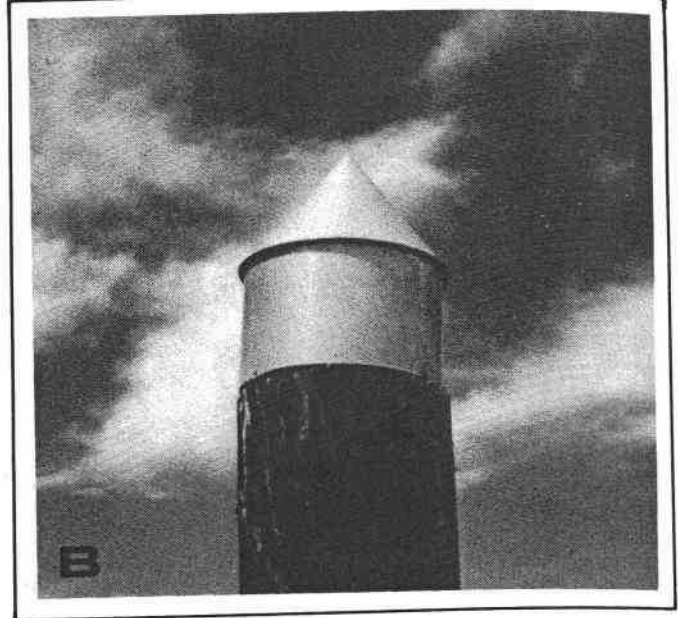
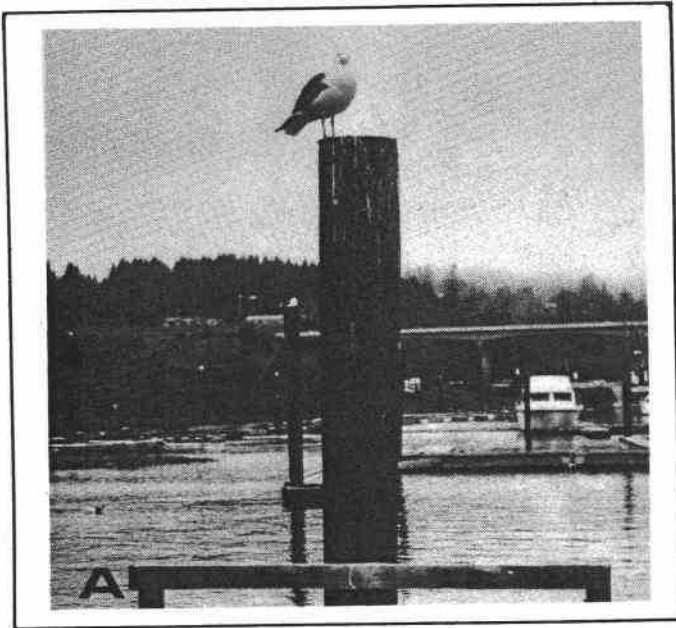

FIGURE 19.

A: SEA GULLS MAY CONTRIBUTE TO DECAY OF PILE TOPS BY INTRODUCING ADDED NITROGEN INTO THE WOOD WITH THEIR DROPPINGS. B: CONE-SHAPED CAPS NOT ONLY KEEP THE PILE DRY BUT ALSO LIMIT PERCHING BY SEAGULLS AND PREVENT THE ACCUMULATION OF DROPPINGS.

## OTHER WOOD-DAMAGING AGENTS

In addition to biological agents that deteriorate wood, there are physical or chemical agents that either damage wood or allow entry of more destructive pests.

### WOOD-METAL CORROSION

Under moist conditions, wood and metal can react chemically so that the wood degrades and the metal corrodes. Dissimilar metals up to several feet apart can form galvanic cells that generate voltage differences, which cause the metal to corrode. Wood near the metal providing the electrons to the cell (anode) becomes "pulped" by the production of sodium hydroxide and appears to be brown-rotted. Conversely, the wood near the metal that is capturing electrons (cathode) becomes exposed to hydrochloric acid and appears to be bleached or white-rotted. These processes

are accelerated in salt water and are common in boats without a sufficient amount of sacrificial zinc protection (Mallon and Kilbe 1979). Leakage of electricity in boats accelerates the corrosion process. The presence of white crystals and a bitter taste to the wood around the metal are sure signs of wood-metal corrosion. The absence of fungi in wood cultured from these areas, in conjunction with pH measurements, can confirm the source of damage. An annotated bibliography of wood-metal corrosion is available (Graham et al. 1976).

### SALT DEGRADATION

Alternate wetting and drying with salt water or leaching of salt stored on wood sometimes leads to accumulation of salt crystals within wood tracheids. Eventually, this buildup of

crystals may rupture the tracheids. Because the lignin remains unchanged, the wood retains its brownish color but otherwise appears like white-rotted wood. Although the ruffled or fibrous appearance of the wood appears severe, salt degradation generally extends only a few millimeters into the wood.

## CHAFING OF TIMBERS

Damage by chafing of piles from floating debris, boats, and, most importantly, floating docks is common, especially in areas with heavy tidal surges or flows. Floating logs chained in place can fence out large floating debris from under the dock and prevent it from striking the piles, but the logs themselves may chafe piles. Chafing can be especially severe on piles driven at slight angles below floating docks. As the tide level changes, the deck moves up and down against any piles pinching the dock, gradually wearing them away (Fig. 20A). Some anti-chafing devices used with varying success include chains, roller bars, U-shaped bars, sacrificial strips of wood or metal, and rubber tires. One device that appears espe-

cially promising, if installed correctly, is a 4-inch-wide metal collar encircling the pile (Fig. 20B). The metal collar may be made an integral part of the dock (Fig. 20C).

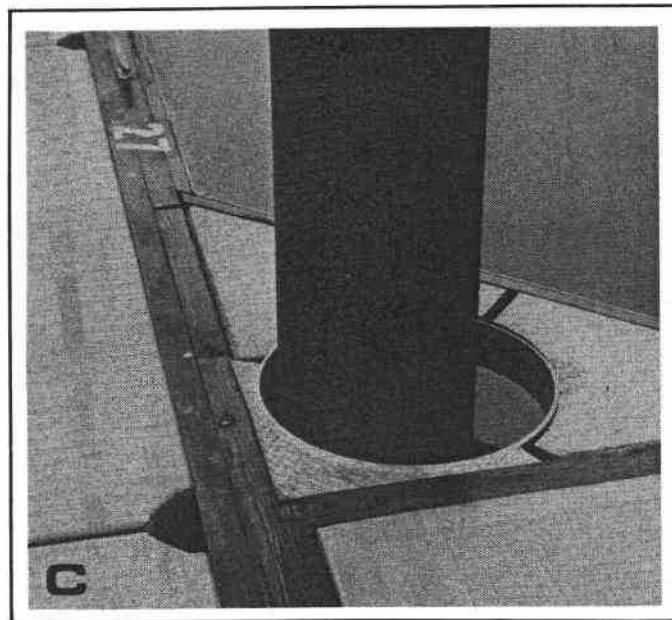
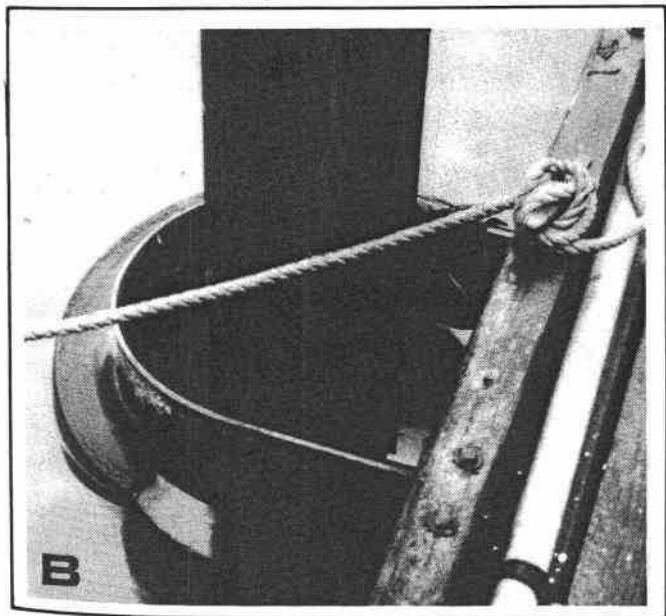
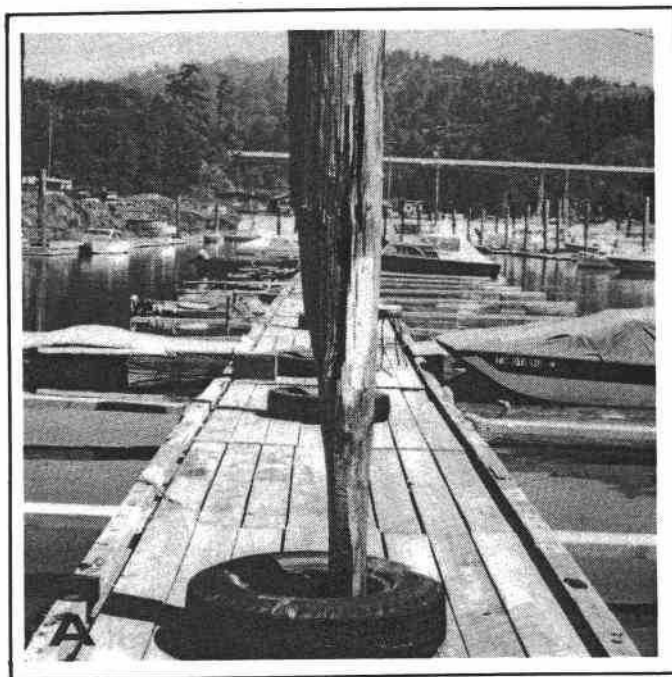

FIGURE 20.

A: CHAFING OF MARINE PILES IS MOST SEVERE WHEN PILES ARE IMPROPERLY PLACED OR IN AREAS OF HEAVY TIDAL FLOWS. B: CHAFING CAN BE PREVENTED BY THE USE OF WIDE METAL COLLARS. C: SUCH COLLARS CAN BE INCORPORATED INTO THE DOCK STRUCTURE.

# DETERIORATION: PATTERNS OF DECAY

Properly treated and handled, wood can last indefinitely under marine conditions. However, wood that is untreated or not used properly is subject to attack by the organisms and agents just described, and the resulting decay forms distinctive patterns that vary according to how the wood is used.

## DECAY OF PILE TOPS

Decay of pile tops results from failure to protect exposed, untreated wood (Fig. 21). It occurs when water accumulates in the tops of cut-off piling. Many pile tops are initially cut at a steep angle, presumably to increase water runoff. Instead, such an angle exposes more untreated surface area, increases decay potential, and makes capping more difficult. Entry of moisture is soon followed by decay fungi and insects.

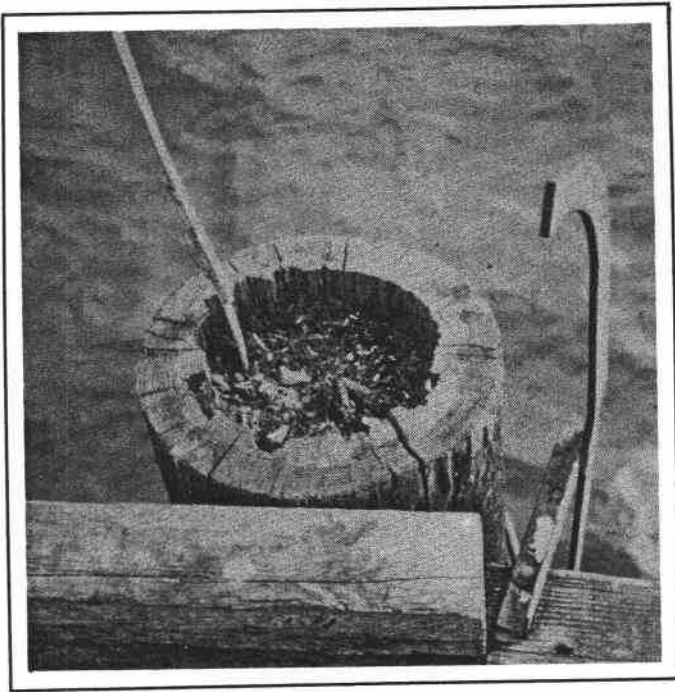

FIGURE 21.  
THE COMMON COASTAL PRACTICE OF CUTTING THE TOP OFF PRESSURE-TREATED PILING EXPOSES UNTREATED HEARTWOOD TO DECAY FUNGI AND OFTEN RESULTS IN A HOLLOW PILE TOP.

## SEASONING CHECKS AND CRACKS

Piles and large sawn timbers that are pressure-treated at high internal moisture con-

tents and exposed to drying conditions in service can develop deep checks that penetrate below the treated shell. Along the Oregon coast, piles are much less susceptible to checking than are sawn timbers that are more directly exposed to the sun. Because wide timbers check more than narrow ones, bolting two or more narrow timbers together can greatly reduce both checking and maintenance costs, especially if the timbers are treated.

Cracks can occur in piles and sawn timber during unloading or when the pieces are dropped. Cracks can also occur in piles during hard driving.

## JOINTS

Failure to protect the untreated ends of cut-off piles and timbers that are butted together can result in rapid colonization by decay fungi and a serious decay problem in as little as 5 years (Fig. 22). Below the waterline, these untreated joints can incur marine borer attack that the preservative treatment would normally inhibit. Above the waterline, the exposed joints trap water and provide an ideal site for fungal invasion unless they are treated or protected.

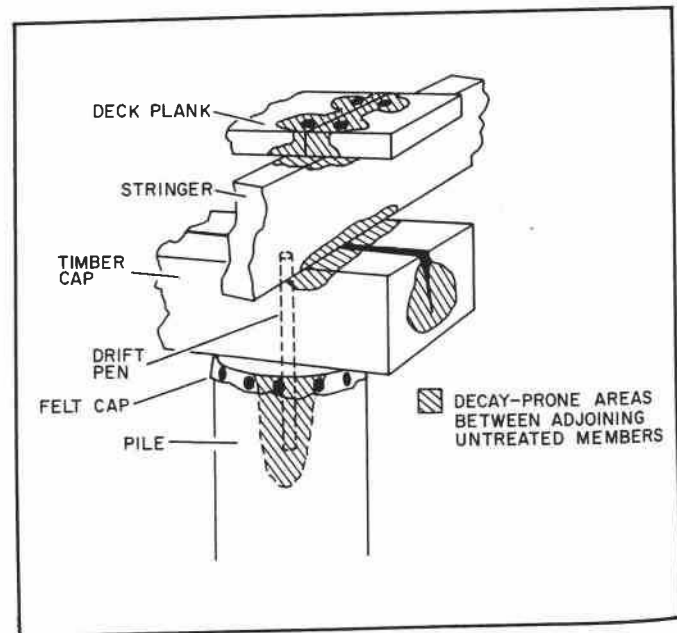

FIGURE 22.

DECAY OFTEN OCCURS WHEN WATER COLLECTS IN WOOD JOINTS.



## BOATS

Wooden boats covered by impermeable barriers such as fiberglass frequently decay when holes are drilled for fasteners or when cracks develop in the barrier surface. Either condition permits the entry of moisture and decay fungi into the wood. The remainder of the barrier helps to hold in this moisture and creates ideal conditions for decay development. Design and construction practices that allow water to be shed and provide good

air circulation enable wooden boats to provide long service.

## BOLT HOLES

Bolt holes also can expose untreated wood inside treated timbers to attack by wood-destroying organisms. If such a hole is not to be treated with a preservative, drill it slightly smaller than the bolt and drive the bolt through. This is especially important if the hole must be drilled below the waterline.

## METHODS OF DETECTING DECAY

Incipient decay may develop in untreated pile tops within 1 year and reach the visible, advanced stage, termed rot, within 2 to 4 years. Incipient decay can extend 4 feet or more from the internally rotting areas of a Douglas-fir pile. Although there are now no practical methods for field detection of incipient decay, continued research on chemicals that color decaying wood and on the alteration of wood's electrical properties by decay may eventually permit such field detection. Until then, microscopic examination or culturing pieces of the wood are the only reliable methods of detecting decay fungi in wood.

Core culturing involves removing a piece of wood, placing it on nutrient agar, and observing the fungi that grow out from it after 1 month (Appendix C). Any fungi that grow from the wood must be examined under a microscope by a trained specialist to determine if they do or do not cause decay. Although there is a delay between inspecting wood and obtaining results from culturing, large numbers of cores can be removed and cultured so that the process is nearly continuous. During the first inspection, culturing can be especially helpful in determining the extent of potential decay problems.

Eventually, the chemical and physical properties of decaying wood change sufficiently to permit recognition by other methods. The

sooner these changes are detected, the earlier remedial treatments can be applied.

A number of devices are used to detect decay above and below the waterline. These devices are outlined in the following subsections. They should be used under particular situations by experienced individuals. (Some equipment sources are listed in Appendix D.) Before applying these procedures on actual structures, it will be helpful to practice on wood with known damage or defects. This step will greatly enhance your ability to detect actual decay or marine borer damage in the field.

## SCRAPING DEVICES

A triangular blade scraper, a sharp shovel, or a dull probe are useful when inspecting piles for surface deterioration or marine borer attack (Fig. 23). The scraper, in addition to detecting surface decay, is also useful for removing surface-fouling organisms that can obscure wood attack. The probe allows the inspector to estimate the depth of deterioration, while the shovel can be useful for removing surface fouling, detecting severely decayed wood, and removing soil from around land-based piles or bulkheads. Because untreated wood can often be exposed while these tools are being used, a preservative solution or paste should be applied to exposed areas.

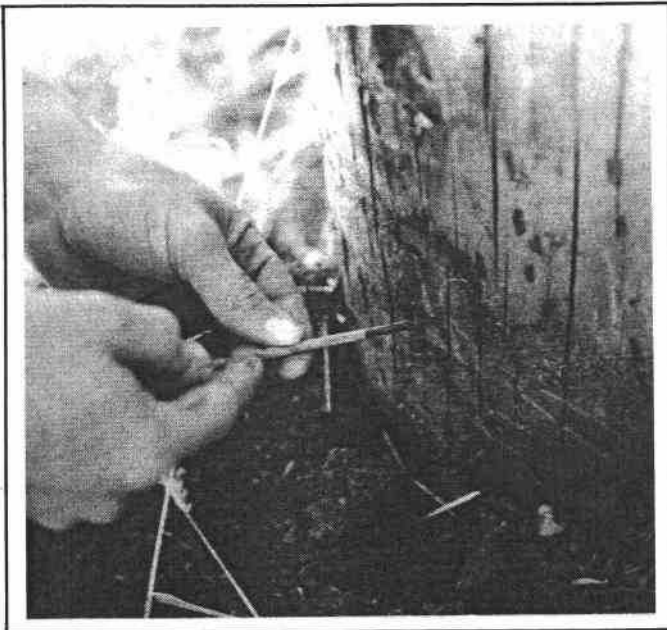

FIGURE 23.

PROBING THE WOOD SURFACE WITH A SCREWDRIVER OR OTHER SHARP INSTRUMENT OFTEN REVEALS SURFACE DAMAGE.

## PICK TEST

In some cases, a pointed tool can be useful for detecting brash wood (Fig. 24) that may be indicative of decay. Sound wood has a fibrous structure and splinters when broken across the grain, whereas rotten wood breaks abruptly across the grain or crumbles into small particles. In addition, sound wood has a solid feel when probed, while surface rot is usually soft and has minute fractures, much like charred wood. Although useful in the hand of trained individuals (Wilcox 1983), the pick technique is highly subjective and easily susceptible to errors in judgment. However, as you become more experienced, you may wish to incorporate this procedure into your inspections.

## PILODYN

The pilodyn is a penetration device with a spring-loaded pin. It can be useful above the waterline for detecting surface decay and below the waterline for detecting softening and attack by *Limnoria* spp. This device has been used to assess wood density in standing

trees, to detect decay from soft rot in utility poles, and to determine the integrity of submerged wood in sunken ships. When properly used, it can indicate surface attack but has little application to detection of internal deterioration.

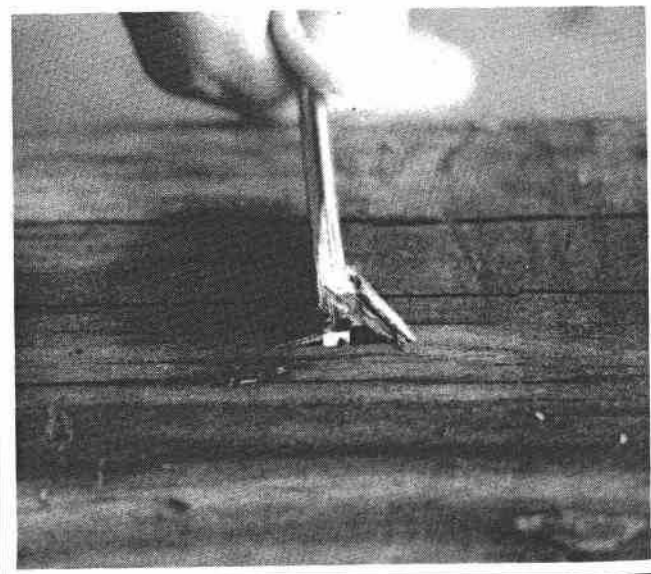
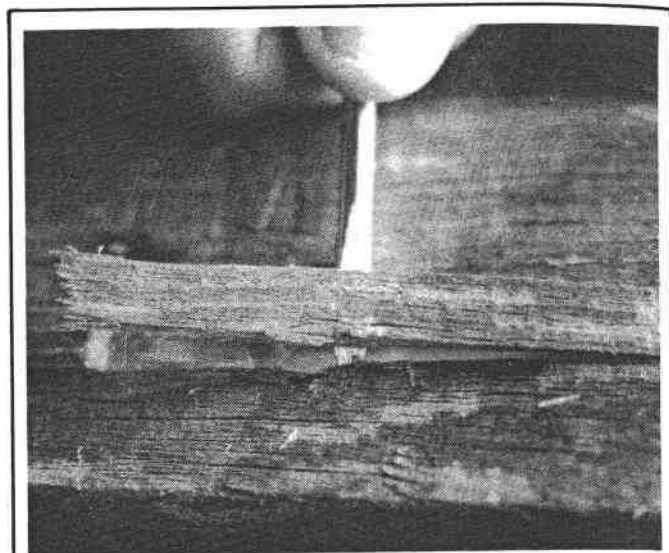

FIGURE 24.

THE "PICK" TEST CAN BE USED TO DETECT DECAYED WOOD. ABOVE: LONG SPLINTERS INDICATE SOUND WOOD. BELOW: EASILY BROKEN WOOD AROUND THE "PICK" INDICATES DECAY. FROM HELSING AND GRAHAM (1981). REPRINTED WITH PERMISSION FROM OREGON STATE UNIVERSITY EXTENSION SERVICE.

## SONIC INSPECTION

The hammer is a simple, effective tool for sounding piles and large timbers in order to detect advanced internal decay (Fig. 25). A light-weight hammer that is both comfortable to use and strong enough to stand repeated blows is recommended. Sound wood is indicated by a sharp ring, while a hollow sound or dull thud indicates some defect. Because wood defects other than decay can affect sounding, it is important to drill or core the suspicious area.

More sophisticated sonic devices have recently been developed for detecting internal decay (Appendix D). Also based on the principle of sounding, these devices can detect internal rot pockets but not incipient decay. To be effective, they must be well-maintained and operated by trained personnel.



FIGURE 25.

SOUNDING A PILE WITH A HAMMER CAN REVEAL LARGE VOIDS IN THE WOOD.

## INCREMENT BORER

The increment borer is an extremely useful inspection tool. It consists of a hollow, high-grade steel bit that is twisted into the pole, permitting removal of a solid wood core (Fig. 26). This core can then be examined for preservative penetration and the presence of

voids or defects, and it can be cultured for the presence of decay fungi. Increment borers are available in a variety of lengths and diameters suitable for the various sizes of structures being inspected (Appendix D).

The service life of the increment borer can be greatly extended by following a few simple rules:

1. To speed coring and decrease the risk of breakage, make starter holes 1/2 to 3/4 inch deep with a hammer-mounted metal punch (Fig. 27).
2. If boring resistance increases sharply, first back out and remove the core, then bore deeper.
3. Apply moistened soap to the exterior of the borer to decrease boring resistance.
4. Periodically sharpen the borer with a fine hone to ease coring and reduce risk of breakage.

Borers should be regularly oiled to avoid corrosion. Some suppliers of increment borers provide reconditioning services that sharpen and clean the bits. Proper maintenance of borers is described in more detail by Cantara (1983).

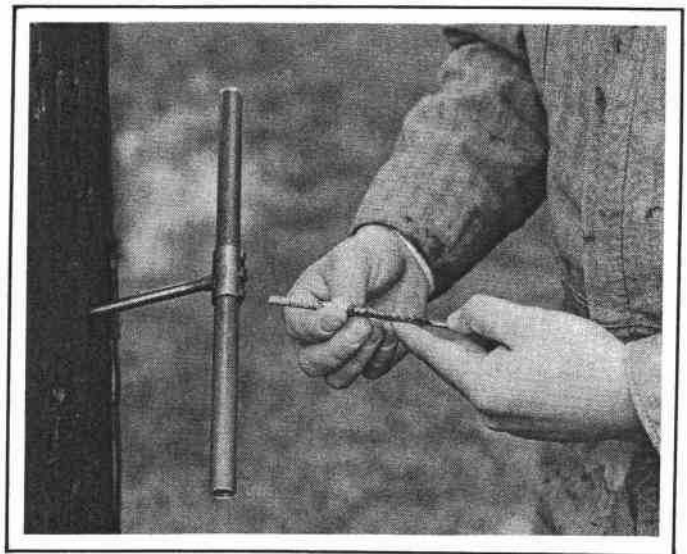

FIGURE 26.

INCREMENT CORES ARE USEFUL FOR DETERMINING PENETRATION OF PRESERVATIVES, DETECTING DECAY, AND OBTAINING WOOD FOR CULTURING FUNGI. FROM GRAHAM AND HELSING (1979).



FIGURE 27.

A LEATHER PUNCH WELDED TO A HAMMER CAN SPEED INCREMENT CORING BY CREATING STARTING HOLES.

While coring can be done by hand, the process can be made easier by mounting the bit in an extension chucked into a brace and bit (Fig. 28A) or directly into a power drill (Fig. 28B). Be sure that the extension is open at one side to permit extraction of cores, and remember that, while mechanical boring works well, it reduces one's ability to "feel" the borer and increases the risk of bit damage.

## BRACE AND BIT

A brace and bit can be useful for outlining areas of decreased drilling resistance and wood voids, although wet wood or natural voids can falsely indicate decay. While drilling, carefully examine the wood particles for discoloration or fines (small particles) that may indicate the presence of decay and note the depth of preservative penetration. Welding a 3/8-inch twist drill to either an electrician's bit or an extension rod of slightly smaller diameter speeds the drilling process.

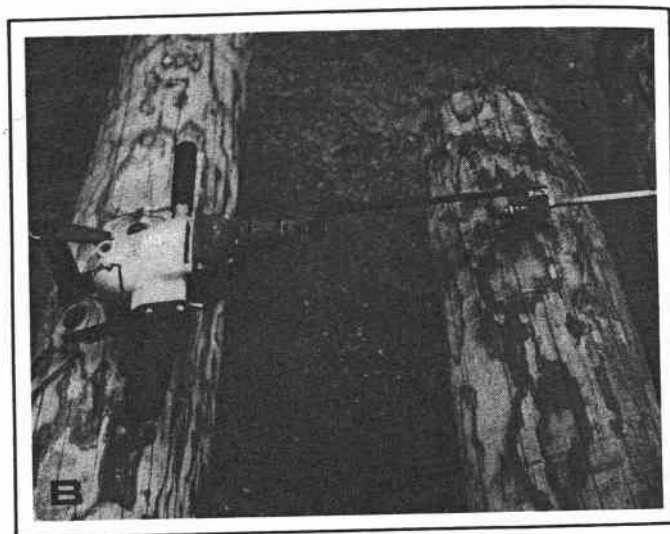

FIGURE 28.

MOUNTING THE BIT FROM AN INCREMENT BORER INTO (A) AN EXTENSION OR (B) AN ELECTRIC DRILL CAN SPEED CORE REMOVAL.

## SHELL-THICKNESS INDICATOR

A shell-thickness indicator is helpful in determining the depth of sound wood in standing piles. It consists of a thin, inscribed metal rod with a small hook at the end (Fig. 29). The rod can be inserted into a hole made by a power auger or increment borer (Fig. 30). By carefully pressing the rod against the side of the hole as it is withdrawn, the inspector can detect the edges of pockets as they catch on the hook at the end of the rod. An experienced inspector can also feel the

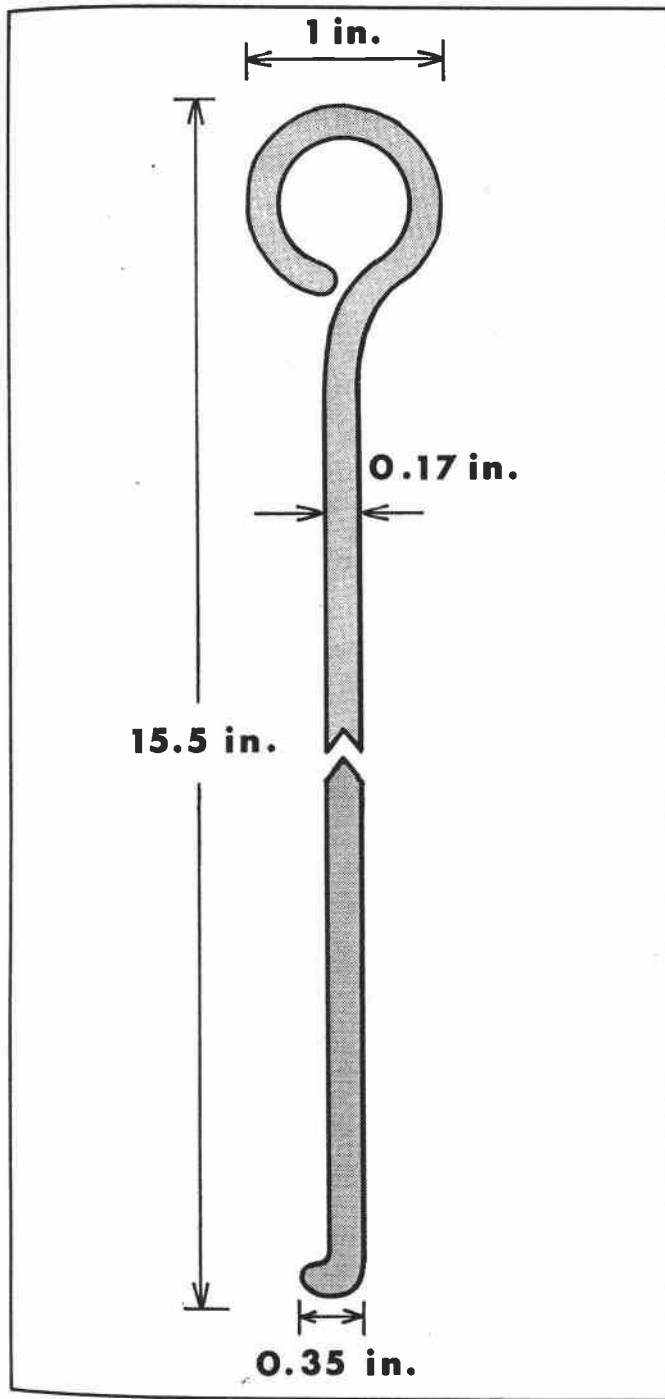

FIGURE 29.

WITH A SHELL-THICKNESS INDICATOR, AN EXPERIENCED INSPECTOR CAN DETECT DECAY IN PILINGS BY "FEELING" THE GROWTH RINGS IN SOUND WOOD AND THEIR ABSENCE IN ROTTEN WOOD. THE INDICATOR IS INSERTED INTO DRILLED HOLES OR THOSE MADE BY AN INCREMENT BORER. FROM GRAHAM AND HELSING (1979).

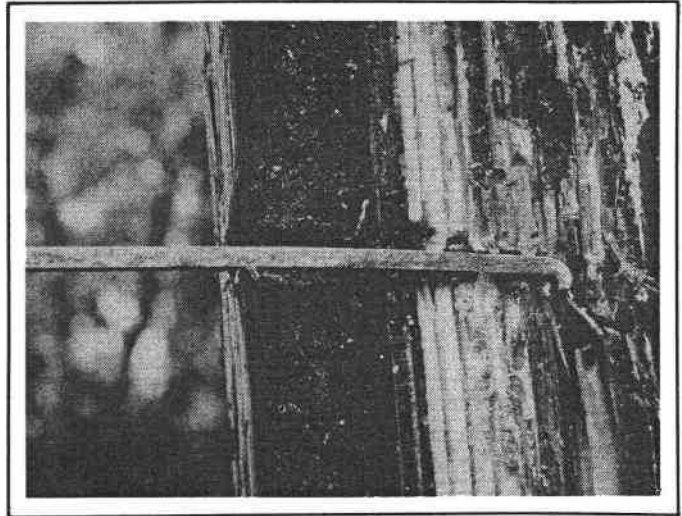

FIGURE 30.

THE SHELL-THICKNESS INDICATOR CAN BE USED TO ESTIMATE THE THICKNESS OF SOUND WOOD REMAINING IN THE OUTER SHELL.

tip pass from one growth ring to another in sound wood, but not in rotten wood. The depth of the remaining shell can be measured by reading the inscribed marks on the rod. Because inspection holes are often drilled at angles, it is helpful to inscribe marks for 45° and 90° on separate sides of the rod to correct for the angle. When using the shell-depth indicator, be sure that decayed wood is not pulled against the sound wood by the tip. Such a practice can result in an overestimate of shell depth.

## POWER AUGER

If the extraction of an intact wood core for culturing purposes is not required, a power auger can be useful for detecting voids and weakened wood. The shavings produced by this process can also be examined for the presence of advanced decay, resin pockets, or excessive moisture. As you drill, carefully listen for characteristic decreases in drilling resistance that may signal decay or other defects.

An auger 1/2 inch in diameter or larger works best, and the resulting hole can be used for the application of remedial chemicals to arrest any decay present.

## SHIGOMETER

The Shigometer measures the electrical resistance of wood and is reputed to be able to detect decay at very early stages. The instrument consists of two long, twisted, insulated wires with the insulation removed near the tips; these tips act as a probe (Fig. 31). This probe, which is attached to a meter measuring changes in electrical resistance, is inserted into a predrilled hole 3/32 inch in diameter. Simultaneously, the meter is observed for decreases in electrical resistance that indicate decay. The Shigometer works best at moisture contents above 27 percent, a moisture level frequently encountered in piles that are actively decaying. When using the Shigometer on marine piling, avoid wood subject to heavy surface wetting; salt absorbed in such wood could interfere with the Shigometer readings.

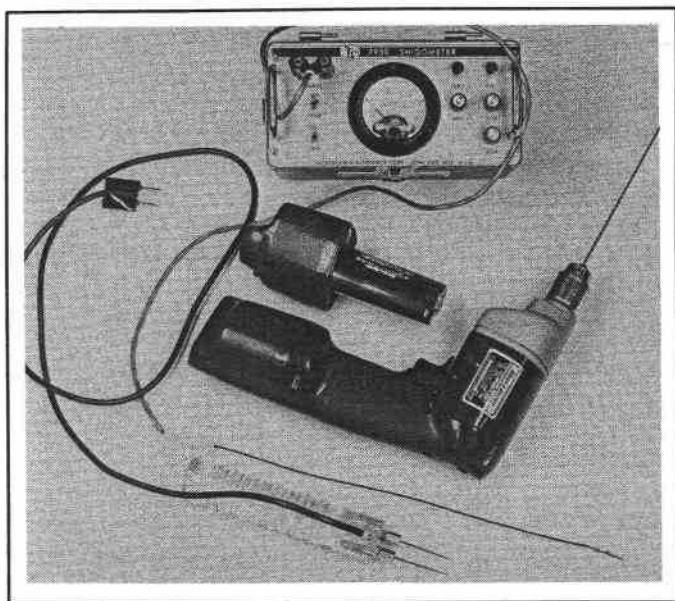

FIGURE 31.

A SHIGOMETER DETECTS DECAY BY MEASURING THE ELECTRICAL RESISTANCE OF THE WOOD. FROM GRAHAM AND HELSING (1979).

The Shigometer sometimes gives bad readings on apparently sound wood; therefore, zones where large meter drops occur (50 or 75 percent of the reading for sound wood) should be cored or drilled to determine the nature of the defect. The Shigometer is a sensitive instrument best operated by trained personnel who understand wood and its defects.

## MOISTURE METER

During inspection of wood, it is helpful to know whether conditions that permit decay are present. A resistance-type moisture meter is ideal for such a purpose because it can determine if moisture levels exceed 20 percent, the level below which most decay fungi are unable to grow.

Moisture meters employ two elongated pins attached to a resistance meter (Fig. 32). The meter is read at selected points as the pins are driven into the wood. By taking moisture readings at various sites around a pile, one can accurately determine where conditions conducive to decay are likely to occur; however, this information is accurate only for the 3-inch depth that the probe can penetrate.

For accurate readings, calibrate the meter frequently, check the batteries, and make sure the electrode coating is intact. When using moisture meters in extreme cold or heat, be sure to correct readings for temperature and wood species. As with the Shigometer, use caution when examining piles

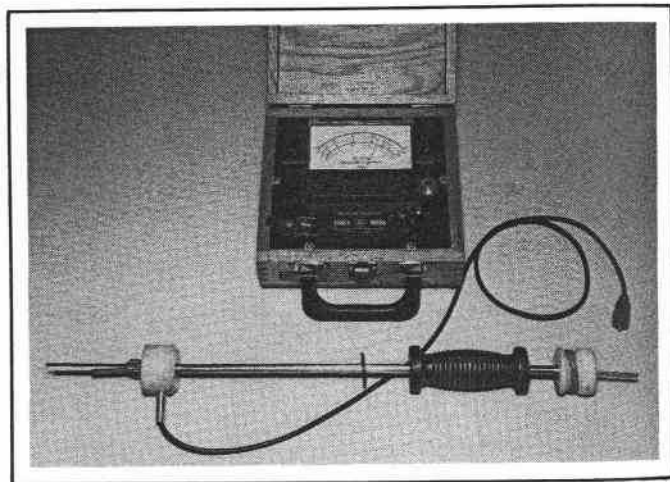

FIGURE 32.

A RESISTANCE-TYPE METER DETECTS WHETHER THE MOISTURE CONTENT OF WOOD IS HIGH ENOUGH (OVER 20 PERCENT) TO INDICATE DECAY. TWO ELECTRODES ARE DRIVEN INTO THE WOOD, AND THEIR DEPTH OF PENETRATION IS MEASURED. THE SHANKS OF THE ELECTRODES ARE COATED SO THAT MOISTURE READINGS ARE MADE BETWEEN THE UNINSULATED POINTS. FROM GRAHAM AND HELSING (1979).

---

treated with chromated copper arsenate or ammoniacal copper arsenate or those subject to heavy wetting, because salt will interfere with meter operation.

The moisture meter and Shigometer produced nearly identical results when these and other devices were evaluated for their ability to detect decay in Douglas-fir poles (Graham and Corden 1980).

## CULTURING

The decision on whether to culture will depend upon the size of your wood system and the timber species involved. In many cases, culturing is the only way a potential problem can be detected in the early stages, when control is most effective and inexpensive (Appendix C). The initial inspection of pile and timber species with thin sapwood and non-durable heartwood (such as Douglas-fir)

should include the culturing of cores removed from wood above the waterline. Previous inspection of Douglas-fir pilings along the Oregon coast indicates that substantial decay can develop below the apparently solid tops of cut-off piles. Culturing should be considered during the initial inspection.

## X-RAYS

X-ray examination of wood to detect voids caused by decay fungi and other pests is based on the movement of X-rays at different velocities through sound and damaged materials. The rays are recorded on photographic film sensitive to them. Their commercial use on wood has several limitations: potential hazards to users, the need for long exposures for large pilings, and the expense of portable equipment. Consequently, the use of X-rays has been limited mainly to small specimens for research purposes.

---

## METHODS OF DETECTING MARINE BORERS

---

Marine borers can be detected by intertidal inspection, sacrificial test blocks, sonic testing, and X-rays.

### INTERTIDAL INSPECTION

Very low tides are ideal times to inspect piling for marine borer damage. They are best suited for detecting attack by *Limnoria* spp., which concentrate on the external faces of piles. For piles near the shore, inspectors can wear hip-waders; for structures in deeper water, inspections can be made by small boat or float or by divers. Because *Limnoria* spp. tend to attack wood inside holes, cracks, or gouges, be sure to use a flashlight or headlamp to inspect below the superstructure for damage. A scraper and a probe can be used to remove fouling organisms from the pile surface and to check around bolt holes and between adjoining wood members for evidence of attack. Damage signs include the hour-glass shape of piles in the tidal zone, numerous bore holes in the wood and a general softening in the attacked areas, oval-shaped holes made by hooks and tongs, hollow ends of bracing, and loose bolts and bracing.

Occasionally, low streamflow or very high tides can bring a wedge of saltwater far upstream in a river. Such conditions are conducive to attack by marine borers, especially in deeper water in the river. For this reason, divers should inspect the outermost piles down to the mudline.

Intertidal inspection is less effective for damage by shipworms. These organisms leave only a tiny entrance hole on the wood surface; consequently, detection of their presence is difficult. Although observant divers in clear water may be able to see the nearly transparent siphons or the tiny pallets protruding from the pile surface, dependence on such observations is a questionable method of inspection. Other techniques are more useful, as the following subsections will reveal.

### SACRIFICIAL TEST BLOCKS

Initial assessment of potential shipworm damage in a particular harbor can be made by immersing "sacrificial" blocks of untreated wood at the site of the intended structure (Fig. 33). Such blocks are removed at 1-month

intervals, split open, and examined for evidence of attack. In estuaries with freshwater flow, the blocks should be suspended in the saltwater wedge beneath. Be sure that the test blocks are securely fastened to supports weighted to submerge them below the zone of tidal and wave action. Untreated piles can be used as an indicator of shipworm activity in a harbor, but driftwood is an unreliable indicator because its source and previous history are unknown. Because salinity conditions may vary from time to time, periodically submerge test blocks to remonitor the site.

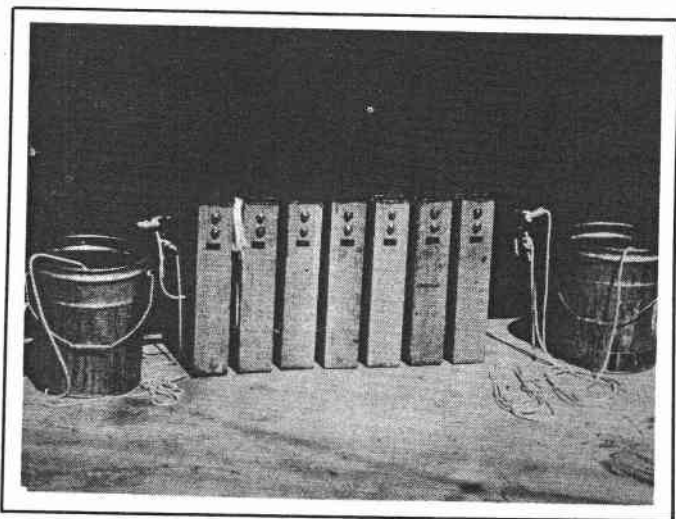

FIGURE 33.

UNTREATED TEST PANELS EXPOSED IN A HARBOR OR ESTUARY CAN HELP INSPECTORS DETECT POTENTIAL HAZARDS FROM MARINE BORERS.

## INSPECTING

The above methods can be used in establishing a routine inspection program by knowledgeable personnel. Such inspections are of paramount importance in maintaining a safe and efficient waterfront system. A thorough initial inspection of structures not previously examined is time-consuming, but the information obtained can save both time and money in the long run. Subsequent, briefer inspections can pinpoint potential problems before they become more serious. An initial inspection will involve four steps.

## SONIC TESTING

A successful, nondestructive device for assessing internal damage by marine borers is the sonic tester developed by the British Columbia Research Council (Agi 1978). Called the Pink Elephant, the device, operated by a single diver, is used to inspect piles from the waterline to the mudline. The strength and velocity of sound waves passing longitudinally through the pile are monitored top-side on a meter by the support crew. Because sound waves move through undamaged wood differently than through damaged wood, the device allows estimates to be made of the amount of undamaged wood remaining in any given cross-section. The sonic tester does not require removal of external fouling organisms; consequently, a crew of two can test about 100 piles per day (Appendix D). Readings for undamaged piles may be inaccurate, however, and some retesting may be required.

## X-RAYS

For experimental purposes, X-rays are an ideal way to study the presence and growth of shipworms in wood. Untreated wood blocks can be immersed in salt water, removed periodically, X-rayed at a local hospital, and replaced in the water.

### STEP 1

Observe and record the general condition of piles, cross bracing, stringers, caps, and decking. Note any unusual damage, loose bolts, chafing about the waterline, deep checks, cracks, scars exposing untreated wood, and untreated cut-off tops and ends of pilings and other members. Also examine the surfaces for holes made by pointed tools, exit holes made by beetles, piles of sawdust



left by carpenter ants, mud tunnels made by subterranean termites, or wings discarded by reproductive termites.

Below the waterline, look for surface tunneling and the general hour-glass shape typical of attack by Limnoria spp. or the extended siphon tubes indicating the presence of shipworms.

Careful observation and record-keeping during inspection is important in directing the inspector to problem structures more quickly and in providing a basis for an efficient maintenance program. Unless recorded, the information can be lost when personnel changes occur.

## STEP 2

Sound the members with a hammer above the waterline, listening for the sharp ring of good wood, the "thud" of wet and possible rotten wood, and the "drum" of hollow wood. Suspicious areas should be bored to determine the nature of the defect. Sounding will detect only members with serious internal defects and should never be the sole method of inspection.

## STEP 3

After sounding, drill or core members upward at a slight angle adjacent to the widest check and at suspicious sites. If the wood is

solid, rate the member as good until results of culturing are available; these results may indicate otherwise.

If visible decay is present in the first core, drill or core the member at other sites to determine the distribution of the rot. Measure the depth of preservative treatment, depth of apparently solid wood, and the size of the member. From this information the residual strength of the member can be estimated and, depending on how the structure is being used, decisions can be reached about future replacement or remedial treatments. If rot is present, remember that apparently solid untreated wood nearby is probably in the early stages of decay.

## STEP 4

Treat all openings made during the inspection with a double-strength preservative solution or paste and plug the holes with preservative-treated dowels slightly larger in diameter than the inspection holes. (Remedial preservative treatments are discussed in the following section.) Plugs treated with inorganic salt are advised for creosote-treated wood attacked by Limnoria tripunctata; however, when no such attack is encountered, creosote-treated plugs are sufficient. In areas where both pholads and L. tripunctata attack, plugs treated with both creosote and inorganic salt are advised.

# REMEDIAL TREATMENT AFTER INSTALLATION

When pressure-treated wood members are already in service, cut-off tops of piles or timbers and bolt holes are critical entry points for decay fungi, insects, and marine borers. It is of the utmost importance that these areas be effectively protected if the port is to achieve maximum return on the original investment. When cutting is necessary, exposed surface area can be minimized by cutting the exposed end of the timber or pile as straight as possible. When bolt holes must be made, drill them slightly smaller than the bolt.

Remedial measures to prevent the entry of pests include treating the exposed wood with an appropriate preservative and then applying a protective cap to pile and timber ends. These measures are discussed below.

## PRESERVATIVE APPLICATION

Four kinds of preservatives are suitable for marine structures: liquids, solids, greases, and fumigants.

## LIQUID PRESERVATIVES

Before applying a water-shedding cap to cut-off tops of piles and timbers, flood them with hot creosote (150 to 200°F), pentachlorophenol in diesel oil, or copper naphthenate in mineral spirits.<sup>1</sup> Such flooding will enhance protection of untreated wood exposed during construction. Although hot creosote is probably the most commonly used preservative for flooding, none of these treatments penetrates wood deeply, nor do they protect wood exposed to wetting. Procedures for protecting cutoff ends are outlined in more detail in AWP Standard M4-79 (Appendix E).

## SOLID PRESERVATIVES

Solid chemicals, applied dry or as a paste, may be useful on docks where hawsers rip off caps and expose wood to moisture and decay organisms. As the chemicals moisten, they readily diffuse down through the pile. These preservatives are able to move to sites where moisture conditions suitable for decay development are likely to occur and can also protect wood that checks after remedial treatment. Fluor-Chrome-Arsenic-Phenol (FCAP), a mixture of compounds available as a liquid or paste, is recommended by the AWP for aboveground remedial applications. Applied as a paste, FCAP has protected cut-off tops of Douglas-fir piles for over 10 years in field tests. Another promising new chemical, ammonium bifluoride (ABF), is stable when dry but picks up water from air, liberating toxic hydrogen fluoride gas. ABF, placed in semi-permeable bags, has effectively eliminated decay fungi and prevented their entry into otherwise exposed pile tops. However, the released gas is corrosive and care should be taken to ensure that no metal fastenings are adjacent to the bag.

## PRESERVATIVE GREASES

Although greases may be of some use for protecting bolt holes, their application to otherwise unprotected pile tops does not

effectively protect such tops from decay. The grease tends to dry and crack after several years of weather checking, permitting the entry of moisture and decay fungi while creating conditions for decay development (Fig. 34).

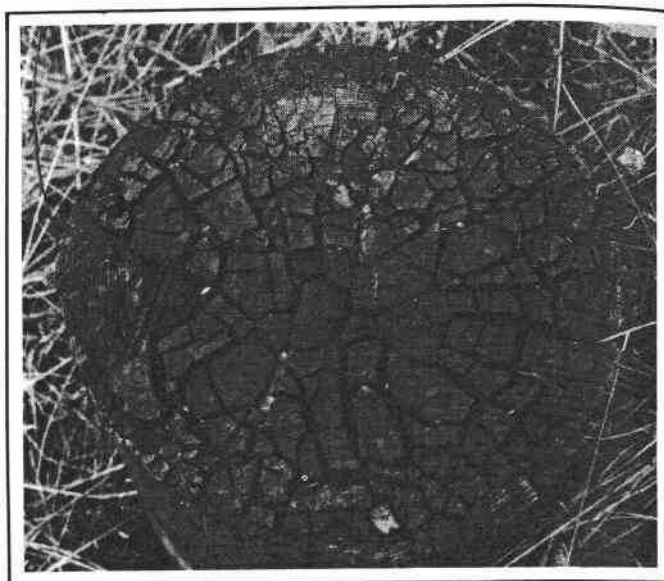

FIGURE 34.

PRESERVATIVE GREASES MAY INITIALLY HELP KEEP PILE TOPS DRY: AS TIME PASSES, HOWEVER, THEY TEND TO CRACK AND THUS PERMIT WATER TO ENTER THE UNTREATED WOOD BELOW.

## FUMIGANTS

Fumigants, long used in agriculture to control soil organisms, are now effectively controlling decay in piles and poles (Corden and Graham 1983). Vapam, Vorlex, and chloropicrin are now registered for application to wood structures by the Environmental Protection Agency (EPA). These chemicals are applied in liquid or solid form. They diffuse as a gas 8 feet or more through the wood from the point of application, thereby eliminating decay fungi and controlling decay for as much as 14 years. Encapsulation is making them safer and easier to use. Treatment methods and dosages are discussed in more detail in a later section.

## PILE CAPPING DEVICES

After the cut-off pile has been treated with preservative, it should be protected with a

<sup>1</sup> The Environmental Protection Agency has recently proposed that application of creosote, pentachlorophenol, or inorganic arsenicals (ACA or CCA) be restricted to certified applicators. Copper naphthenate is not covered by these proposals.

water-shedding cap. Such caps are discussed here, and the pertinent sections of the AWWA standards for protecting untreated wood exposed during construction are presented in Appendix E.

Materials used for capping piles include coal tar-roofing cement, galvanized metal, heavy roofing felt, heavy plastic, Noah's pitch, hot asphalt, and preservative-treated plywood (Fig. 35). One effective capping device is coal tar-roofing cement held in place by

fiberglass mesh cloth. To cap a pile by this method, trowel a thick layer (1/2 inch) of cement on top, place two layers of fiberglass mesh on the cement, nail the mesh to the pile, and finish with an additional coat of cement. This patch remains flexible and resists water penetration into the untreated wood below.

Galvanized metal, roofing felts, and plastic sheets make effective caps when applied in conjunction with chemical treatments. Without

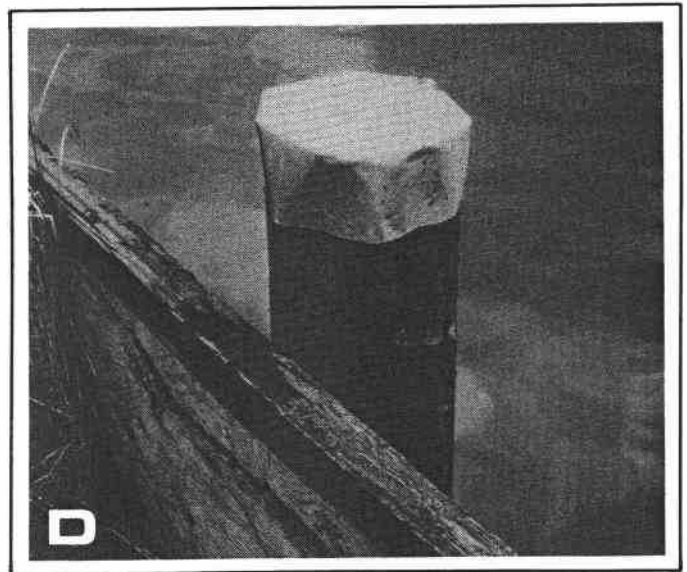
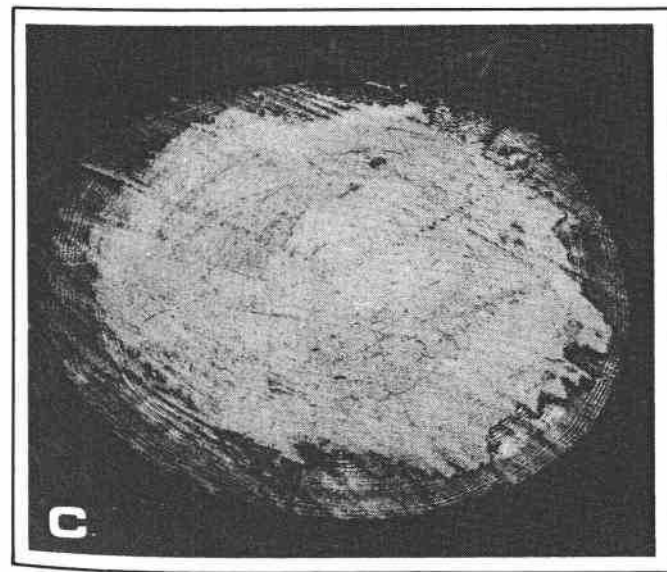
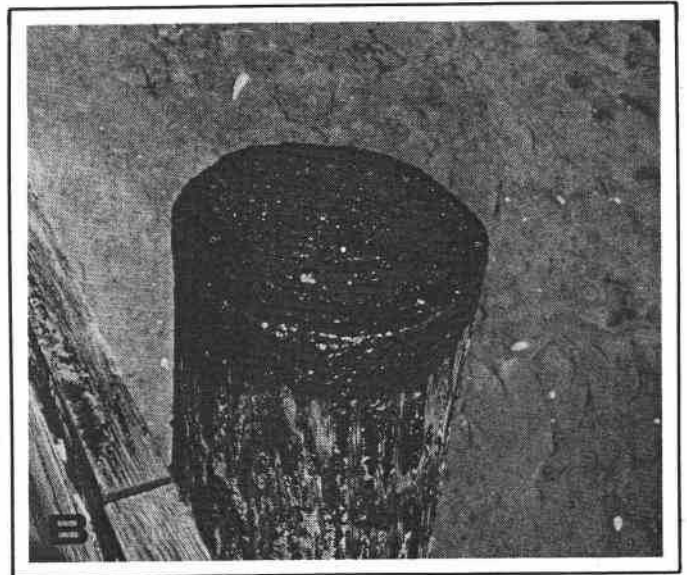
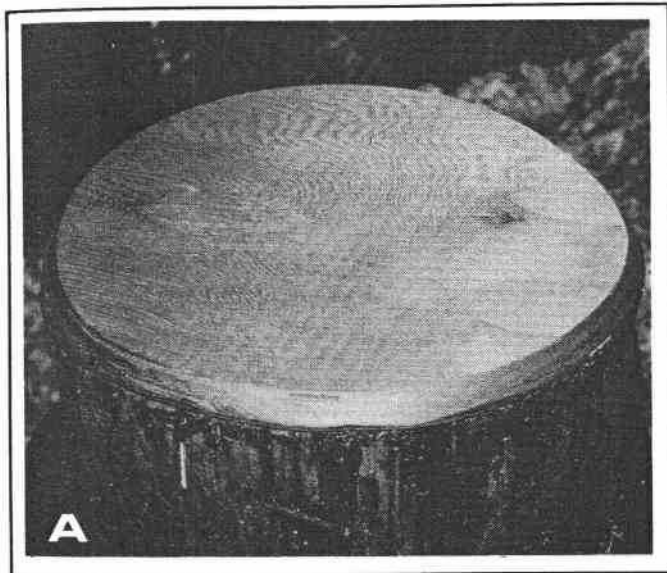

FIGURE 35.

A NUMBER OF CAPPING DEVICES ARE USED TO PROTECT UNTREATED WOOD EXPOSED IN CUT-OFF PILE TOPS--A: PLYWOOD; B: COAL TAR CEMENT/FIBERGLASS MESH; C: FLUOR-CHROME-ARSENIC-PHENOL (FCAP) PASTES; D: SHEET METAL.

---

a preservative, condensation or leaks can create ideal conditions for decay beneath the cap. The material should be cut with at least a 2-inch overlap to permit the edges to be folded down and fastened to the pile sides with galvanized roofing nails or bands.

Noah's pitch or hot asphalt may be applied to pile tops before addition of a water-shedding cap. However, these materials only penetrate the wood to a shallow depth and are of little use if the cap leaks.

Preservative-treated plywood makes a simple but effective capping device. Two narrow strips of treated wood are nailed to the pile top, and the plywood cap (cut to a slightly larger diameter than the pile) is attached to the strips. The strips permit air to circulate beneath the cap and keep the wood dry.

Because pile caps on working piers are often damaged or pulled off by hawsers, it is

helpful to treat the top with a water-soluble preservative before cap installation. These treatments remain inactive as long as the cap remains sound, but they are activated whenever water enters the cap and thereby prevent the entry of decay fungi until the cap can be repaired.

## **BRUSH TREATMENT FOR DECKING**

The brushing of FCAP onto the surface of untreated Douglas-fir decking can be useful for extending the service life of that surface and the wood immediately beneath. Unlike pentachlorophenol in diesel oil, which does not effectively penetrate wood, water-soluble chemicals such as FCAP continue to move into checks as they open, thereby protecting the wood below the surface. Brushing, however, is not a substitute for pressure treatment of new wood.

---

## **PREVENTING BORER ATTACK**

Attack of piles by marine borers can be prevented by the use of preservative-treated wood, impermeable barriers, wood and concrete reinforcements, plastic wraps, and fumigant treatments. Each of these methods is described below.

### **TREATED AND RESISTANT WOOD**

Pressure treatment of piling with creosote effectively prevents attack by marine borers in coastal waters north of San Francisco, California. In waters south of San Francisco, treatments with inorganic salts [Chromated Copper Arsenate (CCA) or Ammoniacal Copper Arsenate (ACA)] are recommended because of the likelihood of attack by Limnoria tripunctata. Where L. tripunctata and pholads are both present, a dual treatment with ACA or CCA and creosote is recommended. In Oregon waters, treatment of wood so that it retains 20 pounds of creosote per cubic foot is recommended. The treatments and retentions recommended by AWWA are listed in Appendix B.

Where marine borers are present, pressure-treated wood will pay for itself in terms of safety, service life, and low maintenance costs. In bay waters with low salinity along the Oregon coast, untreated piles frequently are used. However, their use in structures is questionable because of high replacement costs. Furthermore, saltwater intrusion when streamflows are low can create opportunities for marine borer attack. The most infamous incident of this type occurred in the San Francisco Bay area between 1917 and 1921 when damage amounting to \$25 million was caused by marine borer attack of untreated piles far up the Sacramento and San Joaquin River systems (Hill and Kofoid 1927). Less costly but similar failures have been recorded on several Oregon bridges when untreated supports were exposed by scouring. Where marine borer attack is always absent, untreated pilings with tops protected from rain have provided reasonable service. Failure to protect the tops of these piles from wetting will necessitate replacement after 8 to 12 years of service.

As mentioned previously, heartwood of certain tropical species exhibits some resistance to

marine borer attack (Table 1). However, sapwood of these species has no resistance to marine borers. Because borers, once established in the sapwood, can then attack the heartwood, care should be exercised to use only heartwood. Greenheart piles along the Oregon coast failed after 6 to 8 years because they contained sapwood.

## BARRIERS

Impermeable barriers can protect wood under the waterline from marine borer attack. Such barriers, generally applied as remedial treatments for preservative-treated piles, serve the dual purpose of inhibiting the entry of borers into the wood and creating anaerobic conditions that kill established borers by limiting the available oxygen. Barrier materials have included copper nails, corrosion-resistant metal sheathing, concrete, epoxies, and, more recently, wraps of heavy polyvinylchloride or polyethylene (e.g., 30 mil and 60 mil). Nails and metal sheathing were the mainstays of wooden ships. A British admiral, after verifying the presence of extensive decay in his wooden ship, noted in the log that there was only a layer of copper sheathing between him and eternity. The expense of these techniques was a major factor in the search for other barrier materials.

Concrete barriers, in addition to preventing marine borer attack, can add support to partially degraded marine structures (Fig. 36); however, it is essential that a zone from below the mudline to above the high tide line be completely encased with at least 2 inches of concrete. Failure to encircle the pile completely will result in localized attack of unprotected areas and eventually lead to pile failure.

Before barriers are applied to structures already in service, it is important to ascertain that piles retain sufficient structural integrity to warrant treatment and, in the case of concrete, that sufficient strength remains to support the barrier.

## WOOD REINFORCEMENT

Where a pile is heavily damaged, the structure can be reinforced by cutting out the damaged section and replacing it with preser-

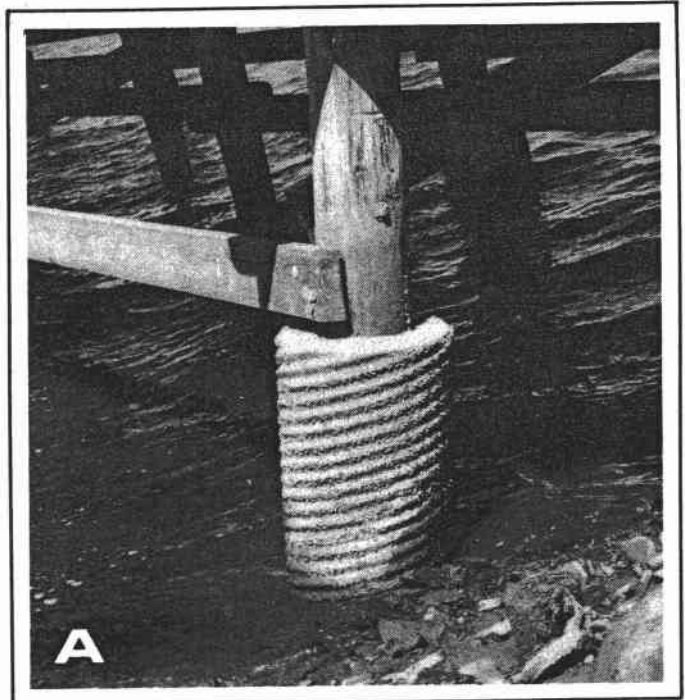

FIGURE 36.

A: CONCRETE CAN FORM AN EFFECTIVE BARRIER AGAINST ATTACK BY MARINE BORERS. B: CONCRETE BARRIERS ARE ONLY EFFECTIVE IF THEY REMAIN INTACT; ONCE BROKEN DOWN, THEY MAY ACTUALLY ACCELERATE DETERIORATION.

vative-treated wood. This method requires that the dock be supported by jacks or shoring during the replacement and is most useful where scattered piles in a dock are damaged.

Reinforcement can be done by posting, bench capping, or splicing. Posting involves supporting the structure, cutting out the damaged pile section, and replacing it with a treated wood section. The section is secured at the bottom with a drift pin or splices, and shims or blocks are used to ensure that the pile has sufficient bearing surface to support the structure. Bench capping is similar to posting except that the cut-off base is capped and timbers or pile sections are used to replace the damaged zone. While these two techniques are recommended for use about the tideline, splicing is recommended for damage in the tide zone. With splicing, the structure is supported and the pile is cut off below the mudline. A replacement section is positioned on the cut stub and secured with drift pins or splints. The top of the replacement section is then adjusted with shims or blocks so that it supports the structure. In all cases, the use of corrosion-resistant, galvanized hardware and preservative-treated wood is recommended.

## CONCRETE REINFORCEMENT

Pile reinforcement with concrete can be accomplished by several methods. Where small voids are present, it is sometimes sufficient to fill the void with coarse stone and mortar. Where damage is more severe, forms made of metal, wood, concrete, woven nylon, or pitch-impregnated fiber are attached to the pile as far down as 2 feet below the mudline. In many cases, these forms are left attached to the pile. Other methods employ a reusable metal form: a reinforcing cage is placed around the pile, the bottom is sealed, and the form is installed. The apparatus is supported by tension rods that center the form so that an even layer of concrete is applied over the pile (Roe 1984).

In severely deteriorated piling, the degraded sections can be cut off below the mudline and a concrete pile can be cast over the old pile base by attaching a dowel into the cutoff, installing a seal to the pile, and placing a form over the seal. The concrete is then pumped into the form through a valve at the bottom seal until the desired height is reached (Roe 1984).

## PLASTIC WRAPS

Wrapping piles in service with plastic barriers, a technique developed fairly recently, can provide protection from marine borers for 25 years or more (Fig. 37). Such barriers are advisable when inspection reveals a 15 to 20 percent loss in cross-sectional area of the pile as a result of marine borer attack. Although polyvinylchloride wraps were initially used for such barriers (Wakesmen and Whiteneck 1960), a two-layer polyethylene system has recently been used in Los Angeles Harbor (Steiger and Horeczko 1982). In this system, a 20-mil polyethylene sheet is heat shrunk around the pile before it is driven. Afterwards, a 150-mil polyethylene sheet is

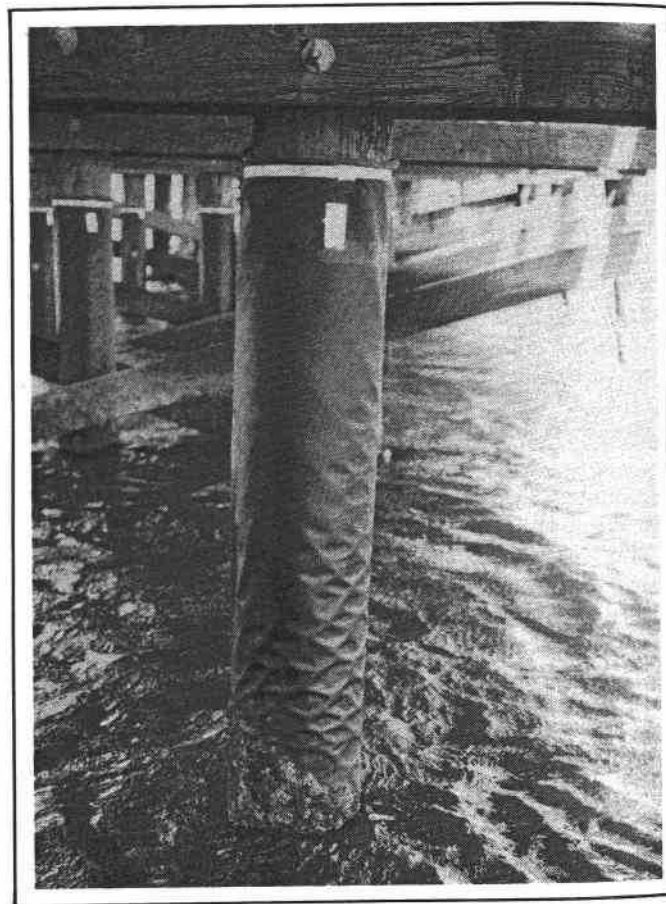

FIGURE 37.

POLYETHYLENE OR POLYVINYLCHLORIDE (BLACK PLASTIC) WITH AN UNDERCOAT OF POLYETHYLENE CAN EFFECTIVELY PROTECT PILES FROM ATTACK BY MARINE BORERS. THIS PARTICULAR WRAP HAS AN ADDITIONAL PLASTIC BARRIER TO PROTECT THE PILE FROM CHAFING.

attached at the intertidal zone with aluminum alloy nails. Application of the wrap requires a diver, a tender, and assistants. Barrier-protected piles should be inspected periodically for damage to the barrier or for scour that exposes the wood; such damage should be repaired.

## TREATMENT WITH FUMIGANTS

Developed during the 1960's for control of decay in poles, fumigants may prove useful for stopping shipworm attack. Before 1970, the only recourse for owners of deteriorating timbers was reinforcement with concrete and grout or costly replacement of the decayed wood. Research at Oregon State University has shown that certain volatile, broad-spectrum fumigants can stop further development of decay in utility poles and marine piling. Three of these chemicals--Vapam (33 percent sodium N-methyldithiocarbamate), Vorlex (20 percent methylisothiocyanate, 80 percent C-3 hydrocarbons), and chloropicrin (trichloronitromethane)--are registered with the EPA for application to wood products. These chemicals have long been used to eradicate soil-borne pathogens before valuable agricultural crops are planted.

In wood applications, the chemicals, in liquid or solid form, are placed into a number of predrilled holes. The fumigant volatilizes into a toxic gas that moves through the wood, eliminating decay fungi and insects. Fumigants can move, or diffuse, longitudinally in effective quantities for over 8 feet from the application point. The duration of effectiveness in Douglas-fir transmission poles is 10 to 14 years with Vapam and over 14 years with chloropicrin and Vorlex (Fig. 38). These chemicals have controlled decay in bulkhead piles for at least 9 years after being applied near a pile top which was then covered with a cap of coal-tar cement and fiberglass mesh (Fig. 39). Although these chemicals can extend the service life of untreated piling, they are longer lasting and more effective when applied to preservative-treated wood.

Of the currently registered chemicals, Vapam has the lowest toxicity and is perhaps the least difficult to apply. Chloropicrin has strong lacrimatory properties, which many people find objectionable. Vorlex is the most

recent chemical to be registered by the EPA for use on wood.

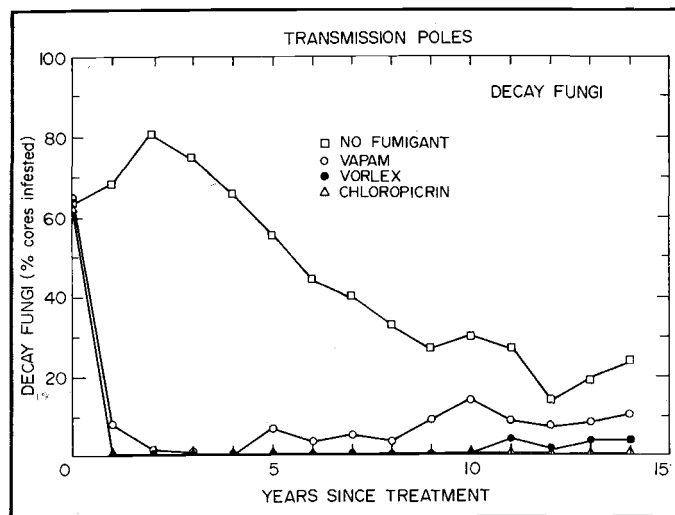

FIGURE 38.

ANNUAL CHANGES IN THE POPULATION OF DECAY FUNGI ISOLATED FROM PRESSURE-TREATED DOUGLAS-FIR POLES AFTER APPLICATION OF VARIOUS FUMIGANTS. NOTE THE LOW LEVELS OF DECAY FUNGI PRESENT IN FUMIGANT-TREATED POLES. FUNGI IN POLES WITHOUT FUMIGANT DECLINED BECAUSE OF THE DEPLETION IN AVAILABLE WOOD. FROM MORRELL AND CORDEN 1984.

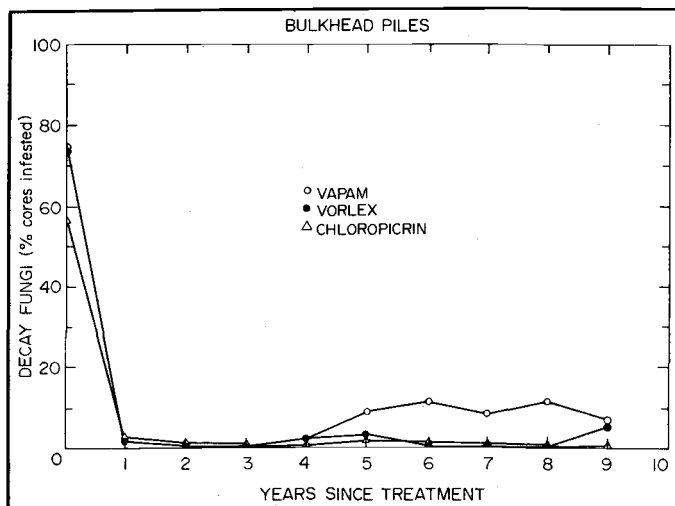

FIGURE 39.

ANNUAL CHANGES IN THE POPULATION OF DECAY FUNGI ISOLATED FROM CREOSOTED DOUGLAS-FIR PILES TREATED WITH VARIOUS FUMIGANTS. EACH VALUE ON THE CURVE REPRESENTS 60 CORES FROM EACH OF 12 PILES. FROM MORRELL AND CORDEN 1984.

Still in developmental stages are solid and encapsulated fumigants. Solid methylisothiocyanate (MIT), the active ingredient of Vorlex and Vapam, has been tested on utility poles for 5 years, with results similar to those achieved with Vorlex. Encapsulated MIT and chloropicrin have been applied to poles with promising results. These developments will increase safety, reduce the risk of environmental contamination, and permit fumigant use in previously restricted applications.

## FUMIGANT APPLICATION

Successful use of fumigants depends on the establishment of an effective inspection program that detects damage before serious loss of strength occurs. Whenever possible, this program should be coupled with sound design and construction procedures. Fumigants can never replace the need for such procedures, only supplement them.

Fumigants, like nearly all other pesticides and preservatives, are toxic to humans and must be handled properly. Therefore, they should only be handled by trained personnel who have a full understanding of the necessary precautions (see below) and should be applied in accordance with State and Federal laws.

Before applying any fumigant, carefully assess the condition of the structure. Determine the optimal drilling pattern that avoids metal fasteners, seasoning checks, and badly decayed wood. Fumigant placed into rotten wood may be lost if the decay pocket intersects a seasoning check or other void.

In piles, the holes should be drilled at a steep downward angle toward the center in order to avoid crossing seasoning checks. Begin by drilling almost perpendicularly to the pole and quickly raise the drill to the proper angle once the bit catches in the wood (Fig. 40). Avoid drilling through the pile! Horizontally oriented, sawn timber should be treated by drilling pairs of holes straight down to within 2 inches of the bottom side (Fig. 41). If large seasoning checks are present, drill the holes on either side in order to protect the timber completely.

It is helpful to plan work when the pile tops are most accessible--generally at high tide. Although fumigants can be applied 10 feet or

more below the pile top, it may take 4 or 5 years before sufficient quantities of fumigant diffuse upward to the point where the decay occurs.

The amount of chemical and the size and number of treating holes required will depend on pile circumference or timber dimension. Not unexpectedly, smaller pieces require less chemical and fewer treating holes. Table 2 gives some examples of the number and size of holes and of the dosages required to treat various sizes of piling.

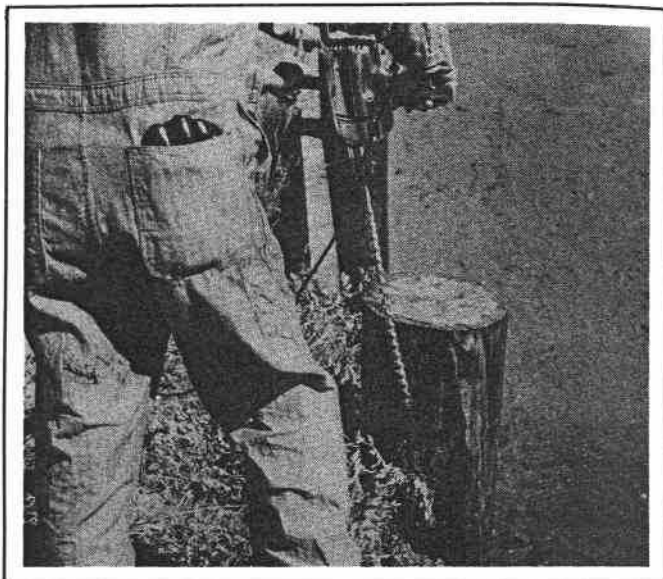

FIGURE 40.

TREATING HOLES ARE DRILLED AT STEEP ANGLES (45 TO 60°) INTO THE WOOD AND FILLED WITH LIQUID FUMIGANT.

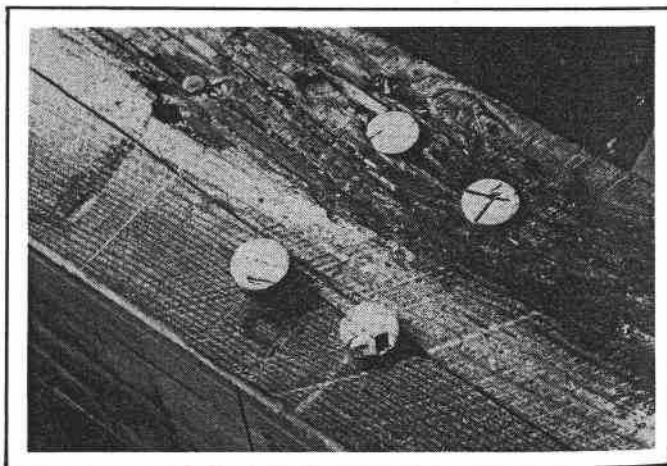

FIGURE 41.

TREATING HOLES IN TIMBERS SHOULD BE SITUATED ON BOTH SIDES OF CHECKS.



TABLE 2.

NUMBER AND SIZE OF HOLES AND DOSAGE OF FUMIGANT REQUIRED FOR PILES WITH VARIOUS CIRCUMFERENCES. FROM GRAHAM AND HELSING (1979).

Hole		Fumigant Pints per inch of hole	No. of holes for piles with circumference (and dosage) of		
Diameter (Inch)	Length <sup>a</sup> (inches)		<32 in. (3/4 pt)	32-45 in. (1 pt)	>45 in. (2 pt)
5/8	15	0.010	6	-	-
	18	.010	5	-	-
3/4	15	.015	4	6	-
	18	.015	-	5	-
	21	.015	-	4	-
	24	.015	-	3	6
7/8	21	.024	-	3	5
	24	.024	-	-	4

<sup>a</sup> Effective length of treating hole is 3 inches less in order to allow for a 3-inch treated plug.

The fumigant can be applied from 1-pint polyethylene squeeze bottles into the predrilled holes. For ease of filling, it is sometimes helpful to replace the plastic cap with a reusable cap fastened to a 1-foot length of plastic or rubber tubing (Fig. 42). After

adding the required dosage, replace the original cap so that the remaining liquid is sealed in the bottle. If fumigant drains out of the hole as it is being applied, do not add more! Instead, plug the hole with a tightly fitting, preservative-treated dowel and drill a new hole into solid wood.

While applying the fumigant, wear protective clothing, including eye glasses, and position yourself upwind. A gas mask must be available for emergency use. If fumigant vapors are detected, move upwind from the treating area and allow vapors to clear before resuming the treatment. The chemicals have strong odors that cannot be tolerated. Vapam smells like rotten eggs, and chloropicrin rapidly brings tears to the eyes. Applicators should be especially cautious when applying chemicals in closed areas where airflow is limited.

Immediately after adding the chemical, plug the hole with tight-fitting wood dowels, preferably of the same species as the treated wood (Fig. 43). Remember to leave sufficient room (3 inches) in the treating hole so that the plug can be driven in without squirting the chemical. The plugs should be treated

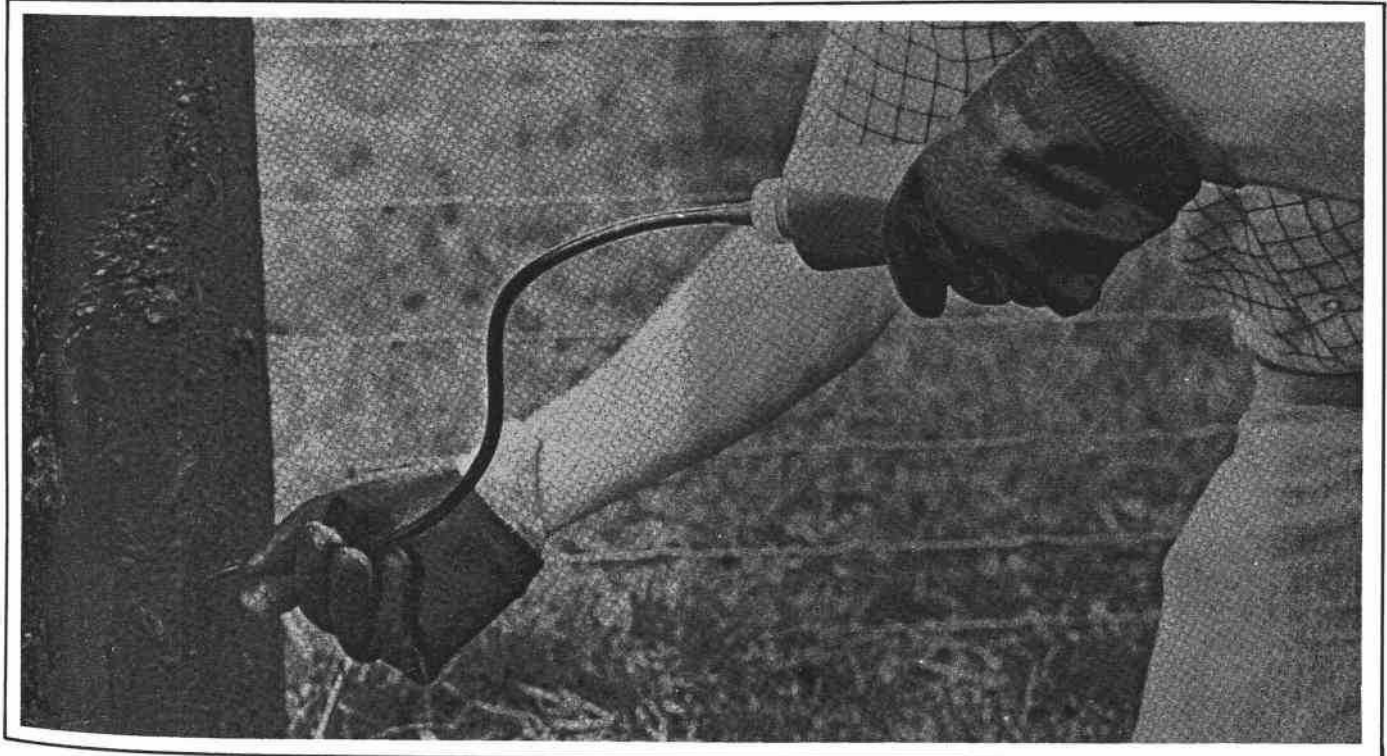

FIGURE 42.

A TUBE ATTACHED TO A 1-PINT SQUEEZE BOTTLE WILL CONTROL THE AMOUNT OF FUMIGANT PLACED IN HOLES. FROM GRAHAM AND HELSING (1979).

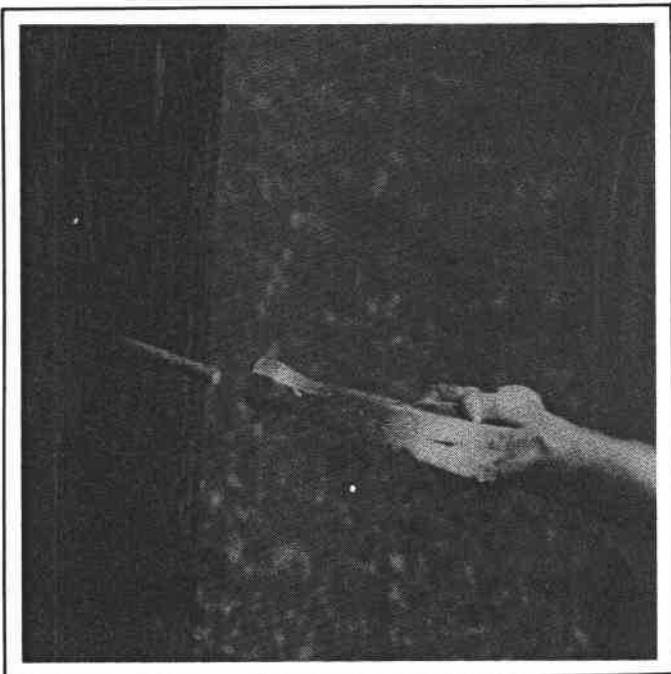

FIGURE 43.

AFTER FUMIGANT HAS BEEN ADDED, THE TREATING HOLE IS PLUGGED WITH A TIGHT-FITTING DOWEL.

with creosote if *Limnoria tripunctata* has not attacked and with inorganic salt if such attack has occurred. Drive the plugs slowly into the hole to avoid splitting the wood.

## RETREATMENT

Eventually, the fumigant will diffuse out of the wood and allow decay fungi to recolonize. Fortunately, complete diffusion occurs only after 10 to 15 years and can be remedied by placing additional fumigant into the same holes used for the first treatment. For such retreatment, drill or pull out the old plugs, add new fumigant to the treatment holes, and replug them. Because drilling out plugs frequently enlarges the hole and makes plugging difficult, a plug puller has been developed (Cantara and Graham 1983) (Fig. 44).

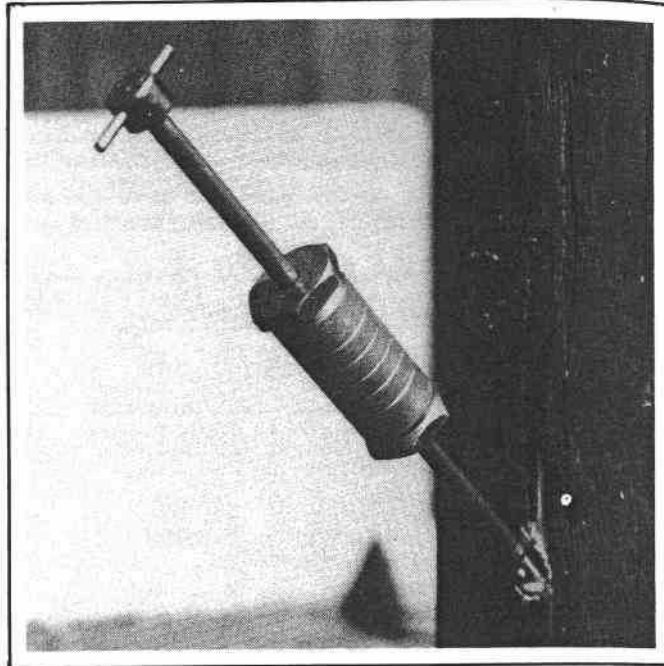

FIGURE 44.

A SLIDE-HAMMER ALLOWS PLUGS TO BE PULLED FROM FUMIGATED PILES WITHOUT ENLARGING THE TREATING HOLES.

Pretreatment may not last as long for fumigant-treated pile tops as it does for poles because the chemical is close to the top of the pile. Until treatment cycles are more clearly defined, the safest route is treatment at 10-year intervals with a regular inspection program at 5-year intervals to help determine when the piles need retreatment.

Although the progress of decay can be determined by measuring shell thickness with a probe, a far more efficient method is to measure shell thickness by removing wood cores and then to culture them for decay fungi. The presence of active fungi in the wood indicates that the protective effects of the fumigant have declined below a toxic threshold. Although this procedure requires the aid of trained technicians and is most applicable to large numbers of wood structures, some agencies specializing in the inspection of wood products are equipped to perform such procedures (Appendix D).

# PRECAUTIONS

- Chemicals used to treat wood in service are potentially toxic to humans and can damage the environment unless handled and used properly.
- Use products that have been registered for wood use by the U.S. Environmental Protection Agency.
- **READ THE LABEL**, and follow the prescribed safety precautions and application methods.
- Check with local, State, and Federal regulatory agencies about the use and disposal of these chemicals and their containers.
- Personnel applying the chemicals should be "Certified Pesticide Applicators"--check with local, State, and Federal agencies about the required training. Several sources of information are listed in Appendix D.

Because of the potential hazards from improper use or accidental spilling or splashing of these chemicals, applicators should:

- Work in pairs.
- Be trained in first aid.
- Wear appropriate protective clothing, usually goggles or face shields, gloves, and washable clothing.
- Use a respirator or full-face gas mask when applying fumigants in closed areas.
- Have an extra label of each chemical in use so that it can be given to a physician.
- Have readily available emergency addresses and phone numbers, phone number and location of nearest poison control center, washing material (soap and water), eye rinse.

## HAVE LABEL AND SAFETY MATERIALS AVAILABLE

Hospital \_\_\_\_\_

Phone \_\_\_\_\_

Poison Control Center \_\_\_\_\_

Phone \_\_\_\_\_

## LITERATURE CITED

- AGI, J. 1978. Non-destructive testing and structural analysis of in-place timber marine-piling. Proceedings, 4th Non-Destructive Testing Seminar. USDA Forest Service, Forest Products Laboratory, Madison, Wisconsin.
- AMERICAN WOOD-PRESERVERS' ASSOCIATION. 1983. Book of standards. Stevensville, Maryland.
- BEST, C.W., and G.W. MARTIN. 1969. Deep treatment of Douglas-fir poles. Proceedings, American Wood-Preservers' Association 65:223-226.
- CANTARA, G.M. 1983. Giving increment borers a new lease on life. Forest Industries 110(7):38-39.
- CANTARA, G.M., and R.D. GRAHAM. 1983. A slide hammer for pulling plugs in fumigated transmission poles. Forest Products Journal 33(5):45.
- CHANDLER, C.R. 1968. Experimental guardrail post: final report on a method of reducing post checking. Technical Report 68-4. Materials and Research Division, Oregon State Highway Department, Salem, Oregon.
- CHIDESTER, M.S. 1935. Temperatures necessary to kill fungi in wood. Proceedings, American Wood-Preservers' Association 31:316-324.
- CORDEN, M.E., and R.D. GRAHAM. 1983. Conserving energy by safe and environmentally acceptable practices in maintaining and procuring transmission poles for long service. 3rd Annual Report (unpublished), Cooperative Pole Research Program, Oregon State University, Corvallis, Oregon.
- GJOVIK, L.R., and R.H. BAECHLER. 1977. Selection, production, procurement and use of preservative treated wood. Supplementing Federal Specification TT-W-571. USDA Forest Service General Technical Report FPL-15. Forest Products Laboratory, Madison, Wisconsin.
- GRAHAM, R.D. 1973. Preventing and stopping internal decay of Douglas-fir poles. *Holzforschung* 27:168-173.
- GRAHAM, R.D. (Undated). Wood preservation minicourse. Slide-tape package. Forestry Media Center, Oregon State University, Corvallis.
- GRAHAM, R.D., and M.E. CORDEN. 1980. Controlling biological deterioration of wood with volatile chemicals. Final Report EL-1480. Electric Power Research Institute, Palo Alto, California.
- GRAHAM, R.D., and E.M. ESTEP. 1966. Effect of incising and saw kerfs on checking of pressure-treated Douglas-fir spar cross-arms. Proceedings, American Wood-Preservers' Association 62:155-158.
- GRAHAM, R.D., and G.G. HELSING. 1979. Wood pole maintenance manual: inspection and supplemental treatment of Douglas-fir and western redcedar poles. Research Bulletin 25. Forest Research Laboratory, Oregon State University, Corvallis, Oregon.
- GRAHAM, R.D., G.G. HELSING, and J.D. LEW. (Undated). Wood destroyers in the marine environment. Slide-tape package. Forestry Media Center, Oregon State University, Corvallis.
- GRAHAM, R.D., D.J. MILLER, and R.H. KUNESH. 1969. Pressure treatment and strength of deeply perforated Pacific Coast Douglas-fir poles. Proceedings, American Wood-Preservers' Association 62:155-158.
- GRAHAM, R.D., M.M. WILSON, and A. OTENG-AMOAKO. 1976. Wood-metal corrosion: an annotated survey. Research Bulletin 21. Forest Research Laboratory, Oregon State University, Corvallis, Oregon.
- GRAHAM, R.D., and R.J. WOMACK. 1972. Kiln- and Boulton-drying Douglas-fir pole sections at 220° to 290°F. Forest Products Journal 22:50-55.
- HELISING, G.G. 1979 (rev. 1981). Recognizing and controlling marine wood borers. Oregon State University Extension Marine Advisory Program Publication SG-49.
- HELISING, G.G., and R.D. GRAHAM. 1976. Saw kerfs reduce checking and prevent internal decay in pressure-treated Douglas-fir poles. *Holzforschung* 30:184-186.
- HELISING, G.G., and R.D. GRAHAM. 1981. Control of wood rot in waterfront structures. Oregon State University Extension Marine Advisory Program Publication SG-55.

---

HILL, C.L., and C.A. KOFOID, eds. 1927. Marine borers and their relation to marine construction on the Pacific coast. Final Report, San Francisco Bay Marine Piling Committee. University of California Press, San Francisco, California.

MALLON, M.H., and E. KILBE. 1979. Cathodic protection for boats in saltwater. Oregon State University Extension Marine Advisory Program Publication SG-46.

MILLER, D.J., and R.D. GRAHAM. 1977. Service life of treated and untreated fence posts--1976 progress report on the post farm. Research Paper 36. Forest Research Laboratory, Oregon State University, Corvallis, Oregon.

MORRELL, J.J., and M.E. CORDEN. 1984. Conserving energy by safe and environmentally acceptable practices in maintaining and procuring transmission poles for long service. 4th Annual Report (unpublished), Cooperative Pole Research Program, Oregon State University, Corvallis, Oregon.

O'NEILL, T.B., R.W. DRISKO, and H. HOCHMAN. 1961. *Pseudomonas creosotensis* sp. n.; a creosote-tolerant marine bacterium. Applied Microbiology. 9:472-474.

ROE, T. 1984. Maintenance of waterfront structures. P. 38-40 in Marine biodeterioration: an interdisciplinary study. (J.D. Costlow and R.C. Tipper, eds.) Naval Institute Press, Annapolis, Maryland.

RUDDICK, J.N.R., and N.A. ROSS. 1979. Effect of kerfing on checking of untreated Douglas-fir pole sections. Forest Products Journal 29(9):27-30.

STEIGER, F., and G. HORECZKO. 1982. The protection of timber piling from marine borer attack by application of plastic barriers. International Journal of Wood Preservation 2(3):127-129.

U.S. DEPARTMENT OF DEFENSE. 1974. Wood preservation: treating practice. Federal Specification TT-W-571J (AGR-AFS). Superintendent of Documents, Washington, D.C.

U.S. NAVY. 1965. Marine biology operational handbook: inspection, repair, and preservation of waterfront structures. NAVDOCKS MO-311. Bureau of Yards and Docks, Washington, D.C.

WAKEMAN, C.M., and L.L. WHITENECK. 1960. Extending service life of wood piles in seawater. P. 36-50 in ASTM Special Technical Publication No. 275, Treated wood in marine use. American Society for Testing Materials, Philadelphia, Pennsylvania.

WANGAARD, F.F. 1953. Tropical American woods for durable waterfront structures. P. T-1 through T-25 in Report of Marine Borer Conference, University of Miami, Coral Gables, Florida.

WILCOX, W.W. 1983. Sensitivity of the "pick test" for field detection of early wood decay. Forest Products Journal 33(2):29-30.

---

## BRITISH/METRIC CONVERSION

---

1 inch (in.)	= 2.54 centimeters (cm)
	= 25.40 millimeters (mm)
1 foot (ft)	= 0.30 meters (m)
	= 30.48 centimeters (cm)
1 cubic foot (ft <sup>3</sup> )	= 0.028 cubic meters (m <sup>3</sup> )
1 pound (lb)	= 453.592 grams (g)
32° Fahrenheit (F)	= 0° Celsius (C)
1 pint (pt)	= 0.473 liter (l)

---

# GLOSSARY OF TERMS

---

## **Anode**

Positive terminal toward which electrons flow in an electrolytic cell.

## **Bacteria**

Single-celled or filamentous microbes that lack chlorophyll and divide by fission (asexually). Bacteria are common on submerged wood, although their role is still unclear.

## **Brashness**

Failure of decayed wood in a direction perpendicular to the direction of applied force. Brashness is apparent with the pick test.

## **Brown rot**

Wood decay characterized by removal of cellulose and hemicellulose. Such rot causes rapid loss in strength and leaves a brownish, cracked wood residue.

## **Cathode**

Negative terminal from which electrons flow in an electrolytic cell.

## **Cellulose**

A long-chain polymer of  $\beta$ -D glucose that makes up 40 to 50 percent of the cell wall in wood.

## **Chloropicrin**

Fumigant consisting of trichloronitromethane, which has also been used for crowd control as tear gas.

## **Conk**

Common term for the hard, durable fruiting structures of many wood-decay fungi.

## **Corrosion**

Disintegration by a chemical process (e.g., rusting).

## **Fiber saturation**

Point at which no free water remains in cell lumens and below which wood begins to shrink as bound water is lost from cell walls (about 25 to 30 percent oven-dry basis).

## **Frass**

Wood waste that has passed through an arthropod's or insect's digestive tract.

## **Fungi**

Single-celled or filamentous organisms that lack chlorophyll and reproduce either sexually or asexually. Fungi feed on living and nonliving organic matter.

## **Gribble**

Common term for members of the genus Limnoria that burrow into the wood surface and cause the pile to take on an hourglass shape about the tideline.

## **Hemicellulose**

Short-chain polymers of various sugars that make up 20 to 35 percent of the cell wall of wood.

## **Hydrological**

Relating to water properties including salinity, temperature, and other characteristics.

## **Hyphae**

Hair-like strands of fungal tissue visible only through a microscope unless present in large numbers as mycelium or mycelial mats.

## **Incipient decay**

The point at which the presence of decay fungi can only be detected by microscopic or chemical examination.

## **Larvae**

Immature insects or arthropods that differ in structure or function from the adult stage.

## **Lignin**

Chemical consisting of a complex ring structure that makes up 30 to 35 percent of the cell wall of wood and renders the wood resistant to deterioration by many organisms.

## **Limnoria**

See Gribbles.

## **Lumen**

Void in the center of wood cells; functions in transport of liquids within the sapwood.

## **Mycelium**

A general term describing macroscopic masses of hyphae on the wood surface.

**Pholads**

Clam-like marine-boring mollusks in the genus Martesia or Xylophaga. Some species can cause extensive damage to wood in tropical marine environments.

**Pink Elephant**

A diver-controlled apparatus used to test piling sonically for shipworm damage.

**Polyethylene**

A plastic wrap used to protect wood from marine borer attack. Polyethylene may also be used as an inner liner in conjunction with PVC wraps on creosoted piles.

**Polyvinylchloride (PVC)**

A plastic wrap used to protect wood from marine borer attack and block oxygen movement at the water interface. PVC may become brittle with age; if so, it should be replaced with polyethylene.

**Riprap**

Large rock dumped around piles or jetties to support the structures or prevent erosion.

**Rot**

A term meaning advanced decay. Visible deterioration of the wood by decay fungi.

**Shell depth**

The amount of sound wood on the outside of a structural timber. This zone is critical for many strength properties.

**Shipworm**

Worm-like marine-boring mollusks in the genera Teredo or Bankia. They cause extensive damage by rasping away wood for their burrows.

**Soft rot**

Wood decay characterized by removal of all wood components and by rapid strength losses. The wood is left with a checked appearance.

**Spore**

Reproductive structure produced by bacteria, fungi, and some lower plants. Spores contain all the genetic material necessary to produce a replica of the original organism.

**Toxic threshold**

The chemical limit above which an organism fails to survive on a particular substratum. Toxic levels differ with organism, substrata, and environmental conditions.

**Tracheids**

Wood cells present in gymnosperms (e.g., pines). Tracheids function in supporting the plant and in water conduction.

**Vapam**

A mixture of 32.7 percent sodium N-methyldithiocarbonate commercially called "Wood-Fume." This chemical breaks down in wood to methylisothiocyanite.

**Vorlex**

A fumigant mixture containing 20 percent methylisothiocyanate and 80 percent C-3 hydrocarbons.

**White rot**

Wood decay characterized by removal of all wood components, especially lignin. White rot gradually reduces wood strength and leaves the wood a bleached color.

---

## CHECKLIST FOR PILE INSPECTION AND TREATMENT

---

**I. READ THIS MANUAL****II. INSPECTION****A. Above waterline**

1. Look for damage to piles, attaching members, or fasteners; note insect holes, surface decay, sawdust, and mud tunnels
2. Sound the pile with a hammer for internal rot pockets

3. Core suspicious areas and measure shell depth and depth of preservative penetration around the pile
4. Core at the pile top and near the widest check below the pile top. Measure solid shell depth and depth of preservative penetration in this core
5. Flood all inspection holes with preservative and plug with treated plugs
6. Reject bad piles--report dangerous piles

#### B. Below waterline (diving inspections)

1. Scrape fouling of the wood surface
2. Probe the surface for severe attack and look for shipworm siphons, gribble galleries, and an hourglass shape
3. Evaluate internal condition of the pile (either sonically or by coring)
4. Fill inspection holes with preservative grease and plug with treated plugs
5. Reject bad piles--report dangerous piles

### III. TREATMENT

#### A. Above waterline (internal)

1. Drill holes in spiral pattern within 6 feet of the pile top; avoiding checks, drill toward the center at a 45 to 50° angle. Do not drill through the pile
2. Wear protective clothing and glasses
3. Place chemical in bottom hole first and plug before filling next higher one. Follow safety precautions on the chemical label
4. Protect pile top with a ventilated watershedding cap

#### B. Below waterline (determine residual strength of pile and system that best maintains it)

##### 1. Barriers

###### a. Plastic

- (1) Attach 30-mil full-length plastic sheets (polyethylene or polyvinylchloride with a polyethylene liner) to piles and tighten around pile with semicircular lengths of wood
- (2) Where boats or debris may damage barriers, attach 150-mil polyethylene with aluminum nails
- (3) Use heat-shrinking system on the polyethylene prior to pile driving

###### b. Concrete

- (1) Attach form to wood 2 feet below mudline
- (2) Ensure that form is evenly attached to pile
- (3) Add cement grout so that it flows into the form below surface of grout already applied
- (4) Remove form if reusable and inspect barrier for defects

##### 2. Reinforcements (where deterioration is more severe)

###### a. Wood

- (1) Attach new preservative-treated section to cut-off pile with a drift pin
- (2) Attach new section to pile top by use of shims or blocks

###### b. Concrete

- (1) Cut off old pile to below waterline
- (2) Attach dowel to cut-off pile and attach special seal
- (3) Place reinforcement above cut-off pile and fit expendable form over seal
- (4) Pump concrete through valve at bottom of seal until desired height is reached



# APPENDIX A: ADDITIONAL REFERENCES

The following references are listed alphabetically by author under thirteen topics or categories: wood, seasoning, deterioration (corrosion), decay and stain fungi, insects, marine borers, general, preservation, maintenance, specifications, service records of treated wood, buildings, and films. Because some sources have issued more than one reference, these sources are listed and numbered below. If applicable, corresponding numbers appear at the left of the citations. Sources for other items are included with the citation.

## Sources

1. Eastern Forest Products Laboratory  
Department of the Environment  
Montreal Road  
Ottawa, Ontario, Canada K1A 0W5
2. Superintendent of Documents  
U.S. Government Printing Office  
Washington, D.C. 20402
3. Forest Research Laboratory  
College of Forestry  
Oregon State University  
Corvallis, Oregon 97331
4. Extension Service  
Oregon State University  
Corvallis, Oregon 97331
5. U.S. Forest Products Laboratory  
P.O. Box 5130  
Madison, Wisconsin 53705
6. Western Forest Products Laboratory  
Department of the Environment  
6620 Northwest Marine Drive  
Vancouver, B.C., Canada V6T 1X2
7. Forestry Media Center  
College of Forestry  
Oregon State University  
Corvallis, Oregon 97331

## WOOD

- 6 BARTON, G.M. 1973. Chemical color tests for Canadian woods. Free.
- CONTROLLER OF STATIONERY. 1951. Canadian woods, their properties and uses. Ottawa, Canada. 367 p. About \$3.
- 5 FOULGER, A.N. 1969. Classroom demonstrations of wood properties. PA-900. Free.
- 7 KRAHMER, R.L. Undated. Wood structure. Slide-tape package: 114 slides, 35 minutes. \$15 to rent, \$90 to purchase.

Details the anatomy of wood, how preservatives are retained, and why wood shrinks and swells.

- 5 LASSEN, L.E., and E.A. OKKONEN. 1969. Sapwood thickness of Douglas-fir and five other western woods. Research Paper 124. 16 p. Free.
- PANSHIN, A.J., and C. deZEEUW. 1970. Textbook of wood technology. 3rd edition. McGraw-Hill, Inc., 8171 Redwood Highway, Novato, CA 94947. 705 p. About \$25.  
This excellent book covers formation, anatomy, properties, and identification of wood.
- 2 U.S. DEPARTMENT OF AGRICULTURE. 1974. Wood handbook. Handbook 72. 421 p. About \$8.  
This is an invaluable storehouse of information about wood.
- WESTERN WOOD PRODUCTS ASSOCIATION. 1973. Western woods use book. 1500 Yeon Building, Portland, OR 97204. 316 p. About \$10.  
This book includes structural data and design tables, with chapters on wood preservation and fire protection.

## SEASONING

- 7 ESPENAS, L.D., and R.D. GRAHAM. Undated. How wood dries. Slide-tape package: 76 slides, 30 minutes. \$15 to rent, \$80 to purchase.  
Details the relationship of fiber walls to the swelling and shrinking of wood, the movement of water through wood, and how moisture changes affect wood.
- 3 GRAHAM, R.D., and R.J. WOMACK. 1972. Kiln- and Boulton-drying Douglas-fir pole sections at 220° to 290°F. Forest Products Journal 22(10):50-55.

- 5 JAMES, W.L. 1975. Electric moisture meters for wood. General Technical Report FPL-6. 27 p. Free.
- 5 JAMES, W.L. 1976. Effects of wood preservatives on electric moisture meter readings. Research Note FPL-0106. 20 p. Free.
- 2 REITZ, R.C., and R.H. PAGE. 1971. Air drying of lumber: a guide to industry practices. U.S. Department of Agriculture Handbook 402. 110 p. About \$1.
- SALAMON, M. 1969. High temperature drying and its effects on wood. Forest Products Journal 19:27-34.
- 6 SALAMON, M. 1971. Portable electric moisture meters for quality control. Informational Report VP-X-80. 36 p. Free.
- 5 USDA FOREST PRODUCTS LABORATORY. 1982. Drying of wood. 11 p. Free.

## DETERIORATION [CORROSION]

- 3 GRAHAM, R.D., M.M. WILSON, and A. OTENG-AMOAKO. 1976. Wood-metal corrosion: an annotated survey. Research Bulletin 21. 34 p. Free.

## DECAY AND STAIN FUNGI

- BOYCE, J.H. 1938 (revised 1961). Forest pathology. McGraw-Hill Book Company, Inc., New York. 600 p. About \$20.
- 5 DUNCAN, C.G., and F.F. LOMBARD. 1965. Fungi associated with principal decay in wood products in the United States. Research Paper WO-4. 31 p. Free.
- 5 ESLYN, W.E. 1970. Utility pole decay, Part II: Basidiomycetes associated with decay in poles. Wood Science and Technology 4:97-103.
- 3 GRAHAM, R.D., and D.J. MILLER. 1964. Staining of wood and its prevention. Special Report 2. 10 p.
- 5 SCHEFFER, T.C., and R.M. LINDGREN. 1940. Stains of sapwood and sapwood products and their control. Technical Bulletin 714. 124 p. Free.

## INSECTS

- 4 EVERY, R.W., and J.A. RUDINSKY. 1962. The golden Buprestid--a wood boring beetle. Extension Circular 713. 4 p. Free.
- 2 FURNISS, R.L., and V.M. CAROLIN. 1977. Western forest insects. U.S. Department of Agriculture Miscellaneous Publication 1339. 654 p. About \$9.
- 4 GOULDING, R.L., and J. CAPIZZI. 1971. Carpenter ant control. Extension Circular 627. 5 p. Free.
- 4 GOULDING, R.L., and R.W. EVERY. 1973. Dampwood termite control. Extension Circular 700. 5 p. Free.
- 2 JOHNSTON, H.R., and L.H. WILLIAMS. 1973. Controlling wood destroying beetles in buildings and furniture. U.S. Department of Agriculture Leaflet 558. 8 p. About \$0.35.
- 2 KOWAL, R.J., R.H. JOHNSTON, and R.A. ST. GEORGE. 1960. Subterranean termites--their prevention and control in buildings. Home and Garden Bulletin 64. 30 p. About \$0.50.
- WILLIAMS, L.H. 1973. Recognition and control of wood destroying beetles. USDA Forest Service, Southern Forest Experiment Station, P.O. Box 2008, Gulfport, MS 39503.

## MARINE BORERS

- 6 BRAMHALL, S. 1966. Marine borers and wooden piling in British Columbia waters. Department of Forestry Publication 1138. 68 p. Free.
- CLAPP, W.F., and R. KENK. 1963. Marine borers: an annotated bibliography. ACR-74. Office of Naval Research, Department of the Navy, Washington, D.C.
- HELSING, G.G. 1979. Controlling wood deterioration in waterfront structures. Sea Technology 6:20-21.

-- HELSING, G.G. 1979. Recognizing and controlling marine wood borers. Oregon State University Extension Service, Sea Grant Marine Advisory Program Publication SG-49. Corvallis, OR.

-- HELSING, G.G., and R.D. GRAHAM. 1981. Control of wood rot in waterfront structures. Oregon State University Extension Service, Sea Grant Marine Advisory Program Publication SG-55. Corvallis, OR.

-- HILL, C.L., and C.A. KOFOID. 1927. Marine borers and their relation to marine construction on the Pacific coast: final report of the San Francisco Bay Marine Piling Committee. University of California Press, Berkeley. 357 p.

This out-of-print book is a classic on marine borers.

-- RAY, D.L. 1959. Marine boring and fouling organisms. University of Washington Press, Seattle. 536 p. About \$9.

## GENERAL

7 GRAHAM, R.D., G.G. HELSING, and J.D. LEW. Undated. Wood destroyers in the marine environment. Slide-tape package: 75 slides, 15 minutes. \$15 to rent, \$80 to purchase.

Describes the organisms involved in marine wood deterioration, the nature of their attack on wood, and conditions that favor their development.

-- MEYER, R.W., and R.M. KELLOGG (Editors). 1982. Structural uses of wood in adverse environments. Van Nostran Reinhold Company, New York. 510 p.

## PRESERVATION

-- AMBURGEY, T.L. 1971. Annotated bibliography on prevention and control of decay in wooden structures (including boats). USDA Forest Service, Southern Forest Experiment Station, P.O. Box 2008, Gulfport, MS 39503. 123 p. Free.

-- BEST, C.W., and G.E. MARTIN. 1969. Deep treatment of Douglas-fir poles. Proceedings, American Wood-Preservers' Association 65:223-226.

5 BLEW, J.O., Jr. 1955. Study of the preservative treatment of lumber. Report 2045. 40 p. Free.

-- BLEW, J.O., Jr. 1961. Results of preservative treatment of Douglas-fir from different areas. Proceedings, American Wood-Preservers' Association 57:200-212.

-- BOULTON, S.B. 1884. On the antiseptic treatment of timber. Minutes of Proceedings, Institution of Civil Engineers (London) 78:97-211.

This wood-preserved's "gem" is well worth the search.

-- BROWN, D.L., and D.F. DAVIDSON. 1961. Field tests of relative strength of incised fir poles. Portland General Electric Co., 621 SW Alder Street, Portland, OR 97205. Free.

-- CARTWRIGHT, K.S.G., and W.P.K. FINDLAY. 1950. Decay of timber and its prevention. Chemical Publishing Co. Inc., New York. 294 p.

7 GRAHAM, R.D. Undated. Pressure wood-preserving processes. Slide-tape package: 119 slides, 24 minutes. \$15 to rent, \$90 to purchase.

Discusses the uses of pressure-treated wood, how wood is prepared for treating, and how the treating processes work.

7 GRAHAM, R.D. Undated. Wood preservation microcourse. Slide-tape package; 80 slides, 22 minutes. \$15 to rent, \$80 to purchase.

Briefly explains the principal concepts of the structure, drying, and pressure-treating of wood.

7 GRAHAM, R.D. Undated. Wood preservation minicourse. Slide-tape package: 144 slides, 50 minutes. \$15 to rent, \$100 to purchase.

Provides a condensed explanation of wood structure, how wood dries, penetration of preservatives into wood, and pressure wood-preserving processes.

-- GRAHAM, R.D., and E.M. ESTEP. 1966. Effect of incising and saw kerfs on checking of pressure-treated Douglas-fir spar crossarms. Proceedings, American Wood-Preservers' Association 62:155-158.

- GRAHAM, R.D., D.J. MILLER, and R.H. KUNESH. 1969. Pressure treatment and strength of deeply perforated Pacific coast Douglas-fir poles. Proceedings, American Wood-Preservers' Association 65:234-241.
- GRASSEL, E.H. 1969. Field test of deeply incised treated Douglas-fir poles. Report LR-19412. Branch of Laboratories, Bonneville Power Administration, P.O. Box 491, Vancouver, WA 98660. Free.
- HELSING, G.G., and R.D. GRAHAM. 1976. Saw kerfs reduce checking and prevent internal decay in pressure-treated Douglas-fir poles. *Holzforschung* 30:184-186.
- KILBORN, K. 1971. A guide to establishing a pressure-treating plant for small sawed and round wood products in Colorado. Department of Forest and Wood Sciences, Colorado State University, Fort Collins. 50 p. Free.
- 3 KRAHMER, R.L. 1961. Anatomical features of permeable and refractory Douglas-fir. *Forest Products Journal* 11:439-441. Free.
- 7 LIN, R.T., D.J. MILLER, and R.D. GRAHAM. Undated. Penetration of liquids into wood. Slide-tape package: 80 slides, 20 minutes. \$15 to rent, \$85 to purchase. Covers theoretical aspects of fluid flow as related to the treating process, movement of preservatives through wood, and practical aspects of preservation.
- MacLEAN, J.D. 1952. Preservative treatment of wood by pressure methods. U.S. Department of Agriculture Handbook 40. 160 p.  
Although this book is out of print, it is an excellent reference if you can get a copy.
- MILLER, D.J., and R.D. GRAHAM. 1963. Treatability of Douglas-fir from western United States. Proceedings, American Wood-Preservers' Association 59:218-222.
- NICHOLAS, D.D. (Editor). 1973. Wood deterioration and its prevention by preservative treatments. Volume 1--Degradation and protection of wood. Volume 2--Preservatives and preservative systems. Syracuse University Press, Syracuse, NY. 402 p. (both volumes combined). About \$20 for Vol. 1, \$22 for Vol. 2.
- These volumes, detailed analyses of available knowledge by 17 authors, include numerous references plus recommendations for future research.
- REDDING, L.W. 1971. Resistance of timbers to impregnation with creosote. Her Majesty's Stationery Office, London, England, Bulletin 54. 43 p.
- RESCH, H., and D.G. ARGANBRIGHT. 1971. Location of pentachlorophenol by electron microprobe and other techniques in cellon-treated Douglas-fir. *Forest Products Journal* 21:38-43.
- 6 ROFF, J.W., R.S. SMITH, A.J. CSERJESI, and P.A. COOPER. 1975. Protection and preservation of wood in service: questions and answers. Informational Report VP-X-145. 42 p. Free.
- 5 USDA FOREST PRODUCTS LABORATORY. 1983. Performance of wood in fire. 8 p. Free.
- 5 USDA FOREST PRODUCTS LABORATORY. 1982. Biodegradation and preservation of wood. 10 p. Free.
- VAN GROENOU, H.B., H.W.L. RISCHEN, and J. VAN DEN BERGE. 1951. Wood preservation during the last 50 years. A.W. Sijthoff's Uitgeversmaatschappij N.V., Leiden, Holland. 318 p.
- WOOD, L.W., E.C.O. ERICKSON, and A.W. DOHR. 1960. Strength and related properties of wood poles: final report. American Society for Testing and Materials, 1916 Race Street, Philadelphia, PA 19103. 83 p.

## MAINTENANCE

- 5 AGI, J. 1978. Nondestructive testing and structural analysis of in-place timber marine piling. Proceedings, 4th Nondestructive Testing Seminar.
- AGI, J. 1983. Structural evaluation of marine structures. Proceedings, Specialty Conference on Port Modernization, Upgrading and Reports, American Society of Chemical Engineers 662-677.

- AMERICAN ASSOCIATION OF PORT AUTHORITIES. 1970. Port maintenance. Washington, D.C. 224 p. About \$15.
- AMERICAN WOOD-PRESERVERS' ASSOCIATION. 1972. A guideline for the physical inspection of poles in service. Standard M12-72. Washington, D.C. 2 p.
- 5 CLARK, J.W., and W.E. ESLYN. 1977. Decay in wood bridges: inspection and preventive and remedial maintenance. 51 p. Free.
- CONDON, E.J., and R.D. GRAHAM. Undated. Preventing decay in wood boats. Oregon State University Extension Service, Sea Grant Marine Advisory Program Publication SG-23. Corvallis, OR.
- ESLYN, W.E., and J.W. CLARK. 1976. Appraising deterioration in submerged piling. *Material und Organismen* 3(Suppl.): 43-52.
- 3 GRAHAM, R.D. 1973. Preventing and stopping internal decay of Douglas-fir poles. *Holzforschung* 27:168-173. Free.
- GRAHAM, R.D. 1977. Fumigants control decay in wood poles. *Electrical World, Transmission/Distribution*, April 15, p. 53-54.
- GRAHAM, R.D. 1979. Getting the most from wood: some questions and answers on the performance of waterfront structures. *Marine Trade Flyer #14*, New York Sea Grant Program, Cornell University, Ithaca.
- GRAHAM, R.D., and M.E. CORDEN. 1977. Controlling biological deterioration of wood with volatile chemicals. Electric Power Institute EL-366 Project: 212-1, Interim Report 1. Research Reports Center, P.O. Box 10090, Palo Alto, CA 94303. 61 p. About \$4.
- This report comprehensively reviews wood preservation research up to 1977 at the Forest Research Laboratory at Oregon State University, and lists pertinent references.
- GRAHAM, R.D., G.G. HELSING, and J.D. LEW. 1976. Fumigants control wood piling decay. *World Ports/American Seaport* 39:18-19.
- 3 GRAHAM, R.D., and J.S. MOTHERSHEAD. 1967. Inspecting and treating western redcedar and Douglas-fir poles in service. *Informational Circular* 21. 34 p. Free.
- GRAHAM, R.D., and T.C. SCHEFFER. 1973. Bioassay estimation of protection in spray treated western redcedar poles. *Forest Products Journal* 23:106-109.
- GRAHAM, R.D., and T.C. SCHEFFER. Undated. Preventing and stopping internal decay of poles. Slide-tape package: 80 slides, 30 minutes. \$15 to rent, \$80 to purchase.
- Discusses factors that contribute to the internal decay of poles, and shows practices to prevent internal decay in new poles and to stop internal decay of poles in service.
- 3 HELSING, G.G., and R.D. GRAHAM. 1980. Protecting cutoff tops of Douglas-fir piles from decay. *Forest Products Journal* 30(2):23-25. Free.
- 1 KRZYZEWSKI, J. 1972. Five year performance of slow release type ground line preservatives in creosoted pine poles. *Informational Report OP-X-44*. 14 p. Free.
- 5 MAEGLIN, R.R. 1979. Increment cores: how to collect, handle, and use them. *General Technical Report FPL* 25. 18 p.
- MILLER, B.D., F.L. TAYLOR, and R.A. POPECK. 1967. A sonic method for detecting decay in wood poles. *Proceedings, American Wood-Preservers' Association* 61:109-113.
- 3 MOTHERSHEAD, J.S., and R.D. GRAHAM. 1962. Inspection and treatment of poles in service--a survey. *Mimeographed Report P-6*. 63 p. Free.
- 3 MOTHERSHEAD, J.S., and S.S. STACEY. 1965. Applicability of radiography to inspection of wood products. Pages 307-336 in *Proceedings, Second Symposium on Non-destructive Testing of Wood*. Spokane, WA. 243 p. Free.
- 5 PANEK, E., J.O. BLEW, Jr., and R.H. BAECHLER. 1961. Study of groundline treatments applied to five pole species. *Report* 227. 12 p. Free.

3 RICARD, J.L., and J.S. MOTHERSHEAD. 1966. Field procedure for detecting early decay. Forest Products Journal 16(7):58-59. Free.

1 ROFF, J.W., and J. KRZYZEWSKI. 1976. In-service assessment of load capacity, decay, and retreatment of utility poles. Report OPX45E. 11 p. Free.

-- RURAL ELECTRIFICATION ADMINISTRATION. 1974. Pole inspection and maintenance. Bulletin 161-4. U.S. Department of Agriculture, Washington D.C. 20250. 50 p. Free.

-- SCHEFFER, T.C. 1971. A climate index for estimating potential for decay of wood structures above ground. Forest Products Journal 21:25-31.

3 SCHEFFER, T.C., and J.D. LEW. 1976. Bioassay of residual preservative protection in wood. Forest Products Journal 26(7):45-50. Free.

-- SHIGO, A.L., W.C. SHORTLE, and J. ORCHRYMOWYCH. 1977. Detection of active decay at groundline in utility poles. General Technical Report NE-35. USDA Forest Service, Northeastern Forest Experiment Station, 6816 Market Street, Upper Darby, PA 19082. 26 p. Free.

-- SMITH, D.H., and R. COCKCROFT. 1967. The remedial treatment of telephone and electric transmission poles. Wood (England), September-November. 12 p.

-- U.S. DEPARTMENT OF THE NAVY. 1965. Marine biology operational handbook--inspection, repair, and preservation of waterfront structures. NAVDOCKS MO-311. Bureau of Docks, Washington, D.C. 20390.

## SPECIFICATIONS

-- AMERICAN NATIONAL STANDARDS INSTITUTE (ANSI). 1972. Specifications and dimensions for wood poles--05.1-1972. 1430 Broadway, New York 10018. 20 p. About \$2.

-- AMERICAN WOOD-PRESERVERS' ASSOCIATION (AWPA). Current edition. Book of standards. Suite 444, 7735 Old Georgetown Road, Bethesda, MD 20014. About \$15.

This book, updated periodically, gives national standards for treated wood products and the chemicals used to preserve them.

5 GJOVIK, L.R., and R.H. BAECHLER. 1977. Selection, production, procurement, and use of preservative treated wood: supplementing federal specification TT-W-571. General Technical Report FPL-15. 37 p. Free.

-- U.S. GENERAL SERVICES ADMINISTRATION. Latest revision. Wood preservation: treating practices. Federal specification TT-WO-571. Single copies are free from Business Service Centers at regional offices of the U.S. General Services Administration.

## SERVICE RECORDS OF TREATED WOOD

-- AMERICAN WOOD-PRESERVERS' ASSOCIATION. 1966. Post service records. Report of Committee U-5. Proceedings, American Wood-Preservers' Association 62:60-130.

This publication lists agencies engaged in testing treated materials. It also includes the results of extensive tests of untreated and treated posts of many woods.

5 GJOVIK, L.R., and H.L. DAVIDSON. 1977. Comparison of wood preservatives in Mississippi post study. Research Note FPL-01. 16 p. Free.

5 GJOVIK, L.R., and H.L. DAVIDSON. 1977. Comparison of wood preservatives in state tests. Research Note FPL-02. 79 p. Free.

## BUILDINGS

5 BLACK, J.M., D.F. LAUGHNAN, and E.A. MRAZ. 1972. Forest Products Laboratory natural finish. FPL-046. 7 p. Free.

3 GRAHAM, R.D. 1977. Useful information for the home owner and builder. 7 p. Free.

3 LATTIN, J.A. (Editor). 1978. Protect your home against decay and insects. 26 p. Free.

- 5 SCHEFFER, T.C., and A.F. VERRAL. Principles for protecting wood buildings from decay. 56 p. Free.
- 5 USDA FOREST PRODUCTS LABORATORY. 1967. Bleaching wood. 9 p. Free.
- 5 USDA FOREST PRODUCTS LABORATORY. 1978. List of publications on finishing. 5 p. Free.
- 5 USDA FOREST PRODUCTS LABORATORY. 1972. Wood finishing: painting outside wood surfaces. 4 p. Free.

## FILMS

- U.S. NAVY. Undated. Wood preservation: Control of wood destroying organisms. No. MN-8167b. 22 minutes. Naval Facilities Engineering Command, 200 Stovall Street, Alexandria, VA 22332. Attn: Applied Biology Section.
- U.S. NAVY. Undated. Wood preservation: Inspection for wood destroying organisms. No. MN-8167a. 20 minutes. Naval Facilities Engineering Command, 200 Stovall Street, Alexandria, VA 22332. Attn: Applied Biology Section.

# APPENDIX B: AMERICAN WOOD PRESERVERS' ASSOCIATION STANDARD C18-77, STANDARD FOR PRESSURE TREATED MATERIAL IN MARINE CONSTRUCTION<sup>1</sup>

## 1. Specific Requirements

1.1 Piles and timbers in marine construction shall be treated in accordance with the requirements of American Wood-Preservers' Association Standard C1, "Standard for Preservative Treatment by Pressure Processes--All Timber Products," except as supplemented herein.

1.5 Framing.--Pile cutoffs, bolt holes, and field cuts shall be protected in accordance with AWWA Standard M4 [Standard for the care of preservative-treated wood products].

1.51 The lower bracing timbers shall be attached to the piles at a minimum height of 3.5 feet above mean low water for marine structures at sites where the tide range is 6 feet or less, and at middle elevation for tidal ranges exceeding 6 feet.

1.6 Incising.--Coastal Douglas-fir, western hemlock, western larch, intermountain

Douglas-fir, redwood, jack pine, lodgepole pine, and red pine lumber shall be incised.

1.8 Branding.--All products shall be branded in accordance with AWWA Standard M1 [Standard for the purchase of treated wood products].

1.82 Piles.--Each pile shall be branded at points 5 feet and 10 feet from the butt end of the pile unless other measurements are specified by the customer. The standard brand shall be used except that only the length shall be shown on the bottom line of the brand.

## 3. Results of Treatment

3.1 Retention--pcf [pounds per cubic foot of wood]. The minimum retentions are listed in the table below. Preservative retention shall be determined by assay method.

Section 1.11--In those areas where *Teredo* and *pholad* are expected or known and where *Limnoria tripunctata* are not prevalent, creosote or creosote-coal tar solution treatment will provide adequate protection.

<sup>1</sup> Reprinted with permission of the American Wood-Preservers' Association.

Section 1.12--In those areas where Teredo and Limnoria tripunctata are expected or known and where pholad attack is not prevalent, either dual treatment or high retentions of ACA or CCA treatment will provide adequate protection.

Section 1.13--In those areas where Limnoria tripunctata and pholad attack are expected or known, the dual treatment provides the maximum protection known at present.

Marine Piling--Specific Requirements of Use for Treated Wood Subject to Exposure of Marine Borers

Marine Boring Organism	Type of Treatment			Dual <sup>1</sup>
	Creosote and Creosote-Coal Tar Solutions	Water-borne Preservatives (CCA and ACA)		
<u>Teredo</u>	<sup>2</sup> S	S		S
Pholads	S	<sup>3</sup> X		S
<u>Limnoria tripunctata</u>	X	S		S

<sup>1</sup> Method as defined in paragraph 2.13 of C1.

<sup>2</sup> (S) Satisfactory for use where the particular boring organism is present.

<sup>3</sup> (X) Maximum service life will not be obtained when water-borne salts are used where pholads are known to attack and when creosote and creosote solutions are used where Limnoria tripunctata are known to attack.

Round Timber Piles Exposed to Moderate or Severe Marine Borer Hazard

	Southern Pine, Red Pine	Coastal Douglas-fir	Oak	AWPA Standard
Moderate Borer Hazard				
Creosote <sup>1</sup>	20.0	20.0	10.0	C3
Creosote-coal-tar <sup>1</sup>	20.0	NR	10.0	C3
Severe Borer Hazard				
<u>Limnoria tripunctata</u> only				
ACA <sup>2</sup>	2.50 and 1.50	2.50	NR <sup>3</sup>	C3
CCA <sup>2</sup>	2.50 and 1.50	2.50	NR	C3
<u>Limnoria tripunctata</u> and Pholads (Dual treatment)				
First treatment				
ACA	1.00	1.00	NR	C3
CCA	1.00	1.00	NR	C3
Second treatment				
Creosote <sup>4</sup>	20.0	20.0	NR	C3
Creosote-coal tar <sup>4</sup>	20.0	NR	NR	C3

<sup>1</sup> When these preservatives are specified for material to be used in salt water, the creosote-coal tar shall conform to Standard P12 [Standard for creosote-coal tar solution to be used in the treatment of marine (coastal waters) piles and timbers], and the creosote shall conform to Standard P13 [Standard for coal tar-creosote to be used in the treatment of marine (coastal waters) piles and timbers].

<sup>2</sup> The assay retentions for southern pine and red pine are based on two assay zones--0 to 0.50 inch and 0.50 to 2.0 inches.

<sup>3</sup> NR--Not recommended.

<sup>4</sup> Creosote-coal tar will conform to Standard P2 [Standard for creosote and creosote solutions] or P12. Creosote will conform to Standard P1 [Standard for coal tar-creosote for land and freshwater use] or P13.



Other Members Used in Marine Construction

Material and Usage	Creosote	Creosote-Coal Tar	Creosote-Petroleum	Penta-chloro-phenol	ACC	ACA	CCA	AWPA Standards <sup>1</sup>
<b>Timber and Plywood Exposed to Tides or Wave Action:</b>								
Southern Pine	25.0	25.0	NR	NR	NR	2.50	2.50	C2
Coastal Douglas-fir and Western Hemlock	25.0	NR	NR	NR	NR	2.50	2.50	C2
Plywood	25.0	25.0	NR	NR	NR	2.50	2.50	C9
<b>Members Out of Water but Subject to Salt Water Splash and in Ground Contact:</b>								
<b>Timber, Lumber and Plywood:</b>								
Southern Pine, Coastal Douglas-fir, Western Hemlock	12.0	12.0	12.0	0.60	NR	0.60	0.60	C2, C9
<b>Members Out of Water and Not Subject to Salt Water Splash and Not in Ground Contact:</b>								
<b>Timber, Lumber and Plywood:</b>								
All Softwood Species	10.0	10.0	10.0	0.50	0.50	0.40	0.40	C2, C9
<b>Structural Lumber in Salt Water:</b>								
Southern Pine	25.0	25.0	NR	NR	NR	2.50	2.50	C2
Coastal Douglas-fir, Hemlock	25.0	NR	NR	NR	NR	2.50	2.50	C2
<b>Structural Lumber in Salt Water--Dual Treatment</b>								
<b>Southern Pine:</b>								
First treatment	NR	NR	NR	NR	NR	1.50	1.50	C2
Second treatment	20.0	20.0	NR	NR	NR	NR	NR	C2
<b>Coastal Douglas-fir, Western Hemlock:</b>								
First treatment	NR	NR	NR	NR	NR	1.50	1.50	C2
Second treatment	20.0	20.0	NR	NR	NR	NR	NR	C2

<sup>1</sup> C2 = Lumber, timbers, bridge ties and mine ties--preservative treatment by pressure processes.

C9 = Plywood--preservative treatment by pressure processes.

## APPENDIX C: CULTURING FUNGI FROM WOOD TO DETECT EARLY DECAY<sup>1</sup>

Advanced decay in a wood pole can be visually detected in cores taken with an increment borer, and those same cores can be measured for shell depth and depth of preservative penetration. However, early decay--which is

invisible--must be detected in the laboratory.

To detect invisible decay, place each core in a plastic straw which is stapled shut at the ends and labeled with line, pole number, core location, and other information. The cores should be brought to a laboratory and cultured within 24 hours--those that cannot be cultured within that period should be stored in a refrigerator.

<sup>1</sup> Written by Jonathan D. Lew while he was a research assistant with the Forest Research Laboratory, Oregon State University, Corvallis. Lew is now staff research assistant, University of California Forest Products Laboratory, Richmond, California.

Culturing, one of the most reliable methods for detecting early decay in wood, involves sterilizing the surface of the core, embedding it in sterile nutrient media, and incubating it 3 to 4 weeks at 20° to 27°C. Cores are observed weekly for fungal growth, which is microscopically examined after 3 to 4 weeks for characteristics of a decay fungus.

## EQUIPMENT

- Small pair of forceps
- Alcohol (95% ethanol)
- Alcohol lamp or small Bunsen burner
- Scissors
- Culture dishes with nutrient media
- Wax pencil or felt tip marker
- Autoclave
- Balance accurate to 0.1 g
- Incubator or room at 21° to 27°C.

## CULTURING AREA

The atmosphere contains spores of fungi and bacteria that can fall into the nutrient media during the culturing process, germinate, and contaminate the culture plate. To reduce contamination, keep the work area free of dust, drafts, and fungus-infested material. Before culturing, wipe down the work area with 95 percent ethanol or another suitable disinfectant. Work on a cloth dampened with disinfectant, or periodically clean the bench top with ethanol. If contamination problems persist, consider purchasing a tissue culture hood or a laminar flow, clean air bench. The tissue culture hood is a cabinet with an ultraviolet (UV) germicidal lamp that is switched on when the hood is not in use (UV radiation damages the eyes) to sterilize the cabinet interior. The laminar flow bench blows "sheets" of filtered air across the working surface in one direction to keep contaminating particles from falling into culture dishes.

## NUTRIENT MEDIA

Wood-rotting fungi are commonly cultured on an agar medium containing 2 percent malt extract.

To make the agar:

1. In a 2,000-ml Erlenmeyer flask, add 1,000 ml of distilled water, 15 g of agar, and

20 g of malt extract. Malt extract is quite hygroscopic, so weigh and dispense it quickly. Swirl or stir until most of the malt extract is well suspended in solution. Cover the flask with aluminum foil, or plug it with a wad of cotton. Agar content can be varied to change the hardness of the medium.

2. Place the flask in an autoclave for 20 minutes at 15 psi.
3. Turn off the autoclave, and allow it to cool slowly. Using an exhaust cycle before the chamber has reached atmospheric pressure will cause the medium to boil over.
4. Wipe off the working surface with 95 percent ethanol. Arrange 35 to 40 Petri dishes in stacks of 2 or 3 dishes each. Use either disposable dishes (presterilized polystyrene) or reusable glass dishes (autoclaved, washed, and oven-sterilized at 110°C for 8 hours).
5. Cool the medium to about 45° to 50°C. At this temperature, you should be able to touch the side of the culture flask to your face.
6. Pour the medium into the dishes. Pour from the flask, or transfer a portion of medium to a smaller sterile vessel (e.g., a 500-ml Erlenmeyer flask) before pouring. Cover the bottom of the Petri dish with a layer of medium 3 to 5 mm deep. Work quickly when pouring, and twirl the flask frequently to prevent the medium from solidifying. To reduce contamination when pouring, tip up one side of the Petri dish cover to expose as little of the medium as possible.
7. The malt agar should solidify and be ready for use in about 30 minutes.

## ENHANCING RECOVERY OF DECAY FUNGI

Decay fungi frequently coexist with both non-decay fungi and bacteria. If you only want to detect early decay, you can eliminate these nondecay and bacterial organisms from your cultures by adding certain chemicals to malt agar. Such media (e.g., Russell 1956, Hunt and Cobb 1971) selectively inhibit the growth

of nondecay fungi and bacteria without appreciably affecting the growth of decay fungi.

For controlling nondecay fungi, especially from Douglas-fir poles, we recommend a medium containing 10 parts per million (ppm) of Benlate [Benomyl].

Vigorously shake 20 mg of Benlate and 20 ml of sterile distilled water in a sterile screw-cap tube to form a suspension, not a solution. Add this mixture to 1,000 ml of malt agar. To control bacteria, add 3.0 ml of lactic acid per 1,000 ml of malt agar. Before adding either the Benlate mixture or the lactic acid, be sure the medium has cooled to about 50°C.

## CULTURING FUNGI FROM INCREMENT CORES

By now you have made up nutrient media dishes and wiped down your culture area--you are now ready to plate the cores. This can be done many ways, depending on personal preference. The important point in trying to culture fungi is to prevent contamination of the plate by airborne spores. Follow this general procedure to aseptically plate cores:

1. Work on a disinfectant-dampened cloth or a sterile paper towel. Wipe down the bench with [70] percent ethanol.
2. Label the dish cover with the information on the straw (line, pole number, location of core).
3. Snip off the end of the straw, and remove the core. If the core is badly broken due to decay or a dull increment borer, use the crease of a paper towel to keep the pieces oriented. If the core is not broken, break it into 2 or 3 segments that will fit into the Petri dish.
4. Sterilize the forceps by dipping them in alcohol and igniting them in the burner flame. [Do not hold the forceps in the flame.]
5. Flame the core segments to destroy superficial contaminants on the surface. Hold the core segment with sterile forceps, and pass it through the gas or alcohol flame for 2 to 3 seconds, momentarily exposing all surfaces directly to the flame.

Scorching the core, other than a slight browning of edges, may kill the fungi in the wood.

6. While holding the flamed core with the forceps in one hand, use the other hand to tip up one side of the Petri dish cover just enough to place the core segment onto the agar surface. With the forceps, push down on the core segment to embed it in the agar. Close the dish at once.
7. Repeat steps 4, 5, and 6 until the entire core has been placed in the dish with as much distance as possible between segments. Whenever a dish is open, keep the cover over the exposed agar surface to prevent contamination.
8. Stack the dishes in a cardboard or plastic box with a closable top or in a temperature-controlled incubator at 21° to 27°C.

## IDENTIFICATION

Observe cultures once a week for 3 to 4 weeks. Note the presence, color, and texture of fungi growing from the core. In addition, be sure to note the presence of fungal or bacterial contaminants not growing directly from the core. On the underside of the dish, circle each contaminant with a wax pencil or felt-tip pen to ensure [its] recognition later. If a culture becomes badly contaminated, you may have to transfer the uncontaminated portion of the core to another dish.

Cultures from infected wood frequently yield a mixture of decay and nondecay fungi. In many cases, these two groups can be separated on the basis of color, texture, and growth rate of the fungal mycelia. In culture, nondecay fungi generally are fast-growing and dark-colored, although the mycelia of many nondecay fungi are white initially and then darken. Decay fungi tend to grow rather slowly, and they have a white color and a downy, cottony, or felty texture. [With] these criteria, the greenish fungus that covers the dish in a few days to a week [can be identified as fitting] into the nondecay group; the white, cottony fungus that becomes prominent after 2 to 3 weeks is probably decay. Although color, texture, and growth rate are helpful characteristics for differentiating between decay and nondecay fungi, sometimes positive identification requires a light

microscope. Some nondecay fungi are white or off-white, whereas the white mycelia of some decay fungi are tinged with pink, yellow, or brown.

## MICROSCOPIC EXAMINATION OF CULTURES

You will be able to view the individual spores and hyphae of fungi with a microscope. The hyphae of most wood-rotting Basidiomycetes (general classification of wood rotters) possess clamp connections--small, characteristically shaped bumps that arise as a result of cell division (Exhibit C-1). Only decay fungi have clamp connections, but sometimes they are rare or difficult to see. Nobles (1965) details the identification of decay fungi.

In addition to the absence of clamp connections, nondecay fungi are characterized by a wide variety of distinctively shaped spores, usually present in great numbers, and spore-bearing apparatuses. Barron (1972) and Barnett and Hunter (1972) have written keys to the Fungi Imperfecti, many of which inhabit wood as nondecay organisms.

A "squash mount" is the most common way to view fungi under the microscope. Place a drop of mounting medium on a microscope slide;

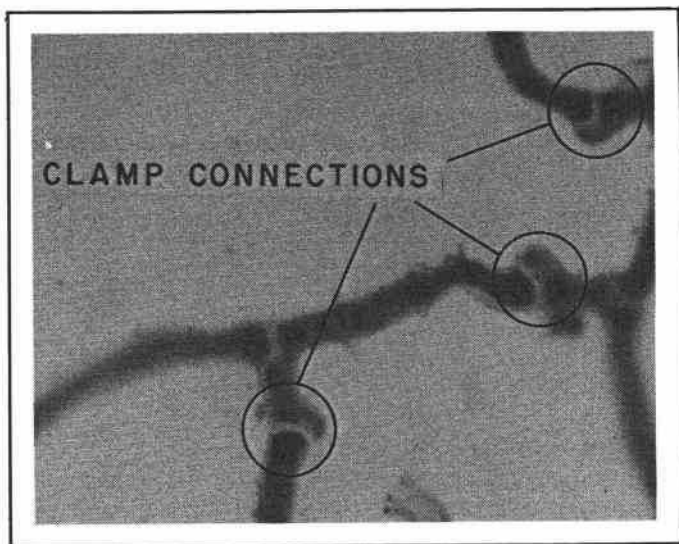

EXHIBIT C-1.

HYPHAL STRANDS OF A DECAY FUNGUS VIEWED UNDER THE MICROSCOPE. CIRCLES MARK CLAMP CONNECTIONS CHARACTERISTIC OF DECAY FUNGI.

cut out a bit of the fungus with a dissecting needle; put it in the mounting medium; and cover the fungus with a cover slip, being careful not to trap any air bubbles near the fungus. You can use a variety of solutions to make mounts, including water, glycerin, lactophenol, and 5 percent potassium hydroxide. Phloxine dye and 5 percent potassium hydroxide are commonly used for decay fungi. Lactophenol dyed with a little cotton blue may be helpful [in viewing] nondecay fungi.

With patience and practice, you should be able to distinguish decay fungi from nondecay fungi. However, positive identification of any fungi to the generic or specific level should be left to a mycologist.

You may find an agar-stick breaking-radius test a reasonably rapid means for differentiating between decay and nondecay fungi (Safo-Sampah and Graham 1976). Decayed sticks can be broken easily with one's fingers.

## LITERATURE CITED

BARNETT, H.L., and B.B. HUNTER. 1972. Illustrated genera of imperfect fungi. Third edition. Burgess Publishing Co., Minneapolis, Minn. 241 p.

BARRON, G.L. 1972. The genera of hyphomycetes from soil. Robert E. Krieger Publishing Co., Huntington, N.Y. 364 p.

HUNT, R.S., and F.W. COBB. 1971. Selective medium for the isolation of wood-rotting basidiomycetes. Canadian Journal of Botany 49:2064-2065.

NOBLES, M.K. 1965. Identification of cultures of wood-inhabiting hymenomycetes. Canadian Journal of Botany 43:1097-1139.

RUSSELL, P. 1956. A selective medium for the isolation of basidiomycetes. Nature 177:1038-1039.

SAFO-SAMPAH, S., and R.D. GRAHAM. 1976. Rapid agar-stick breaking-radius test to determine the ability of fungi to degrade wood. Wood Science 9:65-69.

# APPENDIX D: SOURCES OF EQUIPMENT AND SERVICE FOR PROTECTING POLES

These sources of equipment were reported by the utilities and inspection agencies that reviewed this manual. Inclusion here does not indicate endorsement by the authors or sponsoring agencies, nor does this list suggest that these are the only suppliers.

## AUGERS, BITS

American Steel Co.  
4033 N.W. Yeon Street  
Portland, OR 97210

Irwin Bit Co.  
Wilmington, OH 45177

Woodbury and Co.  
P.O. Box 3154  
Portland, OR 97208

## DRILLS, BATTERY OR ELECTRIC

Black & Decker Manufacturing Co.  
701 E. Joppa Road  
Towson, MD 21204

## MOISTURE METERS AND SHIGOMETERS

Delmhorst Instrument Co.  
607 Cedar Street  
Boonton, NJ 07005

Osmose Wood Preserving Co.  
980 Ellicott Street  
Buffalo, NY 14209

## INCREMENT BORERS

Ben Meadows  
3589 Broad Street  
Atlanta (Chamblee), GA 30366

Forestry Suppliers, Inc.  
Box 8397  
Jackson, MS 39204

Keuffel & Esser Co.  
2701 Second Avenue  
Seattle, WA 98101

## SONIC TESTERS

J. Agi and Associates  
1414 Alaskan Way  
Suite 600  
Seattle, WA 98101

Techware, Inc.  
#111, Box C  
Fort Collins, CO 80522

Heath Consultants  
511 D. Harbour Blvd.  
Sacramento, CA 95691

## PILE CAPS

Marine Technology  
74 Loomis St.  
Bedford, MA 01730

Koppers Co.  
7540 NW St. Helens Rd.  
Portland, OR 97229

## PLASTIC BARRIERS

Osmose Wood Preserving Company  
Box 168  
Griffin, GA 30223

The Zippertubing Company  
13000 S. Broadway  
Los Angeles, CA 90061

Pantascope, Inc.  
Film/Compound Division  
4303 East 48th Street  
Los Angeles, CA 90058

Vyline Corporation  
2301 East Artesia Blvd.  
Long Beach, CA 90805

Hatco Plastics  
Div. W.R. Grace  
1844 East 22nd St.  
Los Angeles, CA 90058

Quality Foam Packaging  
16180 East Gladstone Street  
Irwindale, CA 91706

## PILODYNS

Lordham Associates  
Box 184  
Merrifield, VA 22116

---

## **WRAPPED PILING**

Koppers Co.  
Western Wood Products Division  
5101 East Airport Drive  
Ontario, CA

Niedermeyer-Martin Co.  
P.O. Box 3768  
1723 NE Eleventh Ave.  
Portland, OR 97208

John C. Taylor Lumber Sales, Inc.  
P.O. Box 567  
13375 W. Henry St.  
Beaverton, OR 97075

## **PESTICIDE APPLICATOR CERTIFICATION**

Plant Division  
Oregon Department of Agriculture  
635 Capitol NE  
Salem, OR 97301  
Attn: Pesticide Supervisor

Grain and Chemical Division  
Washington Department of Agriculture  
406 General Administration Building  
Olympia, WA 98504  
Attn: Pesticide Registrar

Division of Plant Industry  
California Department of  
Food and Agriculture  
1220 N St.  
Room 308  
Sacramento, CA 95814

## **WOOD INSPECTORS**

J. Agi and Associates  
1414 Alaskan Way  
Suite 600  
Seattle, WA 98101

Aquatic Divers, International  
2523 Tacoma Ave. S.  
Tacoma, WA 98408

Bode Inspection, Inc.  
P.O. Box 591  
Lake Oswego, OR 97034

Fraser Burnard Diving Ltd.  
975 No. 6 Road  
Richmond, BC, Canada V6W 1E5

Kleger Diving  
Rural Route 2  
Burns Lake, BC., Canada V0J 1E0

Heath Consultants  
511 D Harbour Blvd.  
Sacramento, CA 95691

McCutchan Inspections  
8525 N. Lombard  
Portland, OR 97203

National Wood Treating  
7780 NW Mitchell Dr.  
Corvallis, OR 97330

Osmose Wood Treaters, Inc.  
980 Ellicott St.  
Buffalo, NY 14209

---

# **APPENDIX E: AMERICAN WOOD-PRESERVERS' ASSOCIATION STANDARD M4-80, STANDARD FOR THE CARE OF PRESERVATIVE-TREATED WOOD PRODUCTS<sup>1</sup>**

---

This Standard prescribes the requirements for the care of preservative-treated poles, piles, lumber and ties (collectively referred to as wood products) in plants or storage yards and includes field fabrication and treatment.

---

<sup>1</sup> Reprinted with permission of the American Wood-Preservers' Association.

### **1. General Requirements**

#### **1.1 Definitions**

1.11 Storage Yard--A storage area established for treated wood products.

1.12 Jobsite--The location at which a project is to be constructed or erected.

## 1.2 Handling

1.21 Treated wood products shall not be dragged along the ground.

1.22 The use of canthooks, peavies, slings, tongs and lifting devices is permissible within the limits specified in Section 2.

## 1.3 Storage

1.31 When it is necessary to hold treated wood products in storage, the material shall be stacked on treated or non-decaying skids of such dimensions and so arranged as to support the material without producing noticeable distortion.

1.32 All treated material shall be stockpiled in such a manner that there is air space beneath the material.

1.33 Storage areas shall be free of debris, decayed wood and dry vegetation (fire hazard) and shall have sufficient drainage to prevent wood products from being subjected to standing water.

## 1.4 Fabrication

1.41 Insofar as is practicable all adzing, boring, chamfering, framing, gaining, incising, surfacing, or trimming shall be done prior to treatment.

1.42 When field fabrication is a necessity, the material shall be treated with preservative as specified under the individual product.

## 1.5 Field Treatment

1.51 A wood preservative meeting the requirements of the applicable AWP Standard for the product shall be used for all field treatment, with the following limitations:

1.511 Creosote and Creosote Mixtures--Creosote for field treatment of material originally treated with creosote or any creosote solution shall meet the requirements of Standard P1 [Standard for coal tar-creosote for land and fresh water use] or P7 [Standard for creosote for brush or spray treatment for field cuts]. Creosote should be between 150°F. and 200°F. when applied. Where particularly heavy coatings are required, a

suitable plastic compound can be prepared by mixing 10 to 20 percent of creosote and 90 to 80 percent of pitch.

1.512 Oil-Borne Preservatives--Pentachlorophenol used for field treatment of material originally treated with this preservative shall be a solution prepared with solvent conforming to AWP Standard P9 [Standard for solvents for organic preservative systems]. The toxicant concentration shall be 5 percent, or more, of the solution weight. Preparations for field treatments, made by manufacturers of these preservatives, can be specified.

1.513 Concentration of water-borne preservatives should be a minimum 3 percent in solution.

1.52 Method of Application--All cuts, holes and injuries of the surface of treated material shall be field-protected by brushing, spraying, dipping, soaking or coating.

1.521 Cuts and Damage--Care should be taken to assure that all injuries, such as abrasions, nail and spike holes, are thoroughly saturated with the field-treating solution.

1.522 Bore Holes--Holes bored in pressure-treated material shall be poured full of preservative. Horizontal holes, such as those for sway brace bolts, may be filled by pouring the preservative into them with a bent funnel.

## 1.6 Loading and Shipping

1.61 All wood products shipped by rail shall be loaded in accordance with the latest issue of the Rules of the Mechanical Division of the Association of American Railroads.

## 2. Specific Requirements

### 2.1 Lumber

2.11 Treated lumber shall be stacked and supported in storage to prevent warp.

2.12 Treated lumber having a specified moisture content shall be stored under shelter. In areas of high humidity the treated lumber should be enclosed in a moisture resistant package.

## 2.2 Piles

2.21 Treated piling may be handled with pointed tools provided that side surfaces are not penetrated over one-half inch.

2.22 Piling which will have the cut-off surface exposed in the structure, in addition to the requirements of paragraph 1.5, shall be protected by covering the end with a cap consisting of two thicknesses of tar saturated fabric or tar paper, or one sheet of 20 gauge or thicker aluminum or galvanized metal, which shall overlap the side of the pile at least two inches. The overlap shall be folded down along the side and secured in place with the sealer used. This cover shall then be coated with one coat of sealer.

2.23 Piling cut off to grade, on which the end surface will not be exposed, shall be field treated by heavy applications of preservatives, which shall be applied until visible evidence of further penetration has ceased, followed by sealing the end surface of the piling with a heavy application of coal-tar pitch, or other sealer.

2.24 Timber bridge piling or those supporting timber structures--in addition to the requirements of paragraph 1.5--shall be covered over the entire upper surface with at least one-half inch of building felt. The felt shall be folded over the side of the pile and securely fastened. The felt shall then be saturated with an oil preservative and covered with 20 gauge or thicker galvanized metal or aluminum sheet, which completely covers the felt.

## 2.3 Poles

2.31 The use of handling tools and loading devices is not permitted in the groundline area. (One-foot above and two-feet below

specified groundline, ANSI Standard 05.1, current issue.)

2.32 Poles are not acceptable if they contain indentations, attributed to loading or handling slings, that are one-quarter inch or more deep over 20 percent or more of the pole circumference. Other indentations or abrasions shall not be more than one-half inch deep at any point.

2.33 Poles fabricated in the field shall be treated by saturating the cut exposed surface with preservative. The field treatment shall meet the requirements of paragraph 1.51.

2.34 Field fabrication in the groundline area is not permitted.

2.35 Poles shall not be cut-off from the butt end after treatment.

2.36 All unused bore holes and spike holes shall be poured full of preservative and plugged with tight-fitting treated plugs.

## 2.4 Ties

2.41 Adzing, cutting or boring of ties after treatment is normally not acceptable. When field fabrication is unavoidable, particularly in rail maintenance, all exposed areas shall be field treated by saturating the exposed area with a creosote or oil type preservative following the procedure outlined in paragraph 1.51.

## 3. Disposal of Pressure Treated Wood

3.1 Arsenical treated wood waste shall not be burned. Burial is the approved method for disposal, unless otherwise prohibited by regulations. Pentachlorophenol treated wood shall not be used for chicken or animal litter nor shall such shavings be used for chicken or animal bedding.



MORRELL, JEFFREY J., GUY G. HELSING, and ROBERT D. GRAHAM. 1984. MARINE WOOD MAINTENANCE MANUAL: A GUIDE FOR PROPER USE OF DOUGLAS-FIR IN MARINE EXPOSURES. Forest Research Laboratory, Oregon State University, Corvallis. Research Bulletin 48. 62 p.

This manual is designed as an illustrated user's guide to maintaining wood in West Coast marine environments. The agents that degrade wood are described in detail, and methods for detecting the damage they cause are outlined. Techniques are also described for correcting and preventing this damage.

MORRELL, JEFFREY J., GUY G. HELSING, and ROBERT D. GRAHAM. 1984. MARINE WOOD MAINTENANCE MANUAL: A GUIDE FOR PROPER USE OF DOUGLAS-FIR IN MARINE EXPOSURES. Forest Research Laboratory, Oregon State University, Corvallis. Research Bulletin 48. 62 p.

This manual is designed as an illustrated user's guide to maintaining wood in West Coast marine environments. The agents that degrade wood are described in detail, and methods for detecting the damage they cause are outlined. Techniques are also described for correcting and preventing this damage.