

Advanced Anchoring and Mooring Study



Prepared for:



November 30, 2009

Oregon Wave Energy Trust (OWET) is a nonprofit public-private partnership funded by the Oregon Innovation Council. Its mission is to support the responsible development of wave energy and ensure Oregon doesn't lose its competitive advantage or the economic development potential of this emerging industry.

OWET focuses on a collaborative model for getting wave energy projects in the water. Our work includes stakeholder education and outreach, policy development, environmental and applied research and market development. For more information about Oregon Wave Energy Trust, please visit www.oregonwave.org.

Table of Contents

Contents

1.0 INTRODUCTION	1
1.1 Purpose	1
1.2 Background	2
1.3 Project Objectives	3
1.4 Organization of Report	4
2.0 WAVE ENERGY TECHNOLOGIES	5
2.1 Operating Principles	5
2.2 WEC Devices	7
2.2.1 Point Absorber	7
2.2.2 Attenuators	8
2.2.3 Terminator.....	9
3.0 MOORINGS	12
3.1 Introduction	12
3.2 Anchors	14
3.2.1 Introduction.....	14
3.2.2 Scope.....	14
3.2.3 Selection of Anchor Type	15
3.2.4 Anchor Selection Criteria	19
3.2.5 Site Investigation	21
3.2.6 Anchor Products.....	23
3.3 Buoys	46
3.4 Mooring Lines and Connecting Hardware	48
3.4.1 Chain	48
3.4.2 Wire Rope	50
3.4.3 Synthetic Rope	51
3.5 Sources of Mooring Hardware	55
3.6 Mooring Configurations	57
3.6.1 Introduction.....	57
3.6.2 Guidelines and Standards.....	58
3.6.3 Mooring Analysis and Design Risk	59
3.6.4 Mooring Configurations.....	61
3.6.5 Mooring Line Characteristics	65
3.6.6 Anchor Characteristics.....	66

4.0 OREGON COAST CHARACTERISTICS	68
4.1 Introduction.....	68
4.2 FERC Sites.....	68
4.3 Wave Climate / Storm Wave Analysis	69
4.4 Winds and Storm Information	76
4.5 Ocean Currents	80
4.6 Threats from Wrecks and Obstructions.....	81
4.6.1 Northern FERC permitted sites.....	82
4.6.2 Southern FERC Permitted Sites.....	84
4.7 Buoy Locations near FERC Sites	85
4.8 Marine Protected Areas – Marine Sanctuaries.....	89
4.9 Bathymetry and Sediment Maps	90
4.10 Geology.....	96
4.11 Geophysical, Hydrographic, Metocean, Geological, and Geotechnical Data Sources of the Oregon Coast.	97
4.11.1 Oregon Bathymetry.....	99
4.11.2 Marine Geology:	99
4.11.3 Seismicity:.....	100
4.11.4 Geophysical:	100
4.11.5 Geotechnical:	100
4.11.6 Oregon Coast Geohazards:	100
4.11.7 Metocean:.....	100
4.11.8 General Information:.....	100
5.0 INSTALLATION ASSETS AND CONSIDERATIONS.....	102
5.1 Introduction.....	102
5.2 Installation Assets	102
5.2.1 Tugs.....	102
5.2.2 Barges	103
5.2.3 Floating Cranes	106
5.3 Installation Planning.....	108
5.3.1 Cost factors	108
5.3.2 Vessel Cost.....	111
5.3.3 Oregon ports.....	113
5.3.4 OWET Study by Advanced Research Corporation	113
6.0 ADDITIONAL R&D RECOMMENDATIONS	115
APPENDIX A ANCHOR DESIGN PROCEDURES	116

A-1 Deadweight Anchors	117
A-1.1 Basic Design – Holding Capacity for a Simple Deadweight Anchor.....	117
A-1.2 Holding Capacity for a Deadweight Anchor with Keying Skirts	119
A-1.2 Other Design Considerations	120
A-2 Drag Anchors	124
A-2.1 Description.....	124
A-2.2 Drag Anchor Performance	125
A-2.3 Drag Anchor Holding Capacity	127
A-2.4 Chain Contribution to Capacity	131
A-2.5 Anchor Penetration	132
A-2.6 Anchor Setting Distance	133
A-2.7 Anchor Instability and Performance Problems.....	134
A-2.8 Piggybacking	135
A-2.9 Factor of Safety.....	136
A-3 Pile Anchor	137
A-3.1 Driven and drilled and grouted piles	137
A-3.2 Suction Piles	138
A-3.3 Piles of Other Types	139
A-3.4 Pile Anchor Capacity.....	139
A-4 Plate Anchors	141
A-4.1 Plate Anchor Types and Functioning	141
A-4.2 Plate Anchor Capacity	142
A-4.3 Load Direction and Timing Factors That Affect Plate Anchor Capacity.....	143
APPENDIX B GEOPHYSICAL TECHNIQUES FOR THE INVESTIGATION OF NEAR-SEABED SOILS AND ROCKS	145
B-1 FORWARD	147
B-2 Preface	149
B-3 Introduction	150
B-3.1 Applications	152
B-3.2 Vessels and deployment systems	155
B-4 Geophysical techniques	158
B-4.1 High resolution reflection systems.....	158
B-4.2 Remote geophysical platforms.....	165
B-4.3 Seabed classification systems	167
B-4.4 Seismic refraction systems.....	168
B-4.5 Electrical resistivity systems.....	170

B-4.6 Underwater cameras.....	172
APPENDIX C BIBLIOGRAHPY and REFERENCES	173
C-1 Design Guides	173
C-2 Anchoring Guides	174
C-2.1 General.....	174
C-2.2 Deadweight Anchors.....	175
C-2.3 Drag Anchors.....	175
C-2.4 Pile Anchors.....	176
C-2.5 Plate Anchors.....	177
C-2.6 Cable/Chain-Soil Interaction.....	178
C-3 Mooring Hardware	179

Figures

Figure 1 Schematic Drawings of WEC Devices.....	6
Figure 2 Examples of Point Absorber Wave Energy Converters.....	7
Figure 3 Attenuator wave energy converter.....	8
Figure 4 Pelamis Wave Energy Converter.....	8
Figure 5 Anaconda Wave Energy Converter.....	9
Figure 6 Ocean Energy Ltd. wave energy converter.....	10
Figure 7 Voith Hydro Wave Energy Converter.....	10
Figure 8 Wave Dragon - Overtopping Wave Energy Converter System.....	11
Figure 9 Oyster® Wave Energy Converter.....	11
Figure 10 Mooring Technology.....	12
Figure 11 Example 3 Leg Mooring.....	13
Figure 12 Generic Anchor Types.....	14
Figure 13 Enhanced Deadweight Anchor.....	15
Figure 14 Anchor Penetration Behavior in Clay.....	16
Figure 15 Typical Drag Anchor.....	16
Figure 16 Multiple Mooring Piles Loaded for Transport.....	17
Figure 17 Multiple Suction Piles Installed from Single Vessel.....	17
Figure 18 Driven Plate Anchor Installation.....	18
Figure 19 Driven plate anchor install.....	18
Figure 20 Types of Deadweight Anchors.....	23
Figure 21 Conventional Anchor Types (after Waterman Supply).....	24
Figure 22 Mooring and Offshore Anchors (after Waterman Supply).....	25
Figure 23 Suction pile example and penetration process.....	35

Figure 24 Generalized Behavior of Plate Anchor.....	38
Figure 25 Example US Navy Fleet Mooring Buoy (MIL-HDBK-1026/4A)	46
Figure 26 <i>Trelleborg</i> Mooring Buoys.....	46
Figure 27 Marine Fender Mooring Buoys	47
Figure 28 Steel Buoy www.oregoniron.com	47
Figure 29 Distributed Cable Buoyancy.....	48
Figure 30 Chain Connecting Elements	49
Figure 31 “X” Chart: Wire Rope Bending and Fatigue.....	50
Figure 32 Parallel Subrope Construction (DNV-OS-E303)	54
Figure 33 <i>Samson Rope</i> Polyester Tether Properties (www.samsonrope.com).....	54
Figure 34 <i>Bridon</i> Superline Polyester Tether	55
Figure 35 Spread Mooring Configuration Options.....	63
Figure 36 All FERC Permitted Sites, North and South, along Oregon Coast	68
Figure 37 Historical Trend of Storm Waves at NDBC Buoy 46002, 30-Year Data Record.....	69
Figure 38 Location of NDBC Buoys (46015, 46050 and 46029) along Oregon Coast.....	70
Figure 39 Significant Wave Height at NDBC Buoy 46029 (1984 – 2001).....	71
Figure 40 Significant Wave Height at NDBC Buoy 46050 (1991 – 2001).....	72
Figure 41 Frequencies of High Swell Events per Year along Oregon Coast.....	73
Figure 42 Wind Speed at NDBC Buoy 46029 (1984 – 2001).....	77
Figure 43 Average Wind Speed at NDBC Buoy 46050 (1991 – 2001).....	77
Figure 44 Frequency of 30 to 40 Knot Wind Events at 3 NDBC Buoys along Oregon Coast.....	80
Figure 45 Measured at Multiple Depths from GLOBEC Mooring NH10 ADCP	81
Figure 46 Legend for Wrecks and Obstructions Maps	82
Figure 47 Four Northernmost FERC Sites with Obstructions Shown.....	83
Figure 48 Two Additional Northern FERC Permitted Sites	84
Figure 49 Two of the Southern Oregon FERC Sites with Obstructions Shown.....	85
Figure 50 Southernmost Oregon FERC Site with Obstructions Shown	85
Figure 51 Northern FERC Permitted Sites with Buoy/Station Locations	86
Figure 52 Southern FERC Permitted Sites with Buoy/Station Locations	88
Figure 53 MPAs along Oregon Coast.....	89
Figure 54 Bathymetry of Six Northern FERC Sites	91
Figure 55 Bathymetry of Three South FERC Sites	92
Figure 56 Sediment Types Inside and Near Four Northern FERC Sites	93
Figure 57 Sediment Types Inside and Near Two North-Central FERC Sites	94
Figure 58 Sediment Types Inside and Near Three South FERC Sites	95
Figure 59 Coastwise Tug	102

Figure 60 Anchor Handling Tug.....	103
Figure 61 Offshore Supply Vessel.....	103
Figure 62 Miss Linda– General Purpose Support (www.MisslindaChartersAndTours.com)...	103
Figure 64 Example Flat barges	104
Figure 63 Flat Barge with WEC-Sized device.....	104
Figure 65 Operations (http://www.geocities.com/uksteve.geo/heavylift.html).....	104
Figure 66 Semi-submersible Barge with USS Cole.....	105
Figure 67 Smit Marine Semi-submersible Barge.....	105
Figure 68 Example Seabridge Semi-submersible Marine Barge.....	105
Figure 69 Example floating crane - DB Pacific.....	106
Figure 70 Oregon Ports.....	114
Figure 71 Simple Deadweight Anchor Design on Cohesive Soil.....	118
Figure 72 Schematic of “Full-Base-Skirted” Deadweight Anchor.....	119
Figure 73 Deadweight Anchor Design on Slopes.....	121
Figure 74 Enhanced Pearl Harbor Anchor.....	121
Figure 75 Enhanced Pearl Harbor Anchor Configuration	122
Figure 76 Anchor Parts Identified.....	124
Figure 77 Types of Drag Anchor	124
Figure 78 Effects of tripping on drag anchor performance.....	127
Figure 79 Ultimate Holding Capacity of Drag Anchors in Mud/soft Clay.....	129
Figure 80 Ultimate Holding Capacity of Drag Anchors in Sand/hard Soil	130
Figure 81 Setting Distance of Drag Anchors	134
Figure 82 Drag Anchors in Parallel	136
Figure 83 Pile Anchors	138
Figure 84 Suction Pie Installation Mechanism	138
Figure 85 Plate Anchor Types	142

Tables

Table 1 Features of Deadweight Anchors.....	15
Table 2 Features of Drag Anchors	16
Table 3 Features of Pile Anchors.....	18
Table 4 Features of Plate Anchors	19
Table 5 General Criteria for Evaluation and Selection Criteria of WEC Anchors.....	20
Table 6 Behavioral Criteria for Evaluation and Selection of WEC Anchors	20
Table 7 Site Data Requirements for Categories of Geotechnical Engineering Applications	21
Table 8 Soil Engineering Parameters.....	22
Table 9 Pile Types	33
Table 10 Mooring Line Connections	34
Table 11 Techniques to Improve Pile Lateral Load Capacity	34
Table 12 Anchor and Mooring Chains.....	49
Table 13 Torque-balanced Wire Rope for Oceanographic Applications.....	51
Table 14 Characteristics of Possible WEC Spread Mooring Configurations.....	64
Table 15 Mooring Line Summary.....	65
Table 16 Anchor Characteristics Summary	66
Table 17 Mooring Configuration Anchor Options	67
Table 18 Bounding Coordinates of Nine FERC Permitted Sites.....	69
Table 19 NDBC Buoy 46015 High Swell Events by Month and Year (*= partial or no data)	75
Table 20 NDBC Buoy 46029 High Swell Events by Month and Year (*= partial or no data)	75
Table 21 NDBC Buoy 46050 High Swell Events by Month and Year (*= partial or no data)	76
Table 22 Wind Speeds at NDBC Buoy 46015, 7-year dataset	78
Table 23 Wind Speeds at NDBC Buoy 46050, 10-year dataset	78
Table 24 Wind Speeds at NDBC Buoy 46029, 10-year dataset	79
Table 25 FERC Permitted Sites with Nearest Buoy/Station Locations.....	87
Table 26 Matrix of FERC sites.....	98
Table 27 Floating Crane Inventory from General Construction (not all cranes will be suited to offshore use).....	107
Table 28 Marine Service Companies	107
Table 29 Installation Costs Factors A.....	109
Table 30 Installation Cost Factors B.....	110
Table 31 Estimated Cost for <i>DB Los Angeles</i> to Deploy WEC Device.....	111
Table 32 Offshore Rates of Various Vessels	112
Table 33 Friction Coefficients for Anchor Materials on Granular Soils ($\tan \phi$).....	117
Table 34 Nominal Features of Enhanced Pearl Harbor Anchor	122

Table 35 Enhanced Pearl Harbor Anchor Capacity in Soft Clay/Mud.....	123
Table 36 Enhanced Pearl Harbor Anchor Capacity in Sand.....	123
Table 37 Soil Characteristics and Effects	125
Table 38 Operating Characteristics of Drag Anchors.....	126
Table 39 Anchor Holding Capacity Parameters	131
Table 40 Mooring Line Friction Factors.....	132
Table 41 Maximum Penetration Depths of Drag Anchors	133
Table 42 Stability Problems and Solutions for Drag Anchors.....	135
Table 43 Recommended Factors of Safety for Mooring Lines and Anchors	137
Table 44 Friction and Bearing Parameters for Cohesionless Soils.....	141
Table 45 Load Timing Factors Affecting Plate Anchor Capacity	144

1.0 INTRODUCTION

1.1 Purpose

This report establishes an industry knowledge base for existing anchoring and mooring techniques as applied to wave energy conversion (WEC) devices in and around Oregon. The effort is supported by the Oregon Wave Energy Trust (OWET) whose mission is to facilitate the responsible development of the wave energy industry in Oregon.

The coast of Oregon has the most energetic wave environment on the West coast of the U.S. except for Alaska. The responsible development of the Oregon wave energy industry requires exacting analysis, design and execution to ensure minimal effect on the environment while providing minimal cost mooring systems consistent with the lowest possible risk.

There is a multitude of WEC devices in concept, in development or in demonstration, yet there are no universally applied standards or criteria specific to the design of wave energy devices. Designers typically select guides developed for floating structures from various sources (DnV, ABS, NK, API, and MMS), adapt them as best that they can, and trust that they achieve a safe and cost-effective design. This can lead to inconsistent designs while making it difficult for regulatory agencies to evaluate and certify the designs.

Almost 20 years ago the USCG was spending a disproportionate amount of time reviewing design and enforcing safety regulations for novel offshore structures and vessels. The USCG engaged the Marine Board from the National Academy of Sciences to recommend a means of ensuring the safety of Innovative Marine Structures. The Marine Board defined an Innovative structure as shown below, and recommended an approach for dealing with this type of structure.

Clearly, WEC devices can be classified as Innovative Structures¹

An Innovative Structure is defined as: “structure that requires analysis and/or special fabrication and inspection controls beyond those required by existing rules. Moreover, an Innovative Structure is the first of its kind; few if any design standards directly apply; and there is little operational experience to relate to the design review process.

In the safety review of Innovative Structures, the identification of problem areas may be more important than the analysis itself, because by definition, the Innovative Structure may be subjected to previously unknown load demands and failure modes. Once the problem is clearly identified, assurance of the safety of Innovative Structures often requires the use of state-of-the-art analysis methods.” The Marine Board went on to state that the analysis of such structures “calls for individuals with a high level of education, competence and experience in applied engineering with a strong grounding in and understanding in fundamental mechanics as well.”

This report on anchoring and mooring techniques is derived from the cumulative experiences of engineers and scientists with many years of experience analyzing, designing and installing

¹ “Assuring the Safety of Innovative Marine Structures”, Marine Board, National Academy of Sciences, 1980

structures in the ocean subjected to significant environmental forces. It is not intended to be a complete design procedure but to provide the user with practical guidance on anchors and mooring techniques and sources of reliable design information necessary to the design of WEC devices suited to the coast of Oregon.

1.2 Background

The installation and operation of WEC's off Oregon provide opportunities to the people of Oregon for a new and clean source of renewable energy. However, the size and extent of WEC mooring systems create potential effects to the offshore environment. The primary function of the mooring system is to withstand the extreme environmental loadings while maintaining WEC position and performance, it should accomplish this function in a cost effective manner with minimal environmental impact. Regulatory agencies require that developers of marine renewable energy address the potential environmental effects of wave energy devices.

A vast amount of technical information exists concerning anchoring and mooring systems from the military and worldwide offshore industry. However, it can be a daunting task to sift through this body of work and determine which information is actually relevant to the analysis and design of a WEC device.

There is considerable experience in the offshore industry with the design and installation of mooring systems for various offshore structures. Their design is controlled by rules, regulations and guidelines established by various regulatory authorities and the most stringent apply to the offshore oil and gas industry due to potential loss of life and the danger of environmental damage. WEC devices are not manned nor do they pose significant potential damage to the environment, thus they could be designed to a lesser safety standard/higher risk level. However, since WEC technology is in its infancy this may not be a reasonable nor advisable design option. Failure of a WEC mooring system could easily damage the public perception of the concept and have a negative influence on future funding and continued support. **Use of the more stringent mooring design rules and guides is recommended until there is a suitable body of knowledge and experience for mooring WEC devices to moderate these procedures.**

The Carbon Trust, established by the UK government, recognized that there were no specific codes of practice, standards, or guides to facilitate WEC design and development. They commissioned DNV to develop a guideline (DNV2) to provide interpretation and guidance on the application of the various existing standards and guides, such as offshore engineering, to wave energy conversion (WEC) devices. DNV notes that this guideline is not a standard and should be considered as a starting point for further standards work. The Guideline was developed to provide guidance, act as reference to principal relevant standards and highlight some major issues that developers or other stakeholders may wish to consider during development of WECs. More recently, DNV issued an Offshore Service Specification for

² DNV 2005, Guideline on design and operation of wave energy converters

Certification of Tidal and Wave Energy Converters³ (DNV-OSS-312). This document defines the requirements, philosophy, deliverables and the certification procedure.

Germanisher LLOYD⁴ also developed a guideline in 2005 that applies to the design, assessment and certification of ocean energy conversion systems and farms of ocean energy conversion systems. The first part of the Guideline applies solely for ocean current turbines (OCT) but has information relevant to the design of WEC devices. This guideline is also not intended to be a full design procedure and safety manual guideline due to the multiple engineering solutions possible, but to give some general guidance for the assessment of the safety of ocean current turbines.

In the RFP for this anchoring and mooring task, OWET properly noted that “The insights garnered from collecting, assessing, and organizing this body of documentation would deliver insightful conclusions to device manufacturers, public stakeholders, and government agencies. A thorough search of public domain literature complemented by targeted corporate inquiries would summarize mooring system impacts based on the performance of similar implementations. The information gleaned could be applicable to assessing a course of action from site selection through project monitoring, provide regulatory agencies with a technical baseline for setting policy guidelines and establishing project evaluation criteria.”

1.3 Project Objectives

The overall objective of this effort is to establish an industry knowledge base for existing anchoring and mooring techniques as applied to wave energy devices in and around Oregon and make recommendations for future analysis.

Specific sub-objectives are as follows:

- **Objective 1**

Inventory the applicable anchoring and mooring techniques plus the geophysical characteristics of the potential project sites in Oregon as they relate to anchoring and mooring. Provide a basis for comparison for evaluation of site characteristics versus alternative anchoring and mooring techniques.

- **Objective 2**

Conduct a desk top study of project sites, as defined by active FERC preliminary permits or pilot project permits, to provide more detail on project site characteristics. Using the project site characteristics, identify promising anchoring and mooring techniques. Identify business case drivers such as availability of equipment and/or personnel on the Pacific Coast.

- **Objective 3**

Recommendations for Follow-on Research: future research, studies or surveys to focus on application of devices to Oregon wave energy site utilization.

³ DNV-OSS-312, Offshore Service Specification Certification of Tidal and Wave Energy Converters, October 2008

⁴ Guideline for the Certification of Ocean Energy Converters Part 1: Ocean Current Turbines –Germanisher Lloyd, 2005 (draft)

1.4 Organization of Report

- **Section 1.0.** Describes the purpose, objectives, background and organization of the report.
- **Section 2.0.** Provides descriptions and operating principles of typical wave energy devices.
- **Section 3.0.** Provides data and sources for mooring components to include anchors, buoys and lines and connecting hardware that may be appropriate for WEC device mooring systems. It also discusses suitable WEC mooring configurations.
- **Section 4.0.** Provides the results of a desk top survey of the site characteristics of the Oregon coast with particular attention to the nine permitted FERC sites.
- **Section 5.0.** Identifies installation equipment such as tugs, barges and handling equipment on the Pacific coast and the available infrastructure on the Oregon coast available to support WEC device installation. Some cost and availability information is provided.
- **Section 6.0.** Provides recommendations for Follow-on Research: studies or surveys that focus on application of WEC devices to Oregon wave energy site utilization.
- **Appendix A.** Provides basic design procedures for deadweight, drag, pile and plate anchors.
- **Appendix B.** Provides a site and route survey guide appropriate to the investigation of WEC sites.
- **Appendix C.** Provides bibliography and references related to anchoring and mooring technologies.

2.0 WAVE ENERGY TECHNOLOGIES

2.1 Operating Principles

Wave energy devices are commonly referred to as Wave Energy Converters (WECs). Harris⁵ provides an excellent description of wave energy devices and related mooring requirements. Harris categorizes WECs by their energy extraction method or operating principles as follows:

- **Oscillating Water Columns (OWC)**

Waves cause the water column to rise and fall, which alternately compresses and depressurize an air column. The energy is extracted from the resulting oscillating air flow by using a Wells turbine (The **Wells turbine** is a low-pressure air turbine developed for use in oscillating-water-column wave power plants to avoid the need to rectify the air stream by delicate and expensive valve systems. It keeps its sense of rotation in spite of the changing direction of the air stream, which is driven by the rising and falling water surface in a compression chamber.)

- **Overtopping Devices (OTD)**

Ocean waves are elevated into a reservoir above the sea level, which store the water. The energy is extracted by using the difference in water level between the reservoir and the sea by using low head Kaplan turbines (The **Kaplan turbine** is a propeller-type water turbine that has adjustable blades).

- **Wave Activated Bodies (WAB)**

Waves activate the oscillatory motions of body parts of a device relative to each other, or of one body part relative to a fixed reference. Primarily heave, pitch and roll motions can be identified as oscillating motions whereby the energy is extracted from the relative motion of the bodies or from the motion of one body relative to its fixed reference by typically using hydraulic systems to pressurize oil, which is then used to drive a generator. The wave activated bodies (WABs) are further subdivided by the energy extraction principle into rotational and translational motions.

Further, Harris⁵ provides an overview of possible operating principles for shoreline, nearshore and offshore locations with schematics of wave energy devices (Figure 1). Both shoreline and nearshore devices are restrained using traditional gravity and/or pile foundations. Once the design survival wave environment, seafloor engineering properties and loads are established, the anchor/foundation design process can be accomplished by many offshore engineering companies with expertise in marine and offshore structures. General design guidance is provided in Appendix A of this report. The Marine Foundation Committee of the *Deep Foundation Institute*

⁵ Mooring systems for wave energy converters: A review of design issues and choices, Robert E. Harris, BSc, PhD, CEng, MIMarEST, Lars Johanning, Dipl.-Ing., PhD, Julian Wolfram, BSc, PhD, CEng, FRINA, MSaRS FRSA, Heriot-Watt University, Edinburgh, UK

sponsored a number of relevant documents such as Deep Marine Foundations⁶ that provide good examples of anchoring and foundation designs relevant to shoreline and nearshore WECs.

The moorings for the offshore WECs in Figure 1 are illustrated as single leg catenary moorings but the actual anchor leg and mooring configuration will depend upon many things such as, device orientation and rotational constraints for maximum power extraction, power transmission cable survivability, seafloor conditions, and number of WECs in proximity to each other, and available footprint and mooring-WEC interactions.

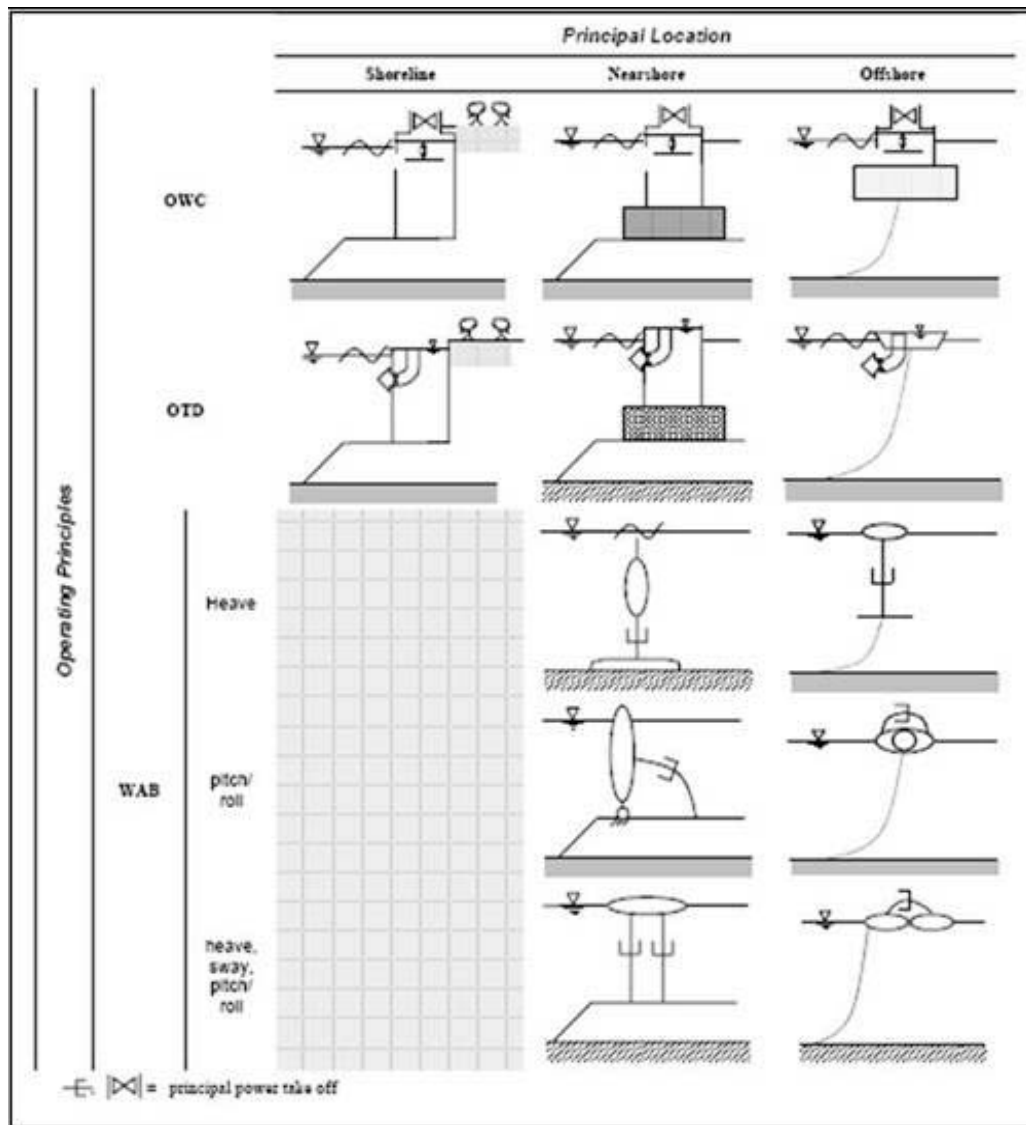

Figure 1 Schematic Drawings of WEC Devices

For operating principles and principal locations (Harris, et al, “Mooring systems for wave energy converters”)

⁶ Deep Marine Foundations, Deep Foundation Institute, Bittner, B, and R. Ellman, 2009

2.2 WEC Devices

WECs are also commonly categorized as Point Absorber, Attenuator and Terminator devices. Each is characterized by a different operating principle and directionality requirement. Operating principle and examples of each of these WEC categories follow.

2.2.1 Point Absorber

A point absorber is a wave device with dimensions much less than the wavelength of the incident ocean wave. These devices use the rise and fall of the water level at a single point to create usable energy. Examples are provided by Figure 2. They may use relative motion or pressure for the power. They generally do not have to be oriented in a particular direction to operate; however, directional control may be required to protect the power cable from twisting. Personal discussions with the **Swell Fuel** developer indicate that rotational control is not an issue with this device. Both the **Ocean Power Technology (OPT)** and **Wavebob** buoys have been deployed with multi-leg moorings (tri-moors) to control rotation, minimize watch circle and provide enhanced mooring safety via the redundant mooring legs.

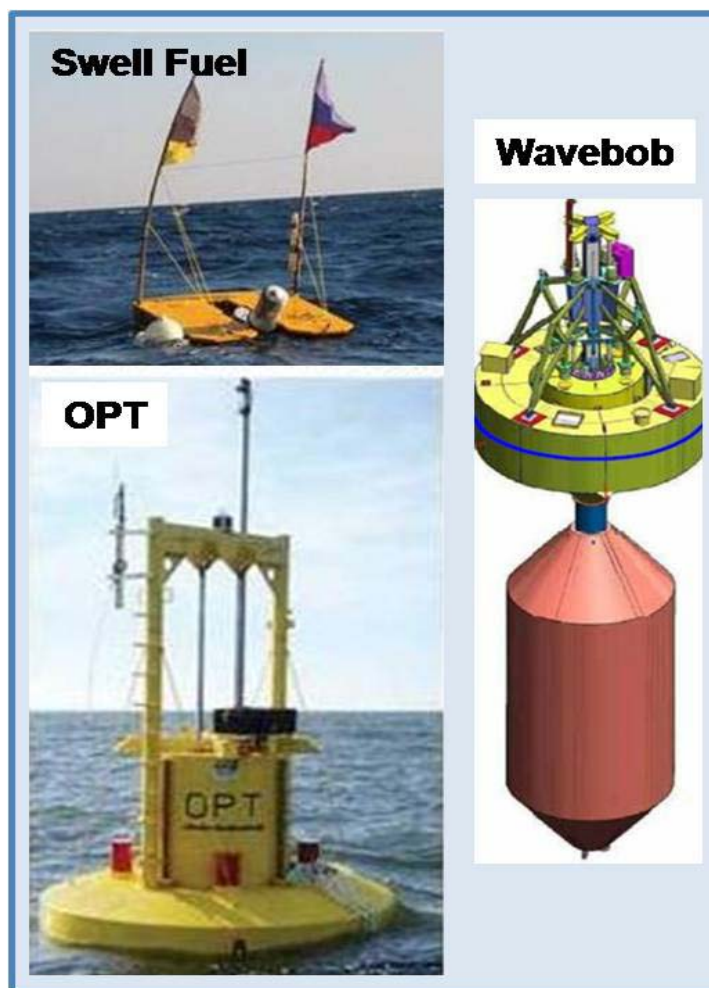

Figure 2 Examples of Point Absorber Wave Energy Converters

2.2.2 Attenuators

An attenuator device extracts energy as the ocean wave moves along the body of the device. The efficiency of an attenuator device is related to their principal axis being parallel or normal to the incoming wave crest. A mooring system that allows the device to weathervane into the waves while preventing rotation of the system is required.

Pelamis is one example of an attenuator WEC device. It is a long multi-segmented floating structure oriented parallel to the direction of the waves and it converts the energy due to the relative motion of the parts of the device as the wave passes (Figure 3). Pelamis is a semi-submerged, articulated structure composed of cylindrical sections linked by hinged joints. The wave-induced motion of these joints is resisted by hydraulic rams, which pump high-pressure oil through hydraulic motors via smoothing accumulators. The hydraulic motors drive electrical generators to produce electricity. Power from all the joints is fed down a single umbilical cable to a junction on the seabed.

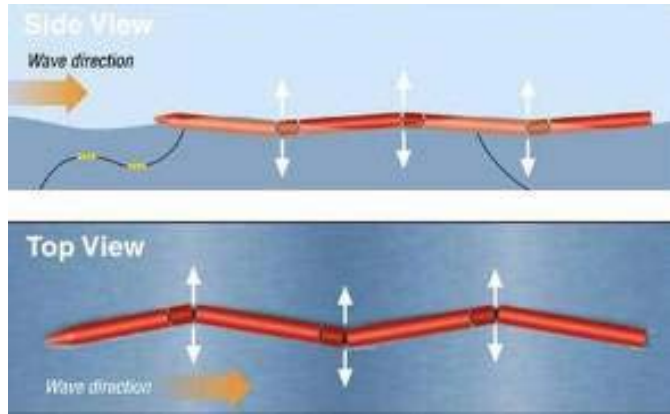

Figure 3 Attenuator wave energy converter

Several devices can be connected together and linked to shore through a single seabed cable.

Pelamis is shown in Figure 4 as a single unit and as multiple units combined to create a wave farm. This system is moored with dual, spread anchor legs at the head and a single anchor leg at the stern to align the unit into the prevailing seas.



Figure 4 Pelamis Wave Energy Converter

The **Anaconda** is another example of an attenuator device although its operating principle differs and it has not yet been field tested. Anaconda is a large water-filled rubber tube, aligned in the direction of wave propagation where the natural propagation speed of bulge waves is

matched to the speed of the water waves to be captured (The **bulge wave** is a wave of pressure, associated with a longitudinal oscillation of fluid, forwards and backwards along the tube. When the pressure is high, the water is flowing forward; when it is low the water is flowing backwards; this wave carries energy). The bulge wave power is converted to electricity by a turbine, which receives a flow smoothed by accumulators. Model tests have shown that the capture width is up to four times the diameter of the tube.

Figure 5 illustrates the waves coming from the left. The arrows show the oscillating flow of water inside the tube. The pictures are screen shots of model test videos where the Anaconda device is tethered to the sea floor and positioned head-on into the coming waves. As the wave encounters the bow it creates a bulge that travels along the tube and when the bulge wave reaches the Anaconda's tail, the energy is used to drive a turbine and create electricity.

A single point catenary leg mooring is shown but that is unlikely in operation to safeguard the power cable and to minimize watch circle.

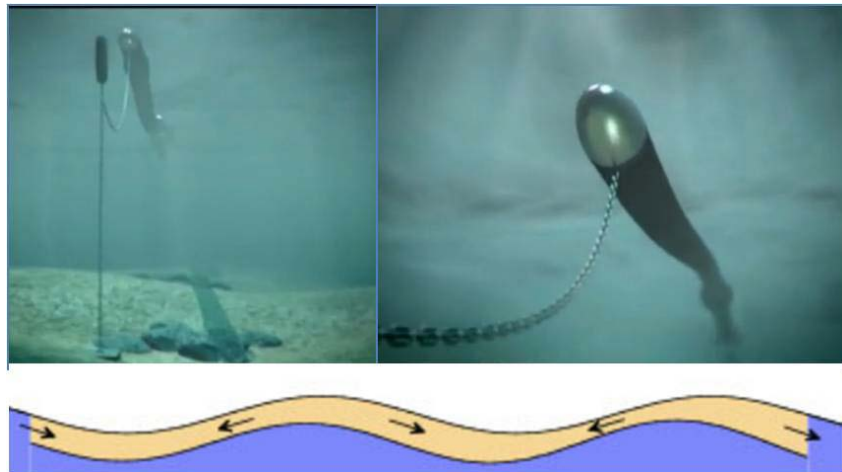

Figure 5 Anaconda Wave Energy Converter

2.2.3 Terminator

A terminator interfaces with the continued propagation of the incident wave and extracts a portion of the incident wave energy in a single event. Terminators extend perpendicular to the direction of wave travel and capture or reflect the power of the wave. These devices are typically onshore or near shore. Several examples of terminator devices follow.

The oscillating water column (OWC) uses the rise and fall of the ocean water level inside a chamber to force compressed air through a turbine/ electrical generator. The **Ocean Energy Ltd.** device is shown in Figure 6 being towed to the site and in operation. Since 2005 the Hydraulics and Maritime Research Centre (HMRC) in Cork, Ireland has been working with Ocean Energy Limited to develop a prototype wave-power electric generator. There “is a large ducting, or chamber, inside this device which is open to the sea at the rear and inside the chamber there is an air volume. That air volume is compressed by the waves and as the waves go by that compressed air is forced through the turbine which spins to generate electricity.”



Figure 6 Ocean Energy Ltd. wave energy converter

The **Voith Hydro** device is a shoreline wave energy converter utilizing an inclined OWC with Wells turbine. Its operating principle and a prototype system are shown in Figure 7. The prototype (Limpet plant) is located on the island of Islay off the west coast of Scotland and according to the developer it is the world's first grid connected commercial scale wave energy plant, commissioned in November 2000.

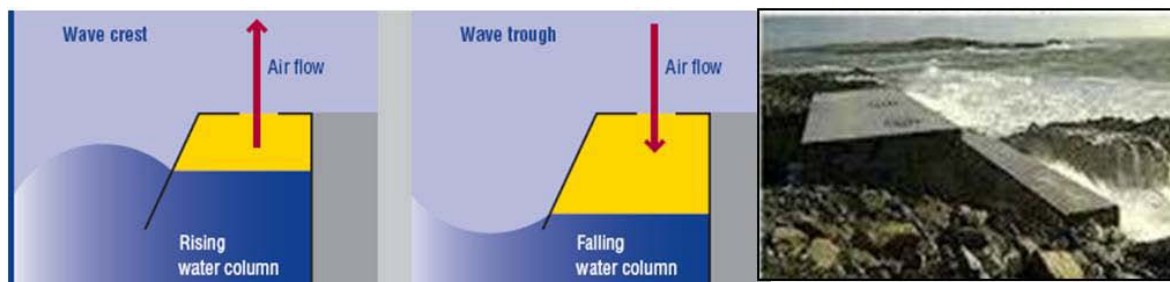

Figure 7 Voith Hydro Wave Energy Converter

The **Wave Dragon** is another form of terminator that is classified as an overtopping device. Figure 8 illustrates the operating principle and shows a prototype in operation. Overtopping wave energy converters operate through storing of potential energy in a water reservoir above the mean water level of incident waves. The stored water is drained through a low head turbine generator to a lower elevation. Both near shore and offshore floating versions have been developed.

Wave Dragon is a floating, slack-moored device that can be deployed in a single unit or in arrays. The first prototype connected to the grid is currently deployed in Nissum Bredning, Denmark. A mooring with good position and direction control is important to the proper performance and survivability of this system.

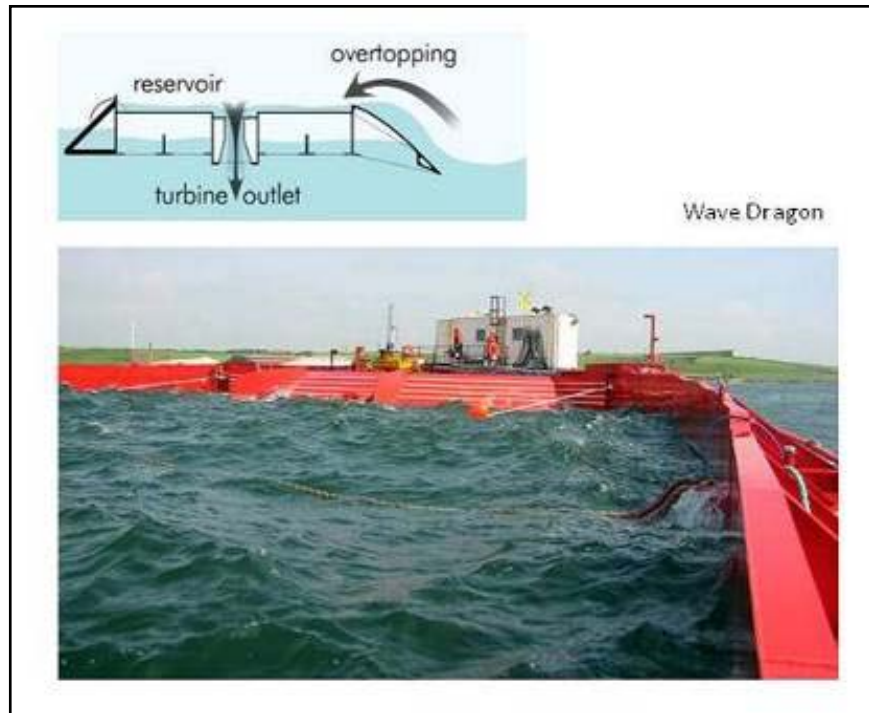

Figure 8 Wave Dragon - Overtopping Wave Energy Converter System

Aquamarine Power, Edinburg, Scotland developed the **Oyster®** wave energy converter shown in Figure 9. Oyster® consists of an Oscillator fitted with pistons and fixed to the nearshore sea bed. Each passing wave activates the Oscillator, pumping high pressure water through a sub-sea pipeline to the shore. Onshore, conventional hydro-electric generators convert this high-pressure water into electrical power. As shown in Figure 9 the device is substantial and can be anchored by gravity base and/or piles. The device generates energy during pitch of the upright element. Its operating principle is illustrated by the middle schematic in Figure 1 for a WAB operating nearshore.



Figure 9 Oyster® Wave Energy Converter

3.0 MOORINGS

3.1 Introduction

Figure 10 depicts the range of mooring components and mooring configurations that were considered for this study. These primarily apply to the mooring of nearshore and offshore floating WEC devices although certain of the anchor design details provided apply to offshore fixed and shoreline devices. The level of detail provided in the following sections varies and focuses primarily on anchors, lines and mooring configurations. There has been a flurry of activity over the past few years towards development and improvement of new anchor systems and much of this information has not been consolidated for simple access, therefore it received greater emphasis herein.

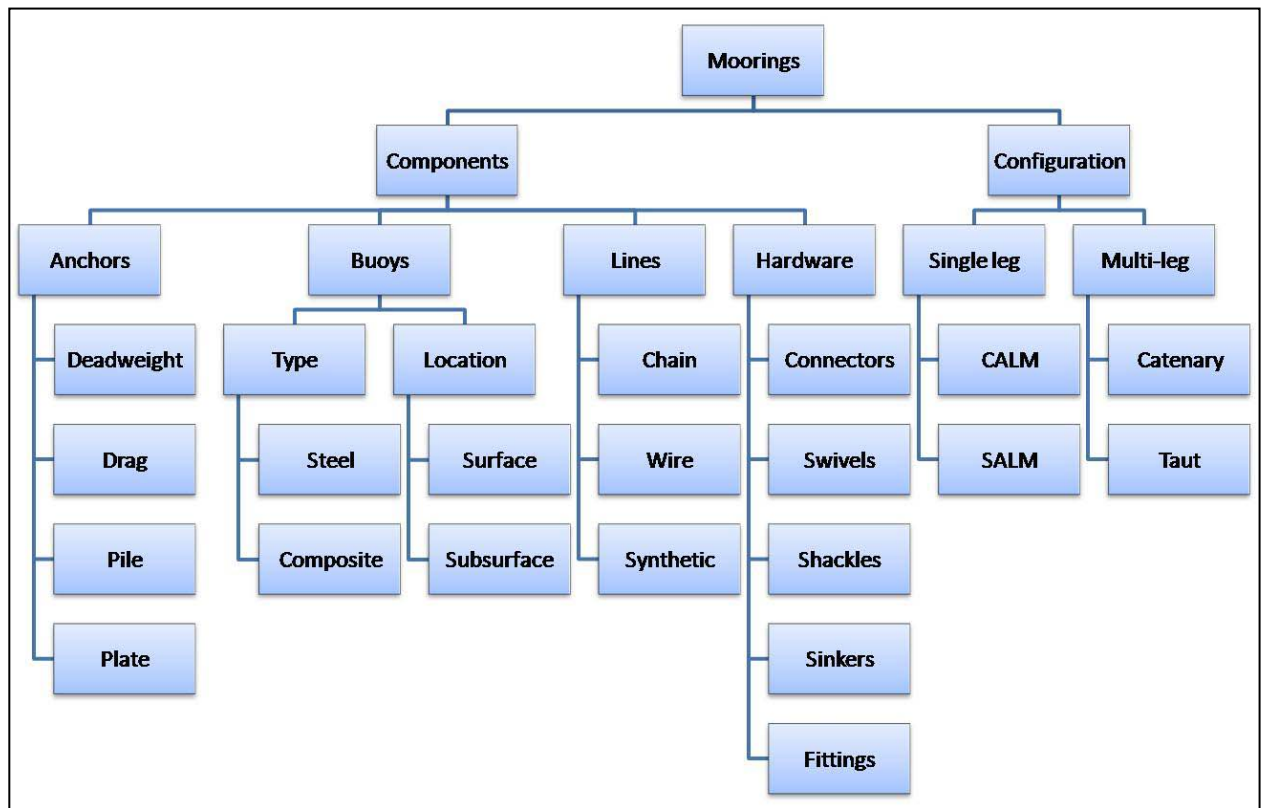

Figure 10 Mooring Technology

Where detailed design guidance is not provided for various components in Figure 10 open sources of information are identified.

There exists a multitude of possible mooring configurations for floating WEC devices. They can be categorized as single and multi-leg. The characteristics and utility of each configuration is described. In general, single leg moorings will not be appropriate unless a means to prevent the power cable from twisting is incorporated into the design. Multi-leg mooring systems with a minimum of two legs for semi-submerged articulated (Pelamis-type) and three equally-spaced legs for point source WEC devices to prevent twisting, control directionality if needed and to control buoy watch circle are often appropriate. Multi-leg moorings also provide redundancy

and increased reliability. Figure 11 illustrates a three leg mooring that could be used to moor a point absorber-type WEC. The inset graphic provides a better perspective of a surface buoy mooring leg configuration. Note that each leg could be assembled from a variety of components to satisfy mooring requirements; there is no mooring leg configuration that is optimal for all systems. The mooring is an integral part of the wave energy device system and its interaction and influence on wave buoy behavior and performance must be considered during the selection and design process.

The various components are described in the following sections.

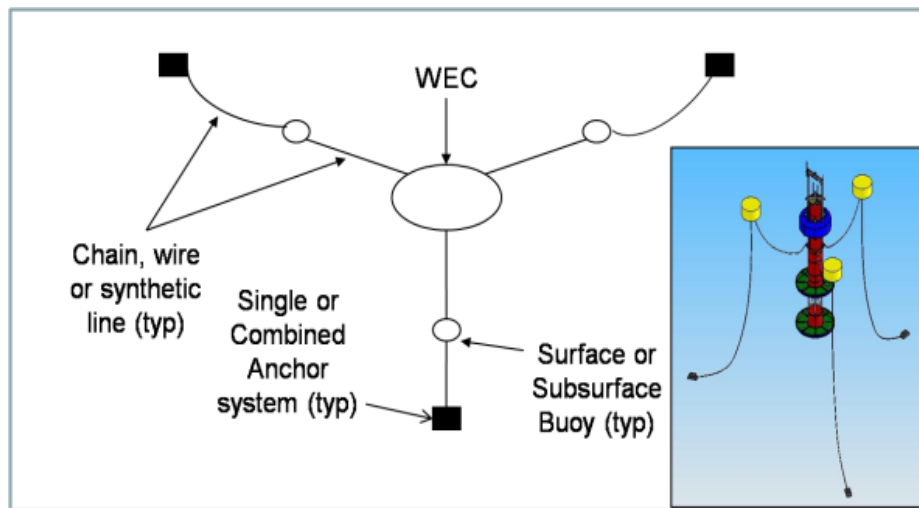

Figure 11 Example 3 Leg Mooring

3.2 Anchors

3.2.1 Introduction

Generally, anchors serve to secure moorings and foundations in a fixed position on the seafloor. They are available in many types, as shown in Figure 12, relating to how they obtain the capability to maintain their position:

- the simple use of a large weight to resist uplift and sliding, and the addition of features to enhance sliding resistance
- grabbing the soil or wedging or cementing into the rock to make use of the seafloor's strength and weight

As the seafloor material is increasingly relied upon to enhance the capacity of an anchor, the complexities of the anchor design and installation increase. Where high holding capacity, rigidity, or uplift resistance, may be needed, and where anchor size or weight or seafloor space may be restricted, innovative and expensive designs and installation procedures sometimes must be used. However, with prudent site selections and a design process that is interactive between the anchor, mooring leg, and moored system in the expected environment, unduly complicated and expensive choices may be avoided.

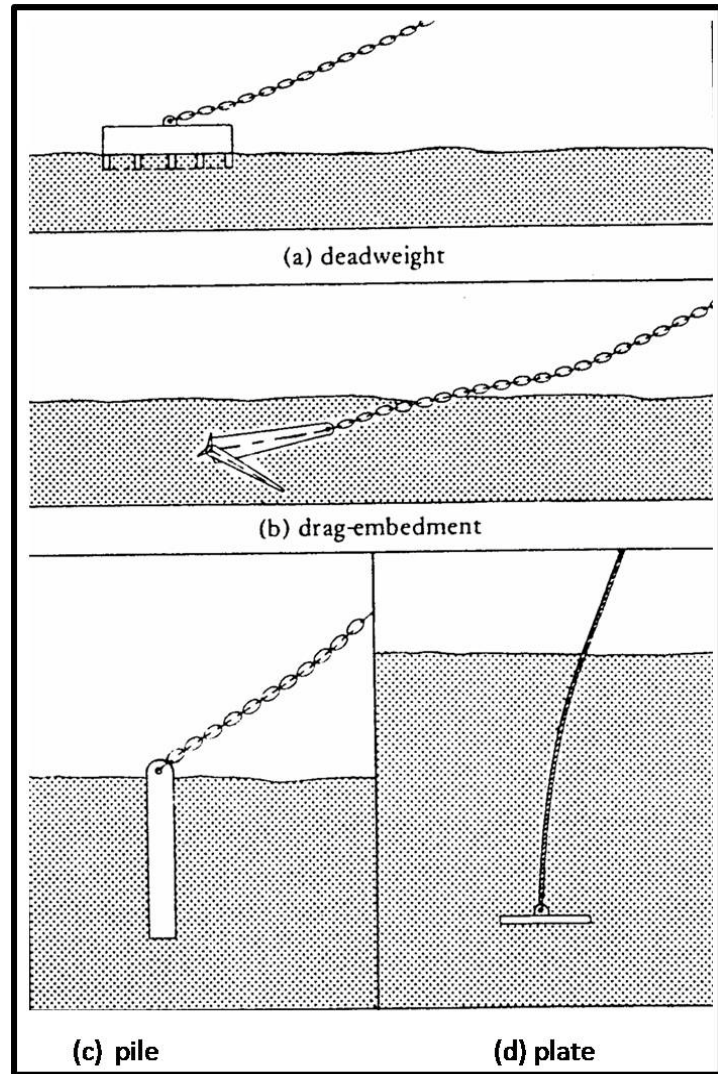

Figure 12 Generic Anchor Types

3.2.2 Scope

This chapter provides general performance, sizing and selection criteria for drag, deadweight, pile and plate anchors. Where appropriate it provides examples of commercial anchor systems that are appropriate to WEC mooring systems. The information typically was derived from manufacturer's literature and reformatted for consistency. Contact information and sources of anchoring equipment are also provided. More detailed design and sizing procedures are provided in Appendix A. Top level site survey and testing requirements are also identified with detailed survey and testing requirements provided by Fugro Inc. as Appendix B.

3.2.3 Selection of Anchor Type

3.2.3.1 Deadweight Anchor

A deadweight anchor is any heavy object placed on the seafloor to resist vertical and/or lateral loading. It can be fabricated from concrete and steel and configured to enhance lateral capacity. Deadweight anchors are often used because they are inexpensive and readily sized for most seafloor and loading conditions. In general they are not very efficient (ratio of holding capacity to weight) compared to the other anchor types, thus they may require heavy lift capabilities for installation and they are a poor choice on sloping seafloors. However, on very hard bottoms they might provide the only reasonable anchoring option. Figure 13 shows an enhanced deadweight anchor for hard bottom anchoring. It is shown with a clump to depress the chain and shorten line scope. Table 1 lists these and other features of deadweight anchors.



Figure 13 Enhanced Deadweight Anchor

Table 1 Features of Deadweight Anchors

Large vertical reaction component, permitting shorter mooring line scope
No setting distance
Lateral load resistance decreases rapidly with increase in seafloor slope
Reliable holding capacity because most capacity due to anchor mass
Simple on-site construction possible, tailored to task
Size limited by load handling equipment
Material for construction readily available and economical
Reliable on thin sediment over rock
Mooring line connection easily to inspect and service
In shallow water, the large mass can be an undesirable obstruction
Lateral load resistance is low compared to other anchor types
Works well as a sinker in combination with drag-embedment anchors to permit shorter scope
A good energy absorber when used as a sinker with non-yielding anchors (pile and plate)
Lateral load resistance is low compared to most anchors except for very hard bottom conditions

3.2.3.2 Drag Anchor

A drag anchor is similar to an inverted “kite” that is placed on the seafloor and dragged laterally until the anchor fluke trips and then penetrates the seafloor to a depth that depends upon load, anchor weight, anchor configuration and seafloor properties.

Figure 14 depicts anchor penetration in soft clay with both chain and wire forerunners. Figure 15 depicts a more traditional “looking” anchor. Typically anchor penetration and capacity increase with a wire forerunner. However, in dense and hard soil capacity may actually decrease with a wire forerunner by up to 25% and is not recommended. Loading direction at the anchor should be near-horizontal to the seafloor to ensure optimal performance. Unless the anchor is used with clumps or deadweights to shorten line scope, a multi-leg mooring spread using drag anchors can occupy a lot of bottom real estate.

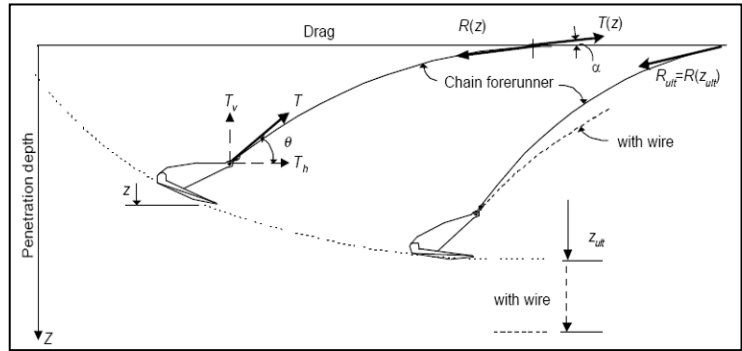

Figure 14 Anchor Penetration Behavior in Clay

Figure 15 depicts a more traditional “looking” anchor. Typically anchor penetration and capacity increase with a wire forerunner. However, in dense and hard soil capacity may actually decrease with a wire forerunner by up to 25% and is not recommended. Loading direction at the anchor should be near-horizontal to the seafloor to ensure optimal performance. Unless the anchor is used with clumps or deadweights to shorten line scope, a multi-leg mooring spread using drag anchors can occupy a lot of bottom real estate.



Figure 15 Typical Drag Anchor

Drag anchors are common in the industry, having broad use experience and they are relatively easy to install and proof. Very large size and capacity anchors are available for both mud/soft clay and sand seafloor applications. Table 2 lists these and other features of drag anchors.

Table 2 Features of Drag Anchors

Wide range of anchor types and sizes available.
Standard off the shelf equipment
High capacity (greater than 100,000 lb) achievable
Can provide continuous resistance even though maximum capacity has been exceeded.
Anchor is recoverable
Performs poorly in rock seafloors
Lower resistance to uplift loading
Behavior is erratic in layered seafloors
Large line scope required to cause near horizontal loading at the seafloor unless used with deadweights
Usable with wire or chain mooring lines
Penetrating/dragging anchor can damage buried cables or pipelines
Loading must be limited to one direction for most anchor types and applications
Exact anchor placement limited by ability to estimate setting distance
Holding capacity decreases rapidly, particularly in sand, if line angle at the seafloor is > 6 deg.

3.2.3.3 Pile Anchor

Pile anchors are used where less expensive anchors such as deadweight, drag and plate anchors cannot be used. The most common piles are long slender tubular piles (L/D ratio $> \sim 10$), which are typically fabricated from rolled steel sections. Diameters are in the range of two to eight feet for the large mooring systems. The piles are placed on the seafloor using a crane and then installed by driving with a piling hammer. Underwater pile hammers exist but cost can be prohibitive due to the need for templates. When the seafloor is rock or composed of thin sediment over rock then piles cannot be installed by driving. In this case an oversize socket must be pre-drilled for a pile to be inserted and grouted in place. The principal drawbacks of driven or drilled and grouted piles for offshore use are high cost and the need for expensive specialized installation equipment.



Figure 16 Multiple Mooring Piles Loaded for Transport



Figure 17 Multiple Suction Piles Installed from Single Vessel

Figure 16 shows mooring piles being loaded for transport on a single platform for installation using a Menck underwater hammer.

Suction piles are a relatively new type of pile system; however their use has been growing steadily in the offshore industry particularly for soft soil in deep water. They are also effective in normal sand seafloors but are not appropriate for hard bottom conditions. Figure 17 shows multiple suction piles being installed from a single workboat making installation quick, relatively inexpensive and less weather dependent than for driven or drilled piles. Suction piles can be more expensive to fabricate since they are welded construction but they are easier and cheaper to transport. Suction piles employ a lower slenderness ratio (length/diameter) than tubular piles; they are shorter and often of much greater diameter, ranging up to 10m for soft soil. There are a number of suction pumps available including some that are operable by a remotely operated vehicle (ROV) a capability that provides flexibility in installation. An important feature of suction piles is their ability to be extracted and recovered by reversing the pump to apply pressure inside the pile.

Anchor piles generate lateral capacity through passive resistance of the soil bed and axial capacity by friction or adhesion along the pile shaft. Ideally the mooring line connection is located below the top of the pile and it can vary from $\frac{1}{2}$ to $\frac{1}{3}$ of pile penetration. Table 3 lists these and other features of pile anchors.

Table 3 Features of Pile Anchors

Requires specialized installation equipment
Can be installed and performs well on substantial slopes.
High lateral capacity (greater than 100,000 lb) achievable.
Can be designed to accommodate scour and resist shallow mud flows
Resists high uplift as well as lateral loads, permitting short scope moorings
Can be installed in hard seafloors (rock and coral) by drilling and grouting
Drilled-and-grouted piles require more specialized skills and installation equipment
Wide range of sizes and shapes are possible (pipe, structural shapes)
More extensive and better quality site data are required than for other anchor types
Anchor setting not required.
Short mooring line scopes possible due to uplift resistant anchor capability
Special equipment (pile extractor) may be required for tubular piles
Suction piles are removable by reversing installation pump
Pile anchor need not protrude above seafloor
Driven piles cost competitive with other anchor types when driving equipment is available

3.2.3.4 Plate Anchor

Plate anchors are large plates that resist extraction when embedded deeply into the seafloor. Plates can be driven, vibrated, jetted, augured, shot (launched ballistically downward) or dragged into the seafloor. Driving can be accomplished with a pile driver or a suction pile. Most plate anchors are installed vertically and then reoriented (as shown in Figure 18) or expanded to achieve a large projected area and thus a high bearing resistance to uplift loading. Jetting can be used to assist penetration in dense sand when vibratory drivers are employed. In hard seafloors, capacity can be developed by friction without any reorientation. The plate in Figure 19 was driven into a coral seabed, did not rotate during load and derived its capacity primarily through friction. Plate anchors have been installed with capacities in excess of one million pounds in competent seafloor soil. They can be effective in hard seafloor conditions where drag anchors are ineffective. A key feature of plate anchors is their ability to resist high uplift loading, which allows their use in short scope mooring legs.

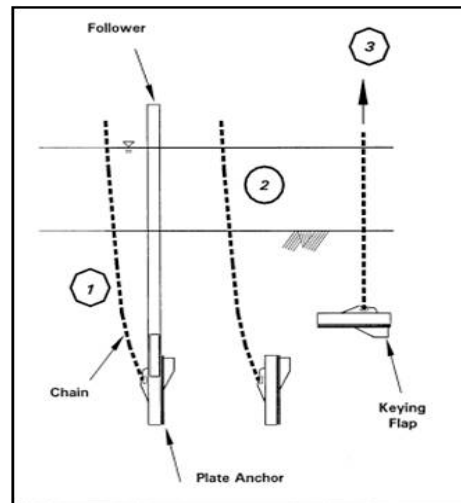

Figure 18 Driven Plate Anchor Installation



Figure 19 Coral Plate Driven Anchor

A drag-in plate anchor is installed similarly to a conventional drag anchor. Once the anchor has achieved a target depth the shank or chain/wire connection is adjusted to a normal or near-normal load. This load direction change increases anchor capacity several times in a normal clay soil. The effectiveness of a drag-in plate in sand or other competent soils has not been demonstrated. Table 4 lists features of plate anchors.

Table 4 Features of Plate Anchors

High capacity (greater than 100,000 lb) achievable.
Resists uplift as well as lateral load, permitting short-scope moorings
Higher holding-capacity-to-weight ratio than other anchor types
Accurate anchor placement is possible; minimizes environmental impact
Does not protrude above the seafloor.
Possibly susceptible to strength reduction due to cyclic loading in loose sand/coarse silt seafloors
Driven anchor typically not recoverable
Drag-in plates are recoverable
Anchor cable may be susceptible to abrasion or fatigue.
Driven plates effective in soft and hard seafloors and in coral
Can be placed on moderate slopes
Penetration is controlled and can be monitored
Suction driven plates limited to soft seafloors
Driven plate installation with surfaced-powered equipment limited to shallow depths
Suction driven and drag-in plates are not depth limited

3.2.4 Anchor Selection Criteria

Table 5 provides general criteria for evaluating and selecting an appropriate anchor type for WEC anchoring applications. Table 6 provides further criteria for evaluating the behavior and acceptability of the four generic anchor types in different soil conditions, topography, load direction and load range.

Table 5 General Criteria for Evaluation and Selection Criteria of WEC Anchors

Parameter	Description
Holding capacity	The size/type of anchor will depend on the amount of anchor holding required
Soils	Engineering properties and sediment layer thickness influence anchor design and selection
Use	If anchors will be relocated, then drag anchors are most commonly used
Weight	The amount of weight that can be handled or carried may control anchor specification
Equipment	The size and characteristics of anchor installation equipment are important in anchor specification
Directionality	Drag anchors may provide little uplift capacity and primarily hold in one direction; plates and piles may provide high omnidirectional capacity
Performance	Acceptability of anchor drag, as well as the amount of available real estate for mooring systems will influence anchor specification

Table 6 Behavioral Criteria for Evaluation and Selection of WEC Anchors

<u>Seafloor Material</u>	Deadweight	Pile	Plate	Drag
Soft clay, mud	++	+	++	++
Soft clay layer (0-20 ft) over hard layer	++	++	o	+
Stiff clay	++	++	++	++
Sand	++	++	++	++
Hard glacial till	++	++	++	+
Boulders	++	o	o	o
Soft rock or coral	++	++	++	+
Hard, massive rock	++	+	+	o
<u>Seafloor Topography</u>				
Slope < 10 deg	++	++	++	++
Slope > 10 deg	o	++	++	o
<u>Loading Direction</u>				
Omnidirectional	++	++	++	o
Unidirectional	++	++	++	++
Large uplift	++	++	++	o
<u>Lateral Load Range</u>				
To 100,000 lb	++	+	++	++
100,000 to 1,000,000 lb	+	++	+	++
Over 1,000,000 lb	o	++	o	o
++ Functions well + Functions, but not normally the best choice o Does not function well				

3.2.5 Site Investigation

This section summarizes criteria and considerations for characterizing a site for WEC anchoring systems. Appendix B prepared by Fugro West Inc. provides detailed guidance for site and route surveys and in-situ and laboratory geotechnical investigations. Gathering the recommended geotechnical and geophysical information is a critical first step in the process of selecting and sizing an effective and efficient anchoring system.

The appropriate type and level of detail of the survey and seafloor investigation will be a function of:

- Value and replacement cost of the WEC
- Consequences of failure (loss of life, sequential mooring failure, damage to neighboring assets)
- Type and size of potential anchor
- Topography and seafloor material type (potential for scour, slope failure)
- Environmental loading conditions
- Hazardous conditions (earthquake, faulting, cables and pipelines)
- Availability of survey equipment and personnel

Table 7 lists the minimum required data for the four generic anchor types. The level of importance of each item is listed as low, high or not applicable (N/A). A low rating may mean either a low impact on the anchor design or selection or an inability to use this data for design due to technical limitations. Pile anchors require the maximum amount and highest quality of data for proper design. Plate anchors are somewhat more forgiving in that over- design due to lesser quality soil data has less cost impact on the final install product.

Table 7 Site Data Requirements for Categories of Geotechnical Engineering Applications

Anchor Type	Requirements for following site data								
	Topography		Material Thickness	Sediment				Rock/Coral	
	Macro (> 3 ft)	Micro (< 3 ft)		Index Properties	In-Situ Strength	Laboratory Strength	Dynamic Response	Index Properties	Laboratory Strength
Deadweight	high	low	high	high	low	high	N/A	N/A	N/A
Drag	high	low	high	high	low	high	low	N/A	N/A
Pile	high	low	high	high	high	high	high	high	high
Plate	low	N/A	high	high	low	high	high	N/A	low

Table 8 lists the specific geotechnical parameters required for each anchor type. A key requirement is the depth of the survey and the consequent larger laboratory investigation particularly for piles and plates. Although the need for laboratory strength data is listed as high in Table 8, it is of lesser importance to a final design because (in general) the primary effect of strength is on final depth of penetration rather than anchor ultimate capacity.

**Table 8 Soil Engineering Parameters
Normally Required for Categories of Geotechnical Engineering Applications**

Anchor	Soil Classification	Grain Size	Atteberg Limits	Strength Properties				Compression Properties			Subbottom Depth of Survey
				Clay		Sand		Clay		Sand	
				S_u, S_t	C, ϕ	ϕ	ϕ_u or S_u	C_v, k	C_c	C_c	
Deadweight	yes	no	no	yes	yes	no	no	no	no	no	1.5-2 x anchor width
Drag	yes	yes	no	yes	no	no	no	no	no	no	30-60 ft clay; 10-16 ft sand
Pile	yes	yes	yes	yes	yes	yes	yes	no	no	no	depth of pile anchor tip
Plate	yes	yes	no	yes	yes	yes	yes	no	no	no	to expected penetration of plate (abt. 30 ft sand; 60 ft clay)

3.2.6 Anchor Products

The four anchor types are described in this section followed by examples of commercially available anchors or construction options. Data were gathered from open websites and reformatted for consistency. Features listed on the “data sheets” contain manufacturer’s and the author’s opinions.

3.2.6.1 Deadweight Anchors

Generally, deadweight anchors are built to individual requirements, according to established design criteria (Reference 34), and therefore are not normally marketed commercially. Figure 20 shows a variety of types of deadweight anchor, running from the simplest to the more complex. The simpler types are typically used for lower-level requirements, where their size and weight may be handled easily by available installation equipment and the cost of their fabrication is not excessive. On the other hand, where the loads are high and the cost is considerable or the installation assets are limited, the more complex types offer increased efficiency (higher ratio of holding capacity to size and weight), which may help control fabrication and installation costs.

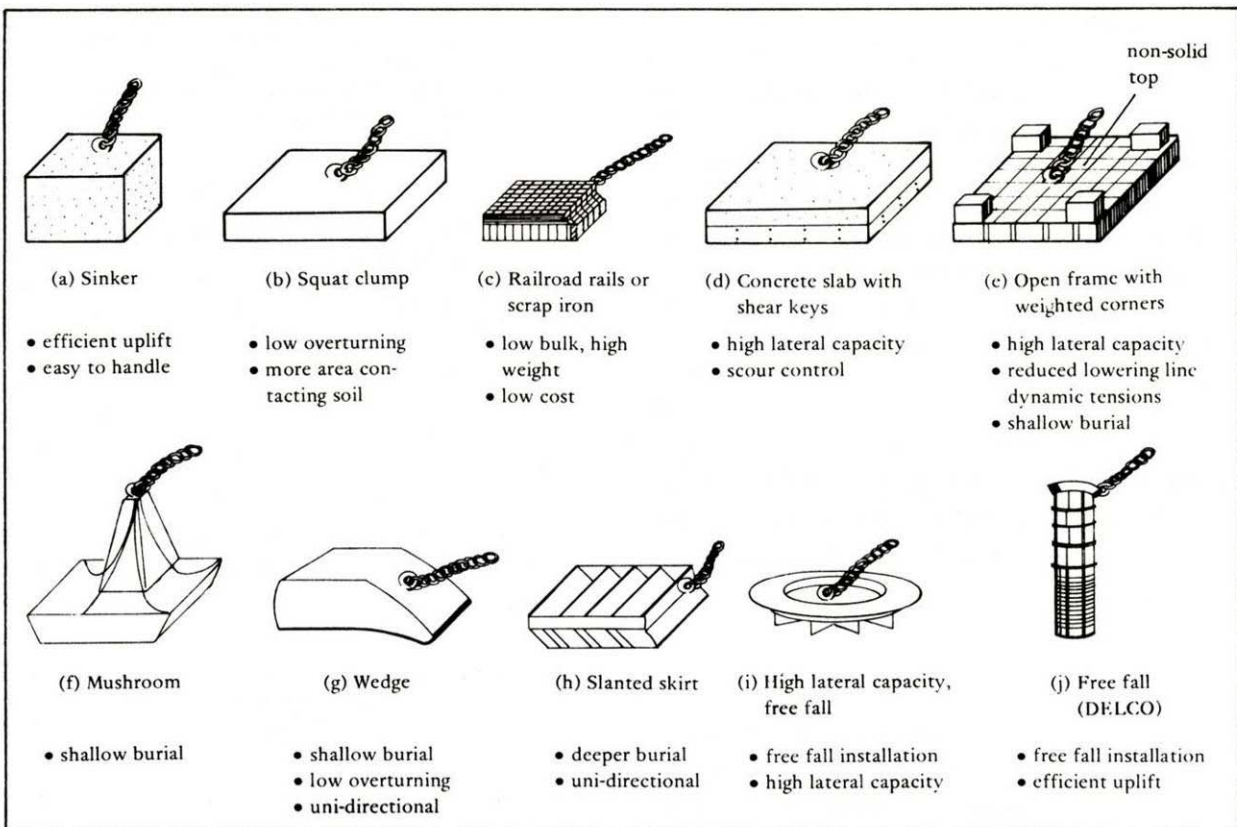

Figure 20 Types of Deadweight Anchors

3.2.6.2 Drag Anchors

There are dozens of anchors available that could be used for various model and prototype WEC anchoring and mooring applications. The conventional anchor types' in Figure 21 are typically used as ships (Bower) anchors and for various other temporary mooring applications. They could offer cost effective anchoring solutions for smaller scale demonstrations. Other than the Danforth and Bruce (cast version shown) anchors these can all be categorized as stockless anchors with moderate to low holding capacities.

These anchors normally don't have adjustable fluke angles for optimized performance in either hard or soft seabed conditions and are not deep burial, otherwise recovery could be problematic. shows anchors commonly used for moorings and offshore operations. Several of these anchors including the Danforth, Moorfast and LWT are cast and thus lose their effectiveness more rapidly with increasing size than do the fabricated steel anchors such as the Bruce, Vryhof (Stevpris / Stevshark) and Flipper Delta anchors highlighted in Figure 22.

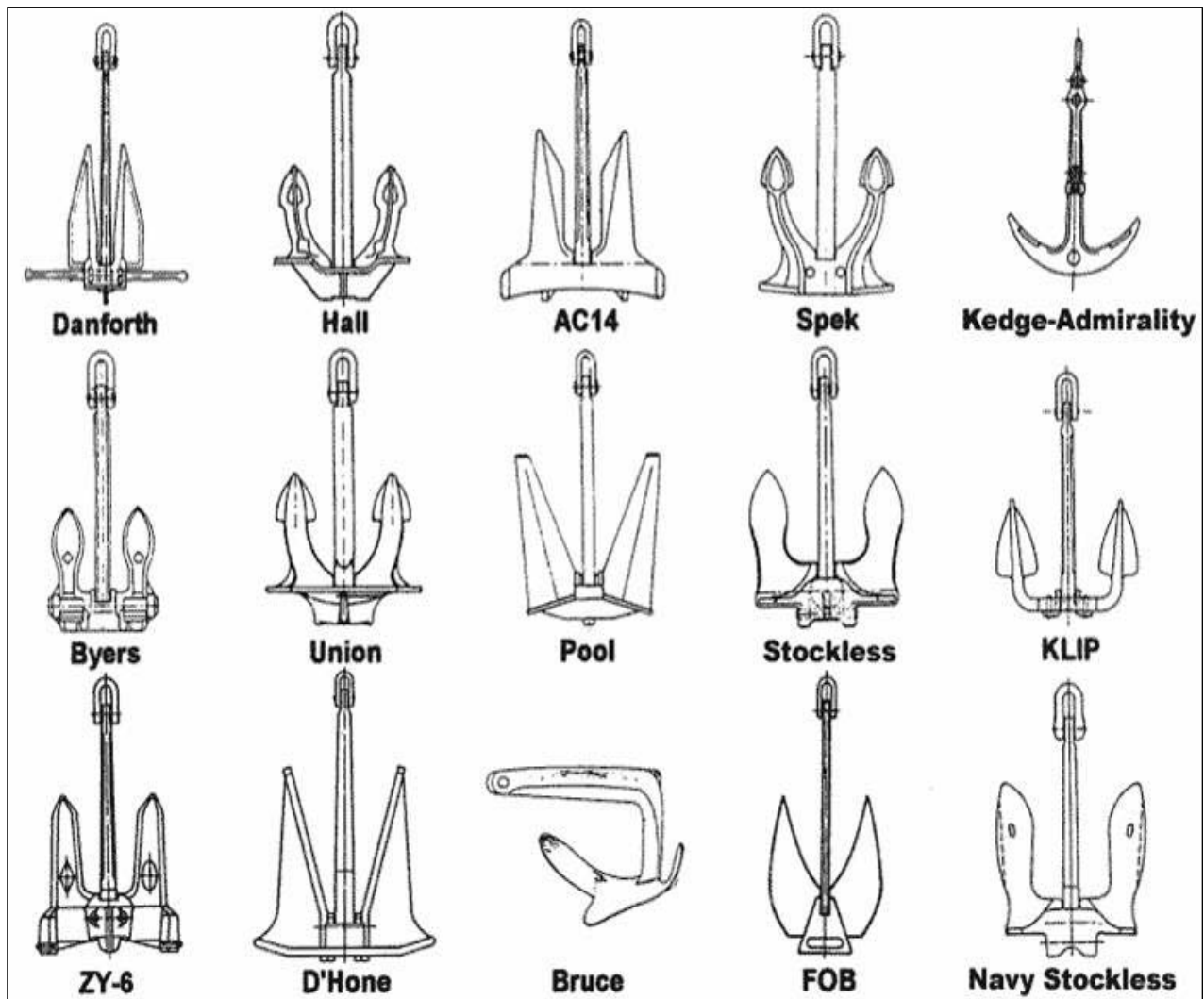

Figure 21 Conventional Anchor Types (after Waterman Supply)

Bruce, Vryhof and Flipper Delta anchors enjoy the widest usage in the offshore industry today for high capacity mooring applications, are functional in a broad range of seabed conditions and are readily available. Features and anchor sizing information for specific Bruce, Vryhof and Flipper Delta anchors are provided in the following pages. The selected anchors are considered appropriate for the likely hard bottom/sand conditions anticipated for the Oregon coast. Details of the other anchors can be found at the websites listed at the end of this section.

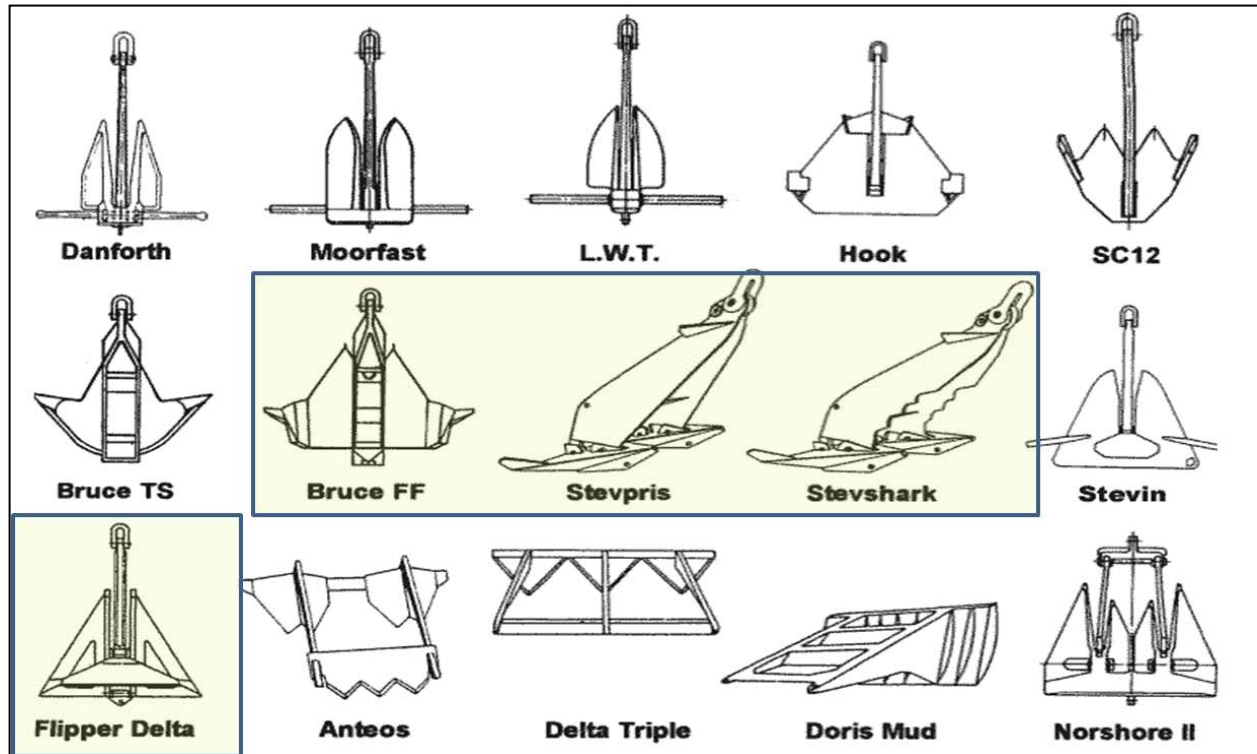

Figure 22 Mooring and Offshore Anchors (after Waterman Supply)

Bruce FFTS MK4

Manufacturer

Bruce Anchor Limited, Anchor House, Cronkbourne, Douglas, Isle of Man, IM4, British Isles

Phone: 44-1624-629203, Fax: 44-1624-62227, web: www.bruceanchor.co.uk

Features

- Choice of two fluke angles to suit soft and hard soil conditions
- Self righting capability
- Stable with drag
- Sharp fluke tips enhance hard soil penetration
- Simple recovery by chain chaser
- Suited to piggyback configuration
- Can be disassembled for transport

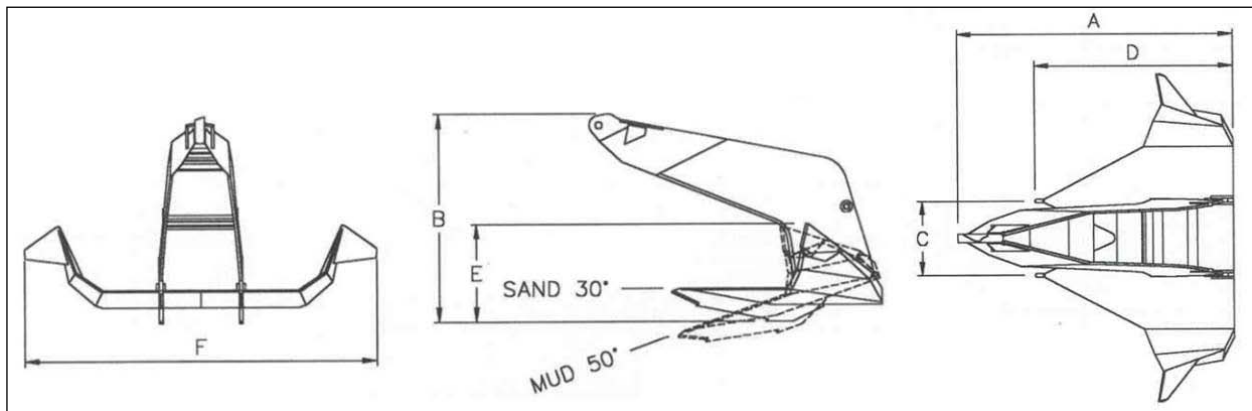

The table gives nominal dimensions of certain sizes but since the anchors are fabricated from steel plate they can be supplied in any size to suit customer requirements, from 250kg up to 60,000 kg.

Weight kg	NOMINAL DIMENSIONS (in mm)					
	A	B	C	D	E	F
500	1827	1280	500	1303	606	2188
1500	2648	1854	723	1888	878	3172
3000	3409	2388	931	2431	1131	4085
5000	4029	2822	1100	2873	1336	4828
9000	4846	3394	1324	3456	1607	5806
10000	5087	3563	1390	3628	1687	6095
12000	5437	3808	1486	3878	1803	6514
15000	5728	4012	1566	4085	1900	6864
18000	6129	4292	1674	4371	2032	7343
20000	6319	4426	1726	4507	2096	7571
30000	7225	5060	1974	5153	2396	8656
40000	8034	5627	2195	5730	2664	9626

Bruce FFTS PM

Manufacturer

Bruce Anchor Limited, Anchor House, Cronkbourne, Douglas, Isle of Man, IM4, British Isles

Phone: 44-1624-629203, Fax: 44-1624-62227, web: www.bruceanchor.co.uk

Features

- Choice of four fluke angles to suit soft and hard soil conditions
- Self righting capability
- Stable with drag
- Sharp fluke tips enhance hard soil penetration
- Simple recovery by chain chaser
- Pendant lugs at rear of flukes for piggyback anchor
- Can be disassembled for transport
- Single point recovery lug on fluke minimizes breakout resistance

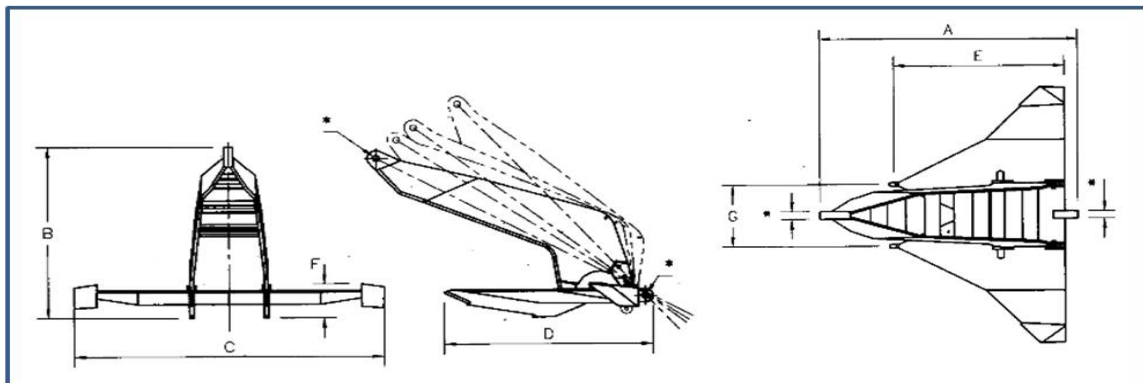

EXAMPLE SIZES	NOMINAL DIMENSIONS (in mm)						
Weight kg	A	B	C	D	E	F	G
5000	4288	2995	4659	3141	2768	594	1120
10000	5318	3715	5778	3895	3434	737	1389
15000	6012	4199	6531	4403	3881	833	1571
20000	6764	4725	7349	4954	4367	937	1767
30000	7742	5408	8412	5671	4999	1072	2023
40000	8437	5893	9166	6179	5447	1169	2204

Bruce Hard Bottom TS

Manufacturer

Bruce Anchor Limited, Anchor House, Cronkbourne, Douglas, Isle of Man, IM4, British Isles

Phone: 44-1624-629203, Fax: 44-1624-62227, web: www.bruceanchor.co.uk

Features

- Purpose built for very hard bottom (40 – 90 psi clay) seabed application
- Configured with single hard bottom fluke angle only
- Designed with lugs at knee of shank for piggyback anchor to enhance penetration of primary HBTS and/or to supplement capacity for softer than anticipated conditions
- Can be disassembled for transport
- HBTS not actively marketed but can be fabricated in various sizes for very hard bottom applications

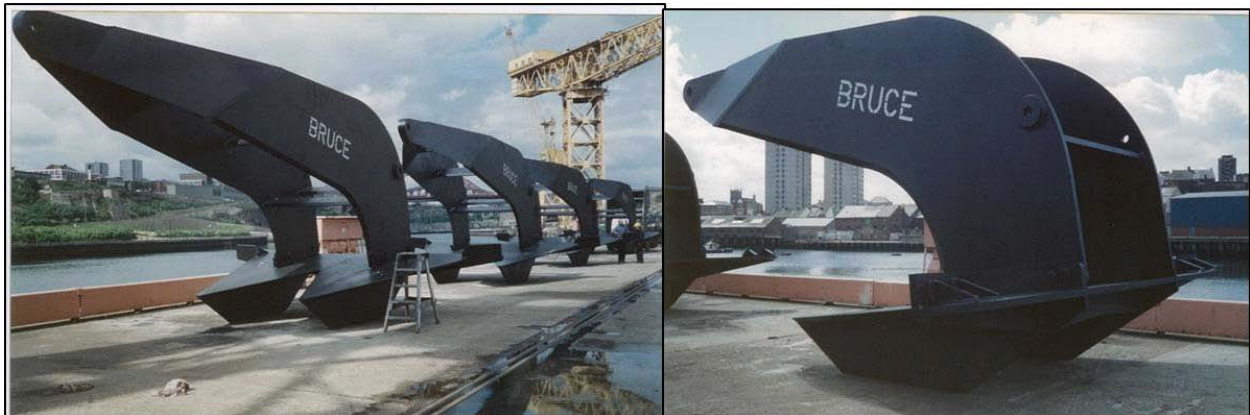
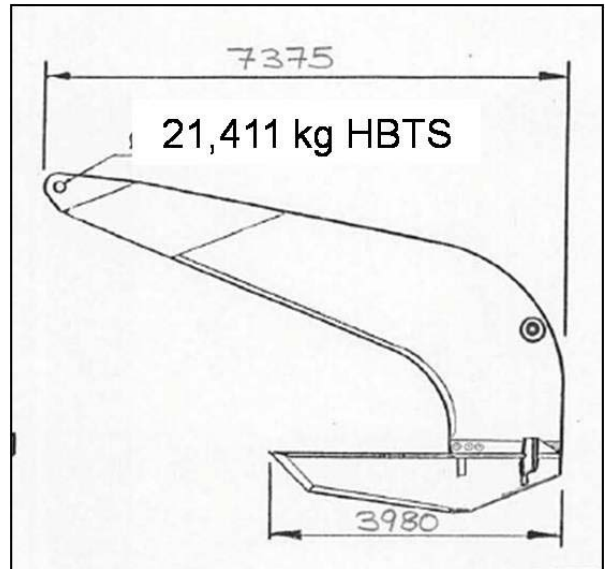

Stevpris MK5

Manufacturer

VRYHOF ANCHORS BV, P.O. Box 109, 2900 AC Capelle a/d Yssel, The Netherlands

Phone: +31 10 266 8900, Fax: +31 10 266 8999, web: <http://www.vryhof.com/>

Features

- Choice of three fluke angles (320, 410, 500) to suit most soil conditions
- Not self-righting: must be placed on seabed with flukes oriented down
- Suited to piggyback configuration
- Simple recovery by chain chaser
- Can be disassembled for transport

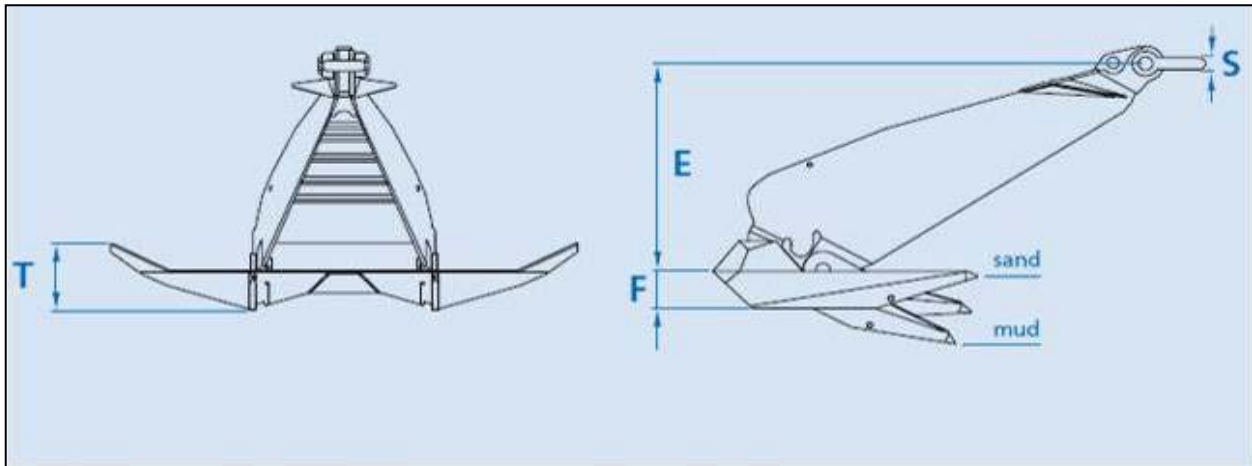

Main dimensions Stevpris Mk5 dimensions in mm anchor weight in kg													
weight	1500	3000	5000	8000	10000	12000	15000	18000	20000	22000	25000	30000	65000
A	2954	3721	4412	5161	5559	5908	6364	6763	7004	7230	7545	8018	10375
B	3184	4011	4756	5563	5992	6368	6860	7290	7550	7794	8133	8643	11184
C	1812	2283	2707	3166	3410	3624	3904	4149	4297	4436	4629	4919	6365
E	1505	1896	2248	2629	2832	3010	3242	3446	3569	3684	3844	4085	5286
F	271	342	406	474	511	543	585	622	644	665	694	737	954
H	1230	1550	1837	2149	2315	2460	2650	2816	2917	3011	3142	3339	4321
T	493	622	738	862	929	988	1064	1131	1171	1209	1262	1341	1736
S	80	90	110	130	140	150	170	180	190	200	200	220	300

Note: The dimensions of the Stevshark Mk5 anchor may be changed for specific applications

Stevshark

Manufacturer

VRYHOF ANCHORS BV, P.O. Box 109, 2900 AC Capelle a/d Yssel, The Netherlands

Phone: +31 10 266 8900, Fax: +31 10 266 8999, web: <http://www.vryhof.com/>

Features

- Choice of three fluke angles (320, 410, 500) to suit most soil conditions
- Not self-righting: must be placed on seabed with flukes oriented down
- Suited to piggyback configuration
- Sharp fluke tips and serrated shank to enhance hard soil penetration
- Simple recovery by chain chaser
- Similar to Stevpris MK5 but has stronger construction, shark teeth, sharp fluke edges and fluke tips for very hard soils. The hollow fluke can be ballasted to assist penetration; weights in table do not include ballast
- Can be disassembled for transport

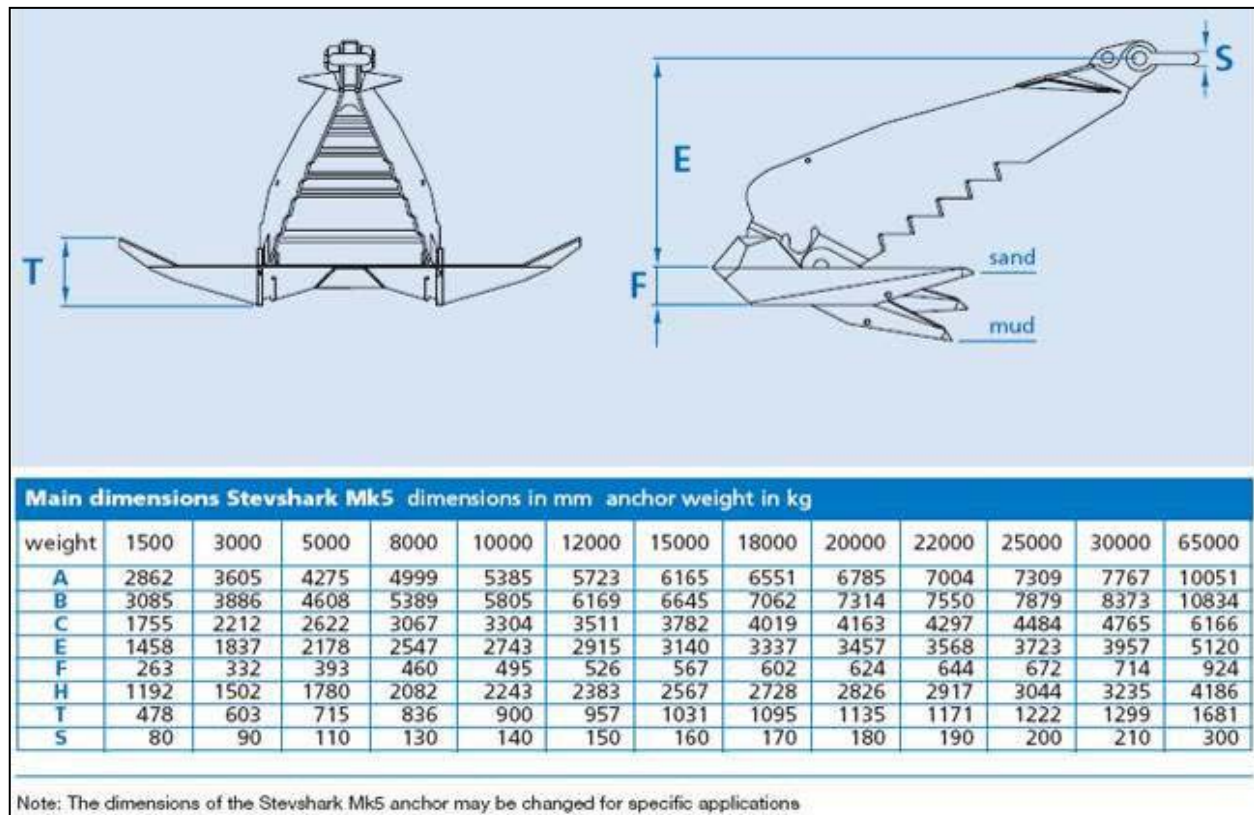

Flipper Delta

Manufacturer

Anker Advies Bureau, b.v. G.J. Wortelboer Jr., P.O. Box 5003, NL-3008 AA Rotterdam, Quarantaineweg 5 NL-3089 KP Rotterdam, The Netherlands T: +31 (0)10 - 429 22 22 F: +31 (0)10 - 429 64 59 <http://www.flipperdelta.com/>

Features

- Choice of three fluke angles
- 280 for very hard bottom soils like rock, cemented sand or coral
- 360 for average soil conditions
- 500 for soft clay and mud
- Sharp flukes enhance hard soil penetration
- Demonstrated stable in mud
- Suited to piggyback configuration
- Can be disassembled for transport

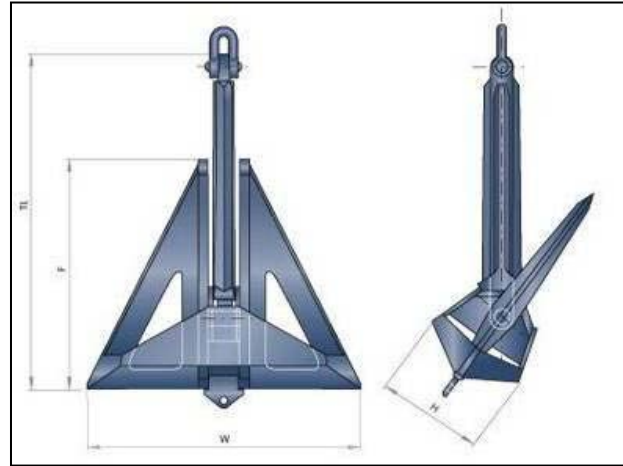

Weight (in kgs)	Dimensions W (in mm)	Dimensions F (in mm)	Dimensions H (in mm)	Dimensions TL (in mm)
500	1500	1200	570	1800
1000	1960	1560	740	2305
2000	2470	2000	930	2960
3000	2830	2285	1070	3380
5000	3330	2660	1260	3945
7000	3750	2995	1405	4440
7500	3850	3080	1435	4565
9000	4130	3320	1550	4925
10000	4270	3400	1600	5040
12000	4530	3600	1705	5335
15000	4845	3875	1830	5735
22500	5490	4360	2060	6905
400000	6650	5290	2480	7850
500000	7150	5690	2670	8440
600000	7600	6040	2830	9000
750000	8200	6560	3100	9430

3.2.6.3 Pile Anchors

Pile anchors are pipes, beams or similar structures installed into the seafloor by driving, drilling and grouting, suction or other underwater construction method. There is a huge experience base for the design and installation of traditional driven and drilled and grouted piles. Piles typically require significant floating and installation support but they may afford an economical mooring solution for large scale commercial WEC system installations.

Pile anchors require the greatest amount of geophysical and geotechnical data to expected depths of penetration, which can reach several tens of meters depending on pile type.

Driven and drilled-and-grouted piles

Tables 9 – 11 provide information on various driven and drilled-and-grouted piles. Table 9 describes pile types, including straight (prismatic), expanding tip (umbrella), chain-in-hole, and rock bolt. As most moorings apply a considerable lateral load component to the pile, mooring connections must sustain such loads, and the lateral load capacity of the pile is of major concern. Table 10 describes mooring line connections, including top-end padeye, side padeye, load-distributing bridle, and top-end swivel. Table 11 describes ways to improve lateral load capacity, including lowering the mooring line attachment point, burying the pile below grade, attaching fins to the upper end of the pile, and using an upper-end shear collar and lower-end anchor to effect a combination of increased soil bearing and confinement with uplift resistance.

Table 9 Pile Types

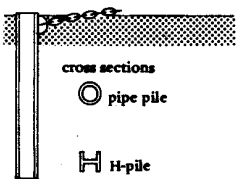
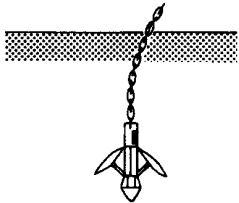
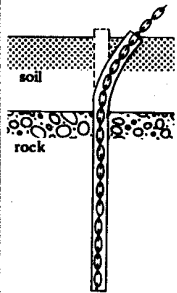
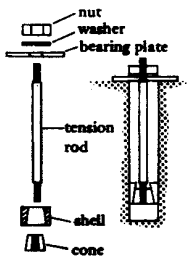
Characteristics	Pipe and H-Piles	Umbrella Piles ^a	Chain-in-Hole ^a	Rock Bolts ^a
Applications	Foundations and Anchors	Anchors	Anchors	Anchors
Approximate Maximum Capacity	Axial: 20,000 kips Lateral: 1,500 kips	300 kips in sand 100 kips in mud	550 kips	30 kips
Installation Methods	driven or drilled and grouted	driven	drilled and grouted	drilled and grouted, or mechanically wedged
Applicable Soil Type	soil and rock	soils without boulders and other obstructions	rock, with overlying soil strata	rock
Advantages	easy to splice; high capacity; can penetrate through light obstructions	high capacity in uplift	high capacity	very low cost, no heavy mechanical equipment necessary
Disadvantages	high cost; vulnerable to corrosion	maximum depth limited by hammer; soils must be homogeneous; inspection of connection not possible	inspection of connection not possible	rock must be competent, non-fractured (shallow water only), low capacity
Remarks	pipe piles resist bending in any direction	resistance developed similar to plate-embedment anchor (Chapter 6)		diver hand-installed, much smaller size than normal piles
Illustration	(anchor pile shown)  cross sections ○ pipe pile H H-pile	(in-service position) 		(wedged bolt shown)  nut washer bearing plate tension rod shell cone

^aSpecial anchor pile.

Table 10 Mooring Line Connections

Type of Connection	End Padeye	Side Padeye	Bridle	Swivel
Advantages	Omni-directional loading. Easily inspected and repaired. Simple construction.	Applicable to H-piles. Simple construction.	Distributes load around pile.	Omni-directional loading. Eliminates torsional stresses in pile.
Disadvantages	Can introduce torsional stresses in pile.	Applicable for uni-directional loadings.	Uni-directional loading. Cannot be inspected and repaired.	Design must protect against fretting corrosion. Complex construction.
Illustration				

Table 11 Techniques to Improve Pile Lateral Load Capacity

Technique	Lowered Attachment Point	Buried Pile Head	Attaching Fins	Shear Collars With Anchor Plates
Advantages	Lateral load is reduced. Lateral resistance is higher.	Lateral load is reduced. Provides for scour in sand.	Increases lateral resistance. Limits pile head deflection and bending moment.	Increases lateral and uplift resistance.
Disadvantages	Uni-directional loading. Inspection and repair of connection impractical. Soil in front of pile may be weakened.	Inspection and repair of connection impractical.	More costly fabrication.	Complex installation. More costly fabrication. Limited experience with system.
Illustration				

Suction piles

Suction piles are an important subset of the pile category and are a relatively new type of pile anchor. Because of unique advantages for various gas and oil mooring applications there has been extensive research into the design and application of this pile type. As a result there is a huge body of scientific and technical data that provide design guidance. Suction piles are typically shorter and stubbier (having a lower slenderness ratio) than driven or drilled-and-grouted piles. Such short, stubby piles are commonly called caissons. Suction caissons typically provide a greater resistance to lateral loads than driven piles because of the larger diameters typically used.

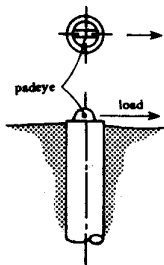
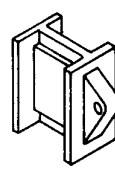
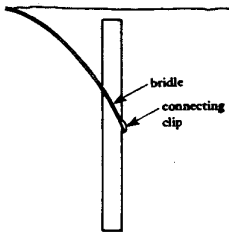
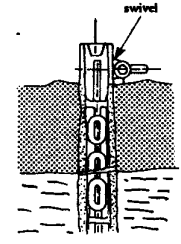
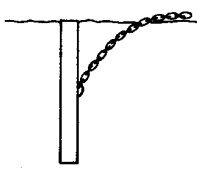
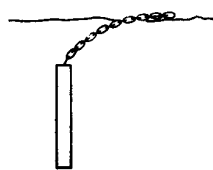
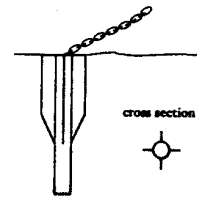
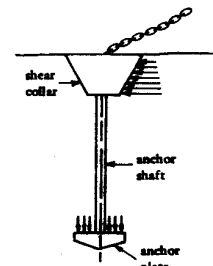
During installation, the suction caisson acts as an inverted bucket. Initial penetration of the suction caisson into the seabed occurs due to the self weight; subsequent penetration is by the “suction” created by pumping water out from the inside of the caisson. The installation method involves applying a pressure differential.

The rim of the inverted bucket seals with the seafloor, and then water is pumped out of the upper end of the enclosed volume (Figure 23). This produces a net downward pressure, or suction, forcing the bucket into the seabed. In clays, the pressure is sufficient to bring the suction caisson to a substantial depth. In sands, water inflow reduces the effective stresses in the sand near the bucket rim, allowing the bucket to penetrate the seafloor. Once installed to sufficient depth, the pumps are removed and the valves are sealed, with the sand quickly regaining its bearing capacity. Suction caissons can easily be removed by reattaching the pumps and pumping water back into the bucket cavity, forcing it out of the seabed.

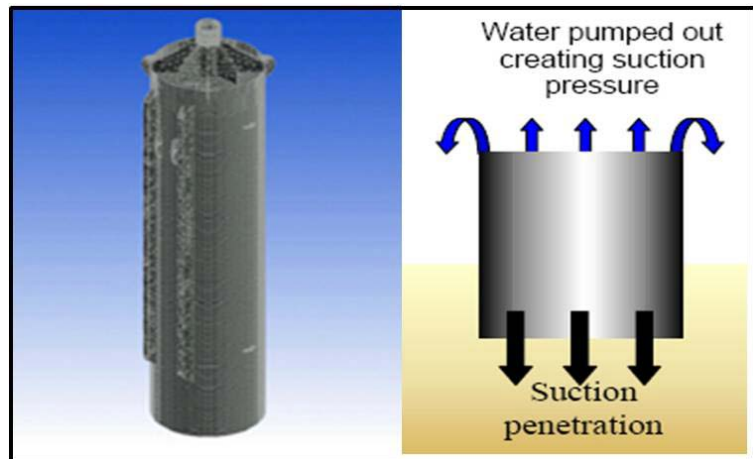

Figure 23 Suction pile example and penetration process

Features of specific suction caisson anchors are provided in the following pages.

SPT Suction Pile

Manufacturer

SPT Offshore, Korenmolenlaan 2, 3447 GG Woerden, The Netherlands, tel: +31(0)348 435260, fax: +31(0)348 435261 e-mail: info@suctionpile.com , web: www.sptoffshore.com

Features

- Broad industry experience
- High holding capacity independent of load angle
- Suitable for taut, semi-taut and catenary moorings
- System is recoverable
- System requires specialized install equipment and positional control during installation
- Proven performance in mud and sand seabeds
- A suction pile does not require an external pull test
- Multiple sizes and configurations possible including single pile and cluster piles as show below

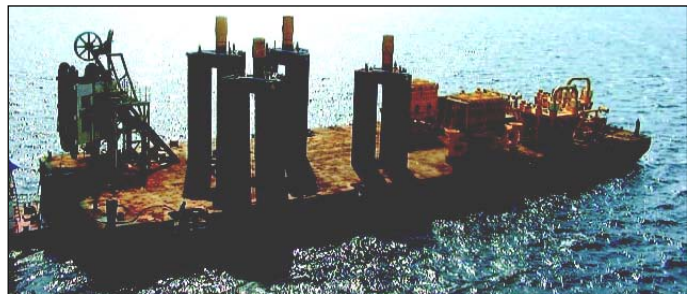
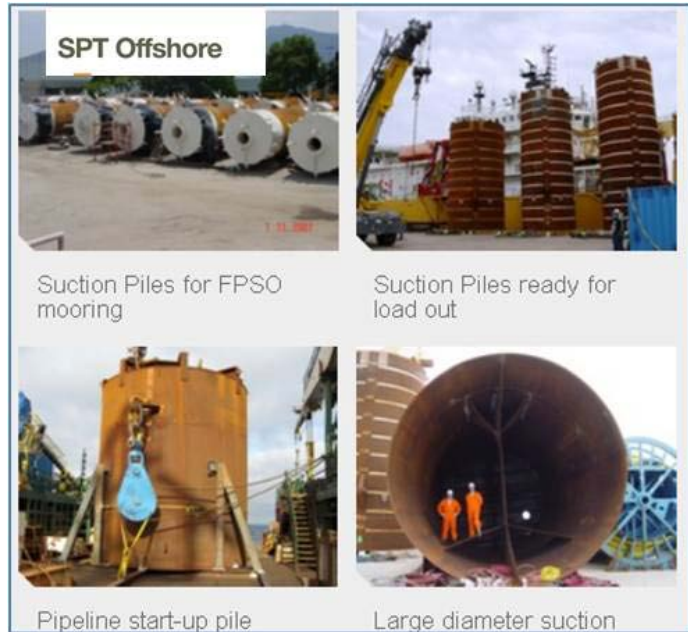

Delmar Suction Pile

Manufacturer

Delmar Systems Inc. TECHNICAL & ENGINEERING 2424 Wilcrest Dr., Ste 225 Houston, TX 77042 832.252.7100 Fax: 832.252.7140; <http://www.delmarus.com/site.php>

Features

- Broad industry experience
- High holding capacity independent of load angle
- Suitable for taut, semi-taut and catenary moorings
- System is recoverable
- Proven performance in mud and sand seabeds
- A suction pile does not require an external pull test
- Multiple anchors installed from single workboat
- System requires specialized install equipment and positional control during installation
- Suction anchor system can be installed using Delmar's proprietary single vessel/single line installation method using one vessel with ROV capability
- Delmar Subsea Connector (DSC) allows a mooring line to be connected or disconnected at any time by an ROV.



3.2.6.4 Plate Anchors

Plate anchors have been used for more than 50 years in a variety of forms primarily by the US Navy but only recently have the advantages of this type of anchor been fully appreciated by the offshore industry. Plate anchors are large plates that can be embedded into the seafloor by a variety of means including driving, vibrating, jetting, auguring, dragging and combinations of these driving means. Holding capacity varies with the configuration of the anchor, seafloor composition, burial depth and loading characteristics. Typically the plate is installed edgewise into the seafloor and then reoriented by various means shown in the following plate anchor examples to maximize holding capacity.

There is a large body of information available that allows confident design of plates with known seafloor engineering properties. Plate anchor holding capacity can be calculated using validated geotechnical engineering design methods described in Appendix A. Figure 24 is a simple illustration of the behavior of an installed plate subjected to uplift loading. Ideally the plate should be embedded sufficiently to ensure deep anchor failure because shallow anchor capacity changes rapidly with depth compared to deep anchors. Deep anchor behavior occurs at relative depths of two to five times anchor width for soft to hard clay respectively and four to eight times anchor width for loose to dense sand respectively. The decision to use a plate anchor effectively depends upon the engineering properties and depth of available sediment.

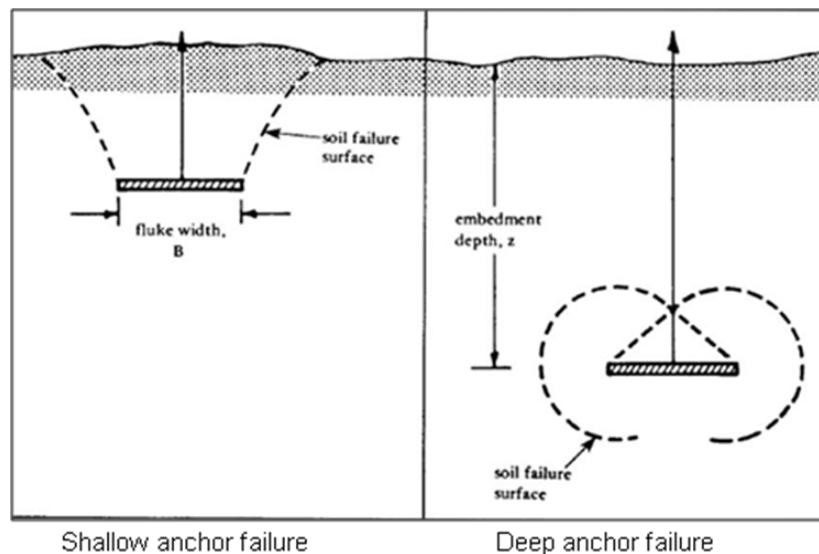

Figure 24 Generalized Behavior of Plate Anchor

Primary advantages of this anchor type include very high efficiencies (holding capacity to installed weight ratios) and resistance to uplift loading, thus they can be used in short scope moorings. Installation can be more complicated and may require specialized equipment but this anchor type has advantages primarily where real estate may be limited and where commercial-scale installations requiring multiple mooring systems are required.

In the following pages, descriptions are provided of four types of plate anchor that may be suited to WEC system moorings. They include suction embedded plates, pile-driven plates, gravity installed plates and drag-in plates.

SEPLA – Suction Embedded Plate Anchor

Manufacturer

InterMoor: 1-800-451-8106 web: www.intermoor.com

Features

- Plate driven into seabed by suction pile
- Geotechnically more efficient than normal suction pile in uplift
- High holding capacity independent of load angle
- System is recoverable
- System requires specialized install equipment and positional control during installation
- Proven performance in mud; performance in sand and hard soil unknown
- Two boat installation sequence

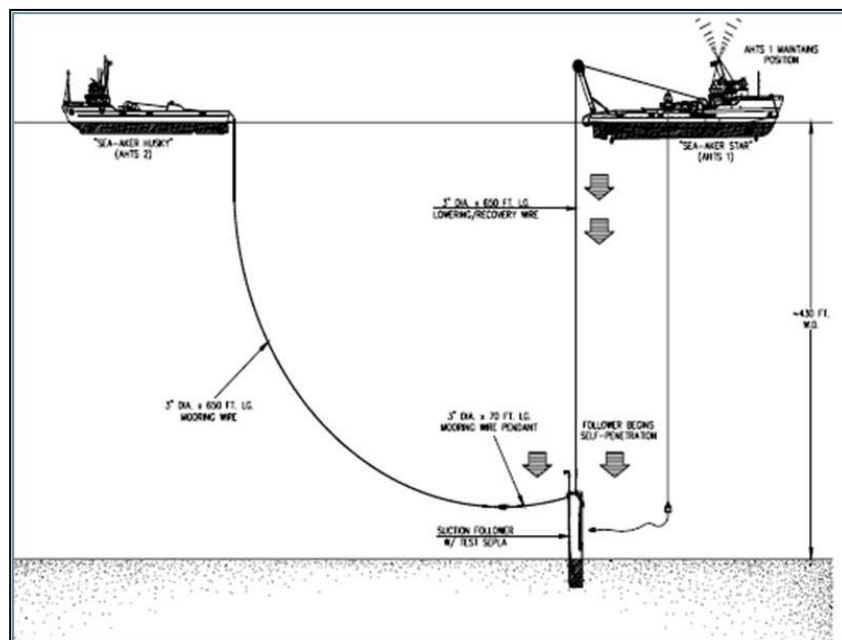

SEA - Suction Embedded Anchor

Manufacturer

SPT Offshore, Korenmolenlaan 2, 3447 GG Woerden, The Netherlands, tel: +31(0)348 435260, fax: +31(0)348 435261 e-mail: info@suctionpile.com , web: www.sptoffshore.com

Features

- Plate driven into seabed by suction pile
- Geotechnically more efficient than normal suction pile in uplift
- System requires specialized install equipment and positional control during installation
- High holding capacity independent of load angle
- Proven performance in mud; performance in sand and hard soil unknown
- SEA proof loaded in-situ, hence no external load test required

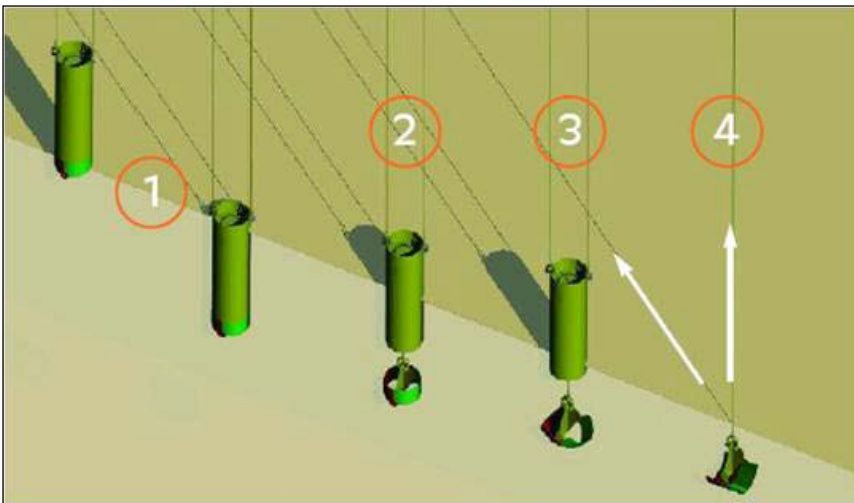
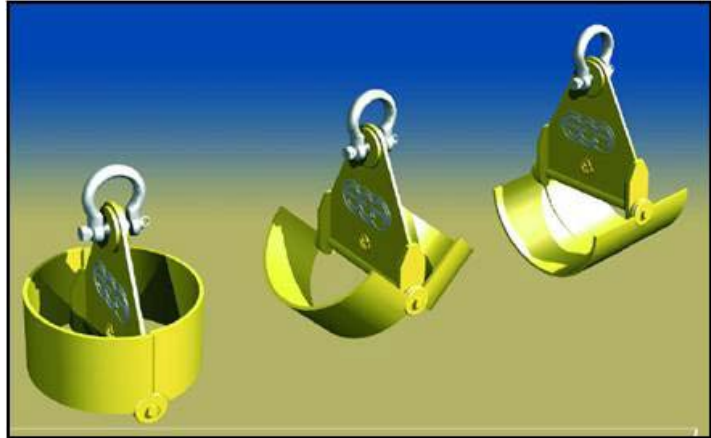

SEA opening trajectory

- Embed SEA using suction follower
- Release rigging
- Open SEA by reversed suction process
- SEA ready for use

US Navy Pile-Driven Plate Anchor

Manufacturer

Design details available in following reference document. Plates and followers can be fabricated by multiple steel fabrication facilities.

Reference

Forrest, J. Taylor, R. Bowman, L., "Design guide for pile-driven plate anchors", TR-2039-OCN, March 1995, Naval Facilities Engineering Service Center, Port Hueneme, CA

Features

- Plate driven or vibrated into seabed
- Simple plate construction
- Proven performance in soft and hard seabeds
- Plates sized/configured for sand, clay and coral seabeds
- High holding capacity independent of load angle
- System requires standard pile driving equipment from a stationary barge
- Keying flaps on back required for mud/soft clay only to ensure rapid plate rotation/keying when loaded
- Followers can be pipe or WF beams

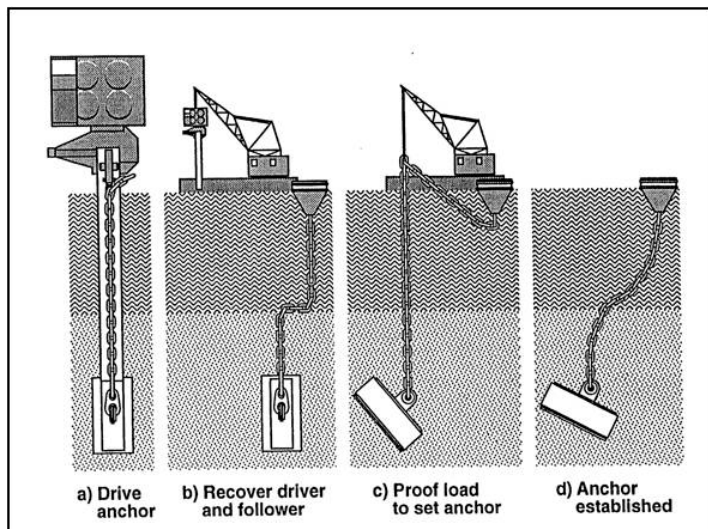

OMNIMAX Gravity Anchor

Manufacturer

Delmar Systems Inc. TECHNICAL & ENGINEERING 2424 Wilcrest Dr., Ste 225 Houston, TX 77042 832.252.7100 Fax: 832.252.7140; <http://www.delmarus.com/site.php>

Features

- Gravity installed anchor
- Designed to accommodate all combinations of chain/wire/synthetic mooring lines.
- Adjustable fluke fins to adapt to different soil strengths.
- Removable fluke fins
- Omni-directional mooring attachment
- Manufacturer claim illustrated at right: “under extreme loading and uplift angle conditions the anchor will penetrate deeper into the soil to gain the needed capacity”.
- Performance data unavailable
- Likely not effective in hard bottoms
- ROV use required to complete installation

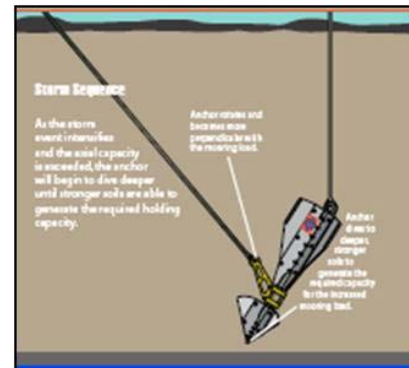

Example Final installation stages

- AHV finishes paying out and moving to proposed drop location and drop Height
- ROV verifies correct mooring arm orientation and drop height
- Acoustic release hook is triggered.
- ROV verifies anchor penetration depth.
- Mooring line is connected.

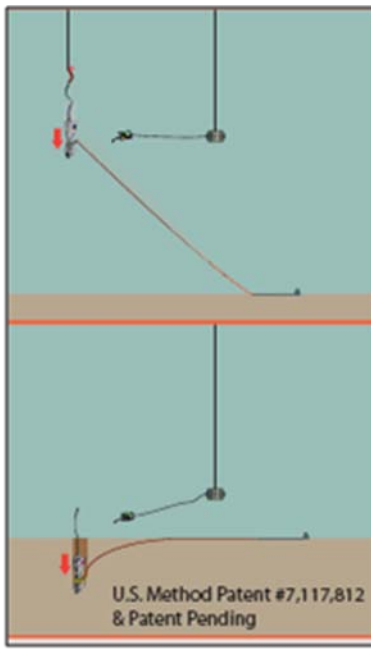

U.S. Method Patent #7,117,812 & Patent Pending

BRUCE DENNLA MK4 - Deep Embedment Near-Normal Anchor

Manufacturer

Bruce Anchor Limited, Anchor House, Cronkbourne, Douglas, Isle of Man, IM4, British Isles
 Phone: 44-1624-629203, Fax: 44-1624-62227, web: www.bruceanchor.co.uk

Features

- Installed similar to drag anchor
- Can be installed as near-normal or conventional drag anchor
- Triggered to release shank to near normal load of 78 deg: shank position C below
- Fluke angle fixed at 36 deg when used in sand and stiff clay soils
- Operational capacity several times drag-in capacity in mud
- Uplift resistant
- 95% of vertical load anchor capacity at depth
- Configured to continue to embed or remain at depth if dragged
- Recovery at low load by mooring line at right with shank position D below

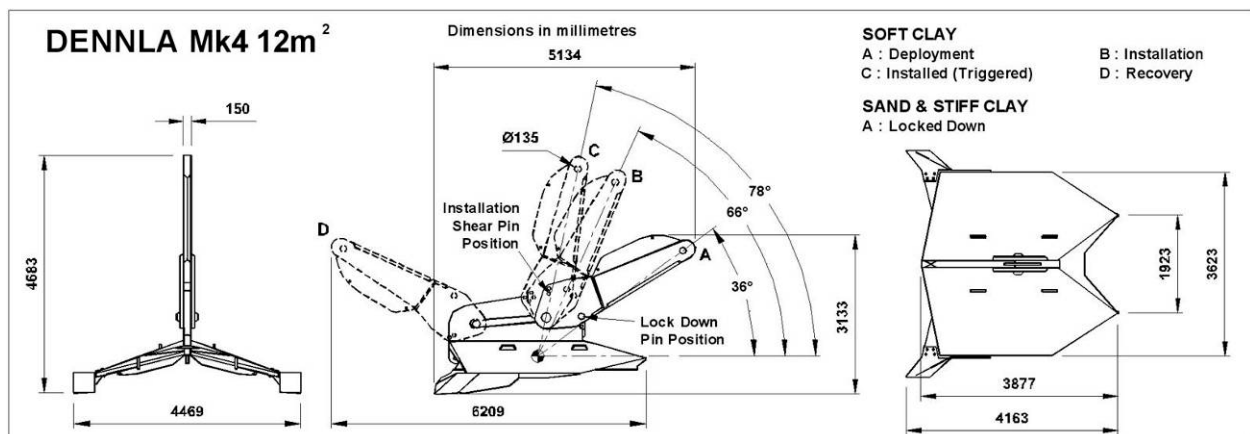
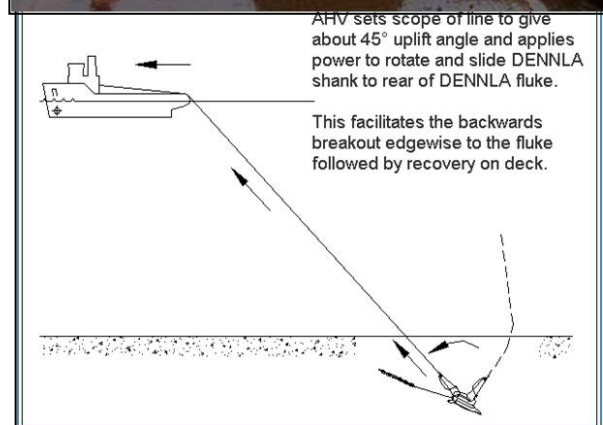
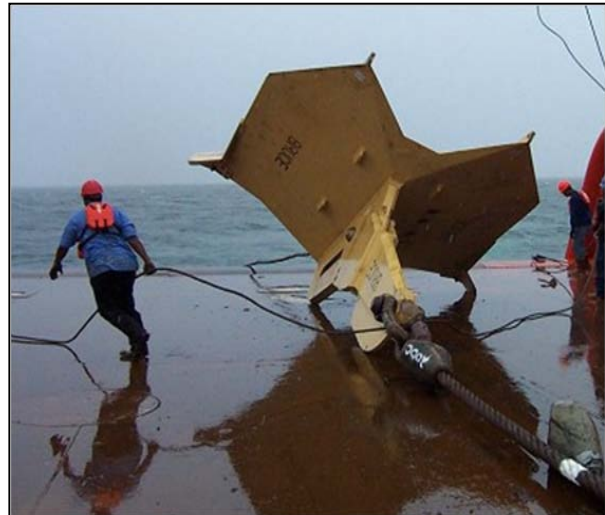

BRUCE® PENNLA - Pile Embedment Near-Normal Load Anchor

Manufacturer

Bruce Anchor Limited, Anchor House, Cronkbourne, Douglas, Isle of Man, IM4, British Isles

Phone: 44-1624-629203, Fax: 44-1624-62227, web: www.bruceanchor.co.uk

Features

- Plate penetrated by self weight into seabed
- Simple plate construction
- Primary use in soft soil
- High holding capacity independent of load angle
- Does not lose penetration depth on keying (rotating to purchase position)
- Plates are self-lubricating to promote deeper penetration
- Precise positioning possible
- Plate designed similar to DENNLA and should perform similarly once installed
- The gravity pile consists of a stack of plug-together modules; each module weighs less than 25 tonnes and is less than 6m long for ease of transport and assembly on an AHV deck. Modular for easy transport
- Anchor system has not been deployed commercially but it is based upon established plate anchor technology

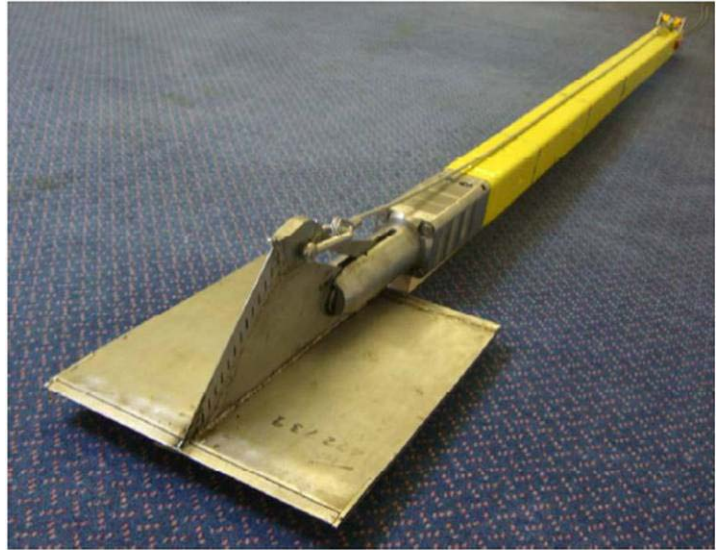

1/10th scale model of 12m² Pennla and 120mT lubricating modular pile

VRYHOF STEVMANTA Drag-In Anchor

Manufacturer

VRYHOF ANCHORS BV, P.O. Box 109, 2900 AC Capelle a/d Yssel, Netherlands

Phone: +31 10 266 8900, Fax: +31 10 266 8999; <http://www.vryhof.com/>

Features

- Installed similar to drag anchor
- Triggered to release shank to 90 deg normal load
- Operational capacity several times drag-in capacity in mud
- Suited to soft soil
- Performance in sand, hard and layered soil unknown
- Uplift resistant
- Recovery at low load by mooring line
- Configurations for permanent and temporary mooring applications: wire for permanent applications to enable deep burial and chain for temporary applications

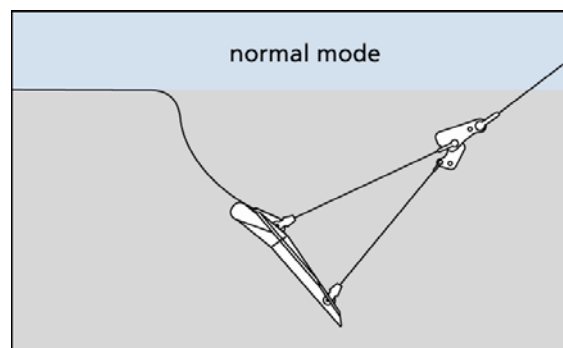
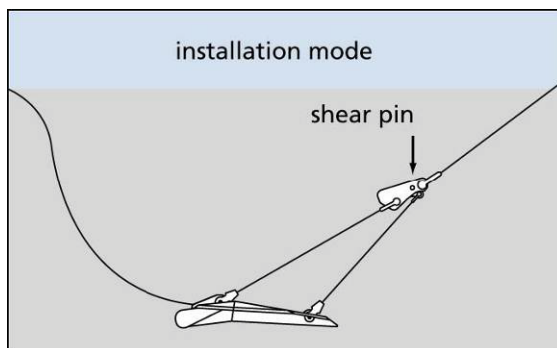
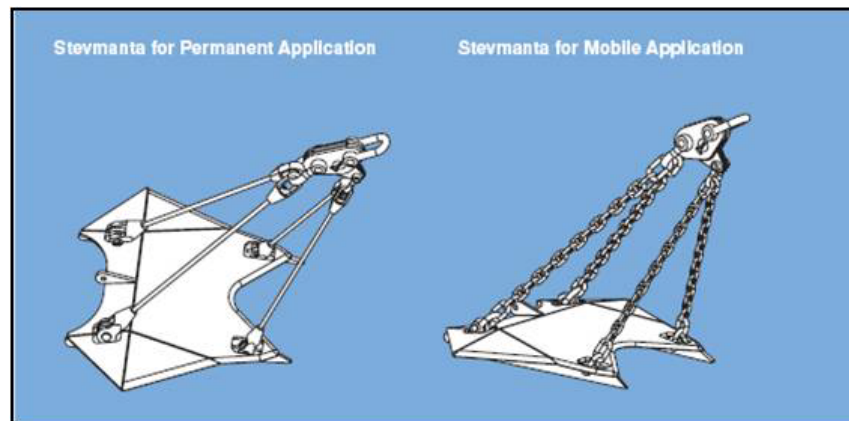

3.3 Buoys

Surface and/or subsurface buoys may be required as an element of a WEC mooring system. Surface buoys come in a variety of shapes, materials and construction. Figure 25 shows a common buoy type in two sizes used by the US Navy for Fleet Moorings, and Figures 26 and 27 show commercially available closed-cell foam buoys. Both the Navy and commercial buoys shown have a polyurethane skin, are filled with closed-cell foam and have a tension bar to transmit mooring loads. The use of foam-filled buoys has gradually replaced steel buoys even though they are more expensive because they require little maintenance and they are self-fendering. Low maintenance is an important consideration in the selection of any WEC mooring component.

Additional sources of information and products are provided in section 3.5.

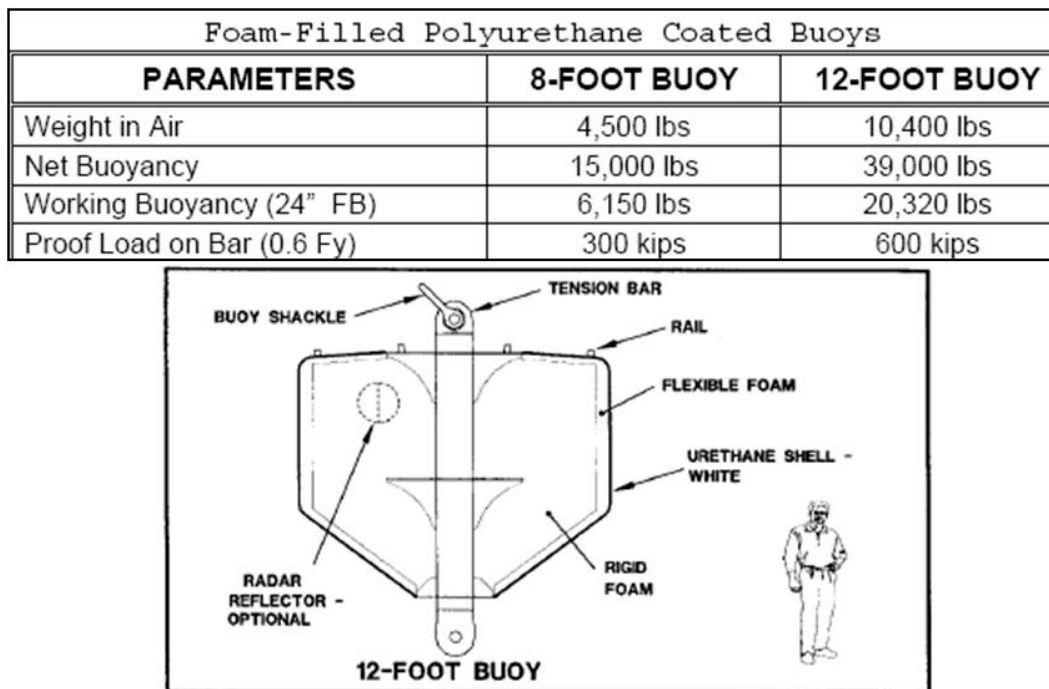

Figure 25 Example US Navy Fleet Mooring Buoy (MIL-HDBK-1026/4A)



Figure 26 Trelleborg Mooring Buoys

http://www.trelleborg.com/upload/TCL_TCI/docs/Trelleborg_Offshore_marine%20products.pdf

MARINE FENDERS INTERNATIONAL, INC.

- Ultra heavy duty central steel core load distribution construction
- US Coast Guard approved inner closed cell rigid urethane buoyancy foam



- Impact absorbing, resilient heat laminated cross-linked polyethylene foam core foam
- Thick, tough filament nylon tire cord reinforced urethane skin

OCEAN GUARD MOORING BUOYS												
BUOY MODEL	BUOYANCY NET		BUOY WEIGHT		DIAMETER OVERALL		HEIGHT BUOY BODY		HEIGHT OVERALL		WORKING LOAD	
	LBS	KG	LBS	KG	FT	M	FT	M	FT	M	LBS	TONS
MB-5	5,000	2,268	1,900	862	6.1	1.9	4.2	1.3	7.6	2.3	100,000	45
MB-8	8,000	3,629	2,650	1,202	7.0	2.1	5.0	1.5	8.6	2.6	150,000	68
MB-11	11,000	4,990	3,400	1,542	8.1	2.5	5.0	1.5	8.6	2.6	150,000	68
MB-15	15,000	6,804	4,100	1,860	9	2.7	5.0	1.5	8.6	2.6	200,000	91
MB-20	20,000	9,072	5,100	2,313	9.8	3.0	5.5	1.7	9.0	2.7	200,000	91
MB-25	25,000	11,340	5,395	2,447	10.1	3.1	6.0	1.8	9.5	2.9	200,000	91
MB-30	30,000	13,608	6,500	2,948	10.6	3.2	6.5	2.0	10.0	3.0	300,000	136
MB-35	35,000	15,876	7,500	3,402	11.1	3.4	6.8	2.1	10.4	3.2	300,000	136
MB-40	40,000	18,144	7,850	3,561	11.8	3.6	6.8	2.1	10.4	3.2	300,000	136
MB-50	50,000	22,680	8,700	3,946	12.0	3.7	8.1	2.5	11.6	3.5	300,000	136
MB-55	55,000	24,948	9,246	4,194	12.5	3.8	8.2	2.5	11.7	3.6	300,000	136
MB-60	60,000	27,216	10,200	4,627	13.0	4.0	8.5	2.6	12.4	3.8	300,000	136
MB-75	75,000	34,020	12,100	5,489	13.2	4.0	9.3	2.8	13.5	4.1	300,000	136
MB-100	100,000	45,380	17,000	7,711	13.5	4.1	12.8	3.9	16.8	5.1	300,000	136

* ACTUAL VALUES FOR ABOVE SIZES MAY VARY +/- 15% DUE TO VARIATIONS IN MATERIALS, TEMPERATURES AND TOLERANCES.

<http://www.marinefendersintl.com/properties/MOORING%20BUOYS%20NEW.pdf>

Figure 27 Marine Fender Mooring Buoys

Subsurface buoys can be used in a WEC mooring leg to add compliance in the system and to reduce the vertical load component on the WEC device. They are often constructed of steel because closed cell foam is depth limited and syntactic foam is expensive. Various manufacturers suggest depth limits for closed-cell foam to as much as 80m but that needs to be verified for long term applications.

Fabrication of a subsurface steel buoy requires an experienced metal fabricator with expertise in manufacturing specialty marine products. The buoy shown in Figure 28 was fabricated by Oregon Iron Works, Inc. (OIW) from Clakamas, OR. OIW is involved in renewable ocean energy and provides an excellent Oregon resource for many of the WEC device fabrication needs.



Figure 28 Steel Buoy www.oregoniron.com

Surface buoy systems are easier to install and to maintain but they introduce an additional surface hazard that must be considered.

Distributed subsurface buoyancy, as shown in Figure 29, normally is required to support and to protect the cable from the WEC device to a subsea junction box or to other locations. The “S” shape of the cable created by the distributed buoyancy can vary but must be adequate to allow the WEC to move throughout its entire range of motion during extreme sea conditions. Typically a multi-leg mooring is required to prevent WEC rotation leading to cable twisting and failure.

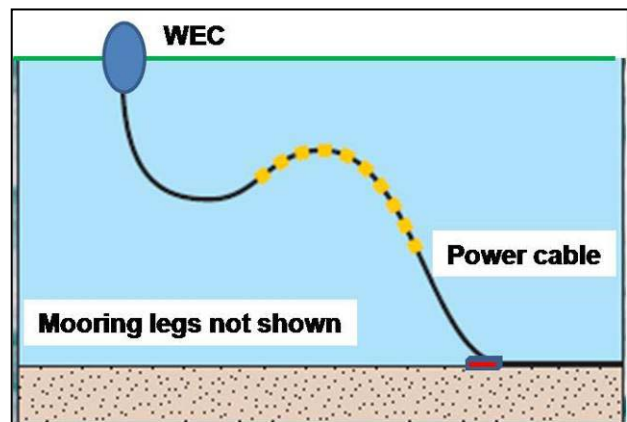

Figure 29 Distributed Cable Buoyancy

3.4 Mooring Lines and Connecting Hardware

Mooring lines may be grouped into three main types;

- Chains
- Steel Wire Ropes
- Synthetic Ropes

In the following sections these three types are considered in isolation. However, an anchor system may use a hybrid mixture of the three types. For example an idealized deep water catenary line may consist of:

- A chain section on the seabed floor providing deadweight, friction and high abrasion resistance
- A synthetic section starting just clear of the seabed floor providing reduction of weight and providing elasticity
- A steel wire rope section starting just above the sea surface and providing high abrasion resistance

3.4.1 Chain

Chain has broad use experience in offshore mooring systems, is durable, easy to inspect and terminate and is cost effective. However, it is heavy and depth limited due to its effective loss in working strength with depth and can be difficult to deploy safely. Its abrasion resistance and the catenary effects from weight are important and beneficial considerations in the mooring design.

Table 12 Anchor and Mooring Chains

链径 Diameter Of Chain	ANCHOR CHAIN						OFFSHORE MOORING CHAIN								
	ABS,BV,CCS,CR,DNV,GL, KR,LR,NK,RINA,RMRS				API		ABS	DNV ABS	ABS/DNV	ABS/DNV			ABS/DNV		
	Grade 2		Grade 3		ORQ		C/E/E	DE/EL/SL	C/E/E/SL	C/E/E	SL	C/E/E/SL	C/E/E	SL	C/E/E/SL
	RQ3		NVR3/RQ3		NVR3/RQ3		RQ3S/NVR3S			RQ4/NVR4					
	PL C=1422	BL C=1991	PL C=1991	BL C=2844	PL C=2030.5	BL C=3060.3	PL C=2147	PL C=2265.2	BL C=3236	PL C=2610	PL C=2527	BL C=3610	PL C=3125	PL C=2783.9	BL C=3977
inch	lbf	lbf	lbf	lbf	lbf	lbf	lbf	lbf	lbf	lbf	lbf	lbf	lbf	lbf	lbf
2 3/8	314000	440000	440000	628000	448672	676222	474414	500532	715046	576721	558381	797687	690519	615147	878782
2 7/16	330000	462000	462000	660000	471064	709972	498092	525514	750733	605505	586250	837499	724982	645849	922641
2 1/2	346000	484000	484000	692000	493920	744418	522258	551010	787158	634883	614693	878133	760157	677184	967406
2 9/16	363000	507000	507000	726000	517231	779553	546907	577016	824309	664847	643705	919578	796034	709145	1013064
2 5/8	379000	530000	530000	758000	540993	815385	572032	603524	862177	695390	673276	961823	832603	741723	1059604
2 11/16	396000	554000	554000	792000	565198	851847	597626	630528	900754	726504	703401	1004858	869657	774910	1107014
2 3/4	413000	578000	578000	826000	589842	888989	623684	658020	940029	758181	734071	1048672	907784	808698	1155282

Waterman Supply Company <http://www.watermansupply.com/chains/waterman-chain-studlinkoffshore.html>

Chain is available in a range of types, sizes and grades. These grades are associated with different strength and durability characteristics of the steel. Table 12 presents Proof Load (PL) and Break Load (BL) data for a broad range of available stud link chain grades. A small range of sizes was extracted to illustrate the large range of chain grades available. Sizes range from 3/4 to over six inches. Note that there is greater than a factor of two strength difference from Grade 2 and RQ4 chain. The remaining data can be found at the web site provided in the table and at other sites noted at the end of the section.

Typical hardware used with chain is shown in Figure 30. The strength of the hardware element must equal or exceed the strength of the highest grade of chain under consideration.

According to DNV-OS-E301 (Position Mooring): “Typically connection elements such as Kenter shackles, ordinary D-shackles and C-links are not permitted in long term mooring systems due to their poor fatigue qualities. Fatigue life cannot be calculated due to lack of fatigue data for these connection elements, with exception of Kenter shackles. API RP 2SK contains information sufficient for estimation of

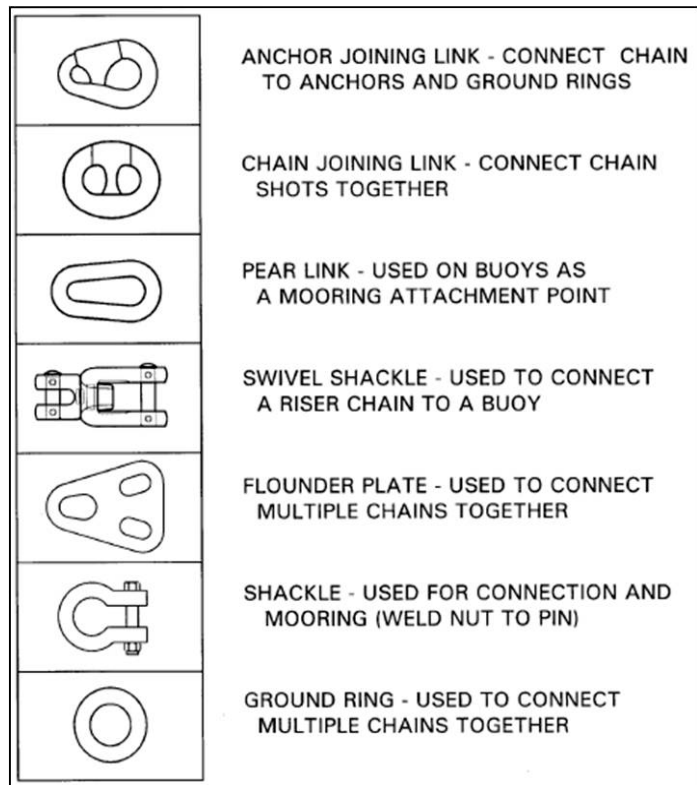

Figure 30 Chain Connecting Elements

fatigue life for Kenter shackles. It further states that: “Swivels are not permitted in long term mooring systems if they are not qualified with respect to functionality, structural strength and fatigue.” Requirements concerning materials, manufacture, testing, dimensions and tolerances, and other relevant requirements for anchor chain cables and accessories are given in DNV-OS-E302 (Offshore Mooring Chain).

Clearly, there needs to be a discussion and resolution on the types of connecting elements that are appropriate to WEC device moorings because the DNV requirements were established for manned structures and not specifically for unmanned WEC devices.

3.4.2 Wire Rope

Wire rope is available in many constructions, materials and strengths to satisfy a multitude of applications. It is designed to withstand tensile loading, abrasion, bending fatigue, crushing and corrosion. The rope finish can be bright or galvanized for added protection in the marine environment. Wire ropes are identified primarily by the type of construction, i.e., number of strands in the rope and the number of wires in each strand. However, there is some flexibility in the classifications. For example a 6x7 wire rope has six strands with up to eight wires per strand and a 6x37 wire has six strands with anywhere from 27 to 49 wires.

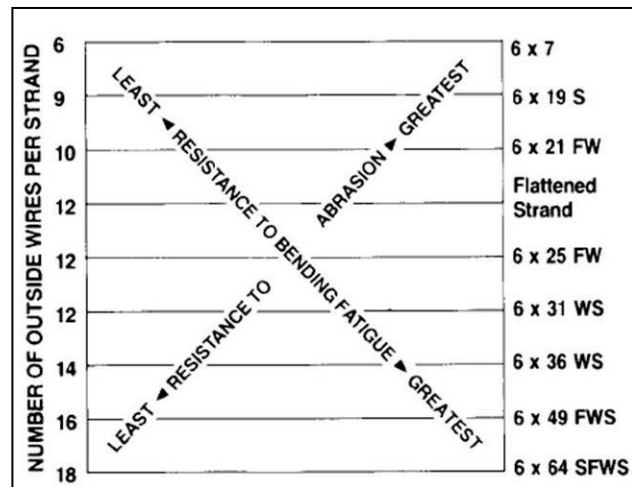

Figure 31 “X” Chart: Wire Rope Bending and Fatigue

Often two factors govern the selection of a wire rope: bending resistance and fatigue. The wire rope industry provides a useful chart (Figure 31) to illustrate the effect of wire construction on bending and fatigue. The mid-point on the chart where the lines cross provides a reasonable balance between bending and fatigue.

There are cable designs specifically created to minimize spin during load handling. They are referred to as spin-resistant and torque-balanced wire ropes. The following discussion is limited to torque-balanced wire rope because it offers unique advantages for oceanographic applications.

Torque-balanced rope typically comes in 3x19 and 3x46 constructions (Table 13). According to the chart the 3x19 construction will provide more abrasion and less bending resistance than the 3x46 wire construction.

The elastic limit of Torque-Balanced wire rope is 75% of normal rope breaking load; this compares to approximately 50% for 6-strand ropes. The importance is that the payload of a Torque-Balanced wire rope, at the elastic limit, is 50% greater than that of an equal strength 6-strand rope with no difference in diameter. Additionally, since a Torque-Balanced wire rope weighs less (about 10%) than a conventional 6-strand rope of the same size and strength, it has a much higher strength to weight ratio. At loads approaching the elastic limit—75% of rope breaking load—tests show rotation to be less than 1° per foot of rope length. Even when there is

a sudden release of load, Torque-Balanced wire ropes will not kink or form loops and hockles, as in conventional 6-strand wire ropes.

The selection of rope for a particular application typically requires compromise and engineering judgment. An application engineer from a cable supplier or manufacturer is often the best individual to discuss your needs and to make a selection because there are a daunting number of wire rope options available.

Table 13 Torque-balanced Wire Rope for Oceanographic Applications

Size Inches	Construction	Weight in Air Lbs/Ft	Approx. Elastic Limit Lbs	Minimum Breaking Force Lbs	0.2% Yield Strength Lbs	Maximum Length Feet
3/16	3x19 Seale	.0586	3,000	4,000	3,500	50,000
1/4	3x19 Seale	.0997	5,036	6,750	5,900	45,000
5/16	3x19 Seale	.153	7,725	10,300	9,100	30,000
3/8	3x19 Seale	.220	11,100	14,800	13,000	50,000
7/16	3x19 Seale	.304	15,000	20,000	17,600	42,000
1/2	3x19 Seale	.392	19,275	25,700	22,600	98,000
9/16	3x19 Seale	.492	24,375	32,500	28,600	77,000
5/8	3x19 Seale	.602	30,225	40,300	35,500	62,000
3/4	3x19 Seale	.879	43,350	57,800	50,900	43,000
7/8	3x19 Seale	1.21	58,500	78,000	68,600	32,000
1	3x19 Seale	1.56	75,450	100,600	88,500	24,000
1-1/8	3x19 Seale	1.96	93,000	124,000	109,000	19,000
1/2	3x41 Seale FW	.417	19,275	25,700	22,600	98,000
9/16	3x41 Seale FW	.517	24,375	32,500	28,600	77,000
5/8	3x41 Seale FW	.631	30,225	40,300	35,500	62,000
3/4	3x46 Seale FW	.903	43,350	57,800	50,900	43,000
7/8	3x46 Seale FW	1.27	58,500	78,000	68,600	32,000
1	3x46 Seale FW	1.64	75,450	100,600	88,500	24,000
1-1/8	3x46 Seale FW	2.07	93,000	124,000	109,000	19,000
1-1/4	3x46 Seale FW	2.60	118,500	158,000	139,000	15,500
1-3/8	3x46 Seale FW	3.10	141,000	188,000	165,000	12,900
1-1/2	3x46 Seale FW	3.69	166,500	222,000	195,000	10,800

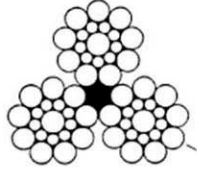

3x19

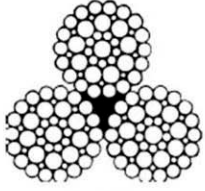

3x46

http://www.macwhyte.com/Resource/_RopeProduct/2076/TorqueBal.pdf

Wire rope terminations and connecting hardware are available at many marine supply companies and many provide on-line or downloadable catalogues (see Section 3.4.4). Optional terminations include spliced eyes, sockets or swaged fittings. The strength of the termination must equal or exceed the maximum wire strength. Several are provided at the end of this section.

3.4.3 Synthetic Rope

The wide spread use of synthetic ropes within the maritime sector is a relatively modern occurrence. From the 1970's as oil exploration moved into increasingly deeper water depths, conventional mooring systems using steel wire ropes and chains have become significantly more difficult and expensive to install. Traditional all-chain catenary moorings approach the limit of their capability at a depth of about 1500 ft. Combined chain/wire-rope systems remain effective to about double this depth before the weight of the mooring begins to sag excessively, and performance and station keeping deteriorate. These water depths are far greater than any proposed for WEC devices but the need to identify more cost effective mooring options for deep water drilling has driven the innovation in synthetic ropes and has caused Classification societies and Regulatory agencies to develop various guides and specifications on the use and testing of synthetic ropes. These include:

- American Petroleum Institute Recommended Practice for Synthetic Mooring (API RP 2 SM) (2001)
- ABS, “Guidance Notes on the Application of Synthetic Ropes for Offshore Mooring”, March 1999 Website for guidance notes:
[http://www.eagle.org/eagleExternalPortalWEB/ShowProperty/BEA%20Repository/Rules &Guides/Current/90_ApplSyntheticRopesforOffshoreMooring/Pub90_SyntheticRopes](http://www.eagle.org/eagleExternalPortalWEB/ShowProperty/BEA%20Repository/Rules&Guides/Current/90_ApplSyntheticRopesforOffshoreMooring/Pub90_SyntheticRopes)
- DNV-OS-E303 Offshore Mooring Fibre Ropes

The ABS guide is particularly useful and is available on line at the website provided with the above reference. The Guidance Notes describe criteria for the design, materials, testing, manufacturing, installation and recovery of synthetic ropes used as components in offshore mooring systems. The Notes also highlight differences with typical steel mooring systems and provide guidance on how to handle these differences during system design and installation; it also discusses terminations. Since rope properties influence mooring system performance, the Notes include details on how testing, mooring analysis and installation can be integrated to provide a consistent design methodology. The ABS Guidance notes include the following aspects:

- Design and Analysis Considerations of Mooring Systems
- Design Criteria for Mooring Components
- Design of Synthetic Rope
- Testing and Production of Yarn and Rope
- Inspection and Certification during and after Rope Production
- Installation, Hook-up and Commissioning Survey
- Post-Installation/In-Service Survey

Synthetic ropes have several advantages over steel wire rope, particularly in deep water mooring systems due to weight savings and in shallow water moorings where mooring compliance is important to controlling dynamic loads. Reasons for selecting a synthetic rope solution may include factors such as, high strength to weight ratios, near neutral buoyancy, high elasticity, corrosion resistance or cost. Synthetic ropes do not require coating or cathodic protection. However synthetic ropes have relatively poor abrasion characteristics when compared to chain or steel wire and thus must not be used in situations where they can contact the seafloor.

Typical synthetic ropes materials are Polypropylene, Aramid, Nylon High Modulus Polyethylene (HMPE) and Polyester ropes. Each is described; however, the focus of this section is on Polyester ropes.

3.4.3.1 Polypropylene

Polypropylene rope has approximately the same elasticity as Polyester rope but is significantly weaker than either Polyester or Nylon. It has a low melting point and a tendency to fuse under friction. Also prolonged exposure to UV causes degradation issues. However Polypropylene is lighter than water and can be used to float ‘Messenger’ lines. Other than this application Polypropylene has little structural application in the maritime sector.

3.4.3.2 Nylon

Dry Nylon rope exhibits slightly better strength to weight ratios than Polyester. However its performance when wet reduces such that when fully saturated, Nylon and Polyester have equivalent strength properties. Furthermore wet Nylon losses strength much faster than Polyester when subject to cyclic loading. Nylon has the greatest elasticity of all the synthetic ropes. Even after being pre-stretched (broken in), it will stretch 12% or more at 50% of its Minimum Breaking Load (MBL). This characteristic makes it particularly well suited to situations where some degree of elasticity is advantageous. Conversely where a very rigid mooring is required the use of Nylon is less advantageous. A common trade name for Nylon is Polyamide.

3.4.3.3 Aramid

Aramid ropes provide high strength, low weight, low stretch, easy handling and corrosion resistance. On a weight basis, Aramid ropes are up to five times stronger than steel ropes and achieve an elasticity of about 3% elongation at 50% MBL. Besides its relatively high cost, the application of Aramid has a number of other drawbacks. Aramid fibers are susceptible to degradation due to UV and mechanical wear. This results in the need to sheath this material with an outer core. A common trade name for Aramid is Kevlar. New high-strength synthetic ropes constructed of Aramid fiber (para-bonded aromatic polyamide) are being developed for ultra-deepwater mooring applications.

3.4.3.4 High Modulus Polyethylene

Since High Modulus Polyethylene (HMPE) ropes were first introduced into the market, their usage has become widespread in many applications including mooring and towing where HMPE ropes have acted as a replacement to traditional wire ropes. Safety and long term cost savings are the primary reasons driving this decision. Reductions in maintenance, environmental costs, and increased handling safety make HMPE a worthwhile investment despite the higher initial cost. A common name for HMPE is Dyneema.

3.4.3.5 Polyester

Polyester is the most durable of all the common fiber materials. It maintains high strength when both dry and wet and it exhibits vastly superior maintenance of strength when subjected to cyclic loading as compared with Nylon and Polypropylene. On an equal strength comparison, Polyester rope tends to offer the most attractive alternative to chain and steel wire due to its lighter weight and high elongation to strength properties. Common trade names for Polyester include 'Dacron' and 'Terylene'.

Polyester and other fiber ropes were studied for deepwater moorings in several Joint Industry projects (JIP) in the early 1990s. These studies provided vital information and answered many critical questions. They showed that polyester rope has desirable stretch characteristics and very good durability for use as mooring lines. Data is now available for as many as 40 million load cycles and for wide tension ranges. These data indicate that polyester rope will not lose

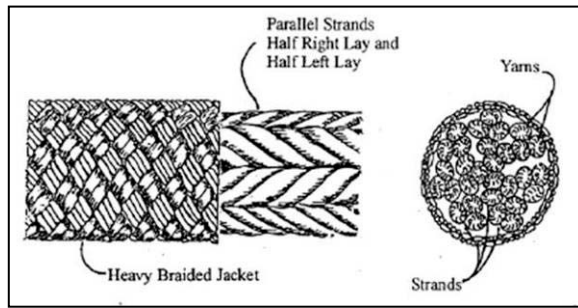

Figure 32 Parallel Subrope Construction (DNV-OS-E303)

significant strength even after hundreds of years cycling at the tensions and over the tension ranges typical of deepwater mooring applications. This is much longer than the potential fatigue lives of either wire rope or chain in sea water.

The most common type of polyester fiber rope for offshore moorings consists of parallel subropes held together by a braided jacket with a filtration barrier to prevent soil intrusion (Figure 32). The subropes consist of strands in helical (laid) or braided arrangement. The helical subropes typically use three or four strands, whereas the braided subropes typically use eight or twelve strands. The size and number of subropes to make up the fiber rope varies between manufacturers. Figure 33 provides data for Polyester Tethers from Samson Rope.

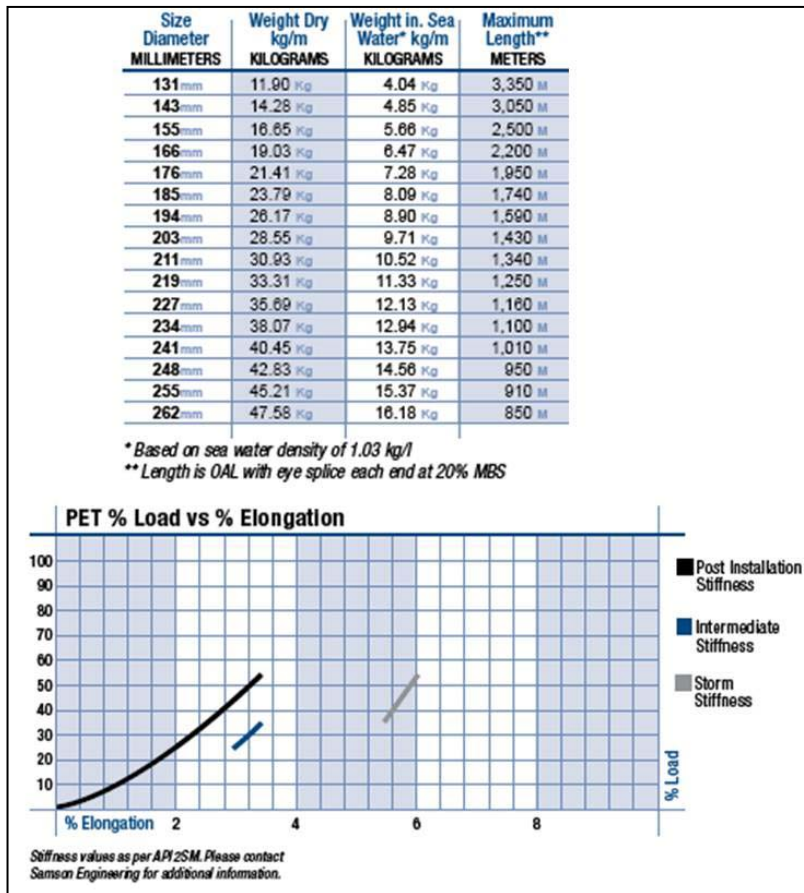

Figure 33 Samson Rope Polyester Tether Properties
 (www.samsonrope.com)

Bridon International also provides Polyester lines with the parallel subrope construction. Figure 34 provides the load-deflection characteristics of their Superline both in a new and a worked condition. Note that the Superline is about half as stiff as the Samson tether shown above. Each manufacturer may have alternate tether constructions that would achieve different load-deflection behavior so it will be important to speak to an application engineer before selecting a product.



Figure 34 *Bridon Superline Polyester Tether*
(www.Bridon.com)

The force-deflection behavior of polyester is essentially linear, although it can vary during the life of the product as shown in the figures. This load-deflection behavior is advantageous in designing a mooring for shallow water applications where the WEC has a large motion response. Mooring compliance is important to controlling load and the consequent effects on mooring component size and cost.

DNV-OS-E303 stipulates that “fiber ropes shall be terminated with spliced eyes and that termination hardware is required to fit and support the eye and should be made of steel. The spliced eyes should be fitted on thimbles. The strength, ductility and toughness of the termination hardware should be such that it can withstand the actual breaking strength of the rope assembly.”

3.5 Sources of Mooring Hardware (e.g., anchors, chain, connectors, wire, synthetic rope, buoys)

- **Anchor Marine and Industrial Supply:**
<http://www.anchormarinehouston.com/>
- **Baldt Anchor and Chain:**
<http://www.baldt.com/>
- **Bethlehem wire rope catalogue:**
http://www.wireropeworks.com/product_pdfs/structural.pdf
- **Bridon International Ltd:**
<http://www.bridon.com.sg/downloads/oilgas-new.pdf>
<http://www.bridon.com/live/brochures/Fibre.pdf#page=1>
- **Cordage Institute Tech manual:**
<http://www.ropecord.com/cordage/publications/CI2001.pdf>
- **Directory of wire rope and termination suppliers:**
<http://www.iqsdirectory.com/wire-rope/?source=google&gclid=CLTo3IC2iJ4CFRgbawodiDZ2oQ>

- **Gilman Corporation:**
http://www.gilmancorp.com/Mooring_.html (buoys)
<http://www.mooringsystems.com/default.htm>
- **Lankhorst Ropes:**
<http://www.lankhorstropes.com/>
- **Lister Chain and Forge Inc:**
<http://www.listerchain.com/>
- **Miami Cordage:**
<http://www.imakerope.com/>
- **Oregon Iron Works:** marine fabricator
<http://www.oregoniron.com>
- **Marine Fenders International:** (buoys)
<http://www.marinefendersintl.com/>
- **Pacific Wire Rope Ltd.:**
http://www.pacificwirerope.com/web_Pages/PWR_OnlineCatalog_page.htm
- **Samson Cordage:**
<http://www.samsonrope.com>
- **Southwest Wire Rope catalogue:**
<http://www.southwestwirerope.com/pdf/cp05.pdf>
- **Telleborg Offshore:** – Buoys, subsea buoyancy products and subsea distributed brochures
<http://www.trelleborg.com/en/offshore/Products-and-Solutions/Subsea/>
http://www.trelleborg.com/upload/TCL_TCI/docs/Trelleborg_Offshore_marine%20products.pdf
- **The Crosby Group:**
<http://www.thecrosbygroup.com/html/default.htm>
- **USS Tiger Brand Wire Rope Engineering handbook:**
<http://www.tramway.net/PDF/Tiger%20Rope.pdf>
- **Washington Chain and Supply:**
<http://www.wachain.com/>
- **Waterman Supply Company:**
<http://www.watermansupply.com/index.html>
- **WireCoWorld Group:**
http://www.macwhyte.com/Resource_/RopeProduct/2076/TorqueBal.pdf

3.6 Mooring Configurations

3.6.1 Introduction

There exists a multitude of possible mooring configurations for WEC devices. The mooring can have single or multiple legs in various shapes and with various components; however, regardless of which mooring design is selected it must satisfy two main requirements. The mooring must survive the design environmental and other load conditions while maintaining station and do this in a cost-effective manner. A cost effective mooring design must be easy to install, maintain and decommission and this does not necessarily equate with the lowest cost components.

The following list shows a range of requirements that should be considered for WEC moorings systems:

- The mooring must maintain the WEC device on station during normal operating conditions and survive extreme storm conditions.
- The mooring system must be designed to accommodate tides.
- Mooring anchors must be designed to accommodate hazardous conditions such as seabed sediment movement, earthquake, cables and pipelines.
- All components must have adequate strength, fatigue life and durability for the operational lifetime. Corrosion must be considered and controlled in the design, and abrasion due to bottom contact or contact with other lines must be minimized or avoided if possible.
- The design life should be five times the anticipated operational life of the WEC device but not less than 50 years.
- The mooring must be designed to minimize environmental impacts on the seabed or native flora and fauna.
- The mooring systems should be designed to keep devices at optimum orientation relative to the waves.
- The mooring system must not allow twisting or over tensioning of the electrical transmission cable.
- The mooring system design should not adversely affect the performance of the WEC device.
- Single mooring legs must be capable of repair or replacement without affecting neighboring devices or necessitating removal of the WEC device.
- The mooring system must be designed with sufficient compliance to achieve a reasonable balance between anchor and mooring line loads and station keeping requirements.

3.6.2 Guidelines and Standards

There is considerable experience in the offshore industry with the design and installation of mooring systems for various offshore structures. Their design is controlled by rules, regulations and guidelines established by various regulatory authorities and the most stringent apply to the offshore oil and gas industry due to potential loss of life and the danger of environmental damage.

The Carbon Trust, established by the UK government, recognized that there were no specific codes of practice, standards, or guides to facilitate WEC design and development. In 2005 they commissioned DNV to develop a guideline “Guidelines for Design and Operation of Wave Energy Converters,” to provide interpretation and guidance on the application of the various existing standards and guides, such as offshore engineering, to wave energy conversion (WEC) devices. DNV notes that this guideline is not a standard and should be considered as a starting point for further standards work. The Guideline was developed to provide guidance, act as reference to principal relevant standards and highlight some major issues that developers or other stakeholders might wish to consider during development of WECs. Recently, DNV issued an Offshore Service Specification for Certification of Tidal and Wave Energy Converters (DNV-OSS-312). This document defines the requirements, philosophy, deliverables and the certification procedure.

Germanisher Lloyd also developed a guideline in 2005 that applies to the design, assessment and certification of ocean energy conversion systems and farms of ocean energy conversion systems. The first part of the Guideline applies solely for ocean current turbines (OCT) but has information relevant to the design of WEC devices. This guideline also is not intended to be a full design procedure and safety manual guideline due to the multiple engineering solutions possible, but to give some general guidance for the assessment of the safety of ocean current turbines.

The objective of these guidelines is to provide interpretation and guidance on the application of various proven standards and recommended practices for the development of wave energy projects (as well as tidal energy devices). The guidelines give a basis to introduce the aspects of integrating reliability, feasibility, and risk management into the design and operation of these systems.

WEC devices are not manned nor do they pose significant potential damage to the environment; thus, they could be designed to a lesser safety standard/higher risk level than manned systems. However, since WEC technology is in its infancy, this may not be a reasonable nor advisable design option. Failure of a WEC mooring system could easily damage the public perception of the concept and have a negative influence on future funding and continued support. Use of the more stringent mooring design rules and guides is recommended until there is a suitable body of knowledge and experience for mooring WEC devices to revise these procedures.

Until there is a fully vetted and ratified standard for WEC mooring design the following guides and standards should be considered:

- Germanisher Lloyd, Guideline for the Certification of Ocean Energy Converters Part 1: Ocean Current Turbines, 2005 (draft)
- DNV, Guideline on design and operation of wave energy converters 2005
- DNV-OSS-312, Offshore Service Specification Certification of Tidal and Wave Energy Converters, October 2008
- DNV-OS-E301 Offshore Standard Position Mooring, October 2008
- API RP 2SK Recommended Practice for Design and Analysis of Station-keeping Systems for Floating Structures, Nov 2005
- API RP 95F Interim Guidance for Gulf of Mexico MODU Mooring Practice - 2007 Hurricane Season, 2nd edition
- UK Department of Energy (DEn). ‘Offshore Installations: Guidance on Design, Construction and Certification’, 4th Edition, 1990.

3.6.3 Mooring Analysis and Design Risk

A detailed discussion and recommended approach for WEC mooring analysis techniques and requirements is beyond the scope of this report. The reader is directed to the Guidelines and Standards listed above for thorough descriptions of static and dynamic analysis requirements relevant to WEC mooring design. The Guides and Standards provide environmental site assessment recommendations and suggestions on combinations of environmental loadings where joint statistics are not known. DNV (Guideline on design and operation of wave energy converters 2005) notes that “for wave energy devices with a dynamic response to wave loading and/or novel mooring configuration, a complete time domain simulation combined with tank testing may be necessary”. This note applies to virtually all the wave activated body WEC devices described in Section 2.1.

The Germanisher Lloyd Guideline for Ocean Energy Converters does a thorough job of identifying load cases for operational, installation and survival analysis. DNV-OS-E301, Section 2.0 specifies a mooring analysis process for Position Mooring Systems (column-stabilized units, ship-shaped units, single point moorings, loading buoys and deep draught floaters (DDF) or other floating bodies relying on catenary mooring, semi-taut and taut leg mooring systems) that is relevant to WEC devices.

An evaluation of the various Guides and Standards shows that there is discretion in the design analysis techniques and safety factors employed for WEC moorings. The DNV and Germanisher Lloyd draft guidance for WECs both employ reliability-based design approaches, wherein the designer and user define an acceptable risk for the system. While this tends to be more difficult than prescriptive design methods, this technique provides more design flexibility with the potential for greater cost effectiveness, but it also requires a greater level of user expertise.

DNV-OS-E301 identifies the following categories for a risk assessment for any significant offshore development. These risks need to be considered throughout the entire life cycle: fabrication, installation, in-service and decommissioning.

- Anchor/foundation failure
- Mooring failure
- Breach of water integrity of compartments or equipment
- Stability failure
- Collision risks
- Interference with commercial and recreational marine activities
- Structural failure
- Fishing gear impact
- Personnel risks to operators and to the general public
- Pressure containment failure from hydraulic or pneumatic systems
- Electrical failures and shore connector failures
- Seismic events
- Fires
- Interference from floating debris with device

By analyzing the above failures, coupled with the engineering limits of the device, the consequences can be predicted. Factors of safety used to specify tensions for sizing anchors and mooring hardware will depend upon the consequence Class selected.

- Class 1, where mooring system failure is unlikely to lead to unacceptable consequences such as loss of life, collision with an adjacent platform, uncontrolled outflow of oil or gas, capsize or sinking.
- Class 2, where mooring system failure may well lead to unacceptable consequences of these types (*identified in Class 1 description above*).

Although the Class descriptions were originally defined for mooring oil and gas platforms they are relevant to WEC devices. Class 2 factors of safety are higher than Class 1 factors and will result in larger and more costly components so care must be exercised in determining your level of risk tolerance and the consequences associated with the failure of any WEC device. The Class descriptions do not include public perception, but that is an important consideration for the relatively infant WEC technology. Failure of a WEC mooring system could easily damage the public perception of the concept and have a negative influence on future funding and continued support. Erring on the side of caution and selecting Class 2 consequences likely is advisable until more experience is gained level with WEC devices.

Recommended Reading. The Specialist Committee V4 Ocean, Wind and Wave Energy Utilization was given the following mandate by the 17th International Ship and Offshore Structures Congress.

COMMITTEE MANDATE

“Concern for structural design of ocean energy utilization devices, such as offshore wind turbines, support structures and fixed or floating wave and tidal energy converters. Attention shall be given to the interaction between the load and the structural response and shall include due consideration of the stochastic nature of the waves, current and wind.”

The report⁷ discusses wind, waves and tidal energy devices and their design for operating and surviving in the ocean environment. The mandate describes the content of this report and it is recommended reading for anybody involved in the design and implementation of a WEC device. A daunting list of references is also provided in the report.

3.6.4 Mooring Configurations

Various **single point** and **spread** (multi-point) mooring configurations and **dynamic positioning** systems have been developed for station keeping/mooring ships and offshore platforms that may be applicable to WEC moorings.

3.6.4.1 Single Point Moorings

There are a variety of single point moorings evaluated by Harris⁸ for WEC suitability:

- Single gravity anchor, single leg
- Turret Mooring
- Catenary Anchor Leg Mooring (CALM)
- Single Anchor Leg Mooring (SALM)
- Articulated Loading Column (ALC)
- Reservoir (SPAR)
- Fixed Tower Mooring

Each of these single point moorings has a common trait: the mooring would allow the WEC device to weathervane around the connection point. This will require a large operational footprint and likely preclude use of this type of system when multiple WEC devices are employed in an energy farm. A single point mooring consisting of a single anchor and single leg provides no rotational control and no redundancy and will not be considered further.

Point Absorber-type WECs generally do not have to be oriented in a particular direction to operate; however, directional control may be required to protect the power cable from twisting. Also, the performance of Attenuator WECs like Pelamis and Anaconda is related to their principal axis being parallel or normal to the incoming wave crest. As noted earlier, single point moorings do not provide directional or rotational control.

⁷ 17th International Ship and Offshore Structures Congress, 16-21 AUGUST 2009, SEOUL, KOREA, VOLUME 2

⁸ Harris, et al, Mooring systems for wave energy converters: A review of design issues and choices
<http://www.oreg.ca/docs/MooringSystems.pdf>

Assuming that a means to protect the electrical transmission cable from twisting failure could be devised, certain single point mooring systems might be practical in areas where they are commonly employed and expertise is available. However, the cost of developing a means to protect the cable and employing the single point moorings off the Oregon coast where resources for installing these moorings are not available cost would be prohibitive at this stage of WEC development.

3.6.4.2 Dynamic Positioning

This includes computer controlled Active Mooring and Propulsion techniques. Active Mooring relies on servo-controlled winches to adjust mooring line lengths to maintain position and orientation while the Dynamic Positioning/Propulsion technique consists of positioning a floating structure relative to a target location. Both techniques are complicated, costly and would be high risk for a long term application.

3.6.4.3 Spread Moorings

This type of mooring configuration generally is applicable to the WEC devices being considered at the FERC sites. Spread moorings provide position, directional and rotational control and redundancy and employ common installation practices and equipment. General spread mooring categories include catenary, multi-catenary and semi-taut moorings. They are illustrated in Figure 35 and described in Table 14. Only two legs are shown for clarity but a minimum of three legs would be required for a Point Absorber WEC depicted in the figure. The mooring leg configurations and component options described below can be applied to any of the other floating WEC devices described in section 2.0.

Simple catenary moorings typically provide little compliance to mitigate mooring loads. Although the mooring legs are simple to install it is difficult to ensure that the mooring will remain under a reasonable pretension during operation. This can cause excessive WEC movement, slack mooring conditions, excessive line abrasion and interaction at the seafloor, and high loads that can be difficult to predict. Mooring stiffness can vary throughout the life of the WEC device and it will be difficult to account for the influence on WEC motion characteristics and energy production. Chain is the preferred material due to its superior abrasion resistance and weight. Nonetheless, it is obvious that a simple catenary leg mooring requires substantially more real estate than either multi-catenary or semi taut moorings.

Figure 35 provides two example multi-leg catenary options just to illustrate the myriad of component combinations that are possible. Although only a single buoy is shown for each leg option, multiple buoys might be employed to create the desired leg stiffness. Clearly, one leg configuration will not fit all WEC devices. The mooring leg on the left uses a subsurface buoy (that should be located sufficiently deep to ensure submergence during storms) and a chain (or wire, fiber) leg to a sinker and anchor. The sinker(s) shown are used to shorten scope and to ensure a near horizontal load at the seafloor interface if a drag anchor or enhanced deadweight anchor is used. Sinkers can be used to introduce additional mooring compliance but they are not required if uplift resistant anchors such as piles, plates or large deadweights (skirted) are used. The mooring leg could be chain, wire or fiber. The multi-catenary mooring leg on the right illustrates use of a surface buoy. Mooring line and anchor options are similar to those described

for the left mooring leg. Anchor options will be described later in the section but there are many possibilities for single anchors and combinations of anchors that may be acceptable depending on load magnitude, direction and seabed properties.

In areas of limited real estate or when multiple WECs are being installed in close proximity to create an energy farm for example, a multi-catenary type of mooring is the most practical option.

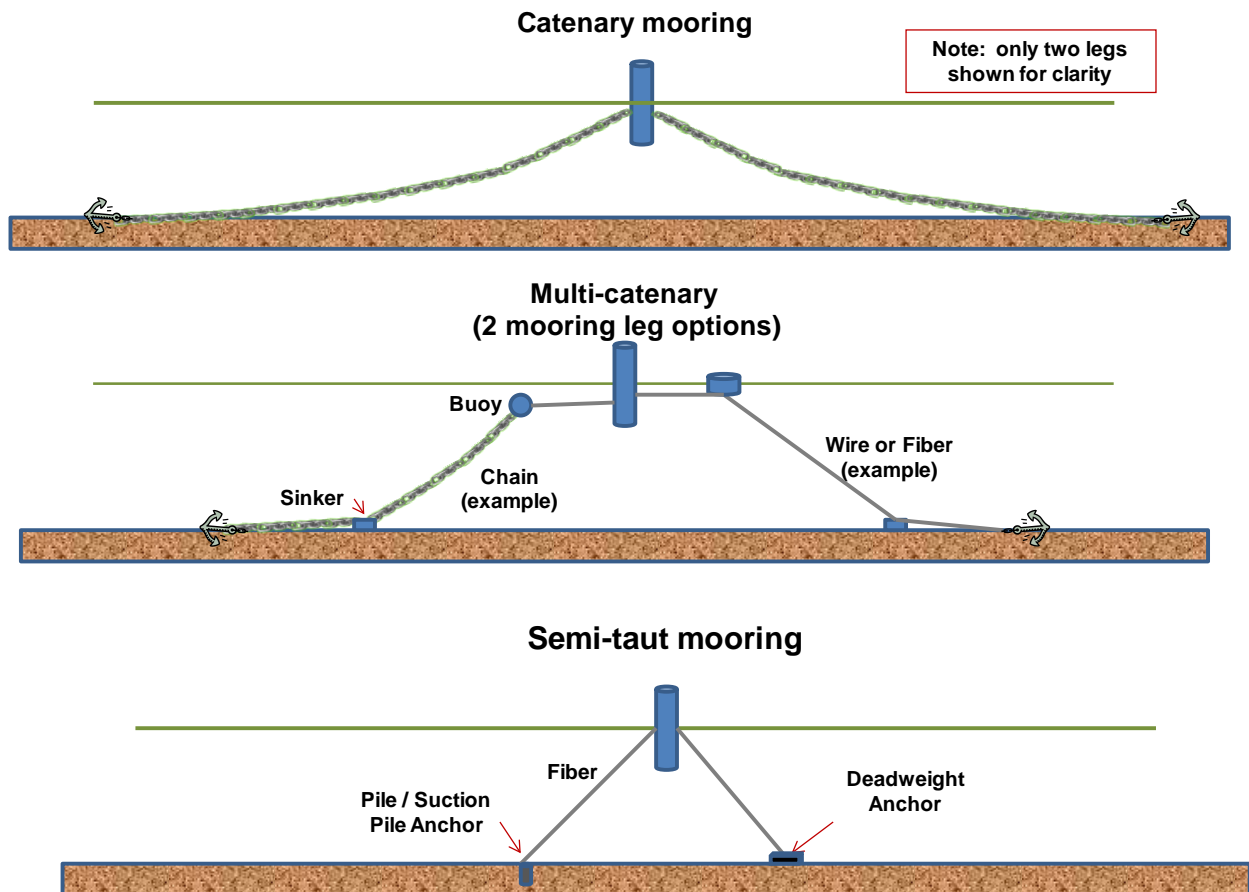

Figure 35 Spread Mooring Configuration Options

Semi-taut spread moorings require anchors capable of resisting large vertical and horizontal loads and this vertical load must also be resisted by the WEC. Large tides and waves in shallow water at probable FERC sites likely restrict the use of taut leg moorings. Installation and maintenance to repair or replace a mooring leg in a taut or semi-taut mooring system is complicated and must be done in very low sea conditions for safety. A taut leg mooring system is not a practical option for the systems proposed for the Oregon FERC sites.

Table 14 Characteristics of Possible WEC Spread Mooring Configurations

Type	Description	Characteristics
Catenary Mooring	Mooring lines hang directly from the WEC device or from an intermediate surface buoy and are of sufficient length/weight to create a near zero line angle at the seabed sufficient to enable proper functioning of a drag anchor.	<ul style="list-style-type: none"> • The horizontal restoring force comes from the weight of the mooring chain being lifted off the seafloor when loaded. • The footprint of this system is large. • Vertical load must be resisted by the WEC or by an intermediate surface buoy. • Simple to install but difficult to maintain pretension during life of the WEC. • Line contacts with the seabed can cause wear and may be environmentally unacceptable. • All anchor types can be considered depending primarily on seabed conditions only.
Multi-Catenary Mooring	Mooring lines can be comprised of various line types and include intermediate buoys and sinkers. Lines can arrive at various angles to the seabed.	<ul style="list-style-type: none"> • Intermediate surface and/or subsurface buoys can be used to limit vertical load at the WEC device. • Sinkers can be used to shorten mooring scope. • The horizontal restoring force can come from the weights of line and sinkers being lifted off the seafloor and subsurface buoys being pulled down. • Mooring footprint can be reduced by introducing buoys and sinkers to create a multi-catenary shape. • Steeper line angles at seabed contact are possible. • Anchoring becomes more complicated to the potential need for resisting uplift loading. • Mooring can be tuned to maximize WEC performance.
Semi-taut Spread Mooring	Mooring lines arrive at an angle to the seabed. Vertical lines similar to those used with a Tension Leg Platform (TLP) are not considered practical in shallow water.	<ul style="list-style-type: none"> • Restoring force comes primarily from the elasticity of the mooring line. • High stretch synthetic lines would be required to accommodate tides and waves. • Anchors would be required to resist large vertical and lateral loads. • Anchoring becomes very complicated due to the need to the anchor to resist large vertical and horizontal loads. • The WEC would have to resist large vertical loads. • Installation and maintenance of taut moorings is complicated and costly.

A single point mooring line connection is illustrated in Figure 35 but the location of the mooring line attachment point at the WEC and the connection method (single or bridle connection) can have a significant influence on WEC behavior, mooring loads and perhaps most importantly energy extraction performance.

It is not possible to suggest an optimal mooring configuration and connection method due to the multitude of WEC system types and performance characteristics and the general lack of long term operational data for this infant technology. Model, small scale and prototype testing coupled with theoretical analysis are required to understand WEC behavior and the influences of

the mooring system on performance. The understanding derived from this complete development process can be used to improve design practices and to establish guidelines and standards based on experience directly with WEC devices.

3.6.5 Mooring Line Characteristics

Table 15 summarizes mooring line characteristics to aid the reader during preliminary line selection. More details are provided in Section 3.4.

Table 15 Mooring Line Summary

MATERIAL	FEATURES	COMMENTS/ISSUES
Chain	<ul style="list-style-type: none"> • Broad use experience • Readily available 	<ul style="list-style-type: none"> • Unsuitable for water depths greater than about 1500ft • Susceptible to corrosion • Good abrasion resistance
Steel Wire Rope	<ul style="list-style-type: none"> • Broad use experience • Readily available 	<ul style="list-style-type: none"> • Unsuitable for water depths greater than about 3000ft • Susceptible to corrosion
Polyester	<ul style="list-style-type: none"> • High dry and wet strength • Moderate stretch • Frequent use in deep water taut moorings 	<ul style="list-style-type: none"> • Most durable of all fiber line materials • Moderate cost
Nylon	<ul style="list-style-type: none"> • High dry strength • High stretch 	<ul style="list-style-type: none"> • Wet strength about 80% that of dry • Low fatigue life • Moderate cost
Polypropylene & Polyethylene	<ul style="list-style-type: none"> • Low weight • Moderate stretch 	<ul style="list-style-type: none"> • Low strength • Low melting point • Susceptible to creep • Low cost
HMPE	<ul style="list-style-type: none"> • Low stretch • High strength to weight ratio 	<ul style="list-style-type: none"> • Replacing wire for towing – increased handling safety • High cost
Aramid	<ul style="list-style-type: none"> • Very low stretch • High strength to weight ratio 	<ul style="list-style-type: none"> • Minimum bending radius similar to steel wire rope • Low abrasion resistance • High cost

3.6.6 Anchor Characteristics

Table 16 summarizes the performance of the four anchor types described by Section 3.2.

Table 16 Anchor Characteristics Summary

Drag	Deadweight	Pile	Plate
<p>Advantages</p> <p>High capacity (> 100,000 lbs) possible. Broad range of types and sizes available. Standard, off-the-shelf equipment. Broad use experience. Continuous resistance can be provided even if maximum capacity is exceeded. Anchor is recoverable.</p> <p>Disadvantages</p> <p>Anchor cannot resist uplift; large line scopes are needed to cause near horizontal loading at seafloor. Does not function in hard seafloors. Behavior is erratic in layered seafloors. Penetrating/dragging anchor can damage pipelines, cables, etc.</p>	<p>Advantages</p> <p>Resists uplift, allowing short mooring line scope. No setting distance is required. Anchor is reliable because most holding force is due to anchor mass. Simple, on-site construction is feasible. Size is limited only by load-handling equipment. Economical if material is readily available. Reliable on thin sediment cover over rock. Mooring line connection is easy to inspect and service.</p> <p>Disadvantages</p> <p>Lateral load resistance is low compared to other anchor types. Usable water depth is reduced; deadweight can be an undesirable obstruction. Requires large-capacity load-handling equipment for placement.</p>	<p>Advantages</p> <p>High capacity (>100,000 lbs) possible. Resists uplift, allowing short mooring line scopes. Anchor setting is not required. Dragging is eliminated. Drilled and grouted piles are especially suited for hard coral or rock seafloors. Simple, on-site construction is feasible. Anchor does not protrude above seafloor. Driven piles are cost-competitive with other high-capacity anchors when driving equipment is available. Comes in a wide range of sizes and shapes, such as pipe and structural shapes. Field modifications permit piles to be tailored to suit particular requirements. Accurate anchor placement is possible. Can be driven into layered seafloor.</p> <p>Disadvantages</p> <p>Taut moorings may aggravate ship response to waves (low resilience).¹ Drilled and grouted installation is expensive and requires special skills and equipment. Costs increase rapidly in deep water or exposed locations where special installation vessels are required. Special equipment (pile extractor) is required to retrieve or refurbish the mooring. More extensive site data are required than for other anchor types. Pile-driving equipment must maintain position during installation.</p> <p>¹ True for any taut mooring</p>	<p>Advantages</p> <p>High capacity (> 100,000 lbs) is possible. Resists uplift, allowing short mooring line scopes. Dragging is eliminated. Has higher holding capacity-to-weight ratio than any other type. Easier handling due to relatively light weight. Can function on moderate slopes and hard seafloors.¹ Easier installation due to possible instant embedment on seafloor contact.¹ Accurate placement is possible. Anchor does not protrude above seafloor. Can accommodate layered seafloors or seafloors with variable resistance.</p> <p>Disadvantages</p> <p>Susceptible to cyclic load-strength reduction when used in taut moorings in loose sand coarse silt seafloors. For critical moorings, knowledge of soil engineering properties is required. Anchor typically is not recoverable. Special consideration is needed for ordnance.¹ Anchor cable is susceptible to abrasion and fatigue.¹ Gun system is not generally recoverable in deep water (> 1,000 ft) Surface vessel must maintain position during installation.</p>

Table 16 is useful in the initial selection of possible anchor types suited to the various mooring configurations described previously (refer to Figure 35). There are many anchoring options that may be appropriate for any of the three mooring configurations. Almost any of the anchor types can be designed to work with each mooring configuration but there may be an optimal or equivalent choices based upon seafloor conditions, available installation assets, load and load direction, and cost. The choices are described by Table 17 with the color code at bottom.

Mooring Configuration	Anchor Type	Comments
Catenary	Deadweight	Skirted deadweight or enhanced deadweight (PHA) for limited sediment or rock.
	Drag	Primary choice for sediment seafloors. Broad use experience.
	Pile	Applicable but not recommended due to cost
	Plate	Applicable but requires more specialized installation equipment.
Multi-catenary	Deadweight	Skirted deadweight or enhanced deadweight (PHA) with sinkers to reduce line angle at PHA. May be a practical option for limited sediment or rock seafloors. Handling weight will drive cost.
	Drag	Must be used with sinkers to reduce line angle to near horizontal angle at the seabed. While this increases handling difficulty it may be a cost effective option because there is broad use experience with this type of system.
	Pile	Applicable but not recommended for single WEC installations due to cost unless equipment and expertise is readily available. Suction piles may be the preferred pile option for sediment seafloors. May be very cost effective for energy farms.
	Plate	Plates can be a cost effective option for single WECs but this depends upon the availability of installation equipment and expertise. Plates are not recommended when load sharing may be required for energy farm applications.
Taut	Deadweight	Applicable but large line loads require high weight to resist vertical and horizontal loads. On seafloors with rock or thin sediment this option should be considered.
	Drag	Cannot handle uplift loads.
	Pile	Broad use experience for soil and rock seafloors. Local expertise and equipment are important to the selection of the least cost pile type and installation method.
	Plate	May be the least cost option for sediment seafloors but not appropriate for rock.

Applicability
High
Medium
Low
Not Applicable

Table 17 Mooring Configuration Anchor Options

4.0 OREGON COAST CHARACTERISTICS

4.1 Introduction

This section provides the results of a desk top survey of the site characteristics of the Oregon coast with particular attention to the nine permitted FERC sites. Site characteristics include:

- Wave conditions
- Wind conditions
- Ocean currents
- Threats and obstructions
- Bathymetry and sediment maps
- Geological information

A listing of websites to gather additional Geophysical, Hydrographic, Metocean, Geological, and Geotechnical data of the Oregon Coast is also provided.

4.2 FERC Sites

There were a total of nine sites considered in this study, six FERC permitted sites in the north, and three FERC permitted sites in the south. Both Figure 36 and Table 18 provide site location details.

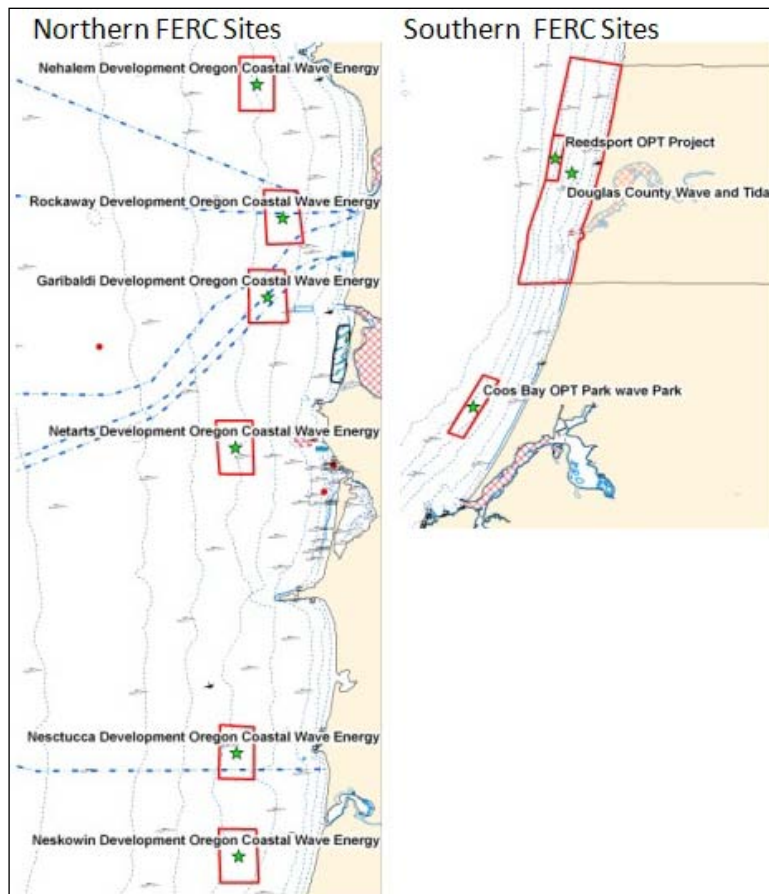

Figure 36 All FERC Permitted Sites, North and South, along Oregon Coast

Table 18 Bounding Coordinates of Nine FERC Permitted Sites

FERC Permit Name	Area		Bounding Coordinates				FERC Permit Centroid	
	AreaSqM	AreaSqK	Left	Right	Top	Bottom	Long (X)	Lat (Y)
Nehalem Development Oregon Coastal Wave Energy	9924543.86	9.92	-124.0393	-124.0121	45.7656	45.7229	-124.025783	45.744274
Rockaway Development Oregon Coastal Wave Energy	10114871.52	10.11	-124.0203	-123.9890	45.6608	45.6176	-124.005308	45.638944
Garibaldi Development Oregon Coastal Wave Energy	10731519.76	10.73	-124.0324	-124.0013	45.5977	45.5555	-124.017316	45.576388
Netarts Development Oregon Coastal Wave Energy	10216827.23	10.22	-124.0583	-124.0282	45.4783	45.4362	-124.042657	45.457606
Nestucca Development Oregon Coastal Wave Energy	9939674.56	9.94	-124.0558	-124.0279	45.2385	45.1953	-124.041621	45.216423
Neskowin Development Oregon Coastal Wave Energy	11048460.33	11.05	-124.0558	-124.0242	45.1564	45.1137	-124.040157	45.134845
Coos Bay OPT Park wave Park	13149606.63	13.15	-124.3600	-124.3008	43.5036	43.4308	-124.330455	43.467289
Douglas County Wave and Tidal	136203365.59	136.20	-124.2782	-124.1586	43.8728	43.6097	-124.216294	43.739016
Reedsport OPT Project	6767926.27	6.77	-124.2469	-124.2239	43.7825	43.7292	-124.235364	43.755747

4.3 Wave Climate / Storm Wave Analysis

The wave climate for the Oregon Coast has been measured by the wave buoy program established by the National Data Buoy Center (NDBC) beginning in the 1970’s. The NDBC Buoy 46002 located 245 nautical miles (453 km) west of Coos Bay Oregon was one of the first wave buoys established along the Oregon Coast. This buoy is centrally located along the Oregon coast and offers more than 30 years of historical wave measurements that are useful in assessing general trends of the wave climate (Figure 37).

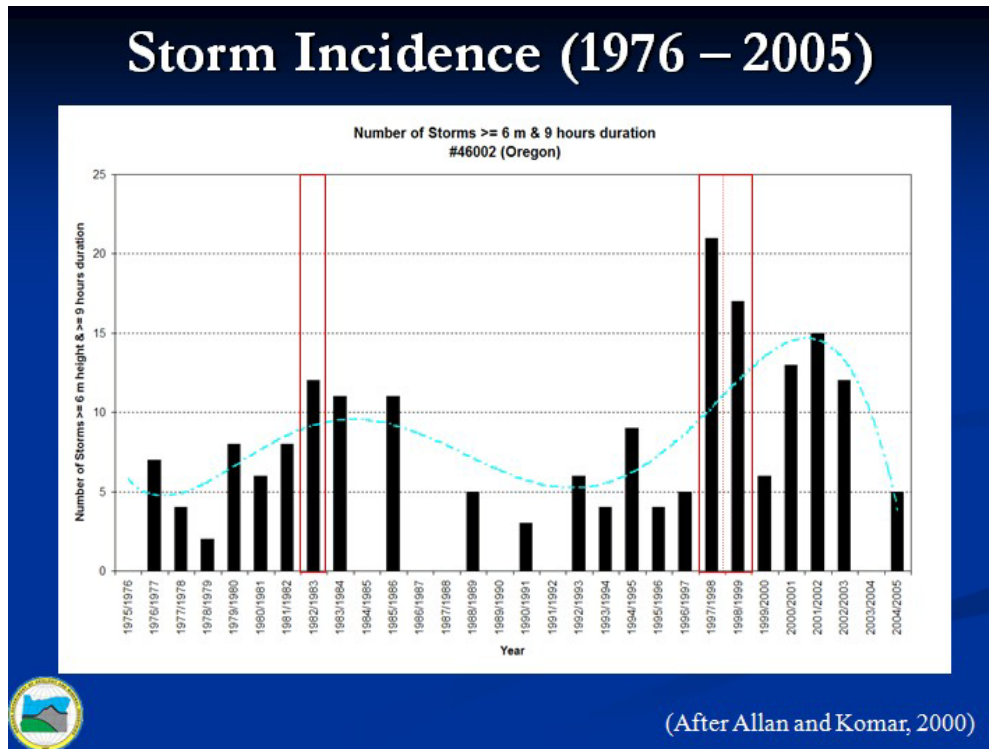
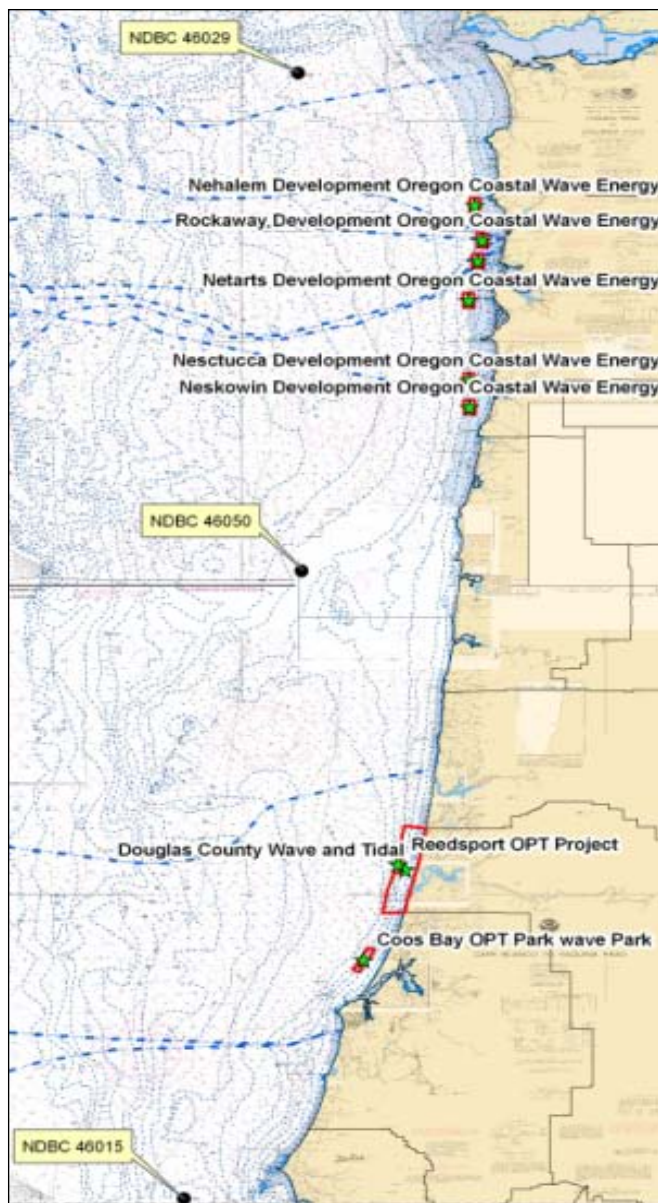

Figure 37 Historical Trend of Storm Waves at NDBC Buoy 46002, 30-Year Data Record

The partial data recorded by NDBC Buoy 46002 indicates a roughly cyclical trend of storm events with several years with a higher frequency of storm events followed by 10 or more years of calmer conditions. The exception to this general trend is found during the years when El Niño conditions affect the west coast of the U.S. (see red boxed areas in Figure 37). The winter periods of 1982 / 1983 and 1998 / 1999 represent strong El Niño events that are generally

expected to increase the size and frequency of high swell events from storms along the entire U.S. west coast. While it is evident that the frequency of high swell events increased substantially during the 1998 / 1999 winter, the same cannot be said for the winter of 1982 / 1983.

For the purposes of this study, the NDBC Buoy 46002 location was too far offshore to provide an accurate representation of the wave climate specific to the individual FERC permitted sites of the Oregon Coast. Fortunately, the NDBC established NDBC Buoy 46029, 23 nautical miles (42 km) offshore of the mouth of the Columbia River along the north Oregon coastline in 1984. This was followed by the installation of NDBC Buoy 46050 at Stonewall Banks, 18 nautical miles (34 km) offshore of the central Oregon Coast in 1991. And NDBC Buoy 46015, located 14 nautical miles (25 km) offshore of Port Orford, in the southern portion of the state was established in 2002. Figure 38 shows the location of NDBC Buoys (46015, 46050 and 46029) along the Oregon Coast.



These three NDBC buoys are evenly spaced along the Oregon coast and provide the best measurements of wave characteristics to make an analysis of the wave climate at the locations of the FERC permitted sites.

Figure 38 Location of NDBC Buoys (46015, 46050 and 46029) along Oregon Coast

The NDBC website offers a plot of the significant wave heights (mean values and range) at NDBC Buoy 46029 produced from data recorded by this buoy over a 17 year period from 1984 through 2001 (Figure 39). This plotted data shows that the average significant wave height (Hs) as well as the upper range of Hs increased between October and March, the winter months. This trend of significantly higher Hs and higher range of Hs is duplicated in a similar plot of data from NDBC Buoy 46050 that was produced from 10 years of data (Figure 40). No similar plot was available from NDBC Buoy 46015 as this buoy had only recorded seven years of data at the time this report was written.

The red bar in these figures indicates one standard deviation above and below the mean value that is shown as the dark symbol in the center of the red bar. The full range of Hs for each month is represented by the solid line, with the maximum and minimum value indicated by the circled dot at the end of this line. The highest Hs recorded over a 10 year period (1991 – 2001) at NDBC Buoy 46050 occurred on March 3, 1999, when Hs reached 14.1 m. On the same day NDBC Buoy 46029 recorded 12.8 m as the highest Hs at this buoy location in 17 years. This event occurred during the previously noted El Niño event that increased the size and frequency of storms along the Oregon coast during the winter of 1998 / 1999.

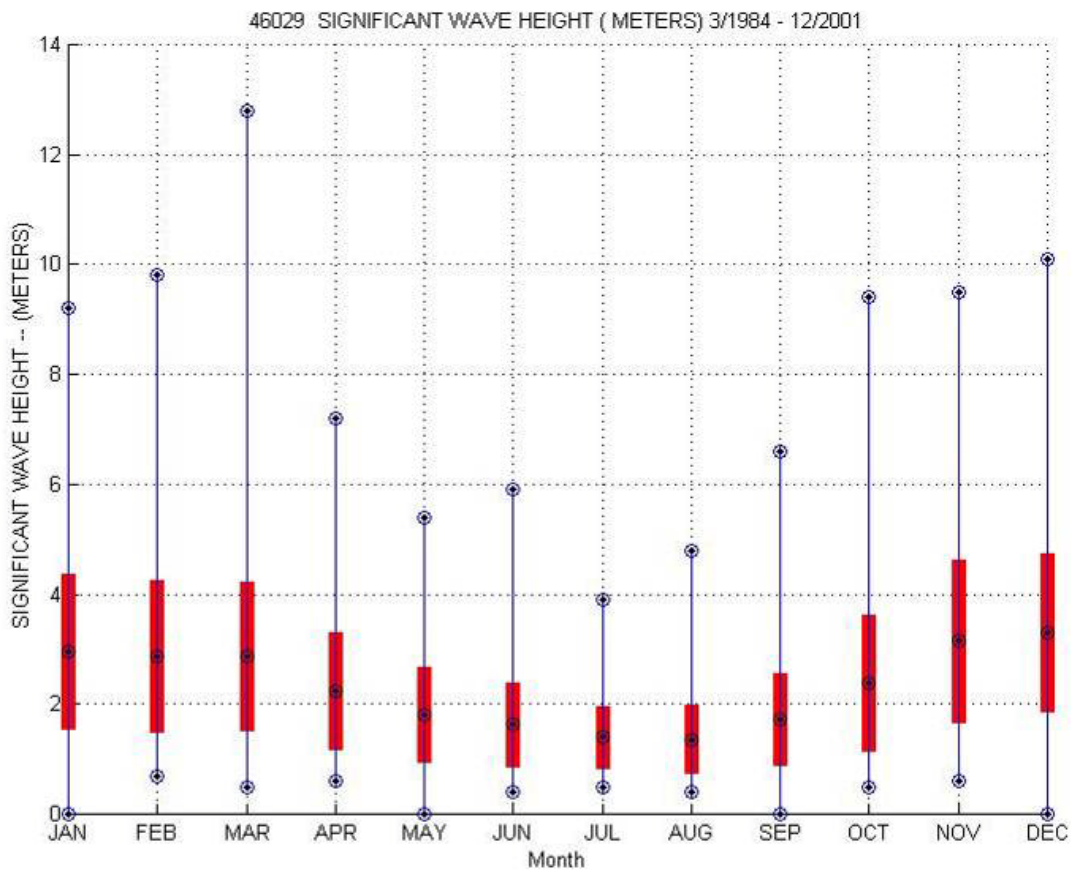

Figure 39 Significant Wave Height at NDBC Buoy 46029 (1984 – 2001)

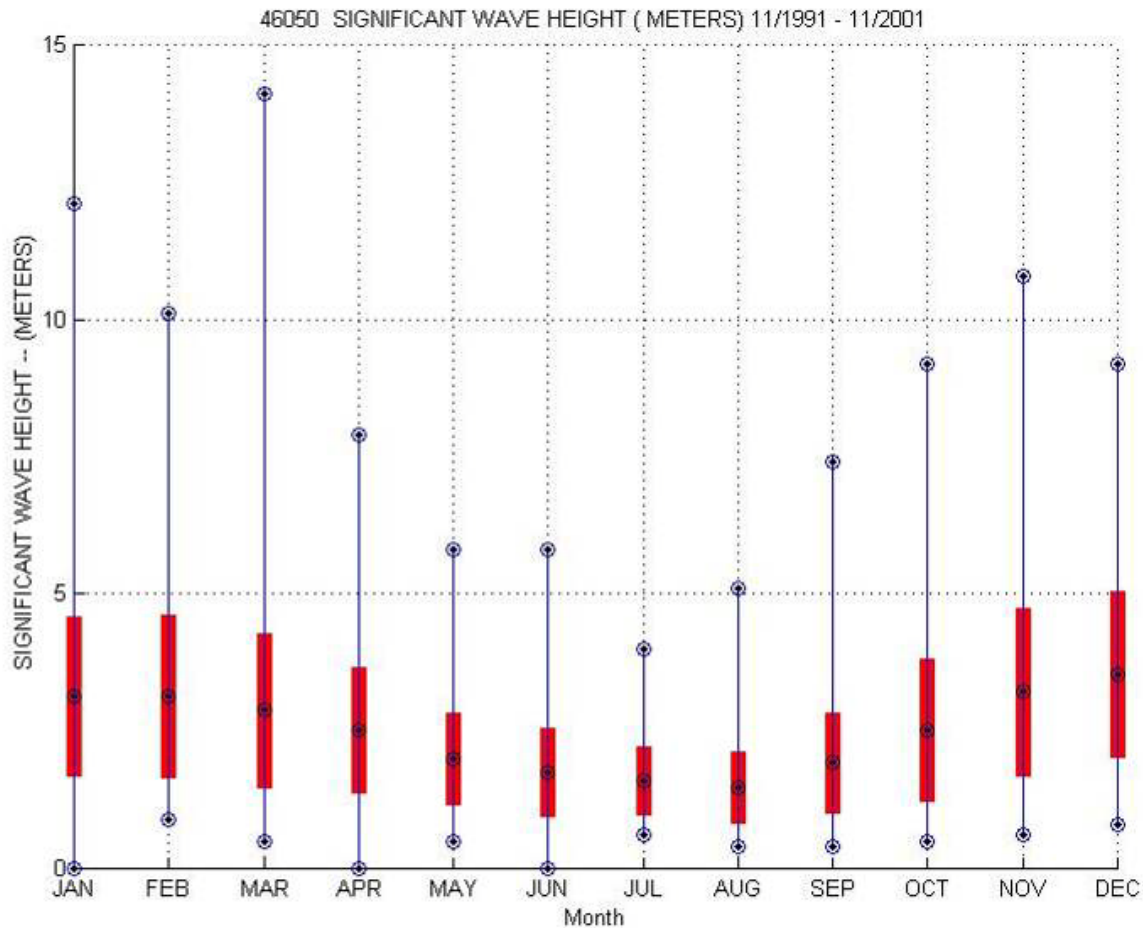

Figure 40 Significant Wave Height at NDBC Buoy 46050 (1991 – 2001)

The statistical averages of H_s at these buoy locations provide a general overview of the wave climate along the Oregon Coast, however the frequency of high swells produced from strong storms impacting the area are of interest to the FERC permitted sites in this study. High swell events will impact the installation, operations and the survivability of any WEC deployed. Data from each of the 3 NDBC Buoys (46029, 46050 and 46015) was used to assess the frequency of high swell events that occurred at each location (Figure 41). 10-years of data were available from NDBC Buoy 46029 and NDBC Buoy 46050 and 7 years of data from NDBC Buoy 46015 were available for this assessment.

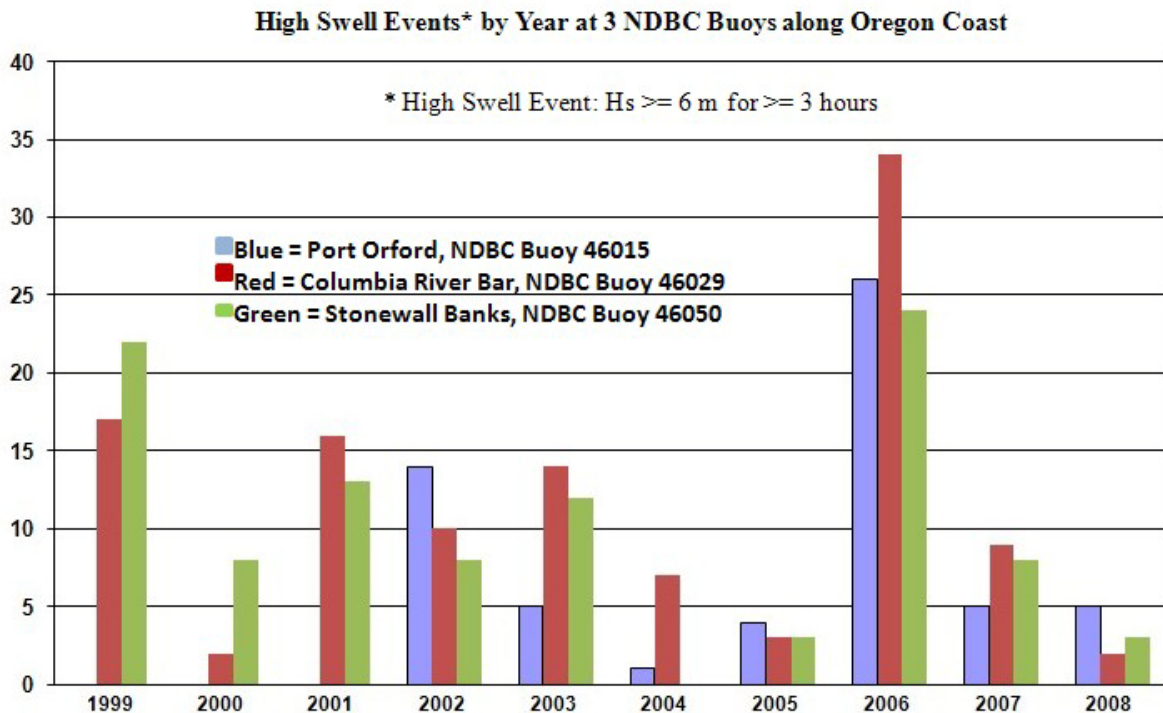

Figure 41 Frequencies of High Swell Events per Year along Oregon Coast

The frequency of high swell events, defined in this assessment as H_s greater than or equal to 6 m for three hours or longer, showed considerable variation from one year to the next, with several years of relative calm followed by a substantial increase in the frequency of these events. This is roughly similar to the pattern seen in the 30-year data set taken from NDBC Buoy 46002. These data indicate that there was no single location along the Oregon Coast that regularly has a higher frequency of high swell events. For example, in the years 2000 and 2001, NDBC Buoy 46050 had more frequent high swell events, and the following three years NDBC Buoy 46029 had a higher frequency of high swell events.

The most significant information in this plot is the data for year 2006. This year was a La Niña year, when colder than average sea surface temperatures were found in the eastern equatorial Pacific and the Northern Pacific jet stream flow directed multiple storms to the northwest region of the U.S. As a result of this increase in the number of storms along the coast of Oregon during 2006, the frequency of high swell events was the highest of any year measured during this 10-year period for the 3 NDBC buoys near the coast.

The winter months of 1999 were dominated by a strong El Niño event when warmer than average sea surface temperatures in the equatorial eastern Pacific affected weather patterns along the western coast of the U.S. In recent years, evidence in the form of detailed equatorial buoy data has been recorded that shows anomalous upper level circulation during eastern Pacific El Niño years occasionally causes North Pacific jet stream flow to split during winter months. When this happens, compact but powerful low pressure systems may form beneath the southern split of the jet bringing unusually severe weather conditions to California. While the northern portion of the Northern Pacific jet stream is directed into Canada and Alaska when the jet stream

splits. Therefore, during El Niño years the coast of Oregon may experience milder than average weather in the form of less rainfall and milder temperatures but may still have an increase in the average number of high swell events impacting the coastal areas as a result of the strong storms passing to the south of Oregon on route to the coast of California. The wave buoy data record for the winter months of 1998 / 1999 are an example of this scenario.

The analysis of 10 years of data from NDBC Buoys 46015, 46029 and 46050 (Figure 36) illustrates that a La Niña year such as 2006 can bring an increase in the frequency of high swell events to the coast of Oregon that are on par with, or greater than those caused by a strong El Niño event. The La Niña year of 2006 surpassed the El Niño year of 1999 having the most frequent number of high swell events in this 10-year period (1999 – 2008). This pattern is contrary to the 30-year data set from NDBC Buoy 46002 (Figure 36) where only El Niño years were identified as having the most significant impact on the frequency of high swell events reaching the coast of Oregon. Nevertheless, either of these two conditions, El Niño or La Niña, should be closely monitored when planning operations in the FERC permitted site areas along the coast of Oregon.

A detailed breakdown of the high swell events at each of the NDBC Buoys 46015, 46029 and 46050 which recorded the number of high swell events during each month shows that these events are largely confined to the winter months, October through April (Tables 19-21). There is only one occasion where one of these high swell events occurred during the month of May in 2005 and a high swell event was never recorded from June through September for the years of data analyzed. This detailed breakdown of the data to a monthly level demonstrates that periods of highest swells (storm events) are restricted to the winter months, and by comparison the summer months can be relatively calm. These tables also indicate the many months of missing data at each buoy, and this information should be carefully considered when viewing the overall totals for each wave buoy.

Table 19 NDBC Buoy 46015 High Swell Events by Month and Year (*= partial or no data)

Month	2002	2003	2004	2005	2006	2007	2008
January	*	2	*		7		1
February	*		*		3		1
March	*	3	*	1	5	*	
April	*		*			*	
May	*		*			*	
June	*		*				
July	*						
August							*
September				*			*
October		*				1	
November	1	*			1		
December	13	*	1	3	10	4	3
Totals	14	5	1	4	26	5	5

Table 20 NDBC Buoy 46029 High Swell Events by Month and Year (*= partial or no data)

Month	1999	2000	2001	2002	2003	2004	2005	2006	2007	2008
January	3	*		2	2	1	*	8	3	*
February	8	*	1			2	*	6	1	*
March	4	*	1	2	2	1	*	5		1*
April	1	*					*			
May							1			
June										
July										
August										
September										
October	1	1	1		3			1	1	
November		*	6	1	3	2		3	3	
December		1*	7	5	4	1	2	11	1	1
Totals	17	2	16	10	14	7	3	34	9	2

Table 21 NDBC Buoy 46050 High Swell Events by Month and Year (*= partial or no data)

Month	1999	2000	2001	2002	2003	2004	2005	2006	2007	2008
January	3	2		*	3		*	5	1	*
February	10	2	1				*	3	1	*
March	2		1	1	2		*	3	1	1*
April	2						*			
May							1			
June										
July										
August								*		
September								*		
October	1	2	2		2				2	
November	1			2	2			4	1	
December	3	2	2	5	3		2	9	2*	2
Totals	22	8	13	8	12	0	3	24	8	3

4.4 Winds and Storm Information

The NDBC website (<http://www.ndbc.noaa.gov/>) contains archived plots of the average wind speeds when there is sufficient time series data to produce a plot that spans at least 10 years. For example, at NDBC Buoy 46029 this plot was produced from data recorded by this buoy over a 17 year period from 1984 through 2001 (Figure 42). The red bar in these figures indicates one standard deviation above and below the mean value that is shown as the dark symbol in the center of the red bar. The full range of wind speed for each month is represented by the solid blue line, with the maximum and minimum value indicated by the circled dot at the end of this line.

The plot of average wind speed at NDBC Buoy 46029 indicates that the average wind speed increased nearly two-fold between July and December, and that the winter months have the higher average wind speeds compared to summer months. This trend of higher average wind speed and higher range of wind speed is duplicated in a similar plot of data from NDBC Buoy 46050 that was produced from 10 years of data (Figure 43). No similar plot was available from NDBC Buoy 46015 as this buoy had only recorded seven years of data at the time this report was written.

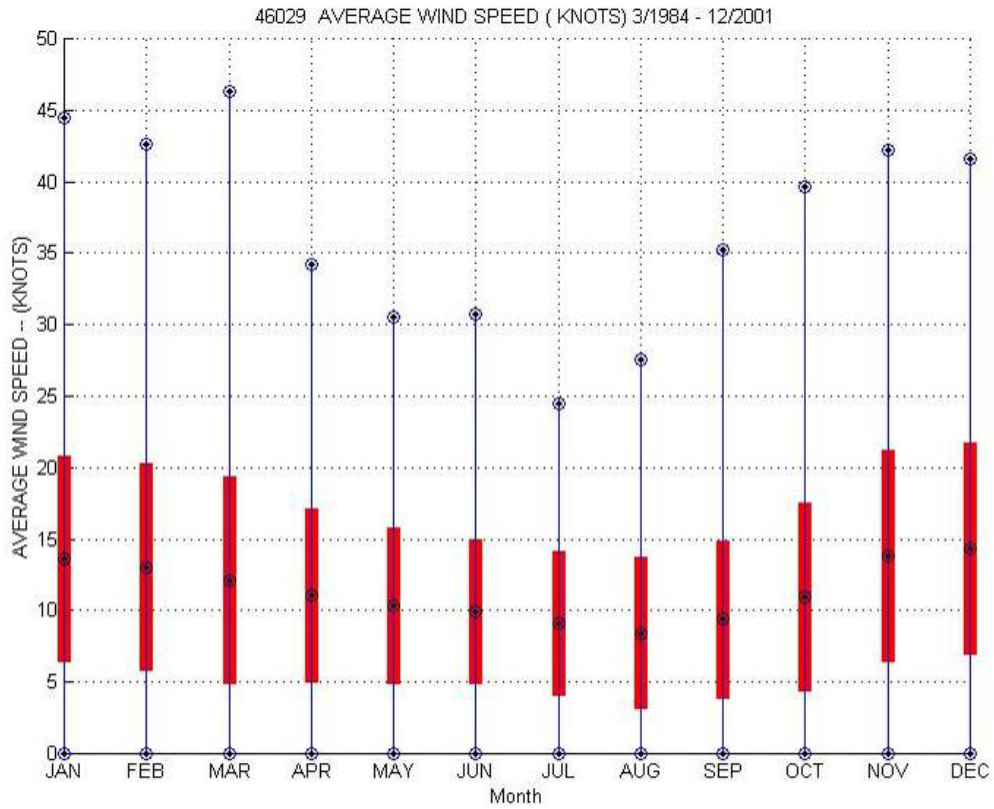

Figure 42 Wind Speed at NDBC Buoy 46029 (1984 – 2001)

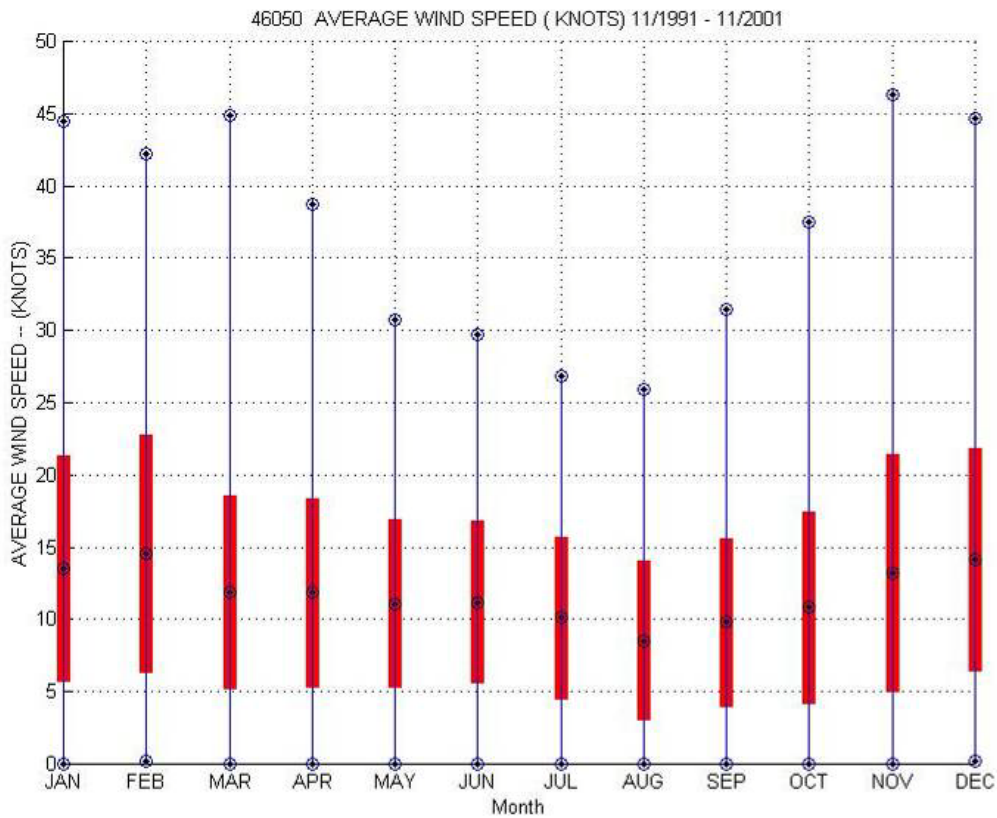

Figure 43 Average Wind Speed at NDBC Buoy 46050 (1991 – 2001)

The statistical averages of wind speeds at these buoy locations provide a general overview of the wind climate along the Oregon Coast, however the frequency of strong wind events impacting the area are also of interest to the FERC permitted sites in this study. The strength of wind events and their frequency are important to consider in planning the installation, operations and the survivability of any WEC operating at these sites. Data from each of the three NDBC Buoys (46029, 46050 and 46015) was used to assess the frequency of these wind events occurring at each of the three NDBC Buoy locations (Tables 22-24). Wind events are defined as having sustained wind speeds at the specified range for three or more hours. 10-years of data were available from NDBC Buoy 46029 and NDBC Buoy 46050 and seven years of data from NDBC Buoy 46015 were available for this assessment. These data should be interpreted with the caveat that all of these buoys had long periods of time when they did not collect data, and roughly half the years had less than 12 months of continuous data records. The number of months during each year that the buoy collected wind data is indicated in each table.

Table 22 Wind Speeds at NDBC Buoy 46015, 7-year dataset

Year	Months of data	10-20 knots	20-30 knots	30-40 knots	> 40 knots
2008	7	154	60	4	0
2007	9	185	79	8	3
2006	10	193	115	35	0
2005	12	276	120	21	0
2004	6	136	62	5	0
2003	9	226	84	11	0
2002	6	103	69	15	1

Table 23 Wind Speeds at NDBC Buoy 46050, 10-year dataset

Year	Months of data	10-20 knots	20-30 knots	30-40 knots	> 40 knots
2008	10	261	71	3	0
2007	12	286	80	6	2
2006	12	173	83	22	0
2005	9	212	54	5	0
2004	12	275	71	3	0
2003	12	327	83	14	0
2002	11	281	73	15	0
2001	10	246	53	6	1
2000	10	270	55	8	1
1999	12	309	109	27	1

Table 24 Wind Speeds at NDBC Buoy 46029, 10-year dataset

Year	Months of data	10-20 knots	20-30 knots	30-40 knots	>40 knots
2008	10	253	54	3	0
2007	8	166	38	3	0
2006	12	302	107	24	0
2005	9	190	48	4	0
2004	12	292	48	1	0
2003	12	309	76	9	0
2002	12	310	79	7	0
2001	12	307	61	13	0
2000	7	161	30	4	0
1999	12	309	103	22	1

From the detailed breakdown of wind events occurring during each year it is apparent that the lower range of wind speed used in this assessment, events with 10 to 20 knots of wind, varied widely from one year to the next. For example, at NDBC Buoy 46050 during the year 2006 (a La Niña year) there were only 173 recorded events in the full 12 months while there were 309 recorded events during 1999 (an El Niño year). One explanation of why 2006 may have had a lower frequency of these mild wind events is that the winds were typically stronger than the range of 10 to 20 knots when storms did impact the coast of Oregon. During 2006 the La Niña year measured in this data it was more common for storms to directly impact the coast of Oregon, therefore wind speed would be higher during this year. During an El Niño year, such as 1999, the centers of storms would typically pass much further to the south in California and the coast of Oregon would receive the lighter winds from the periphery of these storms.

As the range of wind speed events is increased in these tables (20 to 30 knots, 30 to 40 knots and >40 knots) both 1999 and 2006 stand out as years when high wind events occurred more frequently than in other years. This is especially true of the 30 to 40 knots range of wind events measured at NDBC Buoy 46015 during the years 2005 and 2006 (Figure 44) . NDBC Buoy 46015 did not offer data previous to 2002 so it was not possible to compare 2006 and 1999 at the southern most buoy location. However, during 2006 there were 35 wind events in the range of 30 to 40 knots at NDBC Buoy 46015 with only 10 months of data measured during that year.

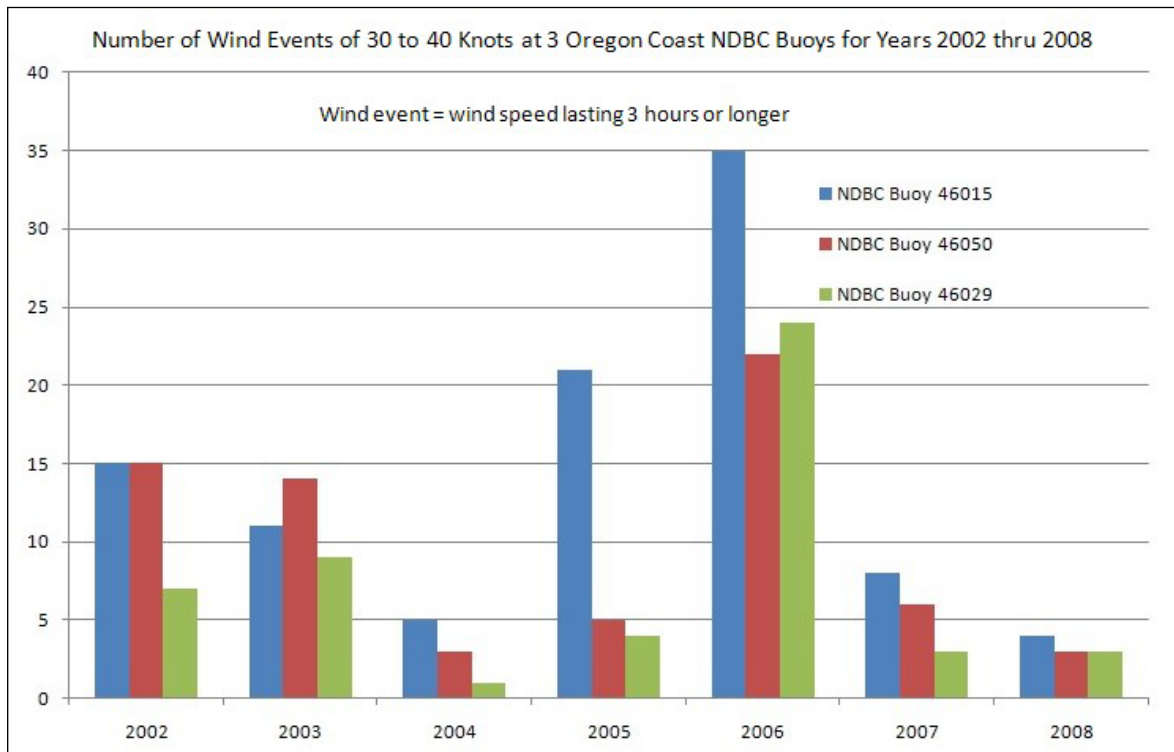

Figure 44 Frequency of 30 to 40 Knot Wind Events at 3 NDBC Buoys along Oregon Coast

A closer examination of the data at NDBC Buoy 46015 for the winter period of late 2005 and early 2006 showed that this southernmost location along the coast of Oregon had the highest frequency of strong wind events during this time with respect to those NDBC buoy located further north. There were 12 wind events in the range of 30 to 40 knots at this buoy during November and December of 2005, and 10 events during January of 2006. Further up the coast at NDBC Buoy 46050 there were only four wind events in the range of 30 to 40 knots during November and December of 2005, followed by eight wind events in this range during January of 2006. At NDBC Buoy 46029, the northern most buoy along the coast of Oregon, there were only four wind events in the range of 30 to 40 knots during November and December of 2005, followed by five wind events in this range during January of 2006.

4.5 Ocean Currents

Direct measurements of surface currents along the entire coast of Oregon are available from the Oregon Coastal Ocean Current Mapping Lab at Oregon State University (OSU). This lab maintains a network of CODAR stations along the Oregon coast that produces daily images of the surface currents. The CODAR instruments produced by CODAR Ocean Sensors, uses a network of land-based high-frequency radar to obtain data on surface currents. This network of CODAR stations produces data on surface currents up to 200 km offshore. The Oregon Coastal Ocean Current Mapping Lab uses this data to produce maps of surface currents and post these maps on their website (<http://bragg.oce.orst.edu/>). These maps are automatically updated each day and posted to the lab's website (Figure 45).

The Oregon Coastal Ocean Current Mapping Lab at Oregon State University has several other types of data posted on their website, which are useful to obtain real-time and long-term datasets on ocean conditions along the Oregon coast. These data include the Global Ocean Ecosystem Dynamics (GLOBEC) Mooring NH10, located 20 km East of Newport Oregon at 44° 38.8' N by 124° 18.4' W. This mooring is in 81 m of water and the buoy data archive includes ADCP data from 1994 until present (September 2009) for depths of 10, 24, 38, 52 and 66 m. Plots of the monthly and seasonal (quarterly) current velocities profiles are available for download from this website (Figure 45). Additionally other oceanographic data of temperature, salinity, and wind speed are also measured by this buoy and available for download.

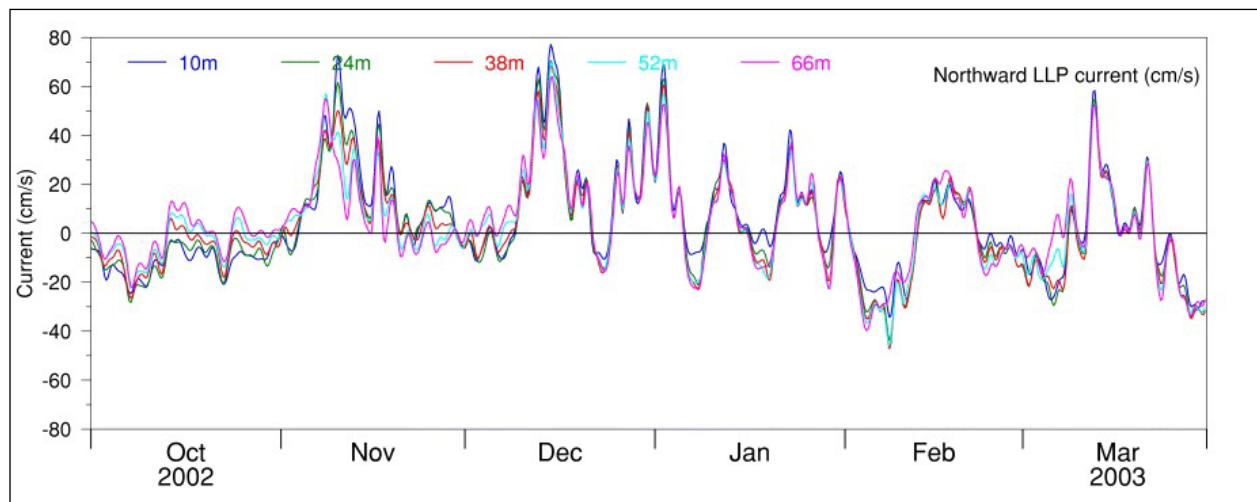

Figure 45 Measured at Multiple Depths from GLOBEC Mooring NH10 ADCP

The COAST 2003 Met Buoy, also maintained by the OSU Ocean Currents Mapping Lab, provides ADCP data, wind, water temperature and salinity data from a second location approximately 40 km north of the GLOBEC Mooring NH10. This moored ADCP is located at 45.0° N by 124.15° W, approximately 10 km offshore of Lincoln City, Oregon. Data from this ADCP is available from 1/11/2003 and other data (wind, temperature, salinity and more) are available from 5/15/2001.

The Oregon Coastal Ocean Current Mapping Lab website also maintains a current inventory of the buoys and instrumentation deployed along the coast of Oregon, and any data sources that are available for public download. This list of oceanographic moorings includes; type of instrument, contact person for each instrument, locations, and anticipated recovery for each instrument.

4.6 Threats from Wrecks and Obstructions

The threats from existing objects on the bottom within each FERC permitted sites along the coast of Oregon were investigated using 2 NOAA chart resources and their associated databases. The two resources available for this investigation were the NOAA Raster Navigational Chart and the NOAA Electronic Navigational Chart, both of these resources had associated information on

each item shown on the chart (e.g. type of wreck, name of submarine cables). The additional information on each item shown on the charts is maintained in an associated database for each chart by NOAA; information is updated weekly and is available for public download at the website (<http://www.nauticalcharts.noaa.gov/staff/charts.htm#RNC>).

Information on each item shown on these maps that is inside the boundaries of the FERC permitted sites is provided in the text below. Four images showing the nine FERC sites at a scale where details on the obstructions could be distinguished is included in this section. The legend of symbols for these wrecks and obstructions maps was also modified to a readable scale from the format presented on the aforementioned website (Figure 41).

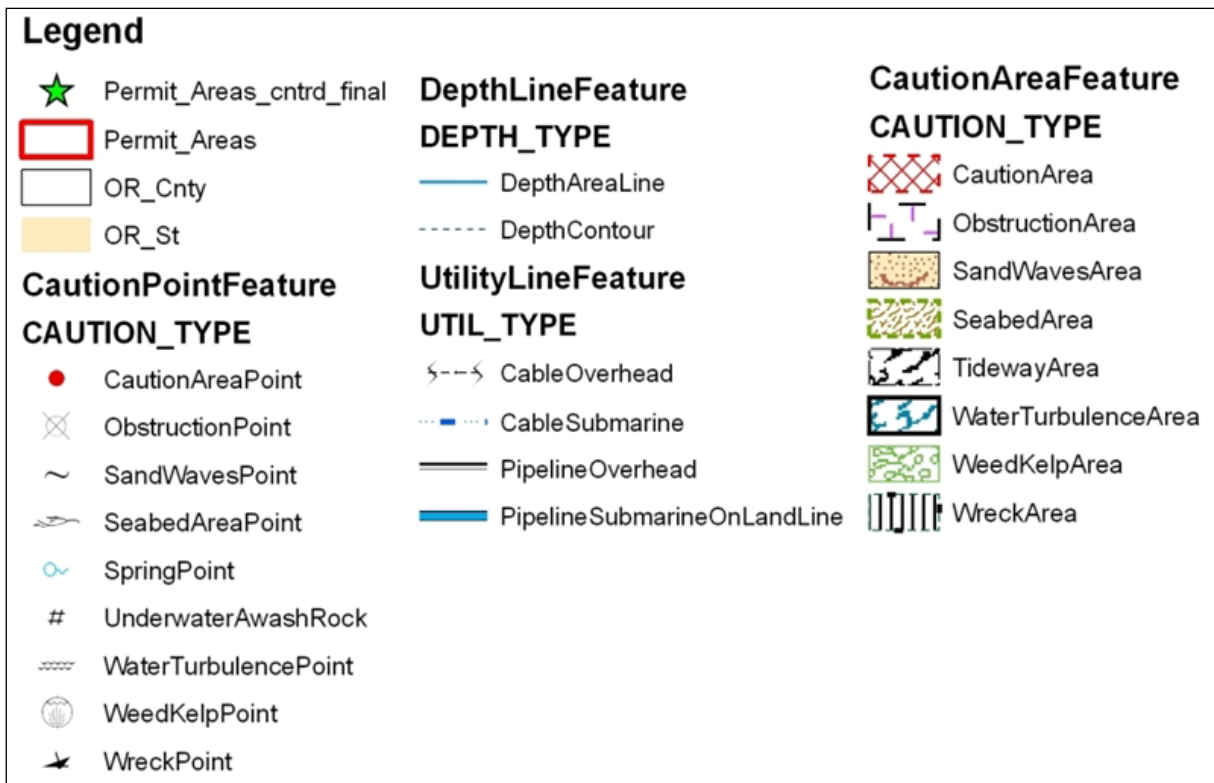

Figure 46 Legend for Wrecks and Obstructions Maps

4.6.1 Northern FERC permitted sites

The wrecks and obstruction maps for the six northern FERC permitted sites along Oregon Coast are shown as two separate maps to preserve the details found on each map that would be lost if these two images were combined into a single map. The four northernmost of these sites are shown in Figure 47. The remaining two sites are shown in Figure 48.

Individual FERC permitted sites are listed below with detailed information on obstructions within the site area. Each of these six sites are Development Oregon Coastal Wave Energy sites and only the first word of their individual names are used to denote them in this list.

Nehalem - No obstructions known within this site area.

Rockaway – Three submarine cables within this area:

- The submarine cable in northeast corner of the site area is designated as TNG_Pacific_G1_RPL.30 in the NOAA database.
- The submarine cable in the center of this site area is designated as the Northstar Cable in the NOAA database.
- The submarine cable in the southeast corner of this site area is designated as the Southern Cross Cable by the NOAA database.

Garibaldi – Three submarine cable within this area:

- The submarine cable in the northwest portion of this site area is the Southern Cross Cable, and is the same submarine cable that transects the Rockaway site.
- The submarine cable in the center portion of this site area is designated as TNG_Pacific_G6_RPL.10 by the NOAA database.
- There is no designation given for the southernmost submarine cable that transects this site area.

Netarts – One sea bed area point is given within this site area, the NOAA database states that the bottom in this area is gravel. No other obstructions were found in this area.

Nescuttuca – One sea bed area point is given within this site area, the NOAA database states that the bottom in this area is sand. There is one submarine cable that crosses the southern portion of this site area, the NOAA database gives this cable the designation of the North Pacific Cable.

Neskowin – No obstructions know within this site area.

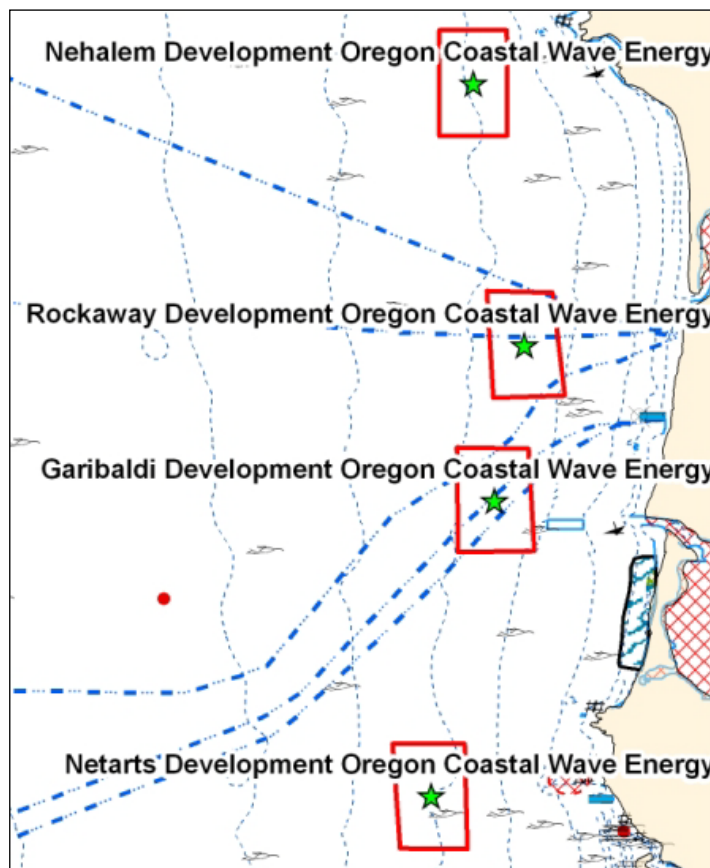

Figure 47 Four Northernmost FERC Sites with Obstructions Shown

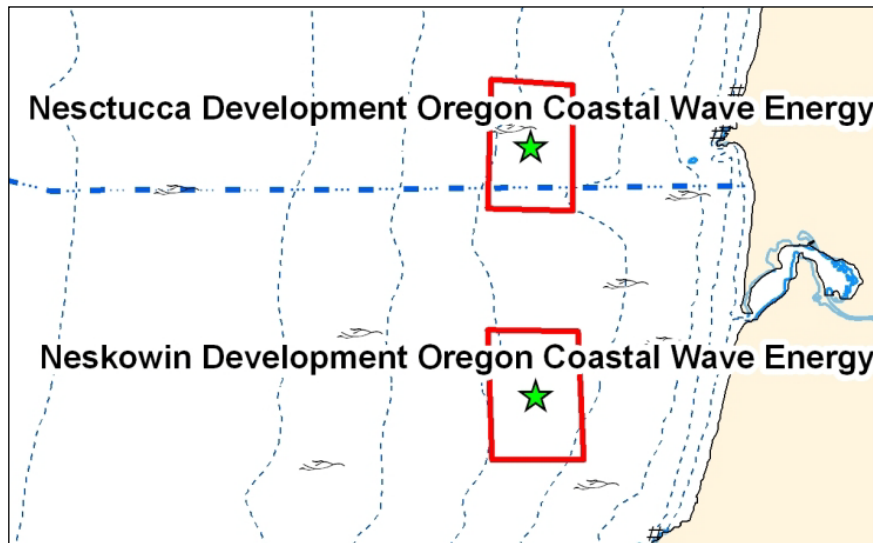

Figure 48 Two Additional Northern FERC Permitted Sites

4.6.2 Southern FERC Permitted Sites

The wrecks and obstruction maps for the three southern FERC permitted sites along Oregon Coast are shown as two separate images in this section to preserve the details found on each map that would be lost if these images were combined into a single map. The two northernmost of these sites are shown in the Figure 49. The remaining individual site is shown in Figure 50.

The three southern FERC permitted sites are listed below with any information regarding obstructions inside the site area:

- Reedsport OPT Project - There were no obstructions known within this site area.
- Douglas County Wave and Tidal - There are One Obstruction Point, one Wreck Point and five Seabed Area Points known within this site area. The following details were provided by the NOAA database on these:
 - The Obstruction Point is listed as a submerged wave gauge that is always as shallow as the surrounding bottom.
 - The Wreck Point in this area is listed as a ship wreck that is always submerged.
 - All five of the Seabed Points listed within this site area are given the designation of sand.
- Coos Bay OPT Wave Park - There were no obstructions known within this site area.

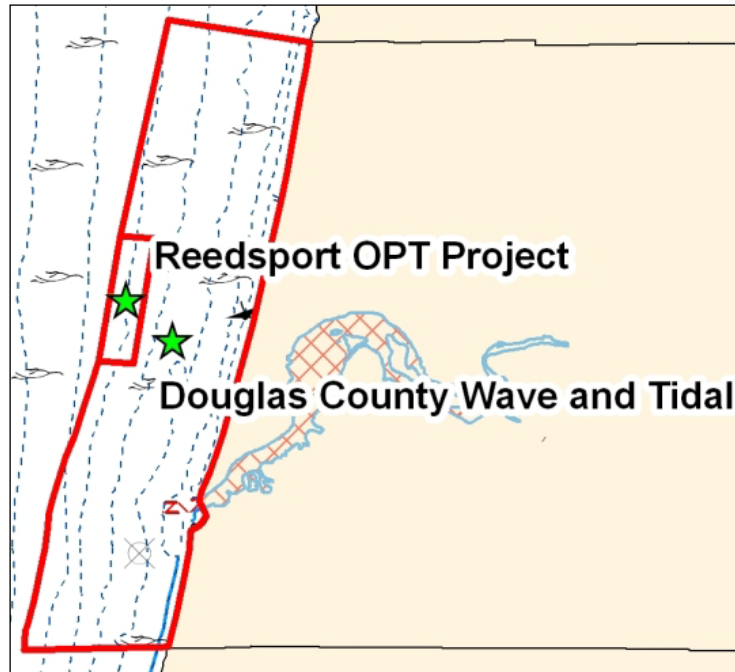

Figure 49 Two of the Southern Oregon FERC Sites with Obstructions Shown

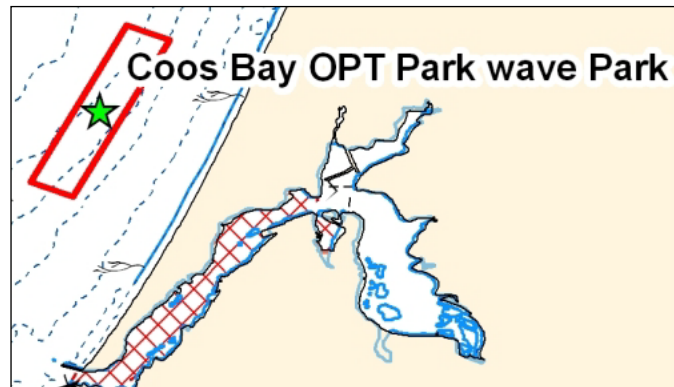

Figure 50 Southernmost Oregon FERC Site with Obstructions Shown

4.7 Buoy Locations near FERC Sites

All operations at the FERC permitted sites will require real-time and predicted information on meteorological and oceanographic data. These data include tide station data, wave parameter measurements (heights and periods) and meteorological data. The proximity to the nearest buoy or shore-based station measuring these various wave and weather parameters are listed in this section of this report.

The tide measurements at the six northern FERC permitted sites are well represented by NOAA tide station 9437540, the Garibaldi Oregon station positioned near the center of these six sites.

Additionally, NOAA maintains a tide station to the north of these six sites near Astoria, Oregon (NOAA tide station number 9439040). And NOAA tide station 9435380 to the south of the six northern sites at Southbeach, Oregon (near Newport, Oregon). The relative position of these stations with regard to the six northern FERC sites is shown in Figure 51.

As discussed in a previous section, these six northern FERC permitted sites have two NDBC Buoys, 46029 to the north and 46050 to the south, which provide wave parameter measurements and a suite of meteorological data, useful in planning operations at any of these six northern sites.

Ocean currents measured by ADCPs are available from two fixed mooring locations maintained by OSU to the south of the six northern FERC permitted sites. As discussed in the previous section on ocean currents both historical and near real-time data are available for download from fixed ADCPs located to the south of these six FERC sites. The distances between the centroid of each site and the nearest buoy or station that measures tides, waves or currents are shown in Table 25.

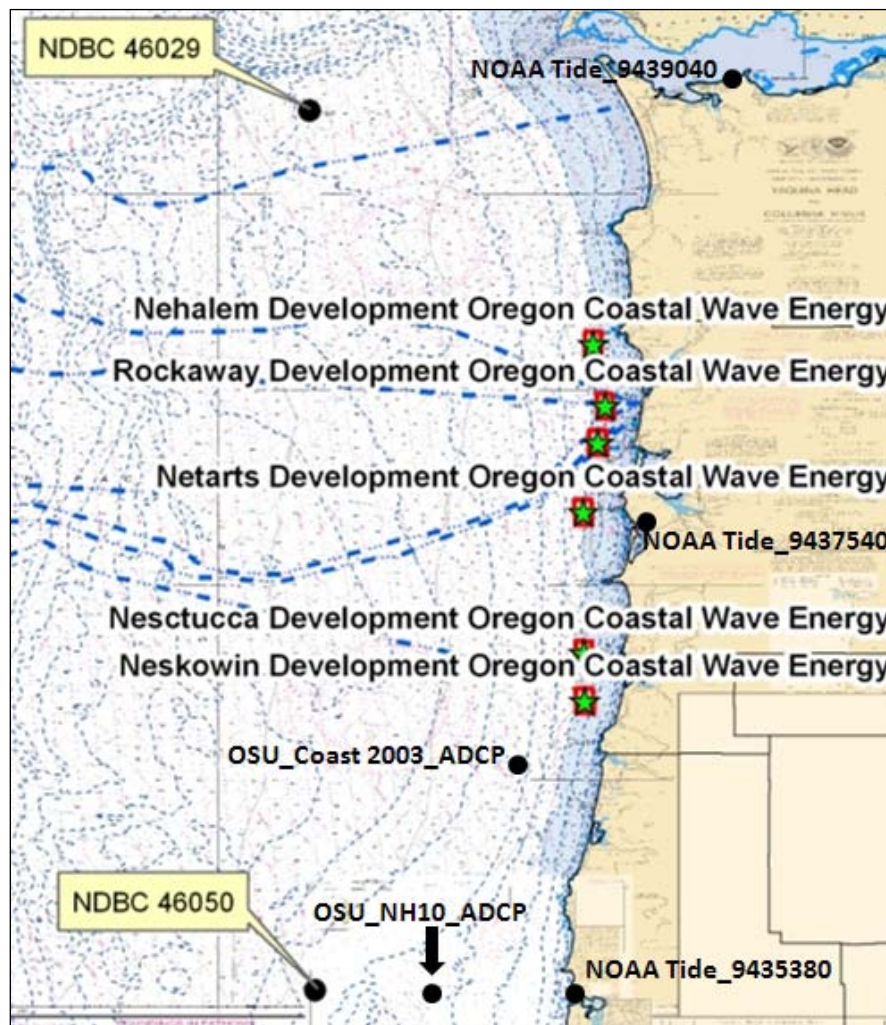

Figure 51 Northern FERC Permitted Sites with Buoy/Station Locations

Table 25 FERC Permitted Sites with Nearest Buoy/Station Locations

FERC Permitted Sites (north to south)	Tidal Station	Wave Buoy	Currents (ADCP)
Nehalem Development Oregon Coastal Wave Energy	23 km/NOAA_9437540	58 km/NDBC_46029	83 km/OSU_ADCP
Rockaway Development Oregon Coastal Wave Energy	12 km/NOAA_9437540	69 km/NDBC_46029	72 km/OSU_ADCP
Garibaldi Development Oregon Coastal Wave Energy	8 km/NOAA_9437540	74 km/NDBC_46029	64 km/OSU_ADCP
Netarts Development Oregon Coastal Wave Energy	14 km/NOAA_9437540	84 km/NDBC_46029	51 km/OSU_ADCP
Nesctucca Development Oregon Coastal Wave Energy	39 km/NOAA_9437540	73 km/NDBC_46050	25 km/OSU_ADCP
Neskowin Development Oregon Coastal Wave Energy	48 km/NOAA_9437540	65 km/NDBC_46050	17 km/OSU_ADCP
Reedsport OPT Project	46 km/NOAA_9432780	25 km/CDIP_139	99 km/OSU_NH10
Douglas County Wave and Tidal	44 km/NOAA_9432780	27 km/CDIP_139	101 km/OSU_NH10
Coos Bay OPT Wave Park	14 km/NOAA_9432780	89 km/NDBC_46015	132 km/OSU_NH10

Tide information for the three southern FERC permitted sites can be obtained from NOAA tide station 9432780, near Coos Bay, Oregon. This tide station lies to the south of all three sites, within the sheltered waters of Coos Bay (Figure 52). The nearest tide station to the north of these three sites is NOAA tide station 9435380, in Southbeach, Oregon. However, NOAA tide station 9435380 is significantly further away from these three sites than the Coos Bay, Oregon tide station and should be used only as an alternative source of data if the Coos Bay, Oregon tide station is not available.

Wave parameter information is accessible at the three southern FERC permitted sites from several sources. The California Data Information Program (CDIP) wave buoy 132 is located directly offshore of two of these sites, the Reedsport OPT Project and Douglas County Wave and Tidal sites. This buoy is useful in providing accurate measurements of significant wave height, and wave period data however this CDIP buoy does not measure meteorological data beyond sea temperature. Measurements of a full suite of meteorological data, and measurements of wave parameters are available from the NDBC Buoys to the north and south of this location, buoys 46050 and 46015 respectively. The distances from the three southern FERC permitted sites to these buoy and station locations are shown in Table 25.

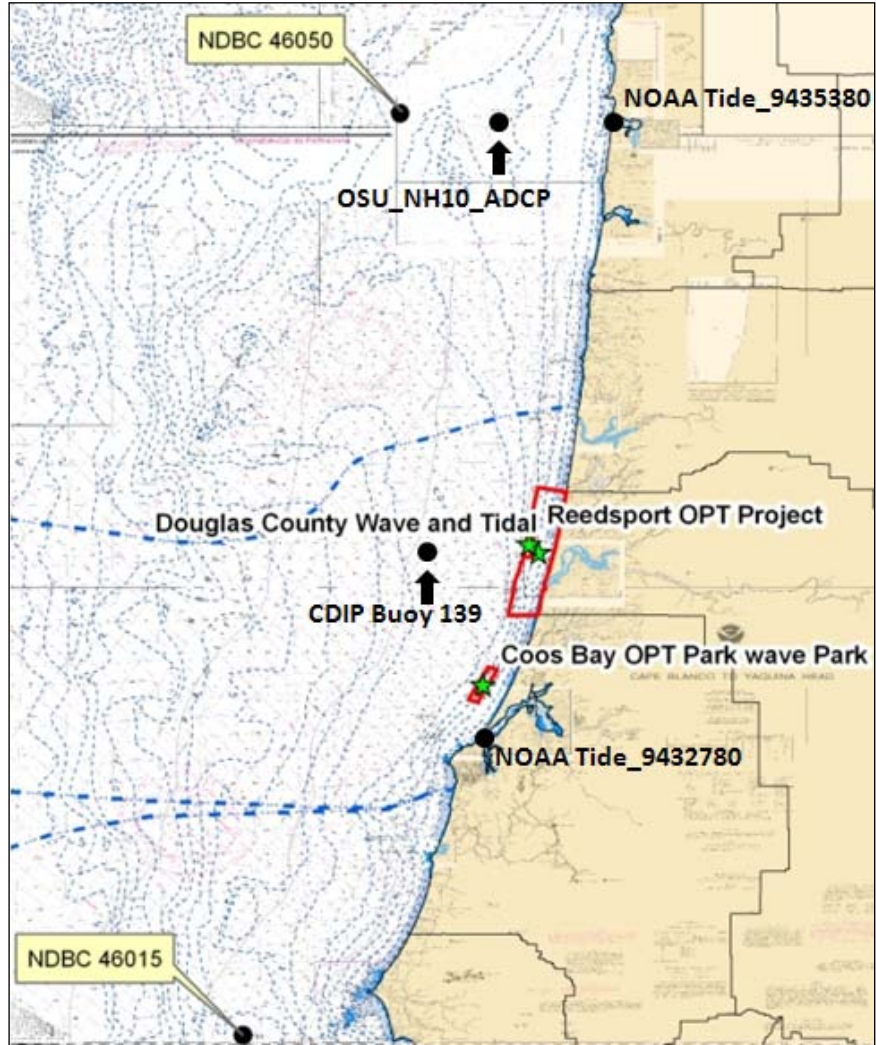

Figure 52 Southern FERC Permitted Sites with Buoy/Station Locations

4.8 Marine Protected Areas – Marine Sanctuaries

A query of the Marine Protected Areas Inventory (MPA Inventory) was made at the National Marine Protected Areas Center website (http://mpa.gov/helpful_resources/inventory.html). The MPA Inventory is a geospatial database that is designed to catalog and classify marine protected areas within U.S. waters. There were no established Marine Protected Areas within any of the FERC Permitted sites at the time this report was written (Figure 53).

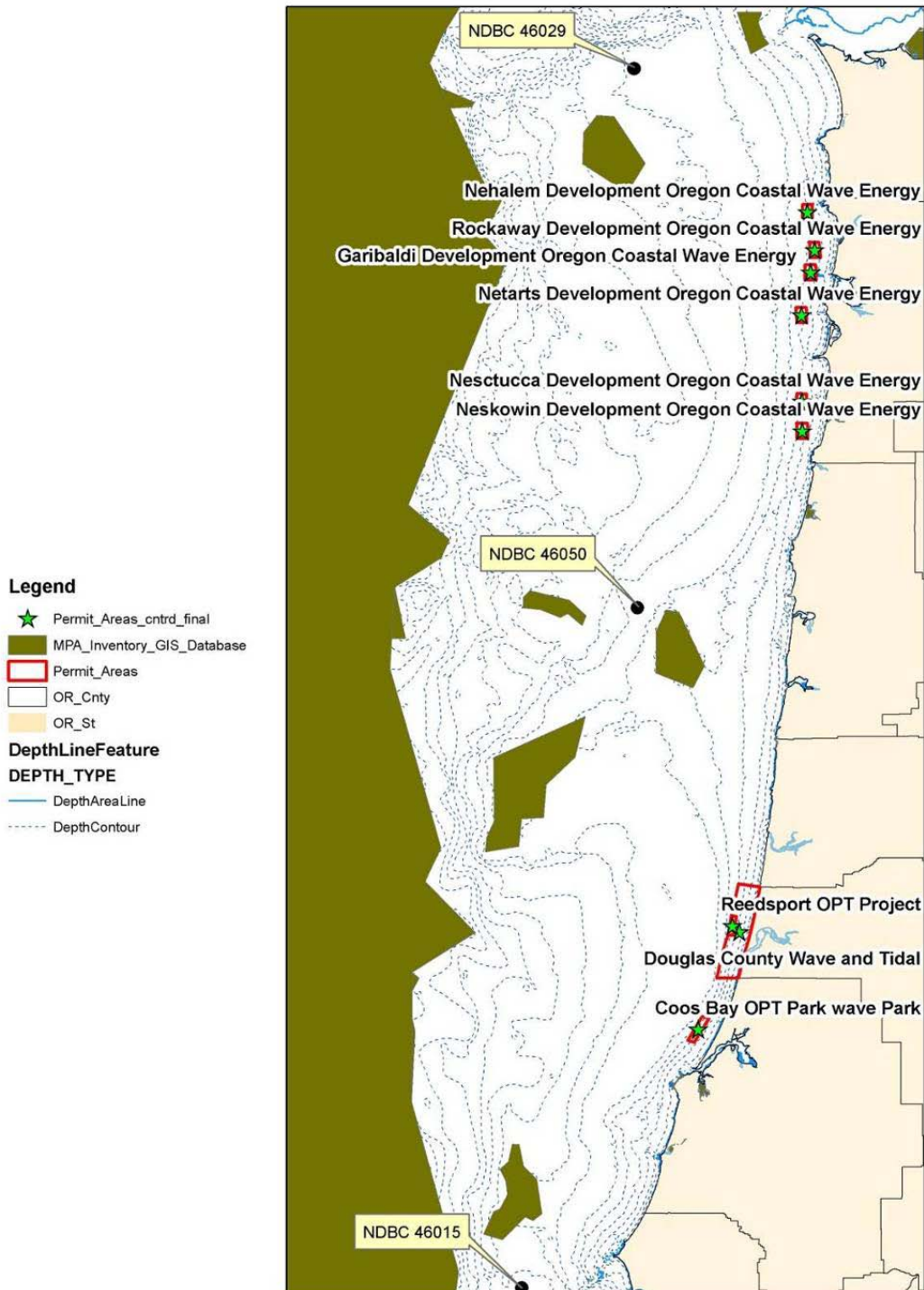

Figure 53 MPAs along Oregon Coast

4.9 Bathymetry and Sediment Maps

The bathymetry and sediments data within each FERC permitted sites along the coast of Oregon were investigated using two NOAA chart resources and their associated databases. The two resources available for this investigation were the NOAA Raster Navigational Chart and the NOAA Electronic Navigational Chart, both of these resources had information on bathymetry and sediments shown on the charts. Any additional information on bathymetry and sediments shown on the charts is maintained in an associated database for each chart by NOAA. This information is updated weekly and is available for public download at the website (<http://www.nauticalcharts.noaa.gov/staff/charts.htm#RNC>).

From the bathymetry data contained in the two NOAA chart resources and their associated databases, two maps were produced showing the bathymetry, one map for the six northern sites (Figure 54) and one map for the three southern sites (Figure 55). The sediment data contained in these resources was used to create maps showing the sediment data in relation to the FERC permitted sites. To preserve details on these images, three individual maps were created to represent the nine FERC permitted sites. The four most northern sites are grouped closely together and are represented as a single map (Figure 56). The two FERC permitted sites, Nescutta and Neskowin, are called out as the north-central FERC sites and represented as a separate map (Figure 57). The three FERC permitted sites in the southern portion of the Oregon Coast were grouped together in a single map (Figure 58).

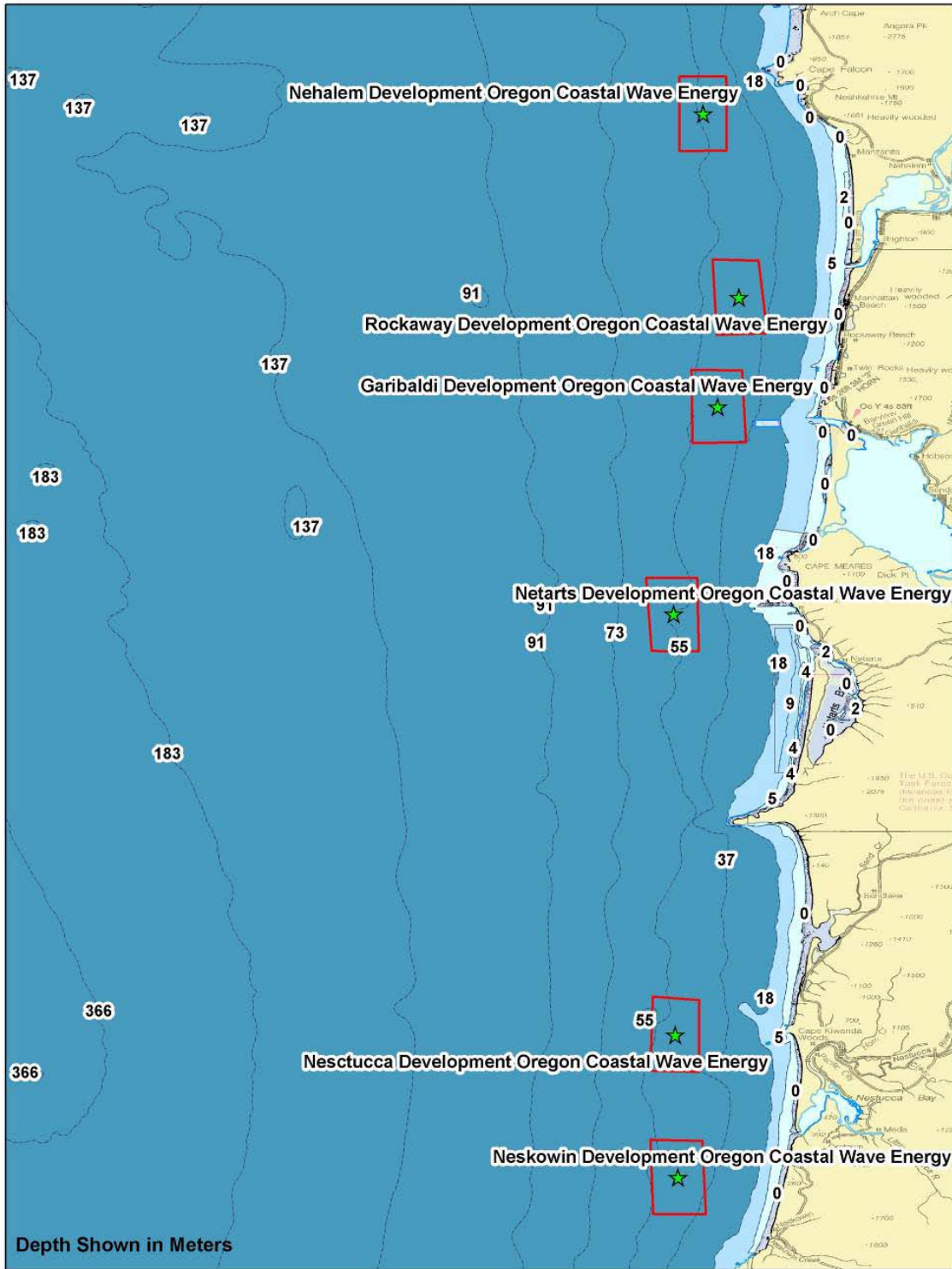

Figure 54 Bathymetry of Six Northern FERC Sites

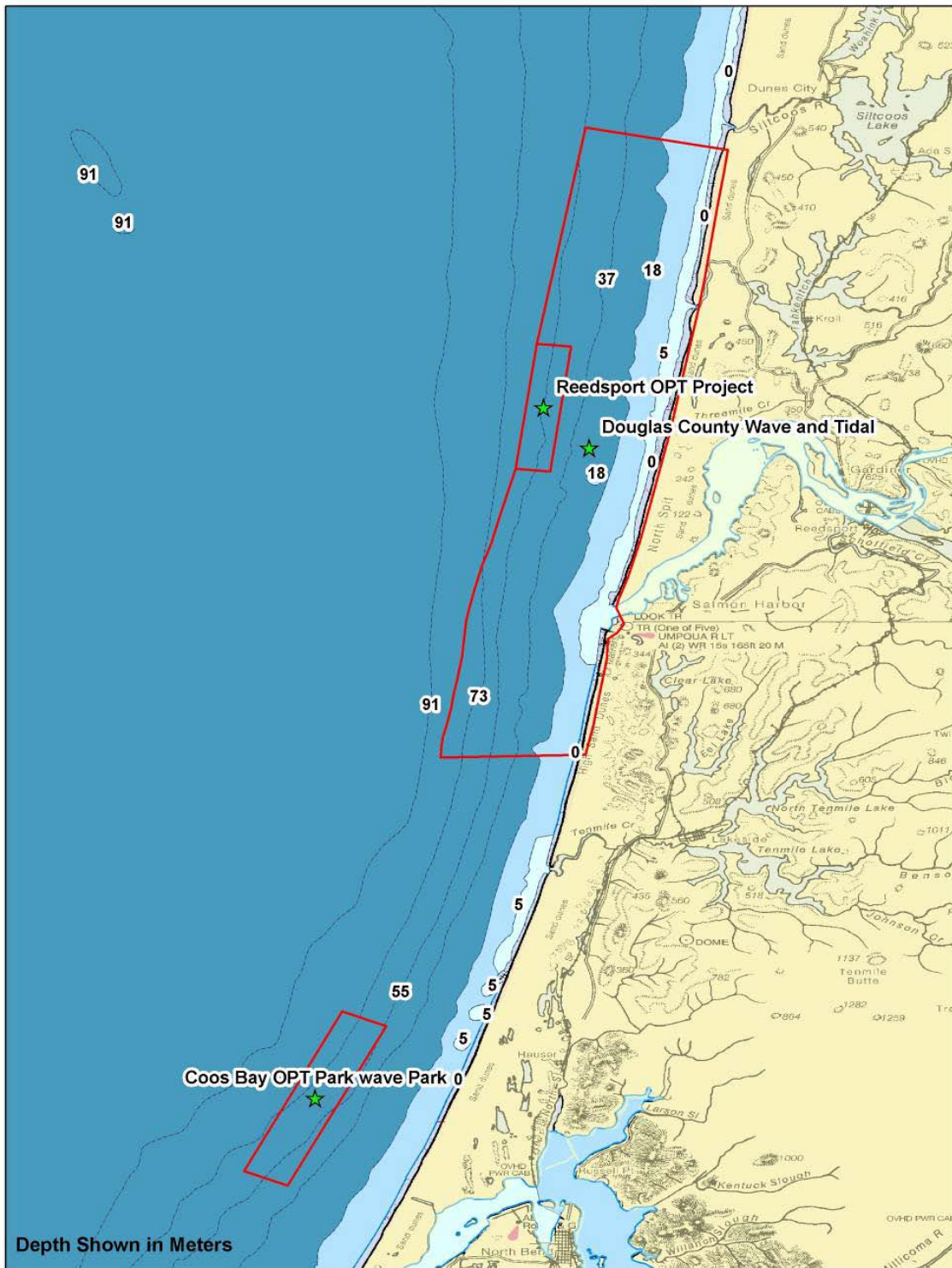

Figure 55 Bathymetry of Three South FERC Sites

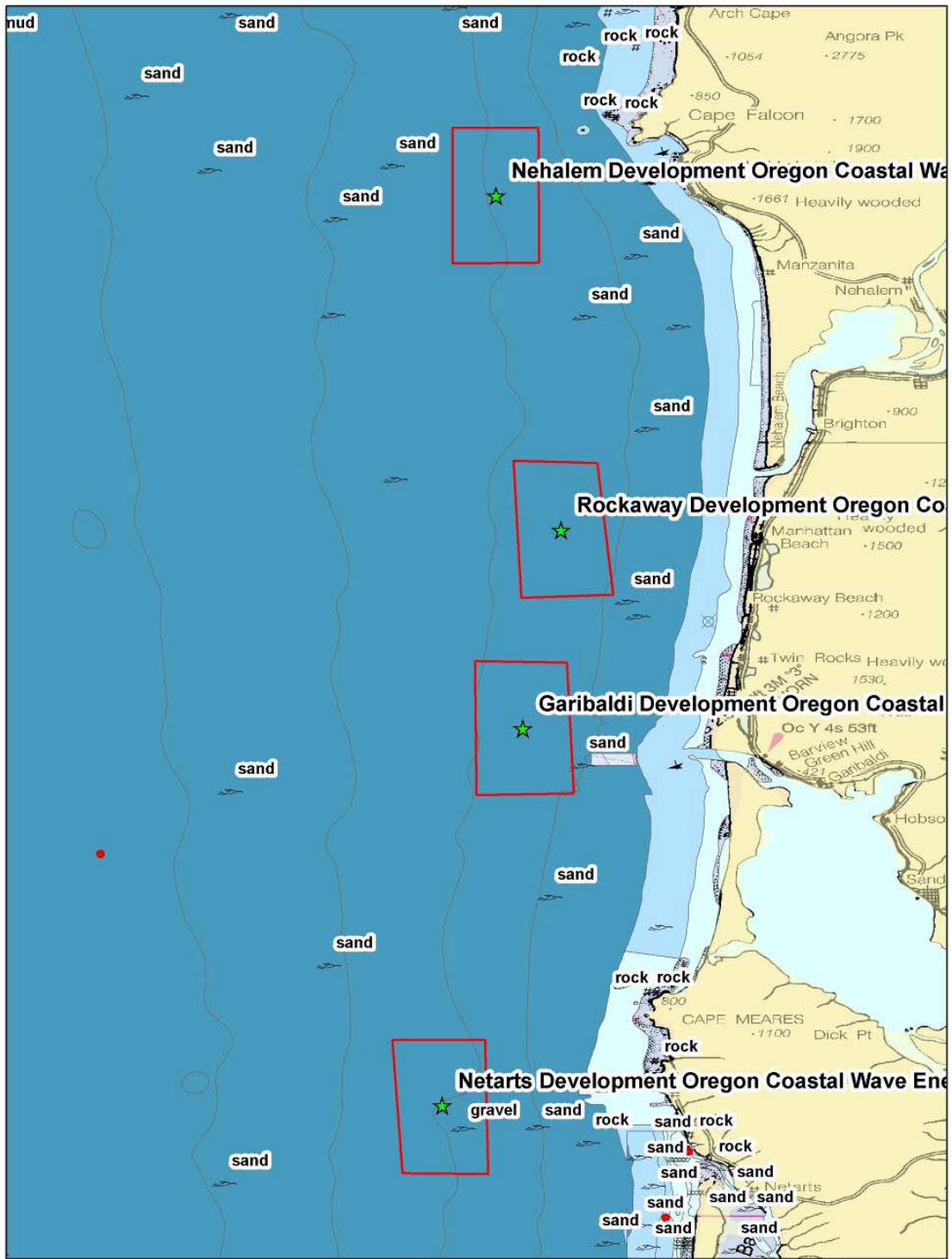

Figure 56 Sediment Types Inside and Near Four Northern FERC Sites

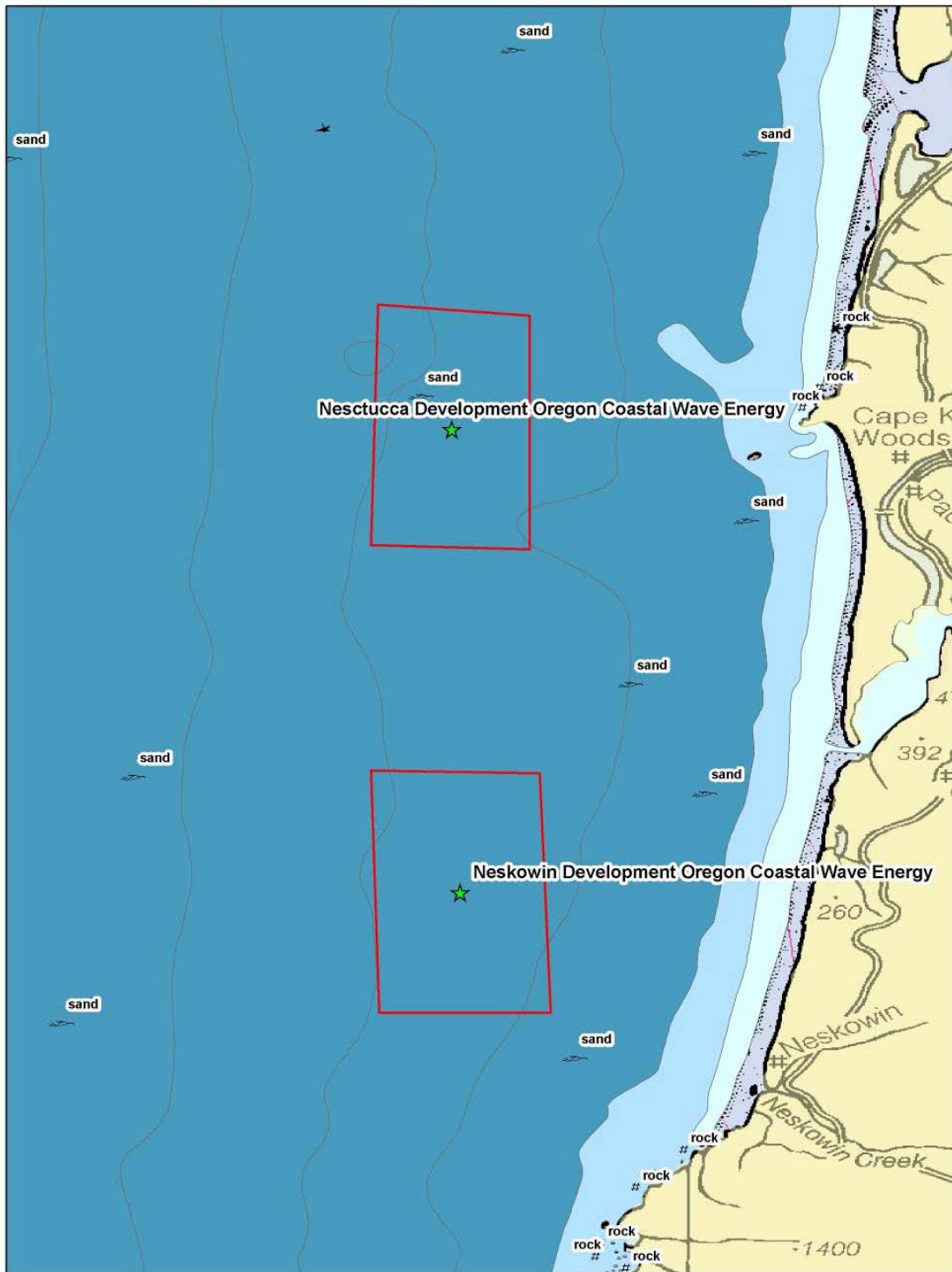

Figure 57 Sediment Types Inside and Near Two North-Central FERC Sites

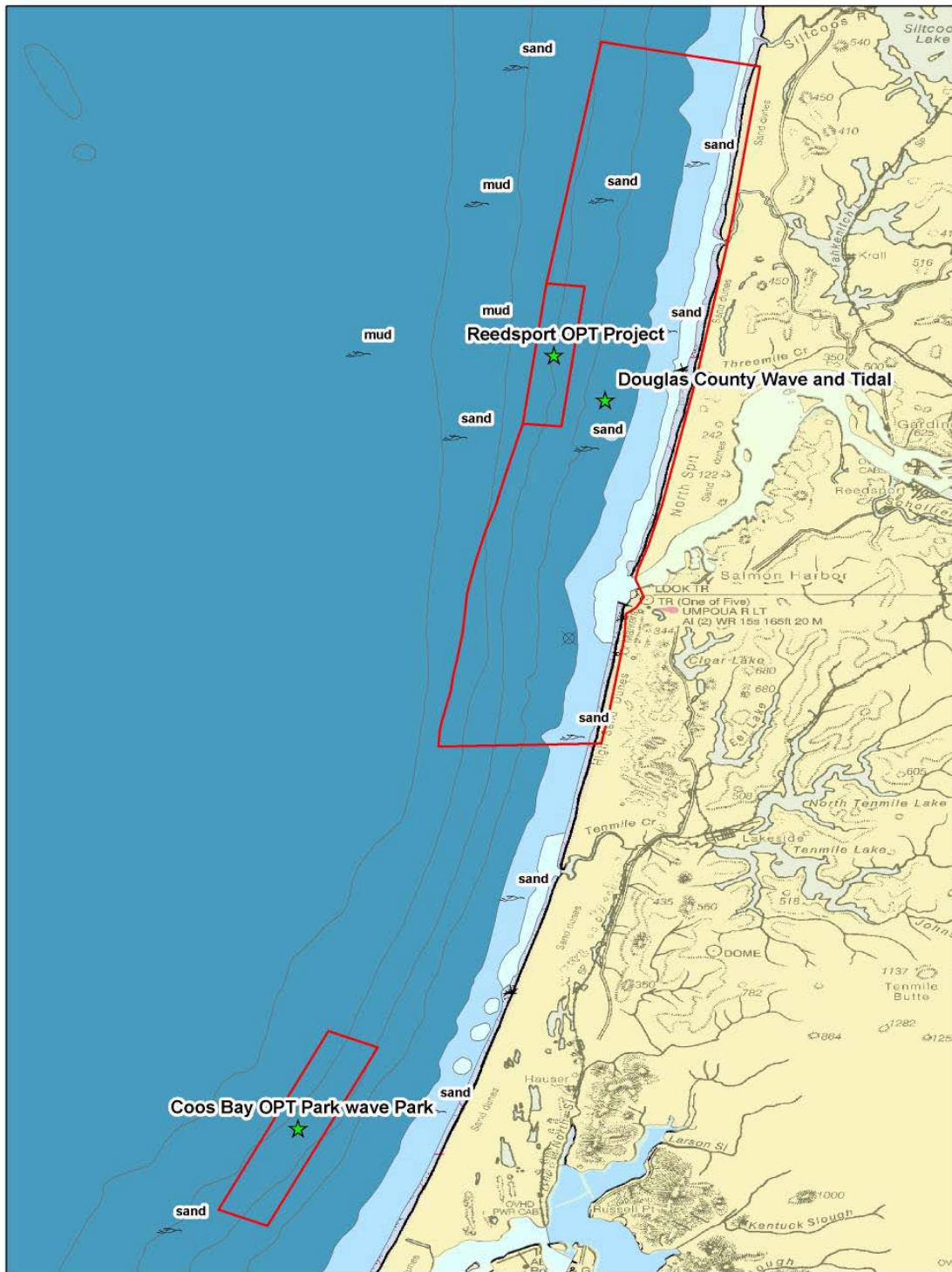

Figure 58 Sediment Types Inside and Near Three South FERC Sites

4.10 Geology

The nine permitted FERC sites are located on the continental shelf within a few miles of the Oregon coastline. A general summary of the geology of the continental shelf offshore Oregon is provided below. Further study is required to characterize geological/seafloor conditions at each FERC permitted site.

The Oregon continental shelf extends from the shoreline to the shelfbreak at the top of the continental slope, and is between approximately 10 and 50 miles wide. The seafloor gradient becomes fairly steep at the shelfbreak as the seafloor slopes down towards the Cascadia Subduction zone, where the Juan de Fuca Tectonic Plate is subducted beneath the North American Tectonic Plate. Based on available information, the FERC permitted sites appear to be in relatively shallow water (approximately 20-55 meters water depth), and several miles from the shelfbreak which occurs at a water depth of 200 meters.

The geology of the Oregon continental shelf is generally characterized by Quaternary and Tertiary sediments and sedimentary rocks at the seafloor down to water depths ranging from several hundred meters to approximately 6,000 meters (Gray and Kulm, 1985). Tertiary igneous basement rock underlies this sedimentary material (Snaveley et al, 1981; Gray and Kulm, 1985). The sediments/sedimentary rocks are composed of silts, siltstone, sands and sandstone with folding and faulting evident in some strata (Snaveley et al, 1981; Gray and Kulm, 1985). Some of these sediments were deposited by rivers both recently and during past lower sea level stands.

Although the seafloor on the continental shelf consists primarily of sedimentary material, there are areas of outcropping hard rock (such as basalt). Some of these areas are nearshore, subtidal rocky reefs such as Siletz Reef and Perpetua Reef. These reefs are environmentally protected areas and would provide poor anchoring conditions. Other areas of outcropping rock are prominent rocky, submarine banks such as Heceta Bank and Stonewall Bank which vary in size. These banks are environmentally sensitive areas and would also provide poor anchoring conditions. Detailed maps such as those contained in the Oregon State coastal database (see next section) should be reviewed to determine the extents of these areas of outcropping rock and their proximities to the FERC permitted sites.

Finally, there are additional seafloor features that help to define general geologic conditions on the Oregon continental shelf. These features include areas characterized by gravel, black sands containing heavy minerals, manganese nodules, wave cut benches, and gas hydrates⁷. These features are discussed in detail in some of the data sources presented in the next section.

Geology References:

Gray, J.J., and Kulm, L.D. (1985), "Mineral Resources Map, Offshore Oregon", Oregon Department of Geology and Mineral Industries Geological Map Series GMS-37, scale 1:500,000.

Snaveley, P.D., Jr., Wagner, H.C., Rau, W.W., Bukry, D. (1981), "Geologic Cross Section of the Southern Oregon Coast Range and Adjacent Continental Shelf", U.S. Geological Survey Open File Report 91-957, scale 1:125,000.

4.11 Geophysical, Hydrographic, Metocean, Geological, and Geotechnical Data Sources of the Oregon Coast.

The websites listed below include several that are typically checked during preparation of desktop studies in United States waters. The data available via these websites are typically regional in nature, covering rather large areas along the coast and farther offshore. The NOAA NGDC Coastal Relief Model CD-ROMs are especially important because they have the highest resolution of the regional data sets currently available (3 arc seconds or roughly 70-meter cell size). The proposed NOAA mapping program for the Oregon coast described below will provide the best source of bathymetry data for the proposed tidal energy projects when the data become available.

Other websites listed below contain data specific to Oregon only. These appear to have valuable information and links to additional websites. The Marine Geology links have detailed information at the proposed tidal energy project sites.

Table 26 provides a matrix of pertinent site characteristics for four counties where the nine FERC sites are located. The matrix lists sources of information that are provided in the websites provided below.

Table 26 Matrix of FERC sites

Sites	Bathymetry	Marine Geology	Seismicity	Geophysical	Geotechnical	Marine Habitats
Tillamook County (6 sites)	NOAA Tsunami Inundation DEM (1/3 arc-second) NOAA NGDC Bathy-Topo (~70 meters)	Dept. of Geology Map GMS-39 Dept. of Geology Mineral Resources Map	ANSS Data Extract	GLORIA Side Scan Sonar Mosaics (50 meter)	Ocean Drilling Program Core Data - Leg 146	Oregon St. University Habitat Info Map
Douglas County (2 sites)	NOAA Tsunami Inundation DEM (1/3 arc-second) NOAA NGDC Bathy-Topo (~70 meters)	Dept. of Geology Map GMS-39 Dept. of Geology Mineral Resources Map	ANSS Data Extract	GLORIA Side Scan Sonar Mosaics (50 meter)		Oregon St. University Habitat Info Map
Coos County (1 site)	NOAA Tsunami Inundation DEM (1/3 arc-second) NOAA NGDC Bathy-Topo (~70 meters)	Dept. of Geology Map GMS-39 Dept. of Geology Mineral Resources Map	ANSS Data Extract	GLORIA Side Scan Sonar Mosaics (50 meter)		Oregon St. University Habitat Info Map

NOTES: 1. An upcoming NOAA Multibeam bathymetry survey with a proposed resolution of 0.5 meters, and a proposed LIDAR survey of the Oregon Coast should provide high resolution data at many of the proposed FERC Sites.

2. Data resolution shown in parenthesis where applicable

3. Other geophysical data are available for the sites, but these data need to be downloaded and reviewed to determine if they are applicable to these sites.

LEGEND:

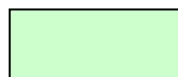

This type of data is available at these sites

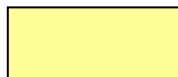

This type of data is available in areas close to these sites



This type of data is not available for these sites

4.11.1 Oregon Bathymetry:

- USGS Coastal and Marine InfoBank Atlas: Oregon Bathymetry:
<http://walrus.wr.usgs.gov/infobank/gazette/html/bathymetry/or.html>
- NOAA National Geophysical Data Center (NGDC) Tsunami Inundation Gridding Project. Hi res bathy-topo along Oregon coast:
<http://www.ngdc.noaa.gov/dem/showdem.jsp?dem=Central%20Oregon%20Coast&state=OR&cell=1/3%20arc-second>
- Also:
http://www.ngdc.noaa.gov/mgg/inundation/tsunami/data/central_oregon_coast_or/central_oregon_coast_or.pdf
- NOAA NGDC National Ocean Service (NOS) Hydrographic Data Base. Good starting point for available digital data offshore Oregon.
http://map.ngdc.noaa.gov/website/mgg/nos_hydro/viewer.htm
- NOAA NGDC Coastal Relief Models: Hi res (3 arc second) bathy-topo along entire Oregon coast on two CD's.
Volume 7 – US Central Pacific Coast, \$25.00
Volume 8 – US NW Pacific Coast, \$25.00
<http://www.ngdc.noaa.gov/mgg/fliers/03mgg01.html>
- Older USGS Bathy for Oregon EEZ (Exclusive Economic Zone) included with CA and WA bathy:
<http://coastalmap.marine.usgs.gov/GISdata/regional/westcoast/bathymetry/caorwall.htm>
- ***Upcoming Mapping Surveys: Fugro -Pelagos will be surveying for NOAA in southern Oregon; David Evans and Associates along with OSU will survey the remaining coast area.
<http://oregonstate.edu/ua/ncs/archives/2009/aug/new-funds-will-help-create-oregon%E2%80%99s-most-accurate-seafloor-mapping-system>
- Oregon Margin Survey (MBARI):
<http://www.mbari.org/data/mapping/margin/default.htm>
- Oregon Dept. of Geology and Mineral Industries LIDAR data along Oregon Coast:
<http://www.oregongeology.org/sub/pub&data/summaries/exsum-OFR-O-05-09.pdf>
- Scripps Institution of Oceanography (SIO) Explorer: Data archive from SIO research cruises providing access to many types of shipboard data (multibeam, seismic, metocean, etc.). This website is run through the San Diego Supercomputer Center (SDSC) on the campus of UC San Diego:
<http://nsdl.sdsc.edu/resources.html>

4.11.2 Marine Geology:

- Oregon Department of Geology Geologic Map Series (GMS), No. 39 (GMS-39): Contains an index map and geologic bibliography for references on marine geology offshore Oregon. This appears to be very useful to track down numerous references on marine geology along the Oregon Coast. GMS-39 can be purchased for \$6 here:
<http://www.naturenw.org/cgi-bin/quikstore.pl?store=maps&product=000242>

- Mineral Resources Map – offshore Oregon (link to PDF):
http://www.oregongeology.org/sub/publications/GMS/gms037.pdf?bcsi_scan_2F3BDF9A6A8A1138=0&bcsi_scan_filename=gms037.pdf

4.11.3 Seismicity:

- Perform an extract from the Advanced National Seismic System using lat/lon of areas of interest for earthquake epicenters and magnitudes:
<http://www.ncedc.org/anss/>

4.11.4 Geophysical:

- GLORIA Sidescan Sonar mosaics for seafloor feature interpretation:
http://coastalmap.marine.usgs.gov/regional/contusa/westcoast/pacificcoast/GLORIA_images.html
- USGS Seismic Reflection Data – Nat'l Archive of Marine Seismic Surveys:
http://walrus.wr.usgs.gov/NAMSS/data_access.html
- Fugro Survey data available via the Fugro Offshore Survey Division Intranet

4.11.5 Geotechnical:

- Ocean Drilling Program (ODP) core data is helpful for regional seafloor information. Several borings have been drilled offshore Oregon. Here are links to information about those borings:
http://www-odp.tamu.edu/publications/204_SR/204TOC.HTM
http://www-odp.tamu.edu/publications/146_1_SR/146_1TOC.HTM

4.11.6 Oregon Coast Geohazards:

- Oregon Department of geology:
<http://www.oregongeology.org/sub/earthquakes/Coastal/CoastalHazardsMain.htm>
- Gas Hydrates:
http://www.netl.doe.gov/publications/proceedings/02/MethaneHydrate/Trehu_Abstract.pdf

4.11.7 Metocean:

- National Data Buoy Center of NOAA, archived and real-time meteorological and oceanographic data from buoys:
<http://www.ndbc.noaa.gov/>
- California Data Information Program, archived and real-time wave measurements from wave buoys:
<http://www.cdip.ucsd.edu/>
- The Oregon Coastal Ocean Current Mapping Lab, ADCP data and CODAR data used to produce maps of surface currents and currents at depth.
<http://www.bragg.oce.orst.edu/>

4.11.8 General Information:

- Oregon Geospatial Enterprise Office (GEO) – Geospatial Data Clearinghouse:
<http://www.oregon.gov/DAS/EISPD/GEO/sdlibrary.shtml>

- Oregon Department of Geology and Mineral Industries:
<http://www.oregongeology.org/sub/default.htm>
- NOAA Nautical Charts:
<http://www.nauticalcharts.noaa.gov/>
- Oregon State database for coastal Oregon information (Chris Goldfinger):
<http://pacoos.coas.oregonstate.edu/MarineHabitatViewer/viewer.aspx>
- Oregon State Oregon Explorer: Natural Resources Digital Library:
<http://oregonexplorer.info/>
- Pacific Coast Marine Habitat Program:
<http://marinehabitat.psmfc.org/documents-links.html>
- Bathymetry Data sources:
http://marinehabitat.psmfc.org/files/source_docs/OR-WAGeo-HabMaps.pdf

5.0 INSTALLATION ASSETS AND CONSIDERATIONS

5.1 Introduction

Important WEC business drivers are the availability and cost of installation equipment such as tugs, barges and handling equipment on the Pacific coast and the available infrastructure on the Oregon coast. This section is limited to installation equipment due to the available time frame for this effort; however, OWET has funded the Advanced Research Corporation (ARC), Newport, OR to assess the infrastructure capabilities of the Oregon Coast. This information should be of significant benefit to all those considering employment of a WEC off the coast of Oregon.

General descriptions of the various craft required to tow and install WEC devices and approximate costs of operation are provided. Most of the support vessel contractors do not have a set price structure for the various pieces of equipment so it is not possible to provide WEC specific towing and installation cost. Pricing for each job is dependent on the specific job requirements such as length of job, risk of job, location of job, operating requirements, manning, rigging and insurances required, etc. Each job price is based upon a mutually agreeable contract that spells out services to be provided and responsibilities of both parties. Most companies will quote specific job prices based on detailed work requirements. The near shore location of most WEC sites introduces a further complication to estimating cost. The potential for mechanical failures when operating close to the beach can result in higher insurance costs and limit the types of assets approved for operation in this environment.

5.2 Installation Assets

5.2.1 Tugs

The tugboat has a number of functions ranging from towing, salvage and anchor handling/positioning. Tug characteristics may have a superficial resemblance to each other but when operating offshore the tug equipment is over-built or heavy duty by conventional harbor standards. They range in size (and power) depending on the tasks that they required to perform. The US Coast Guard has guidelines for vessels used in inland, coastwise and ocean operation. The Certificate of Inspection (COI) as well as insurance companies will determine the area of operation more often than their owners or operators.

5.2.1.1 Coastwise Tugs

Profitable coastwise towage consists of moving the greatest amount of product in a single hull. As the size of barges increase, the size of coastwise tugs remains within the 110 - 140 foot range. Horsepower ranges from 2000 to 9000. With some exceptions, coastwise tugs (Figure 59) are generally too cumbersome for daily harbor use. There are specialized tugs used for very heavy towing with up



Figure 59 Coastwise Tug

to 22,000 HP but that capability will not be required for WEC devices.

There are no hard fast rules governing the size of the barge that may be towed in relation to the horsepower of a given tug. There are too many variable factors affecting this, i.e., weather, hull shape, object towed, experience of personnel aboard.

5.2.1.2 Anchoring Handling Tugs (AHT)

The petroleum industry requires large anchors and vessels capable of setting anchors. The AHT (Figure 60) is generally built for this operation. These uniquely designed vessels have dimensions running from 130 – 210 feet and have upwards to 10,000 hp. An AHT can handle anchors used in water depth up to 2,000 feet of water. Their stern taffrail is of concave construction, which allows an anchor and its chain to run freely over the stern roller. During deployment of the ground tackle, the AHT then runs on a bearing to the back to the vessel it is mooring.



Figure 60 Anchor Handling Tug

Currently there is only one AHT on the West Coast and she is on a long term contract with a petroleum company.

5.2.1.3 Supply Vessels

Supply vessels (Figure 61) were originally designed and constructed in the Gulf of Mexico (GOM) to support the petroleum industry by transporting cargo to the rigs. All have a raised forecastle head bow with all superstructures well forward, leaving a large, long, open stern. Their sizes run to 225 feet with up to 12,000 hp. Some are fitted with winches, bow and stern thrusters, and capable of dynamic positioning.



Figure 61 Offshore Supply Vessel

5.2.1.4 General Purpose Support Vessel

There is often need for support vessels that can perform a multitude of functions such as crew or passenger transport, dive support, moderate towing and supply. The vessel in Figure 62 is a good example of a general purpose vessel and it is available out of Coos Bay, OR. It has 450 hp, a 22x34 ft deck area, a knuckle boom crane (not shown), A-Frame boom and winches for performing a multitude of tasks.



Figure 62 Miss Linda– General Purpose Support

(www.MisslindaChartersAndTours.com)

5.2.2 Barges

Some WEC devices are quite large and may require large flat deck or specialized semi-submersible barges to transport them long distances to the installation site.

5.2.2.1 Flat Deck Barge

Flat deck barges are available in many sizes capable of transporting most WEC devices (Figure 63). Example sizes are shown in Figure 64. General Construction Company is located in Seattle, WA and McDonough Marine has offices on the Gulf Coast.



Figure 63 Flat Barge with WEC-Sized device

GENERAL CONSTRUCTION COMPANY

ILITIES PROJECTS CAREERS CONTACT US

Equipment Fleet

The work we perform requires a commitment to specialized equipment and we own one of the largest marine construction fleets in the world today.

Flat Deck Barges
Click the equipment name to view the data sheet.

Name	Type	Size	Quantity
GC 200 Series	Flat Deck Barge	210' x 54' x 14'	1
GC 190 Series	Flat Deck Barge	190' x 44' x 14'	2
GC 180 Series	Flat Deck Barge	180' x 45' x 12'	5
GC 170 Series	Flat Deck Barge	170' x 50' x 11.5'	2
GC 100 Series	Flat Deck Barge	164' x 50' x 10.7'	4
GC 120 Series	Flat Deck Barge	160' x 50.5' x 13.5'	2
GC 160 Series	Flat Deck Barge	160' x 4' x 10'	1
GC 150 Series	Flat Deck Barge	150' x 42' x 10'	5
GC 40 Series	Flat Deck Barge	110' x 35' x 8'	2
GC 30 Series	Flat Deck Barge	110' x 34' x 8'	9
GC 20 Series	Flat Deck Barge	110' x 30' x 8'	3

http://www.mcdonoughmarine.com/ocean_marmac400.htm

MM View Home Page

Company Overview Inland Barges Ocean Barges

Heavy Deck Load Barges

Size	Barge Type	Deck Load Capacity
140' x 40' x 9'	ABS ocean deck	3000 lbs/sq ft
140' x 45' x 9'	inland spud	3000 lbs/sq ft
180' x 54' x 12'6"	ABS ocean deck	2000 lbs/sq ft
180' x 60' x 12'6"	ABS ocean deck	3000 lbs/sq ft
195' x 35' x 10'6"	Inland deck	2500 lbs/sq ft
200' x 50' x 13'	ABS ocean deck	4500 lbs/sq ft
250' x 54' x 11'	inland deck	2000 lbs/sq ft
250' x 54' x 11'	inland deck	6000 lbs/sq ft
250' x 72' x 16'	ABS ocean deck	4500 lbs/sq ft
260' x 72' x 16'	ABS ocean deck	4500 lbs/sq ft
300' x 100' x 19'9"	ABS ocean deck	4500 lbs/sq ft
318' x 96' x 20'	ABS ocean deck	3000 lbs/sq ft
400' x 99'9" x 20'	ABS ocean deck	4500 lbs/sq ft

http://www.mcdonoughmarine.com/ocean_marmac400.htm

Figure 64 Example Flat barges

5.2.2.2 Semi-submersible Barges

This is an ocean-going vessel designed to transport large, heavy equipment over long distances. They are built with ship-shaped bows and an integral ballasting system to allow cargo to be lifted, skidded or rolled on and off the deck. The operational process is illustrated in Figure 65.

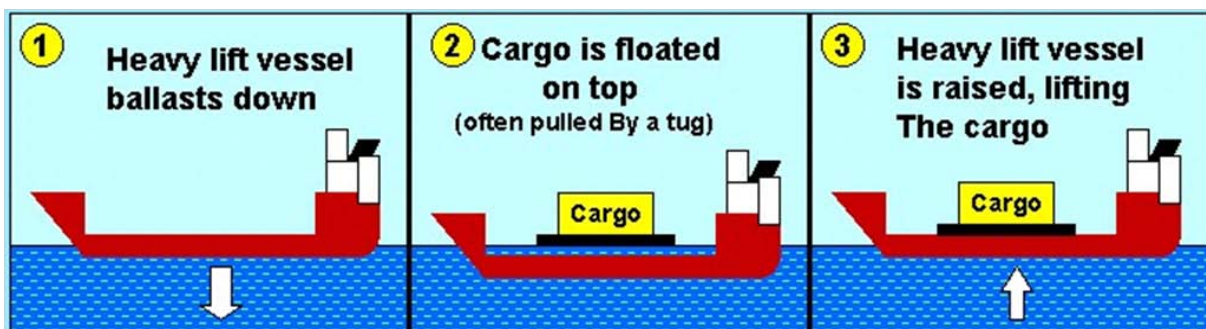

Figure 65 Operations (<http://www.geocities.com/uksteve.geo/heavylift.html>)

A dramatic example demonstrating the use of a semi-submersible barge is shown by Figure 66, where the *USS Cole* is being transported home from Yemen for repair. Figure 67 shows a Smit Marine semi-submersible barge. Details of this and other barges and heavy lift equipment can be found on the website inserted in the picture.



Figure 66 Semi-submersible Barge with USS Cole



Figure 67 Smit Marine Semi-submersible Barge

Seabridge Marine Services located in Vancouver, B.C., provides a variety of semi-submersible barges (Figure 68). Visit their website listed in Figure 63 for a more complete description of the barges. These barges are offered for bareboat charter or on a turnkey project basis. Barges are available worldwide but the availability on the West coast of North America is intermittent

	<p>Seabridge Marine Services Limited 305 – 1549 Marine Drive West Vancouver, B.C, Canada V7V 1H9 Tel: (604) 925-2601 Fax: (604) 648-8121 Email: services@seabridgemarine.com</p>
<p>“BOABARGE 9”</p>	
<p>TYPE : OCEAN-GOING, HEAVYLIFT DECK BARGE, SUBMERSIBLE FLAG : CAYMAN ISLANDS BUILT : MITSUBISHI, JAPAN 1976 CLASSIFICATION : DET NORSKE VERITAS LENGTH, OVERALL : 122.45M (401 FT., 9 IN.) LENGTH, LOADLINE : 119.95M (393 FT. 6IN.) BREADTH, MOULDED : 30.50M (100 FT, 1 IN.) DEPTH, MOULDED : 7.60M (24 FT, 11 IN.) DRAFT, LOADLINE : 6.21M (20 FT. 4 IN.) DECK PLATE : 19MM DECK CARGO AREA : 3,437SQ.M. (37,000 SP.FT.) GROSS TONNAGE : 6,950 (As per International Tonnage Convention 1969) NET TONNAGE : 2,085 (As per International Tonnage Convention 1969) DEADWEIGHT : 15,550MT (17,144ST) LIGHTSHIP WEIGHT : 3,490MT (3,848ST) DECKPLATE : 22MM WINDLASS : DIESEL HYDRAULIC SINGLE WILDCAT WITH GYPSY HEAD ANCHOR : 3,485KG (7,800 LBS) STOCKLESS WITH 270M OF 2-3/16 IN. DIAMETER CHAIN GENERATOR (AUX) : ONE (1) 450V X 50KVA 1,200 RPM TAIYO ELEC. BY YANMAR DIESEL 70PS X 1,200 RPM SUBMERGING AND BALLASTING SYSTEM : MAXIMUM SUBMERGENCE DEPTH 15.24M (50 FT.) COMPLETE REMOTE CONTROLLED SYSTEM BALLAST PUMPS : TWO (2) DIESEL DRIVEN CENTRIFUGAL @ 1,500 CU.M./HR (TOTAL 3,000 CU.M./HR) ADDITIONAL FEATURES : FLUSH DECK WITH RECESSED MANHOLES AND CHOCKS : HYDRALIFT SKEGS FOR DIRECTIONAL STABILITY, POWER, AND FUEL SAVINGS</p>	

Figure 68 Example Seabridge Semi-submersible Marine Barge (<http://www.seabridgemarine.com/services/marine-services.htm>)

5.2.3 Floating Cranes

Floating cranes/crane barges are available in various sizes with a range of capabilities. They are not inexpensive and their use is sensitive to the environment and proximity to shore. These cranes are not self powered thus costs must include the cost of a tug for towing and possibly a second tug for maneuvering and mooring once on station. Example costs are provided later in this section. Figure 69 and Table 27 provide example details.

GENERAL CONSTRUCTION COMPANY	D.B. PACIFIC 180 TON FLOATING CRANE
CAPABILITIES <ul style="list-style-type: none">■ Piledriving■ Heavy Lifting■ Duty Cycle – Dredging■ Offshore Construction & Service■ Pipe Lay	SPECIFICATIONS <ul style="list-style-type: none">■ Main Crane: American M-25A■ Capacities: 180 tons @ 44' radius fully revolving 42 tons @ 130' radius fully revolving■ Boom: 120' to main fall (200' available) 126' to whip line (206' available)■ Barge Size: 250' x 72' x 15'■ Classification: ABS+A1, USCG■ Draft (std.): 7'-0"■ Spuds: Not available■ Anchors: 6-point moorage■ Deck Loading: 1,800 psf uniformly distributed■ Bunkers: 35,000 gallons diesel fuel 3,000 gallons fresh water
	

Figure 69 Example floating crane - DB Pacific

Table 27 Floating Crane Inventory from General Construction (not all cranes will be suited to offshore use)

 GENERAL CONSTRUCTION COMPANY			
Name	Type	Capacity	Size
D.B. General	Floating Crane	700 Ton	300' x 100' x 18'
D.B. Los Angeles	Floating Crane	300 Ton	210' x 68' x 15'
D.B. Bremerton	Floating Crane	190 Ton	140' x 70' x 12.5'
D.B. Pacific	Floating Crane	180 Ton	250' x 72' x 15'
D.B. Seattle	Floating Crane	165 Ton	150' x 70' x 12.5'
D.B. Vancouver	Floating Crane	140 Ton	210' x 60' x 13.5'
D.B. Columbia	Floating Crane	133 Ton	142' x 58' x 12'
D.B. Alameda	Floating Crane	100 Ton	142' x 58' x 12'
D.B. Olympia	Floating Crane	100 Ton	150' x 60' x 10'
D.B. Beaver	Floating Crane	97 Ton	116' x 52' x 10'
D.B. Portland	Floating Crane	85 Ton	116' x 52' x 10'
D.B. Anchorage	Floating Crane	75 Ton	120' x 50' x 9'
D.B. Oakland	Floating Crane	60 Ton	140' x 70' x 12.5'
D.B. Tacoma	Floating Crane	37 Ton	150' x 44' x 10'

The marine service transportation companies in Table 28 assisted in providing information for floating cranes, tugs, load line deck barges and support craft. They could support operations in Oregon at the FERC sites but transit distances should be a consideration in vessel selection.

Table 28 Marine Service Companies

Company	Location	Contact	Phone	Support Vessels	Email	Website
General Construction Co	Seattle WA	Ken Preston	206/938-6755	Tugs, crane barges	ken.preston@kiwit.com	http://www.generalconstructionco.com
West Coast Contractors	Coos Bay OR	Tim Smith	541/267-7689	Marine construction	tsmith@westcoastcontractors.com	http://www.westerntowboat.com/Barges/default
Sause Brothers	Coos Bay OR	John Lemos	541/269-5841	Tugs, crane barges & shipyard	johnl@sause.com	http://www.sause.com/id5.html
Maritime Logistics	Morro Bay CA	Frank Loving	805/431-7393	R/V & Tug	kayak38@aol.com	http://www.fedvendor.com/contractor/PRO00000000P0356324/profile.htm
Miss Linda Charters	Coos Bay OR	Bob Pedro	541/888-2128	R/V work boat	misslindacharters@gmail.com	www.MissLindaChartersAndTours.com
Caicos Corp	Port Gamble	David Berry	360/2975636	Marine construction	david@caicoscorp.com	http://www.caicoscorp.com/
Foss Maritime	Seattle	Spencer Ogrady	206/281-3754	Tugs, barges	ogradey@foss.com	http://www.foss.com/services_towing.html
Western Towboat	Seattle	Ric Shrewsbury	206/789-9000	Tugs, barges & shipyard	ric@westerntowboat.com	http://www.westerntowboat.com/Barges/default.aspx

5.3 Installation Planning

5.3.1 Cost factors

Detailed installation planning is a key to a successful operation. There are so many variables in this type of an operation and it differs from normal operational experience. Control of cost requires careful preparation by experienced offshore engineers and constructors, precise installation coordination and some luck, primarily because weather and sea conditions are always an issue and each WEC device installation will be novel until the technology advances to the commercial stage. The equipment you select for installation must match the task and that is best determined by those with years of experience working offshore. Basically there are no shortcuts to ensuring a successful operation. Before any cost estimates for vessel support can be provided many of the questions in Table 29 & Table 30 need to be addressed.

Table 29 Installation Costs Factors A

Factor	Note
Location	Geographic location of installation site
	Distance from shore
	Distance from nearest suitable ports for preparation, maintenance, support
	Distance from fabrication yard
Time	Anticipated length of the project
	Installation season (winter, spring, etc)
	Daytime or 24 hr installation
	Scheduling flexibility
WEC Characteristics	Weight, dimensions, configuration
	Specific handling requirements, limitations
Cabling	Types and sizes of cable
	Trunk cable (burial?)
	Shore cable installation (HDD?)
Mooring	Mooring configuration (single or multi-point)
	Anchor type and size
	Cable types, lengths and sizes
	Buoys (surface, subsurface?)
Vessels	What size deck area required to deploy WEC
	Will WEC be towed or deck mounted
	Crane requirements (WEC and/or mooring installation)
	Electrical and/or hydraulic power requirements for the vessel?
	In the selection of the vessels, is the registry, Jones Act, an issue?
	Anchor handling tug required
	Line haul tug(s) requirements
	Pusher boats/tugs required for barge positioning/anchor hauling
Vessels-Stand by vessel to monitor WEC after installation (2-5 days)	

Table 30 Installation Cost Factors B

Installation	Will the installation require diving and/or other support requirements?
	If the divers operating in depths over 100 ft, a decompression chamber is required
	Navigation-positioning requirements for the WEC installation
	Prevailing site conditions
	Any unique positioning requirements
	Maximum suitable conditions for installation of WEC, mooring, cabling
	Are auxiliary sensor systems, i.e., bottom mounted acoustic wave and current sensor(s), AWAC/ADCP, going to be required for the installation of WEC?
	Anchor proof testing required?
	Environmental (marine mammal observers, anchor drag, transformers, cable EMF)
	Any unique safety requirements
Site	Range of water depths at site
	Bottom conditions for vessel anchoring
	Distance from the mobilization-safe refuge port
	Any bottom obstructions at the site or along cable route
Crew	Size of the crew to prepare WEC
	Size of deck crew for installation
	Size of crew for cabling installations
Logistics	Room and Board
	Ground transportation
	Crew boat
	Emergency evacuation considerations

5.3.2 Vessel Cost

5.3.2.1 Floating Crane

General Construction Company, Seattle, provided a day-rate cost estimate for their 300 ton floating crane, *DB Los Angeles*. Table 31 does not include preparing the crane for transit (shorting the crane boom for operating in greater than sea state one conditions, re-reeve the crane/winch wires) and then transiting to Portland. After arriving in Portland the crane has to be mobilized to install the WEC device. At job completion the entire process has to be reversed to transit back to Seattle. The base cost for mob, de-mob and transit to/from Seattle is approximately a quarter of a million dollars.

The day rate for the *DB Los Angeles* adds \$57K per day plus the cost of on-site vessel support, WEC personnel, navigation, diving as required, etc. as identified in Table 31. Careful planning to account for potential weather losses and to enable segmented and reversible installation steps is a must to control cost if installation requires this type of asset.

Table 31 Estimated Cost for *DB Los Angeles* to Deploy WEC Device

Support Crews	Rate	Hours	Total
Harbor Crew			
DB Los Angeles	\$1,700.00	10	\$17,000.00
Superintendent	\$100.00	10	\$ 1,000.00
Field Engineer	\$75.00	10	\$ 750.00
5 Man Crew	\$382.00	10	\$ 3,820.00
Subsistence/man-day	\$200.00	7	\$ 1,400.00
		TOTAL	\$23,970.00
Offshore Crew			
DB Los Angeles	\$1,700.00	24	\$40,800.00
Superintendent	\$100.00	14	\$ 1,400.00
Field Engineer	\$75.00	14	\$ 1,050.00
5 Man Crew	\$490.00	24	\$11,760.00
Subsistence/man-day	\$200.00	12	\$ 2,400.00
		TOTAL	\$57,410.00

5.3.2.1 Ocean Tugs, Barges, Support Vessels

The information in Table 32 was derived from Oct. 09 *WorkBoat survey* of 32 offshore service vessel companies and from various contacts listed in Table 28. The availability of vessels on the West coast is somewhat limited due to limited offshore activity thus costs may be higher. Note that tug rates are either provided on an hourly or daily rate with or without fuel costs. The crewboats, deck barges, and tugs in are all West Coast vessels.

Table 32 Offshore Rates of Various Vessels

Vessel Type	Average Rate - 2009
AHT	65.4 K\$/day
Supply	
<200 feet	4. -5 K\$/day
>200 feet	10.1 K\$/day
Crewboats	
<125 feet	2.9 K\$/day
>125 feet	4.8 K\$/day
Deck Barges: 6,500 tons capacity	1.5-2.0 K\$/day
Tug	
3000 hp	5.5 K\$/day plus fuel (2.6 K\$/day @ 8 kts)
2,000, 3,000, 4,000 or 5,700 hp	\$300-\$600/hr

An important consideration and one that can influence cost is the **Jones Act** (Merchant Marine Act of 1920) (P.L. 66-261) is a United States Federal statute that regulates maritime commerce in U.S. waters and between U.S. ports. Essentially, the Jones Act states that no foreign flag vessels can support WEC installation in coastal waters.

5.3.3 Oregon ports

There are more than a dozen ports along the Oregon coast but only a few, such as the Port of Astoria, Port of Coos Bay and the Port of Newport on Yaquina Bay have capabilities to support dock side mobilization of WEC and provide crane service marine chandlery stores and shipyard support. Any fabrication/modification that resulted from dock side testing could be arranged by local services in these ports.

Port of Astoria. – 12 miles from the mouth of the Columbia River

This is a deep-draft port on the Columbia River. The docks can handle bulk, brake bulk containers, Ro-Ro and specialty cargoes. The port has a mobile crane rated at SWL 250 tons with 210 feet reach. It does have tug and barge services for ships at anchor.

Port of Coos Bay. – 15 mi. from the Pacific

This is the largest deep-draft coastal harbor between San Francisco Bay and Puget Sound. It is Oregon's second busiest maritime commerce center. It is noted for the safest entrance bar on the Pacific Northwest coast. Railroad service runs to the marine terminals and a shipyard.

Port of Newport/Yaquina Bay. – 2 mi. from the Pacific

This is a tidal estuary widened by the Yaquina River with commercial moorage. The port dock is wooden but does have mobile crane service.

5.3.4 OWET Study by Advanced Research Corporation

Figure 70 identifies the Ports being investigated by the Advanced Research Corporation (ARC), Newport, OR to assess the infrastructure capabilities of the Oregon Coast⁹.

The ARC effort will provide the following information for all Oregon Ports. It is derived from publically available sources¹⁰ and from direct contact with the various ports:

- Brief overview of the planned depths and entrances of each port
- The deep-water docks and wharfs where applicable.
- Basic fabrication and repair capabilities in the near vicinity of the port
- Contact information for the port in each area for additional information

⁹ Oregon Ports, Infrastructure along the coast, October 2009, Advanced Research Organization, Newport OR

¹⁰ Coast Pilot (www.nauticalcharts.noaa.gov/nsd/cpdownload.htm),
U.S.A.C.E Port Series Reports (www.iwr.usace.army.mil/ndc/ports/ps/psbooks.htm)

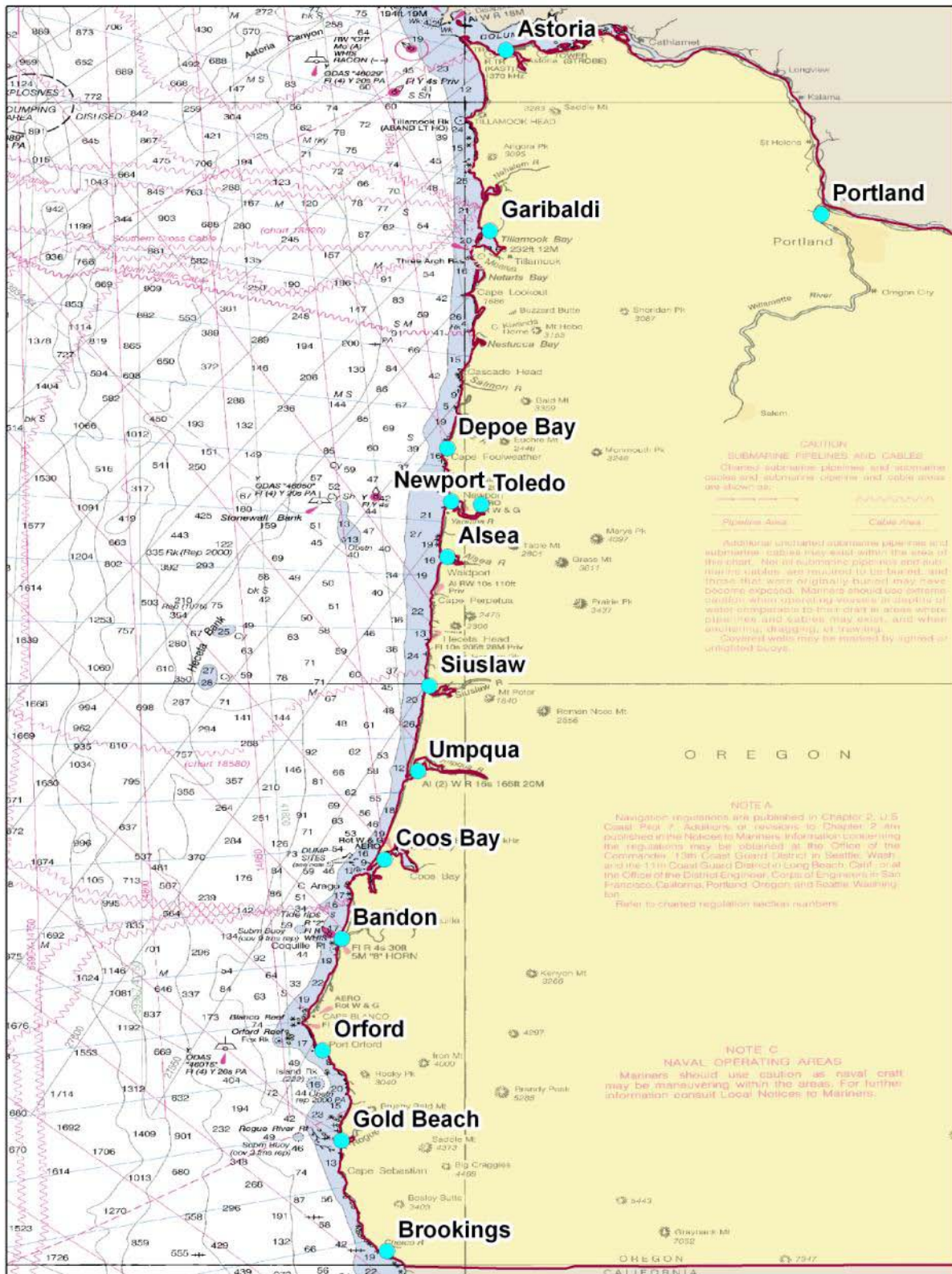

Figure 70 Oregon Ports

6.0 ADDITIONAL R&D RECOMMENDATIONS

- 1) **SEDIMENT GEOTECHNICAL DATA:** Data on sediments at all of the Oregon FERC sites is limited. Information on sediments (composition, thickness, areal variability and engineering properties) controls the types and sizes of anchor that can be used. Surveys and follow on studies are critical to the economical and reliable design of WEC anchoring systems.
- 2) **CURRENT DATA:** Data on ocean currents at the sites is lacking. Current data over extended periods is necessary for the economical and reliable design of WEC mooring systems. There is good coverage of surface currents along the entire coast through the CODAR system. Ocean current data across a range of depths are available at the GLOBEC buoy NH10 (20 km east of Newport, OR) and from the COAST 2003 buoy 40 km north of the NH10 buoy (near the center of the Oregon coast). However, similar buoys with ADCPs within the FERC permitted sites would provide comprehensive information on the forces the WEC devices will encounter from ocean currents through the water column, as surface currents are largely wind driven and are contained to the top 5 m of the water column.
- 3) **COMPONENTS FOR HIGH-DYNAMIC-LOAD MOORINGS:** Conventional chain and wire catenaries are not effective at mitigating dynamic loads in shallow water moorings. Synthetic ropes, and in particular, polyester fiber ropes, can be effective in mitigating dynamic loads. Research is required to evaluate the utility and effectiveness of using Polyester rope in WEC shallow water moorings. Polyester tethers have covers and filtration barriers to prevent ingress of sand, which can dramatically reduce the life of the rope. However, the effectiveness of the rope “sand barriers” needs to be validated for the highly-charged shallow water region.
- 4) **WEC ARRAY MOORING CONFIGURATIONS:** There are a multitude of designs possible for mooring individual WEC devices. The design and implementation of an economical mooring system for an array of WECs is far more complex. Short-scope/semi-taut mooring legs that can support more than a single WEC must be contrived to minimize the overall array footprint, while allowing maintenance and recovery of individual WEC devices.
- 5) **DESIGN GUIDES AND STANDARDS:** There are a multitude of design guides, specifications and recommended practice documents that could be applied to the design of a WEC mooring system. Since there are many WEC types and configurations and they are a relatively infant technology, the effectiveness and efficiency of these design tools and guides is unknown. Research is needed to evaluate the current suite of available design tools and guides and to recommend an engineering design methodology appropriate to the design of single and multiple WEC devices.

APPENDIX A ANCHOR DESIGN PROCEDURES

APPENDIX A ANCHOR DESIGN PROCEDURES	116
A-1 Deadweight Anchors	117
A-1.1 Basic Design – Holding Capacity for a Simple Deadweight Anchor.....	117
A-1.2 Holding Capacity for a Deadweight Anchor with Keying Skirts	119
A-1.2 Other Design Considerations	120
A-2 Drag Anchors	124
A-2.1 Description.....	124
A-2.2 Drag Anchor Performance	125
A-2.3 Drag Anchor Holding Capacity	127
A-2.4 Chain Contribution to Capacity	131
A-2.5 Anchor Penetration	132
A-2.6 Anchor Setting Distance	133
A-2.7 Anchor Instability and Performance Problems.....	134
A-2.8 Piggybacking	135
A-2.9 Factor of Safety.....	136
A-3 Pile Anchor	137
A-3.1 Driven and drilled and grouted piles	137
A-3.2 Suction Piles	138
A-3.3 Piles of Other Types	139
A-3.4 Pile Anchor Capacity.....	139
A-4 Plate Anchors	141
A-4.1 Plate Anchor Types and Functioning	141
A-4.2 Plate Anchor Capacity	142
A-4.3 Load Direction and Timing Factors That Affect Plate Anchor Capacity.....	143

A-1 Deadweight Anchors

A-1.1 Basic Design – Holding Capacity for a Simple Deadweight Anchor

For a cohesionless soil, the capacity of a simple deadweight anchor is given by

$$F_h = (W - F_v) * (\tan \phi)$$

where: W = anchor weight in water

F_v = vertical component of line pull

$\tan \phi$ = tangent of the friction angle between the bottom surface of the anchor and the underlying soil, as given in Table 33.

Table 33 Friction Coefficients for Anchor Materials on Granular Soils ($\tan \phi$)

Soil	Smooth Steel	Rough Steel	For Soil On:		Trapped Soil
			Smooth Concrete	Rough Concrete	
Quartz Sand	0.27	0.60	0.60	0.69	0.67
Coralline Sand	0.20	0.63	0.63	0.66	0.67
Oolitic Sand	0.23	0.56	0.58	0.74	0.79
Foram Sand-Silt	0.40	0.66	0.67	—	0.64

Note the minor difference in friction coefficient between rough steel and smooth concrete. It requires only minor surface roughness that can be caused by rust or very minor surface pitting or scouring to transition from smooth to rough behavior. For all practical situations the smooth steel condition can be achieved in the laboratory for small controlled specimens but does not occur in practice.

For a cohesive soil, referring to Figure 71, the capacity of a simple deadweight anchor is given by

$$F_h = S_{uz} * A + [2 * S_{ua} * z + \gamma_b * \frac{1}{2} z^2] * B$$

where: S_{uz} = undrained shear strength at bottom of anchor

A = plan area of bottom of anchor

S_{ua} = average undrained shear strength from surface to depth z

z = depth to bottom of anchor

γ_b = buoyant unit weight of soil

B = width of anchor

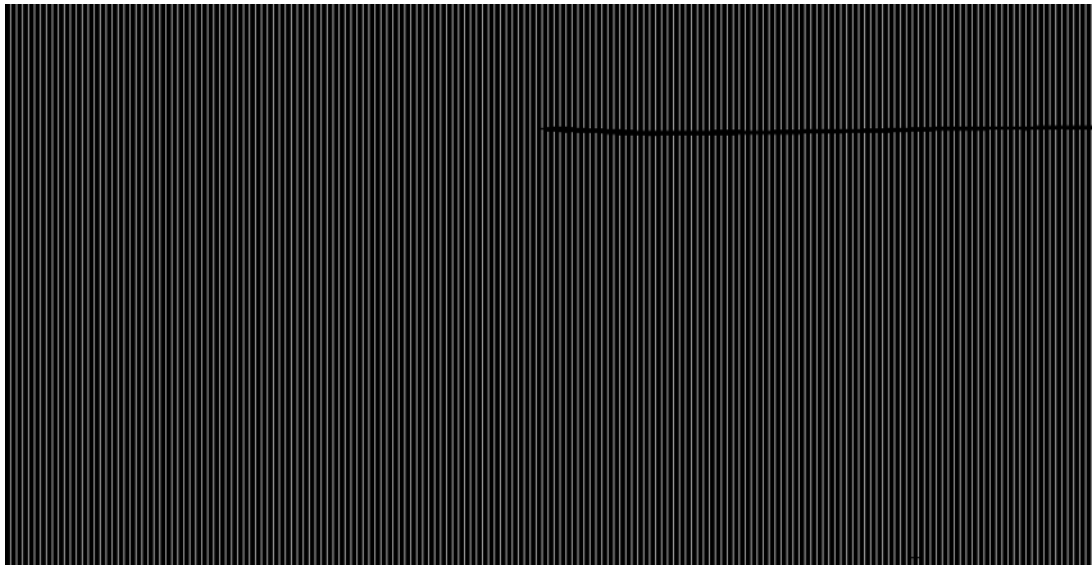

Figure 71 Simple Deadweight Anchor Design on Cohesive Soil

In this equation, the shear and uplift of the passive wedge at the front of the anchor (numbers 2 and 3 in Figure 71) are represented in the second and third terms, and the alongside shear and rear suction (numbers 4 and 5 in Figure 71) are omitted as negligible. The shear strengths in this equation can be measured using standard geotechnical methods. Alternatively, they can be estimated from the tendency of the anchor to settle to the depth at which it is supported by the bearing strength of the soil; this gives

$$S_{uz} = W / (N_c * A)$$

where: N_c = bearing capacity factor, conservatively approximated at 5.7

For sediment having a shear strength increasing linearly from a zero value at the surface, the average shear strength over the depth z is

$$S_{ua} = 0.5 * S_{uz}$$

and the value of depth is

$$z = S_{uz} / G_{su}$$

where: G_{su} = rate of increase of shear strength with depth, approximated at 12 psf/ft

A-1.2 Holding Capacity for a Deadweight Anchor with Keying Skirts

The addition of keying skirts adds substantially to the capacity of a deadweight anchor by mobilizing soil resistance to lateral movement below the main body of the anchor, where the soil is typically stronger than in shallower zones. The calculation of holding capacity is more complicated. Calculations are described below for a simple “full-base-skirted” deadweight anchor (Figure 72) in which the peripheral skirts enclose the entire anchor base.

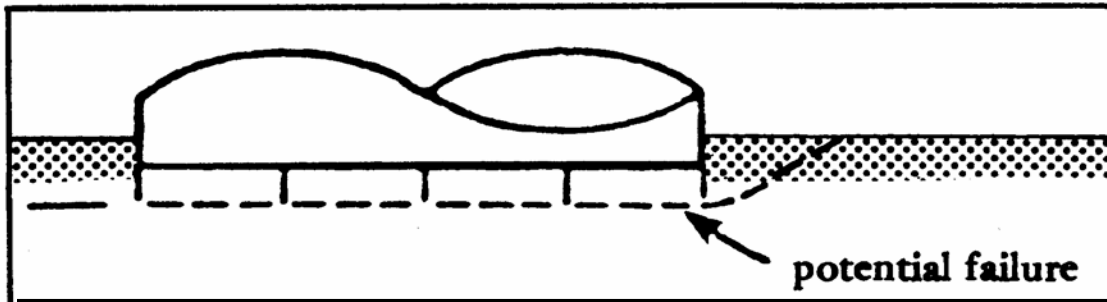

Figure 72 Schematic of “Full-Base-Skirted” Deadweight Anchor

First, the penetration of the skirts must be determined. Properly designed skirts will penetrate fully. The net downward force available at anchor placement is compared with the calculated bearing capacity of the skirts, using a deeply penetrating sheet pile model for the type of soil at the mooring site, to ensure that the downward force is sufficient to produce full penetration. Note that if full penetration of the keying skirts is not achievable with the available downward force at placement, the force may be increased or the depth and/or thickness of skirts may be reduced. However, if the depth is reduced, the spacing of interior shear keys should be reduced accordingly, thus increasing their number and adding to penetration resistance. Therefore, increasing the anchor weight is often the best choice.

Then the added capacity of the skirts is calculated as the sum of the leading skirt passive earth force and the base sliding resistance force. The recommended design uses internal shear keys that penetrate to the same depth as the peripheral skirts, with spacing equal to the skirt depth for cohesive soils, and equal to twice the skirt depth for cohesionless soils. This causes the sum of shear key resistances to match the sliding resistance of the soil block enclosed by the peripheral skirts, which is in fact the base sliding resistance force.

In cohesive soil, the lateral capacity of a deadweight anchor with full-base keying skirts is then

$$F_h = S_{uz} * A + [2 * S_{ua} * z_s + 1/2 \gamma_b * z_s^2] * B$$

where: S_{uz} = undrained shear strength at bottom of skirts

A = plan area of bottom of anchor, enclosed by peripheral skirts

S_{ua} = average undrained shear strength from surface to depth z_s

z_s = depth to bottom of skirts

γ_b = buoyant unit weight of soil

B = width of anchor

In cohesionless soil, the lateral capacity of a deadweight anchor with full-base keying skirts is then

$$F_h = (W - F_v) (\tan \phi) + K_p * \gamma_b * 1/2 z_s^2 * B$$

where: W = anchor weight in water

F_v = vertical component of line pull

$\tan \phi$ = tangent of the friction angle at depth z_s (at the bottom surface of the soil trapped within the peripheral skirts), as given in Table 33.

K_p = passive earth pressure coefficient, $= \tan^2(45 + \phi/2)$

γ_b = buoyant unit weight of soil

z_s = depth to bottom of skirts

B = width of anchor

A-1.2 Other Design Considerations

Sloping seafloor effects. Because gravity anchor capacity depends on friction and keying, and because both of these actions depend on normal force, the performance of a gravity anchor is affected strongly by the slope of the seafloor upon which it rests. As shown in Figure 73, the downslope component of anchor weight is added to the downslope component of anchor pull, while the normal component of weight is reduced by the upward normal component of anchor pull. Thus, for a seafloor sloping toward an anchored object, the anchor capacity is reduced, reaching zero as the tangent of the slope angle reaches the effective coefficient of friction of the anchor on the seafloor. On the other hand, the upslope anchor capacity is substantially increased by an increased slope angle.

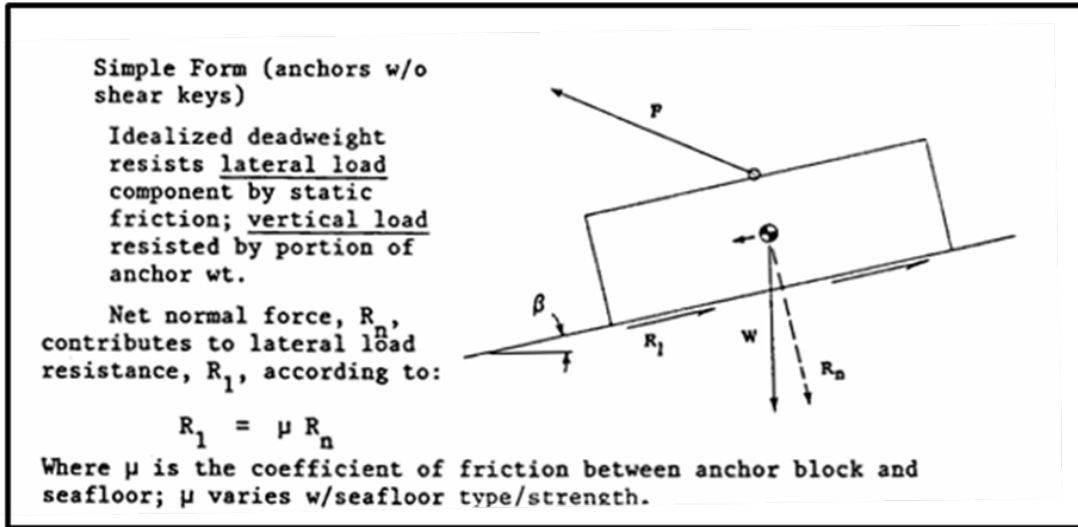

Figure 73 Deadweight Anchor Design on Slopes

Shaping and Special Features. The wedge ("Pearl Harbor") anchor is a variation on gravity anchors that uses shape effects to gain an efficiency advantage. The wedge anchor has no shank and so it relies upon careful orientation during placement, along with a small orienting moment provided by the attachment eye, to ensure that the leading cutting edge digs into the sediment as pull is applied. Pulls exceeding its capacity or in the wrong direction can destroy its stability, requiring it to be placed again in the proper orientation to return it to service at full capacity.

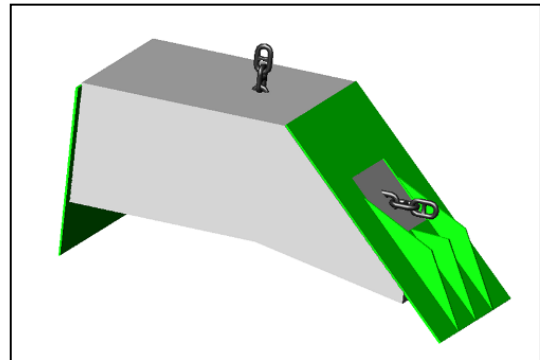

Figure 74 Enhanced Pearl Harbor Anchor

The "Enhanced Pearl Harbor" anchor is shown in Figure 74. The basic concrete wedge has been enhanced with steel plates – on the front to improve penetration and on the rear to increase the downward load on the front plate as a forward pull is applied. Table 34 provides dimensional information for this anchor over a broad range of sizes.

Table 34 Nominal Features of Enhanced Pearl Harbor Anchor

	ITEM # =	(2)	(3)	(4)		
NOMINAL ANCHOR	REFERENCE ANCHOR	BAR	PLATE	REBAR	Concrete	IN-WATER
IN-AIR WEIGHT (US TONS)	DIMENSION 'A' (ft)	DIAMETER (in)	THICKNESS (in)	DIA. (in)	VOL. (ft ³)	WEIGHT, W' (thousands pounds)
1	1.50	1.75	0.625	0.375	12.1	1.32
2	2.00	1.75	0.625	0.375	28.7	2.91
5	2.70	1.75	0.625	0.375	70.6	6.77
7.5	3.00	1.75	0.75	0.375	96.9	9.34
10	3.40	1.75	0.75	0.5	141.1	13.34
12.5	3.60	1.75	0.75	0.5	167.4	15.7
15	3.90	2	1	0.5	212.9	20.5
20	4.25	2	1	0.5	275.5	26.2
30	4.90	2.5	1.5	0.625	448.6	44.2
45	5.50	2.5	1.5	0.625	597.1	57.9
60	6.10	2.5	1.5	0.625	814.6	77.7

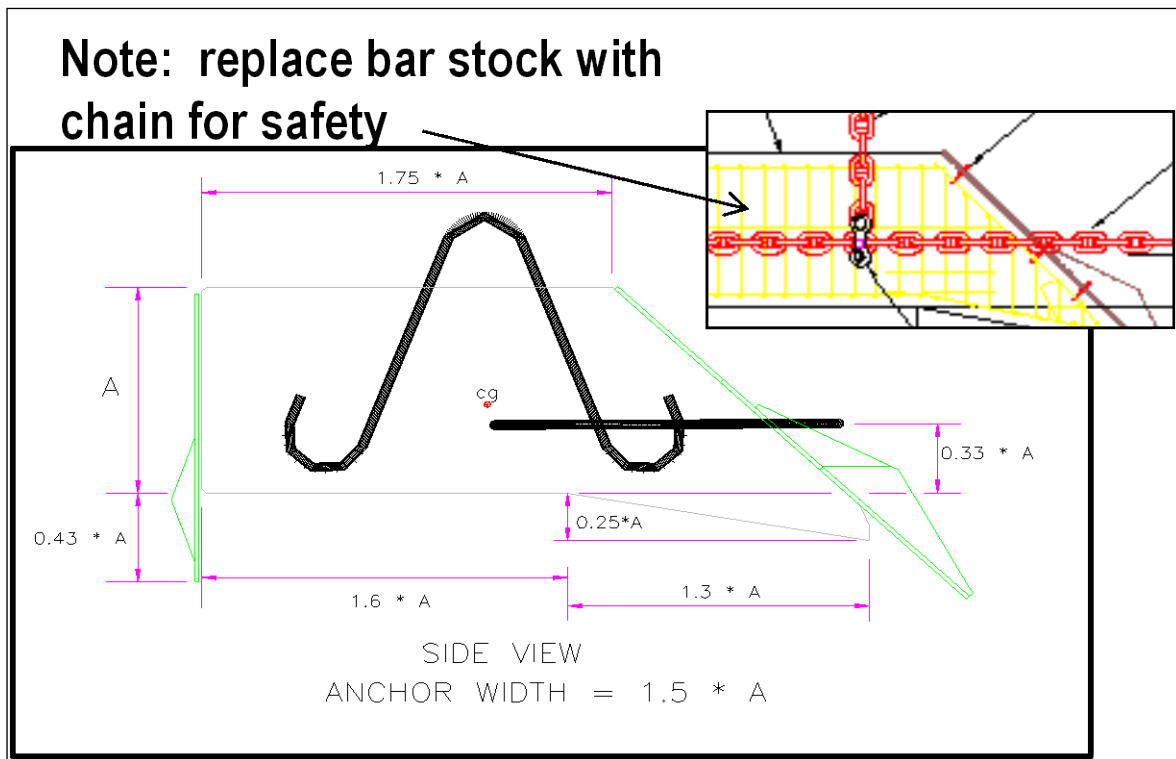

Figure 75 Enhanced Pearl Harbor Anchor Configuration

Figure 75 shows the detail of the reinforcing bar that is cast into the concrete in the Enhanced Pearl Harbor anchor to serve as eyes for lifting and applying forward pull. Note that in recent versions, the bar stock has been replaced with chain to preclude damage to the eyes on impact,

and to prevent the protruding eyes from damaging other equipment in case of inadvertent shifting during transit.

Tables 35 and 36 provide working capacities for these anchors in soft clay/mud and in sand, respectively.

Table 35 Enhanced Pearl Harbor Anchor Capacity in Soft Clay/Mud

NOMINAL ANCHOR IN-AIR WEIGHT (US TONS)	REFERENCE ANCHOR DIMENSION 'A' (ft)	IN-WATER WEIGHT, W' (thousands pounds)	ANCHOR MAXIMUM WORKING HORIZONTAL CAPACITY* (thousands pounds)
1	1.50	1.32	2.0
2	2.00	2.91	4.0
5	2.70	6.77	10.0
7.5	3.00	9.34	15.0
10	3.40	13.34	20.0
12.5	3.60	15.7	25.0
15	3.90	20.5	30.0
20	4.25	26.2	40.0
30	4.90	41.7	60.0
45	5.50	57.9	90.0
60	6.10	77.7	120.0
			* In mud
			FS=1.5
			Keep chain
			angle less than
			5 to 6 degrees

Table 36 Enhanced Pearl Harbor Anchor Capacity in Sand

REFERENCE ANCHOR DIMENSION 'A' (ft)	IN-WATER WEIGHT, W' (thousands pounds)	NOMINAL ANCHOR IN-AIR WEIGHT (US TONS)	0-DEG UP ANGLE WORKING* HOLDING (thousands pounds)	6-DEG UP ANGLE WORKING* HOLDING (thousands pounds)
1.50	1.32	1	3.87	2.65
2.00	2.91	2	9.35	6.30
2.70	6.77	5	23.8	15.8
3.00	9.34	7.5	33.3	22.0
3.40	13.34	10	49.5	32.5
3.60	15.7	12.5	59.3	38.9
3.90	20.5	15	77.1	50.4
4.25	26.2	20	102	66
4.90	41.7	30	163	106
5.50	57.9	45	236	151
6.10	77.7	60	331	211
			* FS = 1.5	* FS = 1.5

A-2 Drag Anchors

A-2.1 Description

A drag embedment anchor (as shown in Figure 76) typically consists of a fluke section, which acts against the soil, and a shank section, which carries the fluke's soil-derived pulling resistance to the anchor line and provides a moment arm to maintain proper attitude of the fluke. Many types also have a stabilizer to prevent rotation out of the soil, and others have their own special features to enhance performance or stability.

Dragged-in anchors are normally used in catenary mooring systems and are available in sizes up to 60 tons with capacities in excess of 2000 tons in competent seabed materials. Unless these anchors are used with clump weights to depress the mooring leg the mooring system will occupy a very large footprint.

Various types of drag anchor are shown in Figure 77.

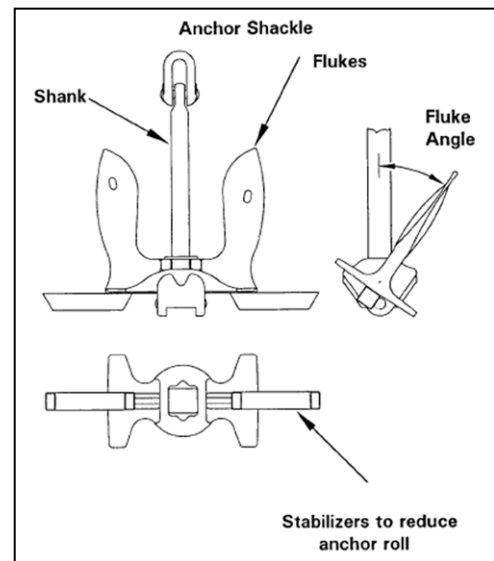

Figure 76 Anchor Parts Identified

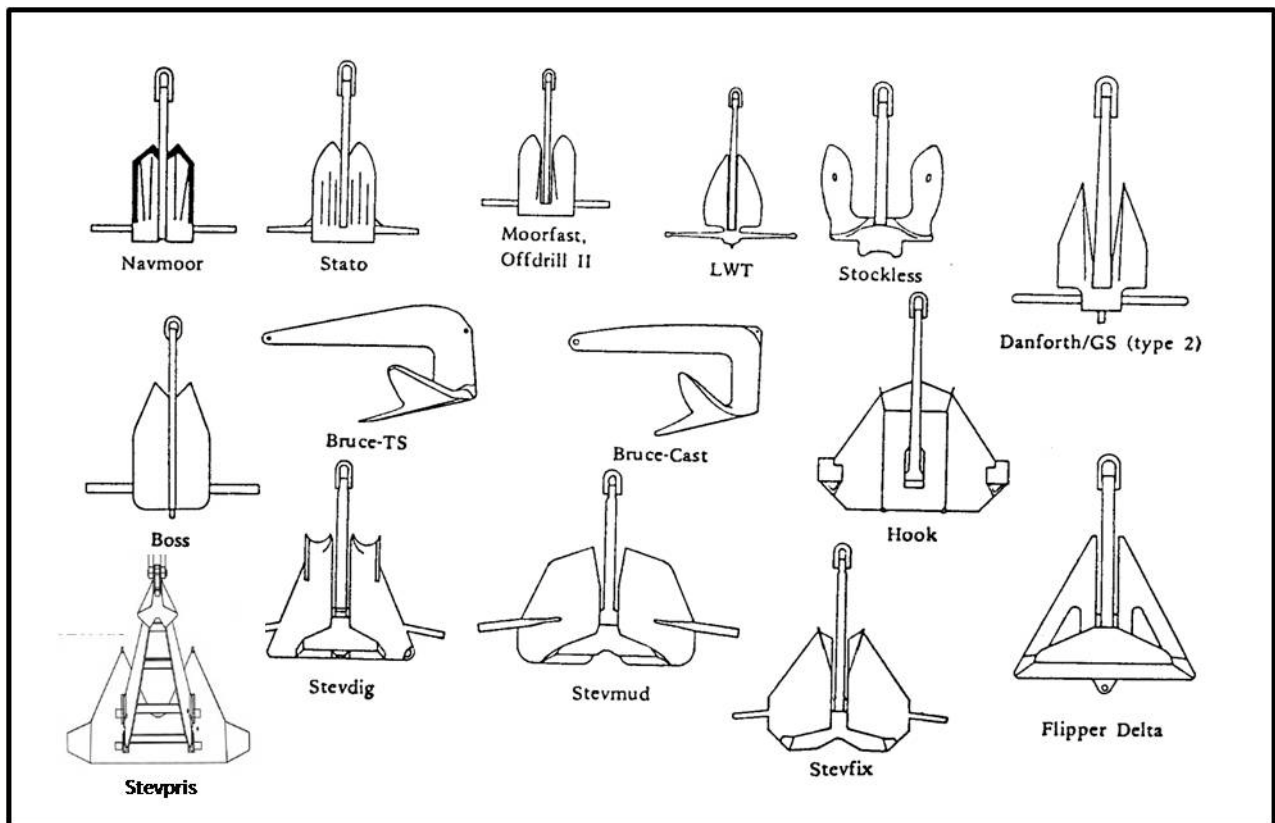

Figure 77 Types of Drag Anchor

A-2.2 Drag Anchor Performance

Drag-embedment anchors achieve most of their capacity as a result of their penetration of bottom sediment during lateral pull. Having penetrated, their flukes bear against the soil, thereby taking advantage of the large available resistance to movement of the affected soil.

Table 37 Soil Characteristics and Effects

Soil	Description	Anchor Capacity
Mud	<ul style="list-style-type: none"> • Normally consolidated, very soft to soft, silt to clay size sediment typical of harbors and bays. • Soil strength increases linearly with depth at 12 psf/ft \pm 4 psf/ft. Approximately equates to standard penetration resistance (SPT) of 2 blows/ft at 20-ft depth. 	<ul style="list-style-type: none"> • Holding capacity is reasonably consistent provided anchor flukes trip open. • Certain anchors () require special care during installation to ensure fluke tripping.
Sand	<ul style="list-style-type: none"> • Medium to dense sand with bulk wet density of 110 to 140 pcf typical of most nearshore deposits. • SPT range—25 to 50 blows/ft. 	<ul style="list-style-type: none"> • Holding capacity is consistent provided sand fluke angle is used.
Clay	<ul style="list-style-type: none"> • Medium to stiff cohesive soil. Soil shear strength (su) considered constant with depth. • su range—3½ to 14 psi. • SPT range—4 to 16 blows/ft. 	<ul style="list-style-type: none"> • Good holding capacity which will range between that provided for sand and mud. • For stiff clay (su > 7 psi) use sand capacity, $\frac{su}{10}$. • For stiff clay (su > 7 psi) use sand fluke angle.
Hard Soil	<ul style="list-style-type: none"> • Very stiff and hard clay (su > 14 psi, STP > 16) and very dense sand (SPT > 50, $\gamma_{sat} > 140$ pcf). • Seafloor type can occur in high current, glaciated, dredged areas. 	<ul style="list-style-type: none"> • Holding capacity is consistent provided anchor penetrates; may have to fix flukes open at sand fluke angle to enhance embedment; jetting may be required.
Layered Seafloor	<ul style="list-style-type: none"> • Heterogeneous seafloors of sand, gravel, clay, and/or mud layers or mixtures. 	<ul style="list-style-type: none"> • Anchor performance can be erratic. Reconsider number and type of anchors if anchors cannot be proof-loaded to verify safe capacity.
Coral/Rock	<ul style="list-style-type: none"> • Can also include areas where coral or rock is overlain by a thin sediment layer that is insufficient to develop anchor capacity. 	<ul style="list-style-type: none"> • Unsatisfactory seafloor for permanent moorings. • Can be suitable for temporary anchoring if anchor snags on an outcrop or falls into a crevice.

Drag-embedment anchor performance can be defined in terms of broad categories of seafloor type. Table 37 describes the various seafloor categories and the level and consistency of anchor capacity possible in each category.

Table 38 provides further data on the tripping, stability, and general holding capacity level of drag anchors.

Table 38 Operating Characteristics of Drag Anchors

Anchor	Performance Characteristic in—					
	Cohesive Soils (clays and silts)			Cohesionless Soils (a) (sands)		
	Tripping/ Dig-In	Stability	Holding Efficiency	Tripping/ Dig-In	Stability	Holding Efficiency
Stockless (b) (movable fluke)	low	med	low	high	med	low
Stockless (b) (fixed fluke)	high	med	low	high	high	low
G. S.	c	c	med	high	med	med
Danforth	med	low	med	high	med	med
LWT	low	low	low	high	med	med
Moorfast	med	med	med	med	med	med
Offdrill II	med	med	med	med	med	med
Flipper Delta	high	c	med	c	c	med
Stevin	c	c	med	c	c	med
Stevfix	low	low	high	high	med	high
Stevdig	c	c	c	high	med	high
Stevpris	high	med	med	high	high	high
Stevmud	high	c	high	d	d	d
Hook	high	high	med	med	high	med
Boss	high	med	high	high	c	high
Stato (e)	high	med	high	high	high	high
Bruce (cast)	high	high	low	high	high	high
Bruce (twin shank)	high	high	high	high	high	high
Navmoor	high	high	high	high	high	high

Notes:

(a) Anchor with fluke angle set at manufacturer's recommendation for sand unless otherwise noted.

(b) With stabilizers (ratings not as high without stabilizers).

(c) Insufficient data available for rating.

(d) Anchor not normally used in this seafloor material.

(e) Anchor fluke angle set at 30° for sand.

Tripping /Dig-in refers to the ability of the anchor to initiate penetration during normal drag as the fluke tips engage the seafloor. Some anchors may have to be placed with the flukes held or blocked in the open position to ensure proper embedment. This most often occurs in very soft

soils for anchors with small tripping palms and in very hard soils especially for anchors with relatively more blunt flukes.

Stability refers to the ability of an anchor to remain stable with minimal or no roll during the anchor penetration process. A stable anchor maintains its capacity during continual drag; whereas, an unstable anchor can roll and be pulled to the surface where it may or may not re-embed with further drag.

Figure 78 illustrates effect of tripping and stability problems on performance of drag anchors. When an anchor fails to trip and dig into the seafloor anchor, the anchor simply drags at or near the surface of the seafloor. An unstable anchor will rapidly lose capacity once it begins to roll out of the seafloor.

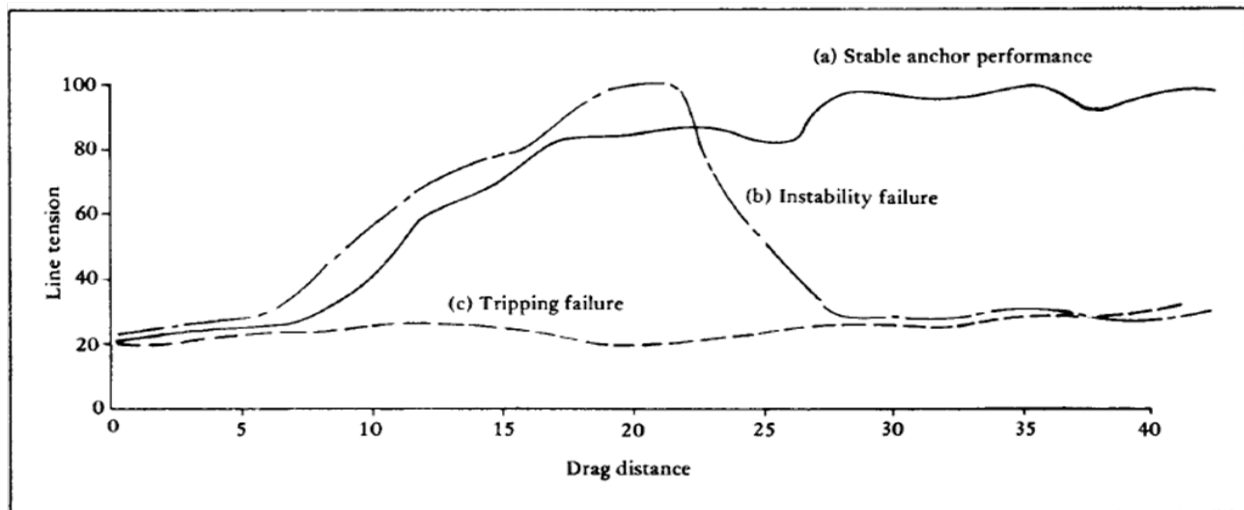

Figure 78 Effects of tripping on drag anchor performance

The anchors in Table 38 span a wide range in efficiency (the ratio of holding capacity against a lateral pull to anchor weight in air). The types of lower efficiency anchor such as the Stockless and LWT tend to be heavier relative to their overall dimensions, and are more rugged and forgiving of rough handling and placement. The highest-efficiency types such as the Bruce, Flipper Delta and Stevin types may require careful placement, orientation and setting to achieve their full capacity, and are more expensive per pound of anchor to procure and install.

A-2.3 Drag Anchor Holding Capacity

Anchor holding capacity is most commonly given as the maximum horizontal pull that can be sustained by the anchor. The “efficiency” – the ratio of the holding capacity to the dry weight of the anchor – varies widely with anchor and seafloor soil type. It is relatively constant with respect to anchor weight for a given anchor type and soil type, but decreases somewhat for very large sizes because of steel stress limitations.

Predictions for anchor holding capacity are provided by Figures 79 and 80. These predictions were developed by the U.S. Navy and subsequently adopted by the American Petroleum Institute

for use in various guides for design of offshore platforms. These curves are considered to be more reliable than other, sometimes less conservative guidance that is available from commercial sources. They were based initially upon Navy-generated performance data and were verified and/or adjusted using commercial data when full test details were available. When data were limited, predictions were extended with an analysis procedure based upon geotechnical considerations. More recent studies have shown that several parameters such as mooring line type and anchor soaking can influence anchor capacity.

The design curves are based on testing with chain mooring lines. In soft clay anchor capacity can increase 15-40% with a wire forerunner due to increased anchor penetration in a normally consolidated clay seafloor (linear soil strength increase with depth). A moderately conservative recommendation of a 20% increase is suggested when using a wire forerunner.

A soaked anchor is one that has been embedded for some time. The time depends upon the permeability of the soil and the time required for dissipating positive pore pressures in the surrounding soil. Anchor soaking can produce a short term increase in capacity prior to initiating drag; however, continued drag will cause this increase in capacity to dissipate.

There are new versions of drag anchor that are not covered by these figures. Often manufacturers simply base changes in performance on changes in fluke area provided that the rest of the anchor remains unchanged. This can be dangerous and unconservative particularly in sand and hard soils. Enhancing fluke area can increase penetration resistance in hard soil with a consequent reduction in overall anchor capacity. However, increasing fluke area for soft clay anchoring applications with no change in shank size or configuration can result in an increase in anchor capacity. Limited test data in soft clay suggests that anchor efficiency increases at a rate slightly greater than the ratio of fluke areas but until more data are available it is recommended that holding capacity for anchors with enlarged fluke area in soft clay be related directly to anchor fluke area.

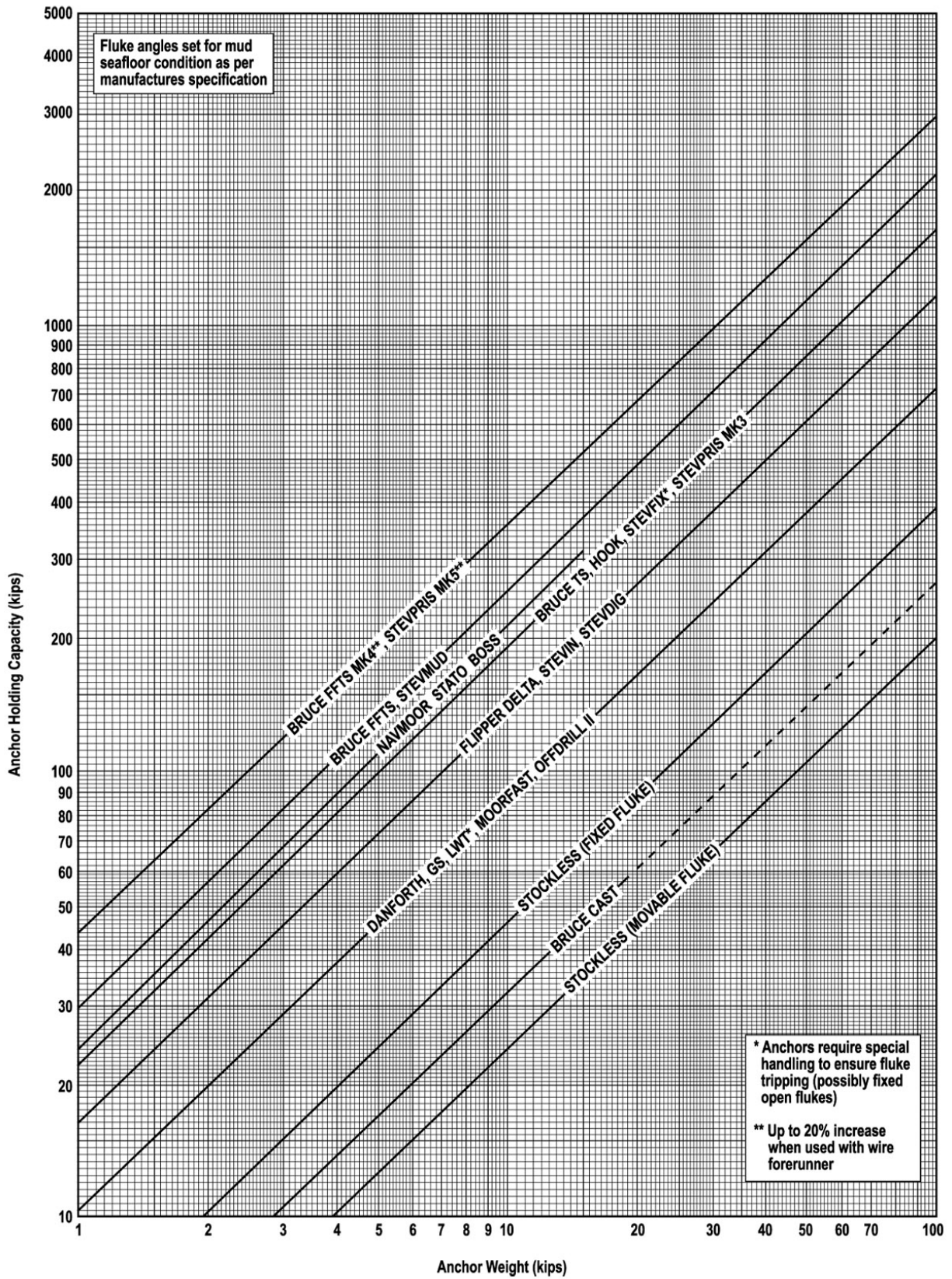

Figure 79 Ultimate Holding Capacity of Drag Anchors in Mud/soft Clay

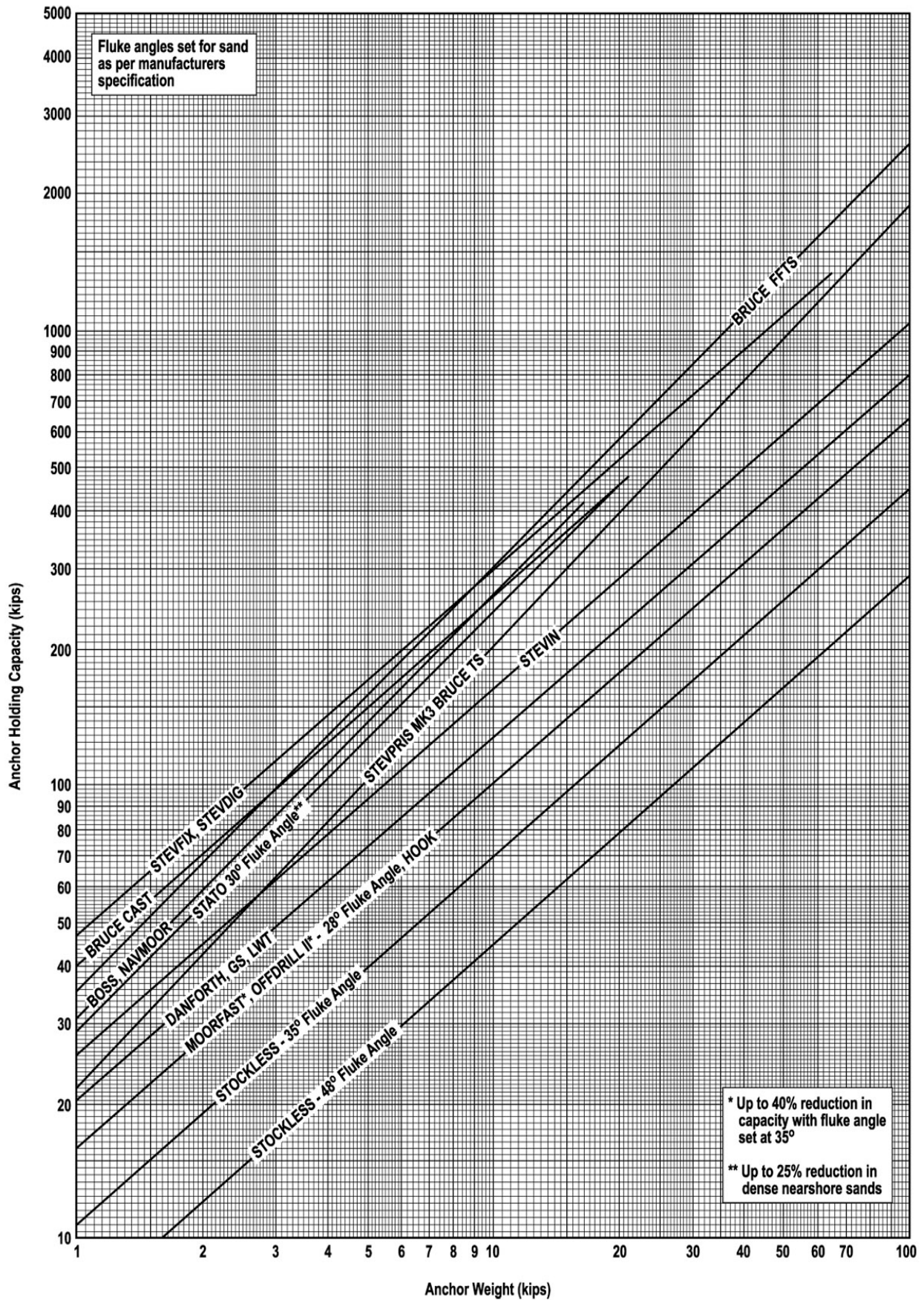

Figure 80 Ultimate Holding Capacity of Drag Anchors in Sand/hard Soil

Anchor system holding capacity can be determined from the following relationship and the parameters in Table 39. This procedure is appropriate for all anchor sizes, including those outside the range of Figures 79 and 80.

$$H_m = m (W_a)^b$$

where: H_m = anchor holding capacity (kips)

m, b = parameters depending on the anchor and soil type

W_a = anchor weight in air (kips)

Table 39 Anchor Holding Capacity Parameters

Anchor Type	Soft Clays and Mud		Stiff Clays and Sand	
	m	b	m	B
Boss	24.1	0.94	31.0	0.94
Bruce Cast	3.9	0.92	39.6	0.8
Bruce Flat Fluke Twin Shank (FFTS)	30.0	0.92	34.4	0.94
Bruce FFTS MK4	42.5	0.92	-	-
Bruce Twin Shank	22.7	0.92	24.1	0.94
Danforth	10.5	0.92	20.0	0.80
Flipper Delta	16.7	0.92	No data	No data
G.S. AC-14	10.5	0.92	20.0	0.80
Hook	22.7	0.92	15.9	0.80
LWT (Lightweight)	10.5	0.92	20.0	0.80
Moorfast	10.5	0.92	15.9 ^a	0.80
NAVMOOR	24.1	0.94	31.0	0.94
Offdrill II	10.5	0.92	15.9 ^a	0.80
STATO	24.1	0.94	28.7 ^b	0.94
STEVDIG	16.7	0.92	46.0	0.80
STEVFIX	22.7	0.92	46.0	0.80
STEVIN	16.7	0.92	26.2	0.80
STEMMUD	30.0	0.92	Not suitable	Not suitable
STEVPRIS MK3 (straight shank)	22.7	0.92	24.1	0.94
STEVPRIS MK5	42.5	0.92	-	-
Stockless (fixed fluke)	5.5	0.92	11.1	0.8
Stockless (movable fluke)	2.9	0.92	11.1 ^c	0.8
Stockless (movable fluke)	-	-	7.0 ^d	0.8

Fluke Angle Settings: ^a $a=28^\circ$, ^b $b=30^\circ$, ^c $c=35^\circ$, ^d $d=48^\circ$

A-2.4 Chain Contribution to Capacity

Both Figures 79 and 80 reflect total anchoring capacity or holding capacity of the anchor plus buried chain. In any anchor leg configuration, it is imperative that sufficient weight of chain, wire, and/or sinker weights be used to make the cable tangent to the seafloor at the design/setting/proof load, and that this angle be not more than about six degrees above that tangent when the load is raised to the ultimate capacity. Beyond this requirement, additional system capacity will be created by the frictional drag of extra chain laying on the seafloor. It is important to be able to determine system capacity when extra chain is used. This is done by multiplying the submerged weight of the extra chain or wire lying on the seafloor by a friction factor, as shown in Table 40.

Table 40 Mooring Line Friction Factors

Mooring Line	Bottom Material	Friction Starting	Factors Sliding
Chain	Sand	1.0	0.75
	Mud w/Sand	0.9	0.7
	Mud/Clay	0.9	0.55
Wire Rope	Sand	1.0	0.25
	Mud w/Sand	0.7	0.2
	Mud/Clay	0.45	0.2

A-2.5 Anchor Penetration

An aspect of performance is penetration depth, which relates to holding capacity and suitability for a given application. Full holding capacity is only achieved at full penetration depth. If, for example, the sediment layer over rock is too thin, an anchor requiring deeper penetration for full capacity will not penetrate the rock, and may become unstable (may roll) and pull out. However, such an anchor may be used at a site having a limited sediment thickness so long as its required capacity and proof load are reduced to preclude penetration exceeding that allowable given the site conditions. Penetration depth is also important in applications where there are buried obstructions, such as pipelines or cables, which are vulnerable to damage. The full penetration depths for mud are generally larger than for sand, and the penetration depths in all soils vary widely with the type of dragged-in anchor.

To achieve the capacities specified by Figures 79 and 80, minimum depths of sediment specified by Table 41 are required. Drag-embedment anchors will penetrate a non-dimensional distance of about one fluke length into sand and three to five fluke lengths into mud. Penetration in hard soil will be in about 1/2 fluke length. Anchor fluke length as defined here was taken from manufacturer's literature; manufacturers often include the crown and tripping palm in their definition of fluke length. The reduced capacity is approximately directly proportional to depth of embedment in mud and depth of embedment squared in sand.

Table 41 Maximum Penetration Depths of Drag Anchors

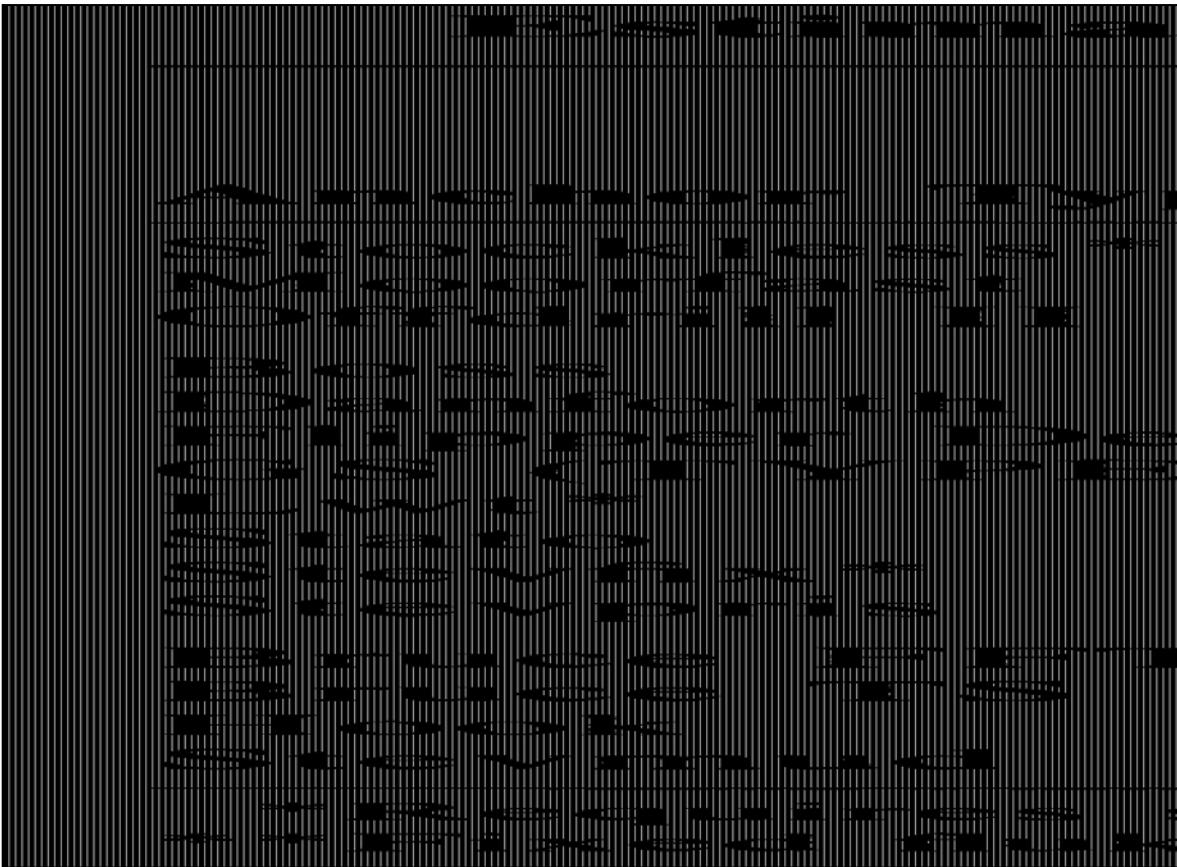

A-2.6 Anchor Setting Distance

The holding capacities of anchors in mud develop at drag distances specified by the relationships of Figure 81. If a simple approximation is desired, the great majority of anchors can be represented by curve 3 with only minimal losses in accuracy. These curves can be used to determine anchor drag distance for any anchor working capacity. The recommended safe working capacity of 50% of maximum (factor of safety = 2) is reached at drag distances between 2 and 12, depending upon anchor type.

In sand, the maximum capacity is achieved in less than about 10 fluke lengths of drag. Safe working capacity (f.s. = 2) occurs in 3-1/2 to 4 fluke lengths. Fixing the anchor flukes in the open sand position for movable fluke anchors reduces the setting distance to about 2 fluke lengths. (Anchor fluke length as defined here was taken from manufacturer's literature; manufacturers often include the crown and tripping palm in their definition of fluke length.)

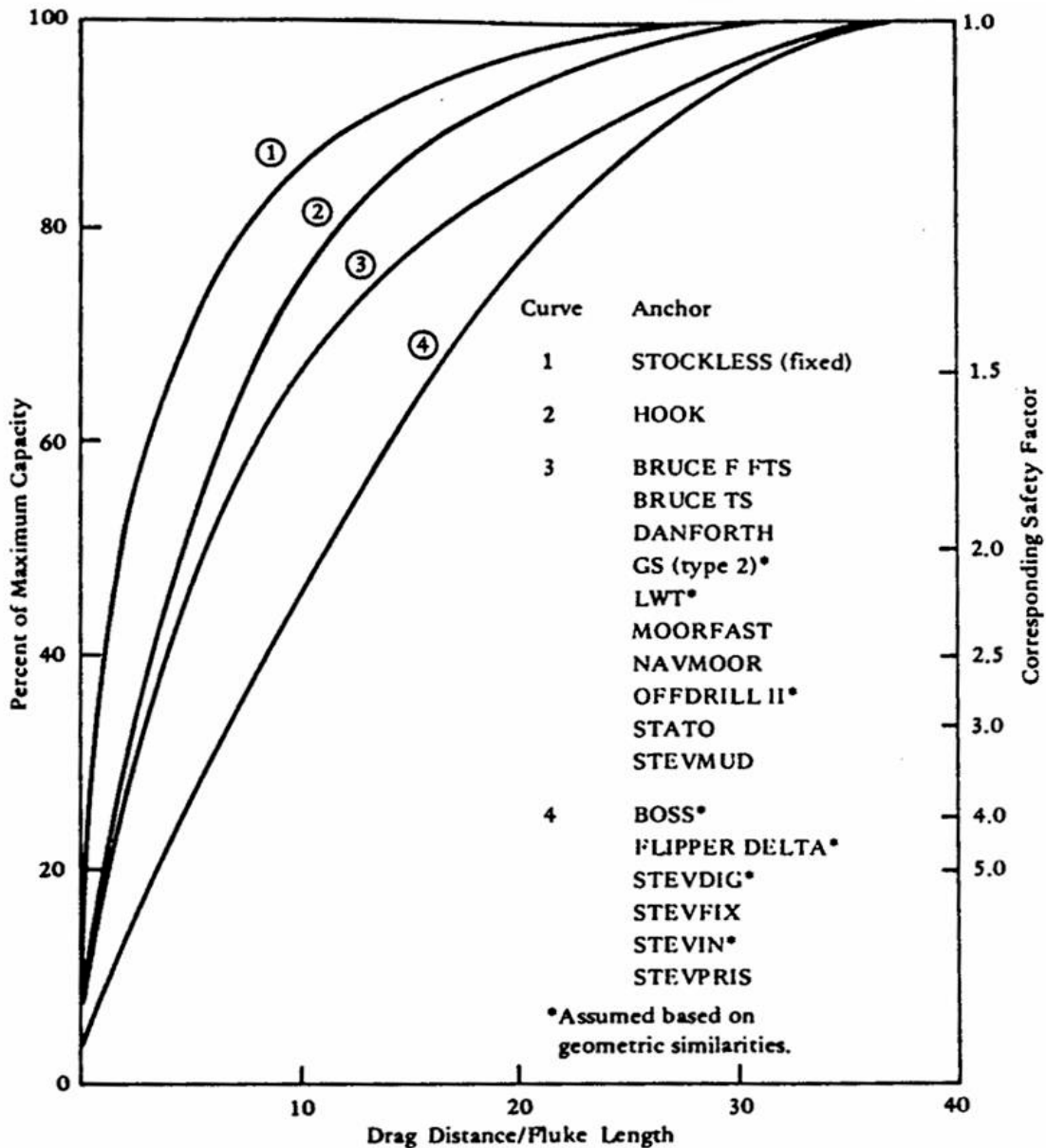

Figure 81 Setting Distance of Drag Anchors

A-2.7 Anchor Instability and Performance Problems

The performance data provided assume that the anchors trip and penetrate into the seafloor and remain stable (maintain their maximum capacity when dragged). This may not always occur. Table 42 lists some options for improving anchor performance.

As indicated in Table 42, stability is a key issue in many situations; thus it is an important factor in anchor selection. The data on stability in Table 42 may be used in selecting an anchor. Additional aspects of stability are discussed under "Piggybacking," below.

Table 42 Stability Problems and Solutions for Drag Anchors

Problem	Symptom	Possible Reason	Possible Solution
Poor Mud Performance	<ul style="list-style-type: none"> ● Near constant line tension ½ to 2 times wt of anchor and mooring line on seabed. ● Drop in tension during proof-loading with continued drag. ● Proof-load tension less than needed. 	<ul style="list-style-type: none"> ● Flukes not tripping. ● Anchor unstable. ● Soil more competent than anticipated. ● Seafloor softer than expected 	<ul style="list-style-type: none"> ● Increase size of tripping palms; add stabilizer. ● Weld or hold flukes in open position. ● Add stabilizers. ● Increase stabilizer length. ● Use different or larger anchor. ● Reduce fluke angle to sand setting or if possible by a smaller (5 deg to 10 deg reduction). ● Use larger anchor. ● Use different anchor. ● Add chain.
Poor Sand/ Hard Soil Performance	<ul style="list-style-type: none"> ● Near constant tension 1 to 3 times weight of anchor and mooring line on seabed. ● Variable tension 3 to 10 times weight of anchor and mooring line on seabed. ● Rapid drop in tension during proof-loading w/ continued drag ● Proof-load tension less than needed. 	<ul style="list-style-type: none"> ● Flukes not tripping. ● Flukes not penetrating. ● Anchor unstable. ● Less sediment than needed. ● Very hard seafloor. 	<ul style="list-style-type: none"> ● Sharpen fluke tips; add fluke tip barbs to break up soil. ● Weld or block flukes in open position. ● Extend anchor crown by light weight pipe or plate construction. ● Water jet anchor flukes into seabed. ● Reduce fluke angle; reduction to as little as 25 deg may be needed for very dense or hard soils. ● Sharpen flukes. ● Extend or add stabilizers. ● Use larger or different anchor. ● Extend/add stabilizers. ● Use larger or different anchor. ● Use larger or different anchor. ● Add chain. ● Use backup anchor. ● Use pile anchor.

A-2.8 Piggybacking

Multiple anchors can be used to achieve a higher system capacity than can be attained using single anchors. This is of value: (a) when the largest single anchor size practical for an application is limited by availability, transport, or handling constraints, or (b) when it is desirable to augment a pre-selected anchor that has proven inadequate.

A common practice is to add an anchor in tandem (piggyback) when a single anchor fails to achieve a required proof load. This can be done as shown in Figure 82. Depending upon the

lengths of pre-attached lines and the water depth, the operator might or might not need to retrieve the first anchor to connect the second. In either case, the first anchor is normally set before the second; hence, it must remain stable over sufficient drag distance for the second anchor to take its share of the load.

The results from piggybacking are strongly dependent on how the primary and secondary anchors are attached to the mooring line. Pendant lines are usually attached to the anchor at the back of the fluke where possible (Option (a) in Figure 82 or at the crown end of the shank (Option (b) in Figure 82). This produces mixed results. With many anchors the piggyback will cause rotation and breakout of the primary anchor or can cause the primary anchor's fluke to close when loaded. With other anchors such as stable fixed fluke anchors (Bruce and Stevpris) and stable movable fluke anchors with the tandem shackle hooked through the shank (NAVMOOR) the tandem capacity of two anchors can equal or exceed the capacity of the two anchors loaded separately. Option (c) is preferred for movable fluke anchors that exhibit stability problems as single anchors.

An alternative is to use two anchors in a parallel arrangement as shown in Figure 82. The key to using this technique effectively is to ensure that the anchors are longitudinally separated as shown to prevent them coming together during drag, which can negatively affect total system capacity.

A-2.9 Factor of Safety

Typically the drag anchor is sized as the "weaker link" in a mooring system to ensure that the anchor drags instead of breaking the mooring line. Anchor drag for a multi-leg mooring results in redistribution of the overstressed mooring line to neighboring

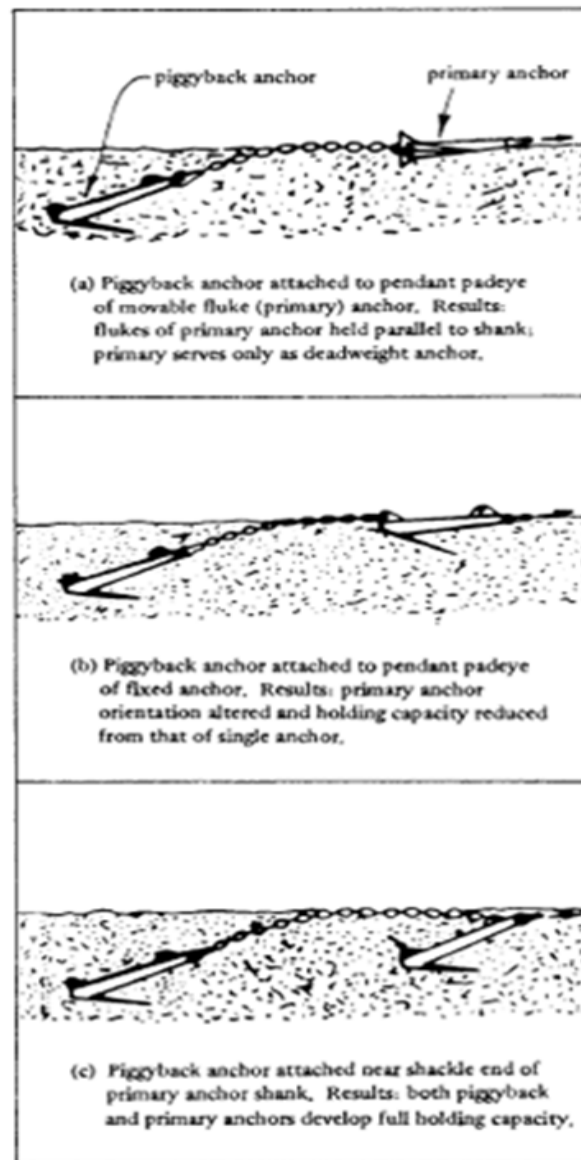

After P.J. Klaren, "Anchors in tandem or the use of back-up anchors (piggybacks)," Holland Shipbuilding, Anker Advies Bureau.

Drag Anchors in Tandem

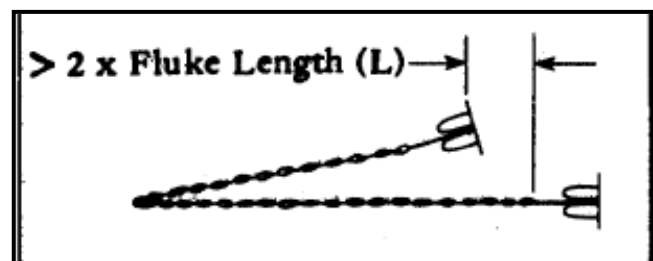

Figure 82 Drag Anchors in Parallel

mooring lines and helps the mooring survive extreme events. The factors of safety for the mooring line and drag anchor are shown in Table 43.

Table 43 Recommended Factors of Safety for Mooring Lines and Anchors

Condition	Analysis Method	Factor of Safety		
		Wire/Chain	Polyester	Anchor
Intact	Quasi-static	2	2.2	1.8
	Dynamic	1.67	1.83	1.5
One-Line Damaged	Quasi-static	1.43	1.58	1.2
	Dynamic	1.25	1.38	1
API RP 2SK (1966) "Recommended Practice for Design and Analysis of Station keeping Systems for Floating Structures"				
American Bureau of Shipping (2000) "Guide for Building Classing Floating Production Installations"				

A-3 Pile Anchor

General definition

A pile anchor is simply a pile with an attached cable that is driven into a soft seafloor or placed and grouted into a hole that has been pre-drilled into a hard seafloor. Refer to Figure 83. Pile anchors are capable of resisting vertical and lateral loads simultaneously. The pile may be installed battered" at an angle to enhance its resistance to uplift loading.

A-3.1 Driven and drilled and grouted piles

The most common types of anchor pile are those installed by driving into sediment or drilling and grouting into rock. These anchor piles are simple in their mobilization of anchor capacity, may be used with confidence, and generally have a useful life limited only by the durability of the chain downhaul cable. Installation may be tailored to suit almost any set of bottom conditions, but the water depth and sea environment must match the capabilities of the driving equipment and the support vessel's station keeping systems. The size and cost of equipment is substantial, making other alternatives more attractive where the number of anchors needed is too small to justify mobilizing a pile installation capability.



Figure 83 Pile Anchors

A-3.2 Suction Piles

Suction piles are piles installed in sediment by applying a decreased internal pressure (a relative vacuum) relative to the ambient seawater pressure at the seafloor. Because their resistance to penetration increases with penetration depth while their pressure-induced embedment force remains constant, they are generally much less slender (stubbier) than driven piles. However, their capacity is analyzed in generally the same way as conventional driven piles (DNV-RP-E303. See Reference 76. Because they are generally stubbier than other types of pile; they are often (and more correctly) called caissons.

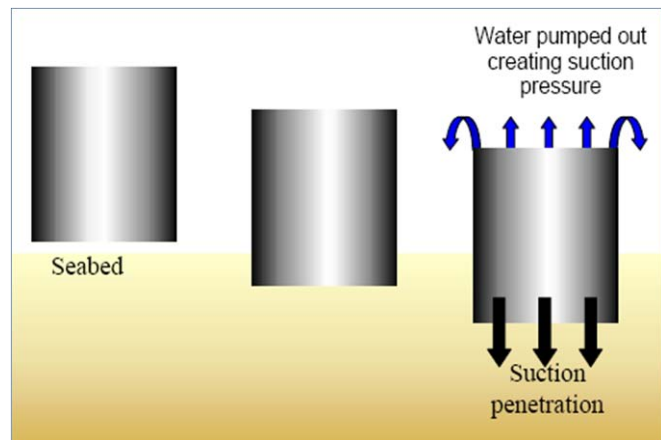

Figure 84 Suction Pie Installation Mechanism

A-3.2.1 Caisson Geometry

In sands, the pressure differential that is applied causes a hydraulic gradient in and around the caisson. Water flows into the caisson due to the suction pressure that exists inside the caisson. If the hydraulic gradient is increased sufficiently, a limiting condition will be reached when the effective stress of the soil inside and below the caisson approaches zero. The limiting condition is commonly referred to as the critical gradient. When the critical gradient is achieved, piping of soil inside and below the caisson occurs. A soil plug is formed inside the caisson due to this effect. A larger diameter caisson configuration has been found to minimize the formation of the soil plug as the gradients are more concentrated along the caisson wall (NGI Publication No. 196, Ref 82).

In both stiff clays and sands, problems arise during installation due to the resistance offered by these stiff soils. To obtain sufficient suction forces to overcome this resistance, larger diameter caissons are used. Shorter caissons with larger diameters are therefore preferred for stiff clays and sands that usually provide sufficient holding capacity. Typically, caissons constructed in these materials have penetration to diameter ratios less than two.

In soft clay deposits, the shearing resistance of the soil usually improves with depth below seabed. Larger penetration depths will be required to mobilize sufficient holding capacity due to negligible side friction along the wall of the caisson. The suction forces that are required to drive the caisson in soft clays are not very high. Therefore, in normally consolidated clay deposits, large penetration depth-to-diameter caissons are typically used.

A-3.2.2 Load Attachment Point

The load attachment point is a very important factor influencing the holding capacity of the suction caisson. Each situation must be analyzed because the location is directly related to the soil type and shear strength profile. However, geotechnical lateral load theory suggests that a load attachment point at mid pile height for normally consolidated clay and mid to 2/3 (from the top) for sand and stiff clay is the proper attachment point to maximize lateral anchor capacity.

A-3.3 Piles of Other Types

Other devices are used for fastening a mooring line to the seafloor, including rock bolts and drilled-and-grouted chains. These devices may be categorized generally as pile anchors, and the analysis of their capacity may be done using generally the same geotechnical relationships.

A-3.4 Pile Anchor Capacity

The capacity of a pile to sustain anchor line pull depends upon the line angle, the pile size and stiffness, and the seafloor material(s). For ease in calculation, the capacity is separated into axial (uplift), and lateral (horizontal) capacities (See “Handbook for Marine Geotechnical Engineering”, NCEL, March 1985 and API RP 2A).

Uplift capacity. The uplift capacity of a vertical pile is its axial pull resistance. In sediments, the axial pull resistance is:

$$HC_u = A_s * f_s$$

where A_s = side area of pile

f_s depends on soil type, as discussed in the following paragraphs.

Cohesionless soils. In cohesionless sediments, the frictional resistance is the lesser of:

$$f_s \leq 0.5 * p_{avg} * \tan(\phi - 5 \text{ deg})$$

$$f_s \leq f_s(\text{max})$$

where p_{avg} = average vertical ground pressure along buried length of pile

ϕ = drained friction angle of soil

$f_s(\text{max})$ = maximum allowable side friction shear stress

Values of ϕ and $f_s(\text{max})$ are given in Table 40

Cohesive soils. In cohesive sediments, the value of f_s depends upon the value of undrained shear strength, S_u . If S_u is less than $0.4 * p_{avg}$, then the soil is normally consolidated, and f_s is approximately equal to S_u . If S_u exceeds $2.0 * p_{avg}$, then the soil is highly overconsolidated, and f_s is limited to about $0.35 * S_u$. For soils in intermediate states of overconsolidation, f_s assumes intermediate values. Refer to Reference 34 for detailed procedures.

Horizontal capacity. The lateral capacity of vertical piles in sediments is a complicated subject. Again, refer to Reference 34 for detailed methods. A good approximation to maximum capacity is obtained by assuming an effective length of pile is held laterally by soil bearing resistance:

$$HCl = f_n * B * L_{eff}$$

where

f_n = normal stress on pile

B = pile width

L_{eff} = effective length

A conservative approximation to the effective length, L_{eff} , is obtained by using the maximum length of pile that can support the required load as a cantilever beam, or one-half of the buried length of the pile, whichever is less.

Cohesionless soils. For cohesionless soils, a bearing capacity coefficient, reduced for horizontal (vice downward) application of load, is applied to the ground pressure:

$$f_n = 0.7 * N_q * p_{avg}$$

where N_q = bearing pressure coefficient for deeply buried plate (buried at least 5 times plate width)

Values for N_q are given in Table 44.

Table 44 Friction and Bearing Parameters for Cohesionless Soils

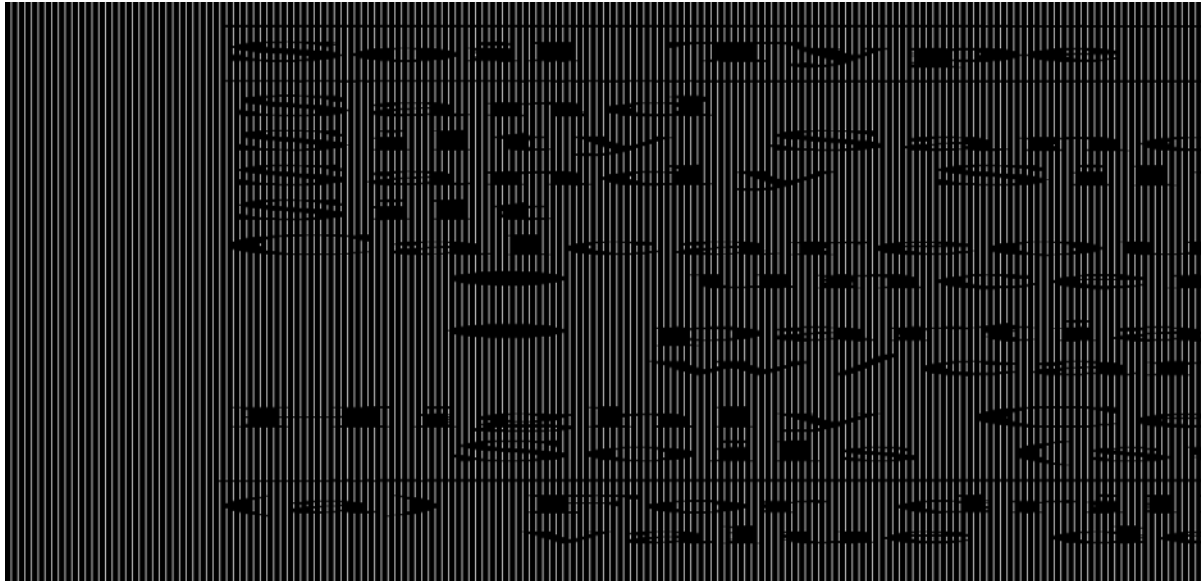

Cohesive soils. For short-term peak load capacity in clays, a lateral bearing capacity factor is applied to the shear undrained strength:

$$f_n = 7.5 * S_u$$

In this relationship, S_u must be determined by geotechnical measurements, or estimated based on geotechnical considerations. A conservative approximation, except where the soil might be underconsolidated, as in a river delta undergoing rapid sedimentation, is

$$S_u = 0.3 * p_{avg}$$

For precise estimates of the long-term sustained load capacity in clays, the drained strength parameters of the soil must be used. Generally, this gives a lower capacity prediction for overconsolidated sediments, but one which will be at least equal to that given by the $0.3 * p_{avg}$ approximation; hence this approximation is recommended as a conservative simplification. For more refined estimates, refer to methods discussed in the “Handbook for Marine Geotechnical Engineering”, NCEL, March 1985 and API RP 2A (References 19, 34).

A-4 Plate Anchors

A-4.1 Plate Anchor Types and Functioning

A plate anchor consists of a “*Deadman*” anchor element that is embedded in the seafloor so it provides good resistance to uplift as well as lateral loading. The plate anchors in common use are categorized as suction-embedded, driven, gravity installed and drag-in plate anchors (Figure 85).

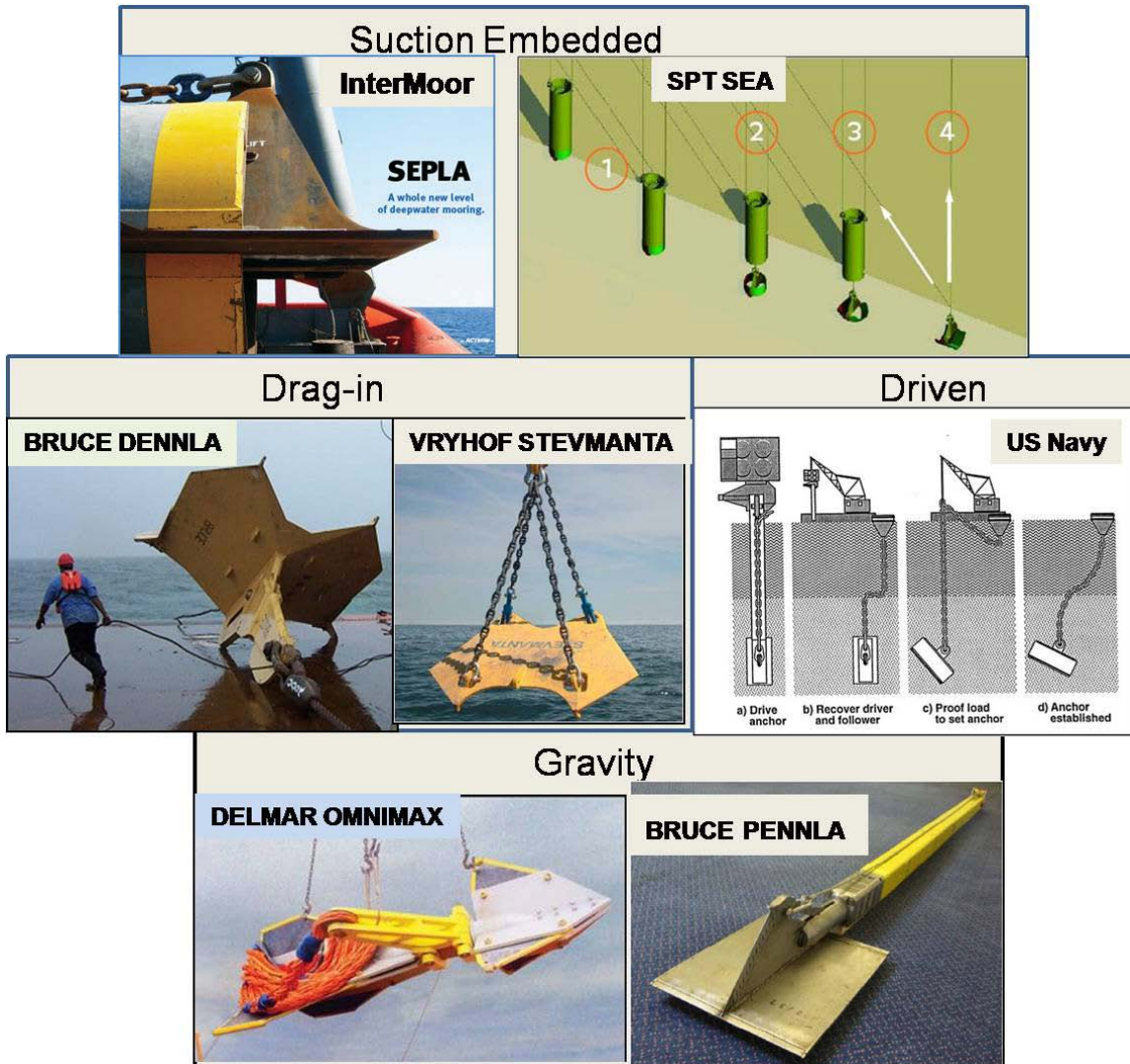

Figure 85 Plate Anchor Types

A-4.2 Plate Anchor Capacity

The uplift resistance of a plate anchor is given by

$$HC_u = A * f_n$$

where A = plate area normal to pull, = $B * L$

B = fluke width

L = fluke length

f_n depends on soil type, as discussed in the following paragraphs

(At angles other than direct uplift, the capacity will be slightly higher, so long as the line attachment standoff distance gives the anchor sufficient moment to rotate to maintain its orientation against the changing direction of line pull.)

Cohesionless Soils. For cohesionless soils, a bearing pressure coefficient, further reduced for upward application of load and adjusted for plate length-to-width ratio, is applied to the ground pressure:

$$f_n = 0.5 * N_q * (0.84 + 0.16 * B / L) * p_{avg}$$

where N_q = bearing pressure coefficient for deeply buried plate (buried at least 5 times plate width); values are given in Table 44.

p_{ave} = overburden pressure in the soil overlying the plate, averaged over a height equal to the plate width

Cohesive Soils. For short-term peak load in cohesive soils, an upward bearing capacity factor, adjusted for plate length-to-width ratio, is applied to the undrained shear strength:

$$f_n = 15 * (0.84 + 0.16 * B / L) * S_u$$

where S_u = undrained shear strength of the soil overlying the plate, averaged over a height equal to the plate width

For long-term sustained capacity in cohesive soils, a conservative simplification is

$$f_n = 9 * (0.84 + 0.16 * B / L) * S_u$$

where $S_u = 0.3 * p_{avg}$

Alternatively, the drained strength parameters of the soil may be used with the method given in Reference 34.

A-4.3 Load Direction and Timing Factors That Affect Plate Anchor Capacity

Plate anchors are normally designed so the plate will be oriented nearly perpendicular to the load direction. This is achieved by careful installation and/or by supporting the line attachment point on a rigid strut that is long enough to provide a moment arm to orient the plate towards the perpendicular as load is applied. However, if the load direction changes, a plate anchor without a reorienting attachment point will be left substantially off-perpendicular, with a substantially reduced projected area normal to the load, and a plate anchor with a reorienting attachment point will travel toward the load as it is reoriented, possibly losing depth and capacity after multiple reorientations.

Aspects of load timing that may reduce capacity are shown in Table 45. “Static” loading will elicit different soil reactions that depend on drainage in sands and creep in clays. “Dynamic” loading is defined in Table 45; cyclic and earthquake loading will tend to reduce capacity somewhat, requiring that an additional safety factor be applied. Definitive specialized analyses may be done to obtain an appropriate value for this additional safety factor, or a value of two may be used as generally conservative.

Table 45 Load Timing Factors Affecting Plate Anchor Capacity

Static	{	<u>Short-Term Loading</u> - An increasing load to failure such that in fine-grained soils drainage does not occur.
		<u>Long-Term Loading</u> - Uniform static load where full drainage occurs.
Dynamic	{	<u>Impulse Loading</u> - Non-rhythmic loads > static capacity, < 10 seconds in duration - sands; < 10 minutes duration - clays.
		<u>Cyclic Loading</u> - Repetitive loading with double amplitude magnitude > 5% static capacity.
		<u>Earthquake Loading</u> - Cyclic loading induced to the entire soil mass by earthquake energy.



APPENDIX B GEOPHYSICAL TECHNIQUES FOR THE INVESTIGATION OF NEAR-SEABED SOILS AND ROCKS

(ABRIDGED EDITION)

(A handbook for non-specialists)

Complete copies of the original document can be downloaded from Fugro's website:

www.Fugro.com

B-1 FORWARD

Offshore Site Study and Investigation Guide: Comprehensive initial study is critical

Utilities have begun to consider offshore energy sources as a new component of the energy grid. Wind, wave, tidal current and ocean thermal energy are the identified potential energy sources.

Offshore vs. onshore

Moving energy technology offshore brings advantages and challenges. The advantages are proximity to population centers renewable resource and the potential to develop larger installations. However, transmission of the energy from a remote offshore facility presents challenges, as well as storage of energy for peak demand. It is expensive to convey energy to shore. As an example, it is estimated that 20 percent of the project cost for the up-to-1000 MW London Array, the world's largest offshore wind farm, will go towards developing a grid connection.

In addition, the energy industry often focuses on the real-time operating challenges of these renewable energy sources, but it is also important to consider the upfront challenges of planning, particularly offshore. One lesson learned during the initial offshore projects in Europe is that an insufficient initial study leads to construction delays and increased project cost. A savings in terms of time and cost could have been achieved if the physical conditions underlying the site had been better understood earlier.

Site assessment

Offshore structure design, especially wave- and current-energy-capture devices, requires information on the environment where the energy harnessing equipment will operate, as well as information specific to the particular energy source they seek to harness. Right from the feasibility stage of an offshore wind energy project, information on the region's seismicity, water depth, climatology, and a review of the existing wind, wave, current, and tide level data for the site can provide early screening for suitable areas and structure types. Data regarding the region's geology and subsurface conditions will provide an indication of anchoring, foundation and transmission line design requirements.

As the project takes shape more detailed data will be required for designing the structures. Questions to be answered include:

- What are the 100-year extreme values for wave heights or wind speeds?
- What is the best time of year for installation?
- What is the forecasted power output from the installation?
- What foundation system will be used?

Cost-effective answers to these questions can be had through statistical analyses using a combination of carefully-tailored measurement campaigns, site investigations, and modelled data. Real-time data on parameters such as wave conditions, tidal height, and weather conditions will help with the planning of the installations.

While it is often sufficient to use existing data sources and models for feasibility studies, it is usually essential to make at least a few months of site-specific measurements to fully validate wind, wave, or current criteria used for engineering purposes. In particular, measurements during the winter months are essential for validating statistics towards the extremes of likely conditions. Site assessment and other engineering aspects of designing, and installing the necessary infrastructure have been discussed and detailed in conferences like the Marine Technology Society for Offshore Wind Power Workshop (June 2009) and the guidelines for marine renewable energy projects by the Mineral Management Service

(http://www.mms.gov/offshore/RenewableEnergy/PDFs/REnGuidebook_03August2009_3.pdf.)



Portions of the foreword, authored Matthew Pollard, PE, Project Engineer with Fugro West, Inc. have been previously published in Intelligent Utility.

Pollard, M., "Offshore Wind: Comprehensive Initial Study is Critical". Intelligent Utility. May/June 2009. pp. 41".

Phases of a Site Assessment

A brief outline of typical phases of a site survey and assessment are presented following based on a typical scope of work for a site and route investigation for an offshore renewable energy project. The technical guide following is based on upon existing Fugro survey practices. Wave energy projects are typically in shallow water (less than 1000m), and involve foundations such as anchored moorings or gravity based foundations, although pile foundations (suction piles and otherwise) can be used depending on foundation conditions. Assessment of climate and wave conditions, critical to site selection, is typically performed separately and in advance of the site surveys, and is not discussed herein

The site assessment should provide a comprehensive, reliable, and high resolution survey solution consisting of geohazard data acquisition, seafloor characterization and reporting along a power cable corridors and project anchoring sites. All operations should support the survey, measurement, study and investigation of the bathymetry, seabed features, shallow geology and potential hazards at the proposed anchor sites and along the cable route.

Typical Phases of Successful Site Assessment

- Team Selection - based on qualifications and experience
- Comprehensive Desktop study (based on existing data)
- Survey plan (based on DTS)
 - Permitting
 - Landfall and site visits
- Survey execution (offshore and near landfall sites)
 - Shoreline
 - Bathymetric
 - Geophysical
 - Bottom Imaging
- Data Interpretation and Reporting
- Optimization of project siting and cable routes (using GIS, and 3D imaging tools such as Fledermaus)
- Final recommendations for siting and cable routes

One of the most important aspects of having a site assessment performed is choosing the right firm to perform the study, a firm which can work in collaboration with the project owner and engineering design team. Because the technology is relative new, and structures are being placed in environments with challenging conditions, all team members need to have the right qualifications and experience.

The technical guide following presented herein is an abridged version of Fugro's *GEOPHYSICAL & GEOTECHNICAL TECHNIQUES FOR THE INVESTIGATION OF NEAR-SEABED SOILS AND ROCKS*, which can be found in it's entirety at <http://www.fugro.com>

B-2 Preface

For the professional geotechnical engineer, geologist and geophysicist, there are many excellent textbooks, articles, and papers, as well as numerous international, national and industry codes of practice and guidance notes on the subject of seabed investigation. However, there are few informative handbooks that cater for the non-specialist Project Manager and other professionals requiring a working knowledge of the subject to better facilitate meaningful dialogue with their specialist advisors and with their contractors.

The objective of this handbook is to provide an overview of the geophysical and geotechnical techniques and solutions available for investigating the soils and rocks that lay beneath the first few metres of the seabed.

The project types covered by this handbook include:

- Pipelines for oil & gas product transport
- Oilfield control and communications infrastructures
- Submarine telecommunications and power cables
- Seabed structures and production facilities
- Seabed protection ‘glory holes’
- Seabed stability studies
- Anchoring studies
- Environmental impact studies
- Dredging and aggregates
- Outfall and landfall engineering

This handbook is the result of consultations with some of the leading specialists in the fields of geophysics and geotechnical investigation. These discussions have been transcribed into plain language without recourse to complex science, mathematics, or lengthy descriptions of complicated procedures.

Every project and every situation is different; the subject itself is highly technical. To ensure a project’s successful outcome depends on securing the services of highly competent contractors and technical advisors. It should also be noted that any reference in this document to achievable soil/rock penetration, production rates or weather limitations and the like, are provided for general guidance only. What is achievable will always be governed by a combination of factors, such as geology, water depth, and environment and vessel capabilities.

It is hoped that this handbook will fill a knowledge-gap and provide a useful guide to the science, its application, and technology.

I would like to thank Mr EFS Danson MRICS FInstCES of Edwin Danson Associates for compiling and editing this document on behalf of the Fugro Group.

Eugene Toolan,
Chief Operating Officer
Fugro NV

Disclaimer: Please note that the specifications of equipment described in this handbook are continuously evolving. Fugro accepts no liability for the accuracy of the information herein provided or the use to which it is put.

B-3 Introduction

Geophysical surveys and geotechnical investigations are seldom performed without an end objective in mind. In general, the objective is the engineering design, construction and installation of some sort of seabed structure.

The environments in which these operations take place vary greatly and can have a major influence on the choice of surveying and geotechnical system(s) used and have an impact on the field operations, not the least of which is safety. To better categorise these environments the geo-industry has developed an empirical operating scale:

Category	Description
Harsh	An environment such as the North Sea and the North Atlantic seabords where there is a high frequency of sudden storms.
Tropical seas	Normally benign and swell-free regions but which lie within tropical storms paths. Such storms are invariably announced by weather warning notices.
Bounded seas	Enclosed seas such as the Caspian, Mediterranean and Black Sea that are free of oceanic swells but where storms can be sudden.
Benign tropics	Areas, such as the west coast of Africa, with continental shelves open to the ocean where storms are infrequent but which suffer from prolonged intervals of long-period swells.
Arctic	In general the high latitudes bounded by the limits of summer sea ice. These areas are subject to sudden storms and, beyond their equinoctial circles, provide limited working opportunities.

Water depths also affect geophysical and geotechnical activities and dictate the sort of techniques and instrument systems required and their operational effectiveness. Generalising, water depth limitations of geophysical remote sensing systems differ from those that constrain the geotechnical systems. While this is not a practical difficulty, it is worth considering as it can influence the mode of operations, especially where geophysical and geotechnical activities are combined.

Geophysical depth ranges		Geotechnical depth ranges	
Inshore, ports and harbours	<25m	Shallow water / near-shore	<20m
Shallow water	25m - 250m	Offshore	20m - 500m
Medium depth	250m - 1,500m	Deepwater	500m - 1,500m
Deepwater	1,500m - 3,000m	Ultra-deepwater	>1500m
Ultra-deepwater	>3,000m		

Regulations, standards and permits

All marine activities are subject to international and/or national regulations and industry operating standards. A number of the international regulations such as those of the International Maritime Organisation (IMO) have not necessarily been ratified by all participating nations although they may in whole or part have been adopted by, or have become accepted practice of, individual nation states.

Many of the operational and technical facets of geophysical surveying and geotechnical investigations are included within various standards and codes of practice.. Invariably, a program of offshore work will require permits from the maritime authorities and from the various departments having jurisdiction over operating areas such as offshore oil and gas fields and their associated infrastructure of pipelines and work zones. Likewise, cable surveying and installation operations will require permits that will include beach landfalls and site access.

When preparing a specification for an operation, there is sometimes the temptation to assume the standards and regulations, requirements, procedures and permit arrangements of an earlier job can be applied. Unless there are substantial grounds for believing this, the practice should be avoided, as there is the greatest risk of oversight that can have serious safety, legal and financial consequences.

Desk studies and planning

The chances for a successful outcome to a seabed investigation are significantly improved when the work program commences with a properly structured desk study. Time and again this sensible precaution has demonstrated savings in time and cost, and always leads to an improved end product whilst providing the engineer with an early overview of site conditions and expectations upon which to base preliminary designs.

Desk studies centre on the requirements of the end product such as a platform, pipeline, cable, or anchor installation, but must also consider the environmental impact of the proposed engineering and the wider consequences of the work. Desk studies comprise the collection of information from public, in-house and commercial sources that can be evaluated to develop overviews on:

- The regional quaternary geology, surface sediments and seabed morphology
- Probable geotechnical conditions, nature of seabed soils and rocks etc
- The local topography (bathymetry)
- The meteorological and ocean environment, tides, currents, weather patterns, sea states etc
- Existing seabed structures and obstacles such as cables, pipelines etc
- Fishing and other marine activity

A desk study alone is not sufficient for detailed engineering purposes but will lead to a sensible operational plan that considers the environmental factors that may affect the work. It will identify an appropriate level of technical specification to meet the objective while allowing for the unforeseen eventuality. The desk study can also address the peripheral issues of regulations, standards and permitting.

Specifications

Assuming an operation will be intrinsically safe, and that all the statutory and legal issues are correctly addressed, specifications tend to fall into one of four classes:

- i. Same as last time. Where it can be shown that the parameters for a new work program are essentially the same as a previous job, then using the last specification is a reasonable choice. However, few jobs fall into this category even though, on first glance, the conditions appear similar. The end product must always be the first consideration; an earlier work program for, say, a template emplacement will be substantially different to that for an anchoring operation in the same vicinity. Apart from the very different geotechnical requirements, reliance on a previous specification will lead to erroneous design assumptions, technical failure and financial risk.
- ii. Best technical. The best technical solution for a particular engineering problem may still not be the correct choice. For many reasons it may not be feasible because of time constraints, or the remoteness of location, or on cost grounds. The choice of the best technical solution should always be based upon a cost-benefit analysis.
- iii. Lowest cost. Here the question must always be ‘does the solution offered meet the requirements of the objective?’ Apart from the obviously inappropriate, the solution provided by the lowest bid is frequently technically marginal. The risks are considerable when the results from an investigation, depending on marginal techniques, do not provide adequate design information or, worse, do not identify potential hazards or weaknesses. The risks of damage and/or failure of the end product structure are very high; remedial action or intervention costs will escalate as will the hazards posed to the environment.
- iv. Most reliable on timing. A properly conducted desk study will inevitably lead to a reasonable estimate of time required. An appropriate proposal that meets the technical requirement and offers reliable timing (assuming this is sensible) can be evaluated simply on cost-benefit terms.

B-3.1 Applications

Pipelines for oil & gas product transport

Pipelines by their very nature demand protection from their environment and vice versa. In areas of seabed engineering, or other activity, or where the soils offer maximum cost-efficient protection, pipelines are invariably trenched and either left to naturally back-fill or back-filled mechanically with the excavated soil or are covered with a rock berm. Where pipelines are laid on the seafloor or part trenched, rock dumping or a layer of concrete ‘mattress’ affords protection.

Geophysical surveys, using side-scan sonar for imagery and multibeam echosounders for bathymetry, provide information on the topographic and seabed surface texture while sub-bottom profilers provide information on the structure of the soils and rocks beneath. Geotechnical investigations, using coring and Cone Penetration Tests (CPTs), provide the ‘ground truth’ for the remotely sensed data and information on the soil and rock types to determine seabed-loading characteristics.

Pipelines are also prone to seabed sediment movements, seawater currents and fish action that result in scouring and suspended sections. Environmental assessment and seabed stability studies identify these risks and can suggest suitable remedies and precautions.

Submarine telecommunications and power cables

Submarine telecommunication cable systems are especially vulnerable to damage between their landfalls and the edge of the continental shelf. Damage to these systems is costly to repair and the loss of revenue from a single day’s downtime can easily exceed \$1M. Fish bites, scouring and chafing are all sources of potential damage. In regions of mobile sand, a buried cable can quickly become exposed and, in areas of fishing activity, cables are at great risk from trawls.

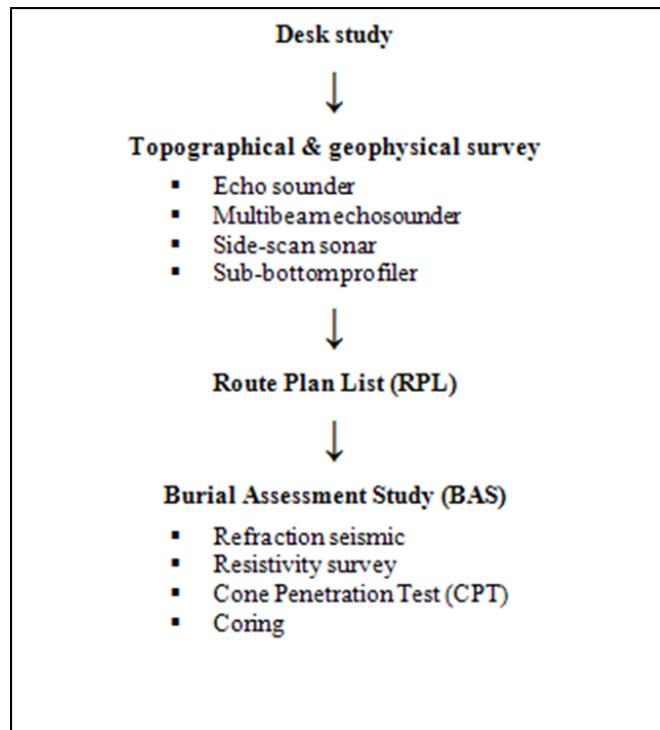

Typical workflow for a cable burial assessment study program



Vessel anchoring is another source of danger, especially in softer sediments where the anchors tend to drag before finding a holding ground. To protect cables from deepwater fishing activities, in vulnerable areas down to 1,500m water depth, cables are now frequently buried. Cable burial is normally performed simultaneously with the lay using a special plough or, in softer sediments, a high-pressure water jet. Burial depths vary up to 3m, occasionally even deeper, although the current norm is 1 to 2m.

The nature of the seabed soils dictates the method of burial; to ascertain these parameters, geophysical and geotechnical investigations are mandatory. Seabed morphology is imaged using multibeam echosounders and side-scan sonar while sub-bottom profilers determine the sediment layers and may identify zones of buried boulders and surface cobbles. Once a potential cable route is settled on, geophysical tools such as refraction seismic and resistivity systems, and geotechnical tools such as cone penetration tests (CPT), soil cores and grabs samples, provide the all-important cable burial assessment study (BAS) data. This data is used to select burial methods and optimise ploughing system configurations.

Seabed structures

Foundation engineering studies are critical for all structures placed on the seabed. The impact of proposed structures has also to be assessed for their effect on other structures and their influence on the local (and regional) environment.

Surveyors and geophysicists use high-resolution geophysical systems to image the proposed work location(s), to assist engineers with their preliminary studies, and to generate data on the surrounding area for environmental impact assessments. After site selection, the same tools provide detailed topographic and morphological information of the sites and information on the sub-surface conditions.

Soil types, strengths and characteristics are assessed from samples recovered by coring and rock drilling augmented by grids of CPTs and other in-situ tests.

Oilfield subsea structures are connected with a network of control 'bundles', umbilical and communication and power cables. This infrastructure is crucial to the safe and economic operation of a field and the demands for protection are great. Trenching, backfill and rock dump protection methods are all employed and all require detailed geotechnical, geophysical and environmental impact assessment studies to determine the safest and most appropriate method of risk reduction.

Seabed stability studies

Few areas of the world's seas and oceans are benign; seawater currents, temperature gradients, unstable soils, tides and wave action directly or indirectly affect the shallow soils of the seabed. In the higher latitudes, glacial and post-glacial activity has left complex and often unstable seabed conditions. Gas leaking through sand can produce very hard concretions or, in soft clays and silts, potentially volatile 'pock-marks' or gas-charged sediments. In some areas, mobile sands traverse the seabed resulting in sand bedforms that range from small ripples through the larger 'mega-ripples' to dune-size masses.

The movement of mobile sands and thinner sediments alternately cover and uncover structures placed in their path while current eddies cause scouring in loose sands and softer sediments; pipelines are particularly vulnerable to these effects.

In the deep oceans, the extreme pressure and low temperatures can result in potentially hazardous frozen gas hydrates. Even on the shallowest of slopes, mudslides can develop that travel for many kilometres, added to which swift currents and the near-freezing conditions make the deepwater a particularly challenging environment.

Seabed stability studies depend upon high quality data; geophysical surveys using side-scan sonar provide clear images of seabed morphology, easily identifying mobile sands and boulder fields, while multibeam echosounders provide the accurate topographic detail for slope determination and the exposed size of geological features. Sub-bottom profilers image the seabed identifying the complexity of the soils, the possible presence of zones of buried boulders, faulting and fissures, gas leaks and signs of trapped gas



pockets. Geotechnical samples and in-situ tests provide the ground truth data for the geophysical interpretation.

Seabed protection ‘glory holes’

In active areas where seabed damage can be extreme, such as from iceberg scouring, seabed structures and their infrastructure can be protected within large, man-made, ‘glory holes’. Typically, these holes can be up to 100m across and 10m to 15m deep. A geophysical survey will provide information on the penetrating depth of scouring and hence the minimum depth of the hole. The successful excavation of glory holes depends on a detailed geotechnical study to determine the soils’ characteristics, strengths and friction angles in order to design the program and select the most appropriate method.

Anchoring studies

Increasingly, engineers are recognising that temporary heavy mooring anchors, for example of semi-submersible drilling units, require as much geotechnical consideration as permanent anchoring systems. A geotechnical study will allow calculation of the most appropriate anchor size and best fluke angles for maximum penetration and holding strength.

In problem grounds, the traditional method of anchor tensioning of a semi-sub can take five days or even more. In extreme cases, this can lead to a complete re-appraisal of the drilling location. The cost associated with a five-day overrun in mooring-up, including lost production time and increased weather downtime risks, can easily exceed several million dollars. A geotechnical study of an anchor pattern will lead not only to correct anchor choice and set-up parameters, but will quickly identify weak or unsuitable grounds at an early enough stage to avoid costly re-design or re-appraisal.

Environmental impact studies

Protection of the environment from engineering or other human intervention, and to preserve the natural balance, begins with a careful appraisal. Geophysical surveys can map the terrain, identify its boundaries and provide the framework of topology but do not necessarily provide any qualitative information on the ecosystem. On the other hand, geotechnical sampling, especially box corers, will preserve undisturbed seabed samples of benthic colonies and worm populations upon which other life forms, such as fish stocks, depend.

Geotechnical methods, geophysics and other remote sensing methods, can all be employed to identify and examine the habitats of endangered corals, chemosynthetic life forms and other oceanic populations.

B-3.2 Vessels and deployment systems

Major geophysical surveys tend to be conducted from specialist survey vessels specifically fitted for deploying and handling both geophysical and geotechnical systems. Onboard, the surveyors, geophysicists and others specialist personnel are provided with laboratories, workshops and computer processing and plotting facilities. These vessels can remain at sea for many weeks.



The Geo Surveyor, geophysical survey ship

Near seabed geotechnical surveys can be performed from most vessels equipped with an A-frame or other suitable crane handling systems. Where office or cabin space is at a premium, special containerised workshops and laboratories can be installed, e.g. on back decks of workboats. Inshore and coastal surveys are normally conducted from launches or from small vessels such as fishing boats.

The smaller geotechnical apparatus, such as grabs, gravity corers, vibrocorers and lightweight CPT systems, can be deployed from survey ships or other of the larger sort of vessel. Heavy or specialist geotechnical systems require dedicated specialist geotechnical vessels fitted with heavy duty A-frames, cranes and winches.

Calculating the size of cranes and A-frames is the work of the marine engineer; safe working loads (SWL) are calculated based on the mass of the tool and its tow or lifting cable together with the maximum dynamic stresses likely to be encountered retrieving the tool from the seabed. Some tools, such as the corers, have to be pulled out of the seabed and the mass of grab samplers increases threefold as they collect their large samples. Other tools, such as deep-towed bodies, or refraction seismic systems which are towed across the seabed impose considerable strains on their tow cables and systems.

Ships conducting coring or in-situ testing operations have to maintain station vertically above the core/test location during the operation. This is best achieved if the vessel has a dynamic positioning system or joystick-controlled thrusters. Alternatively, a multi-point anchoring system may suffice, although this can increase operational times and is usually impracticable in deepwater.

Attention to detail is required when selecting a vessel; a low-cost vessel can easily turn into a financial liability and seriously jeopardise a project. The vessel's weather keeping attributes are vital in harsher environments where sea-state can easily terminate an operation with an ill-considered ship. A vessel's capacity for deploying and recovering systems requires closest attention, especially if it is new to the work. If cranes or A-frames have to be fitted, then the ships structure needs to be surveyed to ensure its integral strength is sufficient.

Any survey or sampling vessel must meet modern health and safety requirements and have fully up-to-date certification for her lifesaving aids, communications and navigation, as well as for work systems such as cranes, winches etc.

For most geotechnical investigations requiring seabed penetration greater than 10m, drilling methods will be required. The exceptions to this are the use of long piston corers, of 20m to 30m in length, which can be used in soft deepwater clay deposits, and the bigger seabed CPT systems, both of which require large vessels with specialist deployment equipment and sufficient deck space and facilities for a safe operation.

A detailed description of geotechnical drilling systems and operations is outside the scope of this document, but a brief summary of the main methods employed is given below.

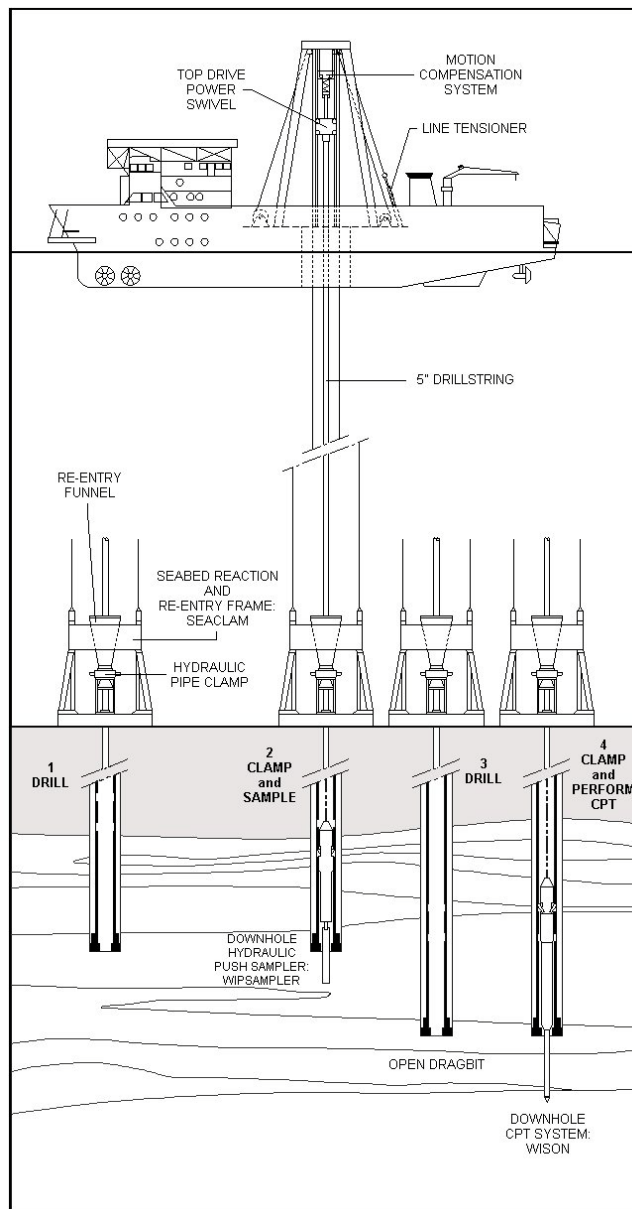

Typical procedures for drilling, push sampling and in-situ testing

Geotechnical Drillships

Most deep geotechnical investigations are performed from dedicated, purpose built or converted, vessels. Since drilling operations can take several days per borehole and verticality of the drill string is critical, the use of dynamic positioning or a four-point (minimum) anchoring system is essential. A heave-compensated rotary drilling technique is used, typically utilising 5" o.d. steel drill pipe and an open-faced dragbit. In ultra deep waters, aluminium drill string is usually required. Sampling and in-situ testing is performed via wireline operated downhole tools. The highly controlled nature of the sampling and testing operations means that, for the majority of ground conditions, this will provide the highest achievable quality of samples and test data.

The size and favourable weather-keeping characteristics of such vessels can, in many situations, also make them cost-effective for shallow penetration investigations.



Geotechnical drillship

Geotechnical Jack-up drilling rigs

Drill ships can, in favourable circumstances, operate in water depths as shallow as 20m. In extreme circumstances, shallow-penetration investigations may be feasible in water depths as shallow as 10m. However, the primary method for drilling boreholes in water depths from around 20m to shore – including the inter-tidal zone – is with a jack-up drilling platform. Such platforms are typically capable of both rotary and percussive drilling techniques, high quality sampling and in-situ testing.



Geotechnical jack-up drill rig

B-4 Geophysical techniques

B-4.1 High resolution reflection systems

Function and applications

Geophysical surveys make measurements of the seabed and the sub-seabed using sound or, at close quarters, laser light. The sensors tend to fall into three categories:

- Seabed measuring sensors, e.g. echo sounders, multibeam sounders
- Imaging sensors, e.g. side-scan sonar, laser-scan, acoustic scanning systems
- Sub-bottom profilers, e.g. pingers, boomers etc

The most common combinations of system sensors for engineering applications are:

- Echosounder – for measuring the water depth directly beneath the vessel. This also acts as a calibration device to the multibeam sounder.
- Swathe bathymetry – for measuring a wide swath of seabed soundings either side of the survey vessel.
- Side-scan sonar – for generating a scaled image of the seabed morphology and features
- Sub-bottom profiler – for determining the stratification of soils to a depth of, say, 50m beneath the seabed, depending on frequencies and energy levels.

System technology and science

Acoustic energy (sound) is the most common source for underwater measuring and sensing systems. Over very short distances, in higher quality water, a new generation of scanning systems use laser light but these systems are beyond the scope of this guide.

In operation, an acoustic energy source generates a pulse of sound that travels through the water column and, where powerful enough, penetrates into the seabed. The sound energy is reflected back as an echo to a receiver system and the lapse in travel time from transmission to reception is converted into ranges.

The media through which the sound passes affects the acoustic signal in various ways. The denser a medium, the faster is the speed of sound; hence, as the wave front passes through different water densities, its rate of progress varies. At the interface between media, a change in the properties will cause some energy to be reflected; this is most prominent at the water/soil interface and between soil strata.

The two fundamental characteristics of the acoustic wave used in geophysical survey are amplitude and frequency. Different acoustic and seismic tools operate within different amplitude and frequency ranges, and provide information on different aspects of the physical environment. In the simplest terms, high frequency, low amplitude signals provide high-resolution information in the water layer and shallowest depths sub-seabed, and have a shorter range. A low frequency, high amplitude signal will travel further into the earth, but has lower resolution.

To generate different frequencies and amplitudes of acoustic energy, transducers of many types are used. Electro-mechanical transducers generate acoustic pulses in echosounders, side-scan sonar, pingers, boomers and chirp sonar. Electrical discharges generate acoustic energy in sparker systems. Air gun systems convert compressed air pressure into high-energy acoustic pressure waves in seismic sources. Returning signals are detected using pressure sensitive transducers and hydrophones. The pressure pulses are converted to electrical energy for measurement and storage.

B-4.1.1 LiDAR systems for shoreline surveying

The use 3-D Laser Scanning System designates the acquisition of 3D data by means of one or several laser scanners mounted on a mobile platform, and is the latest technology in marine surveying. Fugro uses this system along with its bathymetric data acquisition systems to characterize shorelines above the

water and below the water in one survey pass. The goal of dynamic laser scanning is the recording of 3D data of object surfaces by taking the following requirements into account:

- time-efficient data acquisition in expanded target areas
- automatic registration of 3D data in a common coordinate system
- high resolution and high accuracy of the registered data



Fugro's Optech Dynamic Mobile Laser Scanning System comprises:

- an Optech ILRIS 3-D Laser Scanner,
- an IMU/GPS System which measures the position and orientation of the mobile platform within the world geodetic system WGS84. The differential GPS System consists of a stationary base station and a so-called rover on the mobile platform
- a Software aimed at merging the geometric profile information (laser scan data) with the position and orientation data of the scanning platform
- a rigid and shock absorbing Mobile Platform
- optional synchronized digital photo camera(s), mounted on the same platform

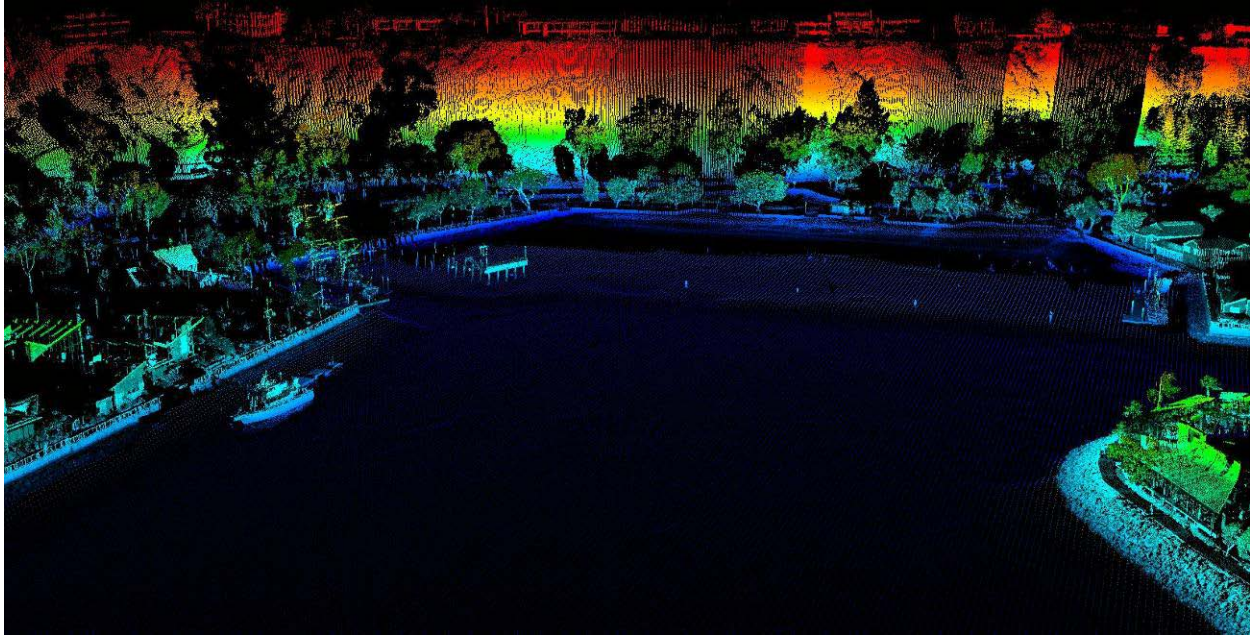

Data Examples

Dana Point Harbor, Shoreline and Bluffs

Dana Point Harbor Entrance, Laser Scanner and Swath Bathymetry

B-4.1.2 Sounders

Echosounders

The echosounder measures water depth by measuring the two-way travel time of a high frequency pulse

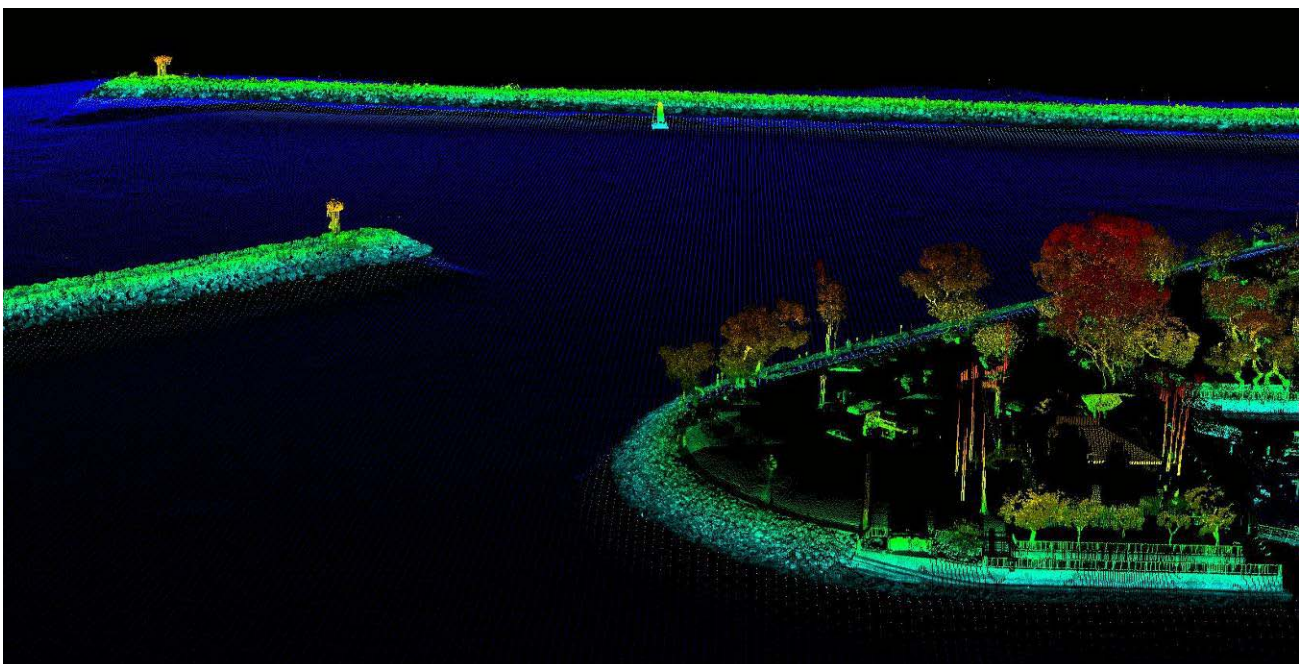



emitted by a transducer. The system must be calibrated to allow for errors introduced by temperature and salinity and other factors that affect sound velocity. The choice of echosounder depends on many factors including accuracy requirements, depth of water and resolution. Typical frequencies range from 10kHz to 200kHz.

Until the introduction of multibeam instruments, echosounders were single beam devices, operating vertically below the survey vessel to gather a single line of sounding.

Swath echosounders

Multi-beam or interferometric swath echosounders have become increasingly common and provide the geophysicist with a powerful seabed-modelling tool. Each transducer produces a fan of acoustic beams to provide sounding information either side of the vessel's track. The high-performance systems have wide-angle swaths that cover an area up to 10 times water depth; more typically, the swath width is twice the water depth. As water depth increases, range increases, but maximum range becomes limited due to acoustic energy depletion of the outer beams.

The accuracy of swathe systems is critically dependent on the correction applied for vessel motion, (heave, pitch, roll, yaw etc); consequently, a swathe system is integrated into many other specialist sensors within the ship or subsea vehicle such as an ROV or AUV.

The chief advantage of swathe bathymetry systems is the high rate of productivity and excellent data sample density, especially in deeper water. Swathe systems can be hull mounted in the ship, installed in a towed body (tow-fish) or in other remotely operated platforms. While hull mounted systems are easier to calibrate than towed systems, a towed system offers more portability and can be deployed closer to the seabed. Many swathe bathymetry systems also record backscatter (reflected energy) from the seabed, similar to side-scan sonar images (see below).

Advantages and limitations

Excluding the more sophisticated deepwater systems, echosounders can be fitted to most vessels either by an over-the-side mount or through a special opening in the ship's hull.

Multibeam echosounders come in a wide variety of sizes depending upon their function. The large deepwater and oceanic systems require large transducer arrays (4-7m long) that have to be purpose built into a ship's hull (a very expensive procedure) hence are restricted to specialist survey ships. For water depths less than say 500m, multibeam systems can be installed on over-the-side mounts but function at their optimum when fitted as purpose-built installations. Shallow water (<100m) systems, being more compact, are normally fitted as temporary installations.

All echosounders require careful installation to avoid sources of interference such as cavitation or acoustic noise. Echosounders require calibration that, in the case of the multibeam, is a complex procedure that can take six or more hours to complete; time must be allowed for this critical procedure. Frequent measurements of seawater density and salinity are also needed to determine the ever-changing speed of sound; these can be performed underway using disposable SV (sound velocity) probes, or by stopping the vessel at intervals to take a 'SV cast'.

B-4.1.2 Side-scan sonar

Side-scan sonars provide an acoustic 'oblique photograph' of the seafloor. By ensonifying a swath of seabed and measuring the amplitude of the back-scattered return signals, an image is built up of objects on the seabed and information on the morphology (the different material and features comprising the seabed surface).

High frequency sonar (e.g. 500kHz) provide high-resolution images, but with short (100m) ranges. Lower frequency systems (e.g. 60kHz) provide long ranges (500m) but with lower resolution. Side-scan sonar tow-fish can be towed deep or shallow depending on requirements. Alternatively, the systems can be

mounted in steerable ROTVs (remotely operated towed vehicles), ROVs (remotely operated vehicles) and AUVs (autonomous underwater vehicles).

In deeper water, tracking a towed side-scan fish is problematical as acoustic tracking systems are typically limited to a range of approximately three to four kilometres; in 1,500m of water, at least 5km of cable is required to position the fish at the required depth. Developments to overcome this problem include using a second vessel (chase boat) to track the fish directly from above (costly), or deploying the side-scans on remote platforms (see below).

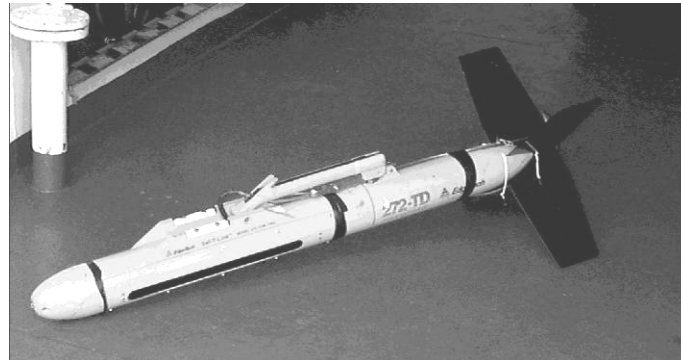

Edgetech side-scan sonar

Advantages and limitations

Side-scan sonar is probably one of the most useful tools developed for imaging the seabed. The clarity of the image, especially from the latest systems, is extraordinary. Developments in sonar imaging continue to move forward rapidly. Its use in seabed classification systems is discussed below.

Side-scan sonars in towed fish require a powered winch and a suitable system for running out the cable; normally an A-frame. The smaller, shallow water systems can be deployed from most vessels but the deeper towed systems operating at, say 1,000m depth, require a cable some 5,000m long and therefore a large winch. The so-called 'deep-tow' systems are very large towfish, 4 or 5m long, and are heavy. They require a large powered winch and special launch and recovery systems and therefore are restricted to specialist survey vessels. The normal tow speed for a side-scan survey is about 4 knots; however, as operating depth increases, so the drag and strain on cables increase. A deep-tow system operating at 2,000m will reduce tow speed to 1 or 2 knots, greatly adding to the time required for a survey.

Because of the long length of the tow cable, surveyors have to allow for a 'run-in' and 'run-out' equivalent to the length of the tow to ensure the required area is covered; likewise, turning time with long cables increases such that a deep-tow can take several hours to complete a line turn. These factors must be taken into consideration when planning and costing an operation.

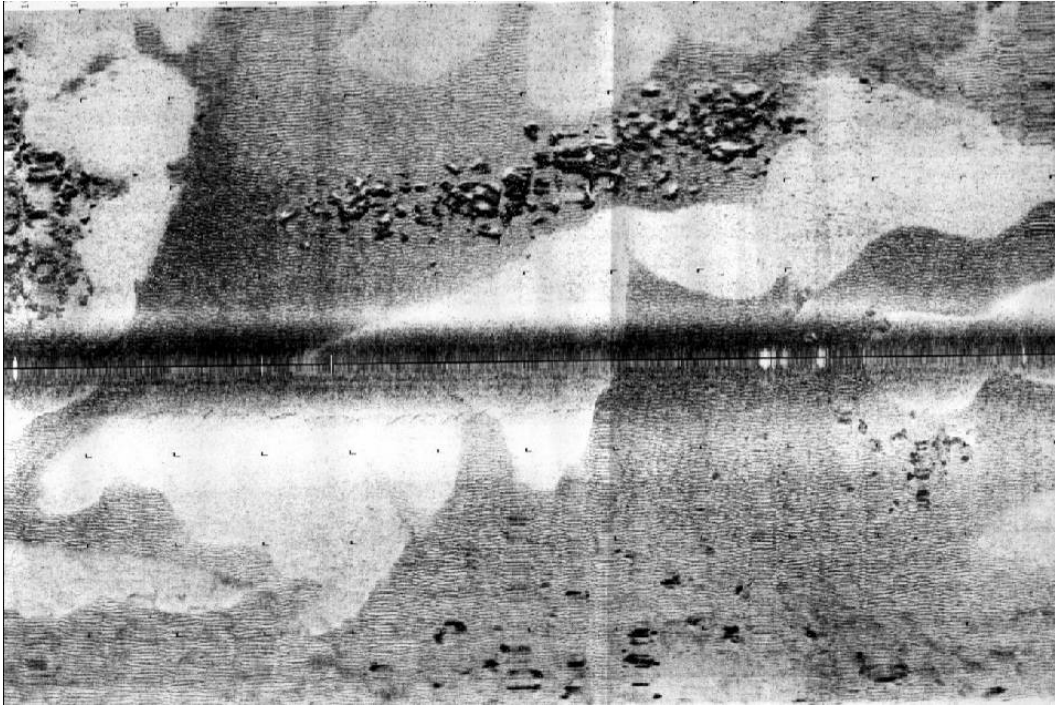

Side-scan sonar image of seabed

B-4.1.4 Sub-bottom profilers

Sub-bottom profilers, sometimes referred to as single channel systems, are used throughout the industry for the shallowest seabed profiling.

Pingers

So-called because of their high frequency acoustic ‘pings’, Pingers operate on a range of single frequencies between 3.5kHz and 7kHz, can achieve seabed penetration from just a few metres to more than 50m, and are capable of resolving soil layers to approximately 0.3m. The high frequency profilers are particularly useful for delineating shallow lithology features such as faults, gas accumulations and relict channels.

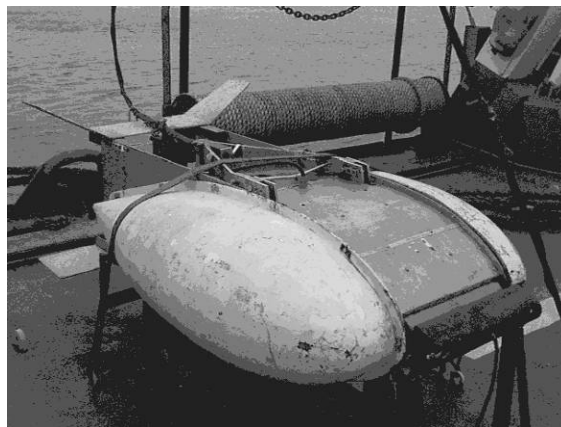

Pinger sub-bottom profiler

Boomers

These instruments have a broader band acoustic source between 500Hz to 5kHz and typically can penetrate to between 30m and 100m with resolution of 0.3m to 1.0m and are excellent general-purpose tools.

Sparkers

These very powerful instruments can penetrate soils and rocks to 1,000m+ but, because of their unstable pulse waveform, they are not in such common use as in the past.

CHIRP

The CHIRP sub-bottom profiler is a recent introduction to geophysical survey. Designed to replace the pingers and boomers, CHIRP systems operate around a central frequency that is swept electronically across a range of frequencies (i.e. a 'chirp') between 3kHz to 40kHz and can improve resolution in suitable near-seabed sediments.

Comments on single channel systems

The single channel acoustic systems provide an excellent range of tools for remotely imaging near-surface soils and rocks. Care is needed not to overreach their capabilities; for example, as the depth of soil penetration increases, so the single channel systems begin to suffer from decreasing signal-to-noise ratios and from multiple reflections. These multiple reflections are the result of acoustic energy being reflected between pairs of horizons before returning to the receiver. The so-called ghost echoes become superimposed on real data causing masking and interpretation difficulties. The problem of 'multiples' is particularly acute within the water column because the sea surface and seabed interfaces are strong acoustic reflectors. These strong reflectors give rise to 'seabed multiples' of real reflections confusing the record. The same factors affecting side-scan cables apply, although the length/depth ratio is somewhat less. A limitation with the higher frequency profilers is that, in the presence of gas or hard soils or biologic colonies, acoustic penetration can be severely reduced or even arrested.

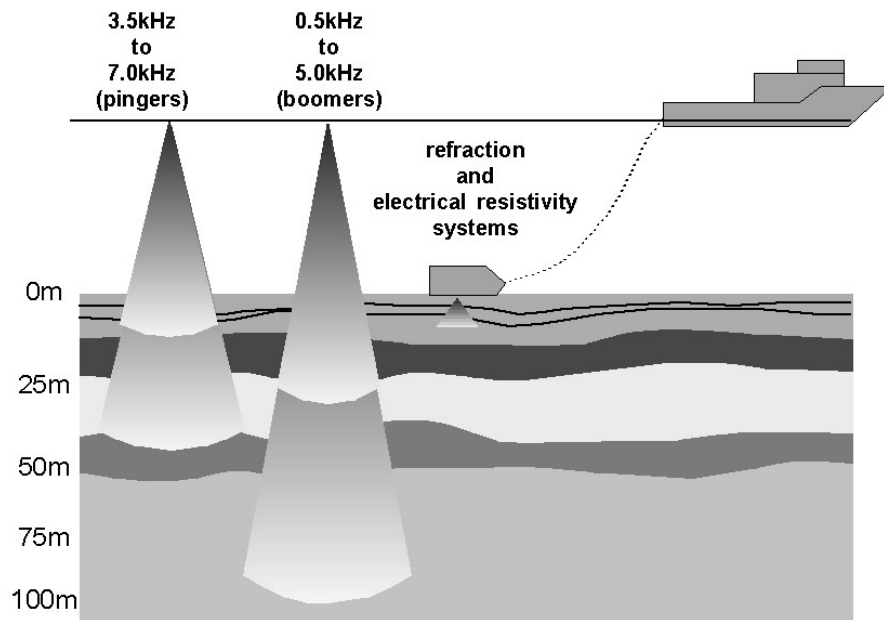

Typical seafloor penetration ranges of geophysical systems

B-4.2 Remote geophysical platforms

B-4.2.1 Remotely Operated Vehicles

ROVs have, for many years, been used as platforms for geophysical sensors. Linked to the mother vessel via an optical and electric umbilical, survey and inspection ROVs are frequently fitted with side-scan sonar and multibeam echosounders. These vehicles have the advantage of great manoeuvrability under direct human control, and a constant source of power.



Sea Demon ROV

Typically, in shallower water, an ROV can fly at 2-3 knots but, in deeper waters, the drag of the long umbilical reduces velocity considerably. ROVs are ideal for inspection but can offer some disadvantages for geophysical survey, such as noise generated by their propulsion systems and other acoustic interference sources. Because they require substantial handling systems, ROVs capable of carrying geophysical sensors are limited to specialist ROV vessels.

B-4.2.2 Autonomous Underwater Vehicles

The advent of AUVs offers a new concept in geophysical surveying. These vehicles can be equipped with a multibeam echosounder, side-scan sonar and high frequency sub-bottom profiler. Some AUVs can also carry a magnetometer or other sensors making them extremely flexible and powerful tools.

Although AUVs have been used for ocean research and in military operations for many years, at this time (February 2001) they are making their first appearance in commercial survey operations. Powered by special battery technology or energy fuel cells, AUVs have mission endurance ranging from 12 to 48+ hours and some can reach depths of 6,000m.

Typically, AUVs operate at 3-4 knots (independent of depth) and eliminate the time required for line turns or deviations.



The 5.6m long Boeing-Oceaneering-Fugro AUV

The smaller AUVs (<2.5m LOA) can be deployed from any vessel that has a suitable handling system. For the larger vehicles, which can reach lengths of 6m, special launch and recovery systems are used and hence these vehicles are generally restricted to larger vessels.

AUVs produce, and store, very high-quality data because, unlike towed platforms, they are capable of operating continuously at optimum sensor heights above the seabed and can adjust their aspects to meet changing environmental factors.

B-4.3 Seabed classification systems

Function and applications

A capability to classify seabed material without the need for costly sampling devices has its obvious advantages. Seabed classification systems do exist and their effectiveness is improving; however, they are not yet a panacea.

System description

Seabed classification is a processed solution depending on a proprietary software and electronics package. The measures of roughness and hardness combined can provide quantitative information on seabed types but will not be reliable enough to determine detailed soil characteristics.

Side-scan sonar can identify seabed morphological boundaries very well. By combining the bounding attributes of a side-scan with the roughness/hardness ratios of a seabed classification system, areas with similar properties can be identified with high reliability. The final step is to use seabed sampling, say with a box corer or grab sampler, to recover examples of the topmost soils and correlate these to the roughness/hardness ratios. In this way, a reliable model of the seabed topsoil is possible.

Advantages and limitations

Seabed classification using remote sensing is a rapid method that does not require additional in-sea equipment. However, side-scan is necessary to detect seabed objects, determine the morphological boundaries and, if reliable seabed interpretation is required, then seabed samples are required.

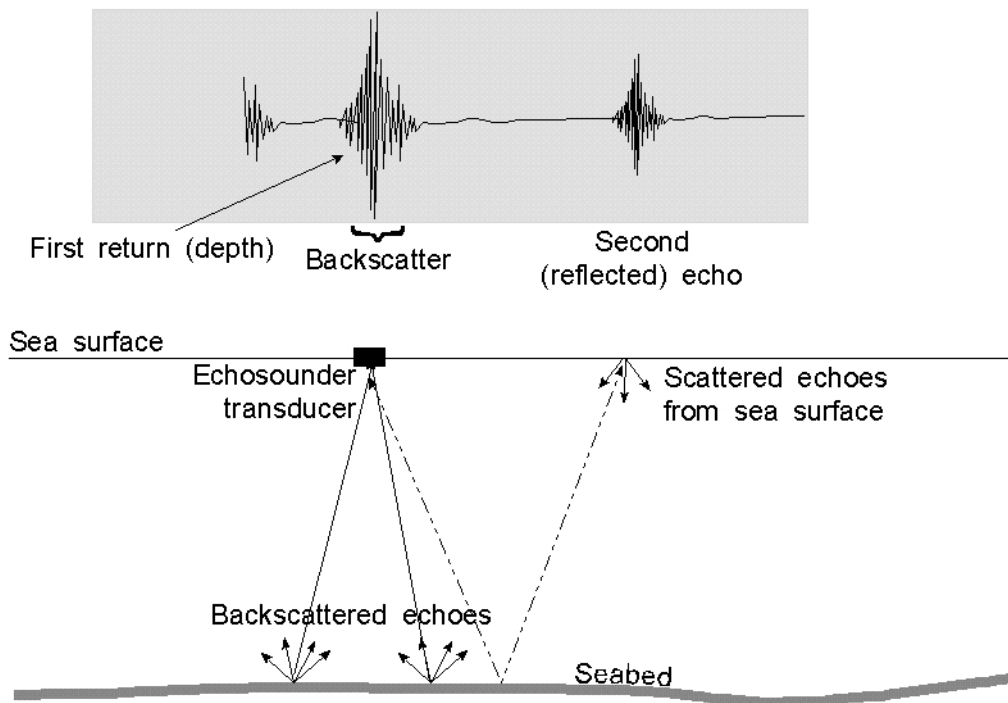

B-4.4 Seismic refraction systems

Seabed refraction seismic is a method of speedily acquiring high-resolution information of soil sedimentary structures. These systems are used typically where fine detail is required of the first 3m of the seabed, and especially the topmost 1m. The most common application is as a burial assessment tool for submarine cable installation; they are also used for pipeline route investigations. Other applications include site investigations for harbours and coastal developments and pre-dredge areas.

Until recently, seabed refraction systems were limited to shallow water depths but recent developments have increased operating depths to over 1,500m. Results obtained are independent of the water depth.

System technology and science

Seismic refraction methods have been used for many years as an exploration reconnaissance tool and for civil engineering applications. In recent years, the technique has been applied with great success to shallow marine soil investigations.

A seismic source at the seabed is used to induce an acoustic pressure wave into the soil. Typically, in shallow water, an airgun is used but for deepwater operation, a mechanical percussion device provides a better option. As the pressure wave passes through the soil layers, some of its energy is refracted along sedimentary boundaries before returning to the soil surface where it is picked up by a hydrophone streamer. The length of the streamer and the number of hydrophones determines the depth of recorded penetration and the resolution of the information – the longer the streamer the greater the depth of penetration recorded but the lower is the resolution. For detailed imaging of the topmost 3-5m, a typical streamer is 24m to 30m in length containing some 48 hydrophones.

Time-distance curves are produced by plotting the first time of arrival (first break) of the refracted waves versus distance from the seismic source. The analysis of the slope of these curves provides a direct determination of the depth of the various soil layers. The compression wave's velocity (V_p) provides the geoscientist with information that can be used to characterise each soil layer.

Spacing between 'shots' is about 15m to 25m, thus each observation requires 2 to 4 seconds. During this period, the seismic refraction system needs to remain quiescent to keep extraneous noise to the minimum. The refraction method can measure seismic velocities to better than 50 m/s with soil penetration accuracy of about 10% of depth, i.e. a soil layer at 2m depth could be resolved to ± 0.2 m. The main weakness of the method is that it falls short in resolving inversion velocity problems i.e. situations where a softer layer underlies a stronger one.

Compressive wave velocities are linked to the mechanical properties of soils and provide quantitative information on soil stiffness. Soil classification of marine sediments based on their seismic velocity is also under development. However, geotechnical information using CPT and / or coring samples taken at, say, 1km intervals is used to discriminate between soils of similar velocity and to obtain shear strength properties indispensable for estimating burial conditions (i.e. achievable burial depth and magnitude of towing forces)

System description

A typical deep-water seabed refraction system comprises of a steel reinforced instrument sled that is dragged across the seabed. Within the sled are housed the attitude sensors, pressure/depth and temperature sensors, tension meters for the tow cable and the multiplexing electronics for passing the data to the support vessel. The sled is positioned using acoustic positioning such as an ultra-short baseline (USBL) system. Also within the sled is the air-powered sleeve gun or mechanical percussion device for generating the seismic pulse. Trailing behind the sled is the hydrophone streamer for receiving the refracted signals. Depending on depth configuration, the sled system can weigh between 1 and 2.5 tonnes.

To tow the system across the seabed, a composite tow and power/communications cable connects the sled to the winch system installed on the surface support vessel. Each refraction-measuring cycle requires the

sled to be stationary while the vessel continues to steam ahead at 3-4 knots. This is achieved by using a stop-go, or yo-yo, device that pays out cable while the sled is stopped and pulls in cable (faster than the ship's motion) to bring the sled to its next observing location. For water depths less than 300m, the yo-yo is normally mounted on the ship while in greater depth it is better to have the yo-yo included within the sled.

Refraction seismic systems require ships equipped with 1½ to 5 tonne A-frames for deployment and tow. Deck space of about 100m² is required for handling the system, for the heavy cable winch and, possibly, an air-line winch, and for storage. Usually, refraction systems are deployed from specialist survey or geotechnical vessels or from the larger sort of workboats. For inshore surveys, smaller equipment and boats can be used.

In operation, it is best practice to perform a geophysical survey first to ascertain suitable (cable / pipeline) routes before employing a refraction system. This practice is the most cost-beneficial method and will identify rough or hazardous seabed across which a refraction survey would not be feasible.

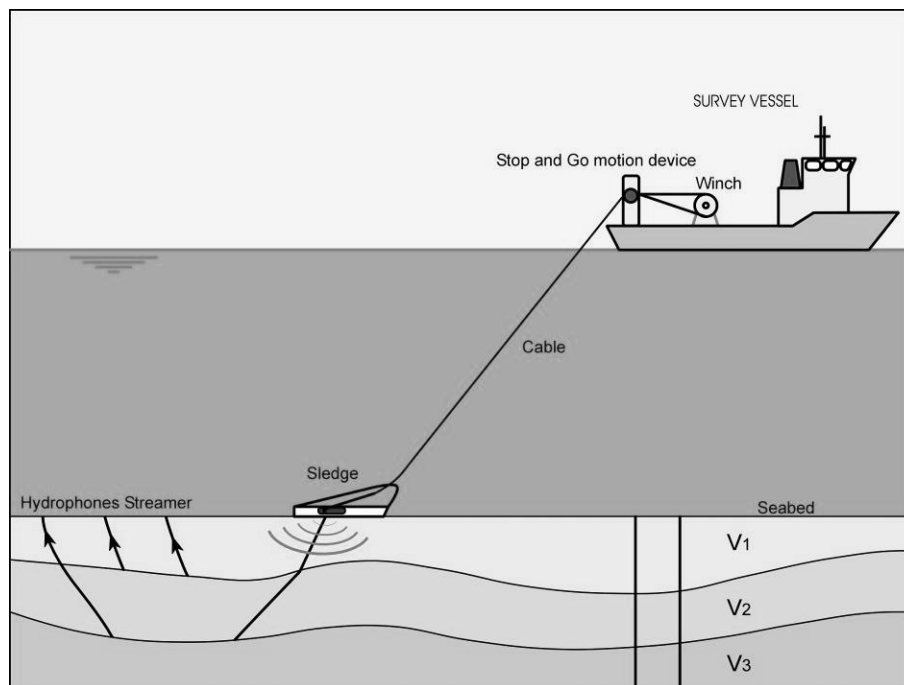

GAMBAS® operating principles

Advantages and limitations

High-resolution seismic refraction is an efficient technique for ascertaining detailed information in the top metres of the sub-surface. The technique provides an accurate quasi-continuous profile of sub-seabed sediments, providing simultaneously a high-resolution definition of the soil layering and a quantitative characterisation of their materials.

Information is acquired in real time and can, firstly, be used to define the subsequent geotechnical programme and optimise the number and location of samples (CPT or coring). Detailed analysis is performed during office interpretation where integrated alignment charts are compiled showing lithology and soil characteristics all along the profile.

High-resolution seismic refraction is a valuable tool for burial assessment purposes. The continuous profile aids in minimising geotechnical uncertainties that, in turn, reduce the risk of ploughing downtime. Due to the variable tow speed, dimensions of the tow and noise created by reflection surveys, coincident geophysical (sonar) surveys cannot be performed simultaneously. Specialist geotechnical vessels are preferred although the larger sort of workboats can also be used.



GAMBAS® refraction seismic system – seabed tow sled

B-4.5 Electrical resistivity systems

Function and applications

Seabed electrical resistivity profiling is a semi-continuous method of measuring the bulk resistivity of a volume of soil near the seabed. The technique is performed using a towed sled from which, in turn, is towed a multi-electrode streamer cable.

For surveys requiring penetration depths of 3 to 5m, for example cable burial assessment, streamer lengths are typically 20 m. For deeper penetration and other applications, such as drilling site surveys, pre-dredge surveys or harbour / coastal investigations, a longer streamer is used.

System technology and science

By injecting an electrical square wave current into the seabed through a pair of electrodes (A and B in the diagram below) an electrical potential is created that can be measured between the reference electrode (N) and, typically, 13 potential electrodes (M₁ ... M₁₃).

To compensate for the self-potential effects of the soil, the injected current's polarity is alternated at 1Hz. The resistivity of the ambient seawater is measured by using a short, low-intensity, square wave injected into the sea by a short quadripole antenna. The ratio of seabed resistivity to that of the seawater is called the Formation Factor. The potential difference is measured at each of the 13 electrodes at a sampling rate of 1 to 10Hz. The depth of investigation is a function of the electrodes separation; short spacing produces values associated with the upper part of the soil mass while increasing separation provides information on progressively deeper sediments.

The Formation Factor in saturated marine sediments is directly linked to the material's porosity. Its value provides qualitative information on soil type and the state of consolidation.

Obtaining layered resistivity versus depth is theoretically possible by implementing inversion-modelling techniques. However, currently this approach has yet to provide convincing results; on the one hand, inversion modelling is time consuming but, on the other, the resolution of the technique is insufficient to discriminate between all possible geological conditions.

Interpretation of resistivity measurements should always be supported by geotechnical information obtained from CPTs, vibrocoreing, or other sampling methods.

System description

A seabed resistivity system comprises of a steel reinforced sled in which are housed the electronics, acquisition unit, power unit, attitude sensors, temperature and pressure sensors and the cable tension

meters. Behind the sled is towed the 24m to 30m long multi-electrode streamer in which is housed the two 24v 10 amp current injection electrodes (A & B). The sled is hauled across the seabed from a tow/power/communications cable attached to a surface support vessel. Some systems are fitted with a yo-yo device that permits the sled to halt during measurements thus improving the signal to noise ratio.

Typically, resistivity systems can operate down to 2,000m water depth and can be towed at up to 2 –3 knots. Soil penetration depths are in the order of 5m although it is possible to get greater depth (ca. 30m) using wider spacing for the electrodes and sacrificing resolution and accuracy. The sled, which is similar to but lighter than the refraction sled, is deployed and towed from an A-frame fed by a 2,000 to 6,000m capacity cable winch.

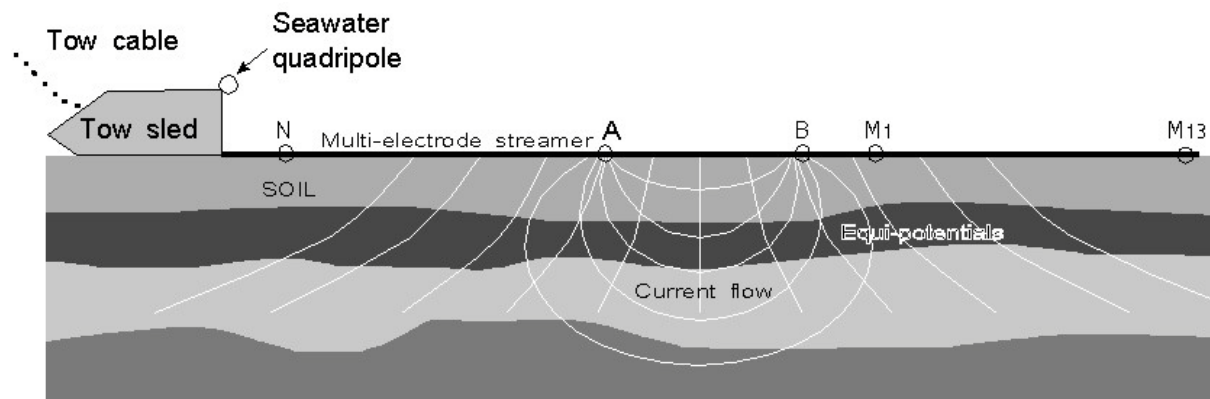

Advantages and limitations

As results are dependent on the water depth and salinity, great care is needed when calibrating the system and attention to detail required in the operating procedures and interpretation methods.

Resistivity surveys provide continuous profiles and fill gaps where normal acoustic systems are unreliable, e.g. in gas-charged sediments, and between CPTs in the more homogenous soils. They can be employed in conjunction with refraction seismic surveys as an augmentation/ bulk sampling system.

The technique is a bulk sample of a volume of soil rather than discrete elements. Like reflection seismic, resistivity requires ground truth data in order to provide meaningful soil type information. Marine resistivity techniques are also limited in that they cannot reliably differentiate between discrete soil layers.

B-4.6 Underwater cameras

Function and applications

The visualising systems used for structural inspection can often assist in solving remotely sensed ambiguities. In-situ examination of uncontaminated soil colour, condition and context provide valuable information for the geologist or benthic scientist for environmental assessment and impact studies.

System technology and science

For operation in shallow depths during daylight, there is a range of off-the-shelf cameras. However, daylight tends to become totally absorbed in seawater below 300-500m; even at 100m the amount of light available is often barely perceptible. Two options are available a) camera lighting systems, b) low-light cameras.

Lighting systems are housed in pressure resistant housings and a variety of light emission types are available depending on need and the receptive media employed. Low-light cameras depend on light-enhancement systems (like night-vision glasses) while in extreme dark, solid-state photon detectors are used to collect any available light.

System description

The common sorts of cameras for sub-sea visualisation are:

- Television (real-time) colour or black and white
- Video cameras (self-recording)
- Movie film (now uncommon but special sensitive films are occasionally used)
- Still cameras (film), normally 35mm format
- Digital stills cameras
- Low light cameras

The most common form of deployment for lightweight cameras (stills, video) is by diver. For prolonged excursions, real-time visualisation and in hazardous or remote locations, cameras and lighting systems are normally installed on an ROV. Either a small observation class vehicle or full size survey vehicle can be used. Cameras can also be lowered to the seafloor from a reinforced power and control cable.

Advantages and limitations

Seabed visualisation is a valuable tool providing high-resolution and discriminatory information. Colour, texture and benthic life forms can all be studied in great detail. Diver deployment in shallow water is relatively inexpensive but deeper water requires saturation diving and costs become extremely high. The alternative is to use an ROV; the small observation class can be operated relatively inexpensively from most vessels but the larger survey class ROVs are limited to specialist survey vessels or the larger sort of workboats.

Visual sampling with an ROV in deep water, say 2,000m, is a time consuming process; a dive to the seabed can take over four hours and a similar time to return to the surface. Once at the seafloor, an ROV can operate for many hours, or even days, and therefore it is more cost-efficient to combine visualisation with other remote sensing operations.

APPENDIX C BIBLIOGRAPHY and REFERENCES

C-1 Design Guides	1
C-2 Anchoring Guides	2
C-2.1 General.....	2
C-2.2 Deadweight Anchors.....	3
C-2.3 Drag Anchors.....	3
C-2.4 Pile Anchors.....	4
C-2.5 Plate Anchors.....	5
C-2.6 Cable/Chain-Soil Interaction.....	6
C-3 Mooring Hardware	7

C-1 Design Guides

1. DNV, Guideline on design and operation of wave energy converters 2005
2. DNV-OSS-312, Offshore Service Specification Certification of Tidal and Wave Energy Converters, October 2008
3. DNV-OS-E301 Offshore Standard Position Mooring, October 2008
4. DNV-OSS-101 Rules for Classification of Offshore Drilling and Support Units
5. DNV-OSS-102 Rules for Classification of Floating Production, Storage and Loading Units
6. DNV-OS-B101 Metallic Materials
7. DNV-OS-C101 Design of Offshore Steel Structures, General (LRFD method)
8. DNV-OS-C201 Structural Design of Offshore Units (WSD Method)
9. DNV-OS-D101 Marine and Machinery Systems and Equipment
10. DNV-OS-C401 Fabrication and Testing of Offshore Structures
11. DNV-OS-D201 Electrical Installations
12. DNV-OS-D202 Instrumentation and Telecommunication Systems
13. DNV-RP-C203 Fatigue Design of Offshore Steel Structures
14. DNV-RP-C205 Environmental Conditions and Environmental Loads
15. DNV-RP-F205 Global Performance Analysis of Deepwater Floating Structures
16. DNV-OS-J101 Design of Offshore Wind Turbine Structures
17. API RP-2T Recommended Practice for Planning, Designing, and Constructing Tension Leg Platforms
18. API RP-2P Analysis of Spread Mooring Systems for Floating Drilling Units, Second Edition, May 1, 1997

19. API RP 2A Recommended Practice for Planning, Designing and Construction of Fixed Offshore Platforms
20. API RP 2SK Recommended Practice for Design and Analysis of Station-keeping Systems for Floating Structures,
21. API RP 95F Interim Guidance for Gulf of Mexico MODU Mooring Practice - 2007 Hurricane Season, 2nd edition
22. DEN. 'Offshore Installations: Guidance on Design, Construction and Certification', 4th Edition, 1990.
23. Germanisher Lloyd, Guideline for the Certification of Ocean Energy Converters Part 1: Ocean Current Turbines, 2005 (draft)
24. Germanisher Lloyd, Guideline for the Certification of Offshore Wind Turbines, 1 June 2005
25. MIL-HDBK-1026/4A Mooring Design 1 July 1999
26. Fleet Moorings, Design Manual 26.5", Naval Facilities Engineering Command. June 1985.
27. Lloyd's Register. 'Rules for the Classification of Mobile Offshore Units.' June 1989.
28. Construction of Marine and Offshore Structures, third edition, Ben Gerwick Jr. CRC Press
29. 2007 M. A. Chjlders. "Spread Moorings Systems" The Technology of Offshore Drilling, Completion and Production, compiled by ETA Offshore Seminars, Inc. Tulsa, Okla., petroleum

C-2 Anchoring Guides

C-2.1 General

30. "Interaction of anchors with soil and anchor design," Recent Developments in Ocean Engineering, University of California, Berkeley. , January 1981.
31. "Preliminary selection of anchor systems for OTEC," CEL TR 53. March 1977.
32. "OTEC single anchor holding capacities in typical deep sea sediments," CEL TN 1463. December 1976.
33. State-of-the-art in high capacity deep water anchor systems," CEL TM 42-76-1, 1976.
34. "Handbook for Marine Geotechnical Engineering", Naval Civil Engineering Laboratory (NCEL), March 1985.
35. Foss, T. Kvalstad and T. Ridley. "Seabed anchorages for floating offshore structures," FIP Commission on Sea Structures, Working Group on Foundations, Feb 1980.
36. American Society of Naval Engineers (1999) "Marine Casualty Response: Salvage Engineering" American Society of Naval Engineers and James Marine Services, Kendall/Hunt Publishing Co. Dubuque, Iowa, 1999

37. 'Single anchor holding capacities for ocean thermal energy conversion in typical deep sea sediments'. Ocean Engineering. Vol. 6, pp169-245, 1979.
38. Røraas H and Hagen ø. 'Method for design, construction and setting of very high capacity anchors'. Paper OTC 6034, 21st Offshore Technology Conference, Texas, 1989.
39. Dove PGS. 'Methods in anchor handling offshore'. Offshore, March 1980.
40. "U.S. Navy Ship Salvage Manual, Volume I (Strandings), S0300-A6-MAN, July 1989.
41. "U.S. Navy Salvage Engineer's Handbook, Volume I, Salvage Engineering 1992.
42. Statutory instrument. 'Anchor and chain cable. The anchors and chain cable rules 1970'. SI No. 1453, 1970.

C-2.2 Deadweight Anchors

43. Technical Report TR-6037, IMPROVED PEARL HARBOR ANCHOR KINGS BAY ANCHOR DESIGNS, Naval Civil Engineering Laboratory, June 2001
44. Bang, S., "Ultimate Inclined Loading Capacity of Deadweight Anchors", South Dakota School of Mines and Technology, 27 April 2001
45. J.L. Tassoulas, University of Texas, "Numerical modeling of Torpedo Anchors", MMS Project 557

C-2.3 Drag Anchors

46. NAVFAC P-990, Chapter 2.8.1 "Drag Embedment Anchors" and Chapter 3.5.2 "Fleet Mooring Anchors," May 1995
47. DNV-RP-E301 Design and Installation of Fluke Anchors in Clay
48. TDS 83-05 Multiple STOCKLESS Anchors for Navy Fleet Moorings Naval Civil Engineering Laboratory
49. NCEL Techdata sheet 83-08R 'Drag embedment anchors for Navy moorings' June 1987.
50. Puech A. 'The use of anchors in offshore petroleum operations'. Editions Technip, 1984
51. Puech A et al., 'Behavior of anchors in different soil conditions'. Paper OTC 3204, 10th Offshore Technology Conference, Texas, 1978.
52. Vryhof Ankers bv, 'Anchor manual'2005.
53. "Drag Anchors for Floating Systems", OTH 93 395
54. Lammes, R.R. and Siemers, R.W., 1988. "Soil Mechanics of Drag Embedment Anchor in Sand." Faculty of Civil Engineering, Offshore Engineering Major, Delft University of Technology.
55. Dove PGS. 'Deepwater high capacity moorings.' Paper OTC 4050, 13th Offshore Technology Conference, Texas, 1981.
56. Miedema, S.A., Kerkvliet, J., Strijbis, D., Jonkman, B., Hatert, M. v/d, 2006, "THE DIGGING AND HOLDING CAPACITY OF ANCHORS". WEDA XXVI AND TAMU 38, San Diego, California, June 25-
57. Mierlo, R. v., 2005. "Anchor Trajectory Modeling." Faculty of Mechanical Engineering, Offshore Engineering Major, Delft University of Technology.

58. House, A., 1998. "Drag Anchor and Chain Performance in Stratified Soils." Geomechanics Group, Report 1319, University of Western Australia.
59. Klaren PJ. 'The behavior of anchors underwater in the bottom with special reference to the Delta-anchor'. Holland Shipbuilding International, May 1971.
60. O'Neill, M.P. and Randolph, M.F., 1998. "The Behavior of Drag Anchors in Layered Calcareous Soils." Geomechanics Group, Report G1329, University of Western Australia.
61. O'Neill, M.P., Randolph, M.F. and House, A.R., 1998. "The Behavior of Drag Anchors in Layered Soils." Geomechanics Group, Report G1346, University of Western Australia.
62. Stewart, W.P., 1992. "Drag Embedment Anchor Performance Prediction in Soft Soils." Offshore Technology Conference, Paper OTC 6970.
63. Thorne, C.P., 1998. "Penetration and Load Capacity of Marine Drag Anchors in Soft Clay."
64. Vrijhof Anchors, 2005, "Anchor manual 2005"
65. Neubecker, S.R. and Randolph, M.F., 1995. "The Performance of Drag Anchor and Chain Systems in Cohesive Soil," Geomechanics Group, Report G1168, The University of Western Australia.
66. "Performance of conventional anchors," in Proceedings of the Offshore Technology Conference, Houston, Tex., 1981
67. P.J. Klaren. "Anchors in tandem or the use of back-up anchors (piggybacks)," Holland Shipbuilding, Anker Advies Bureau, pp 230-232.
68. "Conventional anchor test results at San Diego and Island," CEL TN 1581 July 1980.
69. "Drag embedment anchor test in sand and mud," NCEL TN 1635, June 1982.
70. "Design guide for drag embedment anchors," NCEL TN 1688 January 1984.
71. "Interaction at anchors with soil and anchor design," NCEL TN 1627 April 1987.
72. "Single and tandem anchor performance of the new Navy mooring anchor: The NAVMOOR anchor," NCEL TN 1774 July 1987.
73. "STOCKLESS and STATO Anchors for Navy Fleet moorings," NCEL TDS 83-09 Mar 1983.
74. "The NAVMOOR anchor." NCEL TDS 87-05, 1987

C-2.4 Pile Anchors

75. "Suction Piles for Mooring of Mobile Offshore Bases", Marine Structures, Vol 13, 367-382, 2000
76. DNV-RP-E303 Geotechnical Design and Installation of Suction Anchors in Clay
77. "Vertical Pullout Capacity of Embedded Suction Anchors in Sand", S. Bang, K. Jones South Dakota School of Mines and Technology, Y.S. Kim, K.O. Kim, and Y. Cho Daewoo Engineering & Construction Co., Ltd. Offshore and Polar Engineering Conference May 28-June 2, 2006

78. "Limit Load Analysis of suction anchors for cohesive materials", A. Rahim, The CRISP Consortium Ltd/South Bank University, September 2001
79. Colliat, J.L., Boisard, P., Andersen, K., and Schroeder, K. (1995), "Caisson Foundations as Alternative Anchors for Permanent Mooring of a Process Barge Offshore Congo," Proceedings, Offshore Technology Conference, OTC 7797, pp. 919-929.
80. Cuckson, J. (1981), "The Suction Pile Finds its Place," Offshore Engineer, pp. 80-81.
81. Senpere, D., and Auvergne, G.A. (1982), "Suction Anchor Piles - A Proven Alternative to Driving or Drilling," Proceedings, Offshore Technology Conference, OTC 4206, pp. 483-493.
82. Sparrevik, P. (1995), "Suction in Sand - New Foundation technique for Offshore Structures," NGI Publication No. 196.
83. Tjelta, T.I. (1994), "Geotechnical Aspects of Bucket Foundations Replacing Piles for the Europipe 16/11-E Jacket," Proceedings, Offshore Technology Conference, OTC 7379, pp. 73-82.
84. Sparrevik, P. (1995), "Suction in Sand - New Foundation technique for Offshore Structures," NGI Publication No. 196.
85. Tjelta, T.I. (1994), "Geotechnical Aspects of Bucket Foundations Replacing Piles for the Europipe 16/11-E Jacket," Proceedings, Offshore Technology Conference, OTC 7379, pp. 73-82.
86. Aubeny, C.P., Moon, S.K.*, and Murff, J.D. (2001) "Lateral undrained resistance of suction caisson anchors," Intl. J. Offshore and Polar Engineering, Volume 11, No. 3, pp. 211-219.
87. Clukey, E.C., Aubeny, C.P. and Murff, J.D. (2003) "Comparison of analytical and centrifuge model tests for suction caissons subjected to combined loads," 22nd International Conference on Offshore and Arctic Engineering, June 8-13, Cancun, Mexico, OMAE2003-37503.
88. Clukey, E. C. and Phillips, R. (2002) "Centrifuge Model Tests to Verify Suction Caisson Capacities for Taut and Semi-taut Legged Mooring Systems," Proceedings of the Deep Offshore Technology Conference, New Orleans.

C-2.5 Plate Anchors

89. DNV-RP-E302 Design and Installation of Plate Anchors in Clay
90. Degenkamp, G. and Dutta, A., 1989. "Behaviour of Embedded Mooring Chains in Clay During chain Tensioning." Offshore Technology Conference, Paper 6031.
91. Murff, J.D., Randolph, M.F. & Elkhatib, S., Kolk, H.J., Ruinen, R.M., Strom, P.J. and Thorne, C.P., 2005. "Vertically Loaded Plate Anchors for Deepwater Applications." Frontiers in Offshore Geotechnics
92. Sutherland HH, Finaly TW and Fadl MO. 'Uplift capacity of embedded anchors in sand'. Volume II BOSS (3rd), MIT, Cambridge, Mass. 1982.
93. "Pile-Driven Plate Anchors for Fleet Moorings," OTC 7490, May 1994.

94. "Design Guide for Pile-Driven Plate Anchors," NCEL TR-2039, March 1995.
95. "Pile Driven Plate Anchors for Fleet Moorings," NCEL TDS 92-10, Nov 1992.
96. "Pile-driven plate anchors". *The Military Engineer*, pp. 18, August 1992
97. "Direct embedment anchor holding capacity," CEL TN-1245, December 1972.

C-2.6 Cable/Chain-Soil Interaction

98. Degenkamp, G. and Dutta, A., 1989. "Soil Resistances to Embedded Anchor Chain in Soft Clay." *Journal of Geotechnical Engineering* Vol 115, No. 10
99. Dutta A. 'A simple method of analyzing mooring chains with embedded anchor point'. *Journal of Offshore Mechanics and Arctic Engineering*, Vol 110 pp 71-73, February 1988.
100. Neubecker, S.R. and Randolph, M.F., 1995. "Performance of Embedded Anchor Chains and Consequences for Anchor Design." *Offshore Technology Conference*, Paper OTC 7712.
101. Neubecker, S.R. and Randolph, M.F., 1995. "Profile and Frictional Capacity of Embedded Anchor Chains." *Journal of Geotechnical Engineering* Vol. 121, No. 11
102. Neubecker, S.R. and Randolph, M.F., 1994. "Profile and Frictional Capacity of Embedded Anchor Chains." *Geomechanics Group, Report G1142, The University of Western Australia.*
103. Dutta A and Degenkamp G. 'Behaviour of embedded mooring chains in clay during chain tensioning'. Paper OTC 6031, 21st Offshore Technology Conference, Texas 1989.
104. "Static Mooring Line Configuration Analysis Tool," *Marine Technology Society (MTS) Conference*, Washington D.C, 1994.
105. "Anchor Mooring Line Configuration Analysis," *Offshore and Polar Engineering Conference (ISOPE)-95 "The Hague"*, Mechanics of Cables & Mooring, Netherlands, June 1995.
106. "Analysis of Anchor Mooring Lines in Cohesive Seafloor," *Transportation Research Record No. 1526 Soils, Geology, and Foundations, Emerging Technologies in Geotechnical Engineering* 1996.
107. "Analysis of Anchor Mooring Lines in Sands, ISOPE-97 Geotech V: Shallow Foundations (V.1), Honolulu, HI, May 1997
108. "Analysis of Anchor Mooring Lines in Cohesive Seafloor", *Transportation Research Board Record 1526*, Jan 2000.
109. Development and validation of mooring line analysis in cohesive seafloor", *ISOPE*, May, 2000
110. "Calibration of Analytical solution using centrifuge model tests on mooring lines", *Transactions of the ISOPE*, Vol 10, No. 3, 2000
111. Klaren PJ. 'Anchors in tandem or the use of back-up anchors'. *Holland Shipbuilding International*, May 1973.
112. "Effect of soil on Mooring System Dynamics," *MTS Conference*, Washington D.C., 1994.

113. ISO 1704: Shipbuilding – Stud link anchor chains
114. “Development and Validation of Mooring Line Analysis in cohesive seafloor”, ISOPE Vol 11, No 2, June 2001
115. “Anchoring systems” Vol. 6, Nos. 1, 2. Pergamon Press, ltd., 1979.
116. “Uplift Resisting Anchors,” DOT Technology Handbook (1975). September 1975.
117. “Design Guide for Pile-Driven Plate Anchors,” NCEL TR-2039-OCN., March 1995.

C-3 Mooring Hardware

118. American Petroleum Institute Recommended Practice for Synthetic Mooring (API RP 2 SM) (2001)
119. ABS, “Guidance Notes on the Application of Synthetic Ropes for Offshore Mooring”, March 1999
120. DNV Certification Notes No. 2.5 “Certification of Offshore Wire Ropes”, 1995.
121. DNV-OS-E303 Offshore Mooring Fibre Ropes
122. DNV-OS-E304 Offshore Mooring Steel Wire Ropes
123. DNV-OS-E302 Offshore Mooring Chain
124. API Spec 2F "Specification for Mooring Chain," 6th Edition, June 1997
125. RCS (Recognized Classification Society) Rules for Offshore Mooring Chain
126. Memo to API RP 2SK Work Group “Studlink and Studless Fatigue Curves for Mooring Lines”, ExxonMobil Upstream Research Company, March 2003
127. Lloyd’s Register. ‘Rules for the manufacture, testing and certification of materials’. 1984.
128. Cordage Institute Technical Manual Cordage Institute, 350 Lincoln Street, Hingham, MA 02043
129. Bhat, SS, Cermelli, CA and Himlo K (2002). “Polyester Mooring for Ultra Deepwater Applications,” Proc OMAE Conf, Oslo (to be published).
130. Bosman, RLM, and Hooker, J (1999). “The Elastic Modulus Characteristics of Polyester Mooring Ropes,” Proc OTC, Houston, OTC 10779.
131. Colby, C, Sodahl, N, Katla, E, and Okkenhaug, S (2000). “Coupling Effects for a Deepwater Spar,” Proc OTC, Houston, OTC 12083.
132. Cermelli, C and S. Bhat, " Fiber Moorings for Ultra-Deepwater Applications", ISOPE, May 2002
133. Del Vecchio, CJM, and Costa, LCS (1999). “Station Keeping in Deep and Ultradeep Waters,” Proc OTC, Houston, OTC 10778.
134. Dove, P, Weisinger, D, Abbassian, F, and Hooker, J (2000). “The Development and Testing of Polyester Moorings for Ultradeep Drilling Operations,” Proc OTC, Houston, OTC 12172
135. Engineers’ Design Guide to Deepwater Fibre Moorings, (1997), Offsh Pub Lim.

136. Gerrits, N, and Smeets, P (2001). "Dyneema Mooring Lines Extend Depth Capabilities of MODUs," Risers, Moor & Anch for Deep Waters Workshop, London.
137. Gupta, H, Finn, L, and Weaver, T (2000). "Effects of Spar Coupled Analysis," Proc OTC, Houston, OTC 12082
138. Lee, MY, Devlin, P, and Kwan, CTT (2000). "Development of API RP2SM for Synthetic Fiber Rope Moorings," Proc OTC, Houston, OTC 12178
139. Lo, KH, Xu, H, and Skogsberg, LA (1999). "Polyester Rope Mooring Design Considerations," Proc Ninth ISOPE, Brest, Vol 2, pp358.
140. Ma, W, Huang, K, Lee, MY, and Albuquerque, S (1999). "On the Design and Installation of an Innovative Deepwater Taut-Leg Mooring System," Proc OTC
141. Ma, W, Lee, MY, Zou, J, and Huang, EW (2000). "Deepwater Nonlinear Coupled Analysis Tool," Proc OTC, Houston, OTC 12085.
142. Meniconi, LC, and Del Vecchi, CJM (1997), "Deepwater Mooring Systems Using Fiber Ropes", Second International Conference on Composite Materials for Offshore Operations, Univ. of Houston, pp56.
143. Shu, H, Loeb, D, and Bergeron, B (2001). "Polyester Rope Mooring Field Trial in 6200 ft Waterdepth," Proc OTC, Houston, OTC 12111.
144. Stonor, RWP, Trickey, JC, and Versavel, T (1999). "The Design of Moorings Using Fibre Rope Tethers," Proc Ninth Int Offsh and Polar Eng, Brest, Vol 2, pp352.
145. Vedelb, S, and Taggart, U (2000). "Polyester Mooring, Clarification of Benefits," Proc Deep Oil Tech Conf, New Orleans
146. Winkler, MM, and McKenna, HA (1995). "The Polyester Rope Taut Leg Mooring Concept: a Feasible Means for Reducing Deep water Mooring Cost and Improving Station Keeping Performance," Proc OTC, Houston, OTC 7708.
147. Lamey, M. et al., "Red Hawk project: Overview and Project Management" Proceedings of Offshore Technology Conference, OTC 17213, Houston, Texas, May 2-5, 2005.
148. Jatar, S. et al., "The Planning and Installation of the Red Hawk Spar and Polyester Mooring System," Proceedings of Offshore Technology Conference, OTC 17294, Houston, Texas, May 2-5, 2005.
149. Tule, J. et al., "Red Hawk Project Polyester Soil Ingress Testing," Proceedings of Offshore Technology Conference OTC 17259 Houston, Texas, May 2-5, 2005.
150. Noble Denton, "Engineering design Guide for Deepwater Fiber Moorings", Noble Denton and TTI, 1999.
151. Flory, J.F., McKenna, H.A., and Parsey, M.R., "Fiber Ropes For Ocean Engineering In the 21st Century" Civil Engineering In the Oceans Conference Proceedings, ASCE, Reston, VA, 1992
152. Flory, J.F. and S.J. Banfield, "Durability of Polyester Ropes Used as Deepwater Mooring
153. Lines", Oceans '06 Conference Proceedings, IEEE, Piscataway, NJ and MTS, Columbia, MD, 2006

154. Banfield, S.J. and Casey, N.F., "An Investigation into the Durability of Polyester Ropes for Deepwater Moorings", Deep Offshore Technology Conference Proceedings, Pennwell, 2006
155. "OCIMF Hawser Standards Development Program – Trial Prototype Rope Tests". OCIMF, London, 1983
156. Guidelines for the Purchasing and Testing of SPM Hawsers, OCIMF, Witherby and Co, London, 1986, 2000
157. Scott, M.I. and Parsey, M.R., "Moored Ocean Platforms", Conference on The Technology of the Sea and the Seabed, AERE, Harwell, UK, 1967
158. Flory, J.F., "Avoiding Fiber Axial Compression Fatigue in the Design and Use of Tension Members", Oceans '96 Conference Proceedings, IEEE, Piscataway, NJ and MTS, Washington, DC, 1996
159. Flory, J.F., "Improved Potted Socket Terminations for High-Modulus Synthetic-Fiber Rope", O.I.P.E.E. C. 2001 Round Table Proceedings, Organisation Internationale Pour L'etude De L'endurance Des Cables, Zurich, 2001
160. "Fibre Tethers 2000 High-Technology Fibres for Deepwater Tethers and Moorings", Final Report, TTI, NEL, and Noble Denton, London, 1995
161. Engineers' Design Guide for Deepwater Fibre Moorings, Noble Denton and Tension Technology International, London, 1999, rev. 2002
162. P. Dove, T. Fulton, P. Devlin, "Installation of DeepStar's Polyester Taut Leg Mooring", OTC 8533, 1997 Offshore Technology Conference Proceedings, SPE, Richardson, TX, 1997
163. "Polyester Taut Leg Mooring Concept Design Study", DeepStar Report DSII CTR 540-1, Shell Development, Houston, 1994
164. Flory, J.F., Devlin, P., Homer, S., and Fulton, T., "DeepStar Polyester Taut Leg Mooring System Test", Offshore and Polar Engineering Conference, International Society of Offshore and Polar Engineering, Cupertino, CA, 1999
165. Devlin, P., Flory, J.F., and Homer, S., "DeepStar Taut Leg Mooring Polyester Test Program", Oceans '99 Conference Proceedings, IEEE, Piscataway, NJ and MTS, Washington, DC, 2000
166. Guidance Notes on the Application of Synthetic Ropes for Offshore Mooring, ABS, Houston, 1999
167. L.C. S. Costa, G.A.V. Castro, R.C.F. Goncalves and R.T. Araujo, "Polyester Mooring Systems – Petrobras Experience", Deep Offshore Technology Conference Proceedings, Rio de Janeiro, 2001
168. "Synthetic Solutions", ABS Surveyor, March, 1999
169. Wylie, M.W.J., "Fast Track FPSO's for Deepwater and Ultra-Deepwater", OTC 16708. 2004 Offshore Technology Conference Proceedings. SPE, Richardson, TX, 2004

170. Jean, P., Goessens, K., and L'Hostis, D., "Failure of Chains by Bending on Deepwater Mooring Systems", OTC 17238, 2005 Offshore Technology Conference Proceedings, SPE, Richardson, TX, 2005
171. Petruska, D.J., Geyer, J.F., and Ran, A.Z., "Mad Dog Polyester Mooring - Prototype Testing and Stiffness Model for Use in Global Performance Analysis", OTC 16589, 2004 Offshore Technology Conference Proceedings, SPE, Richardson, TX, 2004
172. Petruska, D., Rijitema, S., Wylie, N., and Geyer, J., "Mad Dog Polyester Mooring Installation" DOT Conference Proceedings, Pennwell, 2005
173. Haslum, H.A., Tule, J., Huntley, M., and Jatar, S., "Red Hawk Polyester Mooring Design and Verification", OTC 17247, 2005 Offshore Technology Conference Proceedings, SPE, Richardson, TX, 2005
174. Tule, J., Huntley, E., Phillips, C., and Haslum, H.A., "Red Hawk Project Polyester Soil Ingress Testing", OTC 17247, 2005 Offshore Technology Conference Proceedings, SPE, Richardson, TX, 2005
175. Veselis, T., Fulton, T., Tule, J., and Huntley, M., "Polyester Mooring for Red Hawk Among First in GoM", Offshore Magazine, September, 2005
176. "Deepwater Nautilus Sets Another World Record in the GoM", Offshore Magazine, October, 2002, PennWell
177. Ghiselin, D., "Improving Ultra-deepwater Performance", 2006 Global Offshore Report Mooring Record, Hart Publications, Houston, September, 2006
178. "Synthetic Mooring System Could Be Choice Future", Drilling Contractor, May/June, 2003
179. Ehlers, C.J., Young, A.G., and Chen, J-H, "Technology Assessment of Deepwater Anchors", OTC 16840, 2004 Offshore Technology Conference Proceedings,
180. Bowles, T., and Fulton, T. , "Deepwater Mooring: Full Taut-Leg Polyester Drilling Unit Mooring Established in Gulf of Mexico, Offshore Magazine, November, 2001
181. Flory, J.F., Ahjem, V., and Banfield, S.J., "A New Method of Testing Change-IN-Length Properties of Fiber-Rope Deepwater Mooring Lines", OTC 18770, 2007 Offshore Conference Proceedings, SPE, Richardson, TX, 2007
182. Aker Omega, "Deep Water Aramid Mooring Line Joint Industry Project, Phase 2 Final Report," Houston, July, 1993.
183. API Bull 2INT-MET, "Interim Guidance on Hurricane Conditions in the Gulf of Mexico," May 1, 2007, Washington, D.C., American Petroleum Institute.
184. Costa, L. C. S., Castro, G. A. V., Goncalves, R. C. F., Araujo, R. T., "Polyester Mooring Systems – Petrobras Experience," Deep Offshore Technology, Rio de Janeiro, Brazil, November 2001.
185. Davies, Peter, Francois, Michel, Grosjean, Francois, Baron, Patrice, Salomon, Karine, and Trassoudaine, Damien, "Synthetic Mooring Lines for Depths to 3000 Meters," Proceedings of the Offshore Technology Conference, OTC 14246, Houston, Texas, May 6-9, 2002.

186. Del Vecchio, C. J. M., "Taut Leg Mooring Systems based on Polyester Fibre Ropes – Petrobras Experience and Future Developments," Presented at International Conference on Mooring and Anchoring, Aberdeen UK, 1996.
187. DuPont Co., "Kevlar® Data Manual for Fiber Optics and Other Cables, July 1991.
188. Huntley, M.B., Whitehill Manufacturing Corp., unpublished data (2006).
189. International Organization for Standardization, ISO 18692:2007 "Fibre Ropes for Offshore Stationkeeping – Polyester," 1st Edition, 2007.
190. Koralek, A.S., and Barden, D.K., "Performance of a Lightweight Aramid Mooring Line," Proceedings of the Offshore Technology Conference, OTC 5381, Houston, Texas, April 27-30, 1987.
191. Riewald, P.G., "Performance Analysis of an Aramid Mooring Line," Proceedings of the Offshore Technology Conference, OTC 5187, Houston, Texas, May 1986
192. Riewald, P.G., Walden, R.G., Whitehill, A.S., and Koralek, A.S., "Design and Deployment Parameters Affecting the Survivability of Stranded Aramid Fiber Ropes in the Marine
193. Polyester Rope Mooring Design Considerations, K H Lo, Proceedings of the Ninth International Offshore and Polar Engineering Conference, Brest France, May 30th to June 4th 1999, pages 358 to 363
194. Deepsea Connection: Mooring Innovation, Journal of Offshore Engineering, R Ahilan, July 2009
195. Mooring With High Modulus PolyEthylene (HMPE) Fiber lines, J Gilmore et al, 15th International Oil and Gas Exhibition and Conference (OSEA), Dec 2006, Singapore
196. Latest Synthetic Fibre Rope Developments in the Towage Industry, J Hooker, International Tug and Salvage Convention, 2000, Jersey