

MEMBRANE ANALOGY FOR TWO-WAY SLABS

by

JULIUS VON ROTZ

A THESIS

submitted to

OREGON STATE COLLEGE

in partial fulfillment of  
the requirements for the  
degree of

MASTER OF SCIENCE

June 1958

## ACKNOWLEDGMENT

Appreciation is expressed to Professor Orville Kofoid, whose investigations using foam rubber stimulated this study. His invaluable suggestions, patience, and encouragement have been of great assistance throughout both the graduate program and this thesis problem.

The cooperation and encouragement extended by Professor G. W. Holcomb and all the members of the staff of the Department of Civil Engineering is gratefully acknowledged.

APPROVED:

Redacted for Privacy

---

Associate Professor of Civil Engineering

In Charge of Major

Redacted for Privacy

---

Chairman of Department of Civil Engineering

Redacted for Privacy

---

Chairman of School Graduate Committee

Redacted for Privacy

---

Dean of Graduate School

Date thesis is presented May 14, 1958

Typed by Florence Rotz

## TABLE OF CONTENTS

Subject	Page
Introduction . . . . .	1
Description of Tests and Models . . . . .	6
Stress-strain Test . . . . .	6
Poisson's Ratio Test . . . . .	8
One-way Slab Model . . . . .	10
Two-way Slab Model . . . . .	12
Analysis of Tests . . . . .	15
Basic Method of Analysis . . . . .	15
One-way Slab . . . . .	16
Two-way Slab . . . . .	19
Discussion . . . . .	23
Conclusions . . . . .	34
Bibliography . . . . .	35
Appendix . . . . .	36
Tables:	
1. Poisson's ratio test . . . . .	37
2. Deflection of top surface of one-way slab . . . . .	38
3. Deflections perpendicular to centerline of one-way slab . . . . .	39
4. Deflections of top surface of two-way slab . . . . .	40
5. Deflection of top surface of two- way slab along quarter points . . . . .	41
6. Deflection along diagonal from corners of two-way slab . . . . .	42
7. Stress-strain test data . . . . .	43
Derivation of formula for arc length . . . . .	44

TABLE OF CONTENTS

Subject	Page
Figures:	
1. Comparison of moment coefficients . . . . .	3
2. Stress-strain curve of foam rubber . . . . .	9
3. Deflection of top surface of one-way slab . . . . .	18
4. Deflections of top surface of two-way slab along centerline . . . . .	20
5. Contour map of two-way slab . . . . .	22
6. Deflections of top surface of two-way slab along quarter points . . . . .	24
7. Deflection along diagonal from corners of two-way slab . . . . .	25
8. Plan and sections of one-way slab . . . . .	28
9. Deflections perpendicular to centerline of one-way slab . . . . .	32
Plates:	
I. Stress-strain test setup . . . . .	7
II. One-way slab model, platform in place . . . . .	11
III. One-way slab model, platform removed . . . . .	11
IV. Two-way slab model, platform in place . . . . .	13
V. Two-way slab model, platform removed . . . . .	13
VI. Transverse bow in one-way slab model . . . . .	27

## MEMBRANE ANALOGY FOR TWO-WAY SLABS

A two-way slab may be defined as a rectangular slab supported on all four edges. It is frequently encountered in the design field, since its most common use is in the floors of buildings. When subjected to loads normal to the surface, the two-way slab bends in two directions in contrast to one-way slabs which are assumed to bend in one direction. The interdependency of the bending in two directions in the two-way slab makes it a highly indeterminate structure and difficult to analyze. These slabs have been analyzed by rigorous mathematical approach and investigated experimentally.

For design purposes the rigorous mathematical approach is not used because its complicated nature renders it impractical. Consequently, the designer resorts to codes for more workable information based on a combination of the rigorous solution and tests of models and prototypes. This information is usually given in the form of bending moment coefficients. The bending moment coefficients obtained from mathematical analysis, based on the assumption that the maximum load is reached when the maximum stress at any point reaches the yield point of the material, are more conservative than those found from tests. This has been accounted for mainly by the added usable strength attained from redistribution of stress caused by slight

yielding of portions of localized high stress.

Shown in Figure 1 is a comparison of bending moment coefficients of simply supported uniformly loaded two-way slabs derived from: 1) theoretical analysis by Timoshenko (2, p.133); 2) a combination of experimental and theoretical analysis by Westergaard (3, p.431); 3) Method 1 of the ACI Building Code (1, p.941); 4) Method 2 of the ACI Code (1, p.943).

The values given by Timoshenko (using a value of 0.3 for Poisson's ratio) are founded on rigorous mathematical analysis with the assumption that no yielding takes place. Westergaard, however, assumed Poisson's ratio to be zero, and assumed a reduction in moment coefficients due to localized yielding. He also modified theoretical results to obtain simpler mathematical expressions.

The ACI code offers two methods for obtaining bending moments in two-way slabs which differ considerably in results. No reason is given for this difference and either method is stipulated to yield an adequate design.

Models and prototypes have been tested using various mechanical, optical and electrical strain measuring devices giving varying test results. Some of this variance can be attributed to errors in measuring small strains and inadequacies in the test setup. The opinions already

Figure 1.

MOMENT COEFFICIENTS OF TWO-WAY SLABS  
SIMPLY SUPPORTED AND UNIFORMLY LOADED

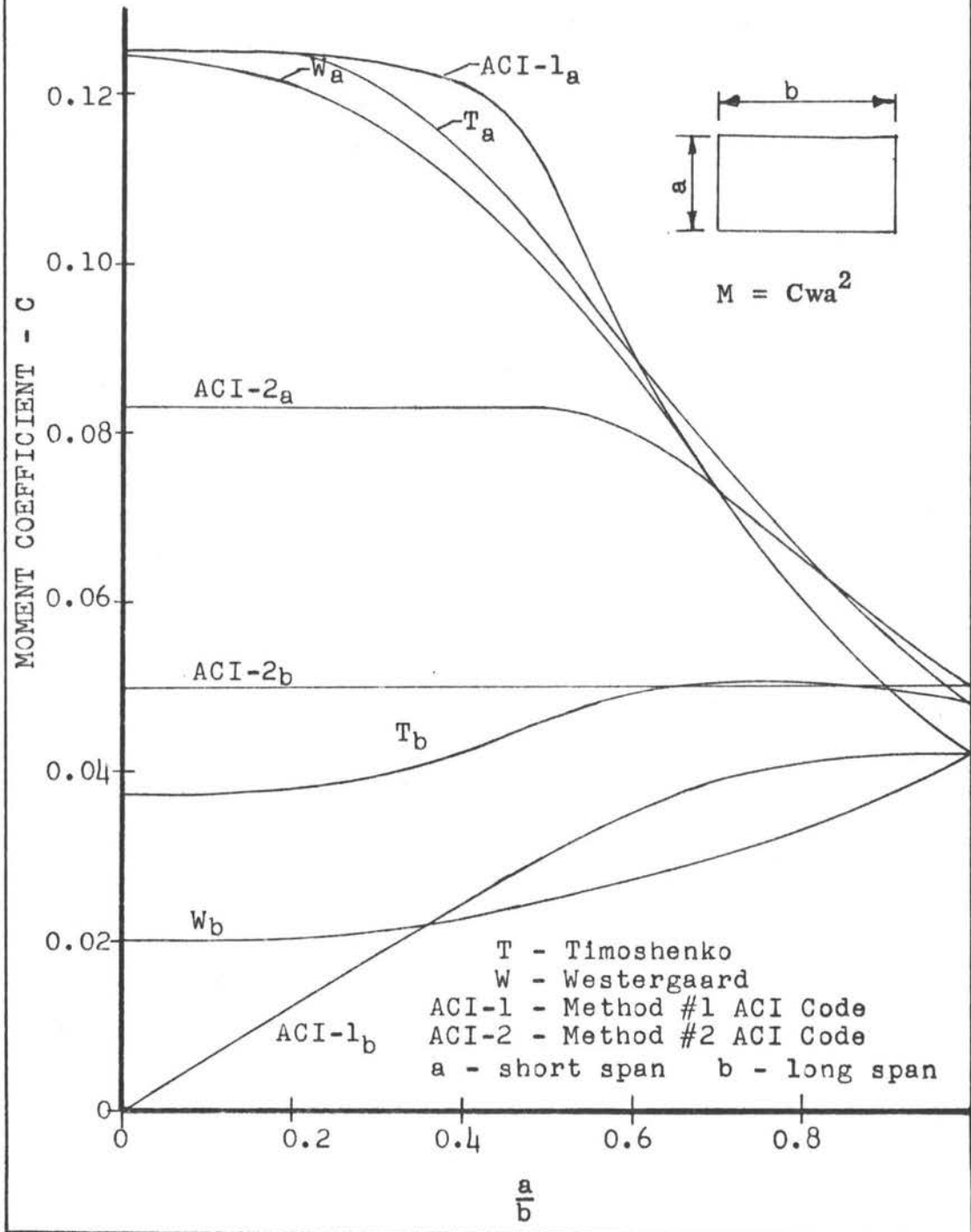



formed by the experimenter affect his location of the strain measuring devices and consequently affect the results of the test. Important strains can go unmeasured and their effects may be masked by inaccurate measurement of small strains.

It is evident that the four sources of design information cited will give four different solutions to the same problem. This and limited basic strain information made further investigation by a different approach the objective of this thesis.

Considering the shortcomings of present approaches, it was concluded that a concept of strain behavior on a greatly magnified and more dependable basis quantitatively was most desirable.

Foam rubber had been used successfully by Professor Orville Kofoid in other investigations concerned with stress concentrations. It was known to have a very small flexural rigidity, a linear stress-strain relationship, and it was not inclined to creep at low stress levels. From these known characteristics, foam rubber was considered a very appropriate material for a model of a two-way slab that would magnify strains to a large extent and on a dependable basis. Consequently, a foam rubber model of a two-way slab was constructed and tested.

In dealing with any material involving strains, dependable stress-strain information is highly essential.

Therefore, a stress-strain test and a Poisson's ratio test were made.

A one-way slab (or essentially a beam) is not open to question with respect to analysis and can be considered a standard for deflections and membrane behavior by which those of a two-way slab can be compared. Therefore, a correlation test was also made on a one-way slab.

The assumption involved in determining the strain behavior was based on the foam rubber slab models behaving as uniformly loaded membranes. This allows the application of the principle of the string polygon that the product of the sag at any point and the constant horizontal force equals the external moment. This principle is the key to correlations between the known behavior of the one-way slab and the unknown behavior of the two-way slab.

In the one-way slab the external moment can be definitely calculated and gives a positive check on the validity of the string polygon principle applied on the basis of measured strains. Therefore, the application of the string polygon principle in conjunction with measured strains in the two-way slab to arrive at external moments is established as a dependable basic working tool in the analysis of results.

DESCRIPTION OF TESTS AND MODELSStress-Strain Test

To obtain reliable stress-strain information the specimen has to be long enough to minimize the effect of rapid neckdown at the ends and wide enough so that minor imperfections in the material and unavoidable irregularities along the cut edges have insignificant effects on the test results. Consequently, a sheet of foam rubber<sup>1</sup> 25 in. by 9 in. by 1.06 in. was chosen for a test specimen and two sets of gage marks were centered on the specimen five and ten inches apart.

Foam rubber, having a very low modulus of elasticity, strains considerably for small increments of load and is also very resilient. This required the stress-strain test setup to provide good control, a high degree of sensitivity, and a long travel distance. Since standard testing machines do not fulfill these requirements, another means of testing had to be sought. The use of a drill press stand with minor modifications as a testing machine (shown in Plate I) seemed to be most plausible in accomplishing these ends.

Wooden loading blocks were glued firmly to the ends

---

<sup>1</sup>The foam rubber used for all tests and models was medium-firm Koylon, a product of U. S. Rubber Company.

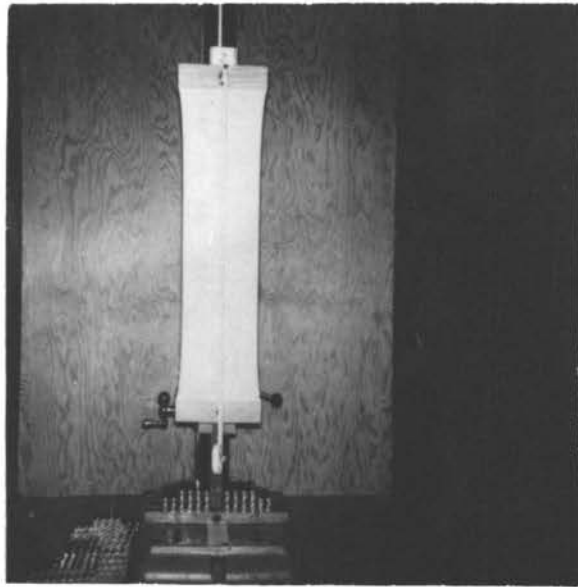

Plate I. Stress-strain test setup.

of the specimen. The top block was pinconnected to a mast bolted to a worm geared vertical travel assembly on the drill press column. The bottom block was pinconnected to a T-shaped hanger on which accurate brass weights were placed as increments of load.

Initially the hanger rested on the base of the drill press stand. The mast was raised by the vertical travel assembly inducing strain in the specimen. When this strain became great enough to accomodate the applied load, the hanger ceased to bear on the base of the stand. This condition was accurately determined by using a piece of paper under the hanger as a feeler gage. After the distance between gage marks was found by reading from a steel engineer's tape suspended from the top of the mast, another increment of load was applied and the process repeated.

Figure 2 shows the stress-strain curve derived from this test; from this, the modulus of elasticity was found to be 7.60 psi.

#### Poisson's Ratio Test

Poisson's ratio was found from testing a strip of foam rubber 30 in. long and 1.08 in. square. Gage marks five inches apart were centered on the specimen for the determination of longitudinal strain. Transverse strains were found from cross-sectional measurements. To minimize

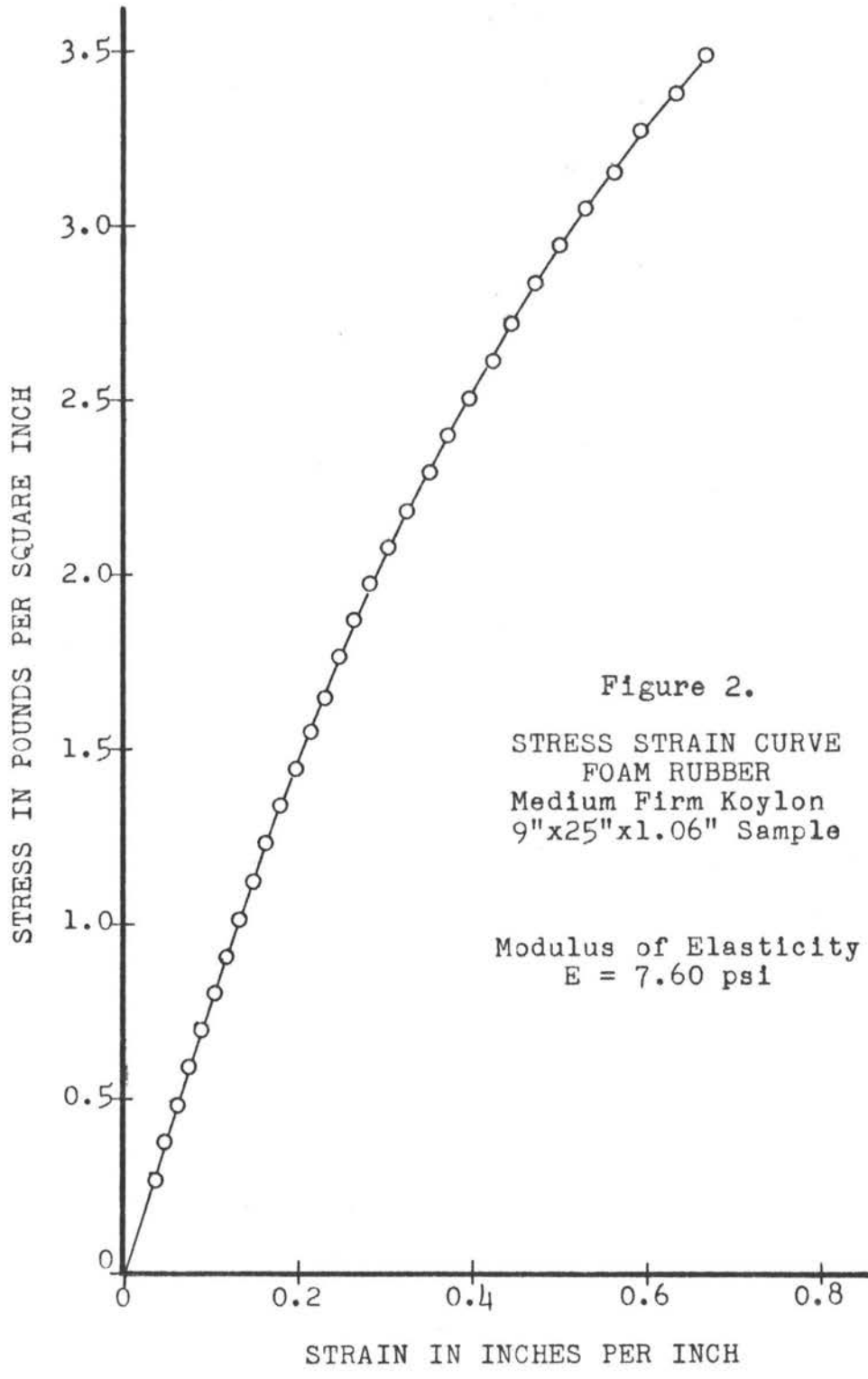

Figure 2.  
STRESS STRAIN CURVE  
FOAM RUBBER  
Medium Firm Koylon  
9"x25"x1.06" Sample  
  
Modulus of Elasticity  
E = 7.60 psi

the effect of errors in small measurements, strain measurements were taken at several stress levels and the results averaged giving a Poisson's ratio of 0.257. (Note Table 1, appendix).

### One-way Slab Model

In considering the dimensions of the one-way slab model, the span length must be long enough to allow the slab to sag considerably. It must also be wide enough to minimize the effect of minor imperfections in the material and irregularities along the cut edges. From these criteria and known stress-strain characteristics of the foam rubber, the model was constructed using a sheet of foam rubber 29 in. by 19.33 in. by 1.08 in.

Plates II and III show the setup for testing the one-way slab model. The foam rubber slab was laid out flat and completely relaxed on a removable platform. Wooden edge supports glued firmly to the 19.33 in. edges were pinconnected to a rigid supporting frame so that the edges were restrained from translation but were free to rotate. The platform was then removed and the slab allowed to sag under its own weight. Plate II shows the platform in place and Plate III shows the platform removed. To obtain deflections, the sliding scale of a tri-square was lowered from the top of a solidly supported two-by-four spanning



Plate II. One-way slab model,  
platform in place.



Plate III. One-way slab model,  
platform removed.



the model until it came in contact with the rubber. These deflections were read directly with the aid of a magnifying glass from a steel scale to the nearest 1/100th of an inch.

Intended deflections were measured along the centerline of the slab, but because a transverse bow appeared in the slab, deflections were also measured on a line perpendicular to the centerline at midspan. These deflections are recorded in Tables 2 and 3 of the appendix.

#### Two-way Slab Model

Several controlling factors were considered in arriving at the dimensions of the two-way slab model. The purpose of the test, to determine the validity of the membrane analogy for two-way slabs, dictated the use of a simple but indicative case. Consequently, a square slab simply supported on all four edges was considered with a view to minimizing the variables and taking advantage of symmetry. Again, as in the one-way slab, the span length had to be great enough to allow considerable sag. A 29 in. span length was assumed to yield the desired degree of sag and would also facilitate correlation with the one-way slab. Based on these criteria, a square sheet of foam rubber 29 in. by 29 in. by 1.06 in. was used for the model.

Plates IV and V illustrate the test setup for the two-way slab model.



Plate IV. Two-way slab model,  
platform in place.



Plate V. Two-way slab model,  
platform removed.

To provide a sound basis of correlation, the procedure followed in testing the two-way slab paralleled that used in testing the one-way slab.

The foam rubber slab was laid out flat and completely relaxed on a removable platform. Four wooden edge supports, glued firmly to the four edges of the slab, were pin-connected to a rigid supporting frame restraining the edges from translation but leaving them free to rotate. The platform was then removed and the slab was allowed to sag under its own weight.

The method used to determine deflections was the same as the method described in the one-way slab test.

Deflections were measured along the diagonal lines connecting the corners and on lines perpendicular to the edges. These deflections are recorded in Tables 4, 5 and 6 of the appendix.

ANALYSIS OF TESTS

Basic Method of Analysis

The basic tool used for analysis in the membrane analogy is the application of the string polygon principle as shown in the following:

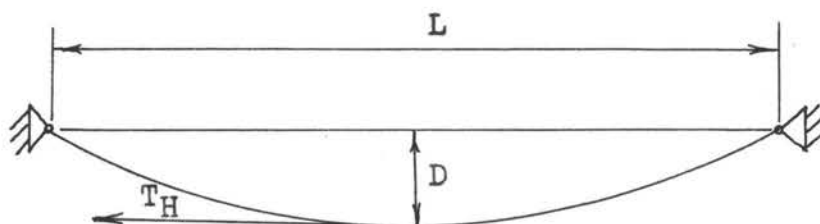

$S$  = arc length of strip

$t$  = thickness of strip

$b$  = width of strip

$E$  = modulus of elasticity of foam rubber

Since the slab was originally flat and relaxed, the total strain in a strip of the unsupported slab acting as a membrane is then the difference between the arc length  $S$  and the span length  $L$ . This divided by the span length gives the average unit strain  $e_{ave}$  in the strip.

$$e_{ave} = \frac{S-L}{L}$$

The unit strain at midspan  $e_H$  is the product of  $e_{ave}$  and  $L/S$ .

$$e_H = \frac{S-L}{L} \frac{L}{S}$$

The unit stress  $f$  at midspan is the product of  $e_H$  and the modulus of elasticity  $E$ .

$$f = \frac{S-L}{L} \frac{L}{S} E$$

The total horizontal force  $T_H$  in a strip  $b''$  wide and  $t''$  thick is the product of the unit stress  $f$  and the area  $bt$  of the strip.

$$T_H = \frac{S-L}{L} \frac{L}{S} E bt$$

From the string polygon principle, the external bending moment  $M$ , due to the weight of the membrane, at a point in the strip is the product of the constant horizontal component of tension  $T_H$  in the strip and the sag  $D$  at that point.

$$M = \frac{S-L}{L} \frac{L}{S} E bt D \quad (1)$$

### One-way Slab

The deflections of the top surface of the one-way slab along centerline were found to be well defined (within an average deviation of 0.006 inches) by the expression:

$$Y = 0.0116x^2$$

considering the origin of the coordinate axis at the top surface of the slab at midspan. (Note Fig. 3 and Table 2). Adjusting this to describe the line of tension yielded the expression:

$$Y = 0.0118x^2$$

with the origin midway between the top and bottom surfaces at midspan.

$$\text{Letting } x = \frac{L}{2} = 14.5" = A$$

$$\text{Sag at midspan is } 2.48" = D$$

the arc length S is then found by substituting these values of A and D into the equation:

$$S = \sqrt{A^2 + 4D^2} + \frac{A^2}{4D} \ln \frac{\sqrt{A^2 + 4D^2} + 2D}{\sqrt{A^2 + 4D^2} - 2D} \quad (4)^1$$

$$S = 29.56".$$

Taking a 1" strip and substituting into the formula:

$$M = \frac{S-L}{L} \frac{L}{S} EbtD \quad (1)$$

$$\begin{aligned} b &= 1" \\ t &= 1.08" \\ S &= 29.56" \\ L &= 29" \\ E &= 7.60 \text{ psi} \\ D &= 2.48" \end{aligned}$$

$$M = 0.386 \text{ in}\#$$

The moment at midspan calculated by the standard formula is shown for comparison:

---

<sup>1</sup>The derivation of this equation is given in the appendix.

Figure 3.

DEFLECTIONS OF THE TOP SURFACE  
OF THE ONE-WAY SLAB ON CENTERLINE

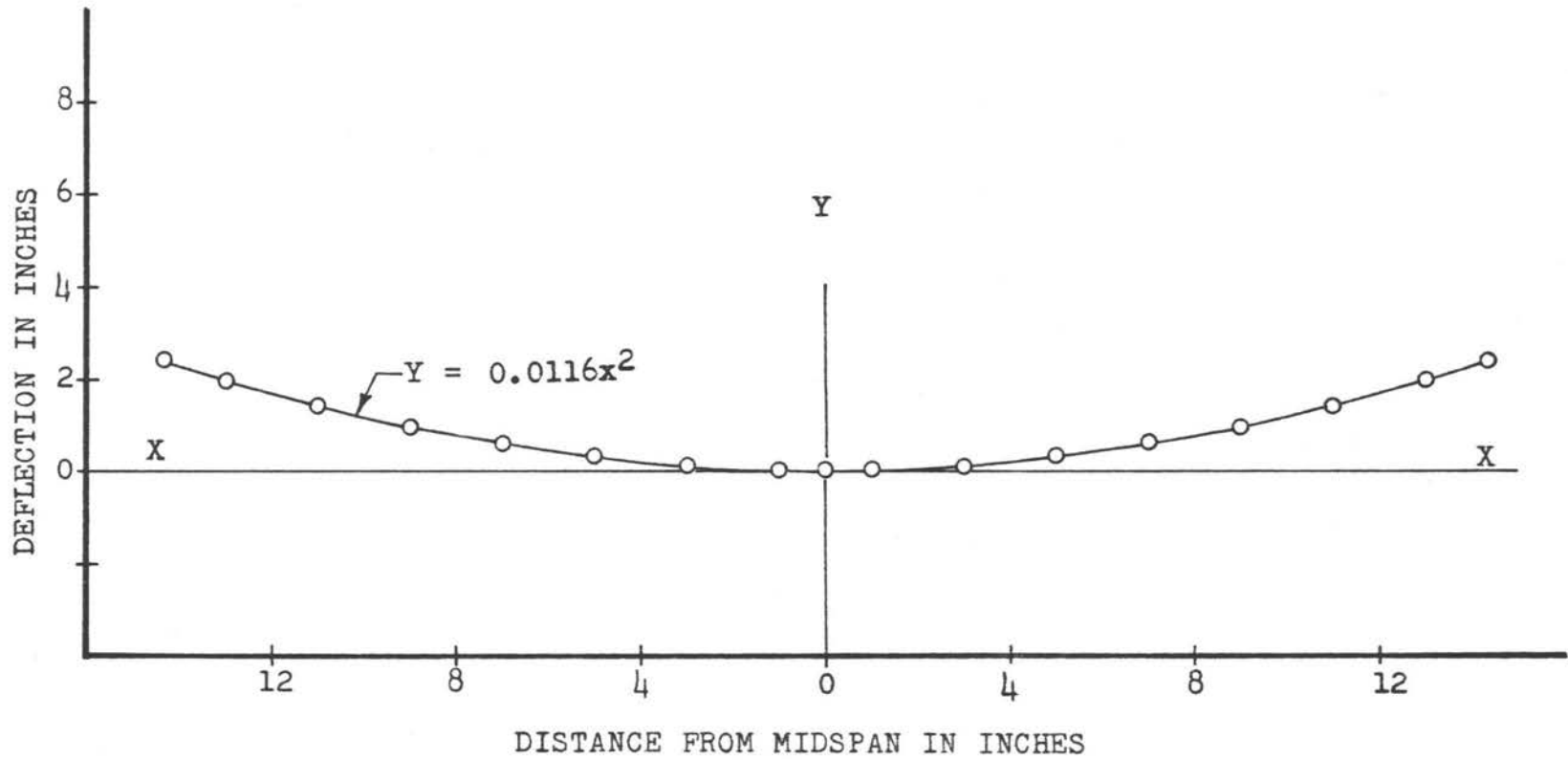

$$M = \frac{wL^2}{8}$$

w = uniform load of 0.00368#/in

$$M = 0.387\text{in}\#$$

This close correlation confirms the assumption that the foam rubber slab acts as a uniformly loaded membrane and forms a basis for sound analysis by the string polygon principle.

#### Two-way Slab

The deflections of the top surface of the two-way slab along centerline were found to be well defined (within an average deviation of 0.007 inches) by the expression:

$$Y = 0.0088x^2$$

considering the origin of the coordinate axis at the top surface of the slab at midspan. (Note Fig. 4 and Table 4). Adjusting this to describe the line of tension yielded the expression:

$$Y = 0.00855x^2$$

with the origin midway between the top and bottom surfaces at midspan.

$$\text{Letting } x = \frac{L}{2} = 14.5" = A$$

$$\text{Sag at midspan is } 1.80" = D$$

the arc length S is then found by substituting these values of A and D into the equation:



Figure 4.

DEFLECTIONS OF TOP SURFACE OF TWO-WAY  
SLAB ON CENTERLINE

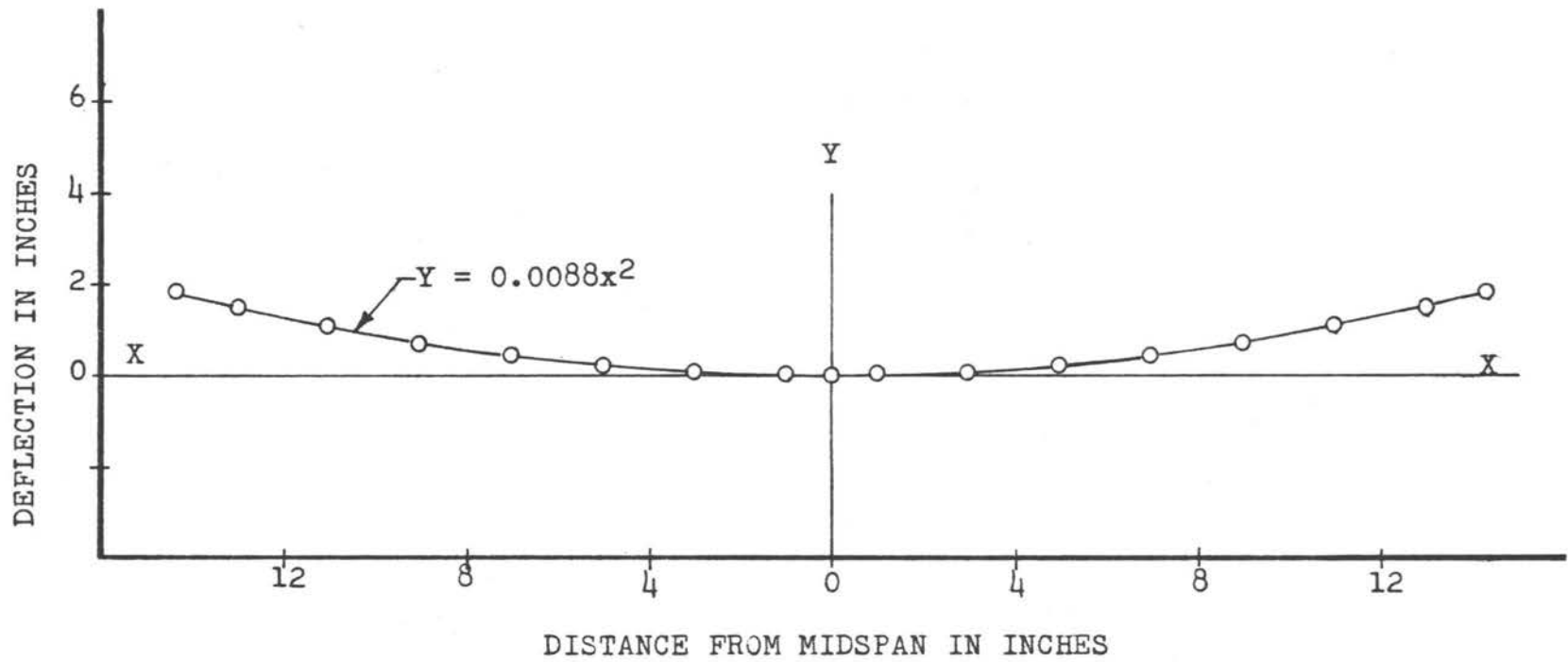

$$s = \sqrt{A^2 + 4D^2} + \frac{A^2}{4D} \ln \frac{\sqrt{A^2 + 4D^2} + 2D}{\sqrt{A^2 + 4D^2} - 2D} \quad (4)$$

$$s = 29.297''$$

Taking a 1" strip and substituting into the formula:

$$M = \frac{S-L}{L} \frac{L}{S} EbtD \quad (1)$$

$$\begin{aligned} b &= 1'' \\ t &= 1.06'' \\ S &= 29.297'' \\ L &= 29'' \\ E &= 7.60 \text{ psi} \\ D &= 1.80'' \end{aligned}$$

$$\begin{aligned} M &= 0.1471 \text{ in}\# \\ &= 0.0474 \text{ wL}^2 \end{aligned}$$

This value compares favorably to the moment coefficient 0.0479 given by Timoshenko (2, p.133) for a square plate with a Poisson's ratio of 0.30.

The other deflections taken were used to construct the contour map of the sagged specimen shown in Figure 5.

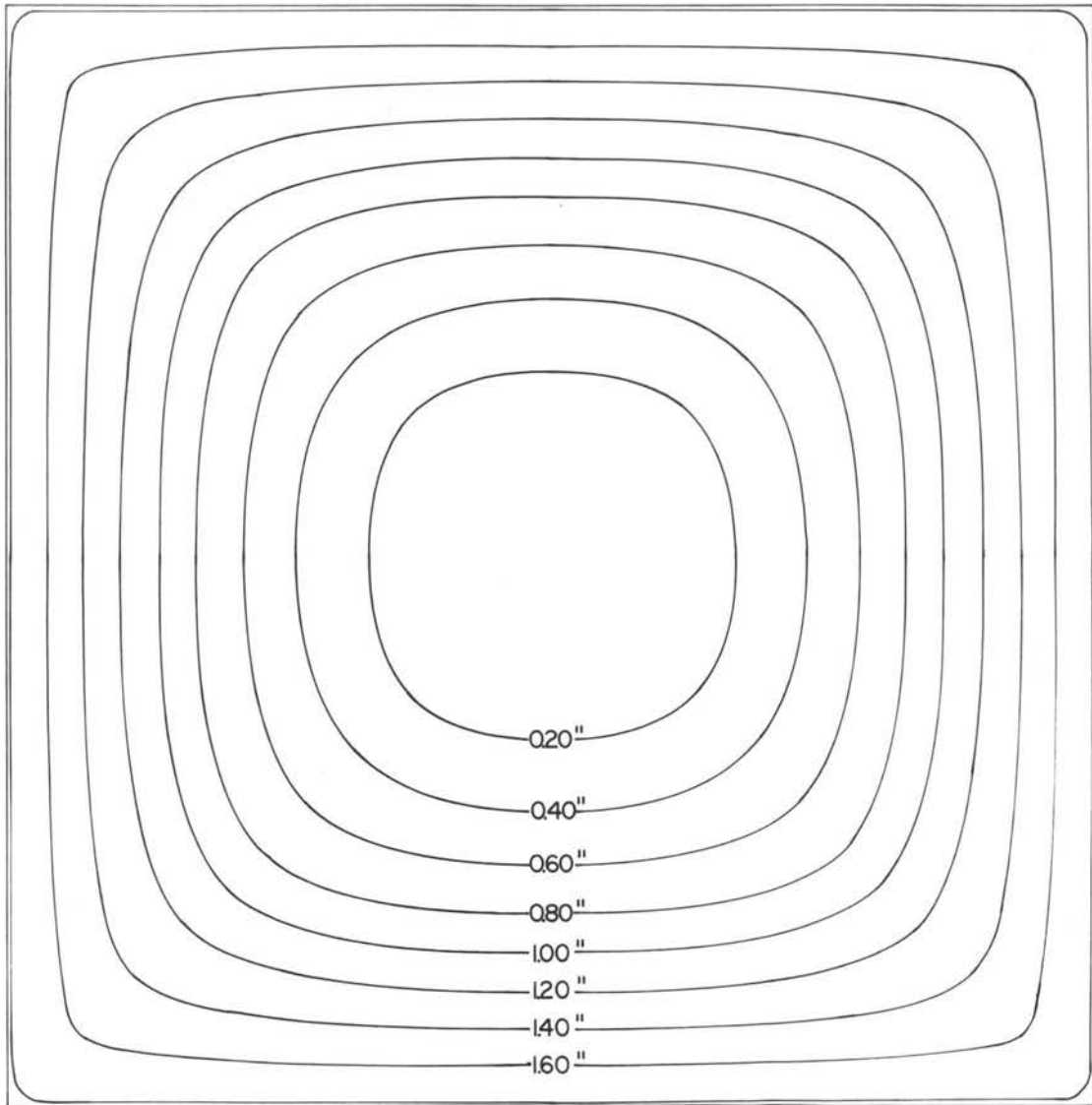

CONTOUR MAP OF TWO-WAY SLAB

29" SQUARE

Figure 5.

### DISCUSSION

It is interesting to note that sags along perpendicular lines from the edges other than at midspan in the two-way slab were very consistent. For example, the deflections of the top surface along the lines at the quarter points were found to be well defined by the expression:

$$Y = |0.00234x^{2.4}|$$

with an average deviation of 0.005 inches. (Note Fig. 6 and Table 5).

The deflections along the diagonal from the corners were also consistent, conforming to the expression:

$$Y = 1.05 (1 - \cos 6.9x)$$

with an average deviation of 0.007 inches. (Note Fig. 7 and Table 6).

A visual inspection of the two-way slab model in the corners gives an insight as to placement of reinforcing in the corners (note contour map, p.22). The curvature parallel to the diagonal from the inflection point is convex upward indicating negative moment in this direction. For this condition, reinforcement would be placed in the top of the slab parallel to the diagonal extending to the inflection point. The curvature perpendicular to the diagonal is concave upward indicating positive moment in

Figure 6.

DEFLECTIONS OF THE TOP SURFACE OF THE TWO-WAY SLAB  
ON A LINE AT 1/4 SPAN LENGTH

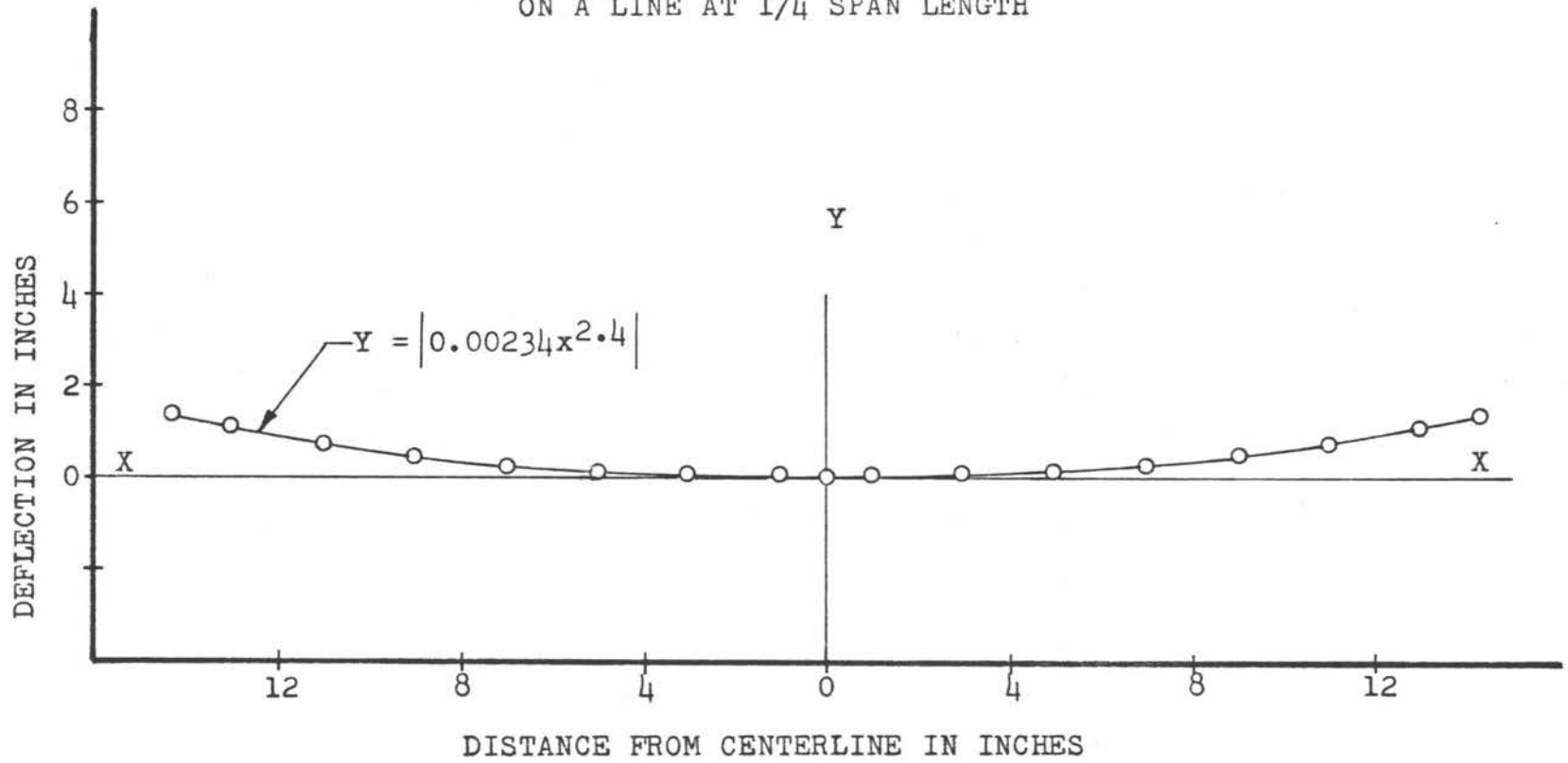
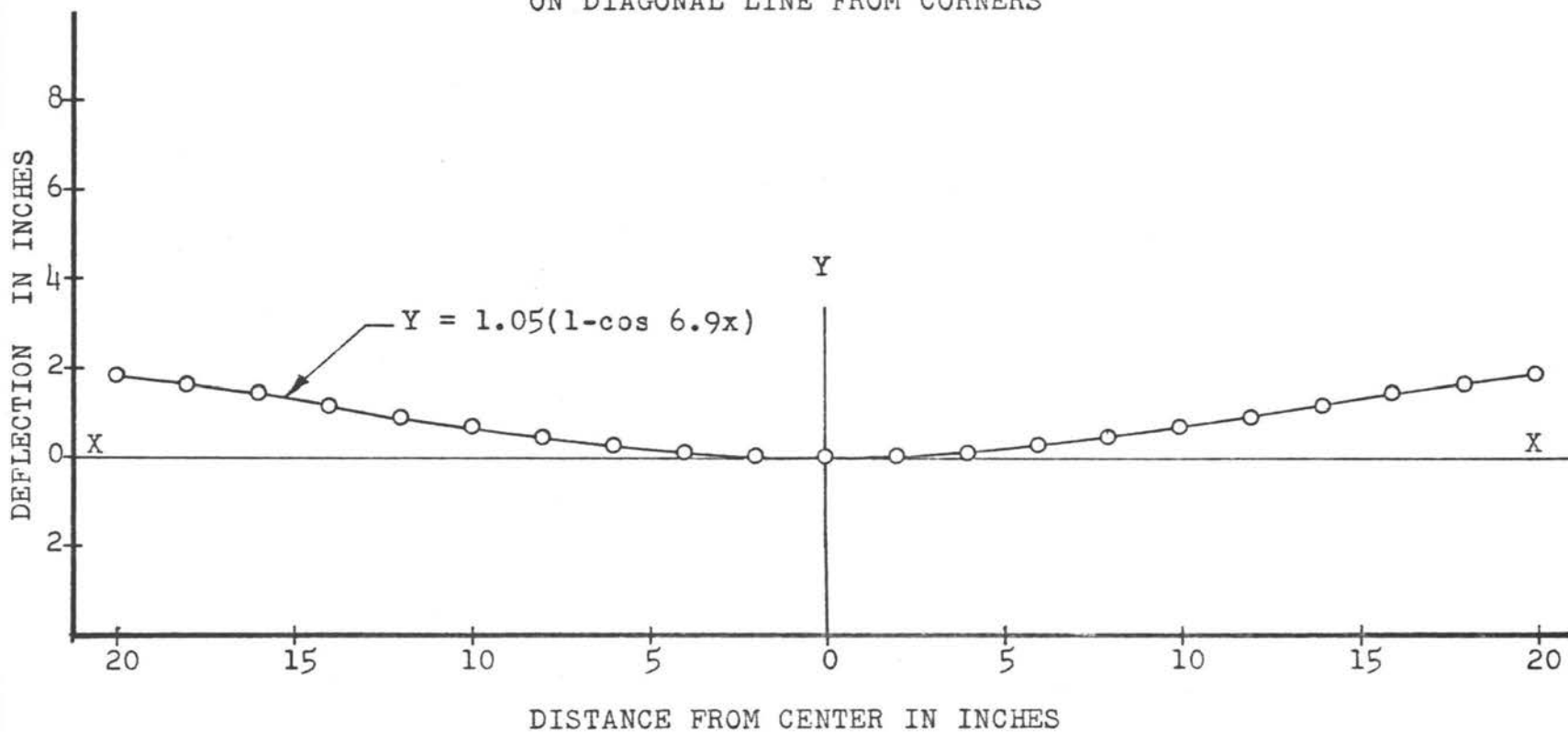

Figure 7.

DEFLECTIONS OF THE TOP SURFACE OF THE TWO-WAY SLAB  
ON DIAGONAL LINE FROM CORNERS



this direction. This requires reinforcing placed perpendicular to the diagonal in the bottom of the slab. The point of inflection occurred 7.95 inches from the corner corresponding to 5.63 inches from each edge or 19.4 percent of the span length.

These observations compare closely to the specifications set forth in the ACI Building Code, paragraph 709b, (1: p.941) which states:

Where the slab is not securely attached to the supporting beams or walls, special reinforcement shall be provided at exterior corners in both the bottom and top of the slab. This reinforcement shall be provided for a distance in each direction from the corner equal to one-fifth the longest span. The reinforcement in the top of the slab shall be parallel to the diagonal from the corner. The reinforcement in the bottom of the slab shall be at right angles to the diagonal or may be of bars in two directions parallel to the sides of the slab. The reinforcement in each band shall be of equivalent size and spacing to that required for the maximum positive moment in the slab.

Plate VI shows a transverse bow that appeared in the one-way slab specimen when it sagged. This bow was due to the difference in stress between the top and bottom of the specimen.

From Figure 8 it is seen that the arc distance between the edge supports on the bottom surface is longer by  $2S'$  than the distance along the top surface. This caused the strain in the bottom fibers to be greater than that in the top fibers. A lateral strain  $e'$  accompanies a



Plate VI. Transverse bow in  
one-way slab model.



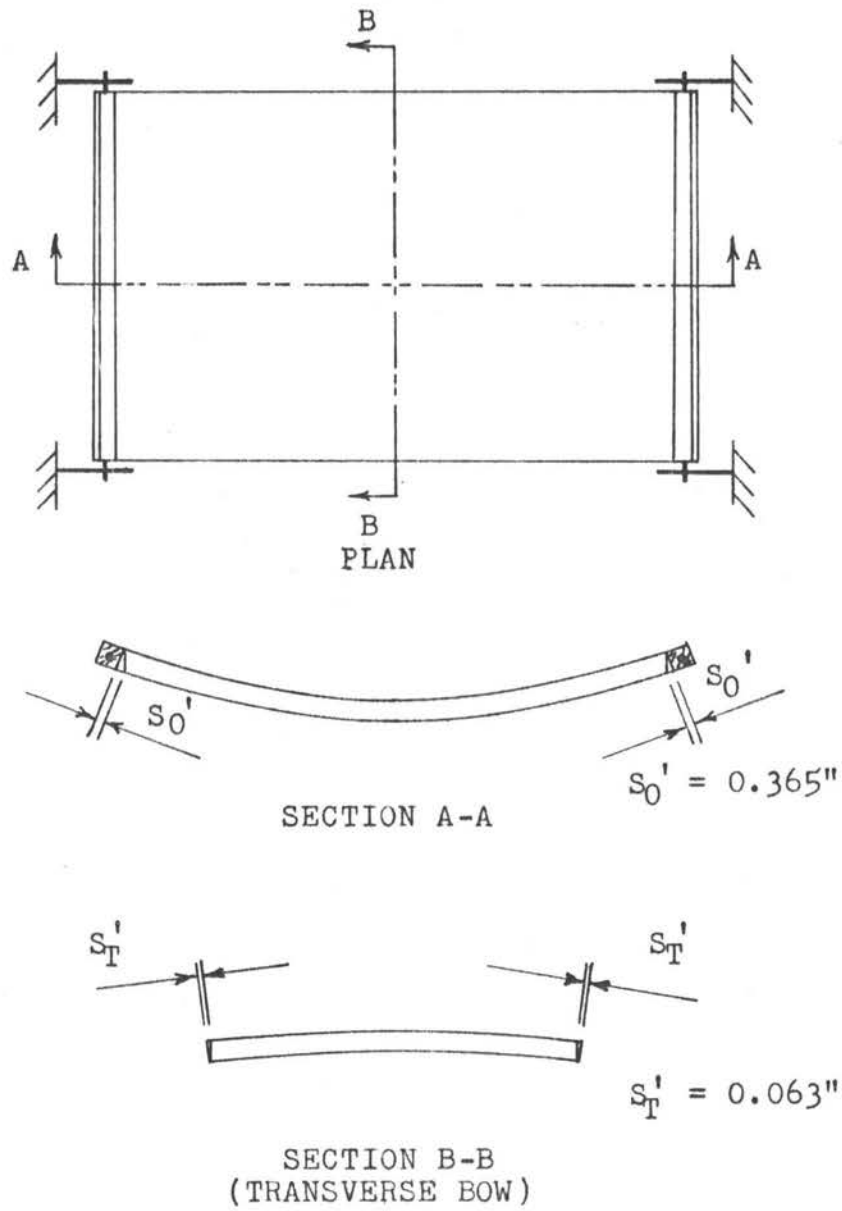

Scale: 1" = 10"

Figure 8.

PLAN AND SECTIONS OF ONE-WAY SLAB

longitudinal strain  $e$ , the ratio of  $e'/e$  being Poisson's ratio  $\mu$ . Since the top fibers were strained less than the bottom, the lateral strain in the top was correspondingly less than the lateral strain in the bottom. This caused the specimen to have a transverse bow convex upward.

The difference in strain between the top and bottom longitudinal fibers is then:

$$e_D = \frac{2S_0'}{L_0}$$

$$e_D = \frac{2(0.365)}{29} = 0.0252 \text{ in/in}$$

The difference in unit strain between the top and bottom transverse fibers is

$$e_D' = \frac{2S_T'}{L_T}$$

$$e_D' = \frac{2(0.063)}{19.33} = 0.0065 \text{ in/in}$$

Dividing  $e_D'$  by  $e_D$

$$\frac{e_D'}{e_D} = \frac{0.0065}{0.0252}$$

$$\frac{e_D'}{e_D} = 0.258$$

This value compares favorably to the experimental value of 0.257 obtained from the Poisson's ratio test.

From this it is logical to conclude that this same action takes place in a beam, but is more pronounced in a slab. If this bow is restrained from occurring as in the case of an infinitely long two-way slab, the moment induced in the long span will be the product of Poisson's ratio and the moment in the short span; since stress is proportional to strain which is in turn proportional to the bending moment  $M$ .

$$M_L = uM_s$$

$M_L$  = moment in long span

$M_s$  = moment in short span

$u$  = Poisson's ratio

The moment at midspan of a uniformly loaded infinitely long two-way slab then becomes

$$M_L = u \frac{wL_s^2}{8}$$

$w$  = load #/in

$L_s$  = length of short span in inches

If the difference in strain between the top and bottom fibers in the longitudinal direction is constant throughout the width of the specimen, the curvature of the transverse bow would also be constant. This leads to the assumption that the bow is circular. To investigate this assumption, perpendiculars to tangent lines at the edges were projected. The length of the perpendicular lines

from the tangent points to their point of intersection were taken as the radius of curvature. This value was found to be 164.9" and substituted into the type equation for a circle yielded the expression:

$$Y = \sqrt{164.9^2 - x^2} - 164.9$$

This equation was found to describe the transverse bow with an average deviation of 0.006 inches. (Note Fig. 9 and Table 3). Since the subtended angle is very small, it would appear as though changing the value of the radius would not affect Y appreciably, however, a change of one inch alters the calculated deflections by approximately one percent.

As stated previously, it was desired to find a method for experimental analysis of the two-way slab that would greatly magnify strains on a dependable basis. The very consistent results obtained from the tests show that these ends have been attained. The bending moment coefficients derived from the membrane analogy closely parallel those derived from rigorous mathematical analysis by Timoshenko. The experimental data taken were consistent to the degree that equations could be written describing the deflections of the slabs. The low modulus of elasticity of the rubber allowed greatly magnified strains which provided an insight into the basic actions which take place in both the one-way and two-way slab. For example, the transverse bow,

Figure 9.

DEFLECTIONS OF TOP SURFACE OF ONE-WAY SLAB  
ON A LINE PERPENDICULAR TO CENTERLINE AT MIDSPAN

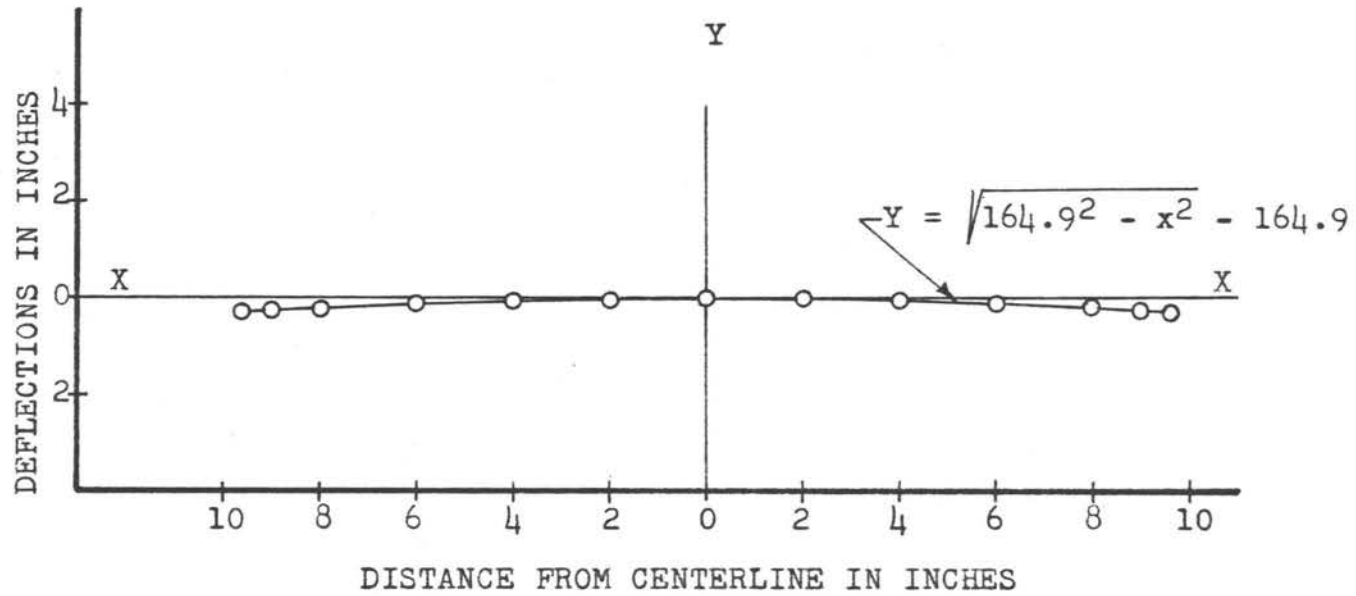

revealing the effect of Poisson's ratio on slab behavior, would probably have gone unnoticed without this magnification. A visual inspection of the sagged membrane also provided an insight into the particularly complex stress conditions of the corners.

From the results obtained in this investigation it appears that the membrane analogy would be of use not only in the analysis of other two-way slabs with varying length to width ratios, but the concepts used therein could possibly be extended to the analysis of other complex or unusual problems for which the solutions are questionable or nonexistent.

### CONCLUSIONS

From the results of this study the following conclusions are presented:

1. The membrane analogy has provided a new and reliable method for experimental analysis of the two-way slab on both a qualitative and quantitative basis.

2. The membrane analogy is further substantiated by the close agreement of bending moment coefficients derived from the analogy with those derived from rigorous mathematical analysis by Timoshenko.

3. The derived mathematical expressions describing measured deflections verify the consistency of the data and substantiate the dependability of the membrane analogy.

4. The transverse bow which appeared in the one-way slab revealed the importance of Poisson's ratio in the analysis of slab behavior.

5. The use of foam rubber models shows promise in being extended to the analysis of other complex stress problems.

BIBLIOGRAPHY

1. American Concrete Institute. ACI standard building code requirements for reinforced concrete (ACI 318-56). Detroit, Michigan, May 1956. p.913-986.
  2. Timoshenko, S. Theory of plates and shells. New York, McGraw-Hill, 1940. 492p.
  3. Westergaard, H. M. and W. A. Slater. Moments and stresses in slabs. Proceedings of the American Concrete Institute 17:415-538. 1921.
- 



APPENDIX

Table 1. Poisson's ratio test.

Reading	Width in.	Length in.	Perpendi- cular Strain in/in	Longitu- dinal Strain in/in	Poisson's Ratio (u)
1	1.08	5.00	0	0	
4	1.05	5.53	0.0278	0.108	0.257
5	1.04	5.74	0.037	0.148	0.250
6	1.03	5.93	0.0463	0.186	0.249
7	1.02	6.02	0.0556	0.204	0.273
8	1.01	6.18	0.0648	0.236	0.275
9	1.00	6.40	0.0742	0.280	0.265
10	0.95	7.50	0.1202	0.50	0.241
mean value					0.257

Table 2. Deflection of top surface of one-way slab along centerline.

X (Distance from Midspan) in.	Y (Deflection)		Deviation <sup>+</sup>
	Experimental in.	Formula* in.	
0	0	0	0
1	0.01	0.01	0.00
3	0.10	0.10	0.00
5	0.29	0.29	0.00
7	0.57	0.57	0.00
9	0.95	0.94	0.01
11	1.38	1.40	0.02
13	1.97	1.96	0.01
14.32	2.41	2.40	0.01

$$*Y = 0.0116x^2$$

<sup>+</sup>Average deviation 0.006

Table 3. Deflections perpendicular to centerline at midspan of one-way slab. (Transverse bow)

X (Distance from Centerline) in.	Y (Deflection)		Deviation <sup>+</sup>
	Experimental in.	Formula* in.	
0	0.00	0.00	0.00
2	0.02	0.014	0.006
4	0.06	0.05	0.01
6	0.12	0.12	0.01
8	0.20	0.197	0.003
9	0.25	0.245	0.005
9.6	0.29	0.280	0.01

$$*Y = \sqrt{(164.9)^2 - x^2} - 164.9$$

<sup>+</sup>Average deviation 0.006

Table 4. Deflection of top surface of two-way slab along centerline.

X (Distance from Center) in.	Y (Deflection)		Deviation <sup>+</sup>
	Experimental in.	Formula* in.	
0	0	0	0
1	0.02	0.01	0.01
3	0.08	0.08	0.00
5	0.22	0.22	0.00
7	0.43	0.43	0.00
9	0.73	0.72	0.01
11	1.09	1.07	0.02
13	1.52	1.49	0.03
14.38	1.82	1.82	0.00
15.2	2.03	2.03	0.00

$$*Y = 0.0088x^2$$

<sup>+</sup>Average deviation 0.007

Table 5. Deflection of top surface of two-way slab along lines at quarter points.

X (Distance from Centerline) in.	Y (Deflection)		Deviation <sup>+</sup>
	Experimental in.	Formula* in.	
0	0	0	0
1	0.01	0.02	0.01
3	0.05	0.033	0.02
5	0.11	0.11	0.00
7	0.25	0.25	0.00
9	0.47	0.46	0.01
11	0.74	0.74	0.00
13	1.10	1.10	0.00

$$*Y = |0.00234x^{2.4}|$$

<sup>+</sup>Average deviation 0.005

Table 6. Deflection along diagonal from corners of two-way slab.

X (Distance from Center) in.	Y (Deflection)		Deviation <sup>+</sup>
	Experimental in.	Formula* in.	
0	0	0	0
2	0.01	0.03	0.02
4	0.10	0.11	0.01
6	0.25	0.26	0.01
8	0.45	0.45	0.00
10	0.68	0.67	0.01
12	0.91	0.92	0.01
14	1.18	1.18	0.00
16	1.42	1.42	0.00
18	1.63	1.63	0.00
20	1.82	1.83	0.01

\* $Y = 1.05 (1 - \cos 6.9x)$

<sup>+</sup>Average deviation 0.007

Table 7. Stress-strain test.

Load lbs.	Stress psi	Strain (10" gage) in/in	Strain (5" gage) in/in
2.545	0.2165	0.035	0.036
3.562	0.374	0.048	0.049
4.579	0.480	0.060	0.062
5.596	0.586	0.074	0.078
6.613	0.694	0.089	0.090
7.630	0.800	0.101	0.103
8.647	0.906	0.116	0.118
9.664	1.013	0.130	0.132
10.681	1.120	0.145	0.150
11.698	1.228	0.160	0.164
13.732	1.441	0.176	0.180
14.749	1.548	0.210	0.214
15.766	1.652	0.228	0.228
16.783	1.759	0.245	0.248
17.800	1.868	0.263	0.262
18.817	1.974	0.280	0.282
19.834	2.080	0.302	0.302
20.851	2.185	0.325	0.325
21.868	2.295	0.350	0.348
22.885	2.400	0.374	0.370
23.923	2.507	0.398	0.395
24.961	2.615	0.421	0.426
25.999	2.721	0.446	0.442
27.037	2.835	0.472	0.471
28.075	2.941	0.500	0.500
29.113	3.05	0.530	0.530
30.151	3.16	0.562	0.565
31.189	3.27	0.591	0.592
32.227	3.38	0.638	0.632
33.265	3.49	0.668	0.668



DERIVATION OF FORMULAS FOR FINDING THE ARC  
LENGTH OF A LINE

The deflections along perpendicular lines from the edges were found to be describable by equations of the type:

$$y = \left| \frac{D}{A^n} x^n \right| \quad (2)$$

To obtain the strain in a strip along one of these lines, the arc length  $S$  has to be found. This arc length can be found arithmetically, graphically, or analytically. The analytical solution was used because it is more exact and involves less calculation once the formulas have been derived. Derivations of these formulas follow:

For a differential length of arc

$$dS^2 = dx^2 + dy^2$$

$$dS = \sqrt{1 + \left(\frac{dy}{dx}\right)^2} dx$$

$$\frac{dy}{dx} = \frac{nD}{A^n} x^{n-1}$$

$$dS = \sqrt{1 + \left(\frac{nD}{A^n} x^{n-1}\right)^2} dx$$

$$S = \int \sqrt{1 + \left(\frac{nD}{A^n} x^{n-1}\right)^2} dx \quad (3)$$

For a parabolic arc,  $n = 2$

$$\text{Letting } \frac{2D}{A^2} = \frac{1}{K}$$

$$S = \frac{1}{K} \int_{-A}^{+A} \sqrt{K^2 + x^2} \, dx$$

$$S = \frac{1}{K} \left[ \frac{x}{2} \sqrt{K^2 + x^2} + \frac{K^2}{2} \ln x \sqrt{K^2 + x^2} \right]_{-A}^{+A}$$

$$S = \sqrt{A^2 + 4D^2} + \frac{A^2}{4D} \ln \frac{\sqrt{A^2 + 4D^2} + 2D}{\sqrt{A^2 + 4D^2} - 2D} \quad (4)$$

$A =$  one-half the span length

$D =$  sag at midspan

It is seen that the exact solution for the length of arc is a rather cumbersome expression. The solution for a parabolic arc involves square roots and logarithms and the general solution has a repeating integral. This led to the following derivation for a series that could be easily applied and also give accurate values for  $S$ :

Expanding by the binomial series the expression

$$\sqrt{1 + \left( \frac{Dn}{A^n} x^{n-1} \right)^2}$$

in the differential equation

$$dS = \sqrt{1 + \left( \frac{Dn}{A^n} x^{n-1} \right)^2} \, dx$$

$$dS = \left[ 1 + \frac{1}{2} \frac{n^2 D^2 x^{2n-2}}{A^{2n}} - \frac{1}{8} \frac{n^4 D^4 x^{4n-4}}{A^{4n}} \right. \\ \left. + \frac{1}{16} \frac{n^6 D^6 x^{6n-6}}{A^{6n}} - \frac{5}{128} \frac{n^8 D^8 x^{8n-8}}{A^{8n}} \dots \right] dx$$

Integrating this expression between the limits of  $-A$  and  $+A$  and letting  $A$  equal  $L/2$  yielded the expression:

$$S = L \left[ 1 + \frac{1}{2(2n-1)} \frac{(2nD)^2}{L^2} - \frac{1}{8(4n-3)} \frac{(2nD)^4}{L^4} \right. \\ \left. + \frac{1}{16(6n-5)} \frac{(2nD)^6}{L^6} - \frac{5}{128(8n-7)} \frac{(2nD)^8}{L^8} \dots \right] \quad (5)$$

$S$  = Length of arc between  
 $x = \pm A$  of the expression

$L$  = span length

$D$  = sag at midspan

This series is easily applied and gives accurate values for  $S$  for curves of the type:

$$Y = \left| \frac{D}{An} x^n \right|$$

$$n > 1$$

$$2nD < L$$