

Bearing Strength Capacity of Continuous Supported Timber Beams: Unified Approach for Test Methods and Structural Design Codes

A. J. M. Leijten¹; S. Franke²; P. Quenneville³; and R. Gupta, M.ASCE⁴

Abstract: Bearing or compressive-strength capacity perpendicular to the grain of timber beams is a troublesome issue. Not only do many different load cases occur in practice that are not covered by structural timber design codes, but also these codes provide only a basic provision and vary throughout continents. Code design rules require the standardized compressive or bearing strength to be determined by test standards. An assessment of the results of standard test methods of the European Union, North America, and Australia/New Zealand shows incompatibility. It is demonstrated how previously incompatible results can be made compatible by using a physical model and some calibration tests. The proposed model offers a consistent and simple way to bridge the differences between both test standards and structural design codes. DOI: 10.1061/(ASCE)ST.1943-541X.0000454. © 2012 American Society of Civil Engineers.

CE Database subject headings: Wood beams; Load bearing capacity; Structural design; Standards and codes; Compressive strength.

Author keywords: Timber; Bearing; Perpendicular to grain; Capacity; Radiata pine; Compression strength.

Introduction

Timber beams used as structural elements like floor joists or studs always require support at the beam ends to transfer the forces. Joists usually find support on either timber beams or other structural materials. This type of support is known as local or discreet. In this paper, the focus is on a fully supported beam locally loaded perpendicular to grain. Both support conditions in Fig. 1 are just examples in which the compressive strength perpendicular to grain, also called bearing strength in many countries, plays an important role. A model successful in estimating the bearing capacity is a potential candidate to understand the bearing capacity of local support situations.

Nevertheless, many believe that compressive (bearing) failure does not pose a threat to the structure because the type of failure is plastic and does not lead to structural collapse. However, high deformations can impair the use of a structure as much as brittle failure. Mixing serviceability and ultimate limit considerations is wrong. It is generally accepted that they are completely separate situations that require a different approach. Deformation criteria should, in principle, not be incorporated into ultimate limit-state design because deformations at the moment of structural collapse are irrelevant. A rough sketch of the load-deformation behavior of timber loaded perpendicular to grain is given in Fig. 2.

Comparing the respective test standards to determine the standard compressive strength and structural design codes of Europe, North America, Australia/New Zealand, and Asia, is revealing. In

the test standards, the dimensions of the test specimen, load configuration, and definition of the standard compressive strength are different, all leading to incompatible results. This would not be a problem if applying the regulations in the respective structural design code would result in the same bearing capacity for a given situation. For the situations in Fig. 1, bearing-capacity differences of 30% and more can be observed. In other words, there is a need to update and unify both standard test procedures and design code rules. It is realistic to assume that code writers are reluctant to modify test and design standards that have been in use for decades. If this is so, this paper demonstrates the ability of a recently published physically based model that explains the differences and shows how to unify test and structural design standards with a minimum of effort.

Differences in Test Piece Dimensions and Load Configuration

Since early 1926, the ASTM D143 test method to determine the standard compressive strength perpendicular to grain has been used. The test setup reflects the situation of a beam fully supported on a bearing wall or foundation, and loaded by a square stud (Bodig and Jayne 1982, Fig. 3, specimen B). The timber specimen itself is 51 × 51 × 152 mm of clear wood and is loaded in the center by a 51 × 51 mm square steel plate. The radial direction of the annual growth rings corresponds with the load direction. For structural size timber with knots, the compressive strength is higher because knots act like reinforcement (Madsen et al. 1982). For this reason, the compressive perpendicular to grain test is absent in ASTM D198 (2008), which deals with static tests for structural lumber. Over the years, the ASTM-D143 test setup has been taken over by many other countries in America and Asia. Approximately the same specimen dimension and loading configuration are prescribed by the Australian/New Zealand Standard (AS/NZS) 4063 (1992) (part 1) and by the latest version of September 2009. The test specimen has the following dimensions: 45- to 50-mm depth, a

¹Associate Professor, Eindhoven Univ. of Technology, Eindhoven, Netherlands (corresponding author). E-mail: A.J.M.Leijten@tue.nl

²Research Fellow, Auckland Univ., Auckland, New Zealand.

³Professor, Auckland Univ., Auckland, New Zealand.

⁴Professor, Oregon State Univ., Corvallis, OR 97331.

Note. This manuscript was submitted on March 12, 2010; approved on June 15, 2011; published online on January 17, 2012. Discussion period open until July 1, 2012; separate discussions must be submitted for individual papers. This paper is part of the *Journal of Structural Engineering*, Vol. 138, No. 2, February 1, 2012. ©ASCE, ISSN 0733-9445/2012/2-266-272/\$25.00.

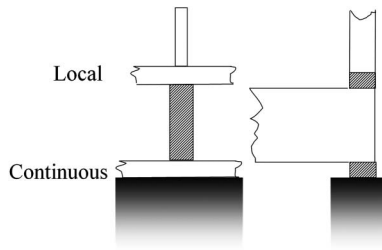

Fig. 1. Continuous and local supports

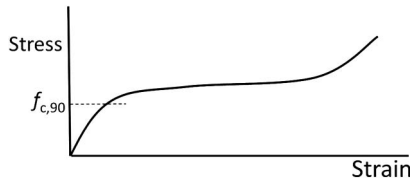

Fig. 2. Stress-strain curve perpendicular to grain of wood

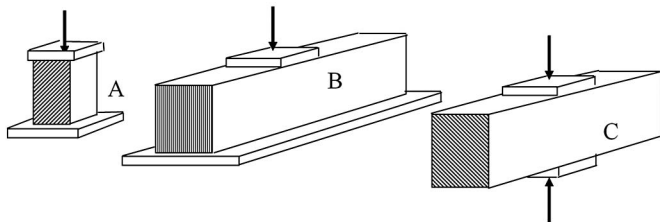

Fig. 3. Test specimens

minimum width of 35 mm, and a length of 200 mm, which is 48 mm longer than the ASTM D143 test piece.

Since the early 1990s, the unification of the European market forced the European Committee for Standardization (CEN) to draft European Standards. For structural timber, the test methods are given by CEN EN 408 (2003). In contrast to the ASTM test method, the CEN test method takes a completely different starting point in which the test piece is loaded over its entire surface (Fig. 3, Specimen A). The test piece dimensions are $45 \times 70 \times 90$ mm and $45 \times 70 \times 180$ mm for sawn timber and glued-laminated test specimens, respectively. It reflects the choice of CEN to aim at well-defined physical material properties instead of properties related to typical uses or applications. It assumes that scientific models implemented in the European structural design code use these material properties to determine the bearing capacity for any practical situation, in contrast to other countries that have chosen the technological ASTM D143 approach. For this reason only, it is not surprising that differences between the ASTM and CEN test setups cause incompatible test results.

A third standard test method is presented in ISO 13910 (2005), which is similar to the alternative test given in the informative annex of AS/NZS 4063 (1992). Although the loading condition resembles the ASTM D143 test method, the specimen is not fully supported but mirrored, as shown in Fig. 3, specimen C. Another deviation from ASTM and CEN is that structural size specimens are prescribed. The dimensions of the test piece are not yet specified, but are all related to the specimen depth. The specimen length is six times the specimen depth. However, whatever the test-piece depth, the dimension of the steel plates used to introduce the load is fixed to 90 mm along the grain. Arguments for this choice given by

Leicester et al. (1998) are to match in-service practices and partly because bearing is a local phenomenon that does not involve the full depth of the beam. In general, this test setup with opposite loaded steel plates results in the lowest strength values. In the annex of AS/NZS 4063, it is argued that the test may form the basis for determining the characteristic strength values of structural size timber, although there is limited experience of application.

Although the results of these standard tests can be useful, the structural-design-code clauses need empirically determined correction factors to account for different loading and support conditions occurring in practice.

Difference in Definition of Strength

An important problem encountered in the interpretation of test results is the difference between test standards in definition of the compressive strength. For clear wood specimens of 50-mm height, ASTM D143 defines the compressive strength at 1 mm (0.04 in.) deformation, which corresponds to 2% strain. The AS/NZS 4063 (1992) sets a fixed 2-mm deformation as definition, which corresponds to a strain of 4%, as illustrated in Fig. 4. It is obvious that this type of definition does not account for differences in wood species in which density affects significantly the steepness of the stress-strain curve. Once again, the CEN standard takes a different approach. The standard's compressive strength is defined by the intersection between the stress-strain curve and a line parallel to the elastic part of the curve with 1%*h* offset, where *h* is the specimen height. The elastic part is taken as the intersection of a straight line and the deformation curve at 10 and 40% of the estimated standard compressive strength. This method therefore accounts for differences in elastic stiffness of wood species.

The ISO 13910 and AS/NZS 3603 take identical definitions. The ISO takes the intersection at a fixed 0, 1*h* deformation. The AS/NZS follows the same approach as the CEN standard, but now with a line 2-mm offset, irrespective of the specimen height *h*. The latter definition is suggested as an alternative for the proportional limit reflecting a serviceability limit according to Leicester et al. (1998).

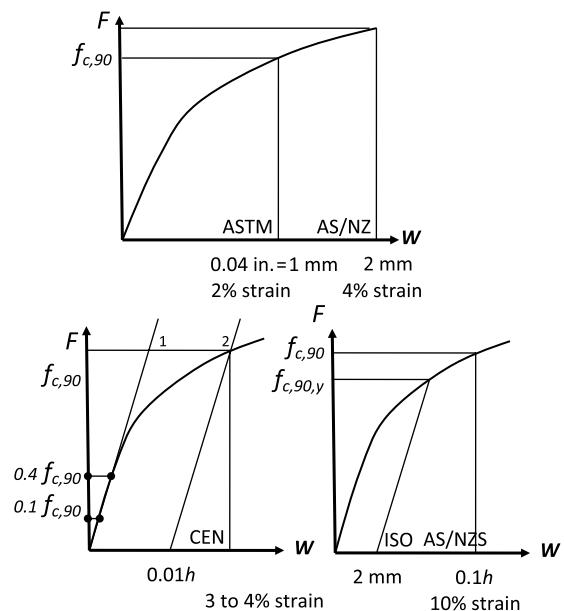

Fig. 4. Strength definitions

As Poussa et al. (2007) shows for Finnish spruce, the ASTM D143 specimen results in 2.5 times higher strength values, i.e., 7 N/mm² compared with 2.8 N/mm² with CEN EN 408. Franke and Quenneville (2011) report for New Zealand Radiata pine 5.7 N/mm² using the CEN EN 408 test method, and 11.1 N/mm² using the 2-mm offset ISO 13910 and AS/NZS 4063 (1992). The strength values are very different and incompatible.

Differences in Structural Design Codes

If test standards of the continents result in different standard-strength values, it is interesting to analyze what various structural design codes stipulate in the bearing-capacity design clauses. Particularly for the National Design Specification (NDS) (2005) and the Standards New Zealand (NZS) 3603 (1992), which are the structural timber design codes of the United States and Australia/New Zealand, only one particular clause deals with the determination of the bearing capacity. The bearing capacity is calculated by multiplying the loaded area times the standard compressive strength times a factor k_c . Both standards refer only to one specific design situation given in Fig. 5 in which two beams overlap. One is the continuously supported bearing beam locally loaded by the top beam. No guidance is provided on which of the two beams actually fails in bearing. Experiments in the past must have shown the influence of the overlap length, as the factor k_c depends on the overlap length up to 150 mm. The smaller the overlap, the higher the factor k_c is (Table 1). For both NDS (2005) and NZS 3603 (1992), this factor is almost the same. The CEN EN 1995-1-1/A1 (2008) (Eurocode 5) takes a completely different

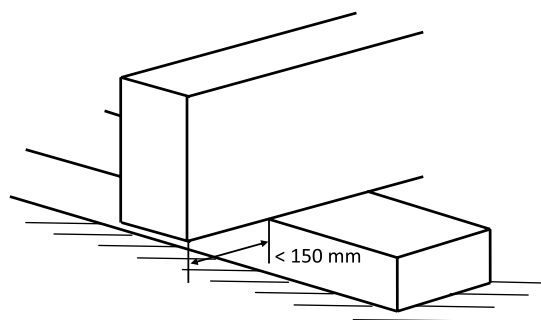

Fig. 5. Beam on continuous support

Table 1. Adjustment Factors for Bearing

		ASTM D2555						
Bearing length (mm)		13	25	38	51	76	102	152
$k_c =$		1.75	1.38	1.25	1.19	1.13	1.10	1.0
		AS/NZS 3603 (1992)						
Bearing length (mm)		10	25	50	75	100	150	
$k_c =$		1.90	1.60	1.30	1.15	1.06	1.0	
		Sawn timber			Glued laminated			
EN 1995-1-1/A1:2008 type		k_c			k_c			
Local support		1			1			
Continuous support		$1.25(l + 2 * 30)/l$			$1.5(l + 2 * 30)/l$			
		with $l =$ loaded length						

approach, covering more load cases. Similarly, the bearing capacity results from a factor k_c times the loaded area times the standard compressive strength. The k_c factor is composed of two constituents. The first is an empirical factor of 1.25 and 1.5, accounting for solid and glued-laminated timber, respectively. The second is a ratio that incorporates the influence of fibers near the edges of the loaded area, contributing to bearing. The fibers that run close underneath the loaded area will be squeezed into an S shape when the deformation increases. Consequently, fibers that run close to the surface, but parallel to the loaded edges contribute hardly at all. The S-shaped fibers are assumed to contribute by the so-called rope or chain effect. This is accounted for by adding 30 mm to the loaded length parallel to the grain of the loaded area. If fibers are squeezed into the S shape on both edges, the total length of the loaded area parallel to the grain is measured as twice 30 mm (Table 1). This approach is based on empirical models by Madsen et al. (2000) and Blass and Görlacher (2004). For discrete or local supports, EN 1995-1-1/A1 (Eurocode 5) specifies $k_c = 1$. From Table 1, it is clear that k_c values used by the standards are very different.

Incompatible Test Results Made Compatible

For many years, researchers tried to develop models that account for the influences of geometry of the bearing beam and load configuration, but proposed only empirical models. Recently, Van der Put (2008) republished his stress-dispersion model (Van der Put 1988) on the basis of plastic theory using the equilibrium method. The equilibrium method always results in a safe approach. This model is much more flexible, reliable, and accurate than the empirical models so far, and possesses a greater applicability to cover situations in practice as shown by Leijten et al. (2009), who evaluated nearly 700 test results.

This model is the only realistic candidate to make incompatible test results compatible. If proved correct, it has the potential to become globally accepted by all future structural timber design codes, whereas the test standards for the determination of the compressive strength perpendicular do not necessarily need to be changed. The incompatible test results can be unified by deriving correction factors based partly on this theory.

The stress-dispersion theory takes the standardized compressive strength of a full-surface loaded specimen (EN 408) as a starting point. The bearing capacity is determined by the standard compressive strength multiplied with an adjustment factor, k_c , accounting for the bearing beam dimensions and loading configuration. The theoretical derivation is given in Van der Put (2008). The stress field distribution that has been chosen is the same as the one that follows from the slip-line theory. This is known from mechanics of solids, solved by the method of characteristics. The method assumes a dispersion of the bearing stresses, activating more materials depending on the level of deformation. To obtain a simplified solution, the first term of a power polynomial approximation appeared to suffice. If the loaded area covers the full width of the beam, the stresses disperse as shown in Fig. 6. In one deformation level, which assumes the onset of yielding and is valid for small deformations of approximately 3% for coniferous wood, the bearing stresses disperse at a 45° angle (1:1). In the other deformation, which is level for large 10% deformations, the slope of the dispersing stresses changes to 34° (1.5 : 1). The model uses the ratio of the parallel to grain length of the loaded area and the maximum or effective length of dispersion near the bottom support. The slope of dispersion beyond which bearing stress can be neglected was predicted by Madsen et al. (1982) and Hansen (2005) on the basis of

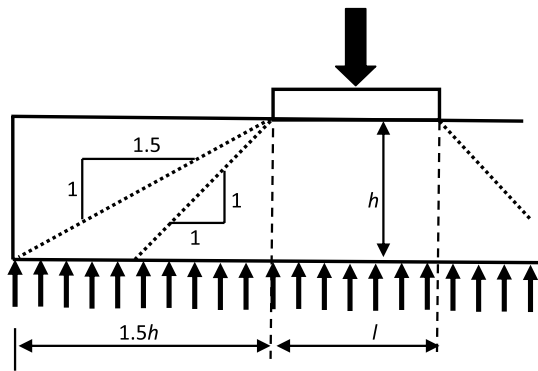

Fig. 6. Assumed dispersion of stresses for two load cases

FEM, and this agrees with the model prediction. The stress-dispersion model is formulated as:

$$\frac{F_d}{bl} = \sqrt{\frac{l_{ef}}{l}} f_{c,90} \quad (1)$$

For coniferous wood: $l_{ef} = h + 2(1.5h)$ for 10% deformation; $l_{ef} = h + 2(h)$ for 3–5% deformation; where F_d = failure load, in N; l = contact length of the applied load in grain direction, in mm; h = beam depth, in mm; b = width of the beam, in mm; l_{ef} = effective length at the support, in mm; and $f_{c,90}$ = reference compressive strength perpendicular to the grain (EN408), in N/mm^2 .

The stress dispersion assumes a loaded area over the full width of the beam. For situations in which the loaded area width is smaller than the beam width, the theory assumes the same dispersion in all directions if deformations are large enough. In that case, the square-root expression in Eq. (1) changes to effective bearing area divided by the loaded area Eq. (1). However, the dispersion in width direction could not be confirmed by tests as yet (Leijten 2009a). The depth-to-width ratio of the bearing beam, the so-called aspect ratio, should be limited to 4 to prevent premature failure mechanisms such as rolling shear (Basta 2005). A model with these capabilities may also be applied in reverse. For instance, when only test results are available for loading conditions as shown in Fig. 7, the model should be able to calculate backward to retrieve the standard compressive strength for each load case. To demonstrate the flexibility of the model to cover special bearing cases, Fig. 6 also shows the assumed stress dispersion for a situation in which the top and bottom loaded areas are different. This, however, assumes that both stress-dispersion areas are not too far apart.

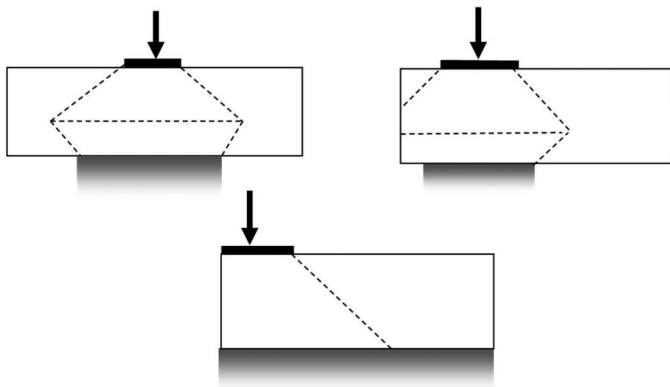

Fig. 7. Stress dispersion for special situation

Evaluation of Former Test Result

The aim of this evaluation was to demonstrate the capabilities of the model to relate incompatible test results of different load configurations and to show how they stem from just one hypothetical standard compressive strength. To check this hypothesis, tests on Australian Radiata pine reported by Leicester et al. (1998) are evaluated. They cover three load cases A, B, and C shown in Fig. 8. Leicester and coauthors were attempting to discover a suitable test method for structural timber (in-grade test method), as it was believed that the test results on small-size clear wood specimens were inadequate in reflecting the bearing strength accurately. Kiln-dried Radiata pine specimens were conditioned to a moisture content of 12.5% and were graded into three strength grades. The test specimen sizes were 35×90 mm and 35×190 mm, and the number of tests were $n = 300$ and 290, respectively. The total specimen length was six times the depth. The length of the steel plate for the load application was 90 mm for cases A and C; whereas for case B, plates were 45, 90, and 180 mm for the cases B1, B2, and B3, respectively. The deformations recorded were measured between the top and bearing plates. The load-deformation curves were not reported. Only the average bearing stress per test series at a number of discrete points on the load-deformation curve was reported. This includes the bearing stress using a 2-mm offset and the bearing stress at 5- and 10-mm deformation, as in Fig. 4. The specimens of each strength grade were equally represented in the load cases.

The problem encountered in comparing bearing stresses given at fixed deformations of 5 or 10 mm is that the strain for the smaller 90-mm-depth specimen is approximately twice as high as that of the 190-mm specimens. As no information is given about the load-deformation curves, it makes comparing two specimen sizes impossible. In Figs. 9 and 10, the compressive stress using the 2-mm-offset method and at 10 mm (11%) deformation is presented graphically for each load case, represented by the two left bars for

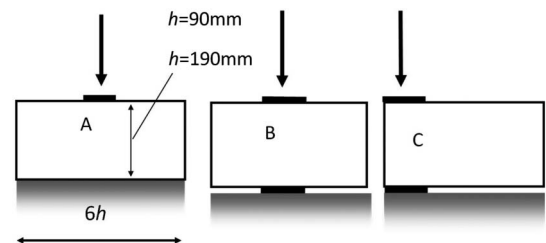

Fig. 8. Configurations A, B, and C

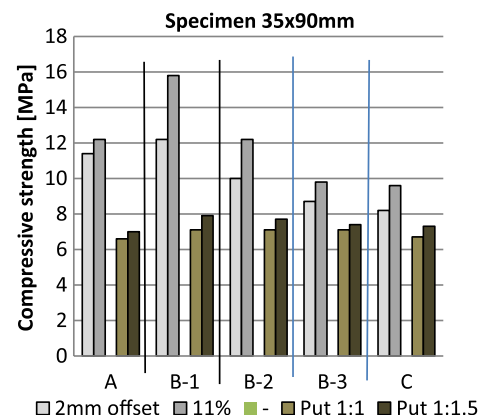

Fig. 9. Test by Leicester et al. (1998) and model results

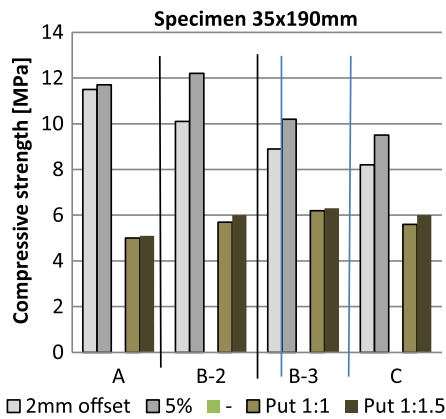

Fig. 10. Test by Leicester et al. (1998) and model results

the load cases A, B, and C. The right two bars of each load case represent the hypothetical standard strength determined with the model, assuming a stress dispersion of 1:1 and 1:1.5 for the 2-mm-offset method and the 10 mm (11%) deformation. The mean hypothetical standard compressive strength for all load cases A to C is 7.2 and 5.9 N/mm² for the 90- and 190-specimens with a variation of less than 5%. The model is able to bring down the differences despite the different load cases.

Franke and Quenneville (2010) studied the effect of different strength definitions using clear wood specimens of New Zealand Radiata pine with standard dimensions of 50 × 50 × 200 mm. They reported an average standard strength of 5.7 and 6.2 N/mm² using the 1% offset CEN method and the 2-mm-offset method (AS/NZS method). The values are close and lower than the hypothetical standard strength calculated. One cause, which cannot be ruled out, is the presence of knots in the structural size specimens. Research carried out in the framework of this study showed that knots have a strong positive effect on the compressive strength.

Additional Confirmation

There are still a number of issues that need to be resolved before the stress-dispersion model can be given full credit. Does the model perform well for other load cases, for instance, when the loaded area is smaller than the beam width and/or is not fully supported? The simple design code rules outlined previously do not consider all of these cases. For this reason, additional tests were performed on solid and glued-laminated Radiata pine of New Zealand. Tests by Leijten (2009a) were carried out at Auckland University, New Zealand considering a variety of load configurations and support conditions, some of which are shown in Fig. 11. The specimen width and depth were 240 × 45 mm and 270 × 90 mm for each of the solid and glued-laminated specimens. The specimens were conditioned to 20°C and 65% relative humidity (RH). The speed of testing was such that 3–5% strain was obtained in approximately 300 s.

The prediction ability of the bearing capacity using the structural design codes of NDS and AU/NZS and Eurocode 5, with appropriate k_c values presented in Table 1, is evaluated. The respective clauses require the respective standard compressive strength as input values.

For New Zealand Radiata pine, the standard compressive strength-values are taken from Franke and Quenneville (2010), who derived 11.1 N/mm² for the mean and 8.9 N/mm² as lower 5% value in accordance to the ASTM/AS/NZS method. Following

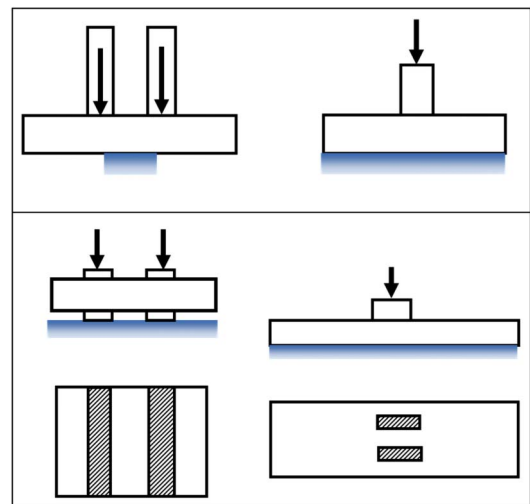

Fig. 11. Overview of tested load configurations

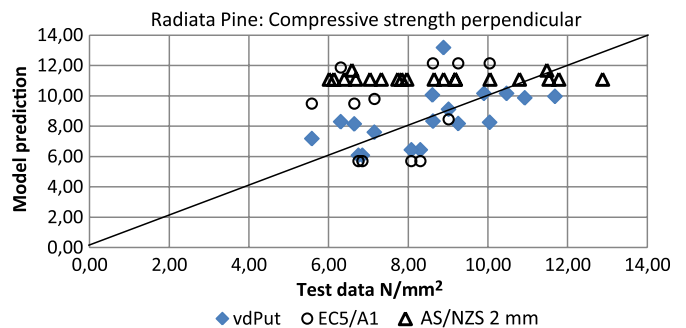

Fig. 12. Test series at 1% off versus model prediction

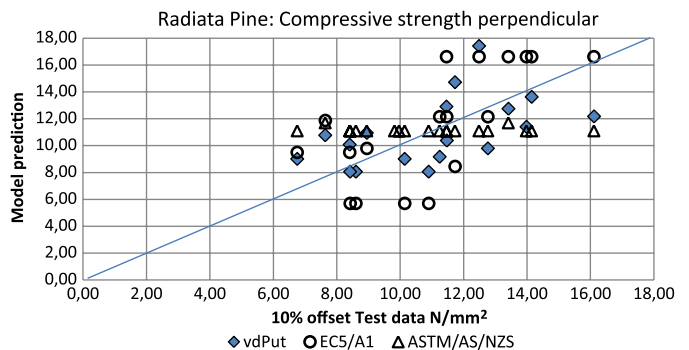

Fig. 13. Test data at 10% deformation versus model predictions

the CEN method, they reported 5.7 N/mm² for the standard mean compressive strength and 4.4 N/mm² as lower 5% value.

In the evaluation of the test results, there were cases in which the loaded area did not cover the total specimen width. This is shown in the bottom-right area of Fig. 11, in which an empirical reduction of the stress-dispersion sideways was applied, 1:10 for the small deformations and 1:1 at 10% deformation, to give the best fit. Previous investigations on Norway spruce showed the dispersion to be 1:0.4 and 1:0.7, respectively (Leijten 2009b). Figs. 12 and 13 show the mean compressive strength per test series versus the stress-dispersion model predictions. They also show the NDS and AUS/NZS design code predictions considering both the results at

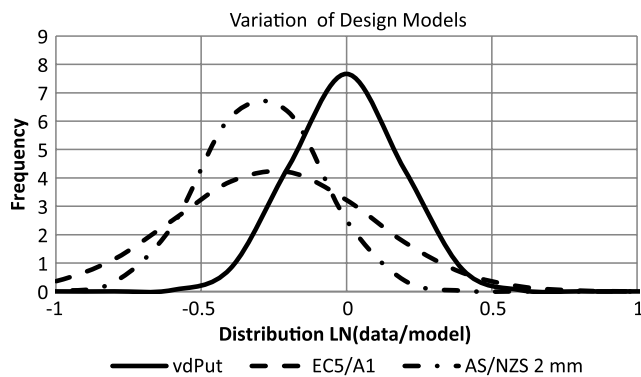

Fig. 14. Variability of model prediction for 1% offset

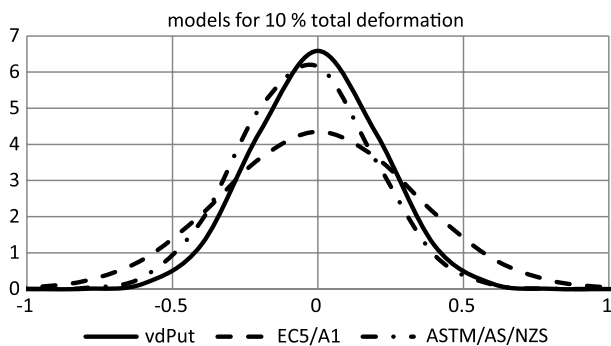

Fig. 15. Variability of model deformations at 10% deformation

1% offset (3–5% total deformation) and at 10% deformation, respectively. The high scatter of the NDS and AS/NZS structural-design-code predictions is not strange, because for most tested situations, $k_c = 1.0$ (Table 1) applies. For that reason, the predictions are represented by a horizontal row of dots. For the Eurocode 5, k_c values varied more; however, without much improvement to follow the trend. The variability of the prediction is shown by Figs. 14 and 15, in which a fitted log-normalized distribution is applied to each model prediction. These figures lead to the following conclusions:

For bearing-strength-capacity estimation at approximately 3% total deformation, the stress-dispersion model of Eq. (1) is the most accurate predictor with the least variability. The code provisions of both NDS, AU/NZS 6,303 and Eurocode 5 are not well suited to predict the bearing capacity. At 10% deformation, the stress-dispersion model is well suited too. In comparison, all the structural design codes are coarse and unreliable.

Outlook for Code Improvement

After noting the inability of current structural design codes to come even close in accurately predicting the bearing capacity, being coarse and inflexible compared with the stress-dispersion model, this paper discusses how to improve this situation. For the benefit of the timber designer, there are a number of options to improve the respective standards, but all depend on how far standard committees are willing to change.

First to be considered is the difference in the types of test specimens. Test piece A, Fig. 8, always produces the lowest strength values, compared with types B and C for any strength definition. This is demonstrated by using modification factors derived from the stress-dispersion model. This alters the results with test pieces B and C to type A (CEN) equivalent values. The model modification factors are 0.58 and 0.71 for B and C, respectively. These modification factors can also be derived experimentally. For Radiate pine, Franke and Quenneville (2011) reported 0.61 and 0.67 on the basis of a total of 150 tests (Column 3, Table 2). The difference between the experimental method and the stress-dispersion method is small, being approximately 5%. This indicates that by having a 1% offset strength definition, the experimentally determined strength of piece C, for example, can be transformed into the CEN specimen value by multiplying by 0.67.

The effect of differences in strength definition is resolved experimentally. To change the test results of the ISO and AS/NZS 2-mm offset to the CEN 1% offset strength definition, reduction, factors of 0.92, 0.84, and 0.86 apply to test pieces A, B, and C, as in Franke and Quenneville (2011) (Column 4, Table 2). To transform the ISO/AS/NZS compression test values directly to equivalent type A (CEN) values, factors in Column 5 can be used, which follow from multiplying Column 3 and 4 values.

The mean strength values obtained for the ASTM D143 test piece B, with the 1 mm (0.04 in.) offset strength definition, can be transformed to the 1% offset definition by applying a factor of 0.66 on the basis of the evaluation of tests by Ranta-Manus (2007), who reported on 200 tests of spruce pine (Column 7, Table 2). Applying the ASTM D143 strength definition of 0.01-in. deformation to test piece A suggests that the test results of Hansen (2005) for spruce result in a factor of 0.90. This indicates that horizontally one finds the change in strength definition, whereas vertically the change is in the test specimen. In Column 8, the modification factor is given to transform the ASTM standard values to type A (CEN) equivalent, which results from multiplication of Columns 3 and 7. To summarize, Columns 5 and 8 contain modification factors to transform the standard test results of ISO 13910, AS/NZS 4063, and ASTM D143 to equivalent CEN values. With these transformation factors in mind, one is able to apply the stress-dispersion model in various design standards.

Table 2. Modification Factors on the Basis of Mean Values

Strength definition	Number of tests n^a	Transformation AS/NZS to CEN		Transformation ASTM to CEN	Number of tests n^b	Transformation ASTM to CEN	
		CEN	ISO/NZ			ASTM	ASTM
		1% offset	2-mm offset			0.04-in. offset	
A	90	1.00	0.92	0.92	30	0.9	0.9
B	30	0.61	0.84	0.51	200	0.66	0.4
C	30	0.67	0.86	0.58	—	—	—

^a n Radiata pine; Franke and Quenneville (2011).

^b n Spruce; Hansen (2005) and Ranta-Manus (2007).

This leaves standard committees with two options. The first option is to modify the standard strength values with Table 2 modification factors and to introduce the stress-dispersion model in the structural design code. The second option is to move Table 2 modification factors to the structural design code and combine them with the k_c factor of the model. For the latter option, only the structural-design-code provisions need to be changed.

Conclusions

The model presented enables accurate prediction of the compressive-strength capacity. This model, in combination with the experimental analyses of Franke and Quenneville (2011), resolves the differences between the standard test methods of ASTM D143, ISO 13910, and AS/NZS 4063 for which modification factors are derived. The inability of the major structural timber design code like EN1995-1-1, NDS, and AS/NZS 3603 to predict the compressive-strength capacity for continuous supported beams accurately is demonstrated. It is argued that with the adoption of the modification factors derived, in combination with the model presented, the bearing-strength capacity can be predicted much more accurately than ever before.

Acknowledgments

The first writer wishes to express his thanks to staff members and laboratory assistants of the Civil Engineering Dept. of Auckland University, New Zealand, who cooperated by carrying out the research during the 3-month sabbatical in that country. In addition, the first writer is grateful to the European Cooperation in Science and Technology (COST) Action E55, which provided the financial support given to this short scientific mission, and to Mary and Raymond Wood in England who verified the use of the English language.

References

ASTM. (2008). "Standard methods of testing small clear specimens of timber." *Designation D198-09*, ASTM, West Conshohocken, PA.

Basta, C. T. (2005). "Characterizing perpendicular-to-grain compression in wood construction." M.S. thesis, Oregon State Univ., Corvallis, OR.

Blass, H. J., and Görlacher, R. (2004). "Compression perpendicular to the grain." *Proc., 8th World Conf. on Timber Engineering*, Vol. 2, VVT, Espoo, Finland, 435–440.

Bodig, J., and Jayne, B. A. (1982). *Mechanics of wood and wood composites*, Van Nostrand Reinhold, New York.

European Committee for Standardization (CEN). (2003). "Structural timber

and glued laminated timber—determination of some physical and mechanical properties." *CEN-EN408*, Rue de Stassart 36, B-1050 Brussels, Belgium.

European Committee for Standardization (CEN). (2008). "Eurocode 5 design of timber structures, general, common rules and rules for buildings." *EN1995-1-1:2004/A1:2008E*, Rue de Stassart 36, B-1050 Brussels, Belgium.

Franke, S., and Quenneville, P. (2011). "Compression strength perpendicular to the grain of New Zealand Radiata pine lumber." *Aust. J. Struct. Eng.*, 12(1), 23–34.

Hansen, F. (2005). "Konstruktionstræ trykbelastet vinkelret på fiber retning." *Forsøgsrapport, DET Teknisk-Naturvidenskabelige Fakultet*, Aalborg Univ., Aalborg, Denmark.

International Standard Organization (ISO) 13910. (2005). "Structural timber—characteristic values of strength graded timber, sampling full size testing and evaluation." *CH-1211*, Geneva.

Leicester, R. H., Fordham, H., and Breitingner, H. (1998). "Bearing strength of timber beams." *Proc., CIB-W18-Timber Structures*, Univ. of Karlsruhe, Karlsruhe, Germany, paper 31-6-5.

Leijten, A. J. M. (2009a). "Withdrawal capacity of washers in bolted timber connections." *Wood Mater. Sci. Eng.*, 4(3–4), 131–139.

Leijten, A. J. M. (2009b). "Unification of bearing strength of timber in test and structural design standards, *COST-STSM-E55-04961*, Brussels, Belgium.

Leijten, A. J. M., Larsen, H. J., and van der Put, T. C. A. M. (2009). "Structural design for compression strength perpendicular to the grain of timber beams." *Constr. Build. Mater.*, 24(3), 252–257.

Madsen, B., Hooley, R. F., and Hall, C. P. (1982). "A design method for bearing stresses in wood." *Can. J. Civ. Eng.*, 9(2), 338–349.

Madsen, B., Leijten, A. J. M., Gehri, E., Mischler, A., and Jorissen, A. J. M. (2000). "Behaviour of timber connections, Timber Engineering, North Vancouver, Canada, 139–162.

National Design Specification (NDS). (2005). *National design specification for wood construction*, ANSI/American Forest and Paper Association, Washington, DC.

Poussa, M., Tukiainen, P., and Ranta-Manus, A. (2007). "Experimental study of compression and shear strength of spruce timber." *Proc., CIB-W18-Timber Structures*, Univ. of Karlsruhe, Karlsruhe, Germany, paper 40-6-2.

Ranta-Manus, A. (2007). *Strength of Finnish grown timber*, VTT, Espoo, Finland.

Standards New Zealand (AS/NZS) 3603. (1992). "Timber structures standard." *Private bag 2439*, Wellington, New Zealand.

Standards Australia. (1992). "Timber-stress graded—in grade strength and stiffness evaluation." *AS/NZS 4063* Sydney, NSW, Australia.

Van der Put, T. A. C. M. (1988). "Explanation of the embedding strength of particle board." *Stevin Research Rep. 25-88-63/09-HSC6*, Faculty of Civil Engineering, TU Delft, Delft, Netherlands.

Van der Put, T. A. C. M. (2008). "Derivation of the bearing strength perpendicular to the grain of locally loaded timber blocks." *Holz Roh Werkst.*, 66(6), 409–417.