

Article

"Quaternary Stratigraphy and History, Quesnel, British Columbia"

John J. Clague

Géographie physique et Quaternaire, vol. 42, n° 3, 1988, p. 279-288.

Pour citer cet article, utiliser l'information suivante :

URI: <http://id.erudit.org/iderudit/032736ar>

DOI: 10.7202/032736ar

Note : les règles d'écriture des références bibliographiques peuvent varier selon les différents domaines du savoir.

Ce document est protégé par la loi sur le droit d'auteur. L'utilisation des services d'Érudit (y compris la reproduction) est assujettie à sa politique d'utilisation que vous pouvez consulter à l'URI <https://apropos.erudit.org/fr/usagers/politique-dutilisation/>

Érudit est un consortium interuniversitaire sans but lucratif composé de l'Université de Montréal, l'Université Laval et l'Université du Québec à Montréal. Il a pour mission la promotion et la valorisation de la recherche. Érudit offre des services d'édition numérique de documents scientifiques depuis 1998.

Pour communiquer avec les responsables d'Érudit : info@erudit.org

QUATERNARY STRATIGRAPHY AND HISTORY, QUESNEL, BRITISH COLUMBIA

John J. CLAGUE, Terrain Sciences Division, Geological Survey of Canada, 100 West Pender Street, Vancouver, British Columbia V6B 1R8.

ABSTRACT Thick Quaternary sediments at Quesnel, British Columbia, provide a record of the late Quaternary history of an area near the centre of the former Cordilleran Ice Sheet. These sediments, in part, fill stream valleys that were cut sometime prior to the Late Wisconsinan Fraser Glaciation. Of special note are (1) fluvial or glaciofluvial sand and gravel deposited by aggrading streams, perhaps in part during early Fraser time; (2) thick glaciolacustrine mud, sand, and diamicton laid down later as glaciers advanced across central British Columbia; and (3) glaciolacustrine sediments similar to (2), but deposited in an ice-dammed lake at the end of the Fraser Glaciation. The stratigraphy is punctuated by colluvial deposits that are products of landslides from valley walls at various times during the late Quaternary; this process continues to the present. During the Fraser Glaciation, glaciers from the Coast and Cariboo Mountains coalesced and flowed north over central British Columbia. Fraser Glaciation advance sediments and older Pleistocene deposits were partially removed by this ice sheet and the eroded remnants mantled with till. At the end of this glaciation, the Cordilleran Ice Sheet downwasted and receded southward along an irregular front across the study area. Large amounts of sediment were deposited in glacial lakes dammed by the southward-retreating ice. With complete deglaciation of the interior, glacial lakes drained and the present drainage system was established. At first, valleys were partially aggraded with sand and gravel, but later, streams dissected valley fills to produce a series of terraces at successively lower levels.

RÉSUMÉ *Stratigraphie et évolution du Quaternaire à Quesnel, Colombie-Britannique.* À Quesnel, l'épaisse accumulation de dépôts quaternaires permet de reconstituer l'histoire du Quaternaire d'une région située près du centre de l'Inlandsis de la Cordillère. Ces sédiments comblent en partie les fonds de vallées qui avaient été entaillées avant la Glaciation de Fraser survenue au Wisconsinien supérieur. On note: 1) que les sables et graviers fluviaux et fluvioglaciers ont été déposés par des cours d'eau alluvionnants, en partie probablement au début de la Glaciation de Fraser; 2) que d'épaisses accumulations de boue, sable et diamicton glaciolacustres ont été mises en place plus tard lorsque les glaciers en progression traversaient le centre de la Colombie-Britannique; et 3) que des sédiments glaciolacustres (semblables à ceux donnés en 2), ont été déposés dans un lac de barrage glaciaire à la fin de la Glaciation de Fraser. La stratigraphie est ici et là parsemée de colluvions qui proviennent de glissements de terrain survenus dans les versants de vallées à différents moments au cours de la fin du Quaternaire; les glissements se poursuivent encore actuellement. Au cours de la Glaciation de Fraser, les glaciers de la chaîne Côtière et des monts Caribou se sont fusionnés pour s'écouler vers le nord du centre de la Colombie-Britannique. Les sédiments de l'avancée glaciaire de Fraser et les dépôts pléistocènes plus anciens ont en partie été emportés par l'Inlandsis et les débris érodés ont formé une couverture avec le till. À la fin de la Glaciation, l'Inlandsis de la Cordillère en voie de fonte s'est retiré vers le sud suivant un front de marge irrégulière qui traversait la région à l'étude. Une grande quantité de sédiments a été déposée dans des lacs glaciaires endigués par le glacier en retrait vers le sud. La déglaciation de la région intérieure étant terminée, les eaux des lacs glaciaires ont été évacuées et le réseau actuel de drainage s'est constitué.

ZUSAMMENFASSUNG *Stratigraphie und Entwicklung im Quaternär bei Quesnel, British Columbia.* Dicke Quaternär-Sedimente bei Quesnel, British Columbia, dokumentieren die späte Quaternär-Geschichte eines Gebiets nahe dem Zentrum der früheren Kordilleren Eis-Decke. Diese Sedimente füllen z.T. Stromtäler, die etwas vor der späten Wisconsinan-Fraser-Vereisung eingeschnitten wurden. Besonders zu verzeichnen ist (1) dass Fluss- oder glazialer Fluss-Sand und Kies durch aufschüttende Flüsse abgelagert wurde, vielleicht z.T. während der frühen Fraser-Vereisung; (2) dass dicker Schlamm, Sand und Diamikton von glazialen Seen später abgelagert wurden, als die Gletscher durch das Zentrum von British Columbia vorrückten; und (3) dass glaziale See-Sedimente ähnlichen von (2) am Ende der Fraser-Vereisung in einem See mit einem Eis-Damm abgelagert wurden. Die Stratigraphie zeigt hier und da kolluviale Ablagerungen, die durch Erdbeben von den Talwänden zu verschiedenen Zeiten während des späten Quaternärs entstanden sind; diese Erdbeben finden noch heute statt. Während der Fraser-Vereisung vereinigten sich Gletscher von der Küste und den Cariboo-Bergen und flossen nördlich über das Zentrum von British Columbia. Sedimente des glazialen Vorstosses von Fraser und ältere Ablagerungen aus dem Pleistozän wurden z.T. durch diese Eisdecke fortgetragen und die erodierten Reste überzogen sich mit Till. Am Ende dieser Vereisung schmolz die Kordilleren Eis-Decke und zog sich südwärts zurück entlang einer unregelmässigen Front durch das studierte Gebiet. Grosse Sedimentmassen wurden in glazialen Seen abgelagert, die durch das südwärts zurückweichende Eis angestaut wurden. Als das innere Gebiet vollkommener enteist war, wurde das Wasser der glazialen Seen abgeleitet und das gegenwärtige Drainage-System etablierte sich. Zuerst waren die Täler teilweise mit Sand und Kies aufgeschüttet aber später zerschnitten Flüsse die Talauffüllungen und bildeten eine Serie von Terrassen mit sukzessiv niedrigerem Niveau.

INTRODUCTION

Several times during the Pleistocene, British Columbia was covered by an interconnected mass of valley and piedmont glaciers and mountain ice sheets, collectively known as the Cordilleran Ice Sheet (Flint, 1971). In central British Columbia, glaciers flowed eastward from the Coast Mountains and westward from the Cariboo Mountains to merge over the Interior Plateau (Fulton, 1971; Tipper, 1971a, b; Clague, 1981). During most glaciations, the major mountain systems remained the principal source areas of glaciers, and ice flow was controlled by topography. However, occasionally, ice on the plateau thickened to form ice domes, with radial flow away from their centres.

Quesnel (Fig. 1) is located near the centre of the former Cordilleran Ice Sheet and thus is strategically located to provide information on the pattern of growth and decay of this glacier complex during the Pleistocene. It is perhaps surprising then that relatively little stratigraphic and sedimentologic work has been done in this area, in spite of the good exposure of Quaternary sediments along Fraser River and some of its tributaries. Previous work at Quesnel has been limited largely to studies of surface sediments and landforms (Leaming and Armstrong, 1969; Tipper, 1971a, b). Although providing valuable information on the pattern of ice flow and glacier decay at the close of the last (Fraser = Late Wisconsinan) glaciation, these studies have contributed little to an understanding of earlier Quaternary events recorded in subsurface deposits. Berger *et al.* (1987), Eyles (1987), Eyles and Clague (1987), and Clague *et al.* (1987) have recently described some subsurface sediments at Quesnel, but a comprehensive stratigraphic framework has previously been lacking.

This report is an attempt to fill this void by describing in detail the Quaternary succession of the Quesnel area. The sediments described in this paper are exposed in the valley of Fraser River and are remnants of a complex fill that has been dissected during the Holocene, producing bluffs that reveal the internal geometry of the Quaternary succession. The Quesnel area was chosen for detailed study because the exposure is excellent and the sections easily accessible. In addition, the Quaternary succession is representative of that found in other parts of central British Columbia.

SETTING

Fraser valley in the study area is 2-6 km wide, and its floor 150-300 m below the surface of the adjacent Interior Plateau. Quesnel and Cottonwood rivers are major tributaries to Fraser River in this area. This part of the Interior Plateau is underlain by sedimentary and volcanic rocks ranging from Pennsylvanian to Miocene in age (Rouse and Mathews, 1979; Tipper *et al.*, 1979). A blanket of Pleistocene drift mantles much of the plateau; locally, thick Quaternary sediments fill buried valleys (Rouse and Mathews, 1979).

METHODS

Sections were logged between 1981 and 1986. Some of the best exposed and most representative of these are shown

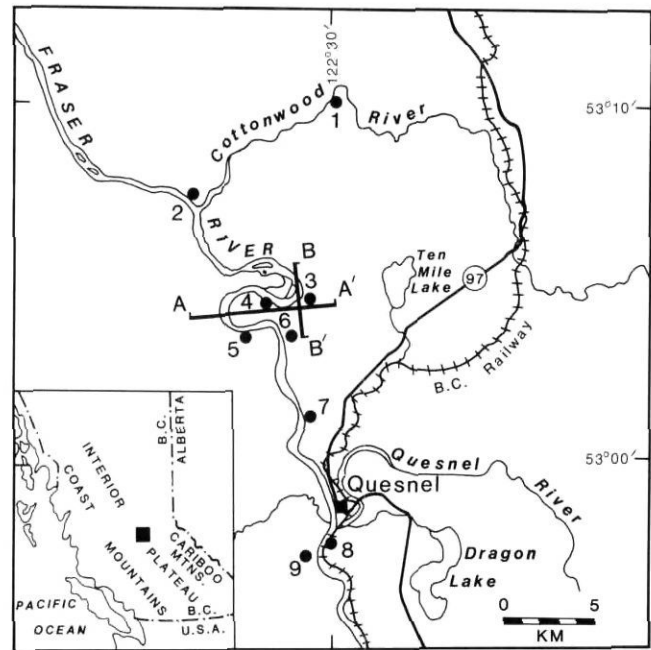

FIGURE 1. The study area showing locations of stratigraphic sections discussed in the paper.

Localisation des coupes stratigraphiques de la région étudiée.

in Figure 2. Units were characterized using field criteria, including texture, stratification and other sedimentary structures, colour, clast composition, and contact relationships. Each unit defined on the basis of these criteria represents a distinct sedimentary environment characteristic of part of late Quaternary time in the Quesnel area. Special efforts were made to determine contact relationships and facies variations within units.

Elevations were measured with an aneroid barometer, with corrections made for air-temperature variations. All altimeter readings were keyed to a topographic benchmark in Quesnel and are thought to be accurate to within ± 5 m.

Stream-flow directions for stratified sand and gravel units were determined by measuring orientations of imbricated clasts and trough and planar cross-beds. Glacier flow directions were determined, in part, by measuring the a-axis orientations of elongate clasts in till.

QUATERNARY STRATIGRAPHY

Units are designated informally to facilitate description and interpretation of the Quaternary succession (Table I).

Units 1-6: older till¹ and associated sand and gravel (Fig. 2, section 6). Although till deposited during the Fraser Glaciation is widespread at and near the surface throughout central British Columbia, there are few exposures of older tills. In the

1. "Till" is sediment deposited directly from glacier ice with little or no sorting by water. "Diamicton" is nonsorted or poorly sorted sediment containing a wide range of particle sizes. All tills in the study area are diamictons, but not all diamictons are of glacial origin.

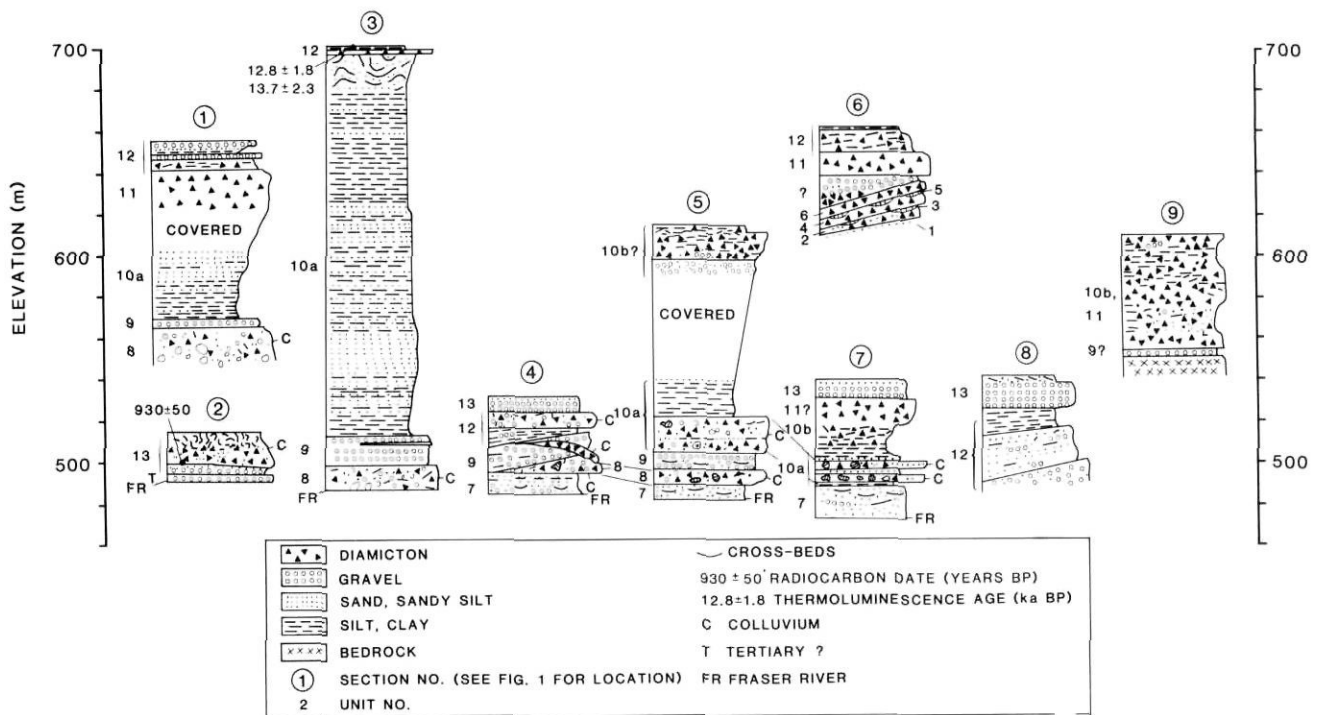

FIGURE 2. Stratigraphic sections. Unit numbers correspond to those in the text.

Coupes stratigraphiques. Les numéros des unités correspondent à ceux qui figurent dans le texte.

TABLE I
Stratigraphic summary

Unit	Genesis	Geologic event
13	Fluvial, colluvial	Postglacial
12	Glaciolacustrine	Fraser Glaciation (recessional phase)
11	Glacial	Fraser Glaciation (grounded ice phase)
10	Glaciolacustrine	Fraser Glaciation (advance phase)
9	Fluvial or glaciofluvial	Fraser Glaciation?
8	Colluvial	?
7	Fluvial-deltaic(?)	?
6	Glacial	?
5	Fluvial or glaciofluvial	?
4	Glacial	?
3	Fluvial or glaciofluvial	?
2	Glacial	?
1	Fluvial or glaciofluvial	?

Quesnel area, only one section exposing what are thought to be pre-Fraser tills was found. This section is located at the margin of a Pleistocene valley cut in Miocene sedimentary rocks (Fraser Bend Formation of Rouse and Mathews, 1979). Here, a varied succession of Fraser Glaciation deposits is underlain by at least three diamictons (units 2, 4, 6) separated by thin units of sand and gravel (units 1, 3, 5).

The sequence, from bottom to top, is as follows: (1) 1 m of poorly exposed sand and gravelly sand; (2) 1-5 m of dense, massive, stony silty sand containing sheared and folded sand lenses; (3) 0-0.5 m of crudely stratified sand, pebbly sand,

and sandy gravel with some silt and diamicton lenses; (4) 4-8 m of dense, matrix-supported diamicton with ca. 20% stones of a wide range of sizes and rock types; (5) 0-2 m of sand and gravel similar to unit 3; and (6) 3-5 m of diamicton similar to unit 4.

The three diamicton units contain fractures and wedges of sand derived from underlying stratified units. Fractures in unit 4, which are the most conspicuous, dip towards the north and northwest (Fig. 3). Elongate stones in units 4 and 6 have preferential northwest-southeast orientations (Fig. 3). The three diamictons are thought to be tills on the basis of their fabric, texture (*i.e.*, they are nonsorted deposits, with particles ranging from clay- to boulder-size), and the presence of striated and faceted stones and fractures.

The sand and gravel units between the diamictons have been oxidized to a yellow-brown colour, a result of either pedogenesis or the movement of oxygenated groundwater through the sediments. They may be outwash or ice-contact sediments deposited during periods of ice retreat, although a strictly nonglacial origin also is possible.

Unit 7: fluvial-deltaic(?) sand (Fig. 2, sections 4, 5, 7). Cross-bedded sand crops out at the base of several bluffs bordering Fraser River north of Quesnel. At section 7, for example, 17 m of fine to medium sand with small-scale cross-beds underlies a thick sequence of glaciolacustrine and glacial sediments. Here and at some other sites, unit 7 contains minor mud and fine gravel. At section 4, the unit, although dominantly sand, fines from pebble gravel at the base to interbedded silty sand and laminated mud at the top. Locally, unit 7 contains mud balls and clasts of Miocene coal and lignite.

Flow directions determined from cross-beds in unit 7 are varied. Westerly and northwesterly flow is indicated at sections 4 and 5; in contrast, variable, but generally easterly flow is suggested at section 7.

Unit 7 is sharply overlain by colluvium (unit 8) at sections 4 and 5 and by glaciolacustrine sediments (unit 10) at section

7. The stratigraphic relationship of unit 7 to the tills exposed at section 6 is not known. It is possible that unit 7 correlates with one of the sand and gravel units that separate these tills; alternatively it may predate the oldest till.

Unit 7 most likely accumulated on a braidplain, perhaps at the mouth of a river. The presence of laminated mud at some sites suggests that deposition, at times, occurred in ponded water (deltaic or fluvial backwater setting). Deposition took place in one or more deep valleys with floors about 250 m below the adjacent plateau surface (Fig. 4, 5).

Unit 8: colluvium (Fig. 2, sections 1, 3-5). A chaotic complex of orange-brown to red-brown, matrix-supported diamicton and poorly sorted, silty and sandy gravel is present near the base of several sections, stratigraphically above unit 7 sand. Unit 8 contains rounded to angular clasts of local Tertiary bedrock, till, and lacustrine sediments; some of these are several metres across. The sediments, in general, are massive to weakly stratified. Near section 5, however, the unit contains rare interbeds of moderately to well sorted sand and gravel.

Unit 8 overlies sand (unit 7) at sections 4 and 5; its base is below the level of Fraser River at section 3. The presence of till clasts in the colluvium indicates that a glaciation occurred prior to the deposition of the unit, but the relationship of this glaciation to those that produced units 2, 4, and 6 is not known.

Unit 8, like the sand that underlies it, is restricted to buried Quaternary valleys incised into the Interior Plateau (Fig. 5). It accumulated in response to the downslope movement (probably slumping and flow) of Tertiary rock debris and Pleistocene drift from the walls of these valleys. It is not clear whether these movements were rapid or slow, or whether there were one or several mass movement events at each site. However, because unit 8 is found over a large area, there appears to be some regional, rather than strictly local, control on landsliding. There has been landsliding in the Quesnel area at other times during the Quaternary (see following sections and Eyles and Clague, 1987), and this process continues on a large scale today.

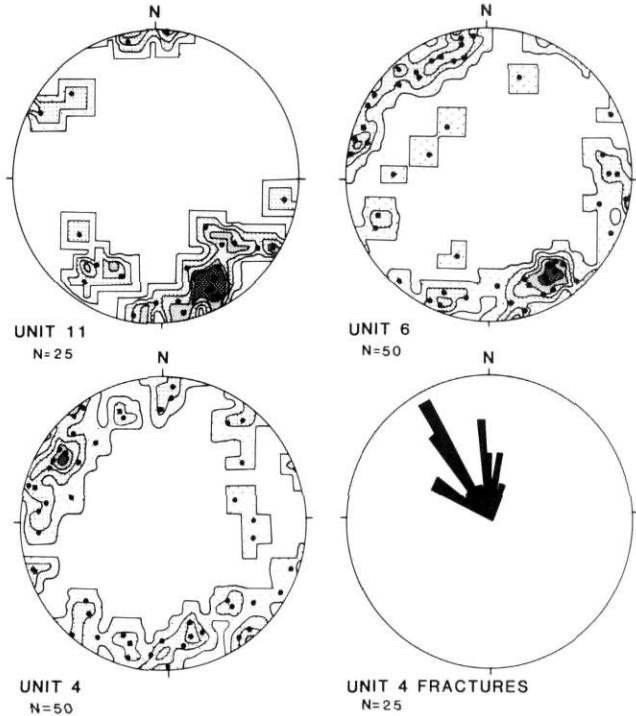

FIGURE 3. Fabric and fracture orientation data for tills at section 6. Till-fabric data are plotted on stereonet; contours approximately 1,3,5,7, and 9% per 1% area. Rose diagram at lower right shows dip directions of fractures in unit 4.

Données sur l'orientation des fractures et sur la structure des tills de la coupe n° 6. Les données sur la structure des tills sont rapportées en projection stéréographique; les courbes représentent approximativement 1,3,5,7 et 9% par 1% de superficie. Le diagramme circulaire, en bas à droite, montre la direction du pendage des fractures de l'unité n° 4.

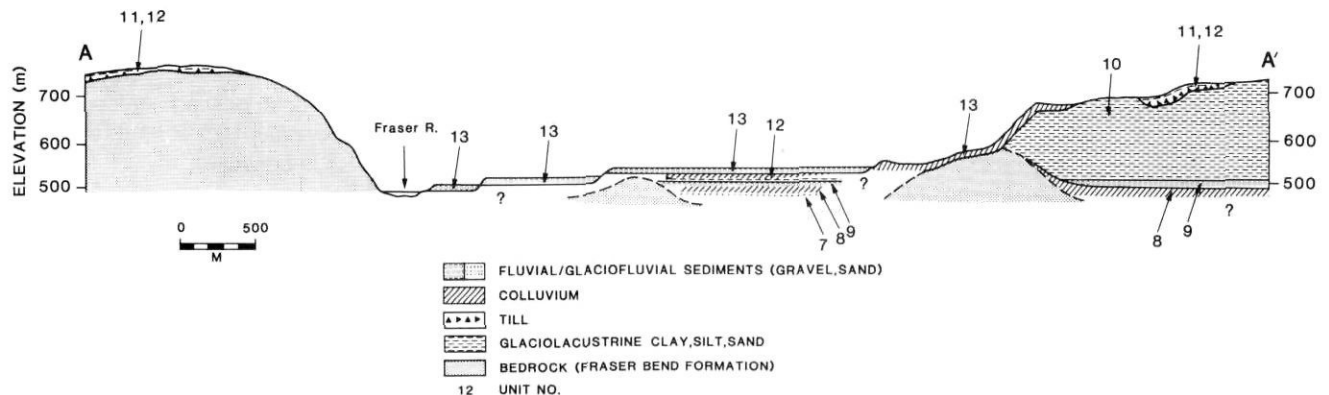

FIGURE 4. Generalized geologic cross-section across Fraser valley north of Quesnel (see Fig. 1 for location). The Tertiary-Quaternary contact is inferred. Note infilled Pleistocene valleys.

Coupe transversale stratigraphique schématisée de la vallée du Fraser, au nord de Quesnel (voir la fig. 1). Le contact entre le Tertiaire et le Quaternaire est hypothétique. À noter les vallées du Pléistocène remblayées.

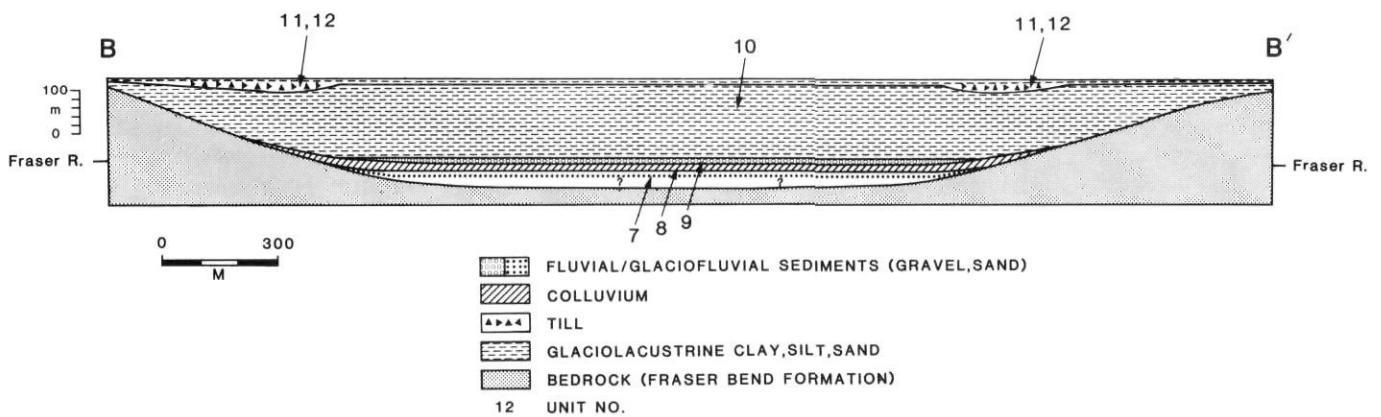

FIGURE 5. Cross-section through an infilled Pleistocene valley north of Quesnel (see Fig. 1 for location). The land surface depicted in this cross-section has been projected from an upland to the east to more clearly show the stratigraphic relationships of the valley fill. This approximates the land along the line of the profile prior to the erosion of Fraser valley.

Coupe transversale d'une vallée du Pléistocène remblayée, au nord de Quesnel (voir la fig. 1). Afin de mieux faire ressortir les relations stratigraphiques entre les matériaux de remblayage de la vallée, on a procédé à une projection vers l'est à partir du plateau. Le résultat correspond approximativement au profil de la vallée avant qu'elle soit érodée.

Unit 9: fluvial or glaciofluvial gravel (Fig. 2, sections 1, 3, 4, 5, 9?). The eroded upper surface of unit 8 is overlain by up to 20 m of well sorted, horizontally stratified gravel and minor sand. The gravel is clast-supported and has a sand matrix. Individual stones are well rounded and of pebble- and cobble-size. The orientation of small-scale cross-beds and imbrication indicates that the gravel was deposited by south- to southwest-flowing streams.

silt, sand, and diamicton overlies units 7-9 (Fig. 6). At section 3, this sequence is 180 m thick and consists entirely of interbedded very fine sand, silt, and laminated mud (unit 10a) deposited in a prodeltaic environment. Here, the sediments conformably overlie unit 9 and completely fill a Pleistocene valley, possibly that of ancestral Fraser River (Fig. 5).

At section 3, a thin bed of diamicton occurs within unit 9 gravel. At section 4, a thick wedge of blocky diamicton cuts down through unit 9 into underlying sediments. These observations indicate that debris flows and other types of landslides occurred in valleys in the study area while unit 9 was accumulating.

Thick tabular beds of diamicton deposited by subaqueous debris flows dominate the lower part of unit 10 at sections 5 and 7 (Eyles and Clague, 1987). Some of these beds can be traced as discrete layers for up to 3 km from their sources on the flanks of preexisting topographic highs; they become thinner and the included clasts smaller with increasing distance from these source areas. The lowest of the diamicton beds consists largely of Tertiary rock debris, whereas higher beds contain a wider variety of clasts, some of which are striated. Laminated mud, silt, and sand separate the diamictic flow members.

Although it is clear that this unit was deposited by one or more aggrading streams, it is not known whether the sediment is a nonglacial fluvial deposit or outwash deposited during a period of glacier advance (see Inferred Quaternary History).

The upper part of unit 10 at section 7 consists mainly of mud which is laminated and nonstony at the base (10a), but massive and stony at the top (10b). Many of the stones in

Unit 10: glaciolacustrine mud, sand, and diamicton (Fig. 2, sections 1, 3, 5, 7, 9). A thick sequence of interbedded mud,



FIGURE 6. Glaciolacustrine sediments (unit 10a) at section 3. These sediments fill a Pleistocene valley at this site (see Fig. 5) and consist of laminated mud, silt, and sand.

Les sédiments glaciolacustres (unité 10a) de la coupe n° 3. Ces sédiments, composés de boue, de silt et de sable laminés, comblent une vallée formée au Pléistocène à cet endroit (voir la fig. 5).

unit 10b are striated. There is no obvious break within the sequence; rather the change from nonstony to stony sediments appears to be gradational.

Thick stony glaciolacustrine sediments at section 9 are tentatively assigned to unit 10b on the basis of stratigraphic position and elevation. They comprise interstratified diamicton, massive to weakly stratified stony mud, and minor sand and gravel; many of the stones in the diamictic and muddy parts of the sequence are striated. These sediments were deposited in close association with ice, perhaps beneath a floating ice margin by rain-out processes or sediment gravity flows. It is possible that some of the massive diamicton layers at this site are grounded-ice deposits.

In many places, the uppermost sediments of unit 10 are deformed. Deformation is most conspicuous at section 3 where silt and sand up to 10-20 m below the top of the unit are intensely sheared and folded; original stratification in this zone has been largely destroyed, possibly through liquefaction under pressure. This deformation is thought to be a result of glacier overriding or of landsliding prior to such overriding.

Unit 11: basal till (Fig. 2, sections 1, 6, 7?, 9?). Unit 10 and older sediments were overridden and, in many places, deeply scoured by the Cordilleran Ice Sheet during the Fraser Glaciation. The erosion surface developed on these deposits is locally overlain by unit 11 till, which is a massive to weakly stratified, matrix-supported diamicton with abundant faceted striated stones. In practice, it is difficult to distinguish this till from underlying and overlying glaciolacustrine diamictons (units 10b, 12). However, the latter commonly have lower stone contents than the former (<10% vs. 15-30%) and are better stratified.

At section 6, unit 11 till overlies stratified, clast-supported gravel and sand. These stratified sediments are either ice-contact deposits or ice-proximal outwash, and may have accumulated in the same lake as the mud and sand of unit 10.

Some gravel beds dip to the northwest, suggesting that meltstreams from advancing glaciers flowed in this direction.

Basal till is generally thin and discontinuous in valleys in central British Columbia, including Fraser valley. In contrast, a thicker, more continuous blanket of till mantles much of the Interior Plateau outside of these valleys (Leaming and Armstrong, 1969; Tipper, 1971a, b).

Unit 12: glaciolacustrine complex (Fig. 2, sections 1, 3, 4, 6, 8). A varied suite of glaciolacustrine sediments overlies unit 11 till and older lake deposits. These sediments display marked lateral and vertical facies changes, due in part to deposition close to, and locally in contact with, glacier ice.

At many sites, the sediments at the bottom of the unit are gravel and diamicton deposited during initial deglaciation, whereas those at the top of the unit are clay and silt deposited after the area was completely ice-free. Examples of this are seen at sections 3, 6, and 8. At section 3, 1-3 m of glaciolacustrine (?) diamicton unconformably overlies highly deformed sediments of unit 10 (Fig. 7). The diamicton is overlain by 1-3 m of laminated silt. At section 6, till is overlain by 11 m of crudely stratified glaciolacustrine diamicton which, in turn, is capped by up to 2 m of rhythmically laminated clay and silt. At section 8, poorly sorted, ice-contact gravel is conformably overlain by interbedded sand, gravelly sand, and minor gravel. These sediments, in turn, are overlain by rippled, very fine sand and silt. Sedimentary structures indicate that this succession was deposited in a lake from meltstreams flowing north.

There is evidence for landsliding during this period of glaciolacustrine deposition. At section 4, the upper part of unit 12 is a chaotic mixture of diamicton and deformed sand and gravel containing abundant clasts of older Quaternary sediments and Tertiary rock. These sediments may have been deposited by subaqueous debris flows from adjacent valley walls or dead ice.

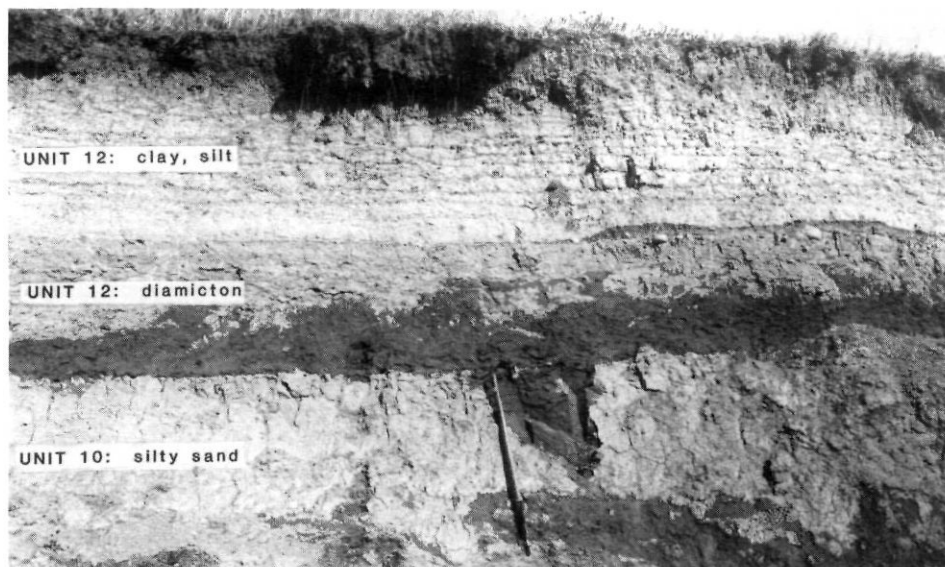

FIGURE 7. Units 10 and 12 at section 3. Highly deformed silty sand (unit 10) is sharply and unconformably overlain by diamicton and rhythmically silt and clay (unit 12). The diamicton probably was deposited in a lake near a glacier margin. The rhythmically bedded sediments accumulated in the same lake, but much farther from the ice front. The ice axe is 1 m long.

Les unités 10 et 12 de la coupe n° 3. Le sable silteux fortement remanié de l'unité 10 est recouvert en discordance par un diamicton puis de l'argile et du silt à stratification rythmique (unité 12). Le diamicton a probablement été déposé dans un lac près de la marge glaciaire. Les sédiments à stratification rythmique se sont accumulés dans le même lac, mais beaucoup plus loin du front glaciaire. Le piolet mesure 1 m.

Unit 12 accumulated in a large lake impounded by a southward-retreating lobe of the Cordilleran Ice Sheet at the end of the Fraser Glaciation (see Inferred Quaternary History). The presence of these sediments down to Fraser River level at section 8 and to near this level at section 4 (Fig. 2, 4) shows that a valley existed in this area at the end of the Fraser Glaciation. The present valley of Fraser River, thus, is not entirely a product of fluvial erosion during the Holocene.

Unit 13: fluvial gravel and sand, colluvium (Fig. 2, sections 1, 2, 4, 7, 8). Holocene fluvial gravel and sand overlie older Quaternary deposits along Fraser River and its tributaries. These deposits typically are 5-15 m thick and underlie a series of terraces extending to about 70 m above present base level. Similar deposits also form the floodplains and channels of present-day streams. Terraces developed as streams incised valley fills during the Holocene. Orientations of cross-beds and imbrication indicate that these streams flowed in the same direction as today.

In some places, tabular bodies of diamicton, produced by landslides, are interstratified with or overlie unit 13 gravel (e.g., section 2). Landslides have continued to occur up to the present, with activity concentrated on steep slopes bordering Fraser, Quesnel, and Cottonwood rivers. Section 3 in Fraser valley is located within a very large and active landslide complex involving units 10 and 12 (Evans, 1982).

INFERRED QUATERNARY HISTORY

Till units 2, 4, and 6 underlie Fraser Glaciation drift and thus were deposited during one or more glaciations prior to the lengthy Olympia Nonglacial Interval which began sometime before 59 ka BP (Clague, 1981). The possible presence of paleosols in sand and gravel units between these tills suggests that more than one pre-Late Wisconsinan glaciation is recorded. However, this conclusion must be considered provisional until additional work is done on the oxidized sediments at this locality. A northwesterly or southeasterly direction of glacier flow is deduced for units 4 and 6 from till-fabric data and fracture measurements (Fig. 3); northwesterly flow is more likely since ice travelled in this direction during the Fraser Glaciation (Tipper, 1971a, b).

Unit 7 (fluvial-deltaic? sand) was deposited by streams flowing in one or more valleys that were at least as deep as present-day Fraser valley. Unit 7 paleocurrent data suggest that the stream pattern at that time may have been different from the present (i.e., westerly and northwesterly paleoflow at section 5, adjacent to south- and east-flowing Fraser River). Unit 7 records a period of fluvial aggradation predating the Fraser Glaciation. The cause of this aggradation is unknown, although landsliding and glaciation are the two most likely possibilities.

The next event recorded in the stratigraphic succession is landsliding. Tertiary bedrock and Pleistocene drift slumped and flowed from valley walls onto adjacent gentler slopes and floodplains. The landslide debris (unit 8) buried unit 7 sand on valley floors. It is not known whether or not these two units differ substantially in age.

Unit 8 landslide debris was eroded (probably by streams) and then covered by another, mainly gravelly fluvial unit (no. 9). Unit 9 probably was deposited in the same type of sedimentary environment as unit 7, although energy levels were higher and the direction of flow different (south to southwest). As in the case of unit 7, aggradation may have occurred in response to landsliding or glaciation. The presence of tabular bodies of diamicton in unit 9 shows that landslides did occur during deposition of the unit. However, a glacial control on aggradation also is possible, because unit 9 is conformably overlain by thick glaciolacustrine sediments (unit 10).

Deposition of unit 9 ceased when valleys in the Quesnel area were inundated by the rising waters of a lake. Although its areal extent is unknown, this lake was at least 180 m deep, and it persisted long enough for valleys in the study area to become completely infilled with sediment. Ponding may have destabilized slopes, producing slumps and subaqueous debris flows (sections 5 and 7). The most likely cause of this ponding was blockage of the regional drainage by advancing glaciers during the Fraser Glaciation. An alternative explanation, which is less likely in view of the depth and duration of the lake, is that drainage was blocked by one or more large landslides.

Unit 10a glaciolacustrine sediments lack ice-rafted debris, thus there is no direct evidence for the presence of glaciers at Quesnel during their deposition. Unit 10b, however, contains large amounts of coarse ice-rafted debris and clearly was deposited close to an ice margin, probably shortly before the area was overridden during the Fraser Glaciation.

Fluvial (or glaciofluvial) sediments of unit 9 and glaciolacustrine sediments of unit 10 lack organic matter, thus it has not been possible to date them directly. They are provisionally assigned a Late Wisconsinan age on the basis of their close association with overlying Fraser Glaciation till (unit 11).

Drumlins, drumlinoid ridges, flutings, and glacial striations provide a record of the pattern of ice flow in central British Columbia at the time of deposition of unit 11 till (Fig. 8). This is supplemented by limited fabric data from unit 11 (Fig. 3). They show that ice from the Coast and Cariboo Mountains coalesced over the central interior during the Fraser Glaciation. This ice flowed in a generally northerly direction from an ice divide at about 52°N latitude (Prest *et al.*, 1968; Tipper, 1971a, b). In places, the ice deeply eroded the terrain over which it flowed.

Climatic amelioration at the end of the Fraser Glaciation destabilized the Cordilleran Ice Sheet. Equilibrium line rose above the surface of the ice sheet in the interior, causing it to downwaste and retreat along an irregular front. In a general sense, ice retreated from north to south in central British Columbia. Locally, however, the pattern of deglaciation was far more complex because the ice sheet separated into valley tongues and irregular masses of dead ice that decayed in response to local conditions (Tipper, 1971a, b).

As the ice front retreated southward, one or more glacial lakes developed in valleys and on the adjacent plateau surface in central British Columbia. Deglaciation was well advanced when a large lake with a surface elevation of about 800 m

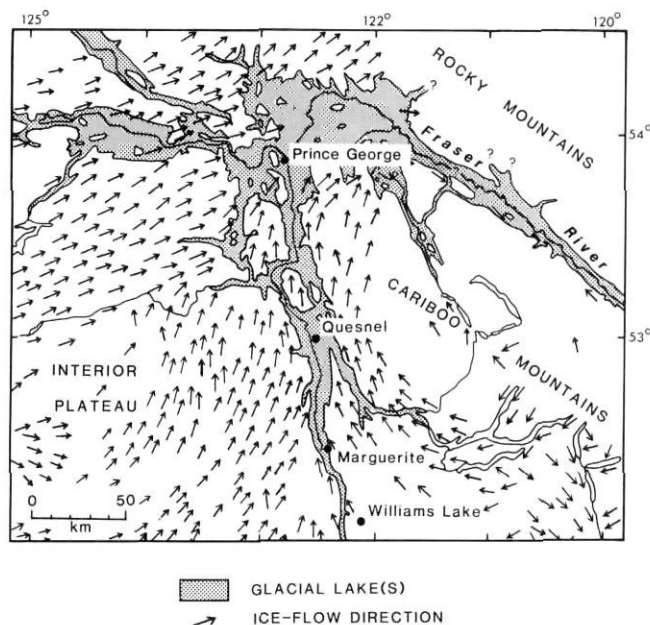

FIGURE 8. Map showing Late Wisconsinan ice-flow directions and the maximum extent of one or more lakes that formed in central British Columbia at the end of the Fraser Glaciation. Ice-flow directions from Tipper (1971a, Fig. 26).

Directions de l'écoulement des glaces au Wisconsinien supérieur et l'étendue maximale d'un ou plusieurs lacs qui se sont formés au centre de la Colombie-Britannique à la fin de la Glaciation de Fraser. Les directions de l'écoulement des glaces sont de Tipper (1971a, fig. 26).

formed in the Quesnel-Prince George region (Fig. 8). This lake expanded as the ice front receded south from Quesnel; later, when the area around Marguerite became ice-free, water levels fell, and the lake decreased substantially in size.

Unit 12 records the development of the late-glacial lake at Quesnel. Initially, till-like diamicton was deposited from subaqueous debris flows and by rain-out from floating ice. Deltas and subaqueous outwash fans consisting of sand and gravel were constructed at the mouths of meltstreams, some of which flowed directly into the lake from decaying ice. Later, when the ice front was south of Quesnel, rhythmically bedded clay and silt were deposited under much lower energy conditions (Fig. 7). Gravelly beach deposits accumulated at the margin of the lake wherever till and glaciofluvial sediments were eroded by waves (Fig. 9).

This lake may have had a short life. Rhythmically bedded sediments, which are widespread through the lake basin, comprise clay and silt couplets which thin upwards in a regular fashion (Fig. 10). There are no more than 100 of these couplets anywhere in the basin. If the couplets are annual layers, the lake existed for no more than a century. If the couplets are not annual, but rather are products of more frequent, sporadic sedimentation events, an even shorter lifespan is indicated.

No datable organic material has been found in unit 12. However, rhythmically bedded clay and silt at section 3 have yielded thermoluminescence apparent ages of 12.8 ± 1.8 ka BP and 13.7 ± 2.3 ka BP (QNL84-3,12 and QNL84-3,5W; Berger *et al.*, 1987). This is in general agreement with

regional evidence that the British Columbia interior became deglaciated about 11 ± 1 ka BP (Clague, 1980, 1981). Dates of $10\,000 \pm 90$ BP (GSC-2964) on wood from a placer gold pit 70 km east-northeast of Quesnel and 9990 ± 90 BP (GSC-4116) on gyttja from the base of a bog 85 km west of Quesnel indicate that deglaciation of central British Columbia was well advanced, if not complete, by 10 ka BP.

The late-glacial lake in the study area drained about 10-11 ka BP, whereupon streams became established in their present valleys. There probably was a brief period of paraglacial fluvial aggradation in these valleys during the early Holocene, as has been recognized elsewhere in British Columbia (Church and Ryder, 1972; Clague, 1986). At the end of this period, base levels at Quesnel were about 70 m higher than they are today. Fraser River and its tributaries, however, soon began to incise their valley fills, producing a series of gravel terraces at successively lower levels. This incision was accompanied by landsliding from unstable valley walls.

The timing of postglacial fluvial downcutting is poorly known. However, radiocarbon dates from low terraces bordering Fraser River north of Quesnel indicate that local base level was less than 10 m above present at 2000 BP and less than 2 m above present at 1000 BP: (1) A log from fluvial gravel underlying a terrace 50 km north of Quesnel yielded a date of 1980 ± 70 BP (GSC-4406). The surface of this terrace is about 7 m above the mean level of Fraser River. (2) A peat layer underlying landslide debris and overlying fluvial terrace deposits at section 2 yielded a date of 930 ± 50 BP. The peat layer is about 5 m above the mean level of Fraser River and could have developed only after the terrace was no longer affected by overbank deposition during floods. This implies that Fraser River at that time probably was no more than 1-2 m higher than today.

In summary, remnants of tills deposited during at least one, and possibly as many as three, pre-Fraser glaciations are present at Quesnel. The stratigraphic record, however, is dominated by glaciolacustrine sediments deposited during the advance and recessional phases of the Fraser Glaciation and by older fluvial (or glaciofluvial) sediments. The latter were deposited on the floors of valleys that were similar in size and depth to existing valleys. These old valleys became filled with glaciolacustrine sediments during the Fraser Glaciation. There is abundant evidence in the Quesnel stratigraphy for sporadic landsliding extending back well into the Pleistocene. Unit 8 was produced by landsliding; mass-movement deposits are also present in units 9, 10, 12, and 13.

CORRELATIONS WITH ADJACENT AREAS

Many of the units described in this paper are widespread in British Columbia and are products of regional, rather than strictly local, events (Table II). Sub-till sediments deposited either early during the Fraser Glaciation or at the end of the preceding Olympia Nonglacial Interval have been recognized at Williams Lake, 100 km south of Quesnel (units 4, 5, and possibly 3 of Clague, 1987). They also are an important part of Kamloops Lake Drift in south-central British Columbia (Fulton

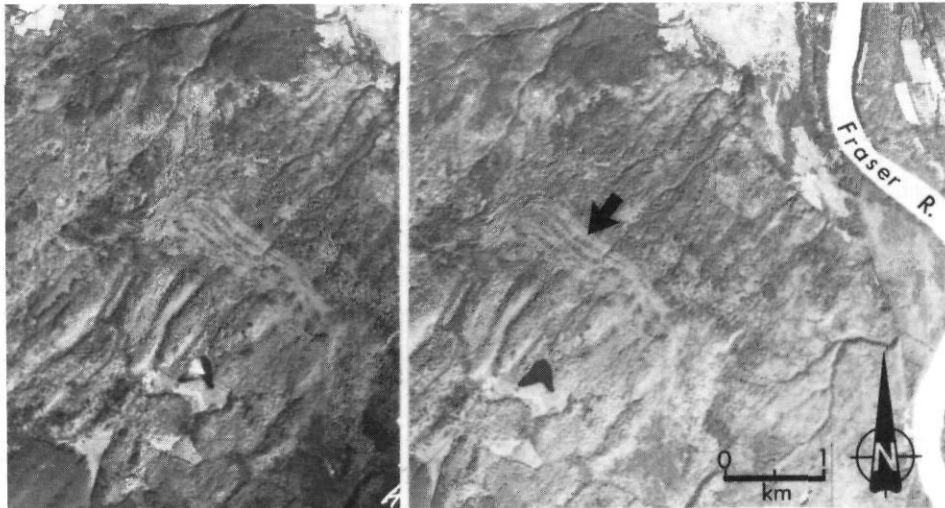

FIGURE 9. Late Pleistocene beaches (top, arrowed) and beach gravel (bottom) in the Prince George-Quesnel area. The beaches are located at the margin of a lake that formed in this area during deglaciation. (Photostereogram compiled from National Air Photo Library photos A13959-128 and -129; location: 10 km south of Prince George.)

Plages du Pléistocène supérieur (haut, flèche) et plage de graviers (bas) de la région de Prince George-Quesnel. Les plages sont situées sur les rives d'un lac qui s'est formé dans la région au cours de la déglaciation. (Stéréogramme à partir des photos A13959-128 et 129 de la photothèque nationale de l'Air; localisation: 10 km au sud de Prince George.)

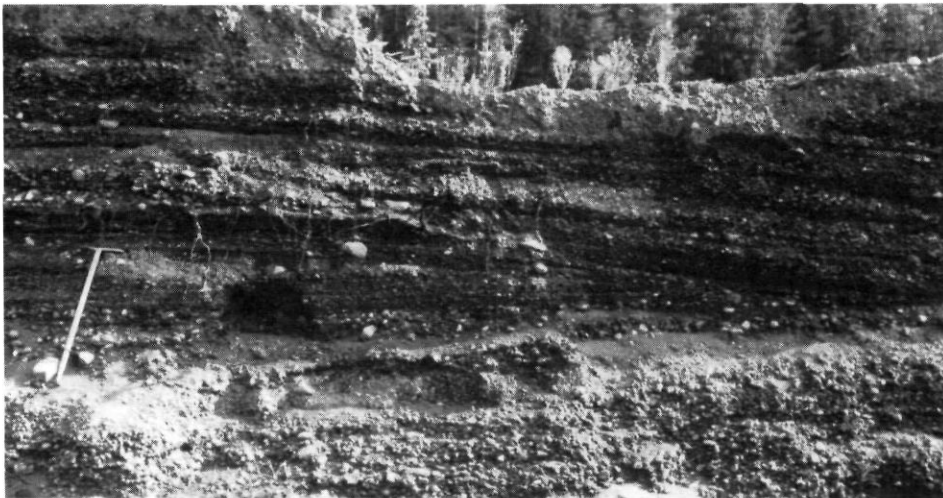

FIGURE 10. Rhythmically bedded clay and silt of unit 12, exposed in a road cut near Prince George. Ice axe (1 m long) near the bottom of the photo provides scale.

Argile et silt à stratification rythmique de l'unité 12, à découvert dans une tranchée en bordure de la route près de Prince George. Le piolet (1 m de long) donne l'échelle.

and Smith, 1978). In many areas, as at Quesnel, these deposits comprise a lower gravelly fluvial unit and overlying silty and sandy lake sediments. This sequence records aggradation and disruption of drainage by advancing glaciers.

Glaciolacustrine sediments dating to the end of the Fraser Glaciation are common in most parts of British Columbia

(e.g., unit 7 at Williams Lake, Clague, 1987; upper unit of Kamloops Lake Drift, Fulton and Smith, 1978). They accumulated in lakes that were dammed by ice and drift as the Cordilleran Ice Sheet wasted away.

At the end of the Pleistocene, the present network of streams became established throughout British Columbia. In most

TABLE II
Correlation chart

Chronostratigraphy	Lithostratigraphic units			Geologic event
	Quesnel (this paper)	Williams Lake (Clague, 1987)	South-central B.C. (Fulton & Smith, 1978)	
Holocene	13	9, 10	Postglacial sediments	Postglacial
Late Wisconsinan	10, 11, 12	5, 6, 7, 8	Kamloops Lake Drift:	Fraser Glaciation:
	12	7, 8	upper unit	recessional phase
	11	6	middle unit	grounded ice phase
	10	4, 5	lower unit	advance phase
Late Wisconsinan?	9*	3*	Kamloops Lake Drift?	Fraser Glaciation?
?	1-8			?

* It is possible that unit 9 at Quesnel and unit 3 at Williams Lake predate the Fraser Glaciation; the correlation with Kamloops Lake Drift thus is tentative.

areas, a brief interval of fluvial aggradation during the early Holocene was followed by degradation and terrace formation that, in most areas, has continued to the present. Sediments deposited under these conditions and broadly correlative with unit 13 of this study are found throughout British Columbia beneath terraces, floodplains, and fans.

Undoubtedly, many of the older units at Quesnel (nos. 1-8) also have regional significance. Unfortunately, it has not been possible to date these units, thus correlations with sediments outside the study area cannot be made at this time.

ACKNOWLEDGEMENTS

The work reported here is part of a larger study of surficial deposits and landforms in the upper Fraser River basin, initiated by the Geological Survey of Canada in 1981. Field assistance at Quesnel was provided by F. Noone, D. Thorkelson, and B. Ward. N. Eyles and R. J. Fulton visited the author in the field and provided valuable advice and ideas. C. Davis drafted several of the figures, and L. E. Vincent translated the abstract and figure captions into French. I. A. Brookes, S. R. Hicock, and L. E. Jackson, Jr. reviewed drafts of the paper. Geological Survey of Canada Contribution 45587.

REFERENCES

- Berger, G. W., Clague, J. J., and Huntley, D. J., 1987. Thermoluminescence dating applied to glaciolacustrine sediments from central British Columbia. *Canadian Journal of Earth Sciences*, 24: 425-434.
- Church, M. and Ryder, J. M., 1972. Paraglacial sedimentation: a consideration of fluvial processes conditioned by glaciation. *Geological Society of America Bulletin*, 83: 3059-3072.
- Clague, J. J., 1980. Late Quaternary geology and geochronology of British Columbia. Part 1: Radiocarbon dates. Geological Survey of Canada, Paper 80-13, 28 p.
- 1981. Late Quaternary geology and geochronology of British Columbia. Part 2: Summary and discussion of radiocarbon-dated Quaternary history. Geological Survey of Canada, Paper 80-35, 41 p.
- 1986. The Quaternary stratigraphic record of British Columbia — evidence for episodic sedimentation and erosion controlled by glaciation. *Canadian Journal of Earth Sciences*, 23: 885-894.
- 1987. Quaternary stratigraphy and history, Williams Lake, British Columbia. *Canadian Journal of Earth Sciences*, 24: 147-158.
- Clague, J. J., Evans, S. G., Fulton, R. J., Ryder, J. M. and Stryd, A. H., 1987. Quaternary geology of the southern Canadian Cordillera. International Union for Quaternary Research, 12th International Congress, Ottawa, Field Excursion Guide Book A-18, 67 p.
- Evans, S. G., 1982. The development of Big Slide, near Quesnel, British Columbia, between 1953 and 1982. *Geoscience Canada*, 9: 220-222.
- Eyles, N., 1987. Late Pleistocene debris-flow deposits in large glacial lakes in British Columbia and Alaska. *Sedimentary Geology*, 53: 33-71.
- Eyles, N. and Clague, J. J., 1987. Landsliding caused by Pleistocene glacial lake ponding — an example from central British Columbia. *Canadian Geotechnical Journal*, 24: 656-663.
- Flint, R. F., 1971. *Glacial and Quaternary geology*. John Wiley and Sons, New York, 892 p.
- Fulton, R. J., 1971. Radiocarbon geochronology of southern British Columbia. Geological Survey of Canada, Paper 71-37, 28 p.
- Fulton, R. J. and Smith, G. W., 1978. Late Pleistocene stratigraphy of south-central British Columbia. *Canadian Journal of Earth Sciences*, 15: 971-980.
- Leaming, S. P. and Armstrong, J. E., 1969. Surficial geology, Prince George, British Columbia. Geological Survey of Canada, Map 3-1969.
- Prest, V. K., Grant, D. R. and Rampton, V. N., 1968. Glacial map of Canada. Geological Survey of Canada, Map 1253A.
- Rouse, G. E. and Mathews, W. H., 1979. Tertiary geology and palynology of the Quesnel area, British Columbia. *Bulletin of Canadian Petroleum Geology*, 27: 418-445.
- Tipper, H. W., 1971a. Glacial geomorphology and Pleistocene history of central British Columbia. Geological Survey of Canada, Bulletin 196, 89 p.
- 1971b. Multiple glaciation in central British Columbia. *Canadian Journal of Earth Sciences*. 8: 743-752.
- Tipper, H. W., Campbell, R. B., Taylor, G. C. and Stott, D. F., 1979. Parsnip River, British Columbia. Geological Survey of Canada, Map 1424A.