

Article

"The development of scree slopes in the English Lake District and Central Québec-Labrador"

J. T. Andrews

Cahiers de géographie du Québec, vol. 5, n° 10, 1961, p. 219-230.

Pour citer cet article, utiliser l'information suivante :

URI: <http://id.erudit.org/iderudit/020310ar>

DOI: 10.7202/020310ar

Note : les règles d'écriture des références bibliographiques peuvent varier selon les différents domaines du savoir.

Ce document est protégé par la loi sur le droit d'auteur. L'utilisation des services d'Érudit (y compris la reproduction) est assujettie à sa politique d'utilisation que vous pouvez consulter à l'URI <https://apropos.erudit.org/fr/usagers/politique-dutilisation/>

Érudit est un consortium interuniversitaire sans but lucratif composé de l'Université de Montréal, l'Université Laval et l'Université du Québec à Montréal. Il a pour mission la promotion et la valorisation de la recherche. Érudit offre des services d'édition numérique de documents scientifiques depuis 1998.

Pour communiquer avec les responsables d'Érudit : info@erudit.org

THE DEVELOPMENT OF SCREE SLOPES IN THE ENGLISH LAKE DISTRICT AND CENTRAL QUEBEC-LABRADOR

by

J. T. ANDREWS

McGill Sub-Arctic Research Laboratory, Schefferville

RÉSUMÉ

Ce texte est une étude comparée des talus d'éboulis du Lake District de Grande-Bretagne et de la partie centrale de l'Ungava-Labrador (région de Schefferville). Après avoir analysé les caractéristiques topographiques, lithologiques et sédimentologiques des talus d'éboulis considérés, ainsi que les conditions de leur genèse en relation avec les facteurs morpho-climatiques, l'auteur pose en conclusion que les talus d'éboulis étudiés sont des formes périglaciaires sub-actuelles liées à un climat plus froid que le climat actuel.

During the summers of 1958 and 1959, the writer made numerous measurements on scree slopes and related slope facets in the English Lake District and in Central Québec-Labrador. In both instances, the angle of the scree slope was measured with a hand level, while a note was also made of the length of each individual slope unit, and the size and nature of the material composing the scree slope. It was felt that an examination of this material might prove instructive in revealing the characteristics of the scree slopes in these two widely different climatic areas, and it was further thought that because of their very nature, they could be examined as regards their usefulness in recognising climatic changes.

Though scree slopes are a conspicuous element in many parts of the world there is a surprising lack of detailed study on the processes involved in their formation and subsequent development. Such important factors as particle arrangement, methods of movement, and rates of disintegration of the free face are little known, and probably vary widely, both in response to climatic factors and differing lithologies and rock structure. The very detailed study by Rapp (1960) in Spitsbergen is the goal for which all studies of scree slopes should be directed.

NATURE OF THE SCREE MATERIAL

The critical examination of the scree slopes in the two areas was facilitated by the similarity of the scree material. Ward has shown that on a cohesionless slope, the nature of the material is of critical importance in determining the angle of repose of the slope (Ward, 1945).

In the English Lake District attention was mainly focused on the Wasdale screes. They are best described by the term gully-screes, a term used here to denote screes originating from rock gullies, and forming fun-shaped accumulations of débris which are convex on the horizontal plane. The screes

FIGURE Ia

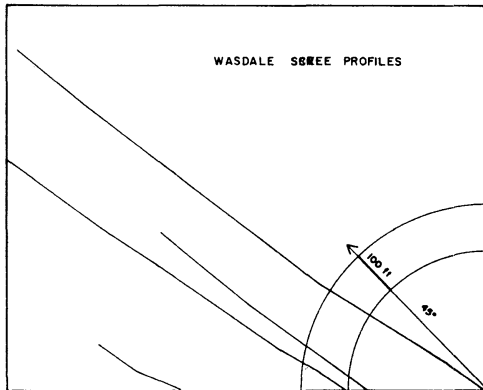
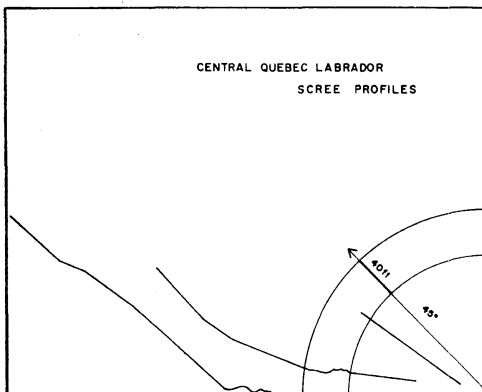

FIGURE Ib



are limited to the east and west by a change in rock type and a fault, so that they are located exclusively on the lower Andesites of the Borrowdale Volcanic series (Paleozoic in age). The rock weathers to form sub-angular fragments of varying sizes, with a roundness value of 0.03 (Powers, 1953).

In Central Québec-Labrador the screes can be classified as sheet screes. In this case the source of origin of the material is from all parts of the free face, and the screes lack the convex horizontal profile that characterises gully-screes. They were located on a wide variety of rock types, but attention was mainly directed to screes located on quartzites, since the weathered material was similar to that found in the Lake District. Observations were also conducted of scree slopes formed of shale fragments.

SCREE SLOPE CHARACTERISTICS

Figure I illustrates the nature of the scree slopes in Wasdale and in Central Québec-Labrador. All graphical comparisons between the two areas are limited to the Wasdale Lower Andesite screes, and to the quartzite screes in Central Québec-Labrador. The most noticeable difference is the lack of a distinct concave element in the Wasdale screes, due to the passing of the slope under Wastwater Lake.

The data collected has been analysed by means of scattergrams whereby different elements of the slopes can be related to each other along the ordinate and abscissae of the graph. Thus, on one graph, the relationships of the slope elements can be compared, or the same element can be compared in two areas, and differences noted. The centre line represents the line of equality.

In Figure II the angles of the scree slopes in the Lake District are compared to those in Central Québec-Labrador. It is at once apparent that there is a very marked similarity in the angle of the scree slope in the two areas, with an average slope of 35° ; but significantly, the Lake District scree slopes stand at a slightly higher angle of rest. This is attributed to the different stages of vegetational development in the two areas. In both cases there was ample evidence that the scree slopes were in a retarded state of development. Crustaceous lichens were well developed, and as Beschel has shown (Beschel, 1950), lichens grow extremely slowly, and they can thus be used as a measure of the time that the habitat has been undisturbed. The Wasdale scree slopes were also inhabited in places by various grasses and shrubs, and chemical weathering had progressed to form a coarse, immature soil, though this was only found in a few localities. King, in a comparison of scree slopes in Iceland and Westmoreland (England), found that the higher degree of vegetation on the Westmoreland scree resulted in a proportionally higher angle of repose (King, 1959), and it is felt that the difference between the Wasdale readings, and those in Central Québec-Labrador can be explained in this way.

Ward states (Ward, 1945) that the angle of repose of a scree slope is conditioned by the density of packing of the material forming the slope, which is in reality a function of the weathered shape of the rock fragments. The very close grouping of the scree slopes in the two areas illustrates this contention. An understanding of the nature of the scree slope is best resolved by applying principles, well known in soil mechanics, to slopes formed of cohesionless material. Being formed of coarse and permeable material, scree slopes are independent of the length of the slope in determining their angle of repose; instead they are controlled by the interaction of two opposing forces, that of gravity which acts to move material down the slope, and that of the internal friction of the scree material. Slope failure occurs when the shear stresses overcome the resistance to shear, resulting in failure and shearing parallel to the slope. Talus creep seems an insignificant, and even doubtful method of slope movement and readjustment, or at least is a method that has not been fully substantiated by experimentation.

Work on the Lake District scree slopes proved conclusively that considerable variations of the angle of repose can occur. It is interesting to note that Hamelin has observed a similar condition in the French Alps (Hamelin, 1958). The

FIGURE II

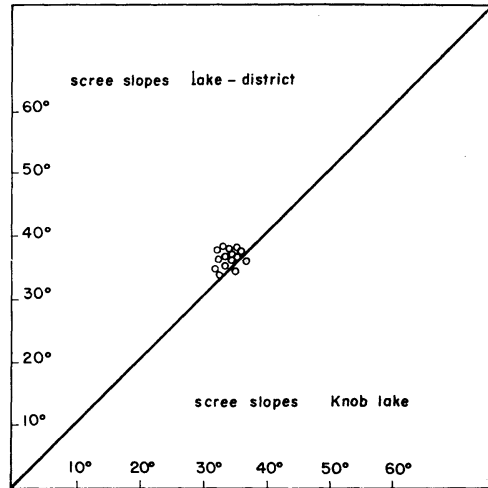

variation on a Wasdale scree is illustrated by reproducing the measured angles given in the table below :

TABLE I

36°	Top of the scree slope.
32°	
35°	
33°	
36°	
30°	Lake level.
35°	

FIGURE IIIa

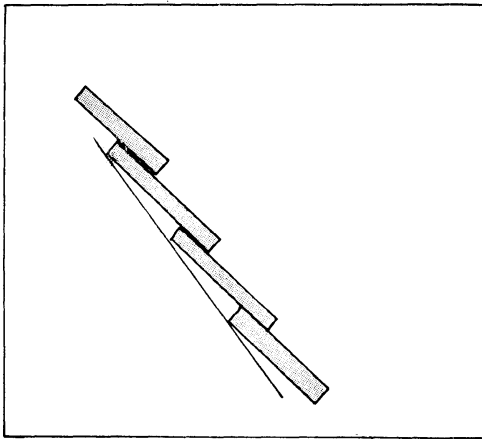
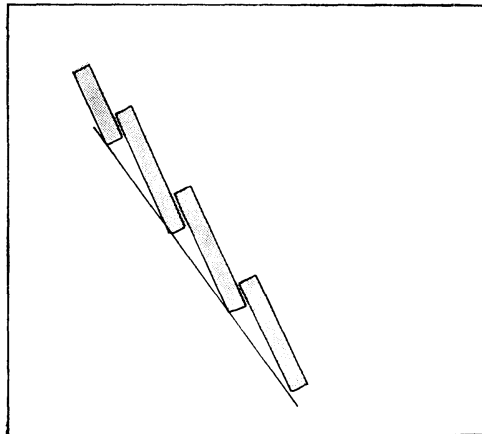

FIGURE IIIb



These variations suggest that the term « Constant » slope is a misnomer, and at least in scree slopes of sub-angular material the main body of the scree rests well below its maximum angle of rest, and can thus tolerate variations of slope angle. Though no detailed measurements have been conducted on scree slopes other than of the sub-angular debris variety, it is felt that scree slopes of platy material (weathered from shales or slates) are less tolerant of variations of slope angle upon the main body of the scree slope, and are in fact in a finer state of adjustment. This can be attributed directly to the nature of the material : a high degree of packing, and thus stability is obtainable with sub-angular material, but it is impossible for platy material to obtain the same degree of packing, thus enabling the scree slope to make adjustments over its total length quite readily. Figure III illustrates in a diagrammatic way the difference in the nature of packing between the two materials ; it should be noted that the long axis of the platy material is parallel to the slope, so that relief from shear stresses is accomplished much easier than in sub-angu-

lar material. The findings of Meiner in Gaspé are at variance with those of the present writer (Meiner, 1934). In Gaspé the scree slopes were characterised by very steep slopes (38° - 40°), and were very stable, even though they were formed on elongated calcareous fragments. The reason for the stability was attributed to the packing of the fragments which lay with their long axis parallel to the slope, and overlapped by the previous fragments (Meiner, *op. cit.*). In Central Québec-Labrador the arrangement of the fragments seems to be reversed, with each succeeding fragment being overlapped by the following fragment. Figure IV indicates the difference between the two arrangements. Why this should happen is difficult to explain, and needs more work, possibly under experimental conditions in a laboratory.

It is suggested that these variations of slope angle as observed in the Wasdale scree slopes, are the result of slope failure, producing localised movements of the scree material, and resulting in a steep frontal slope and a more gentle back slope. The actual result is, therefore, a rotational type of slip, with the original failure occurring along lines parallel with the scree slope. The moving scree over-rides the material downslope, and thus forms a steep foreslope. This is analogous to the shearing of active ice over slower moving or stagnant ice at the snout of a glacier. It is interesting in this connection to consider the figures for the average size of the material on the different sections of the scree slopes (see Table II on the following page).

All the scree slopes in Wasdale had similar characteristics though the actual stage of development was somewhat uneven. There did appear to be a relationship between the slope angle and the size of the material that could be explained by the above hypothesis. It also appeared that the section of slope characterised by a high angle of rest was also fairly short (in a relative sense), compared to the gentler and longer back slope.

FIGURE IVa

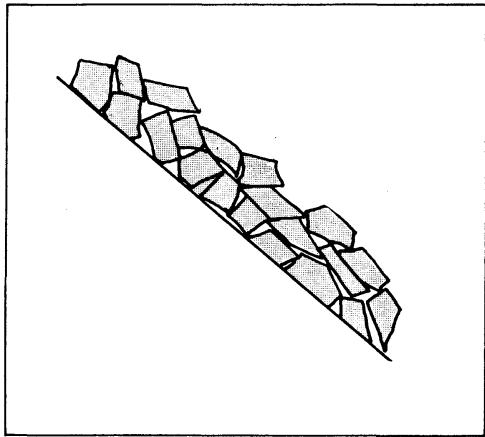

FIGURE IVb

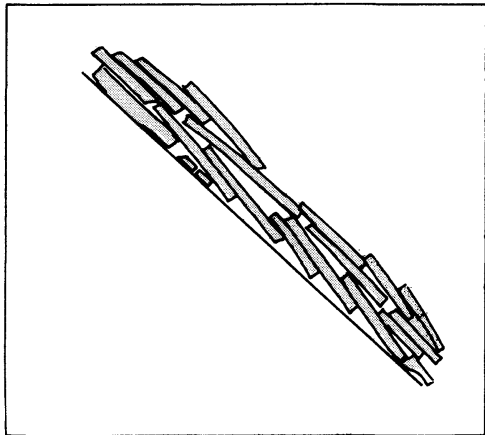

TABLE II

<i>AVERAGE SIZE OF SCREE MATERIAL ON THE SCREE SLOPE</i>	
The same scree slope as in TABLE I	
1" to 6"	Top of the scree slope.
1' to 6"	
2'	
1'6"	
2'	
1'	
6' to 4'	Lake level.

In Central Québec-Labrador nothing of this nature was noted on the quartzite scree slopes. Though breaks of slope were apparent, critical examination revealed that they were in fact conditioned by the underlying rock structure, covered only with a thin veneer of scree material. An examination of certain scree slopes in the area formed below outcrops of shale proved to be of great interest. Generally the long axis of the material lay parallel to the slope, but in certain places it was found that the long axis of the material was inclined at an angle to the slope, as if slope failure had induced a slight rotational movement in the scree material. It is apparent that a study of scree slopes on differing rocks (differing mainly as to the shape of the weathered material) and under the same climatic regime would be most instructive.

An examination of the size of the material composing the scree slope from its base to the top, reveals a rough grading of size. On slopes of sub-angular material the degree and extent of grading can vary quite widely, but incomplete observations on scree slopes of platy material indicates that here the grading is more closely confined within a certain range. This is compatible with the difference in the degree of packing of the materials and ease of relief from shear stresses. In Central Québec-Labrador a small scree standing at an average angle of 35° had the following gradation :

TABLE III

<i>AVERAGE SIZE OF SCREE MATERIAL</i>	
2" to 6"	Top of the scree slope.
1'	
2" to 3"	
1'6"	

These readings were taken at 50' intervals up the scree slope. While the scree slopes at Wasdale revealed a similar character, they had a more varied aspect. An example from Wasdale is to be found in Table II and also in the figures below :

TABLE IV

<i>AVERAGE SIZE OF THE SCREE MATERIAL</i>	
6" to 1'	Top of the scree slope.
1" to 2"	
6"	
6" to 1'	
1' to 2'	
3' to 4'	
6'	Lake level.

These readings refer to spot examinations in areas of observable break of slope. Even on screes within the same general area there is often wide variation in material size, though the nature and size of the material is largely dependent upon the lithology of the parent rock, thus Table III and Table IV are not average conditions but actual examples. Again, as far as observations have gone, it appears that the scree material of a platy nature is more regularly graded as regards size over the length of the scree slope. With the long axis of the material parallel to the slope the resistance to shear is low, and shear stresses induced by material being of a larger size than that demanded by the local angle of repose lead to a redistribution of material down the slope. Scree slopes developed with sub-angular material exhibit no definite arrangement of rock fragments, and being in a coarser state of adjustment can tolerate greater variety of sizes on a given slope section. In general the slopes exhibited a grading of material, fine at the top, and becoming progressively coarser down the slope. This is coupled with a slight increase of gradient from the base of the scree slope, so that again the use of the term « Constant » is inappropriate. The slope is, in fact, slightly concave. The grading of the material is in part explained by differential rates of fall from the free face ; there is a natural tendency for the larger material to fall appreciably further down the slope. Once established, this effect is further heightened by the finer material at the top of the scree slope standing at a higher angle of rest due to the density of packing on the slope. Larger material resting on this section of the slope will be essentially unstable. The observations of Behr (1933) indicate that in certain areas the sorting of scree material is reversed, and in these cases the coarser material rests at the top of the slope and grades into finer material. The experimental work of Burkalow (1945) suggested that a particular scree slope is

the end result of the intersections of a number of complex variables, all of which affect the slope angle. There has been little attempt to check the laboratory results of Burkalow with quantitative field data, though this again is an aspect of slope studies that demands attention.

The Wasdale screes were markedly convex in their lower portions, with a difference of angle of 4° between the slope rising immediately out of the lake, and the break of slope above. This is explained as being due to the undercutting of the slope by waves generated on Wastwater, though surprisingly, this seemingly unstable state has not resulted in any compensating movements of the slope above, or at least in recent times, as is evidenced by the lichen covered scree material.

RELATION OF THE FREE FACE TO THE SCREE SLOPE

Figure V indicates the angular relationship of the free face to the scree slope. In contrast with the close grouping that was observed in Figure II it is

evident that the free face varies within wide limits. These limits are governed by several factors, of which the structure of the rock, and the nature and duration of the weathering processes on the free face are most important.

A study of the free face in both the Lake District and in Central Québec-Labrador was undertaken in connection with the study of the scree slopes. It was apparent that it was only undergoing slight attack from weathering agencies, and thus the supply of material to the scree slope was correspondingly meagre. This, taken in conjunction with the vegetate nature of the screes, supports the conclusion that they are in a retarded state

of development. It would seem that this is best explained by postulating severe freeze-thaw at some period in the past. What this means in terms of climatic parameters, and the role of freeze-thaw, is examined later.

USE OF SCREES AS INDICATORS OF CLIMATIC CHANGE

In both the English Lake District, and in Central Québec-Labrador, it was concluded that the screes were in a retarded state of development. The extent of the free face facet in the two areas makes it inevitable that climatic

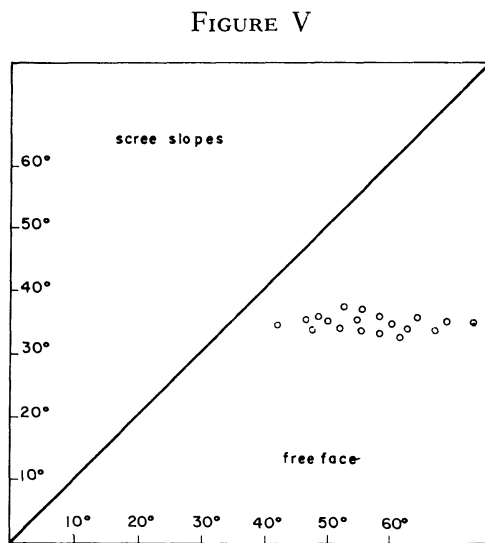

factors should be called upon to explain the slight weathering of today, and the evidence of fairly vigorous attack at some period in the past. On an active scree slope, the supply of material from the free face calls for repeated adjustments over its entire length. Vegetation finds it difficult, if not impossible, to establish itself on the slope. With a diminishing supply of material from the free face, the need for readjustments on the scree slope will be reduced; plants will in time establish themselves on the scree, which in its turn will hasten the stabilisation of the slope.

In the English Lake District, the development of the screes can be dated as beginning to form in Allard times, then the ice disappeared, only to reappear in the form of small valley glaciers in some of the valleys in post-Allerød times. From this time on till the present day, the growth and « health » of the screes has been conditioned by those climatic changes which affect the rate of weathering of the free faces. The climatic history of the north of England has been similar to that experienced in Scandinavia (Manley, 1950) and the last period of active scree formation was possibly coterminous with the xviith and xviiith century advance of the glaciers in this area. That the climate was in fact more severe at some period in the immediate past seems to be proved conclusively by the finding of subactual periglacial phenomena in the northern and western Lake District (Hay, 1936; Hollingworth, 1934; Andrews, 1959), and it seems logical to classify the screes as sub-actual periglacial features.

Central Québec-Labrador, which experiences a sub-arctic climate, should according to Peltier (Peltier, 1950), be close to the southern boundary of areas experiencing maximum to moderate mass-movement, and mechanical weathering. Derbyshire and Henderson (Derbyshire, 1959; Henderson, 1959) speak of the present day potency of mechanical weathering, caused by frequent fluctuations of the temperature about the freezing point; while Henderson and Twidale further demand a period at some period in the past with quite massive mechanical weathering and mass-movement to account for the formation of nivation hollows, and *vallons de gélivation* (Henderson, 1959; Twidale, 1956, 1958). Observations carried out while at the McGill Sub-Arctic Research Laboratory indicated quite conclusively that at the present day, mechanical weathering is relatively slight, and from the preservation of glacial striae on exposed ridge tops, has been since glacial times, while detailed observations on the *vallons de gélivation* have shown that they are not, in fact, periglacial forms. It does seem that the role of freeze-thaw in the production and movement of material in this part at least of the Sub-Arctic has been vastly overstated, and that the number of freeze-thaw cycles has little importance. Haywood, in preliminary measurements at the McGill Sub-Arctic Research Laboratory on soil movements, has observed only one major freeze-thaw cycle in the year, and a maximum of four additional minor cycles (Haywood, 1960). The work of Grawe and Battle (Grawe, 1936; Battle, 1952) casts serious doubts on the mechanical effectiveness of the freeze-thaw cycle as popularly defined, and demands both a more rapid change of temperature, and a larger temperature range than is usually allowed for. Even so, it is very difficult to explain the present form, and state of development of the screes in the area without recourse to a change in climate, and one in which

mechanical action was stronger than at present. Though the usual course is to attribute the forms to action during the « little ice age » (Henderson, 1959 ; Twidale, 1958) the actual effectiveness of a colder climate on mechanical weathering should be questioned.

FIGURE VI

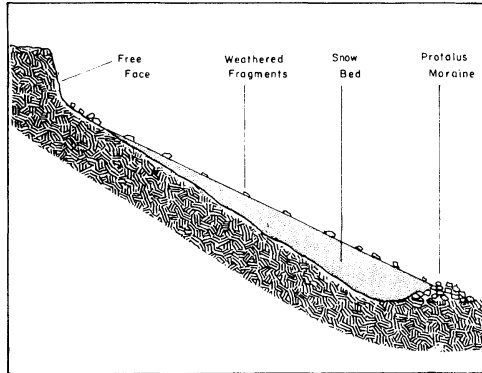

At the foot of several of the scree slopes to the west of the town of Schefferville, are long, low ridges, paralleled to the valley sides, and separated from the scree slope by a marked depression (Figure VI). Examination of the material composing the ridge showed it to be sub-angular in form, and of the same rock type as the adjacent scree slope. The form, composition, and situation of the ridges make it appear unlikely that they are of glacial origin, and the logical explanation is that they are protalus moraines, formed at a period when permanent, or semi-

permanent snow banks lay along the valley sides. At present the snowbeds disappear in the area in mid to late July ; but observations carried out from the McGill Sub-Arctic Research Laboratory since 1955 indicate the presence of semi-permanent snowbeds in certain localities even today. Manley has examined the relationship between the altitude of semi-permanent snowbeds, and regional snow line in maritime Britain (Manley, 1949), and came to the conclusion that snowbeds will linger down to 1570' below the regional snow line, which can in turn be equated with a summer temperature in the area of the snowbeds, of 42°F. (June-September). However, in a cold continental climate snowbeds are likely to survive slightly warmer summers due to the internal residual cold from the severe winter period. It is thus probable that snowbeds will survive in areas where the mean summer temperature is 44°F. or even slightly higher. The summer of 1956 fulfilled these conditions, and in the Labrador Trough a mean temperature of 46°F. was recorded. Allowing for elevation, this suggests that at the altitude of the snowbeds the temperature was 2°F. lower, that is 44°F. Snowbeds remained through this summer in favourable localities. However, in 1954 and 1959 the snowbeds lingered through summer though for seemingly different reasons.

Data, collected and analysed at the Laboratory, indicate that the disappearance of the snowbeds generally show no obvious relationship to summer temperature or to winter precipitation. In fact, the controlling forces seem to be winter wind speed, and local topography (Ives, 1960). At the time when the snowbeds were more extensive it is reasonable to suppose that their duration and extent were controlled by the summer temperature. The present average summer temperature at 2000', which is the height at which the protalus moraines are to be found, is 47°F., and it appears that the protalus moraines were formed

at a time when the summer temperature was about 3°F. cooler than at present. No age can be assigned to this period. Ives has suggested that a figure of 2500'-2700' is of the correct order of magnitude for the height of the regional snowline above the snowbeds in a continental climate (Ives, *op. cit.*), and adopting these figures it would seem that the height of the regional snowline at the time of the formation of the proctalus moraines was 4700' and that the present regional snowline over the area is between 5500'-6000'. These figures are higher than those calculated by Ives (Ives, *op. cit.*), and this evidence suggests that Derbyshire (1960) has also placed the regional snowline too low in Central Labrador-Ungava.

There is accumulating evidence in Central Québec-Labrador for a period of more severe climate at some time in post-glacial times that has generally been attributed to the « little ice age » period, but the role of mechanical weathering has been overemphasized. Matthew has noted old, non-active stone circles north of the Indian House Lake area (Matthew, 1960), as did the writer in the Tessiuyak Bay area of Newfoundland-Labrador. On gravel outwash plains in the area there were networks of patterned ground, with diameters of 20' and over. Ives (1961) has postulated a correspondence of permafrost with vegetation in Labrador-Ungava, and as such, this theory does not necessitate drastic climatic changes to account for relic permafrost in southern Labrador-Ungava (Andrews, 1961). However, the evidence of the fossil stone circles and polygons in areas north of the present treeline suggests that they might be dated to a time of more active soil movements, since when the permafrost has been degrading. This is a tentative suggestion, and requires corroboration.

A recourse to a colder climate does not solve all the problems : it is instructive to imagine the role of freeze-thaw at this period of lower temperatures : the presence of snow beds for most, if not all the year, and a lower summer temperature would in fact reduce the potency of the process, since the lower seasonal temperature would mean a smaller possible temperature fluctuation over, and below the freezing point, which would generally be considered as unsuitable for scree formation. Rapp (1960) in studying active scree slopes in Spitsbergen has stressed the importance of long termed temperature cycles such as the annual, in controlling the supply of scree material.

CONCLUSIONS

The main conclusion to be drawn is the need for more detailed work on scree slopes of all types, in different areas, and composed of different fragment shapes to find the exact relationship between these variables. Generally the scree slope has been associated with a constant slope of a certain inclination, but little attention has been paid to the arrangement of individual particles on the scree slope, and its effect on the character of the slope.

It does seem that the scree can be used as an indication of a change of climate as it affects the supply, or otherwise, of material to the scree slope, but it seem that the general answer to the question, that of a colder climate in the past, has certain mechanical weaknesses.

ACKNOWLEDGMENTS

The writer would like to take this opportunity to thank a number of people for their help and co-operation : Mr. W. Davidson assisted the writer in measuring the screes in the Lake District, while Dr. J. D. Ives, Mr. P. J. William, and Mr. E. M. Matthew have read and criticised the work. Miss Martha Tuthill kindly typed the paper.

REFERENCES

- ANDREWS, J. T., *Geomorphology of the Wasdale, Miterdale, and Eskdale area of West Cumberland*, in unpublished B. A. thesis, Nottingham University, 1959.
- BATTLE, W. R. B., *Corrie formation with particular reference to frost shatter at depth*, in unpublished Ph. D. thesis, presented to Cambridge University, 1952.
- BEHR, C. H. Jr., *Talus behaviour the timber line in the Rocky Mountains*, in *Jour. of Geol.*, vol. 41, pp. 622-635.
- BESCHEL, R., *Lichens as a yardstick of age of late-glacial moraines*. Translated from *Zeit. für Gletscher. und Glazial.*, vol. 1, 1950, p. 153.
- BURKALOW, A., *Angle of repose and sliding friction*, in *Bull. Geol. Soc. Amer.*, 56, pp. 669-707.
- DERBYSHIRE, E., *Fluvial-glacial erosion in Central Québec-Labrador*, in unpublished M. Sc. thesis, McGill University, 1959.
- DERBYSHIRE, E., *Glaciation and subsequent climatic changes in Central Québec-Labrador — A critical review*, in *Geogr. Ann.*, vol. 42 (1) 1960, pp. 49-62.
- GRAWE, O. R., *Ice as an agent of rock weathering*, in *Jour. of Geol.*, vol. 44, 1956.
- HAMELIN, L. E., *Le talus oriental d'éboulis de l'Aiguille Rousse*, in *Rev. de Géog. Alpine*, 1958, pp. 429-439.
- HAY, T., *Notes on glacial erosion and stone stripes*, in *Geog. Jour.*, vol. 87, 1936, pp. 47-51.
- HAYWOOD, B. H., Personal communication, 1960.
- HENDERSON, E. P., *A glacial study of Central Québec-Labrador*, in *Geol. Survey of Canada, Bull.* 50, 1959.
- HOLLINGWORTH, *Some solifluction phenomena from the Northern Lake District*, in *Proc. York. Geol. Soc.*, 1934.
- IVES, J. D., *Semi permanent snowbeds in Central Labrador Ungava*, in *McGill Sub Arctic Research Papers No. 9*, 1960, pp. 45-56.
- KING, C. A. M., Personal communication, 1959.
- MANLEY, G., *Some consequences of the relation between glacial variation and British climate*, in *Jour. of Glac.*, vol. 1, 1950, n° 7, pp. 352-357.
- MATTHEW, E. M., Personal communication, 1960.
- MEINER, N. A., *Talus slopes of the Gaspé peninsula*, in *Science*, vol. 79, 1934, pp. 229-230.
- PELTIER, L., *The geographic cycle in periglacial regions as it is related to climatic geomorphology*, in *Assoc. Am. Geog. Ann.*, vol. 40, 1950, pp. 214-236.
- POWERS, M. C., *Comparison chart for visual estimation of roundness*, in *Jour. Sed. Petrology*, vol. 23, 1953, pp. 117-119.
- RAPP, A., *Talus slopes and Mountain Walls at Templefjordan Spitsbergen. A geomorphological study of denudation slopes in an Arctic locality*, in *Norsk Polar. Skifter*, 1960, 119, 96 pp.
- TWIDALE, C. R., *Vallons de gélivation dans le centre du Labrador*, in *Rev. de géomorph. dynam.*, vol. 7, 1956, n°s 1-2, pp. 18-23.
- TWIDALE, C. R., *Vallons de gélivation dans le centre du Labrador*, in *Rev. de géomorph. dynam.*, vol. 9, 1958, n°s 5-6, p. 84.
- WARD, W. R., *Stability of natural slopes*, in *Geog. Jour.*, vol. 105, 1945, pp. 170-197.