

EFFECT OF THICKNESS OF OVERLAYING CLAY LAYER OF LOWLAND REGION ON SENSITIVITY OF LATERAL DEFLECTION OF LONG PILES EMBEDDED IN NON-HOMOGENEOUS SOIL – PART IIB: NUMERICAL STUDY OF CLAY AND PILE PARAMETERS

D. H. Hafez¹ and B. B. Budkowska²

ABSTRACT: This part of the paper is a direct continuation of part I and part IIA of the paper. The first part of the paper presented the theoretical formulation of the sensitivity of the lateral head deflection of piles embedded in non-homogeneous soil consisting of clay overlying sand to changes in the design parameters. Parts IIA and IIB cover the numerical sensitivity studies based on this theoretical formulation. Part IIA studied the effect of variation in sand parameters on the variation of the lateral pile-head deflection. This part (part IIB) presents the sensitivity of the lateral pile-head deflection to variations in the clay and pile parameters. The numerical sensitivity results are graphically plotted along the pile length. The effect of the thickness of the overlying clay layer on these sensitivity results is investigated. This effect of non-homogeneity of soil is of significant importance to areas in which the overlying clay layer has variable thicknesses such as in lowland areas.

Keywords: Distributed parameter sensitivity, numerical analysis, clay and pile parameters, non-homogeneous soil

INTRODUCTION

Studying the sensitivity of the system response with respect to system parameters is important to broaden our understanding of the system behavior. In addition, it is considered as a versatile design tool. The sensitivity results represent trends for the system response that are important to the designer in changing his design estimate.

The current study investigates the sensitivity of the laterally loaded pile-soil system and the system response is taken as the lateral pile-head deflection which is an important serviceability measure for the superstructure supported by the laterally loaded piles. The sensitivity formulation was derived based on the adjoint method of sensitivity analysis with distributed design variables (Kleiber, 1997) in Part I of the paper (Hafez and Budkowska, 2006a). The laterally loaded pile subjected to horizontal loads at its head is embedded in non-homogeneous soil consisting of clay overlying sand. Both layers are under water table and the pile is subjected to cyclic loading.

The sensitivity formulation resulted in obtaining sensitivity operators for each parameter that can be graphically plotted allowing the engineer to detect where along the pile length and how each parameter affects the lateral top deflection. The design parameters investigated

were eight parameters that define the pile structure and the adjacent p - y clay (Matlock, 1970) and p - y sand soils (Reese et al., 1974) (where p stands for soil resistance and y stands for the pile deflection).

The sand parameters were numerically investigated in Part IIA of the paper (Hafez and Budkowska, 2006b) with the aid of the nonlinear finite difference program COM624P (Wang and Reese, 1993) used for analysis of laterally loaded piles. In this part of the paper the clay and pile parameters will be numerically investigated, i.e. the effect of the change of clay and pile parameters on the change of pile-head lateral deflection will be studied.

Moreover, the effect of the thickness of the overlying clay layer on the sensitivity results will be numerically investigated through comparative sensitivity assessment. Different thicknesses of the overlying clay layer are compared. The thickness of the clay layer overlying the sand layer ranges from 10% of the pile length up to 50%.

The input data used for the numerical investigation is first presented followed by the sensitivity results of the variation of lateral head deflection of piles embedded in different cases of non-homogeneous soil due to variations in the clay and pile parameters. The effect of the thickness of the overlying clay layer on the sensitivity results is finally discussed.

¹ Ph.D. Candidate, University of Windsor, Civil and Envir. Eng. Dept., 401 Sunset Ave., N9B 3P4, Windsor, Ontario, CANADA

² Professor, University of Windsor, Civil and Envir. Eng. Dept., 401 Sunset Ave., N9B 3P4, Windsor, Ontario, CANADA

Note: Discussion on this paper is open until June 30, 2007.

INPUT DATA

The input data was discussed in detail in Part IIA (Hafez and Budkowska, 2006b). It is summarized below:

- Pile length = 16m (behaves as a long pile)
- Pile head fixity = free head pile
- Soil stratification = thickness of clay layer varies from 10% of pile length to 50%. (0% clay case is omitted since the clay parameters are investigated not sand)
- Loading: applied at the pile head located at the ground surface in increments of 25 kN up to a load that causes plastic flow in the clay in each case of thickness.
- Initial values used for the design variables:
 EI = pile's bending stiffness = 55,400 kNm²,
 b = pile diameter = 406 mm;
 γ'_c = submerged unit weight of clay = 7.5kN/m²;
 c = undrained cohesion = 18kN/m²;
 ε_{50} = the strain corresponding to one-half of the compressive strength of clay = 0.02;
 ϕ = friction angle of sand = 33°,
 γ'_s = submerged unit weight of sand = 10kN/m² and
 k = constant representing the modulus of subgrade reaction in the linear stage of sand behavior = 16,285.8 kN/m³.

SENSITIVITY RESULTS

The theoretical formulation of the sensitivity analysis using the adjoint method with distributed parameters resulted in the derivation of Eq. (22) in Part I (Hafez and Budkowska, 2006a) which takes into account the non-homogeneity of soil. It is considered by using local coordinates for each layer as shown in Fig. 1. These local coordinates are used for the bounds of integration for each layer in Eq. (22) which is repeated below:

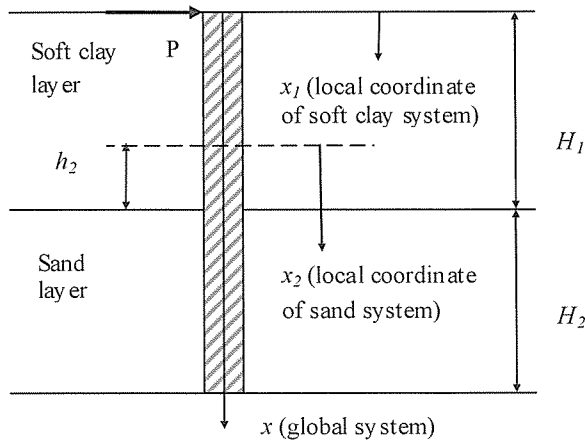

Fig. 1 The coordinate systems of a pile embedded in a non-homogeneous soil

$$\begin{aligned}
 1_a \delta y_t = & \int_0^{H_1} (S_{EI})_c (\delta EI_N)_c dx + \int_0^{H_1} (S_b)_c (\delta b_N)_c dx + \\
 & \int_0^{H_1} (S_{\gamma'_c})_c (\delta \gamma'_{cN})_c dx + \int_0^{H_1} (S_c)_c (\delta c_N)_c dx + \\
 & \int_0^{H_1} (S_{\varepsilon_{50}})_c (\delta \varepsilon_{50N})_c dx + \int_{h_2}^{h_2+H_2} (S_{EI})_s (\delta EI_N)_s dx + \\
 & \int_{h_2}^{h_2+H_2} (S_b)_s (\delta b_N)_s dx + \int_{h_2}^{h_2+H_2} (S_{\gamma'_s})_s (\delta \gamma'_{sN})_s dx + \\
 & \int_{h_2}^{h_2+H_2} (S_{\phi})_s (\delta \phi_N)_s dx + \int_{h_2}^{h_2+H_2} (S_k)_s (\delta k_N)_s dx
 \end{aligned} \quad (1)$$

where 1_a is the unit load applied to the adjoint pile at the pile head, δy_t is the variation in the top deflection in the pile, $(S_{(\cdot)})_c$ and $(S_{(\cdot)})_s$ denote the normalized sensitivity operators for clay and sand, respectively and the symbols $(\delta(\cdot)_N)_c$ and $(\delta(\cdot)_N)_s$ denote the normalized variations of design variables for clay and sand, respectively.

The graphical presentation of the sensitivity operators allows us to examine the effect of the change of the design variables on the changes of the pile-head lateral deflection δy_t along the pile length. Thus the most and least effective locations of the change of the design variables on the pile's lateral head deflection can be observed. Due to the normalization process, the units of all the sensitivity operators are in kN.

The current paper investigates the sensitivity of the lateral top deflection to changes in five design parameters. These parameters are the design parameters of soft clay (γ'_c , c and ε_{50}) and the pile parameters (EI and b). The sand parameters (γ'_s , ϕ and k) were discussed in Part IIA (Hafez and Budkowska, 2006b).

The sensitivity operators are presented graphically for the different cases of clay thickness. In each case of thickness the operators are plotted for different loads applied in increments of 25kN as mentioned above. However, for clear outputs only increments of 50kN are shown in some figures.

Sensitivity to Changes in Clay Parameters

The clay design parameters studied are those defined in the p - y soft clay relationship. The p - y soft clay relationship involves three stages of the soil behavior that were discussed in Part I (Hafez and Budkowska, 2006a) and are shown again in Fig. 2. In Fig. 2 p_{ult} is the ultimate soil resistance per unit length of the pile, y_{50} is the deflection at one-half of that ultimate soil resistance and x_{rc} is the depth of reduced resistance.

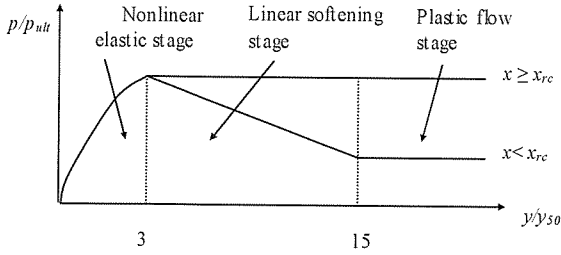

Fig. 2 Nonlinear behavior of soft clay subjected to cyclic loading after Matlock et al. (1970)

The distribution of sensitivity operators $(S_{\epsilon_{50}})_c$, $(S_{\gamma'_c})_c$, and $(S_c)_c$ presents the changes of pile-head lateral deflection δy , caused by the change of normalized design variables ϵ_{50} , γ'_c , and c , respectively. These variables are connected to the clay layer only. The figures showing the distribution of these operators are divided into two groups. This is due to the difference in the order of magnitude of the sensitivity operators in addition to the change in the shape of the distribution of the operators between the two groups.

In the first group, at low levels of the applied load, the soft clay at the ground surface is in the nonlinear elastic stage. Since the deflection decreases with depth, the entire soil layer is in a nonlinear elastic stage. In the second group, the soil at the ground surface is in the linear softening phase for all values of applied load except for the maximum load applied for each case where plastic flow occurs at the ground surface. Therefore the entire clay layer experiences the linear softening behavior (second stage) or both the first and second stages depending on the clay thickness and level of load applied.

The distribution of $(S_{\epsilon_{50}})_c$ is plotted for different cases of clay thickness ranging from 10% to 50% in Figs. 3 to 7, respectively. The distribution of sensitivity operator $(S_{\epsilon_{50}})_c$ shows a positive value of the operator. The positive sign is expected since ϵ_{50} is a measure of deformability (opposite to the other variables), i.e. the increase of ϵ_{50} causes an increase in the lateral deflection. However, the values are positive only for ϵ_{50} in the first group (nonlinear elastic stage). The sign is negative when the soil experiences the linear softening stage.

These positive and negative results were checked numerically using the computer code COM624P. It was found that when ϵ_{50} is increased in the area where the operator has a positive value, the deflection at the pile head increases while it decreases in the area where the operator has a negative value when ϵ_{50} is increased verifying the sensitivity results obtained.

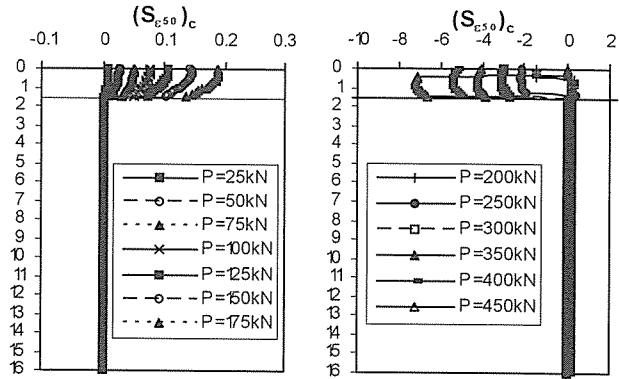

Fig. 3 Distribution of $(S_{\epsilon_{50}})_c$ for 10% clay

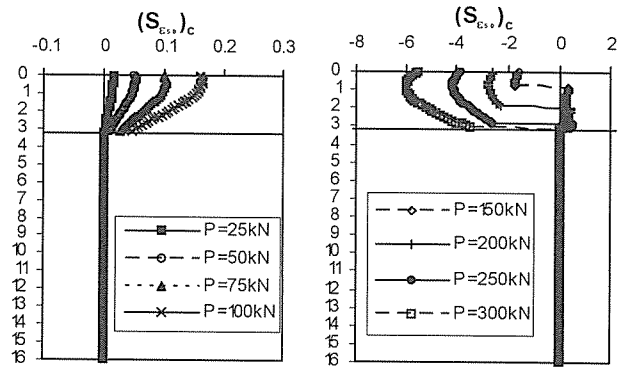

Fig. 4 Distribution of $(S_{\epsilon_{50}})_c$ for 20% clay

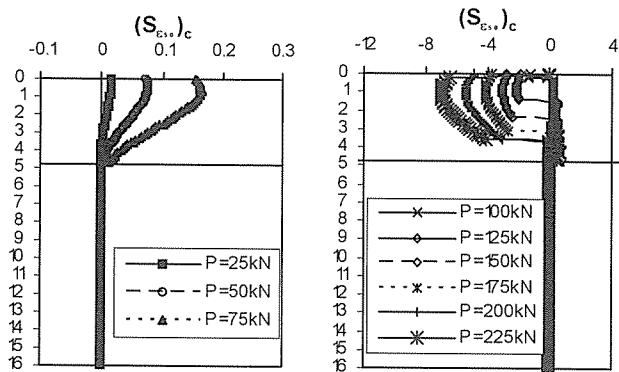

Fig. 5 Distribution of $(S_{\epsilon_{50}})_c$ for 30% clay

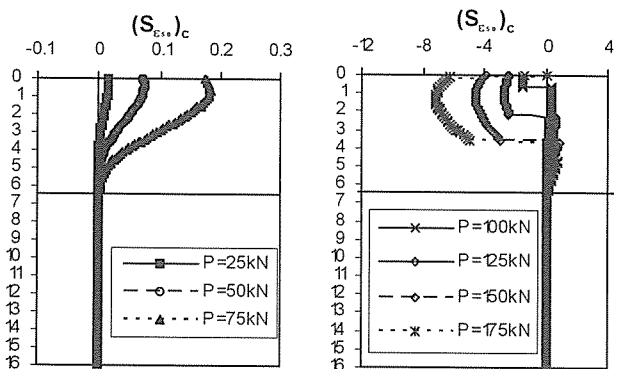

Fig. 6 Distribution of $(S_{\epsilon_{50}})_c$ for 40% clay

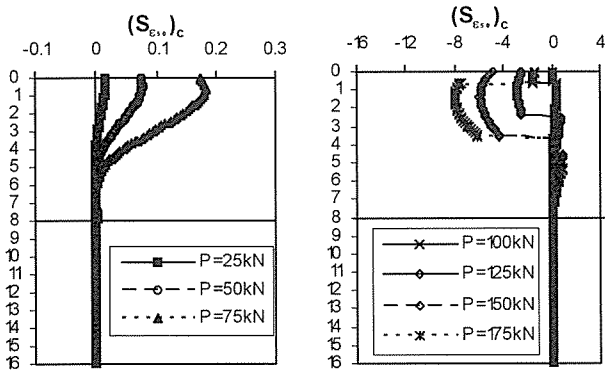

Fig. 7 Distribution of $(S_{\epsilon_{50}})_c$ for 50% clay

The distribution of $(S_{\gamma'_c})_c$ (Figs 8 to 12) that presents the changes of $\delta\gamma'_c$ caused by changes of the submerged unit weight of soft clay, γ'_c , shows that there is no effect for the change of γ'_c on $\delta\gamma'_c$ below the depth $x = x_{rc}$. The depth of reduced resistance of clay x_{rc} is equal to 3.64 m for the initial design variables used. For 10 % and 20% clay (clay thickness = 1.6m and 3.2 m respectively), the clay thickness is less than x_{rc} thus values of $(S_{\gamma'_c})_c$ are obtained in the entire clay thickness.

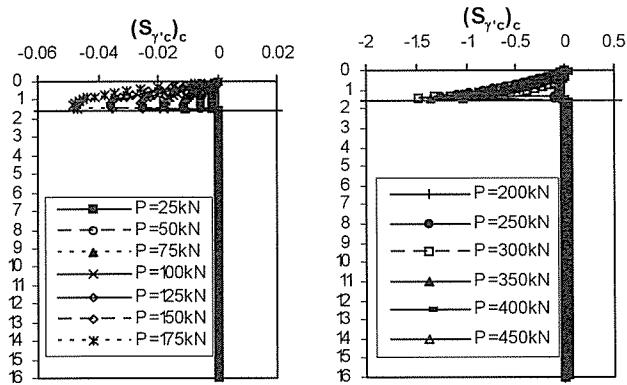

Fig. 8 Distribution of $(S_{\gamma'_c})_c$ for 10% clay

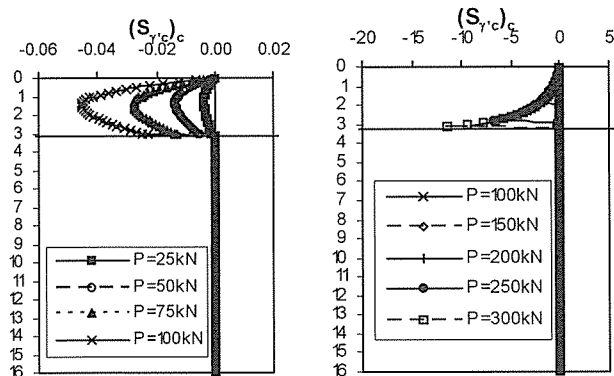

Fig. 9 Distribution of $(S_{\gamma'_c})_c$ for 20% clay

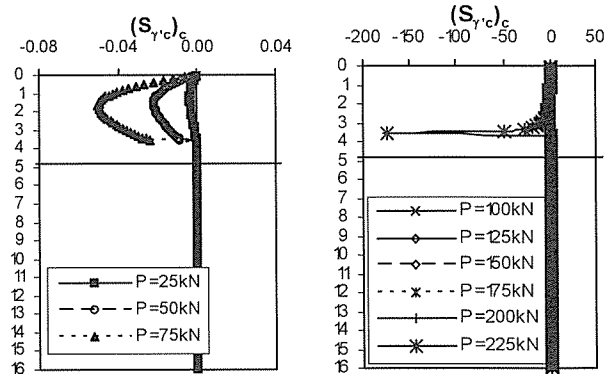

Fig. 10 Distribution of $(S_{\gamma'_c})_c$ for 30% clay

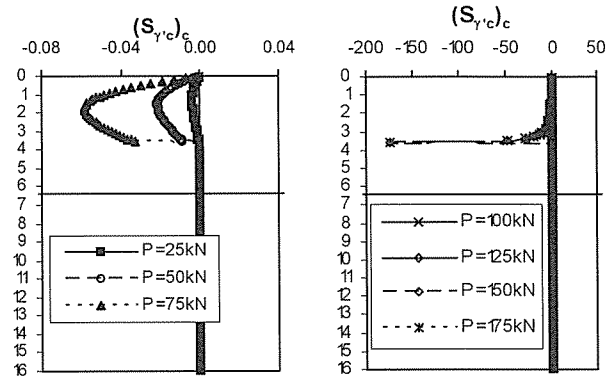

Fig. 11 Distribution of $(S_{\gamma'_c})_c$ for 40% clay

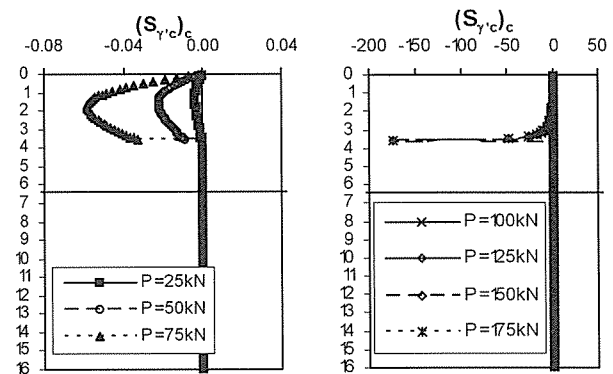

Fig. 12 Distribution of $(S_{\gamma'_c})_c$ for 50% clay

For the distribution of the c operator $(S_c)_c$ (Figs 13 to 17), in the first group, it starts with a high value at the surface and decreases with depth. There is an obvious difference in the features of the curves and values between the first and second group for $(S_c)_c$ and $(S_{\gamma'_c})_c$.

The very high localized values of the sensitivity operators $(S_c)_c$ and $(S_{\gamma'_c})_c$ obtained in the second group of curves for certain thicknesses of clay (30%, 40% and 50%) deserve a note of explanation. The investigated system is complex with respect to physical features and variability of non-homogeneity in geometrical terms. These features directly affect the sensitivity analysis.

The material complexity of p - y clay model governs the classification of the results with respect to the applied load for each particular thickness of the clay layer. The key to suitable interpretation of the sensitivity results is the reference to the p - y curve of soft clay below water table subjected to cyclic loading (Fig. 2).

It is worth noting that for small depth (small thickness of clay layer), the discussed p - y model of clay for $x \leq x_{rc}$ is able to develop three physical phases that is, nonlinear elastic phase, linear softening and plastic flow. However, for very large loads and deformations, when the thickness of clay layer $x > x_{rc}$, only two soil phases are allowed to develop within the soil medium, that is plastic phase followed by nonlinear elastic phase.

These phases are of continuous type however the transition from one phase to another is clearly marked by rapid change of material slopes defining the behavior of clay. These features are of key importance in sensitivity analysis. Consequently, these facts indicate that depending on the thickness of clay layer and the magnitude of the applied load, the sensitivity operators can demonstrate various behaviors depending on how the particular design variable is involved in the physical model of the non-homogeneous system.

For the investigated non-homogeneous system, the most deformable part of pile and the adjacent soft clay can develop on the soil surface. In case of thick clay layer (larger than x_{rc}) as the load increases, the following soft clay phases can develop in ascending order of the applied load: nonlinear elastic, then linear softening (that with depth passes in non-linear elastic phase) and the plastic flow (that with depth is transferred into linear softening and at larger depth it is transferred in nonlinear stage).

In case of very large load applied, linear softening can develop at large depths close to the depth of reduced resistance x_{rc} . Mathematically this means that the softening curve associated with this physical linear softening stage is very flat (very small slope) that approaches almost horizontal plastic flow on p - y curve for $x > x_{rc}$. It is obvious that in this situation the determination of some sensitivity operators for $x \cong x_{rc}$ results in infinite values (singularity) since the p - y relationship in the coordinate system (p/p_{ult}) versus (y/y_{50}) is indefinite (horizontal line independent of y/y_{50}). This explains the dramatic increase in values of some sensitivity operators when the investigations of non-homogeneity are connected with thicker clay layer. It is obvious that in case of thin clay layer, the process of softening is characterized by larger slope on p - y curve (thickness of clay layer is less than the depth of reduced resistance x_{rc}) and large values of sensitivity operators are not able to develop like in case of thick layer.

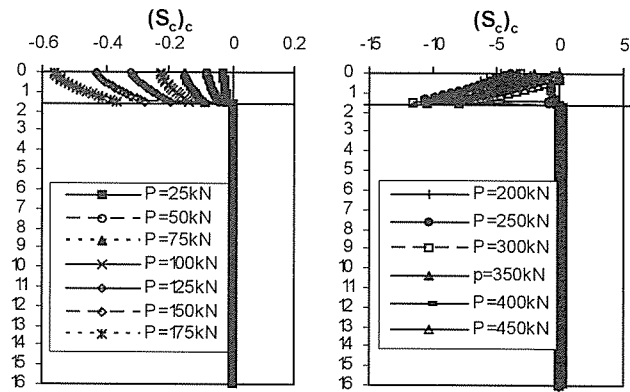

Fig. 13 Distribution of $(S_c)_c$ for 10% clay

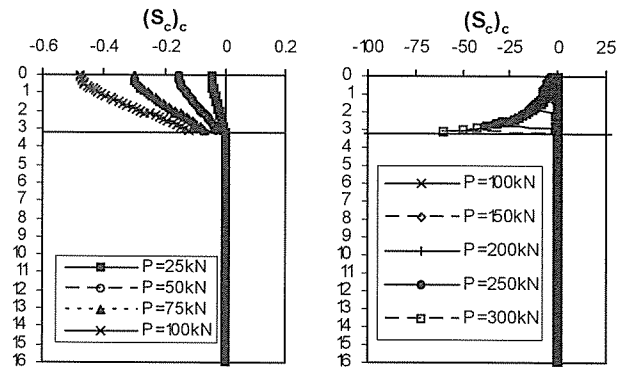

Fig. 14 Distribution of $(S_c)_c$ for 20% clay

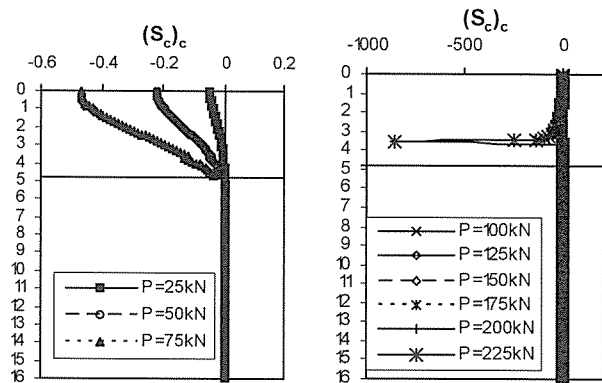

Fig. 15 Distribution of $(S_c)_c$ for 30% clay

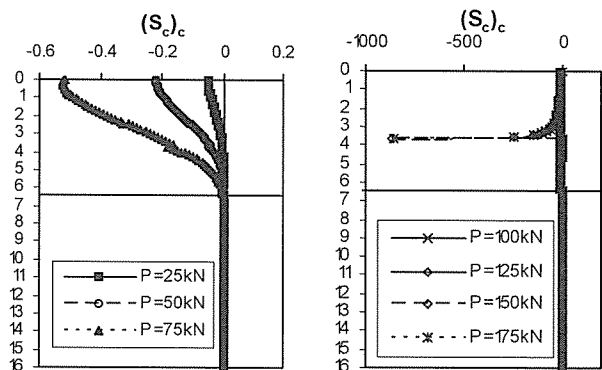

Fig. 16 Distribution of $(S_c)_c$ for 40% clay

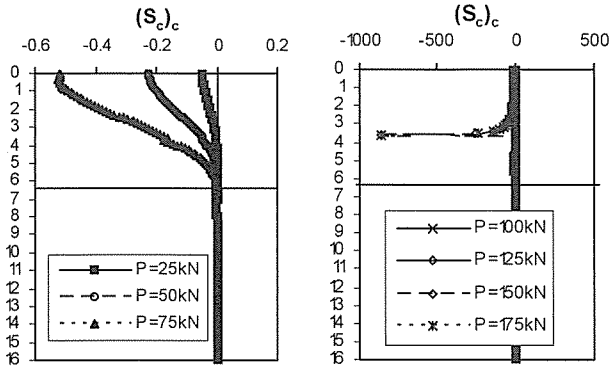

Fig. 17 Distribution of $(S_c)_c$ for 50% clay

In addition, it is observed that the numerical values of $(S_c)_c$ are much higher than those of $(S_{\gamma'_c})_c$. This indicates that the effect of the change of the cohesion c on the lateral head deflection is in general higher than that of the submerged unit weight γ'_c .

Sensitivity to the Variation in Pile Parameters

The sensitivity operators that affect the changes of the pile-head lateral deflection δy_l due to the changes of the normalized design variables EI and b appear in both the clay and sand. The pile diameter b is considered as a design parameter involved in the p - y relationship of clay and also in the p - y sand relationship. The operators for the variable b are different for clay and sand since they depend on the p - y relationships ($S_b = (S_b)_c$ in the clay layer and $S_b = (S_b)_s$ in the sand layer). However, the sensitivity operators for the design variable EI are defined in the same fashion for clay and sand since they are connected with the pile material ($(S_{EI})_c = (S_{EI})_s = S_{EI}$).

The distribution of S_b is given in Figs. 18 to 22. As seen there are values for S_b in both clay and sand. However, the value of S_b is negative in the clay layer and positive in sand. This implies that an increase in the pile diameter in the clay layer will cause a decrease in the lateral pile head deflection while an increase in the pile diameter in the sand layer will cause an increase in the lateral pile head deflection.

The correctness of these results obtained and shown in the figures was checked using the computer program COM 624P with suitably modified input data required for checking procedure. Specifically, it was done by using different values of pile diameter in the clay and sand zones as an input to the program and detecting how this change of diameter values will affect the pile-head deflection results. By increasing the value of b in the clay layer a smaller deflection in the pile head was obtained and by increasing the diameter in the sand a larger value of deflection was obtained at the pile head which verifies the sensitivity results obtained.

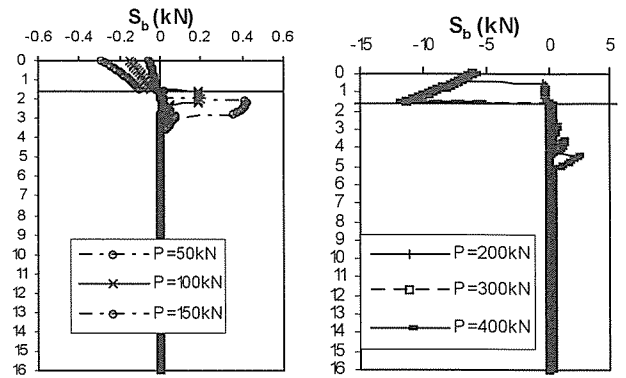

Fig. 18 Distribution of S_b for 10% clay

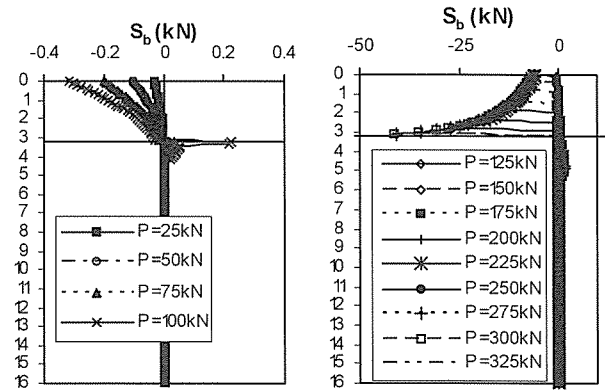

Fig. 19 Distribution of S_b for 20% clay

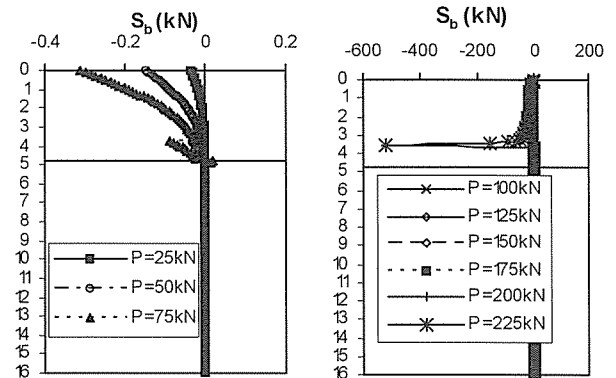

Fig. 20 Distribution of S_b for 30% clay

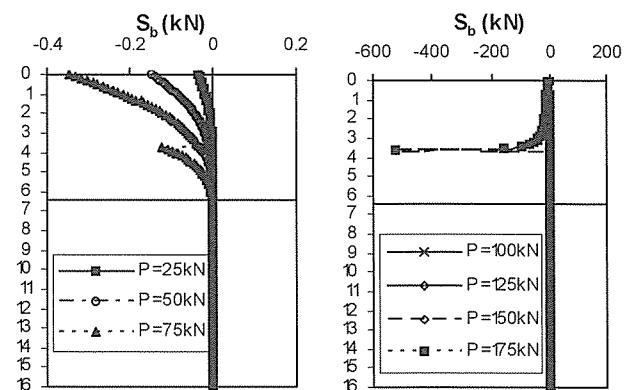

Fig. 21 Distribution of S_b for 40% clay

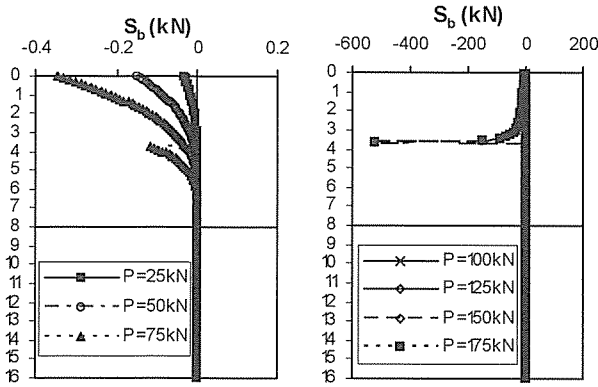

Fig. 22 Distribution of S_b for 50% clay

It was not possible to obtain this information by simply looking at the $p-y$ relationships due to the complexity of the nonlinear $p-y$ models. However it was possible to visualize it using the distributed parameter sensitivity analysis. It is noted that high values for S_b are achieved at high loads when clay thickness exceeds 30% for the same reasons mentioned for $(S_{y'c})_c$, and $(S_c)_c$. In addition as the clay thickness and load increase the values of S_b become relatively small in sand that they are hardly observed.

The sensitivity operator S_{EI} that detects along the pile length the effect of the variation of the pile bending stiffness EI on the variation of the pile-head lateral deflection is plotted for each case of thickness of clay layer in Figs. 23 to 27. The sensitivity operators for the design variable EI are defined in the same fashion for clay and sand since they are associated with the pile material $((S_{EI})_c = (S_{EI})_s = S_{EI})$.

The distribution of S_{EI} depends on the bending moment distribution along the pile length for the primary and adjoint piles. Therefore as seen in the figures the shape of S_{EI} is affected by the bending moment distribution of free head piles. The bending moment distribution of a free head primary pile for one case of thickness (50% clay) is shown in Fig. 28.

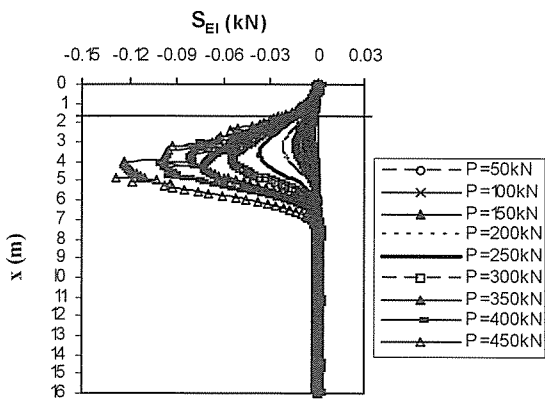

Fig. 23 Distribution of S_{EI} for 10% clay

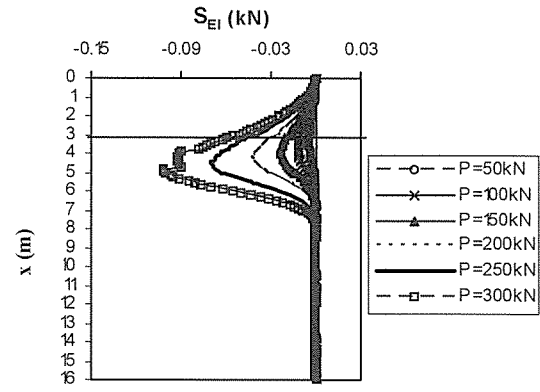

Fig. 24 Distribution of S_{EI} for 20% clay

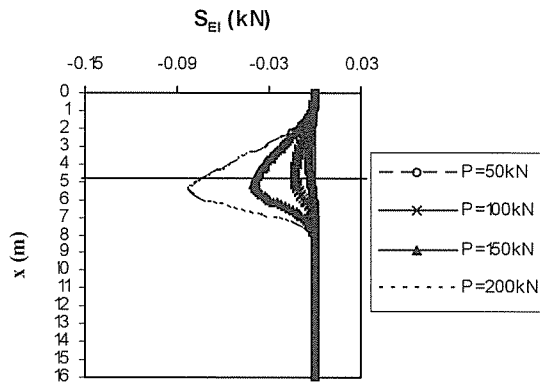

Fig. 25 Distribution of S_{EI} for 30% clay

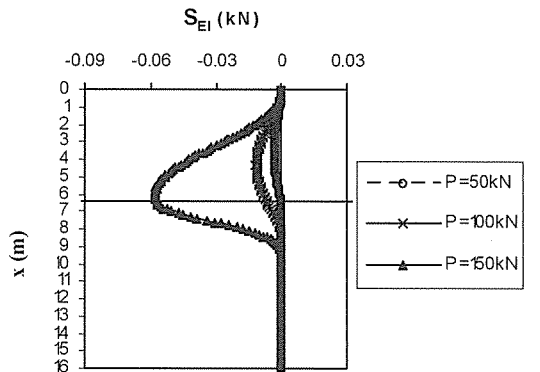

Fig. 26 Distribution of S_{EI} for 40% clay

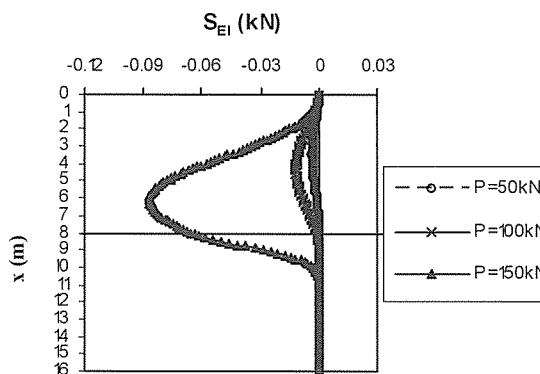

Fig. 27 Distribution of S_{EI} for 50% clay

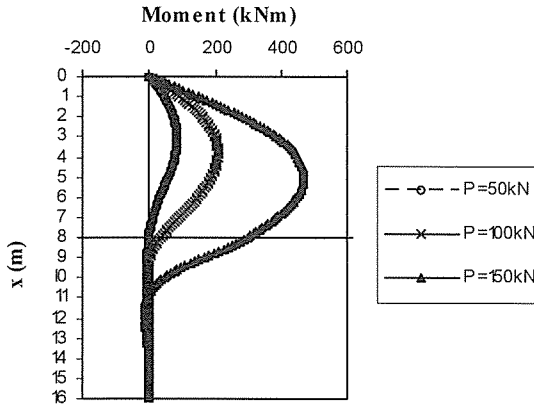

Fig. 28 Bending moment of primary pile for 50% clay

It should be noted that the lack in continuity in some diagrams of S_{EI} (Fig.s 23 and 24) is associated with numerical inaccuracy resulting from the application of very large load to the primary pile combined with unit load applied to the adjoint pile being in the state of deformation of the primary pile.

EFFECT OF THICKNESS OF OVERLYING CLAY ON SENSITIVITY RESULTS

To study the effect of thickness of clay layer on the sensitivity results two approaches are taken. The first approach is to compare the sensitivity results for different thicknesses while the load is kept constant, i.e. load-based comparison. The second approach is to compare the sensitivity results for different thicknesses of clay while the deflection of the pile at the ground surface is kept constant, i.e. deflection-based comparison.

Load-based Comparison

For the first approach, the sensitivity operators $(S_{e50})_c$, $(S_{\gamma'c})_c$, $(S_c)_c$, S_b and S_{EI} are plotted in Fig.s 29 to 33 for different thicknesses of clay when the pile is subjected to a constant load. The constant load was taken equal to 150 kN so that all the clay cases will be included in the comparison. For a constant load, as the thickness of clay increases, the deflection of the pile increases because the soil that supports the pile becomes weaker. This causes the sensitivity of the lateral pile-head deflection to changes in these five parameters to increase, i.e. the sensitivity increases in general.

In addition, as the deflection increases soil experiences linear softening behavior causing the operators to change in magnitude and shape. For $(S_{\gamma'c})_c$, $(S_c)_c$, and S_b , the values for cases 40% and 50% of clay are very close and experience high values as explained above.

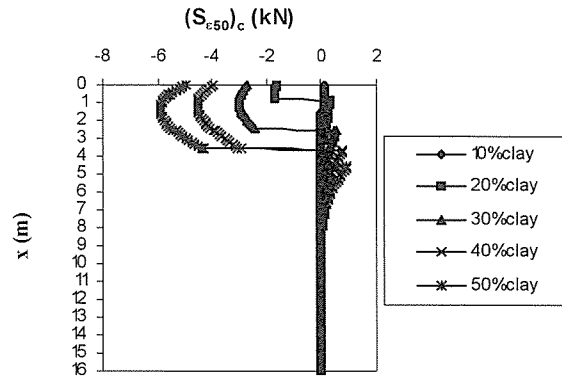

Fig. 29 Effect of clay thickness on $(S_{e50})_c$ at P=150kN

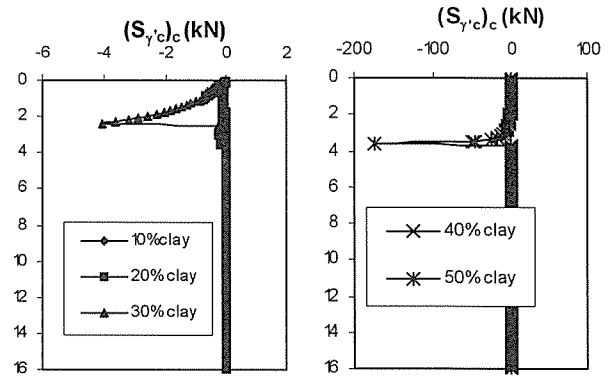

Fig. 30 Effect of clay thickness on $(S_{\gamma'c})_c$ at P=150kN

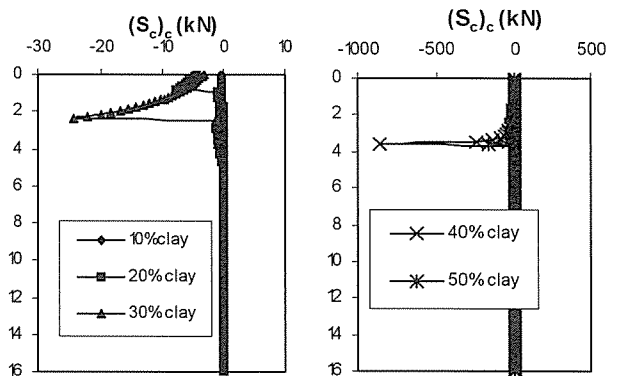

Fig. 31 Effect of clay thickness on $(S_c)_c$ at P=150kN

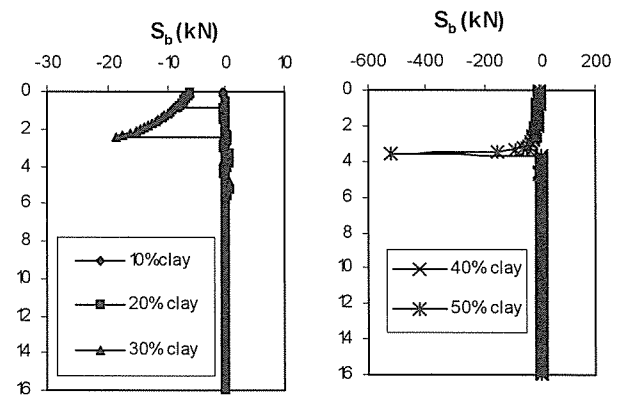

Fig. 32 Effect of clay thickness on S_b at P=150kN

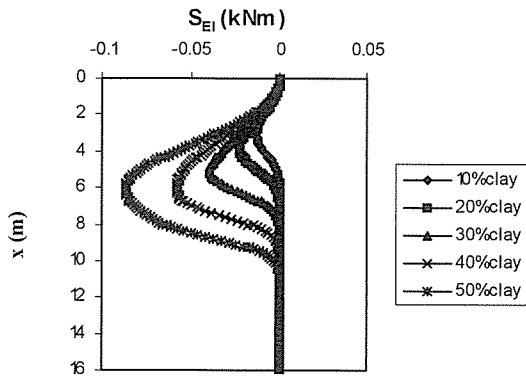

Fig. 33 Effect of clay thickness on S_{EI} at $P=150\text{kN}$

For S_{EI} shown in Fig. 33, the increase in the values of the operator are associated with the increase in the bending moment as mentioned in the previous section.

It is worth noting that the effect of non-homogeneity is not dominating in the case of the clay parameters because the treatment of the clay layer is different than that of sand with regards to the local coordinates since sand was the underlying layer (Georgiadis, 1983).

Deflection-based Comparison

The second approach taken to study the effect of the thickness of overlaying clay layer on the sensitivity results is to investigate this effect while the deflection at the pile head is almost equal for the different cases (please see Table 1 in Part IIA (Hafez and Budkowska)). The sensitivity operators $(S_{e50})_c$, $(S_{\gamma'_c})_c$, $(S_c)_c$, S_b and S_{EI} are plotted in Figs 34 to 38. The results of sensitivity analysis of $(S_{e50})_c$, $(S_{\gamma'_c})_c$, $(S_c)_c$ and S_b based on the constant pile-head deflection criterion can be explained in reference to the p - γ curve presented in Fig. 2.

Constant value of pile-head lateral deflection means that within the soft clay the same phases are developed for various thickness of top clay layer. Consequently, the same physical phases are spread in the soil when the clay thickness increases and require application of smaller lateral load to the pile head. This means that increase of clay layer thickness makes the system more sensitive to the changes of soil parameters associated with these particular soil phases. The p - γ curve relationships shown in Fig. 2 demonstrate that for thicker layer of soft clay the criterion of constant displacement at the top surface means the possibility of development of such a softening state at deeper depth that its behavior is closer and closer to the plastic flow. It is described by almost flat part of p - γ curve characteristic for very softened clay layer.

It is obvious that the pile structure when embedded in sand with small thickness of clay layer is more rigid than

in the case when the top clay layer increases its thickness. This means that increase of thickness of soft clay layer is equivalent to the weakening of pile support in the proximity of the soil surface. The association of constant pile deflection criterion means that the constant value of top displacement of rigid pile results in larger bending moment of pile structure that is developed at smaller depth of the pile. This logic explains why the S_{EI} operators shown in Fig. 38 have higher values when the thicknesses of soft clay layer are small than when the thicknesses of clay layer are large.

Moreover, Figure 38 shows that variability of S_{EI} for small values of thickness of clay layer is spread to smaller depth than for the thicker clay layer. It is shown in the figure that as the thickness increases the maximum value of the operator S_{EI} decreases opposite to the behavior observed for the load-based comparison.

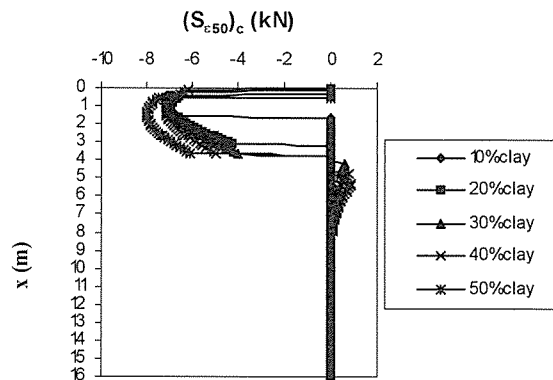

Fig. 34 Effect of clay thickness on $(S_{e50})_c$ for constant deflection criterion

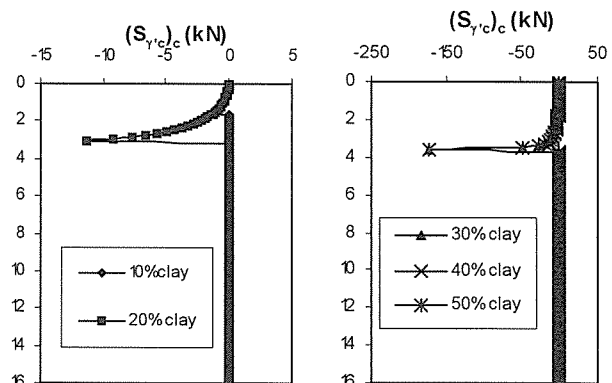

Fig. 35 Effect of clay thickness on $(S_{\gamma'_c})_c$ for constant deflection criterion 50kN

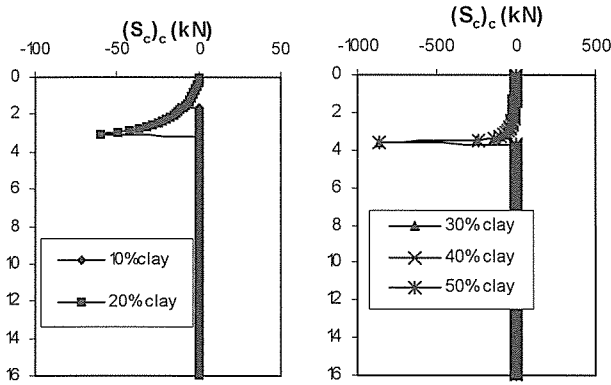

Fig. 36 Effect of clay thickness on $(S_c)_c$ for constant deflection criterion

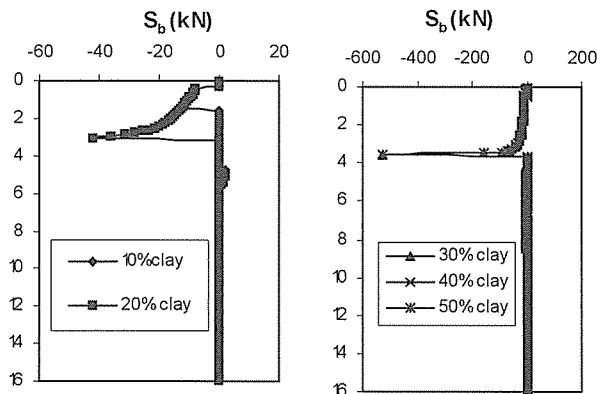

Fig. 37 Effect of clay thickness on S_b for constant deflection criterion

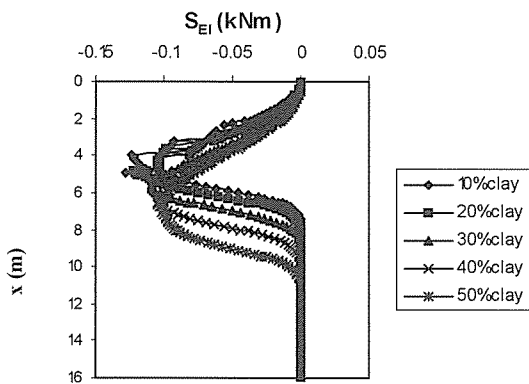

Fig. 38 Effect of clay thickness on S_{EI} for constant deflection criterion

SUMMARY AND CONCLUSIONS

Numerical sensitivity studies were performed in this part of the paper based on the theoretical formulation of sensitivity analysis derived in Part I of the paper (Hafez and Budkowska, 2006a). The paper covered the study of

the effect of the changes of clay and pile parameters on the maximum lateral deflection of long piles subjected to cyclic loading and embedded in non-homogeneous soil consisting of soft clay overlying sand. Due to the nature of the distributed parameter sensitivity analysis of soil-structure systems, the sensitivity results were given in the form of graphical presentation of sensitivity operators that allows the engineer to detect where and how each design variable affects the maximum lateral deflection of the pile. The five design variables studied were the clay parameters (γ'_c , c and ϵ_{50}) and the pile parameters (EI and b).

The investigations of distributed parameter sensitivity of piles embedded in progressively developed non-homogeneous media provide valuable results on the effect of changes of the parameters of the system on the changes of the performance of the pile-soil system. It is worth noting that non-homogeneity of the medium makes the investigations more realistic through the fact that it broadens the range of parameters and reveals these changes that are not available for prediction and detection using standard parametric studies. The investigations conducted show how the various degree of non-homogeneity defined by the varying geometry of each homogeneous component of the soil-system interact with each other and consequently on the structure embedded in the non-homogeneous medium. These two geometrically varying different media demonstrate that the successive development of one homogeneous medium is on the cost of another component medium since the size of the investigated medium is finite.

The systematic investigations of non-homogeneity of p - y type are defined by the geometrical boundaries that describe the physical behavior of each homogeneous component of the investigated medium. This fact when applied to p - y type media in the problem of distributed parameter sensitivity analysis results in geometrical truncation of some specific features of each contributing component from the stand point of distributed parameter sensitivity analysis. This fact has direct effect on the results of distributions of sensitivity operators that can reveal the unknown possibilities that can develop when a homogeneous component of the medium becomes a part of non-homogeneous medium. As far as the specific results are concerned, it is worth noting that:

1. The values of the sensitivity operators for $(S_{\gamma'_c})_c$, $(S_c)_c$, S_b and S_{EI} are negative while they are positive for $(S_{\epsilon_{50}})_c$ since ϵ_{50} is a measure of deformability (opposite to the other variables). However two exceptions were observed based on the model used:
 - The value of $(S_{\epsilon_{50}})_c$ was negative when the soil experienced the linear softening

behavior (stage 2), i.e. as ε_{50} increases the pile lateral head deflection decreases.

- The values of S_b were negative in clay as expected but positive in the sand implying that an increase in b in the sand layer increases the deflection.

The results were verified numerically using the computer code COM624P that uses the p - y relationships for the pile analysis. It was not possible to obtain this information by simply looking at the p - y relationships due to the complexity of the nonlinear p - y models. However it was possible to visualize it using the distributed parameter sensitivity analysis.

2. The sensitivity of lateral head deflection to changes in EI depends on the bending moments of piles.
3. The graphical presentations of the sensitivity operators are given as a guide to engineers to detect critical locations of sensitivity of pile performance to clay and pile parameters and to complement the understanding of the pile-system behavior.

In addition, the effect of thickness of the overlying clay layer on the sensitivity results was explored based on two approaches. The first approach is addressed to engineers interested in studying the effect of evolution of the overlying clay thickness while the pile is subjected to a constant load (i.e. load-based comparison). The second approach addresses engineers interested in understanding the effect of the increase in the thickness of the overlaying clay layer on the sensitivity results while the pile-head deflection is maintained constant (i.e. deflection-based comparison). Based on these approaches, the following conclusions can be drawn;

1. For load-based comparison, the sensitivity of lateral head deflection to changes in the clay and pile parameters increased in general as the thickness of clay layer increased.
2. For the deflection-based comparison, the proper physical interpretation of sensitivity operators for clay requires close reference to p - y relationship of soft clay that defines the softening process in continuously varying way both physically (continuous variability of softening curve) and spatially (continuous dependence with respect to depth variable). The physical interpretation of the distributed parameter sensitivity of the pile structure expressed by S_{EI} is conducted in

reference to the assessment of the stiffness of the pile-soil system when the thickness of soft clay layer is developed.

3. The study of the effect of non-homogeneity of soil presented is of significant importance to areas in which the overlaying soft clay layer is of different thicknesses such as in lowland areas.

ACKNOWLEDGEMENT

The financial support provided by the Natural Sciences and Engineering Research Council of Canada (NSERC) under Award No PGSD2-304496 and Discovery Grant OGP 0110260-05, respectively to both authoresses is greatly acknowledged.

REFERENCES

- Georgiadis, M. (1983). Development of p - y curves for layered soils. Proc. of the Geotechnical Practice in Offshore Eng., ASCE, 536-545.
- Hafez, D. H. and Budkowska, B. B. (2006a). Effect of overlying clay layer of lowland region on sensitivity of lateral deflection of long piles embedded in non-homogeneous soil. Part I: Theoretical formulation. Lowland Technology International Journal, 8(1): 27-36.
- Hafez, D. H. and Budkowska, B. B. (2006b). Effect of overlying clay layer of lowland region on sensitivity of lateral deflection of long piles embedded in non-homogeneous soil. Part IIA: Numerical study of sand parameters. Lowland Technology International Journal, 8(2): 9-20.
- Kleiber, M., Antunez, H., Hien, T. D. and Kowalczyk, P. (1997). Parameter Sensitivity in Nonlinear Mechanics, Theory and Finite Element Computations. John Wiley and Son, New York.
- Matlock, H. (1970). Correlations for design of laterally loaded piles in soft clay. Proc. 2nd Annual Offshore Technology Conference, Houston, Texas, 1, 577-594.
- Reese, L.C., Cox, W.R. and Koop, F.D. (1974). Analysis of laterally loaded piles in sand. Proc. 5th Annual Offshore Technology Conference, Houston, Texas, 2, 473-485.
- Wang and Reese (1993). COM624P-Laterally Loaded Pile Analysis Program for the Microcomputer, Version 2.0. Report FHWA-SA-91-048, Washington, USDT.