

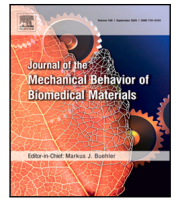

Contents lists available at ScienceDirect

## Journal of the Mechanical Behavior of Biomedical Materials

journal homepage: [www.elsevier.com/locate/jmbbm](http://www.elsevier.com/locate/jmbbm)

Research paper

## Mechanical characteristics of diabetic and non-diabetic plantar skin

Sarah R. Crossland<sup>a,\*</sup>, Francesca Sairally<sup>a</sup>, Jen Edwards<sup>b</sup>, Peter Culmer<sup>a</sup>, Claire L. Brockett<sup>c</sup><sup>a</sup> Department of Mechanical Engineering, University of Leeds, Leeds, UK<sup>b</sup> Faculty of Biological Sciences, University of Leeds, Leeds, UK<sup>c</sup> Insigneo Institute for in silico Medicine, University of Sheffield, Sheffield, UK

## ARTICLE INFO

Dataset link: <https://doi.org/10.5518/1331>

## Keywords:

Diabetes  
Plantar  
Skin  
Strain

## ABSTRACT

Diabetic foot ulceration is linked to high amputation and mortality rates, with the substantial associated annual spend on the at-risk diabetic foot reflecting the intensive time and labour involved in treatment. Assessing plantar interactions and developing improved understanding of the formation pathways of diabetic ulceration is important to orthotic interventions and patient outcomes. Plantar skin surrogates which emulate the mechanical and tribological characteristics can help improve physical models of ulceration, reduce reliance on cadaveric use and inform more complex computational modelling approaches. The information available from existing studies to characterise plantar skin is limited, typically featuring ex-vivo representations of skin and subcutaneous tissue combined and given focus to shear studies with time dependency. The aim of this study is to improve understanding of plantar tissue mechanics by assessing the mechanical characteristics of plantar skin in two groups; (1) non-diabetic and (2) diabetic donors without the subcutaneous tissue attachment of previous work in this field. Digital image correlation was used to assess inherent skin pre-tension of the plantar rearfoot prior to dissection. Young's modulus, storage and loss moduli were tested for using tensile stress-strain failure analysis and tensile and compressive dynamic mechanical analysis, which was conducted on excised plantar rearfoot donor specimens for both disease state cohorts at frequencies reflecting those achieved in activities of daily living. Plantar skin thickness for donor specimens were comparable to values obtained using ultrasound acquired in vivo values. Median tensile storage and loss moduli, along with Young's modulus, was higher in the diabetic cohort. With a mean Young's modulus of  $0.83 \pm 0.49$  MPa and  $1.33 \pm 0.43$  MPa for non-diabetic and diabetic specimens respectively. Compressive studies showed consistency between cohorts for median storage and loss moduli. The outcomes from this study show mechanical characteristics of plantar skin without the involvement of subcutaneous tissues under reflective daily achieved loading regimes, showing differences in the non-diabetic and diabetic specimens trialled to support improved understanding of plantar tissue response under tribological interactions.

## 1. Background

Diabetic foot health is an ever growing research area, mirroring the growth of the global diabetic population (International Diabetes Federation, 2019). The diabetic population is more at risk of amputation than the general global population (Moxey et al., 2011), with the number of diabetes related major lower limb amputations reaching nearly 8000 in England alone between 2017 and 2020 (for Health Improvement & Disparities, 2022). This correlates with data that shows the risk of mortality within five year of a diabetic foot ulcer (DFU) is 40% (Jupiter et al., 2016), rising following a major lower limb amputation to around 79% (Icks et al., 2011; Ikonen et al., 2010). In the UK alone, the annual spend on diabetic foot intervention and treatment totals to over £900 million (Kerr et al., 2019), making the care of this diabetic patient subset both costly financially and in terms of labour resources also.

Prediction of DFU formation, through assessment techniques to allow for the use of prophylactic interventions, is a focus of much of the research surrounding the diabetic foot. Although the contribution of shear in the mechanical formation of DFU is considered, it has often been overlooked in assessment methods in favour of pressure solely due to the availability of technology to capture the relevant metrics (Yavuz et al., 2007b,a, 2008; Jones et al., 2022). Research to investigate the contribution of shear in the interaction of the plantar surface has emerged in recent years due to the improved technology capabilities (Rajala and Leikkala, 2014; Lord and Hosein, 2000; Jones et al., 2022) and supports the vast body of pressure data already accumulated. Whilst the understanding of plantar skin in vivo surface response to shear and pressure is progressing, the need for translation and comprehension of the effect of these normal and tangential forces

\* Corresponding author.

E-mail address: [s.crossland@mmu.ac.uk](mailto:s.crossland@mmu.ac.uk) (S.R. Crossland).<https://doi.org/10.1016/j.jmbbm.2023.106279>

Received 19 May 2023; Received in revised form 28 June 2023; Accepted 23 November 2023

Available online 24 November 2023

1751-6161/© 2023 The Authors. Published by Elsevier Ltd. This is an open access article under the CC BY license (<http://creativecommons.org/licenses/by/4.0/>).

on the subcutaneous tissues is required to underpin DFU formation mechanics and is an emerging focus for researchers (Pai and Ledoux, 2012). Current studies of plantar tissue mechanical characteristics are often centred on compressive shear studies mimicking direct plantar interactions (Cheung et al., 2006; Gefen et al., 2001; Hsu et al., 2009, 2007, 2002, 2000; Klaesner et al., 2002; Piaggesi et al., 1999), using bulk property approaches to characterising the soft plantar tissues during mechanical testing approaches (Chatzistergos et al., 2014, 2022; Chen et al., 2010; Kwan et al., 2010). The need to isolate the interacting layers to define specific properties will support the development of more complex surrogate and finite element model methods and provide a basis for the development of treatment approaches for the at-risk diabetic foot.

Assessment of plantar skin thickness and stiffness between non-diabetic and diabetic cohorts has been studied using a range of in vivo and ex vivo approaches to begin to characterise the soft tissue response. Ultrasonography measurements have long been used to assess skin thickness in research and have been used to reveal the presence of increased skin thickness in the diabetic population (Huntley and Walter, 1990), with improvements to ultrasound diagnostic tools it has developed into a key in vivo assessment approach. Outcomes from using these techniques with diabetic populations show thickening to the stratum corneum, increases in total thickness of plantar soft tissues, alongside epidermal thickness reduction in ulcerative and neuropathic groups (Hashmi et al., 2006; Chao et al., 2011). The plantar heel pad has been investigated to assess biomechanical properties at this subcutaneous layer utilising ultrasound. The heel pad superficial layer microchambers were seen to show decreased stiffness in diabetic populations compared to increased stiffness in the deep macrochamber layer, compared to healthy controls, which may lead to the decreased cushioning capacity seen in the diabetic foot (Hsu et al., 2009). The same methods have shown plantar skin thickness of the heel to range from  $2.34 \pm 0.33$  mm to  $2.86 \pm 0.40$  mm (2.s.f) dependent on disease state and study (Chao et al., 2011; Morrison et al., 2021). In contrast, ex vivo histomorphological measurements have estimated plantar skin thickness to be closer to  $2.06 \pm 0.66$  mm, but showing a 0.2 mm approximate increase in thickness than non-diabetic samples (Wang et al., 2011), and shown lower elastin content in diabetic calcaneal tissue in comparison (Wang et al., 2017). Other studies using the same techniques found an a 1.70 mm (2.d.p) calcaneal skin thickness averaged across both disease states (Brady et al., 2021).

Whilst in vivo studies enable an understanding of the in-situ tissue response to mechanical loading, they are limited by the ability to recreate realistic loading patterns in both normal and tangential applied forces. The benefit of in vivo approaches are that functional tissue data can be obtained and used as a reference for ex vivo and in vitro studies. Existing ex vivo studies enable replicative pressures and strains to be applied to the tissue as seen at the plantar interface, but lack any representation of the foot's underlying anatomy provided to the tissue in vivo. Alternatively, in vitro assessments enable the replication of some in vivo characteristics, such as temperature or humidity, but the structural tissue limitations of ex vivo assessment and is often chosen to support histological characterisation (Pai and Ledoux, 2012; Brady et al., 2021). Alongside a focus on compressive and shear responses, research is limited in reflection of the frequency of loading, instead opting to assess characteristics over a set time period due to the soft tissue non-linear behaviour.

Understanding the tribological interface and mechanical characteristics of plantar skin is fundamental in developing improved skin surrogates. Current skin surrogates are often developed for use with a singular or limited range of use in mind (Bostan et al., 2016; Nachman and Franklin, 2016), such as to test the skin care industry, or for use in surgical simulations and thus often neglect the plantar aspect of the foot or provide simplified mechanical properties (Singh et al., 2022). Chanda (2018) recognised this need and have begun to develop elastomer surrogates alongside the development of calcaneal fat pad

surrogates (Chanda and McClain, 2019) but plantar skin surrogate development is still under-served. The development of surrogates to recreate mechanical characteristics of skin and underlying tissue of the plantar foot allows for biofidelic test bed creation. Utilising biofidelic test beds as a testing protocol enables the reduction in use of cadaveric tissue and allows for recreation of in vivo loading regimes without the difficulty in measurement brought about by direct measurements whilst also reducing ethical requirements and participant recruitment (Carré, 2021). Further understanding of the plantar soft tissue responses during activities of daily through simulated interactions, may lead to improved understanding of DFU formation pathways and allow for testing of existing and new treatment modalities.

Diabetic foot ulcers have complex etiology involving with both skin and subcutaneous tissue involvement in their mechanical formation. With the plantar skin interface being the focus of the interaction of the diabetic foot with its external surroundings, the skin has been selected as the primary focus for the scope of this study to better understand the mechanical characteristics for both diabetic and non-diabetic skin and address the research gap in this area. The need to characterise plantar skin mechanical characteristics under tensile and compressive loading independently of subcutaneous tissues is clear. Plantar skin undergoes both normal pressure and shear forces during daily interactions, this paper assesses the mechanical characteristics of ex vivo cadaveric plantar skin under tensile and compressive dynamic mechanical analysis (DMA), alongside tensile stress-strain failure analysis to reflect these forces and to characterise the role each makes to the skin response. Testing was conducted at representative walking and running frequencies for both diabetic and non-diabetic specimens to inform future physical models for biofidelic testing.

## 2. Methods

The study used a range of non-diabetic and diabetic cadaveric foot specimens from donors through a certified human tissue service [Med-Cure Inc., Orlando, USA]. Ethics were obtained via the University of Leeds MaPS and Engineering joint Faculty Research Ethics Committee (MEEC FREC) under ethics reference MEEC 18-040. Either left or right foot were taken without specificity from the individual donors based on the availability of donor tissue for use. Five non-diabetic donors and two diabetic donors being used to create six and three individual test specimens respectively. The sample size was determined by the availability of cadaveric donor tissue. The plantar surface was assessed prior to selection of the tissue to ensure that the presence of any skin defect, such as significant bruising or callousing, was not present across all specimens. Due to tissues being obtained post-mortem, no data was available on the duration of diabetes in the diabetic donors used within the study. A two-sample t-test was used to compare the relevant metrics between the non-diabetic and diabetic groups.

### 2.1. DIC skin pre-tension analysis

To support tensile mechanical testing, an understanding of initial tension to apply to the sample prior to data collection is required. Digital image correlation (DIC) was employed as a technique to assess the inherent pre-tension of the skin prior to excision from the cadaveric foot. Digital image correlation uses computer vision techniques to track positional changes of an applied stochastic speckle pattern during strain events (Michael et al., 2009a). A computer generated pattern, previously optimised for use in plantar strain tracking (Jones et al., 2023), was created with 0.8 mm speckles, 65% density and 75% variance [Speckle Generator, Correlated Solutions Inc.] and applied to an adhesive thin film of 0.18 mm thickness [Temporary Tattoo Paper Clear, Silhouette America Inc.].

The thin film speckle pattern sheet was adhered with a water application to the plantar rearfoot of each cadaveric donor prior to dissection of the specimen samples for mechanical testing (Fig. 1).

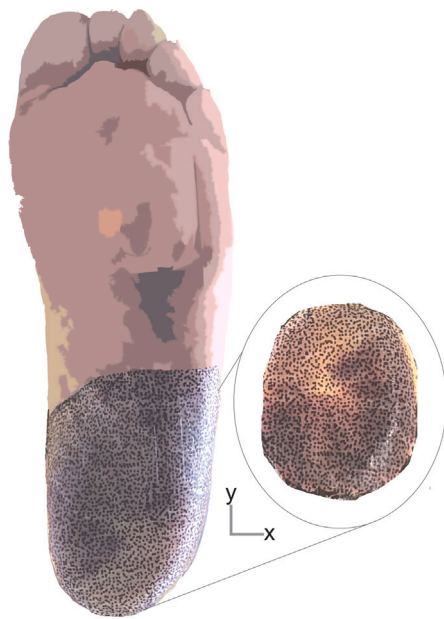

**Fig. 1.** Placement of the thin film DIC layer as applied to the plantar rearfoot of the cadaveric feet used within the study. The call-out shows the excised portion of the skin used for post analysis of strain changes using DIC.

The plantar aspect was positioned on a suspended glass plate using a 12 MP camera capturing a 2208 x 944 pixel image. Single camera calibration via a multi-image checkerboard process was undertaken to determine corrected image size and remove lens distortion [MATLAB, R2021a] (Michael et al., 2009b). An initial reference image was taken of the intact defrosted cadaveric foot and attached speckle distribution. Following dissection of the rearfoot plantar skin a second image was captured in the same orientation to track pattern changes caused from dissection, as seen in Fig. 1. GOM Correlate [2019] software was used to apply an equidistant 1 mm data point spread across the DIC component to extract positional and strain values for exportation to MATLAB [R2012a] for further analysis. Masking was applied to select the outer boundary of the excised plantar region and a corresponding inner boundary of non-determinant values, sized proportionally with growth of the outer boundary. The inner boundary reflects a central region of the tissue less likely to show edge effects formed from shape changes due to the tissue dissection process.

## 2.2. Specimen sample preparation

Cadaveric feet were stored at  $-80^{\circ}\text{C}$  before being defrosted within storage bags in a waterbath until the plantar aspect was thawed, prior to the application of the speckle pattern for DIC analysis. Dissection of the rearfoot plantar skin was conducted to remove the skin from the underlying subcutaneous tissue and extract an area covering the calcaneal region. Post DIC analysis, the excised plantar skin samples were bagged and frozen at  $-40^{\circ}\text{C}$ .

Prior to mechanical characterisation testing the skin was thawed for 20 min at room temperature. Dissection of the calcaneal sample was then completed to create tensile and compressive testing specimens (Fig. 2). Compressive specimens consisted of three cored 10 mm diameter samples taken from the posterior calcaneal region. Six samples were obtained for tensile testing in the form of 5 mm x 40 mm strips, aligned contiguously in the anterior-posterior direction of the foot (Fig. 2), in line with the direction of progression during gait and perpendicular to the langer lines of the foot. Strips were taken in lieu of 'dog-bone' samples due to limited availability of tissue from which to excise all samples. Samples were then stored in PBS solution prior

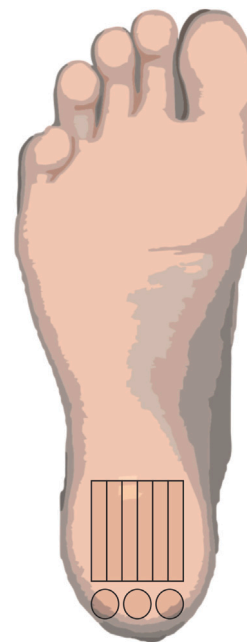

**Fig. 2.** Location and orientation of the excised samples for tensile and compression testing. Tensile samples shown in the anterior-posterior direction. Compression samples shown taken from the posterior heel.

to immediate mechanical testing to preserve tissue hydration. Testing of the tissue specimens was conducted immediately following sample preparation to reduce time of exposure to room temperature conditions and reduce potential for drying, from initial to final test, this time was approximately 1 h 30 min. Sample thicknesses were measured using a digital thickness gauge [J-40 Series, Schmidt control instruments] to 2 d.p. for all excised specimens and reported in Table 1.

## 2.3. Cadaveric tensile testing

A universal load tester [ElectroForce<sup>®</sup> BioDynamic<sup>®</sup> 5110, TA Instruments<sup>®</sup>] was used in tensile testing, equipped with serrated tissue clamps (Fig. 3) Spacing was configured to allow 20 mm of visible sample length between the clamps. Tensile studies were conducted for both DMA and stress-strain testing to mechanical failure. Three excised samples were used for conducting DMA studies and three utilised for stress-strain testing. Specimen thickness was measured with a digital thickness gauge [J-40 Series, Schmidt control instruments] and reported in Table 1.

Specimen measurements were input in the software prior to running each test as required [WinTest<sup>®</sup>, TA Instruments<sup>®</sup>]. For DMA an initial pre-load tension of 0.1 N was applied in line with Chanda (2018) to reduce any sample slack and reflective of the pre-tension of the skin prior to dissection. Tests were conducted to apply 4% strain to the sample inline with averaged strain values obtained from in-vivo plantar strain DIC testing at a normal walking pace of 1.25 m/s (Crossland et al., 2023; Segal et al., 2004). Each sample was initially pre-conditioned at a frequency of loading at 1 Hz and recorded from 1.2 Hz to 3 Hz in 0.2 Hz increments. The initial frequency steps align well with stance phases at slow walking speeds, building to brisk walking and running frequencies of stance phase loading during gait (Crossland et al., 2023; Segal et al., 2004). The storage ( $E'$ ) and loss modulus ( $E''$ ) were recorded alongside  $\delta$  ( $E''/E'$ ) for each frequency increment.

Stress-strain response was conducted at a rate of 0.24 mm/s, reflecting a strain rate of  $0.012\text{ s}^{-1}$  for the visible specimen length as used by NíAnnaidh et al. (2012), and continued until failure of the sample. Software, developed specifically for soft tissue analysis, was used to

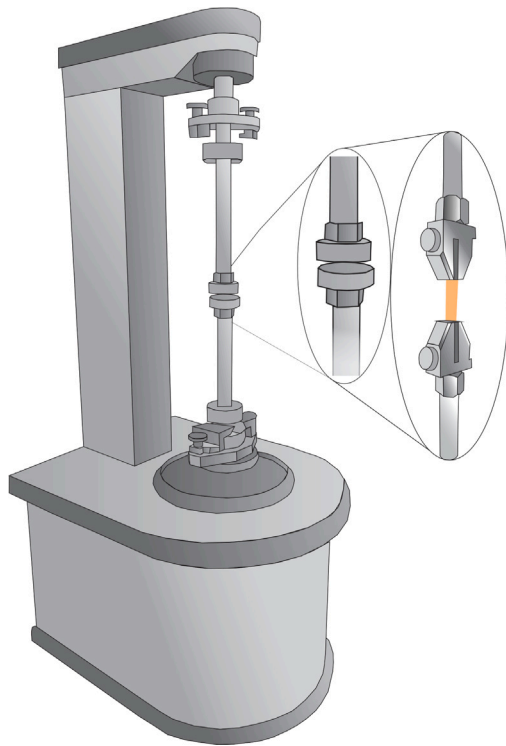

Fig. 3. Configuration of the universal load testing equipment used in both tensile and compression testing with call-out showing the compression plate arrangement and tensile clamp positioning alternative [ElectroForce® BioDynamic® 5110, TA Instruments®].

determine the mechanical characteristics of the plantar skin specimens from the output stress–strain curve data [Dots-on-plots™, Boise State University, USA]. The Young’s Modulus of each specimen was reported alongside the transition, yield and ultimate stress and strain value, where default settings were used with the transition point considered to be 2% below the inflection point of the stress deviation from the linear fit and the yield point 0% above the inflection point.

#### 2.4. Cadaveric compression testing

The universal load tester with 220 N load cell with compression plate adaptations attached [ElectroForce® BioDynamic® 5110, TA Instruments®], see Fig. 3, was employed alongside software for dynamic mechanical analysis (DMA) compressive testing [WinTest®, TA Instruments®]. Compliance compensation stiffness testing of the set-up was conducted. Samples were loaded centrally between the compressive plates and an initial compression of 0.1 N loaded onto each sample following the protocol of [Pai and Ledoux \(2010\)](#) and to reflect the pre-tension of the skin prior to dissection. Specimen measurements were recorded on the DMA software prior to running each test. Three cored 10 mm diameter samples were taken from each donor for repeat testing.

Non-diabetic donor specimen samples were loaded to 20 N and diabetic samples were loaded to 30 N for DMA analysis in line with approximate cross-sectional area average peak pressure loading for plantar tissue determined by [Brady et al. \(2021\)](#). Each sample was initially pre-conditioned at a frequency of loading at 1 Hz and recorded from 1 factors which influence thi.2 Hz to 3 Hz in 0.2 Hz increments in replication of tensile DMA stages. The storage ( $E'$ ) and loss modulus ( $E''$ ) were recorded alongside  $\tan \delta$  ( $E''/E'$ ) for each frequency increment.

Table 1

Characteristics of the cadaveric donors and sample specimens showing Mean [SE] values.

	Non-diabetic	Diabetic	p
Number of donors (n)	5	2	–
Donor Age (years)	75 [3]	64 [4]	0.12
Donor Weight (kg)	67 [3]	114 [4]	0.00*
Gender ratio (M:F)	3:2	1:0	–
Number of specimens (n)	6	3	–
Left and right ratio (L:R)	1:5	1:2	–
Tensile sample thickness (mm)	2.90 [0.10]	3.13 [0.13]	0.17
Compressive sample thickness (mm)	2.79 [0.13]	3.30 [0.25]	0.06

\* p < 0.05 two-sample t-test.

Table 2

DIC output data showing Mean [SD] strain values ( $S_{mag}$ ,  $S_x$ ,  $S_y$ ) for four non-diabetic and two diabetic rearfoot plantar skin samples tracked upon excision.

		Non-diabetic	Diabetic	p	Combined
Outer boundary	$S_{mag}$ Mean	6.77 [8.03]	4.80 [5.00]	0.31	5.99 [7.05]
	$S_x$ Mean	1.56 [8.98]	0.65 [5.91]	0.36	1.20 [7.92]
	$S_y$ Mean	–1.36 [5.06]	–1.63 [3.18]	0.76	–1.47 [4.41]
Central boundary	$S_{mag}$ Mean	2.73 [1.72]	1.67 [1.96]	0.87	2.31 [1.76]
	$S_x$ Mean	–1.55 [2.12]	–0.20 [2.17]	0.48	–1.01 [2.06]
	$S_y$ Mean	–0.42 [1.85]	0.36 [2.35]	0.35	–0.11 [1.98]

\* p < 0.05 two-sample t-test.

### 3. Results

Table 1 shows the characteristics of the donors and the test specimens generated. Both the non-diabetic and diabetic group feature a donor with both left and right feet used as individual specimens, with this reflected in the number of donors, gender ratio, donor age and weight categories.

#### 3.1. DIC skin pre-tension analysis

Successful DIC tracking was achieved for 4/6 non-diabetic and 2/3 diabetic plantar specimens. In the remaining 2 non-diabetic and 1 diabetic cases, DIC analysis could not be performed due to misaligned sample positioning between pre and post dissection images. Table 2 shows the mean strain values and standard deviations determined from DIC analysis for both the non-diabetic and diabetic cohort and combined as a singular group. The applied central and outer boundaries referred to in Table 2 can be seen in Fig. 4, which shows an example of the strain ‘heatmap’ outputs generated for an individual plantar specimen. Central boundary values are chosen to reflect consistent equivalent positions of reference between specimens for assessment. The low values strain values seen for  $S_{mag}$  for both cohorts with relatively high standard deviations show a low strain that can be considered negligible in relation to any inherent pre-tension in the skin prior to dissection.

#### 3.2. Tensile mechanical properties

Results from tensile testing were plotted to show the individual specimen figures showing the mean storage modulus, loss modulus and  $\tan \delta$  alongside shaded errors depicting standard deviation for the three repeat trials. Fig. 5 shows the combined means and associated standard deviations for the two cohorts. Fig. 6 shows the distribution of the storage and loss moduli and  $\tan \delta$  for both disease states with a greater number of data outliers in the non-diabetic cohort than the diabetic cohort, with a similar distribution of values around the median. For non-diabetic data plateauing of the storage and loss moduli median is seen to occur at around 2 to 3 Hz. In comparison to the non-diabetic group, the diabetic results show a tempered plateauing of the median occurring later at approximately 2.6–3 Hz for both the storage and loss

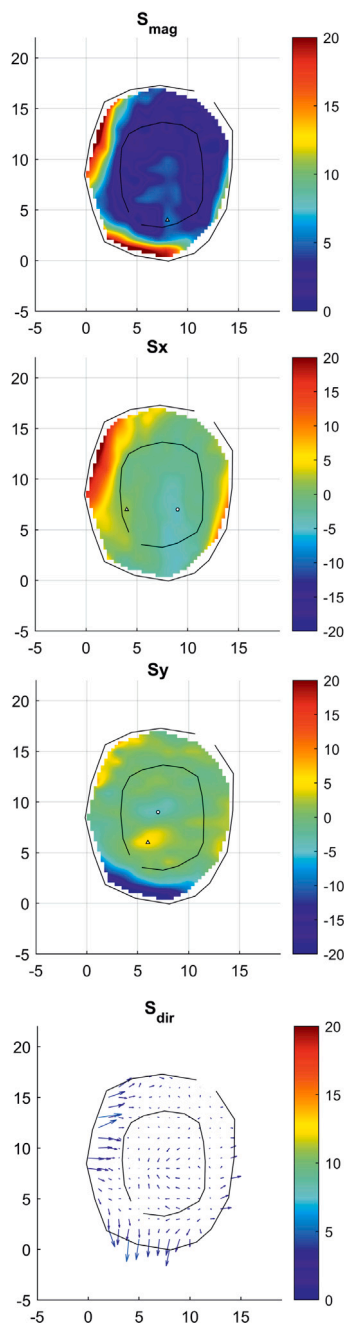

Fig. 4. Example of a typical strain profile for one excised plantar skin specimen displayed as a heat map showing applied outer and central boundaries for  $S_{mag}$ ,  $S_x$ ,  $S_y$  and  $S_{dir}$  (quiver plot).

moduli, with relatively higher achieved final values. The difference in sample size should be considered in reflection to these outcomes.

Table 3 presents the tensile characteristics from stress–strain failure testing. A two-sample paired t-test shows significance in the larger Young’s modulus for the diabetic cohort, albeit with a small sample size limiting the implication of this.

### 3.3. Compressive mechanical properties

Compressive DMA output figures were generated in line with the tensile testing approach. Fig. 7 shows the per specimen and combined cohort means and associated standard deviations for the storage modulus, loss modulus and  $\tan \delta$  values in relation to the increasing

frequency. Fig. 8 presents boxplots of the combined cohort characteristics for compressive storage and loss moduli and  $\tan \delta$ , showing greater variability in non-diabetic cohort, but increased consistency in median value growth with frequency comparative to the tensile outcomes for both cohorts. Plateauing of the storage and loss moduli are not seen in the compressive analysis, as with the tensile DMA, with minimally increased values achieved for the diabetic cohort in relation to the non-diabetic cohort.

## 4. Discussion

Donor weight was higher in the diabetic cohort reflecting group dynamics in the study of Brady et al. (2021), with a non significant increase in tensile and compressive sample thickness seen also. Specimen sample thickness measured in this study is comparable to in vivo non-compressive plantar skin thickness determined by Morrison et al. (2021), but thicker than seen in ex vivo techniques employed by Wang et al. (2011), Wang et al. (2017) and Brady et al. (2021). Alternative measurements of stained tissue using an optical measurement approach have been applied previously to find values of calcaneal and plantar skin thickness of between 1.70 and 2.06 mm (2.d.p), not congruent with the physical measurements determined by this study (Wang et al., 2011, 2017; Brady et al., 2021). Whilst this technique was outside the scope of this study, the variance between values achieved utilising different measurement techniques and states should be investigated further.

Employing DIC to determine the surface strain response of skin is an effective technique to generate high resolution tissue characteristics. Reference images for DIC analysis are traditionally obtained from the initial frame of the video prior to collection of the remaining frames. In this instance the reference image is obtained from the whole foot with the comparative image collected once dissection has occurred. This is a source of potential tracking issues due to misalignment of the specimen with the original positioning of the reference image. This is the most likely cause of failure in this applied DIC process, leading to only 4/6 and 2/3 non-diabetic and diabetic specimens tracking. To reduce the likelihood of this a marked position on the glass was determined to place the excised sample, but slight rotational changes can lead to complete loss of tracking as seen in some specimen tracking in this study.

The region between the outer and central boundary, depicted in the example Fig. 4, shows higher values of strain than within the central boundary consistently (Table 2). Factors which influence this value include the positioning of the sample on the glass post-dissection. It is postulated that some adhesion of the tissue to the glass surface occurs, creating a faux strain region at the tissue edges in particular during alignment (Derler et al., 2009). Strain at the outer boundary is also thought to be higher than the central region due to shape changes to the tissue upon dissection. The central region was established to account for these edge effects and focuses on a comparative sample across the specimens. Whilst glass refraction is present, it is accounted for due to the pre and post dissection images being taken under the same conditions in contact with the glass. The combined mean  $S_{mag}$  value,  $2.31 \pm 1.767$ , for central boundary can be considered to be the closest representation to pre-tension of plantar calcaneal skin. This low value of strain and discussed method errors, support an outcome of negligible strain and implied minimal skin pre-tension prior to dissection. This supports the standard applied pre-tensions used in the tensile and compressive testing derived from literature (Chanda, 2018; Pai and Ledoux, 2010).

Tensile stress–strain failure testing provided a relatively low Young’s modulus in comparison to other in vitro derived values for the skin across a range of sites and testing modalities, but not disproportional to in vivo response results (NíAnnaidh et al., 2012). NíAnnaidh et al. (2012) study of the effect of orientation on mechanical characteristics of excised back skin shows that at 90° orientation to the larger lines

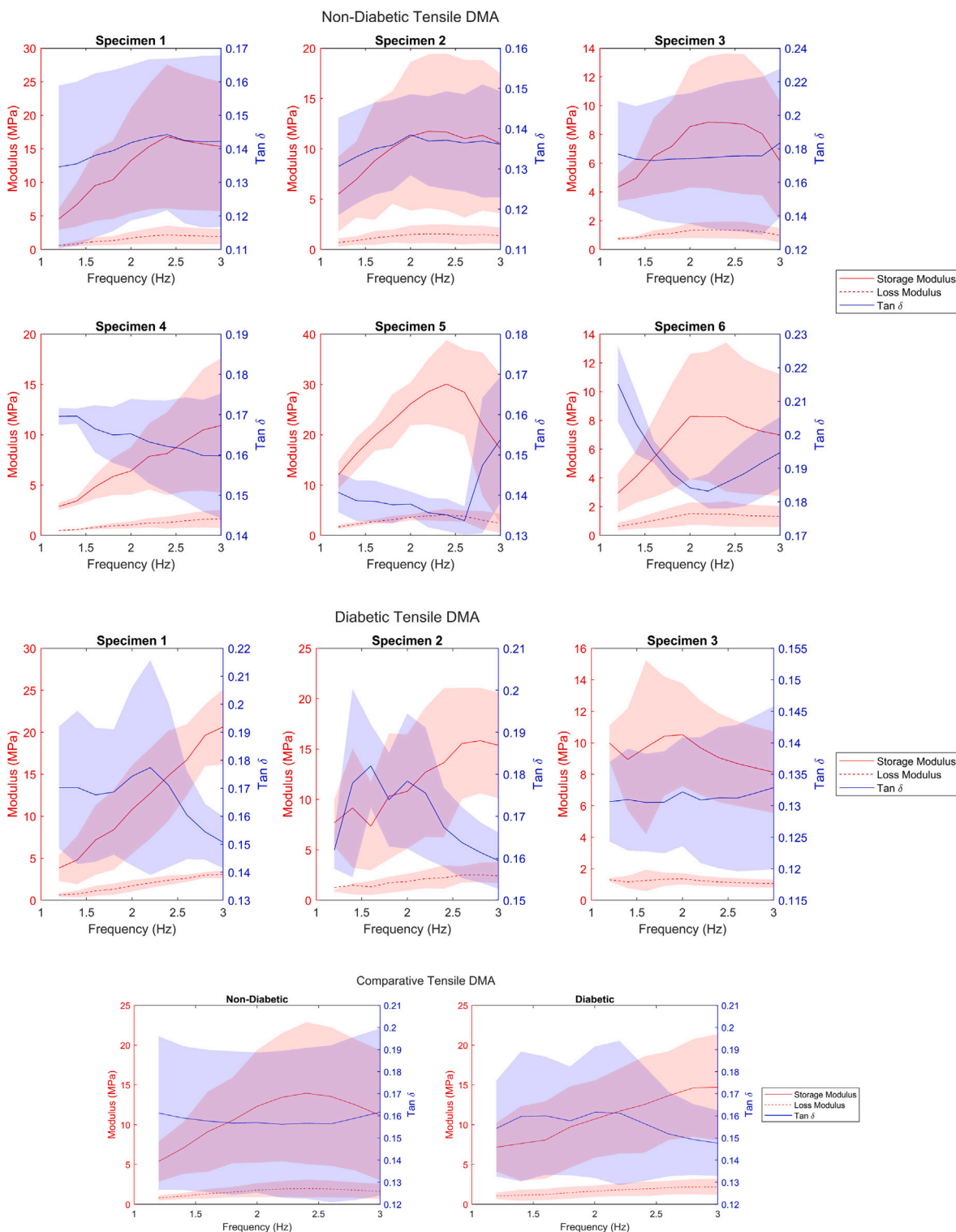

Fig. 5. Tensile DMA analysis outputs showing storage modulus, loss modulus and tan  $\delta$  mean and standard deviation for each non-diabetic and diabetic plantar skin specimen.

exhibits lower Young’s modulus, which is congruent with the specimens excised in this study in the anterior–posterior direction on the plantar aspect. Differences in plantar skin to other skin sites, including increased skin thickness (Huntley and Walter, 1990; Hashmi et al., 2006; Chao et al., 2011), lead to differing mechanical characteristics and Young’s moduli. The higher Young’s modulus of the diabetic cohort reflects the expected soft tissue changes of increased thickness and stiffness of the tissue comparative to non-diabetic specimens (Huntley and Walter, 1990; Hashmi et al., 2006; Chao et al., 2011). Pawlaczyk

et al. (2013) report the linear increase of Young’s modulus of the skin with age, but with a higher value seen in the younger donor diabetic population it, it can be postulated that diabetic skin changes influence stress–strain plantar skin response.

Storage modulus reflects stiffness changes with load applied to the tissue, Wang et al. (2017) reports of reduced elastin content in diabetic plantar tissue and combined with expected comparative stiffness increases to the tissue (Hsu et al., 2009), meant that the higher storage modulus achieved in the diabetic tensile DMA testing was unexpected

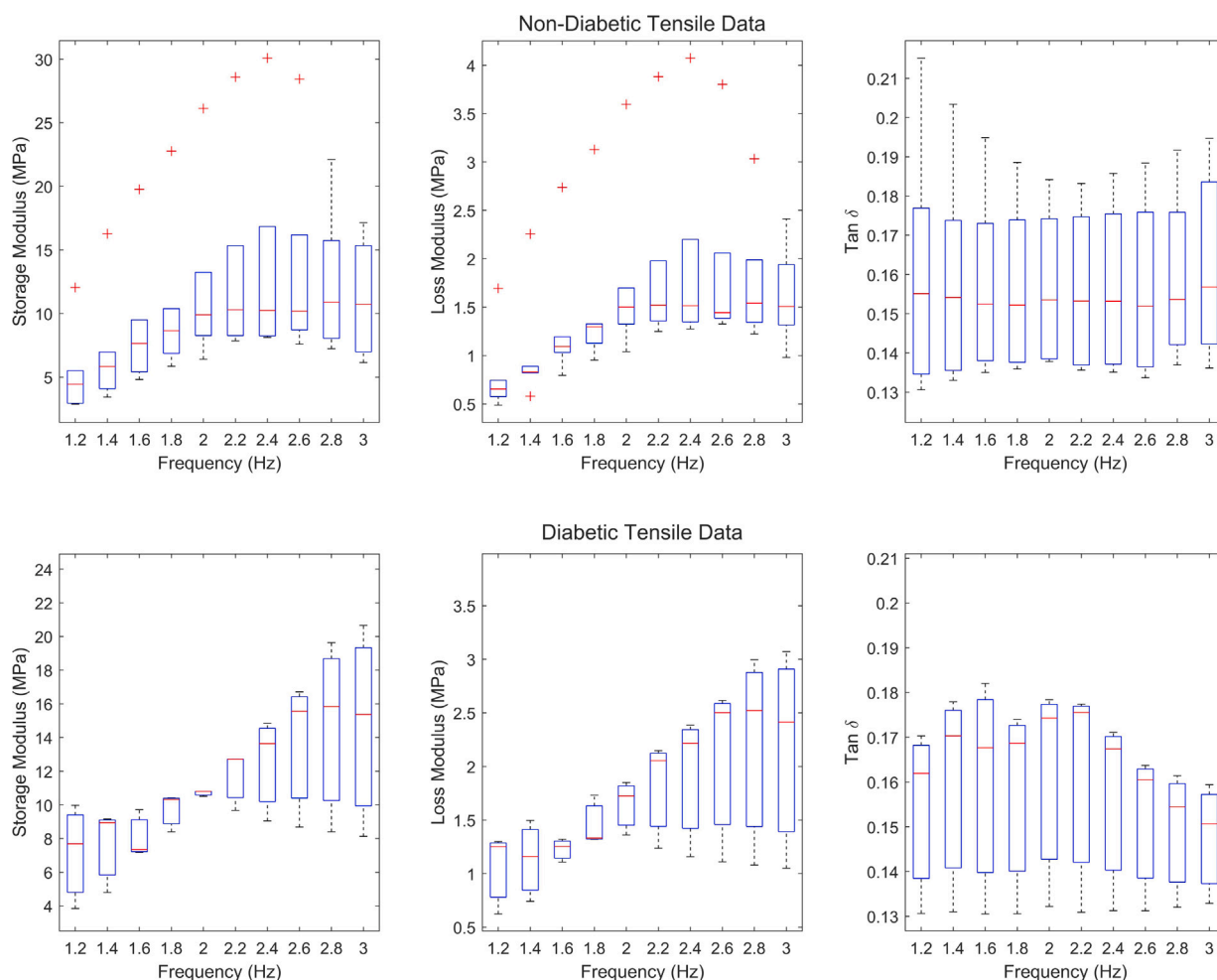

Fig. 6. Tensile DMA comparative outputs for the combined cohorts of non-diabetic and diabetic plantar skin specimens.

Table 3

Stress-strain failure testing data of non-diabetic and diabetic plantar skin showing the mean and [SD] per specimen, combined means and p values, as determined using Dots-on-Plots™ software.

		Non-diabetic						Diabetic				p	
		Specimen 1	Specimen 2	Specimen 3	Specimen 4	Specimen 5	Specimen 6	Non-diabetic mean	Specimen 1	Specimen 2	Specimen 3	Diabetic mean	(1 s.f.)
Strain (mm/mm)	Transition	0.02 [0.01]	-0.11 [0.02]	-0.07 [0.06]	0.01 [0.05]	-0.04 [0.03]	0.03	-0.03 [0.02]	-0.05 [0.01]	0.02 [0.06]	-0.04 [0.06]	-0.02 [0.02]	0.9
	Yield	0.06 [0.01]	-0.07 [0.03]	-0.04 [0.05]	0.08 [0.06]	0.01 [0.03]	0.07 [0.06]	0.02 [0.07]	-0.01 [0.01]	0.06 [0.07]	0.00 [0.06]	0.02 [0.06]	1
	Ultimate	0.18 [0.01]	0.24 [0.10]	0.06 [0.04]	0.28 [0.05]	0.23 [0.07]	0.21 [0.09]	0.20 [0.09]	0.13 [0.03]	0.25 [0.07]	0.15 [0.05]	0.18 [0.07]	0.5
Stress (MPa)	Transition	0.05 [0.01]	0.03 [0.01]	0.05 [0.01]	0.04 [0.01]	0.07 [0.01]	0.02 [0.01]	0.04 [0.02]	0.05 [0.00]	0.07 [0.02]	0.07 [0.02]	0.06 [0.02]	0.02*
	Yield	0.08 [0.02]	0.06 [0.03]	0.09 [0.02]	0.07 [0.02]	0.12 [0.02]	0.03 [0.02]	0.08 [0.03]	0.09 [0.01]	0.11 [0.03]	0.29 [0.12]	0.24 [0.09]	0.03*
	Ultimate	0.17 [0.05]	0.17 [0.07]	0.17 [0.04]	0.15 [0.04]	0.27 [0.04]	0.07 [0.03]	0.17 [0.07]	0.19 [0.05]	0.24 [0.03]	0.29 [0.12]	0.24 [0.09]	0.04*
Young's Modulus (MPa)		0.96 [0.21]	0.86 [0.24]	1.13 [0.22]	0.50 [0.09]	1.13 [0.16]	0.41 [0.10]	0.83 [0.49]	1.11 [0.21]	1.25 [0.17]	1.64 [0.58]	1.33 [0.43]	0.004*

\* p < 0.05 two-sample t-test.

(Fig. 6). The disparity in sample size within the disease population may contribute to this, but the population age should also be considered. As in Table 1, the non-diabetic donor age is higher than the diabetic population, and with age being a function of increasing skin stiffness this may effect the data (Pawlaczyk et al., 2013). Diabetic disease state is also known to contribute to plantar soft tissue changes (Chao et al., 2011), and with disease longevity, neuropathic and pre-ulcerative history unknown for the donor group it is uncertain the contribution this plays in the study outcomes. Fig. 6 shows the tan δ median decreasing with increasing frequency in the diabetic population compared to relative stability in the non-diabetic cohort, suggesting that disease state may impact dampening effects of the skin undergoing tensile evaluation. DMA analysis was conducted at frequencies representative of a range of gait speeds undertaken during activities of daily living (Segal et al., 2004).

Compressive DMA subjected the disease groups to different loading conditions of 20 and 30 N, reflective of expected loading in the respective non-diabetic and diabetic populations (Brady et al., 2021). Fig. 8 showed minimal difference in median values for storage and loss modulus and tan δ between the populations. With these characteristics being a function of load, it would be expected that the value may differ due to exposing the diabetic specimens to 10 N increased loading. Further studies with an increased sample size and under consistent and varied loading conditions should be considered to investigate population variance.

Due to the limited availability of tissue, in particular diabetic donors, the sample sizes used in this study are small and lead to reduced power in any statistical evaluations considered, as reflected in similar studies (Brady et al., 2021). Limited availability also meant that in both cohorts, one donor provides specimens from both feet for assessment whereas all other donors provided only one foot for

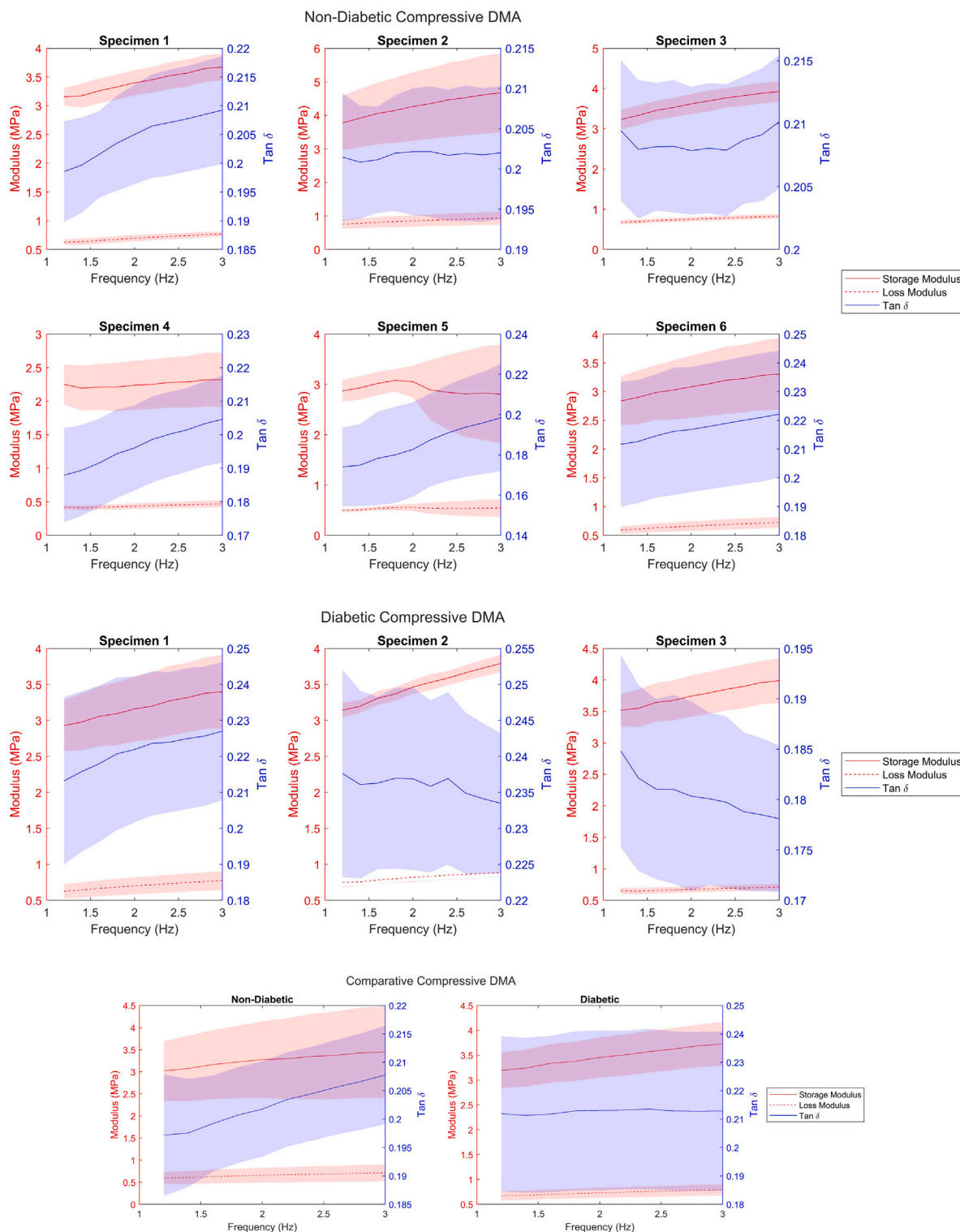

Fig. 7. Compressive DMA analysis outputs showing storage modulus, loss modulus and tan  $\delta$  mean and standard deviation for each non-diabetic and diabetic plantar skin specimen.

specimen collection. Limitations also exist in the methods of tissue excision and measurement, leading to variability in the values obtained for skin thickness. The difficulty in separating the subcutaneous fat from the skin and the inability to distinguish between any remaining fatty tissues still attached using a thickness gauge supports this limitation. The protocol employed for tensile testing also provides a potential source of result variability. Gripping tissue using serrated clamps, whilst maintaining tissue hold, may lead to some loosening of the tissue position alongside elongation of the tissue during the study.

Improved tissue grip designs alongside torque controlled clamping may improve consistency in grip and subsequent soft tissue testing results and should be considered for future studies (Jiang et al., 2020).

Application of the mechanical properties of plantar skin characterised in this study offer the potential for use in developing an improved plantar surrogate, deviating from the oversimplified models often currently employed in tissue surrogates (Chanda, 2018). When translating mechanical characteristics into surrogate development it is important to consider the response of shear due to the role it plays



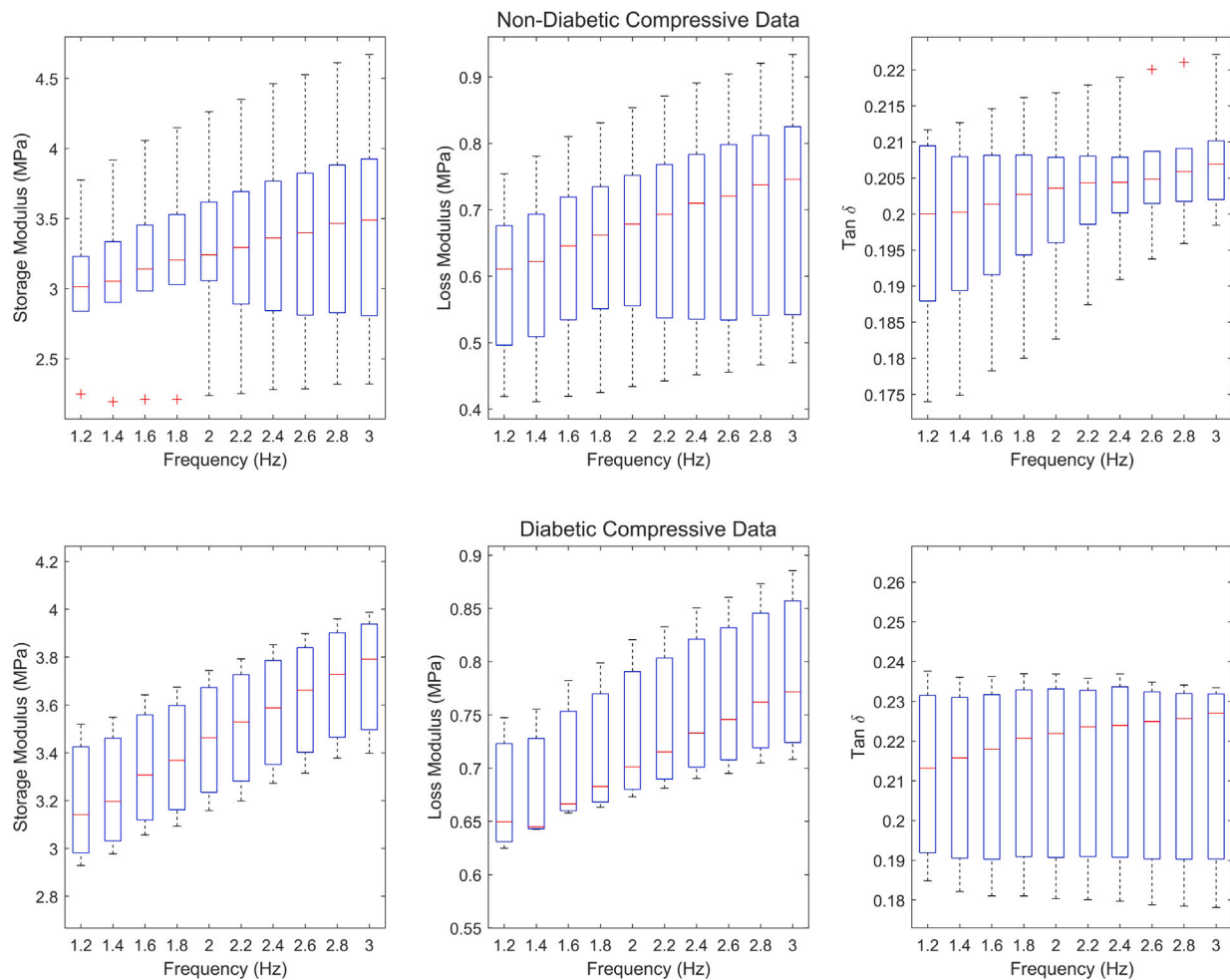

Fig. 8. Compressive DMA comparative outputs for the combined cohorts of non-diabetic and diabetic plantar skin specimens.

in plantar interactions leading to DFU formation (Jones et al., 2022). Though this is outside the scope of this study it has been considered previously in other studies of skin mechanical characterisation (Brady et al., 2021; Holt et al., 2008). Holt et al. (2008) found that skin exhibits strain hardening under shear step-stress conditions, but when analysing independent skin layers, the dermis alone demonstrates stress softening. This individual layer response showed the epidermis providing elastic rigidity to the skin, with the dermis responsible for viscoelasticity (Holt et al., 2008). Due to this differing response of the skin layers, future studies should investigate the dermis and epidermis separately to ensure that any subsequent surrogate development aligns with the mechanical characteristics of the complete skin structure. Further studies should also focus on the role of subcutaneous tissues acting under the loads transmitted from the plantar skin surface during interaction with the external environment, to characterise their behaviour and contribution in the development of ulcerations.

The mechanical characterisation of the skin in this study offers potential for translation of findings to surrogate development of both diabetic and non-diabetic tissues for use within biofidelic test bed approaches. Biofidelic test beds offer the opportunity to reduce reliance on cadaveric tissue when assessing plantar interactions, but the lack of appropriate mechanical surrogates limits their employment at present. Future studies should consider surrogate manufacture utilising the defined tissue characteristics for biofidelic testing approaches.

## 5. Conclusions

Measuring plantar tissue mechanical characteristic differences between disease states is fundamental in working towards improved

understanding of diabetic foot ulceration formation pathways. DIC offers a useful method to assess inherent surface straining of the skin both in and ex vivo. Assessing tissue response under frequencies representative of activities of daily living to determine dependent characteristics, provides a method that ensures development of physical models to be tested under the same loading regimes can be met. Whilst the sample size in this study is low, due to availability of donor tissue, differences can be seen in the mechanical characteristics of the non-diabetic and diabetic population plantar specimens undergoing DMA and stress-strain analysis. Utilising these response characteristics will inform the creation of non-linear response surrogates, moving away from the current simplified property models and allow for more realistic physical models for tribological assessment. A successful surrogate will reduce the reliance on donor procurement for testing and allow for increased testing demand of plantar tribological studies to work towards improved interventions and patient health outcomes for the at-risk diabetic foot.

## Abbreviations

DFU — Diabetic Foot Ulceration  
 DIC — Digital Image Correlation  
 DMA — Dynamic Mechanical Analysis

## CRediT authorship contribution statement

**Sarah R. Crossland:** Methodology, Data curation, Investigation, Conceptualization, Writing – review & editing, Formal analysis, Writing – original draft. **Francesca Sairally:** Investigation, Writing – review &

editing, Methodology. **Jen Edwards:** Conceptualization, Investigation, Writing – review & editing, Methodology. **Peter Culmer:** Supervision, Conceptualization, Methodology, Writing – review & editing. **Claire L. Brockett:** Conceptualization, Methodology, Formal analysis, Supervision, Writing – review & editing.

### Declaration of competing interest

The authors declare that they have no known competing financial interests or personal relationships that could have appeared to influence the work reported in this paper.

### Data availability

<https://doi.org/10.5518/1331>.

### Acknowledgements

Thanks should be extended to my supervision team for their continual support and guidance and to EPSRC, UK for funding this research.

### Funding

This study was funded via EPSRC, UK funded CDT Centre, UK Grants EP/L01629X/1 and EP/L014823/1.

### Ethics approval and consent to participate

Ethics were obtained via the University of Leeds MaPS and Engineering joint Faculty Research Ethics Committee (MEEC FREC). Ethics Reference: MEEC 18–040. Donor consent for tissue study was obtained through the certified human tissue service used for this study, MedCure Inc., Orlando, USA.

### References

- Bostan, L.E., Taylor, Z.A., Carré, M.J., MacNeil, S., Franklin, S.E., Lewis, R., 2016. A comparison of friction behaviour for ex vivo human, tissue engineered and synthetic skin. *Tribol. Int.* 103, 487–495. Available from: <https://www.sciencedirect.com/science/article/pii/S0301679X16302407>.
- Brady, L., Pai, S., Iaquinto, J.M., Wang, Y.-N., Ledoux, W.R., 2021. The compressive, shear, biochemical, and histological characteristics of diabetic and non-diabetic plantar skin are minimally different. *J. Biomech.* 129, 110797. Available from: <https://www.sciencedirect.com/science/article/pii/S0021929021005595>.
- Carré, M.J., 2021. *Synthetic Test-Beds for Assessing Human-Object Tribological Interactions*. Lyon, France.
- Chanda, A., 2018. Biomechanical modeling of human skin tissue surrogates. *Biomimetics* 3 (3), 18. Available from: <https://www.ncbi.nlm.nih.gov/pmc/articles/PMC6352690/>.
- Chanda, A., McClain, S., 2019. Mechanical modeling of healthy and diseased calcaneal fat pad surrogates. *Biomimetics* 4 (1), 1. Available from: <https://www.ncbi.nlm.nih.gov/pmc/articles/PMC6477669/>.
- Chao, C.Y.L., Zheng, Y.-P., Cheing, G.L.Y., 2011. Epidermal thickness and biomechanical properties of plantar tissues in diabetic foot. *Ultrasound Med. Biol.* 37 (7), 1029–1038. Available from: <https://www.sciencedirect.com/science/article/pii/S0301562911002018>.
- Chatzistergos, P.E., Allan, D., Chockalingam, N., Naemi, R., 2022. Shore hardness is a more representative measurement of bulk tissue biomechanics than of skin biomechanics. *Med. Eng. Phys.* 105, 103816. Available from: <https://www.sciencedirect.com/science/article/pii/S1350453322000650>.
- Chatzistergos, P.E., Naemi, R., Sundar, L., Ramachandran, A., Chockalingam, N., 2014. The relationship between the mechanical properties of heel-pad and common clinical measures associated with foot ulcers in patients with diabetes. *J. Diabetes Complicat.* 28 (4), 488–493. Available from: <https://www.sciencedirect.com/science/article/pii/S105687271400066X>.
- Chen, W.-M., Lee, T., Lee, P.V.-S., Lee, J.W., Lee, S.-J., 2010. Effects of internal stress concentrations in plantar soft-tissue—A preliminary three-dimensional finite element analysis. *Med. Eng. Phys.* 32 (4), 324–331. Available from: <https://www.sciencedirect.com/science/article/pii/S1350453310000020>.
- Cheung, Y.Y., Doyley, M., Miller, T.B., Kennedy, F., Lynch, F., Wrobel, J.S., Paulson, K., Weaver, J., 2006. Magnetic resonance elastography of the plantar fat pads: Preliminary study in diabetic patients and asymptomatic volunteers. *J. Comput. Assist. Tomogr.* 30 (2), 321–326.

- Crossland, S.R., Siddle, H.J., Brockett, C.L., Culmer, P., 2023. Evaluating the Use of a Novel Low-Cost Measurement Insole to Characterise Plantar Foot Strain During Gait Loading Regimes. medRxiv, Pages: 2023.04.04.23288138. Available from: <https://www.medrxiv.org/content/10.1101/2023.04.04.23288138v1>.
- Derler, S., Gerhardt, L.C., Lenz, A., Bertaud, E., Hadad, M., 2009. Friction of human skin against smooth and rough glass as a function of the contact pressure. *Tribol. Int.* 42 (11), 1565–1574. Available from: <https://www.sciencedirect.com/science/article/pii/S0301679X0800251X>.
- Gefen, A., Megido-Ravid, M., Azariah, M., Itzhak, Y., Arcan, M., 2001. Integration of plantar soft tissue stiffness measurements in routine MRI of the diabetic foot. *Clin. Biomech. (Bristol Avon)* 16 (10), 921–925.
- Hashmi, F., Malone-Lee, J., Hounsell, E., 2006. Plantar skin in type II diabetes: an investigation of protein glycation and biomechanical properties of plantar epidermis. *Eur. J. Dermatol.* 16 (1), 23–32. Available from: [https://www.jle.com/fr/revues/ejd/e-docs/plantar\\_skin\\_in\\_type\\_ii\\_diabetes\\_an\\_investigation\\_of\\_protein\\_glycation\\_and\\_biomechanical\\_properties\\_of\\_plantar\\_epidermis\\_267553/article.phtml?tab=texte](https://www.jle.com/fr/revues/ejd/e-docs/plantar_skin_in_type_ii_diabetes_an_investigation_of_protein_glycation_and_biomechanical_properties_of_plantar_epidermis_267553/article.phtml?tab=texte).
- for Health Improvement & Disparities, O., 2022. National Diabetes Foot Care Report. UK Government, Available from: <https://fingertips.phe.org.uk/static-reports/diabetes-footcare/national-diabetic-footcare-report.html>.
- Holt, B., Tripathi, A., Morgan, J., 2008. Viscoelastic response of human skin to low magnitude physiologically relevant shear. *J. Biomech.* 41 (12), 2689–2695. Available from: <https://www.ncbi.nlm.nih.gov/pmc/articles/PMC2584606/>.
- Hsu, T.-C., Lee, Y.-S., Shau, Y.-W., 2002. Biomechanics of the heel pad for type 2 diabetic patients. *Clin. Biomech. (Bristol Avon)* 17 (4), 291–296.
- Hsu, C.-C., Tsai, W.-C., Hsiao, T.-Y., Tseng, F.-Y., Shau, Y.-W., Wang, C.-L., Lin, S.-C., 2009. Diabetic effects on microchambers and macrochambers tissue properties in human heel pads. *Clin. Biomech. (Bristol Avon)* 24 (8), 682–686.
- Hsu, C.-C., Tsai, W.-C., Shau, Y.-W., Lee, K.-L., Hu, C.-F., 2007. Altered energy dissipation ratio of the plantar soft tissues under the metatarsal heads in patients with type 2 diabetes mellitus: a pilot study. *Clin. Biomech. (Bristol Avon)* 22 (1), 67–73.
- Hsu, T.C., Wang, C.L., Shau, Y.W., Tang, F.T., Li, K.L., Chen, C.Y., 2000. Altered heel-pad mechanical properties in patients with Type 2 diabetes mellitus. *Diabetic Med.* 17 (12), 854–859.
- Huntley, A.C., Walter, R.M., 1990. Quantitative determination of skin thickness in diabetes mellitus: relationship to disease parameters. *J. Med.* 21 (5), 257–264.
- Icks, A., Scheer, M., Morbach, S., Genz, J., Haastert, B., Giani, G., Glaeske, G., Hoffmann, F., 2011. Time-dependent impact of diabetes on mortality in patients after major lower extremity amputation: survival in a population-based 5-year cohort in Germany. *Diabetes Care* 34 (6), 1350–1354.
- Ikonen, T.S., Sund, R., Venermo, M., Winell, K., 2010. Fewer major amputations among individuals with diabetes in Finland in 1997–2007: a population-based study. *Diabetes Care* 33 (12), 2598–2603.
- International Diabetes Federation, 2019. IDF Diabetes Atlas 9th Edition. International Diabetes Federation, International, Available from: <https://diabetesatlas.org/atlas/ninth-edition/>.
- Jiang, M., Lawson, Z.T., Erel, V., Pervere, S., Nan, T., Robbins, A.B., Feed, A.D., Moreno, M.R., 2020. Clamping soft biologic tissues for uniaxial tensile testing: A brief survey of current methods and development of a novel clamping mechanism. *J. Mech. Behav. Biomed. Mater.* 103, 103503. Available from: <https://www.sciencedirect.com/science/article/pii/S1751616119310628>.
- Jones, A.D., Crossland, S.R., Nixon, J.E., Siddle, H.J., Russell, D.A., Culmer, P.R., 2023. STRain Analysis and Mapping of the Plantar Surface (STAMPS) – A Novel Technique of Plantar Load Analysis During Gait. medRxiv, Pages: 2023.03.10.23287086. Available from: <https://www.medrxiv.org/content/10.1101/2023.03.10.23287086v1>.
- Jones, A.D., De Siqueira, J., Nixon, J.E., Siddle, H.J., Culmer, P.R., Russell, D.A., 2022. Plantar shear stress in the diabetic foot: A systematic review and meta-analysis. *Diabetic Med.* 39 (1), e14661.
- Jupiter, D.C., Thorud, J.C., Buckley, C.J., Shibuya, N., 2016. The impact of foot ulceration and amputation on mortality in diabetic patients. I: From ulceration to death, a systematic review. *Int. Wound J.* 13 (5), 892–903.
- Kerr, M., Barron, E., Chadwick, P., Evans, T., Kong, W.M., Rayman, G., Sutton-Smith, M., Todd, G., Young, B., Jeffcoate, W.J., Sutton-Smith, M., Todd, G., Young, B., Jeffcoate, W.J., 2019. The cost of diabetic foot ulcers and amputations to the National Health Service in England. *Diabetic Med.* 36 (8), 995–1002. Publisher: Blackwell Publishing Ltd. Available from: <https://onlinelibrary.wiley.com/doi/abs/10.1111/dme.13973>.
- Klaesner, J.W., Hastings, M.K., Zou, D., Lewis, C., Mueller, M.J., 2002. Plantar tissue stiffness in patients with diabetes mellitus and peripheral neuropathy. *Arch. Phys. Med. Rehabil.* 83 (12), 1796–1801.
- Kwan, R.L.-C., Zheng, Y.-P., Cheing, G.L.-Y., 2010. The effect of aging on the biomechanical properties of plantar soft tissues. *Clin. Biomech.* 25 (6), 601–605. Publisher: Elsevier. Available from: [https://www.clinbiomech.com/article/S0268-0033\(10\)00101-4/fulltext](https://www.clinbiomech.com/article/S0268-0033(10)00101-4/fulltext).
- Lord, M., Hosein, R., 2000. A study of in-shoe plantar shear in patients with diabetic neuropathy. *Clin. Biomech.* 15, 278–283. ISBN: 02680033/00.

- Michael, A., Michael, A., Orteu, J.-J., Schreier, H.W., 2009a. Digital Image Correlation (DIC). In: Schreier, H., Orteu, J.-J., Sutton, M.A. (Eds.), *Image Correlation for Shape, Motion and Deformation Measurements: Basic Concepts, Theory and Applications*. Springer US, Boston, MA, pp. 1–37, Available from: [http://doi.org/10.1007/978-0-387-78747-3\\_5](http://doi.org/10.1007/978-0-387-78747-3_5).
- Michael, A., Michael, A., Orteu, J.-J., Schreier, H.W., 2009b. Single camera models and calibration procedures in computer vision. In: *Image Correlation for Shape, Motion and Deformation Measurements*. pp. 1–37, Publisher: Springer, Boston, MA. Available from: [https://link.springer.com/chapter/10.1007/978-0-387-78747-3\\_3](https://link.springer.com/chapter/10.1007/978-0-387-78747-3_3).
- Morrison, T., Jones, S., Causby, R.S., Thoires, K., 2021. Reliability of ultrasound in evaluating the plantar skin and fat pad of the foot in the setting of diabetes. *PLoS ONE* 16 (9), e0257790, Available from: <https://www.ncbi.nlm.nih.gov/pmc/articles/PMC8459958/>.
- Moxey, P.W., Gogalniceanu, P., Hinchliffe, R.J., Loftus, I.M., Jones, K.J., Thompson, M.M., Holt, P.J., 2011. Lower extremity amputations — a review of global variability in incidence. *Diabetic Med.* 28 (10), 1144–1153, eprint: <https://onlinelibrary.wiley.com/doi/pdf/10.1111/j.1464-5491.2011.03279.x>. Available from: <https://onlinelibrary.wiley.com/doi/abs/10.1111/j.1464-5491.2011.03279.x>.
- Nachman, M., Franklin, S.E., 2016. Artificial Skin Model simulating dry and moist in vivo human skin friction and deformation behaviour. *Tribol. Int.* 97, 431–439, Available from: <https://www.sciencedirect.com/science/article/pii/S0301679X16000554>.
- NíAnnaidh, A., Bruyère, K., Destrade, M., Gilchrist, M.D., Otténio, M., 2012. Characterization of the anisotropic mechanical properties of excised human skin. *J. Mech. Behav. Biomed. Mater.* 5 (1), 139–148.
- Pai, S., Ledoux, W.R., 2010. The compressive mechanical properties of diabetic and non-diabetic plantar soft tissue. *J. Biomech.* 43 (9), 1754–1760.
- Pai, S., Ledoux, W.R., 2012. The shear mechanical properties of diabetic and non-diabetic plantar soft tissue. *J. Biomech.* 45 (2), 364–370, Available from: <https://www.sciencedirect.com/science/article/pii/S0021929011006555>.
- Pawlaczyk, M., Lelonkiewicz, M., Wieczorowski, M., 2013. Age-dependent biomechanical properties of the skin. *Adv. Dermatol. Allergol.* 30 (5), 302–306, Available from: <https://www.ncbi.nlm.nih.gov/pmc/articles/PMC3858658/>.
- Piaggese, A., Romanelli, M., Schipani, E., Campi, F., Magliaro, A., Baccetti, F., Navalesi, R., 1999. Hardness of plantar skin in diabetic neuropathic feet. *J. Diabetes Complicat.* 13 (3), 129–134.
- Rajala, S., Lekkala, J., 2014. Plantar shear stress measurements - A review. *Clin. Biomech.* 29 (5), 475–483, Publisher: Elsevier Ltd.
- Segal, A., Rohr, E., Orendurff, M., Shofer, J., O'Brien, M., Sangeorzan, B., 2004. The effect of walking speed on peak plantar pressure. *Foot Ankle Int.* 25 (12), 926–933, Publisher: SAGE Publications Inc. Available from: <https://doi.org/10.1177/107110070402501215>.
- Singh, G., Gupta, V., Chanda, A., 2022. Artificial skin with varying biomechanical properties. *Mater. Today: Proc.* 62, 3162–3166, Available from: <https://www.sciencedirect.com/science/article/pii/S2214785322017813>.
- Wang, Y.-N., Lee, K., Ledoux, W.R., 2011. Histomorphological evaluation of diabetic and non-diabetic plantar soft tissue. *Foot Ankle Int.* 32 (8), 802–810, Publisher: SAGE Publications Inc. Available from: <https://doi.org/10.3113/FAI.2011.0802>.
- Wang, Y.-N., Lee, K., Shofer, J.B., Ledoux, W.R., 2017. Histomorphological and biochemical properties of plantar soft tissue in diabetes. *Foot (Edinburgh Scotland)* 33, 1–6.
- Yavuz, M., Botek, G., Davis, B.L., 2007a. Plantar shear stress distributions: comparing actual and predicted frictional forces at the foot-ground interface. *J. Biomech.* 40 (13), 3045–3049.
- Yavuz, M., Erdemir, A., Botek, G., Hirschman, G.B., Bardsley, L., Davis, B.L., 2007b. Peak plantar pressure and shear locations: relevance to diabetic patients. *Diabetes Care* 30 (10), 2643–2645.
- Yavuz, M., Tajaddini, A., Botek, G., Davis, B.L., 2008. Temporal characteristics of plantar shear distribution: relevance to diabetic patients. *J. Biomech.* 41 (3), 556–559.