

## 600. Grass silage thickening technology using centrifugal undirected action vibrator

A. Jasinskas<sup>1,2</sup>, K. Plieskis<sup>2</sup>, E. Šarauskis<sup>1</sup>, A. Sakalauskas<sup>1</sup>

<sup>1</sup> Lithuanian University of Agriculture, Faculty of Agricultural Engineering, Department of Agricultural Machinery, Studentu str. 15, Akademija, LT-53362 Kaunas reg.

**e-mail:** [algirdas.jasinskas@lzuu.lt](mailto:algirdas.jasinskas@lzuu.lt)

<sup>2</sup> Lithuanian University of Agriculture, Faculty of Agricultural Engineering, Institute of Agricultural Engineering, Instituto str. 20, Raudondvaris, LT-54132 Kaunas reg.

**e-mail:** [algirdas.jasinskas@lzuu.lt](mailto:algirdas.jasinskas@lzuu.lt)

(Received 12 October 2010; accepted 9 December 2010)

**Abstract.** A vibratory device to thicken silage was designed and tested, experimental research was carried out using the device for thickening chopped mass of red clover and maize. Dependences of grass mass density variation on duration of thickening by the device and dependences of relative grass pressure on vibration frequency have been examined and assessed. The research has showed that during vibratory thickening grass layer thickens intensively for 5-10 min and this vibrator is advisable for thickening grass layers of 0.5-0.6 m thickness.

After investigation of dependence of grass thickening and grass comparative pressure on vibration frequency it was established that most effectively vibrator works at  $43.96 \text{ s}^{-1}$  frequency. Consequently, it is reasonable to thicken grass using undirected action vibrator at the mentioned frequency or close to it.

Experimental research has established that red clover density of  $350 \text{ kg/m}^3$  can be achieved by centrifugal-undirected action vibrator. That is insufficient density for grass silage. This vibrator is much more efficient for maize thickening when nearly double mass density is achieved. Therefore, this type of vibrator is advisable for thickening of big stems plants such as maize and its mixture with red clover.

It was established, that thickening of maize – Caucasian goat's rue (*Galega orientalis* Lam.) mix (2:1 ratio) by undirected action vibrator – after 20 min of thickening ( $2 \times 60 \text{ kg}$ ) gave  $425 \text{ kg/m}^3$  and  $124 \text{ kg/m}^3$  of dry matter density respectively. It is not sufficient density for grass thickening. Such vibrator is much more efficient in thickening maize, it reaches bigger mass density –  $730 \text{ kg/m}^3$  and  $223 \text{ kg/m}^3$  of dry matter.

On the grounds of the research results it can be stated that the vibratory thickener of investigated design (undirected action vibrator) is reasonable to use in thickening maize and maize-red clover mixture. This vibrator is not suitable for thickening of red clover, Caucasian goat's rue and maize-Caucasian goat's rue mixture.

**Keywords:** silage, thickening, container, undirected action vibrator, density, pressure.

### Introduction

Feeding cattle with silage is predominant all over the world. More and more swards are allocated to silage in Western Europe states. That is evidenced by the data on the percentage of using harvested swards for silage production: in Holland it is 99 %, in Denmark – 93 %, in

Northern Ireland – 90 % and in Norway – 75 %, etc. [1]. In the process of energy deficit ensiling of grass forages has been and will continue being the main way of their preservation. It is forecasted that the production of chopped grass silage in trenches, heaps, containers and bales will remain in the near future. In preparation of silage its quality depends on the time of filling trenches and containers and mass pressing [2, 3]. Up to 1990 in Lithuania silage was pressed only by caterpillar tractors. Later heavy wheeled tractors K-701, T-150K, average draught class MTZ and other tractors were started to be used for this purpose. Later, in 2001 research on using low capacity tractors (T-25A, etc.) in pressing chopped grass was carried out [4, 5, 6].

There is a problem in agriculture while preparing forage of grass plants; it is the need to thicken materials as efficiently and as economically as possible. In preparing silage in trenches production costs reach 320 Lt/ha, in bales – nearly 4 times less and in bags – 740 Lt/ha. Quite high energy capacity is typical for thickening process. During thickening of grass mass in a trench by tractor energy capacity reaches 18 kJ/kg of grass [1, 5].

In Lithuania silage is prepared in trenches and stacks. Recently production of unchopped grass silage in bales is becoming more popular. In small-scale farms chopped silage is advisable to produce in section type trenches and in container stores. Container manufacturing does not require huge capital investments. The vibratory method could be used for mass thickening in containers [1, 6, 7].

Energy costs should be similar in using vibratory method for grass thickening. Yet, in the case of vibratory thickening tractor is not used and it can be used for transporting grass mass and silage can be produced in trenches of substandard size or special section type trenches [8, 9]. In addition the thickened mass is not polluted with oil products and the risk of injuries is reduced as operator manages the process from the outside. Therefore, it is advisable to assess the process of silage mass thickening by using vibratory method.

Recently the Institute of Agricultural Engineering of LUA (IAE LUA) has been carrying out investigations related with applying vibratory grass mass pressing method as an alternative way to mass pressing by tractors [5]. In order to evaluate such methods a good analysis of physical characteristics of the mass pressed have to be performed as the types of used vibrators and their operational parameters depend on them. It is reasonable to manufacture an experimental model of grass thickening vibrator, assess its main working parameters and their influence on grass thickening process.

**The objective** of tests was to assess the process and technology of silage thickening by vibratory method and establish dependence of change in mass thickness and comparative pressure of grass thickened by centrifugal undirected action vibrator on working parameters of vibrator.

## Experimental methods

Research object is different chopped grass plants. For the research the following was used: red clover and Caucasian goat's rue (*Galega orientalis* Lam.) of 69-79 % moisture chopped with *Maral-125* forage combine (grass length 15-45 mm) and composed of 80-85 % of red clover and 15-20 % of legume grasses; maize of 81 % moisture, chopped with *Krone Big* forage combine (grass length 15-20 mm) and maize-red clover mixture of 76 % moisture (2:1 ratio). The research was made in the laboratory trial station of Institute of Agricultural Engineering, LUA. The trials were made by a laboratory stand, which was made in the Institute [10] (Fig. 1). For grass thickening centrifugal undirected action vibrator with changeable weights was used. The grass mass was thickened in a container store at the bottom of which an opening had been made and a sensitive pressure plate of 0.25×0.25 m size fitted. The vibrator is rotated by alternating current asynchronous engine of 1.1 kW power and 2850 min<sup>-1</sup> revolution frequency. Total centrifugal undirected action vibrator mass – 105 kg.

Grass mass was thickened in container store, at the bottom of which an opening was made and tensometer sensor was fitted. A 0.0625 m<sup>2</sup> area of pressure recording plate of sensor is on a level with container bottom. This sensor connected with pressure measuring device – tensoindicator 1526 by “Brull & Kjør” firm showed mass pressure upon container bottom.

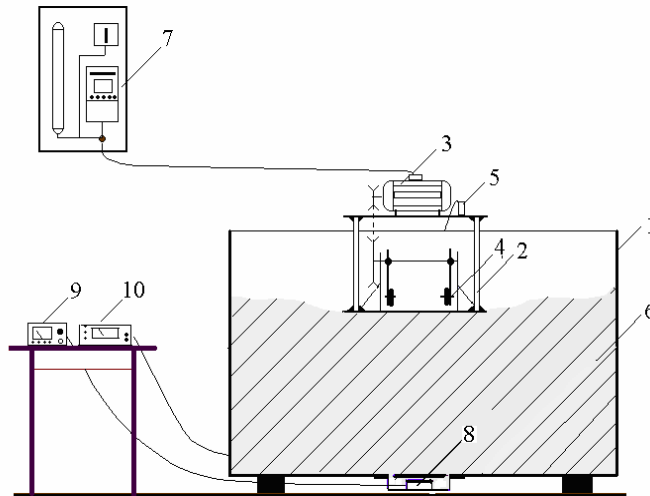

**Fig. 1.** Scheme of grass thickening in container storage using centrifugal undirected action vibratory device: 1 – container storage; 2 – centrifugal undirected action vibrator; 3 – electrical engine; 4 – changeable weights; 5 – vibration sensor; 6 – mass of thickened grass; 7 – electric current frequency converter; 8 – tensometer sensor; 9 – pressure measurement device; 10 – vibration measurement device

In order to assess more accurately the influence of vibrator’s exciting power on pressure of thickened grass and avoid the influence of grass and vibrator mass and other factors on received pressure data, pressure was translated into relative pressure  $p_s$  [7]. This pressure shows percentage increase of pressure in grass layer during vibration in comparison with pressure when only vibrator’s gravity is involved.

$$p_s = (p_2 - p_1) / p_1 \times 100 ; \quad (1)$$

where:  $p_s$  – relative pressure, %;

$p_1$  – pressure in grass layer when only influenced by vibrator’s gravity, kPa;

$p_2$  – pressure in grass layer during vibrator’s operation, kPa.

During the trials container was loaded with chopped grass, vibrator fitted on top and it vibrated for 20-30 min. During vibrator operation every 5 min the height of grass mass layer  $h$  was measured and readings of devices recorded. On the grounds of previous research data [7] it was established that when pressing with tractors grass horizontal displacement (from under wheels to sides) does not exceed 3 %, therefore, this horizontal displacement was not taken into account.

During trials the following main thickening parameters were set: thickness of thickened grass layer varied within range of 0.4-1.2 m, 3 layers were loaded; vibrator rotation frequency – 21.98-65.94 s<sup>-1</sup>; vibrator’s exciting power – 222-2003 N.

The efficiency of vibratory thickening in trials was assessed according to variation of density  $\rho$ . Grass density was obtained from the ratio of grass mass and its volume. Grass volume was established with a ruler (accuracy  $\pm 0.001$  m). The mass of grass loaded in container was established by weighing. Weighing range of the scales used is 20÷500 kg, accuracy  $\pm 0.5$  kg. After putting two silage layers into the container and pressing these layers the silage was sealed by polyethylene film and pressed by using the gravity force of the centrifugal directed action vibrator. Two months later silage samples were taken and the quality of feed was evaluated by using standard methods [11].

Every experiment was repeated at least 3 times and research data was processed by using mathematical-statistical methods calculating arithmetic mean, standard deviation and choosing Student's coefficient – errors at 0.95 probability.

## Results

During the research of pressure in thickening red clover it was established, that depending on vibrator's work parameters and layer thickness of thickening grass and its physical parameters the pressure during the research varied from 9.6 to 19.2 kPa. When applying (1) equation, pressure was recalculated into comparative pressure  $p_s$  and the data obtained is presented in Fig.2.

Comparative pressure shows the efficiency of vibrator's work more accurately compared with increase of thickening grass density, while reducing the influence of such factors as physical characteristics of grass. First three curves in Fig. 2 demonstrate the influence of vibration frequency on the increase of comparative pressure or efficiency of thickening, when thickness of grass layer is stable. It can be observed from these curves that the greatest comparable pressure is achieved, when vibrator works at 43.96 s<sup>-1</sup> frequency (curve 2). When vibration frequency decreases or increases (curves 1 and 3), comparative pressure decreases. On the grounds of these results it can be stated, that it is reasonable to thicken grass at vibration frequency close to 43.96 s<sup>-1</sup>.

Curves (4, 5) in Fig. 2 present data when vibrator works at a stable 43.96 s<sup>-1</sup> frequency while changing only the thickness of grass layer. Jumps in these curves represent loading of new grass layers – up to the 5<sup>th</sup> minute of vibrating mass comparative pressure increases, later it stabilizes and is more or less the same until the 10<sup>th</sup> minute. After 10 minutes a new layer of grass is loaded, vibrator is switched on and thickening is in progress until the 15<sup>th</sup> minute which decreases again later. On the grounds of this research data it can be stated that it is reasonable to thicken grass layers of 0.5-0.6 m thickness with vibrator. It was established that grass layer thickens intensively for 5-10 min.

Research results of thickening different layers of grass plants with vibratory thickener are presented in Fig. 3-7. After testing the influence of grass layer thickness on its thickening it was established that grass had been thickened more, when the layer loaded was thicker. Diagrams in Fig. 3 show that after 20 min of thickening red clover in the second treatment (2×0.60 m) 315 kg/m<sup>3</sup> density was achieved and in the first case (3×0.40 m) only 260 kg/m<sup>3</sup> density was achieved even after 30 min of thickening. That can be explained by different grass quality: in the first case overgrown clover with larger amount of legume grass was used and in the second case younger and smaller clover was thickened. When thickening the first 0.60 m thick layer the greatest mass density of 350 kg/m<sup>3</sup> was achieved.

Very similar research results were got of thickening different layers of Caucasian goat's rue. Nevertheless, such density for silage is not sufficient and it is not reasonable to use this vibrator for red clover and Caucasian goat's rue thickening.

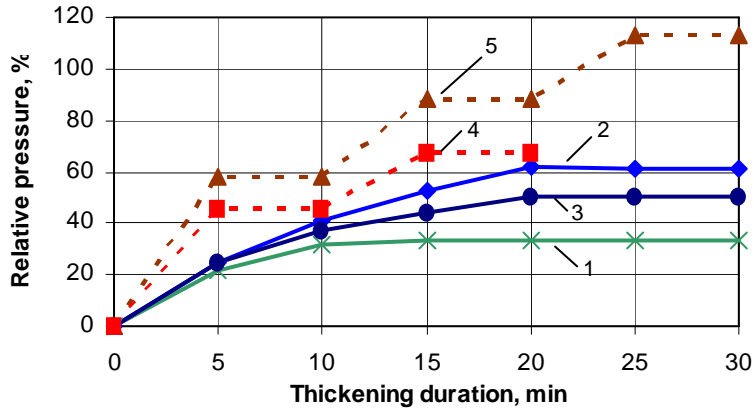

**Fig. 2.** The influence of vibration frequency and grass layer thickness upon pressure: 1 – vibrator rotation frequency  $\omega = 21,96 \text{ s}^{-1}$ , grass layer thickness  $h = 0,95 \text{ m}$ ; 2 –  $\omega = 43,96 \text{ s}^{-1}$ ,  $h = 0,95 \text{ m}$ ; 3 –  $\omega = 65,94 \text{ s}^{-1}$ ,  $h = 0,95 \text{ m}$ ; 4 –  $\omega = 43,96 \text{ s}^{-1}$ ,  $h = 2 \times 0,61 \text{ m}$ ; 5 –  $\omega = 43,96 \text{ s}^{-1}$ ,  $h = 3 \times 0,43 \text{ m}$

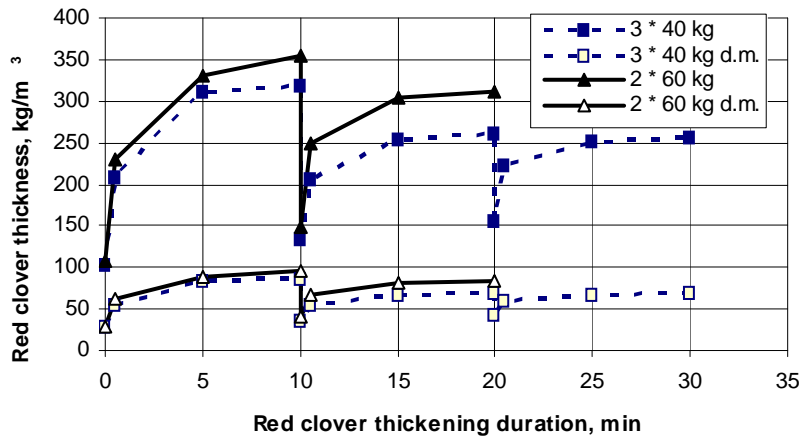

**Fig. 3.** The influence of red clover layer thickness upon thickening

Dependences of maize mass density change on thickening duration are presented in Fig. 4. The diagrams presented show that maize density achieved with vibratory thickener was much better than that of red clover. After 20 min of thickening twice as thick maize layer ( $2 \times 0,120 \text{ m}$ )  $450 \text{ kg/m}^3$  density was achieved and in the other case ( $3 \times 0,60 \text{ m}$ ) after 30 minutes  $490 \text{ kg/m}^3$  density was achieved. In thickening the first  $60 \text{ kg}$  thick maize layer actually the density of  $700 \text{ kg/m}^3$  was obtained after 10 min.

Diagrams given in Fig. 5 show that vibratory thickener was rather efficient with maize-red clover mixture. Mixture density was similar to that of maize. After 20 min of thickening ( $2 \times 0,60 \text{ m}$ )  $530 \text{ kg/m}^3$  density was achieved and in thickening the first  $60 \text{ kg}$  thick mixture layer even  $620 \text{ kg/m}^3$  density was achieved after 10 min.

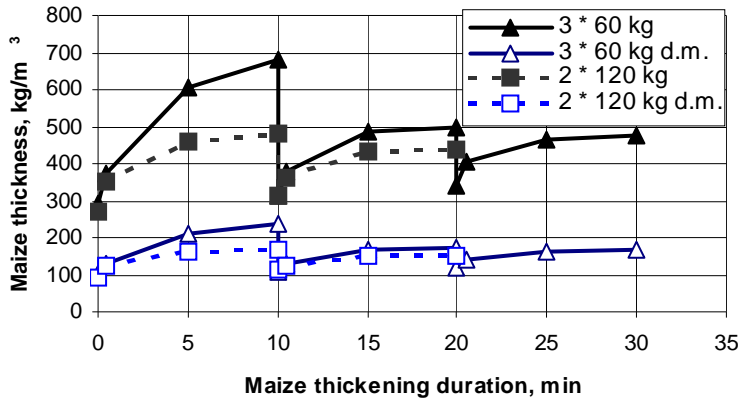

Fig. 4. Dependences of maize thickening duration to the mass density change

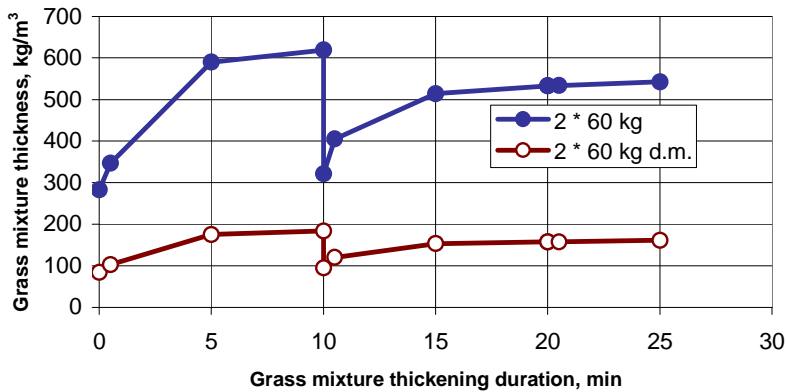
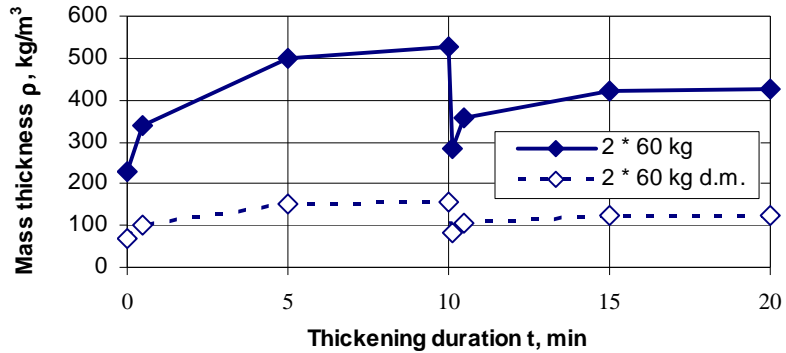

Fig. 5. Dependences of thickening duration of maize-red clover mixture (mixture rate 2:1) to the mass density change

The influence of thickening duration on variation of maize and Caucasian goat's rue mixture (mixture rate 2:1) density when the feed is thickened by a centrifugal undirected action vibrator is presented in Fig. 6. It was established that the analysed vibrator achieved not high density of maize and Caucasian goat's rue mixture mass: after 20 min of thickening 120 kg mixture mass the achieved density was 425 kg/m<sup>3</sup> and 124 kg/m<sup>3</sup> of dry matter respectively. It is not sufficient density [1] to produce high quality silage.

The influence of thickening duration on variation of maize mass density when the feed is thickened by a centrifugal undirected action vibrator is presented in Fig. 7. It was established that the analysed vibrator achieved rather high density of maize mass: after 20 min of thickening 120 kg maize mass the achieved density was 730 kg/m<sup>3</sup> and 239 kg/m<sup>3</sup> of dry matter respectively. While thickening the first maize mass layer of 60 kg, after 10 min even 808 kg/m<sup>3</sup> density was achieved. It is sufficient to achieve 600 kg/m<sup>3</sup> density to produce high quality silage.



**Fig. 6.** Dependences of maize and Caucasian goat's rue mixture (2:1) density  $\rho$  variation on thickening duration  $t$  (thickening mass by undirected action vibrator)

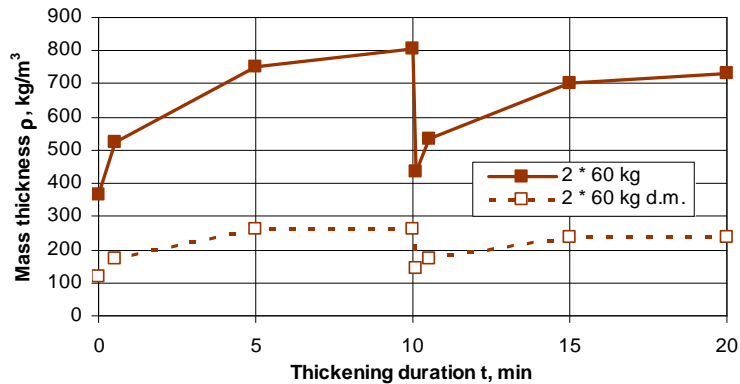

**Fig. 7.** Dependences of maize mass density  $\rho$  variation on thickening duration  $t$  while thickening mass by undirected action vibrator

On the grounds of the research performed it can be stated that the vibratory thickener of investigated design (undirected action vibrator) is reasonable to use in thickening maize and maize-red clover mixture. This vibrator is not suitable for thickening of red clover, Caucasian goat's rue and maize-Caucasian goat's rue mixture.

Silage quality was checked during the last trial when grass was thickened in two layers each 0.60 m thick. Quality test showed that the silage corresponded to requirements of first class, and maize-red clover mixture – of third class. During the trial it was established that ammonia, lactic and acetic acid amounts satisfied required level and pH and butyric acid amounts exceeded permissible level.

Research made at the Institute showed that experimental vibrator does not satisfy all requirements raised. Only big stem grass plants can be thickened by it efficiently, its work is not sufficiently stable and it is inexpedient to use it for thickening red clover and Caucasian goat's rue. It is reasonable to continue these investigations and to develop and reconstruct this vibrator into directed action vibrator, analyse the most important parameters of such vibrator, determine optimum working modes and reason its most important constructive parameters.

## Conclusions

- [1] Centrifugal undirected action vibrator for silage thickening was established and tested. It was established that grass layer thickens intensively for 5-10 min. Further grass layer thickening is inexpedient as there was no significant thickening of comparative pressure increase. It is reasonable to thicken grass layers of 0.5-0.6 m thickness using this vibrator.
- [2] After investigation of dependence of grass thickening and grass comparative pressure on vibration frequency it was established that most effectively vibrator works at  $43.96 \text{ s}^{-1}$  frequency. Consequently, it is reasonable to thicken grass using undirected action vibrator at the mentioned frequency or close to it.
- [3] As a result of experimental research it was established that centrifugal undirected action vibrator is reasonable to use in thickening chopped maize and maize-red clover mixture (thickening layer of 0.60 m mass thickness sufficient  $490\text{-}530 \text{ kg/m}^3$  density was achieved). This vibrator is not suited for thickening unmixed red clover as only  $260\text{-}350 \text{ kg/m}^3$  grass density is reached.
- [4] It was established, that thickening of maize – Caucasian goat's rue (*Galega orientalis* Lam.) mix (2:1 ratio) by undirected action vibrator – after 20 min of thickening ( $2 \times 60 \text{ kg}$ ) gave  $425 \text{ kg/m}^3$  and  $124 \text{ kg/m}^3$  of dry matter density respectively. It is not sufficient density for grass ensiling. Such vibrator is much more efficient in thickening maize, it reaches bigger mass density –  $730 \text{ kg/m}^3$  and  $223 \text{ kg/m}^3$  of dry matter.
5. On the grounds of the research results it can be stated that the vibratory thickener of investigated design (undirected action vibrator) is reasonable to use in thickening maize and maize-red clover mixture. This vibrator is not suitable for thickening of red clover, Caucasian goat's rue and maize-Caucasian goat's rue mixture.

## References

- [5] Sirvydis J. Development of silage production. Agroengineering and energetics. **1**, pp 74-82, 1999 [in Lithuanian].
- [6] Antonov N. M. The technology of vegetative materials thickening. Moscow, 65 p., 1995 [in Russian].
- [7] Augustaitis V. K. Basics of mechanical oscillatory motion. Vilnius, 318 p., 2000 [in Lithuanian].
- [8] Babitsky V. I. Theory of Vibroimpact Systems and Applications. Berlin, 154 p., 1998.
- [9] Tkacenko B. A. et al. Vibratory thickening of silage and haylage mass. Mechanization and automation of of agro-industrial complexes technological processes. Moscow, pp 157-158, 1989 [in Russian].
- [10] Spirgys A. Safe use of low power tractors in chopped grass packing: doctor theses. Kaunas-Akademija, 141 p., 2001 [in Lithuanian].
- [11] Mioldazys A. Safe work of silage mass thickening by wheeled tractors: doctor theses. Kaunas-Akademija, 139 p., 1993 [in Lithuanian].
- [12] Csizmadia B., Hegedűr A. Optimization the flexible elements of two-mass vibratory screen. Hungarian institute of agricultural engineering. **15**, pp 44-46, 2002.
- [13] Langlen R. W. Agricultural structures: wall leads. I Agr E Journal Landwards, **55** (4), pp 10-12, 2000.
- [14] Jasinskas A., Ferevičius D. Research of silage thickening using vibrator of undirected action. Agricultural engineering: IAE LUA and LUA research papers. Raudondvaris, **36(2)**, pp 21-31, 2004 [in Lithuanian].
- [15] Sirvydis J. Production of herbaceous forage: monograph. Raudondvaris, 186 p., 2001 [in Lithuanian].