



Surface Shape Measurement by Grating Projection Method in Aerospace Structures

著者	HIGUCHI Ken, FUJIGAKI Motoharu, SHIOKAWA Takayuki, KISHIMOTO Naoko, IWASA Takashi
journal or publication title	Memoirs of the Muroran Institute of Technology
volume	64
page range	77-84
year	2015-03-13
URL	http://hdl.handle.net/10258/3782

Surface Shape Measurement by Grating Projection Method in Aerospace Structures

著者	HIGUCHI Ken, FUJIGAKI Motoharu, SHIOKAWA Takayuki, KISHIMOTO Naoko, IWASA Takashi
journal or publication title	Memoirs of the Muroran Institute of Technology
volume	64
page range	77-84
year	2015-03-13
URL	http://hdl.handle.net/10258/3782

Surface Shape Measurement by Grating Projection Method in Aerospace Structures

Ken HIGUCHI^{*1*2}, Motoharu FUJIGAKI^{*3}, Takayuki SHIOKAWA^{*4},
Naoko KISHIMOTO^{*5}, and Takashi IWASA^{*6}

(Received 28th November 2014, Accepted 22nd January 2015)

Abstract

To improve the accuracy of the grating projection method of a surface shape measurement method without contact, several attempts are proposed and verified. A whole-space tabulation method (WSTM) is demonstrated to measure a translucent glittering metallic mesh of a parabolic antenna for a radio astronomy satellite. A transparency method of the grating projection method is proposed to measure a glossy polymer film often used in space structures. An extrapolation method is proposed to measure a larger object than the reference planes. A pre-calibration can be used to adjust the measured value to the real values. The extrapolation method and the pre-calibration are demonstrated to measure a displacement of a wing of a developing airplane under loading.

Keywords: Surface Shape Measurement, Grating projection method, Whole-space tabulation method, Translucent metallic mesh structure, Polymer membrane structure, Aircraft structure

1 INTRODUCTION

Precise large aerospace structures have been required for future and contemporary aerospace mission. Especially, space structures need to be measured in situ on orbit precisely. Even in the case of the development phase of them on the earth, they have to be measured repeatedly within the rigorous accuracy requirement. They are often membrane structures or metallic mesh structures due to the requirements of light-weight and compactness during the transportation. Airplane surface also consists of flat planes and curved planes, and the large surface shape and the displacement under loading have to be measured easily with high precision.

A photogrammetric measurement using grating projection method^{1),2)} is a prospective candidate to satisfy such requirement. The grating projection method can measure the three-dimensional coordinates of an object by a pixel-to-pixel basis. So, the method can provide the surface shape of the object with a greatly high spatial resolution. The effectiveness is to investigate by measuring several aerospace structures in this paper.

2 MEASUREMENT PRINCIPLE

2.1 General principle of grating projection method and Whole-space tabulation method used for mesh measurement

Optical methods for performing surface profile measurements have been extensively studied^{3),4)}. A grating projection method is often used as a technique to measure the shape of an object without contact. Several phase analysis methods for grating projection method have been proposed⁵⁾⁻⁷⁾.

The calibration method is important for accurate shape measurement. Therefore, several methods that use a reference plane or planes for calibration have been proposed for accurate shape measurement⁸⁾⁻¹²⁾.

*1 Muroran Institute of Technology, College of Design and Manufacturing Technology

*2 Muroran Institute of Technology, Aerospace Plane Research Center

*3 Wakayama University, Faculty of System Engineering

*4 Wakayama University, Graduate student.

*5 Setsunan University, Faculty of Science and Engineering

*6 Tottori University, Faculty of Graduate School of Engineering

Some of the authors also proposed a whole-space tabulation method (WSTM)¹³⁾⁻¹⁵⁾ that uses reference plane repeatedly. This method excludes lens distortion and the intensity warping of the projected grating in measurement results theoretically.

In this study, the authors applied the WSTM to measure a translucent metallic mesh object. The specimen is an extendible large-scaled antenna used for radio astronomy satellite ASTRO-G, which is a space radio telescope in Japan. A grating pattern naturally transmits the translucent mesh object. The unnecessary transmitted grating pattern is taken by the camera, too. The transmitted grating pattern image and the reflected grating pattern from the surface of the object are superposed, and this causes measurement errors. This chapter describes an optical setup that avoids this problem.

Figure 1 shows the principle of the calibration of the grating projection method. Figure 2 shows schemata of the calibration tables of z coordinates from phase q , used in the WSTM. The phase interval of the table elements is chosen according to the required resolution of the coordinates. The coordinate of each table element is produced by interpolation.

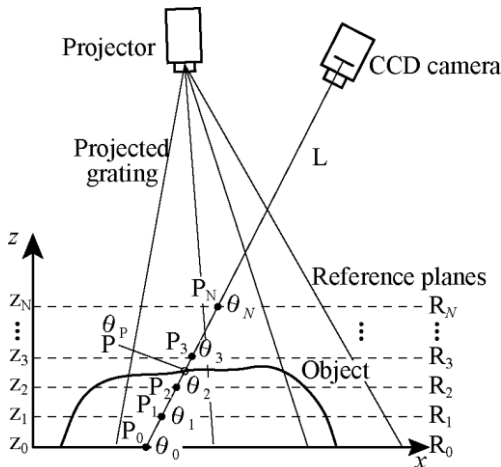

Fig. 1 Principle of the calibration method using whole-space tabulation

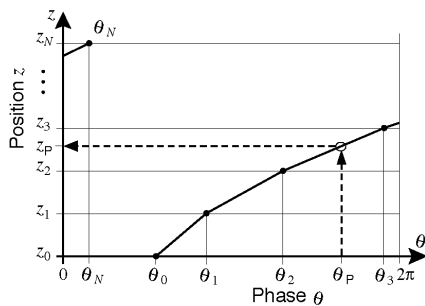

Fig. 2 Schema of calibration tables used to z -coordinates from phase q

The phase shifting method using Fourier transform (PSM/FT)¹⁵⁾ is useful for analyzing the phase of a projected grating for the following reasons.

- 1) The phase can be obtained from the change in brightness at a point regardless of the shape of a 3-D object.
- 2) The original pattern of an object does not influence the phase.
- 3) The accuracy is high because of the elimination of noise including that in high frequency components.

To expand measurable range, phases are applied unwrapping method¹⁶⁾.

2.2 Optical setup of mesh object

Figure 3 shows the optical setup of the measurement system. The distance from the camera to flat plane is 2,300 mm. The distance from the camera to the projector is 1,300 mm. The backlight is a switch for the fixed 2-D grating. When the switch is turned off, the fixed 2-D grating disappears. When the switch is turned on, the fixed 2-D grating appears. One of the purposes of the experiments was to confirm the measurement precision of the 90% light-permeable object. Phases are obtained even if the coordinate is out of measurable range on the back wall. Distinguishing the thing from the range where phase can be measured on the background is not possible. Using these phase distribution, wrong coordinates coexists with right coordinates. Figure 4 shows the panel setting for measurements of translucent object. The shadow of the panel avoids the background associated with using the panel.

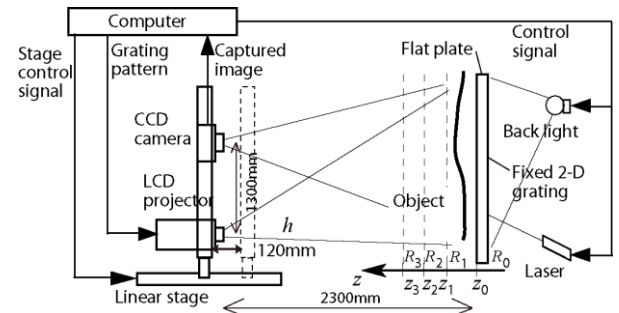

Fig. 3 Optical setup

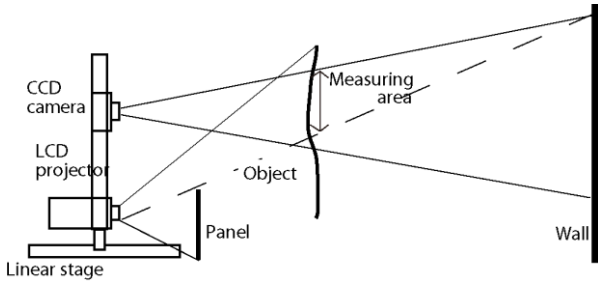

Fig. 4 Panel setting for measurement of translucent object

2.3 Shape measurement of mesh object with step model

Figure 5 shows a sample mesh object with known step distance. Figure 6 shows a step height distribution of the step mesh model. The red rectangular areas on each step in Fig. 6 are analysis areas. Images are thinned out from a size of 1600 x 1200 pixels to a size of 400 x 300 pixels. The table elements in the WSTM are divided into 1,200 elements, each 125 mm in size. Table 1 shows height distribution chart of the step mesh model. Table 1 shows the comparison of the z distribution at marker position on the mesh surface measured by a laser displacement meter. The translucent metallic mesh can be measured by the grating projection method.

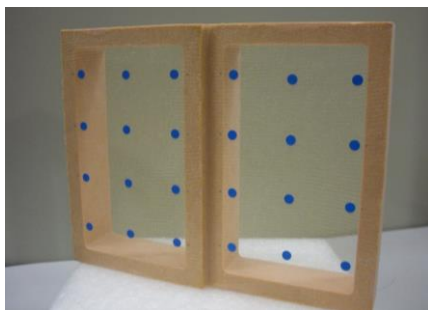

Fig. 5 Mesh model with known step

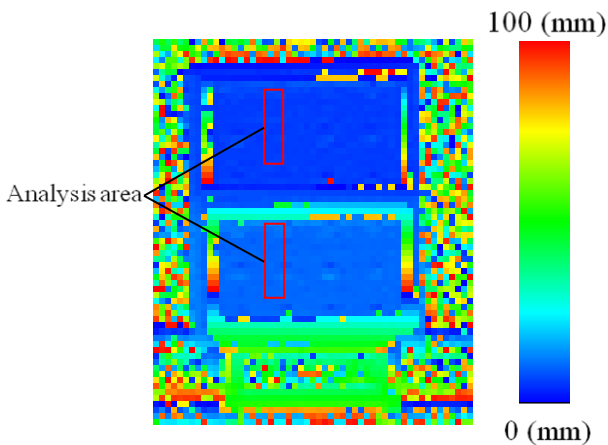

Fig. 6 Height distribution image of Fig. 5

Table 1 Comparison of height between proposed method and a laser displacement meter

	Grating Projection Method with WSTM		Measuerd by Laser Dsplacement Meter	
	1st Step	2nd Step	1st Step	2nd Step
Average Height	0.05	5.29	0.00	4.96
Standard Deviation	0.28	0.31	0.07	0.06
Step Difference	5.24		4.96	

Unit[mm]

2.4 Shape measurement of mesh parabolic antenna

A parabolic antenna used for a satellite is made of a translucent metallic mesh. The precise measurement of the profile irregularity of the parabolic antenna surface is important.

The aim of this experiments is to measure the mesh parabolic antenna. Figure 7 shows the mesh parabolic antenna object. Figure 8 shows a gratings image of the translucent and glittering metallic mesh parabola. Figure 10 shows an analytical photographic image of a parabolic mesh antenna. Figure 10 shows the phase distribution of Fig. 8. This phase distribution was obtained by PSM/FT with 10 and 16 pitches. Figure 11 shows a 3D model of the image featured in Fig. 8. Figure 12 shows a height distribution image of Fig. 8 by color. Figure 13 shows height distribution shown as lines A, B, C illustrated in Fig. 12. The x position of the bottom line ranges from -750mm to 750mm. The size of sample mesh and radio wave test model is 1.5m x 1.5m. Line A shown in Figs. 12 and 13 is upper area of antenna. Line B shown in Figs. 12 and 13 is middle area of antenna. Line C shown in Figs. 12 and 13 is neat to the bottom of the antenna. Measurement accuracy of this experiment is almost the same as experiment of section 2.3. Because of the optical setup of the measurement system is the same as experiment of section 2.3. Figure 14 shows height distributions comparison of a laser displacement meter to WSTM of the mesh parabolic antenna object.



Fig. 7 Parabolic mesh antenna for radio wave test model for ASTRO-G satellite

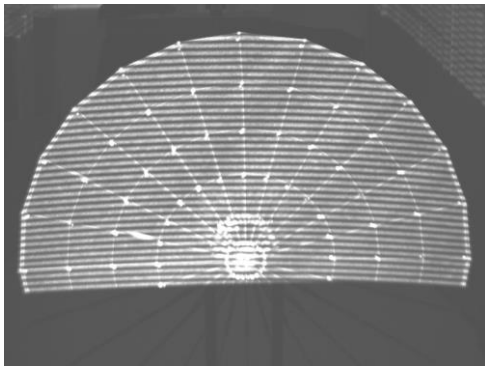

Fig. 8 Grating image of the mesh antenna

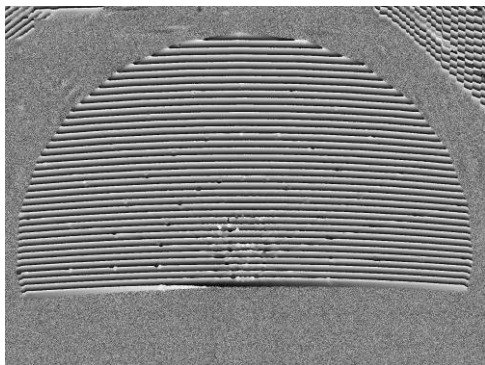

Fig. 9 Phase distribution

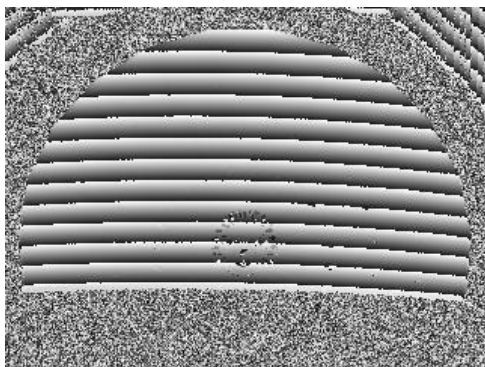

Fig. 10 Unwrapped phase distribution

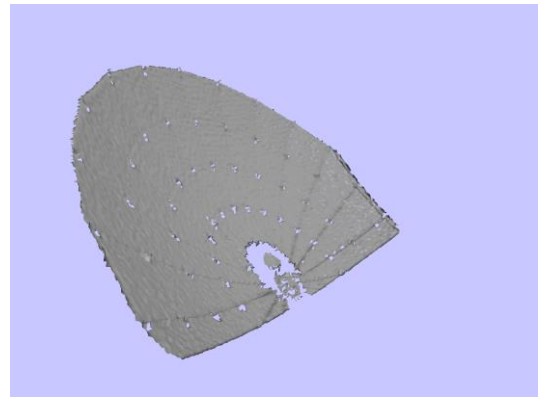

Fig. 11 3D-model of Fig.7

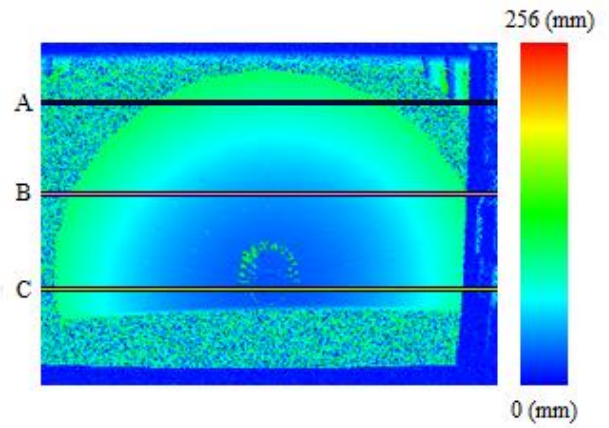

Fig. 12 Height distribution coloring image of the parabola

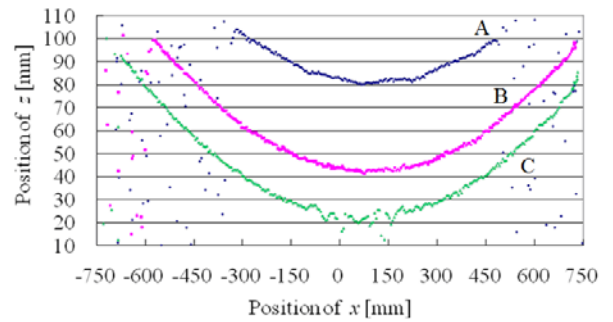

Fig. 13 Height distribution along lines A, B, and C in Fig.12

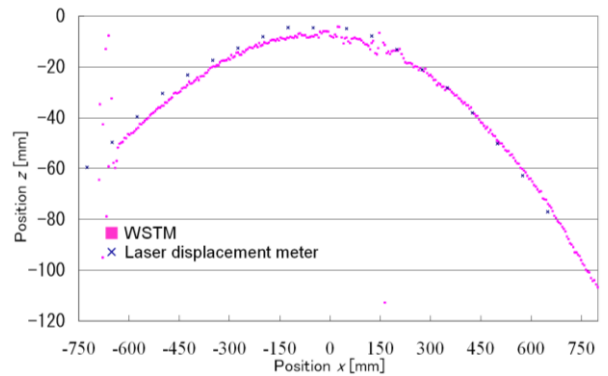
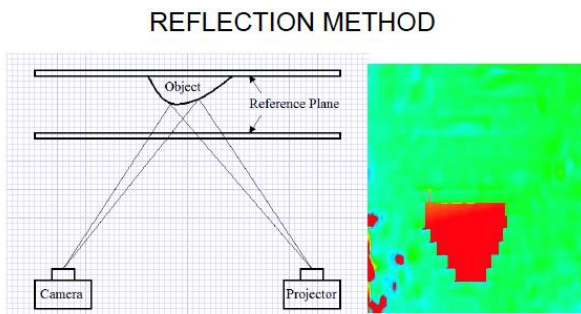

Fig. 14 Height distributions compare laser displacement meter and WSTM

3 TRANSPARENCE METHOD TO MEASURE GLOSSY FILM

Surface shape measurement by an optical method without contact should be applicable for a glossy surface, because space membrane structures are made of polymer film in many cases, and the surface is generally reflective and lambent. Grating projection method needs to light the measurement object by a projector, and the reflected light is photographed, so the gloss reflection of polymer film can be the cause of measurement error. The trial to utilize the grating pattern of the transmitted light through the object film is named here as ‘transparence method’ as against the normal ‘reflection method.’

A surface shape of a suspended rectangular polyimide film is measured to utilize the transmitted light to prevent the gloss effects for the measurement. Polyimide is mostly used film material in space structures. Figure 15(a) illustrates the apparatus set-up and the measurement result of the usual reflection method, and figure 15(b) shows the apparatus set-up and the measurement result of the proposed transparence method. The induction of glossy part in the reflection method is avoided and the whole area can be measured successfully by the proposed transparence method.



(a) Usual reflection method

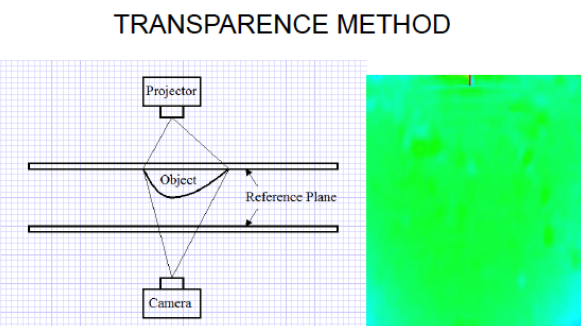

(b) Proposed transparence method

Fig. 15 Measurement setup of glossy film

4 EXTRAPOLATION MENTHOD TO MEASURE LARGE SUFFACE

In the case of a grating projection method, a measurement object has to be set between two reference planes, and the imaginary three-dimensional coordinates arise between the reference planes. The coordinate values are calculated by a linear interpolation. Therefore, the size of the measurable region is within the size of the reference planes. In the case that a large space structure has to be measured, the constraint condition that the reference plane must be larger than the measurement object should be prevented in the practical usage in orbit. The grating projection method needs two reference planes in principle, so an idea to put the measured object at the back of the two reference planes, and the three-dimensional coordinates of the object is calculated in an extrapolative manner. The method to measure the object larger than the reference planes by arranging it at the back of the two reference planes is called here as ‘extrapolation method,’ and the method of usual setup by arranging the measurement object between the two reference planes is called here as ‘interpolation method.’ The difference of the two setups is illustrated in Fig. 16.

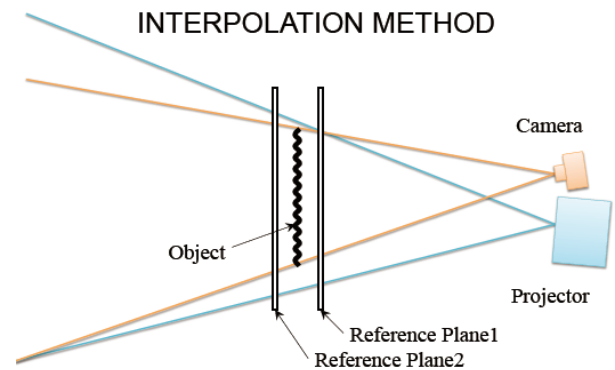

(a) Principle of interpolation method

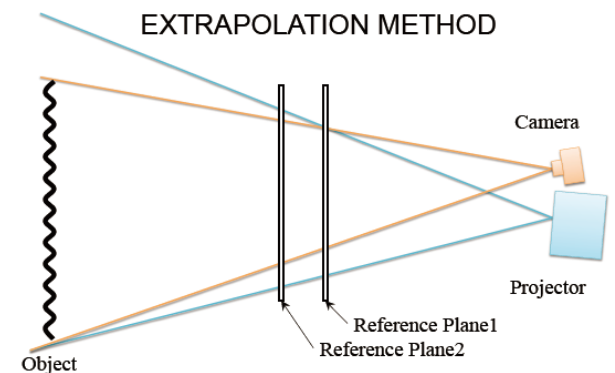

(b) Principle of extrapolation method

Fig. 16 Arrangement of grating projection method

The extrapolation method will be suitable for practical use in space to measure a large structure, however, the measurement accuracy seems to be degraded by the extrapolation. The proposition of the extrapolation method should be accompanied by some sort of accuracy improvement idea. Two improvement strategies are put forward: a geometrical calculation method of coordinate values and a pre-calibration method.

In the case of interpolation method, the coordinate values are calculated by an assumption of linear relation between the phase of the sinusoidal gratings and the object position. This assumption is beneficial, if the distance between the two reference planes is small and the measurement object is set within the two reference planes. The assumption, however, does not hold good, if the linear extrapolation does not work well.

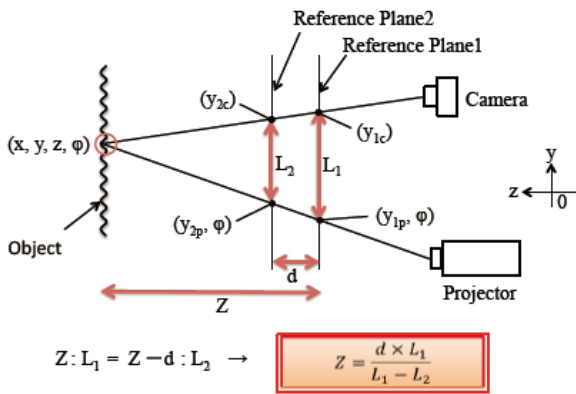

Fig. 17 Geometrical calculation of position of object surface from phase of reflected gratings

A strategy to measure the object position precisely is based upon the geometrical calculation according to the strict definition of position. The coordinate value of object can be determined geometrically, as shown in Fig.17, without any approximation. This is true and applicable even for the object between the two reference planes as usual grating projection method, although usually a linear interpolation calculation to obtain the coordinate values is much easier than the geometrically strict calculation, as long as the linear interpolation can keep good accuracy.

A second improving strategy is the活用application of pre-calibration. In the case of pre-calibration method, each known position is preliminary measured step by step, and the calibration table between the measured values and true values is made. The

measured object surface is calibrated with reference to the calibration table.

Figure 18 shows the correction degree of the pre-calibration values and the geometrical calculation in reference to the true values. The geometrical calculation does not necessarily 必要need the pre-calibration even in the case of the extrapolation method, according to the accuracy requirement. The pre-calibration method, however, is easy to apply without the rigorous geometrical calculation.

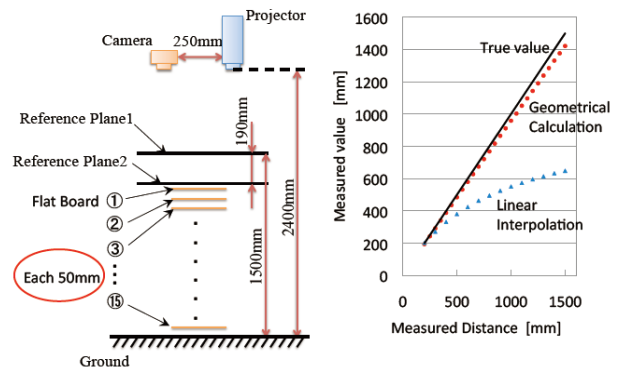

Fig. 18 Pre-calibration and the correction table

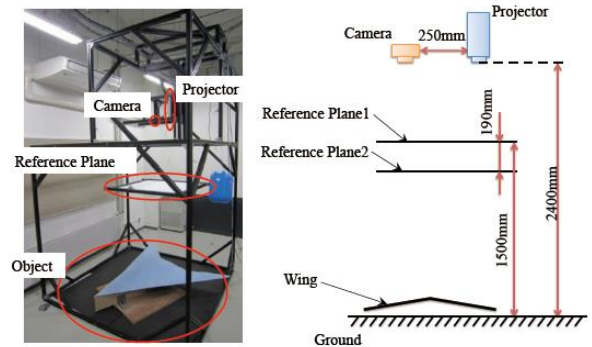

Fig. 19 Measurement example of a large object by the extrapolation method

Figure 19 shows the measurement example: the displacement measurement of a main wing of an aircraft under loading. The aircraft is Oowashi No.1, which is a prototype under development aiming at supersonic flight in Muroran Institute of Technology, Aerospace Plane Research Center (APReC) as shown in Fig. 20. The measured displacement is compared with the true value measured by a slide caliper, as shown in Figs. 21, 22 and table 2. The accuracy is practically good enough.

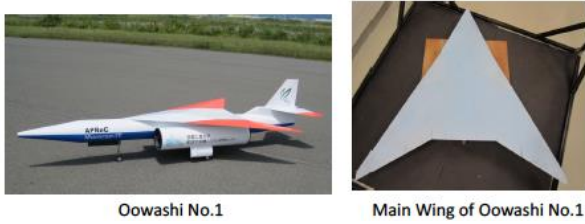
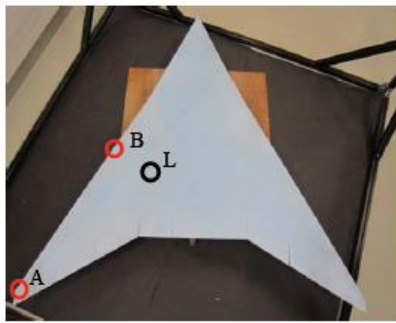

Fig. 20 Oowashi No.1 prototype aircraft



L : LOADING POINT
 A,B : MEASURED POINTS BY VERNIER CALIPER
 CORD LENGTH: 1390mm
 WING SPAN: 1610mm

Fig. 21 Measurement points of displacement on the wing of an aircraft

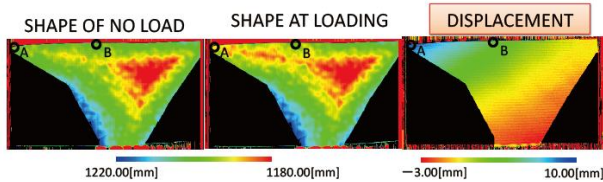

Fig. 22 Measurement results of displacement of a wing under loading as a large plate structure by the extrapolation method

Table 2 Comparison of displacement measurement in Fig.22

	DIAPLACEMENT BY GAUGE [mm]	DISPLACEMENT BY PROPOSED METHOD [mm]	ERROR [mm]
POINT A	9.96	9.36	-0.60
POINT B	5.53	4.94	-0.45

5 CONCLUTIONS

The grating projection method can provide high accuracy to measure 3-D shape of even a translucent and glittering metallic object. In this study, the WSTM was applied to measure precisely the shape of a

translucent metallic mesh antenna of parabolic surface used for a radio astronomy satellite. The effectiveness of this method for shape measurement of such a surface nature object was confirmed in high precision, although the grating projection method was thought to be inappropriate for such an object of a translucent and glittering metallic mesh.

A surface shape of glossy polymer film often used in space structures can be measured by using the proposed transparence method of the grating projection method.

An extrapolation method was also proposed to measure large space structures. The extrapolation method can measure larger object than the reference planes. In this case, two accuracy improvement strategies are proposed. One is a pre-calibration method, and a second is a geometrical calculation method to get the coordinate values without approximation. The extrapolation method, with the geometrically strict calculation and the pre-calibration, was applied to measure the displacement of a main wing of an aircraft under loading.

ACKNOWLEDGMENT

This study was partly funded by Grant-in Aid for Scientific Research by the Japanese Ministry of Education, Science and Culture. This study was also partly funded by ISAS/JAXA's Strategic Research Grant.

REFERENCES

- (1) Tay, C.J., Thankur, M. and Quan, C.: Grating Projection System for Durface Contour Measurement, *Applied Optics*, (2005), **44**, 8, pp.1939-1400.
- (2) Fujigaki, M. and Morimoto, Y.: Shape Measurement with Grating Projection Using Whole-Space Tabulation Method, *Journal of JSEM*, (2008), **8**, 4, pp.92-98. (in Japanese).
- (3) Chen, F., Brown, G. M. and Song, M.: Overview of Three-dimensional Shape Measurement Using Optical Methods, *Opt. Eng.*, **39**-1 (2000), 10-22.
- (4) Tomohiro, S.: Profile Measurement and Analysis Technology Employing Laser Beam, *Japan Science and Technology Agency*, **57**-8 (2006), 559-563.
- (5) Takeda, M. and Mutoh, K.: Fourier Transform Profilometry for the Automatic Measurement of 3-D Object Shapes, *Applied Optics*, **22**-24 (1983), 3977-3982.
- (6) Asundi, K. and Zhou, W.: Mapping Algorithm for 360-deg Profilometry with Time Delayed Integration Imaging, *Optical Engineering*, **38**-2 (1999), 339-344.
- (7) Sitnik, R. and Kujawinska, M.: Digital Fringe Projection System for Large-volume 360-deg Shape Measurement, *Optical Engineering*, **41**-2 (2002), 443-449.

- (8) Zhou W.-S., Su X.-Y.: A Direct Mapping Algorithm for Phase-measuring Profilometry, *Journal of Modern Optics*, **41-1** (1994), 89-94.
- (9) Asundi, A. and Wensen, Z.: Unified Calibration Technique and its Applications in Optical Triangular Profilometry, *Applied Optics*, **38-16** (1999), 3556-3561.
- (10) Su, X. Song, W. Cao, Y., and Xiang, L.: Phase-height Mapping and Coordinate Calibration Simultaneously in Phase-Measuring Profilometry, *Optical Engineering*, **43-3** (2004), 708-712.
- (11) Ha, T., Takaya, Y., and Miyoshi, T.: High-precision On-machine 3D Shape Measurement Using Hypersurface Calibration Method, *Proc. SPIE*, 5603 (2004), 40-50.
- (12) Yen, H. N., Tsai, D. M., and Yang, J. Y.: Full-field 3-D measurement of solder pastes using LCD-based Phase Shifting Techniques, *IEEE Transactions on Electronics Packaging Manufacturing*, **29-1** (2006), 50-57.
- (13) Fujigaki, M. and Morimoto, Y.: Shape Measurement with Grating Projection Using Whole-Space Tabulation Method (in Japanese), *Journal of JSEM*, **8-4** (2008), 92-98.
- (14) Fujigaki, M., Takagishi, A., Matui, T., Morimoto, Y.: Development of Real-Time Shape Measurement System Using Whole-Space Tabulation Method, SPIE International Symposium, *Proc. SPIE* 7066, (2008), 706606.
- (15) Morimoto, Y. and Fujisawa, M.: Fringe Pattern Analysis by a Phase-shifting Method Using Fourier Transform, *Opt. Eng.*, **33-1** (1994), 3709-3714.
- (16) Asai, D., Miyagi, T., Fujigaki, M. and Morimoto, Y.: Expansion of Measuring Range by Phase Unwrapping of Shape Measurement with MEMS Scanner Grating Projector (in Japanese), *Journal of JSEM*, **10-1** (2010), 74-81.
- (17) Takayuki SHIOKAWA, Yoshiyuki SHIOJI, Motoharu FUJIGAKI, Ken HIGUCHI, Naoko KISHIMOTO, Yoshiharu MORIMOTO and Akihiro MASAYA: 5th International Symposium on Advanced Science and Technology in Experimental Mechanics, 4-7 November, 2010, Kyoto, Japan.

航空宇宙構造分野における格子投影法による表面形状計測

樋口 健^{*1*2}, 藤垣元治^{*3}, 塩川貴之^{*4}, 岸本直子^{*5}, 岩佐貴史^{*6}

概要

航空宇宙構造分野の表面形状計測に有利と思われる格子投影法の適用分野拡大と高精度化を目指していくつかの提案を行い、それらの試みを実際の計測に適用し、精度検証した。まず高精度化のために全空間テーブル化手法を用いた。適用例として、光学計測には困難と思われる、透過性が大きくかつ金属光沢のある金属メッシュでできた衛星搭載電波望遠鏡パラボラ面に適用し、その精度検証を行ったところ、満足する高精度計測ができた。樹脂フィルムは宇宙構造物に多用されるが、光沢があるため、投影した格子の反射光を撮影する格子投影法では光沢の部分はエラーとなり計測できない領域となる。投影した格子の透過光を撮影することにより、光沢がある樹脂フィルムの形状を計測できることを示した。格子投影法の計測対象物の大きさは基準面の大きさに制約されるが、座標位置の算出に基準面間の内挿の代わりに基準面外へ外挿を行うことにより、基準面より大きい対象物を計測できる。ここで、外挿に伴う計測精度劣化を補償するため、近似を用いない厳密な座標値取得方法を適用し、また真値をテーブル化しておき計測値と比較する手法を適用し、外挿法においても高精度に計測する手法を提案した。適用例として、室蘭工業大学航空宇宙機システム研究センターで開発したオオワシ1号機の主翼の荷重変位関係を得る実験に用い、実測値との比較を行った。

キーワード：表面形状計測，格子投影法，全空間テーブル化手法，透過性金属メッシュ構造，高分子膜面構造，航空機構造

*1 室蘭工業大学もの創造系領域，*2 室蘭工業大学航空宇宙機システム研究センター，*3 和歌山大学システム工学部，*4 和歌山大学大学院修了，*5 摂南大学理工学部，*6 鳥取大学大学院工学研究科