

2023-07-24

IoT-based on boiler fuel monitoring system: A case of Raha Beverages company limited, Arusha-Tanzania

Ntambara, Boniface

Research Square

doi.org/10.21203/rs.3.rs-3167311/v1

Provided with love from The Nelson Mandela African Institution of Science and Technology

IoT-Based on Boiler Fuel Monitoring System: A Case of Raha Beverages Company Limited, Arusha-Tanzania

Boniface NTAMBARA (✉ bonifacen@nm-aist.ac.tz)

Nelson Mandela African Institution of Science and Technology

Devotha Nyambo

Nelson Mandela African Institution of Science and Technology

Andreas Solsbach

Carl von Ossietzky University of Oldenburg

Research Article

Keywords: Remote Fuel Monitoring System, GSM technology, IoT systems, ThingSpeak Platform, ATmega 328 Microcontroller.

Posted Date: July 24th, 2023

DOI: <https://doi.org/10.21203/rs.3.rs-3167311/v1>

License:  This work is licensed under a Creative Commons Attribution 4.0 International License.

[Read Full License](#)

Additional Declarations: No competing interests reported.

IoT-BASED ON BOILER FUEL MONITORING SYSTEM: A CASE OF RAHA BEVERAGES COMPANY LIMITED, ARUSHA-TANZANIA

Boniface NTAMBARA^{1*}, Member, IEEE, Devotha Nyambo¹, Andreas Solsbach²

Abstract— RAHA Beverages Company (RABEC) is one of the banana wine production companies that utilize fuel in steam production in Arusha-Tanzania where fuel data conditions like temperature, pressure, discharge, fuel level, and gas leakage with humidity were a challenge to monitor them which provoked boiler malfunction and plant breakdown. Today, RABEC manually uses a dropping stick into the fuel tank to monitor fuel data conditions which is time-consuming and gives inaccurate readings, inefficiency, fuel economy discrepancy, and accidents. This study aimed to design and develop an IoT-based fuel monitoring system. The flow meter, ultrasonic level, thermistor fuel temperature, humidity, and pressure sensors were used to gather fuel information where GSM module was employed to send fuel data messages to the operator's phone. An AT mega 328 microcontroller was used to process and analyze the fuel data and send them to the Thing Speak IoT platform using Wi-Fi connectivity. The results showed that when the fuel level was less than the threshold value, an operator was alerted by a refilling message via GSM technology. At 0.1Psi pressure, fuel temperature of 120°C, and 80% humidity, the system notifies the operator by an alert message to check injector pressure and if the fuel-air mixture was perfect. In addition, these data were observed on LCD and ThingSpeak webpage. To conclude, the developed system proved the best performance with a 99.98% of success rate with high accuracy, security, and efficiency rate compared to the current monitoring system.

Index Terms— Remote Fuel Monitoring System, GSM technology, IoT systems, ThingSpeak Platform, ATmega 328 Microcontroller.

I. INTRODUCTION

Fuel is considered one of the most significant consumables in the beverage manufacturing industry, and it is critical to the economics of wine processing operations. To ensure that the fuel volumes in the industry's tank during the steam process are correct and valuable, a fuel monitoring system is necessary [1]. In addition, the mechanical heat exchangers (boilers) utilize the fuel heat or waste heat energies from the factory output to steam the working medium to a given temperature and pressure. Moreover, there are innumerable inadequacies in the industrial boiler system used by RAHA Beverages Company Limited, such as a lower level of automation, greater fuel usage, discrepancies in fuel economy at the same production, serious pollution, inefficiencies, and accident proneness [2]. An IoT-based fuel monitoring system that uses IoT-enabled sensors could enable industry users to remotely monitor fuel usage and other fuel parameters and identify fuel drawbacks like leakages or excessive idling, and maximize fuel efficiency [3]. Through the insertion of sensors, the real-time state parameters of the RAHA Beverages Company Limited fueling system can be collected and transmitted to the remote management platform or webpage using an IoT web server platform like ThingSpeak. Furthermore, the monitored fuel utilizations in the ignition

process can be safe and efficient when fuel parameters like fuel temperature and pressure can be analyzed, determined, and investigated remotely where the operational situation of the monitored fuel boilers can be instantaneously and in real-time released on the internet through a webpage [4]. The operational cost of the fuel matters the most in RABEC Ltd. The increased cost of steam generation using fuel results in higher and this can be optimized by using real-time fuel monitoring and data analytics using IoT web access. The fuel tracking strategy is critical in RABEC Ltd.'s production plant, which operates to feed steam on a frequent basis for the manufacturing process [5]. Manual fuel monitoring systems without remote access and control, or with limited remote access, prevent real-time decision-making and quick emergency response. Fig. 1 shows the manual measurements of fuel that come with inherent risks where the RABEC fuel tanks are tall structures and the risk of falling is very real.

Devotha Nyambo and Andreas Solsbach contributed equally to this work.

Boniface NTAMBARA, bonifacen@nm-aist.ac.tz, bonifacen@ieee.org, Devotha Nyambo, devotha.nyambo@nm-aist.ac.tz, Andreas Solsbach, andreas.solsbach@uni-oldenburg.de

¹School of Computational and Communication Science and Engineering (COCSE), The Nelson Mandela African Institution of Science and Technology, P.O Box 447 Arusha, Tanzania,

² Department of Computing Science, University of Oldenburg, Ammerländer Heerstr; 114-118; 26129 Oldenburg-GERMANY

¹Corresponding Author, ORCID: <https://orcid.org/my-orcid?orcid=0000-0001-9915-5421>



Fig. 1. RABEC Fuel monitoring (a) using a stick and a manual meter (b) descent of the RABEC operator from the top of the fuel tank.

Based on previous research, shows that the existing monitoring systems comprise a lot of limitations such as time consumption, human errors, inefficiency, inconvenience, and poor monitoring. The manual monitoring systems without remote access and control, prevent real-time decision-making and quick emergency response. Additionally, fuel and oil tanks are prone to hazardous fumes that are not only bad for the lungs but also combustible. So, reducing human intervention will reduce the risk of injury across the board [6]. Therefore, this study aimed at developing an IoT-based fuel monitoring system that should monitor the fuel temperature, fuel pressure, and humidity of fuel so that the operator and or operation manager can be easier to monitor the fuel parameters via a web page and short message service to increase the fuel efficiency and effective fault check as soon as possible. The enhanced fuel monitoring system with high performance has been compelled for remote monitoring for fuel system applications in order to improve perfect fuel combustion to the RABEC Limited [7]. The current RABEC fuel monitoring readings are inaccurate and inconsistent because of the high prevalence of misreading and high accidental risks during fuel level measurement which can provoke death and abrupt industry plant breakdown. Furthermore, the existing fuel monitoring system is regarded as inefficient and imprecise difficulties which might be circumvented and cleared up securely with remote intelligent technology including GSM technology and the Internet of Things (IoT). The analysis of industrial fuel monitoring markets demonstrated that integration and deployment of remote fuel monitoring methods are key topics in this paper. Various researchers have investigated these services and infrastructures using various fuel monitoring frameworks. All of these real-time fuel monitoring systems presented in the fuel monitoring study's review of the literature had advantages and disadvantages. The applicability of optimum monitoring theories showed that an IoT-based fuel monitoring system can dynamically improve fuel monitoring challenges. To prove an IoT-based fuel monitoring system performance in a wider range variation in fuel monitoring parameters is the far more important motivator in this research paper.

This study is divided into four main parts. Initially, it provides an overview of fuel monitoring problems in RABEC Limited, as well as the inspiration and innovation of the developed IoT-based fuel monitoring system. Second, previous outcomes in fuel monitoring schemes are intermittently described and evaluated, including the manual fuel and remote monitoring frameworks. It also designates previous research drawbacks

and proposes an innovative approach to solving the issues. Third, the components and methodological approach for resolving fuel monitoring concerns were discussed and addressed where a novel IoT-based fuel monitoring system with different fuel data conditions is premeditated and highly developed. Fourth, the research paper suggests and considers an alternative for the hardware and software requirements of the developed prototype with sensing and actuating unit' integration and deployment. The proposed and developed IoT-based fuel monitoring system is compared with the current monitoring strategy by testing the performance. Finally, the final view and plans for further work are substantiated and documented.

II. REVIEW OF RELATED WORKS

It has been suggested to use an embedding system to build and deploy a GSM-based computerized fuel monitor and fuel fraud tracking as shown in [8]. To maintain accountability for the amount of fuel in the tank, the cloud-based technique was employed. When fuel fraud is detected, the sensor generates a notification, and a real-time text message is sent to the owner, who is monitoring the forgeries. An Arduino-based sensor for fuel tank monitoring was developed [9]. The technology demonstrator device might be effective in the automotive sector, where it can be used to quantify fluid balance using an LED indicator. The device's accuracy and reliability are constrained through the use of passive components for both identification and detection. The Control System for Wirelessly Accurate Measurement and Monitoring of Fuel Usage Using an Integrated System has been created and developed by [10]. This method used the ultrasonic sensor for a height of tank measurement together with a water flow sensor for fuel level monitoring. The Arduino microcontroller was attached for system control and collects the sensor data and then analyzes the data via a web page. The system has drawbacks such as inaccuracy, poor calibration, poor data transfer, and unreliable. The Fuel Management System was also developed as indicated by [11]. The system makes use of a microcontroller-based fuel monitoring and reed switch that still operates on the Hall Effect principle to figure out how much fuel in the tank and fuel volume consumed, and the fuel data is then preserved in onboard storage. In this technology, an embedded guidance system with diverse duties was created to monitor the fuel level. The difficulties of insensitive and inefficient of this system design have been identified and reported. Fuel monitoring with a resistive float model sensor was conventionally used as an indicator system to verify the fuel threshold in the tank. The transmitter unit model was responsive to quantifying fuel level while the gauge unit module was responsible for displaying that quantified level and sending the information to the driver [12]. These fuel thresholds concerned with the identification sensors are widely utilized in the brewing and wine-making industries. These detectors are mechanically linked to a float that moves upward and downward in response to fuel levels. The susceptibility of the sensor changes as the float moves, and the needle's position changes in response to the passage of energy via the coil. The drawback of the resistive contact-based detector element is sensing wear and damage induced by the sliding contact within the sensor elements, which also affects

the sensor lifespan [13]. The fuel monitoring system based on the industrial internet of Things (IIoT) was developed and equipped with two-way remote monitoring and management technology such as Easy IO (Johnson Controls) and BMS technologies respectively. This technology plays an important role in delivering efficiencies by managing fuel that's required and monitoring the performance of the industrial boiler, then creates a cost-saving, eliminating the necessity for an engineer to attend site for various tasks. The Easy IO modem sends data on the boiler's gorge meter and fuel levels to the cloud-based management software (BMS), then the operator got alerted via the BMS software and finally, the operator makes changes to the boiler remotely. This monitoring system technology allows the industry to monitor fuel levels and alert teams when fuel is low easily by predicting fuel usage by utilizing this BMS software to predict the fuel usage and display the fuel data on a gauge [14]. This monitoring system is not providing real-time output in case an operator is away from the industry during shift working hours. The fuel level monitoring computerized technique was piloted by [15]. This method made use of an Arduino microcontroller connected with ultrasonic and LM35 sensors to sense and illustrate the tank level and fuel temperature respectively. The designed system was capable of displaying the number of fuel liters used and remaining, monitoring and measuring fuel tank levels, and detecting fuel tank temperature. However, this method was inefficient because the fuel monitoring sensor was unable to provide accurate results during the calibration process and this LM35 temperature is poor to detect fluid fuel temperature due to its calibration problems. An IoT-based system to monitor fuel storage tanks in the brewery industry has been proposed. The system utilized an ultrasonic sensor, Blynk application, and Node MCU but this method was limited to only can monitor 10 liters of fuel tank capacity and was unable to detect the fuel tank condition like humidity [16]. The current fuel monitoring system proves insensitivity, inefficiency, ineffective, and inaccurate for fuel data readings and fuel parametric conditions where the monitoring scheme persisted to employ a real-time monitoring system which is really inefficient and far less safe, as well as poorer production and compared to the sophisticated remote fuel monitoring system using IoT technology, as well as a high computational time and process for the network. The objective of this study was to design and implement a novel IoT-based fuel monitoring system that any assigned plant operator has to login into the system and access fuel data conditions on the ThingSpeak platform where also they should be displayed on LCD with short message service notification of fuel data conditions water. This study also aimed to develop a remote fuel monitoring system that will enable RABEC Limited to improve fuel-air mixture perfection during the steam production process and minimize unbanned fuel amounts while eliminating the monthly daily reading time and stresses at the plant operator side. The developed IoT-based fuel monitoring system also presented enhanced and optimized fuel monitoring systems to the RAHA Beverages Company Limited.

III. MATERIALS AND METHODS

3.1 System design view

The ATmega 328UP microcontroller was chosen due to its high efficiency, compact size, really good performance, and configurability. It was powered by 5VDC from 220AC buck converted where the sensing and actuating units have sent fuel data to this microcontroller for storage, processing, and analysis purpose. These fuel data conditions were also transferred to the cloud storage using the ESP Wi-Fi internet module for data integration and visualization where fuel conditions were monitored and analyzed. The ultrasonic sensor was used to measure the fuel level within the fuel tank by delivering the transmitter signal to the fuel in the tank and returning the signal information, which was then sent to the ATmega 328 microcontroller for processing. The flow rate sensor was employed to measure the fuel flow rate in order to detect the amount of fuel used per hour. The pressure and thermistor sensors were labored to sense the fuel pressure and fuel temperature respectively. The DHT 22 sensor was also maneuvered to measure the fuel tank humidity to detect any kind of moisture in fuel that may cause all sorts of issues that can lead to unplanned downtime and boiler failure. The GSM module was utilized to send the fuel parameters like fuel temperature, fuel pressure, and fuel usage using SMS to the mobile phone where the boiler operator can get fuel conditions and display them to the LCD. The buzzer was used also to alert if the fuel was reached below the predefined fuel value. Figure 2 indicates the overall system design view that was developed in this paper.

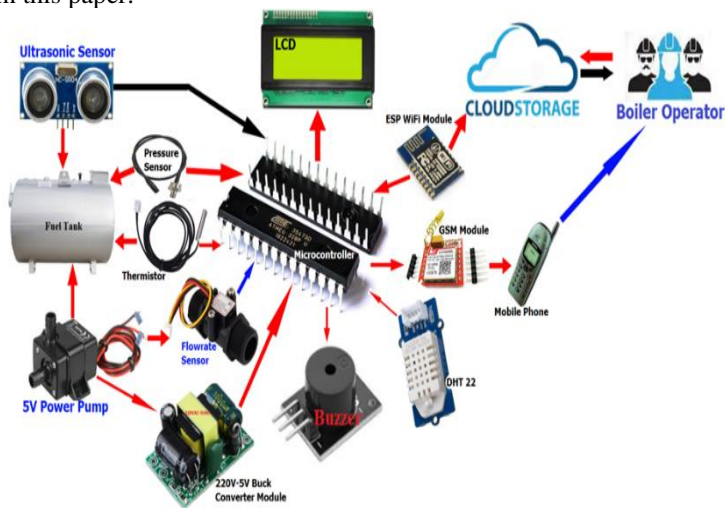

Fig. 2. System conceptual design.

3.2 Block Diagram

Figure 3 depicts the proposed system's block design, in which all sensing and actuating devices were connected to the microcontroller and activated. The 5VDC submerged pump was powered to increase the speed of moving fuel to reach faster to the ignition point and gets ignited to the boiler. The sensed and actuated data were conducted and processed by a microcontroller and sent to the cloud storage webpage via a Wi-Fi module for data analysis, storage, and visualization. The boiler operator was able to access the fuel data conditions using a mobile phone via a GSM module.

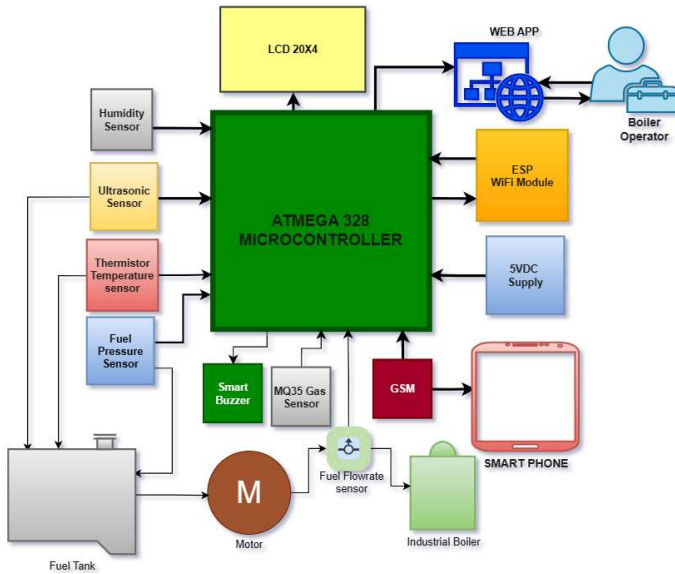

Fig. 3. Block diagram of the proposed system.

3.3 Use Case System Design

The system started by switching ON to power all connected sensing and actuating units. As fuel flows through the pipe from fuel tank to boiler, the motor pumped the fuel to increase the fuel flows. The operation manager and boiler operator were assigned to observe fuel parametric conditions such as fuel temperature, fuel pressure, fuel level tank, fuel usage, fuel humidity, and environment temperature. In addition, these fuel conditions have to be sent to the assigned operator via GSM communication technology and wait for the buzzer to generate an alert regarding any abnormal condition. Any assigned operator/manager was able to log in to the ThingSpeak platform to access the fuel data in order to visualize, aggregate, and analyze these fuel data conditions. Then, the user was able to log out after all fuel observation activities from the ThingSpeak platform. Fig. 4 illustrates the use case diagram of the developed system which describes how the boiler operator and operation manager interacted with the system and the role of each actor.

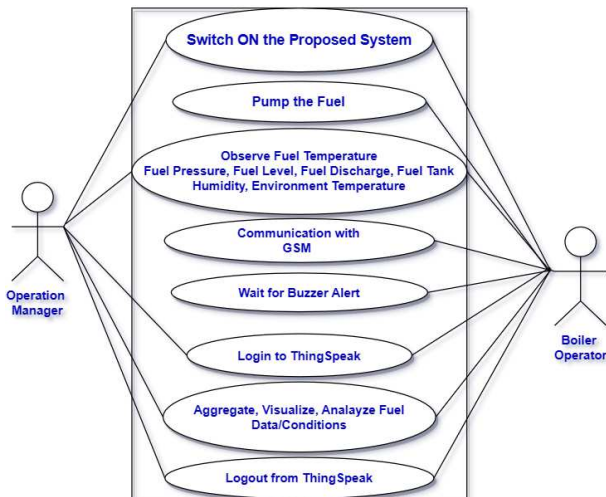

Fig. 4. System Use Case diagram.

3.4 Flow chart diagram for Hardware

The software design system is partially built-in on the IoT ATmega 328UP microcontroller due to its great efficiency, compactness, impressive performance, and configurability. Firstly, this ATmega 328 microcontroller was powered by a 5VDC power supply, and then all connected sensors (Flowrate sensor, DHT 22 sensor, ultrasonic sensor, pressure sensor, GSM module, thermistor sensor, MQ35 gas detection sensor, LCD), and ESP 32 Wi-Fi module got activated. The DHT 22 sensor detects and measures any type of fuel tank humidity. The ultrasonic sensor transmits the signal to check the fuel level within the fuel tank and receives the receiver signal, and then calculates the distance traveled based on the transmitting and receiving signals. MQ35 sensor detects any form of gas that circulates around the boiler to prevent any hazardous and harmful faults. The flow rate sensor was used to calculate the amount of fuel going from the fuel container to the boiler in order to know the fuel usage on an hourly and daily basis. All sensed fuel information was processed and analyzed by the microcontroller and transmitted to cloud storage through a Wi-Fi module for visualization and analysis by a designated operator/manager. The operator's mobile phone receives fuel data messages via GSM technology and then after, displayed on LCD. A boiler operator should be able to access these data through the ThingSpeak webpage. If the amount of fuel in the tank is less than the threshold value, the buzzer sounds, and an SMS is sent to any nominated boiler operator or operation manager through the GSM module to refill the fuel tank with other alerting information messages. Other conditions were set that if the pressure is higher than the threshold and the fuel temperature is greater than the settable value, the system sent an SMS to the operation manager for a diagnosis alert and sent the corresponding values to the cloud. Fig.5 depicts a flowchart diagram of an IoT-based fuel monitoring system that was built and constructed to aid in the implementation of the system in this paper.

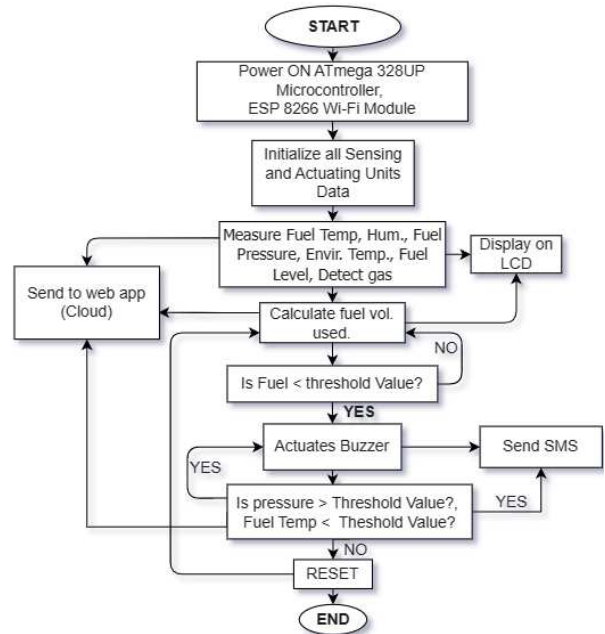

Fig. 5. Developed System Flowchart.

IV. RESULTS AND DISCUSSION

4.1 WEB-BASED APPLICATION SYSTEM RESULTS

The proposed web-based application includes the login and dashboard pages. This web-based application is designed to enable data transfer from the system. The boiler operator/operation manager was assigned with login credentials where these users can change the password for both security and preferences reasons which it demonstrates a sense of easiness of the developed system. Fig. 5 shows the login page by entering the email address and clicking next which all assigned boiler operators and managers can log in and fig. 6 indicates an assigned operator entering the password and clicking sign in.

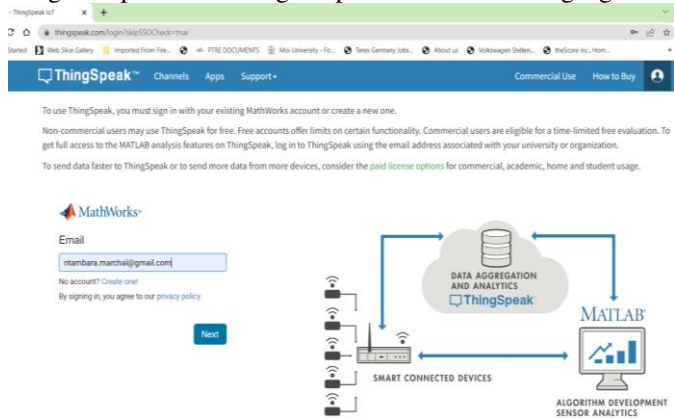

Fig. 6. Login page.

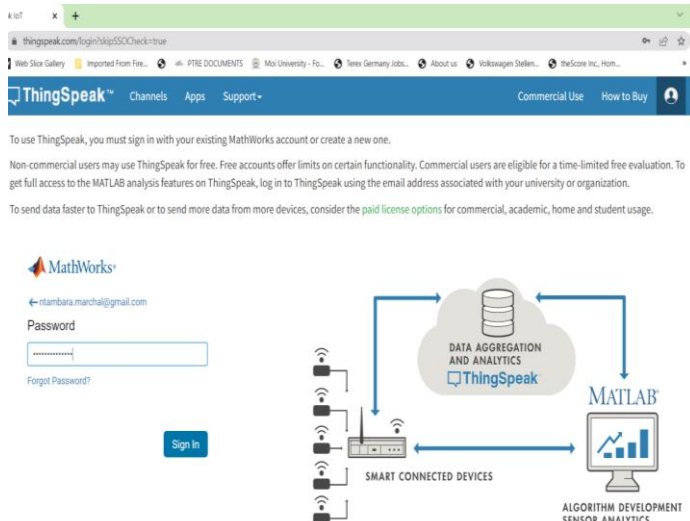

Fig. 7. Entering Password then click Sign In.

Fig. 8 shows that the Signing In was successfully done.

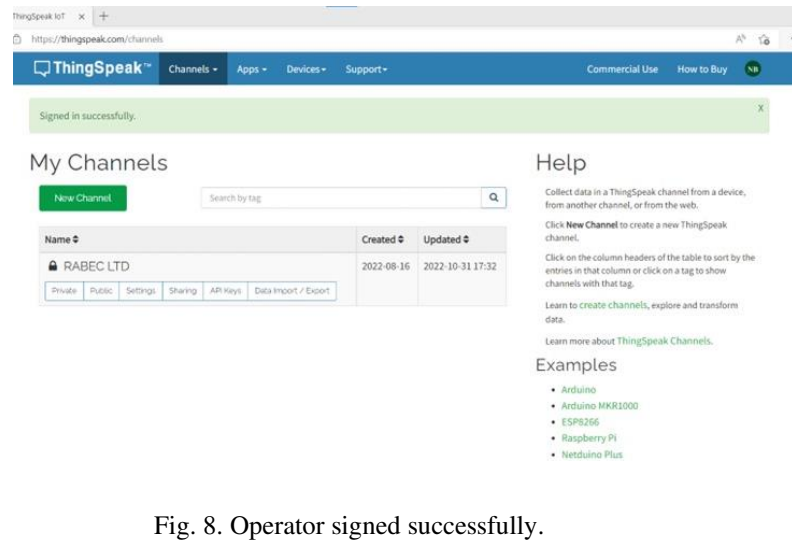

Fig. 8. Operator signed successfully.

Fig. 9 shows that an operator was able to access fuel temperature, fuel pressure, fuel tank humidity, gas detection, and fuel tank level monitoring system on the ThingSpeak.



Fig. 9. Fuel data condition visualization.

4.2 HARDWARE DEVELOPMENT RESULTS

4.2.1 Liquid Crystal Display (LCD) I2C testing results

The LCD was able to display the environment temperature (°C) where the boiler is installed, fuel temperature (°C), fuel pressure (Psi), humidity (%), fuel remaining (L), and display also if there is gas leakage or not. From the test experiments, the environment temperature (EnvTemp) was 31.8°C while fuel

temperature (Fuel Temp) was 29°C and the humidity (Rh) was 38%. The fuel level resealed by the ultrasonic unit (LV) was 52cm as the unit tank length while the remaining fuel in the tank (L) was 127.7 Liters. This fuel test indicates that the fuel pressure was 0.2 psi. In addition, the system proved that there was no gas detected with normal range temperature while the fuel level was good. The fuel-air mixture was perfect. Fig. 10 shows all fuel parameters as sensed by the connected sensing units and displayed in LCD where the fuel monitoring conditions are properly fine. Fig. 11 indicates when the system demonstrates the abnormal fuel temperature of 105°C, gas detected, and poor fuel pressure of -0.1Psi.



Fig. 10. LCD testing results (a) fuel data and (b) fuel condition updates to a display.

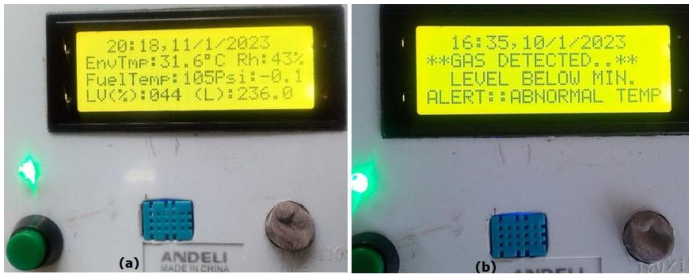

Fig. 11. LCD with (a) abnormal fuel conditions (b) Alert notification display.

4.2.2 Ultrasonic sensor testing results

The ultrasonic sensor sensed any level increased or decreased according to the fuel usage within the fuel tank and sent the percentage level to the ThingSpeak at every change as it is shown in fig. 12.

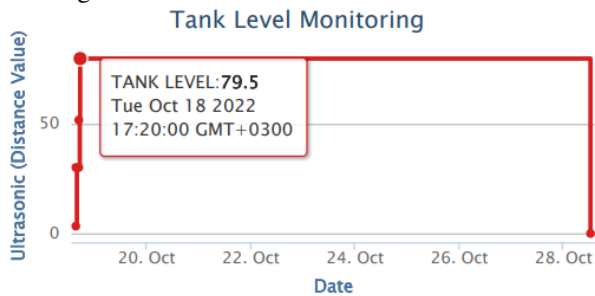

Fig. 12. Visualization of ultrasonic sensed fuel level values.

4.2.3 MQ35 sensor testing results

The developed system detects if the boiler surrounding exists the inflammable gas which can provoke the plant incident/or plant fire occurrence. In the testing experiment, the MQ35 sensor read 87% value of gas detected. If the gas was not detected, the system reads a 0% value. Fig. 13 illustrates the gas

detection condition or no gas detected in the fuel monitoring process.



Fig. 13. Gas condition results around the boiler (a) Gas detected (b) No gas detected.

4.2.4 DHT22 sensor testing results for environment temperature monitoring within the boiler installation area.

The boiler installation temperature area was detected. This temperature was considered as environment temperature. In addition, the higher environmental temperature of 46°C was observed and the system alerted the plant operator to be alerted. The system also detects the normal temperature of 22.6°C during plant operation. Fig. 14 depicts the environmental temperature in the boiler installation area within RABEC Ltd.

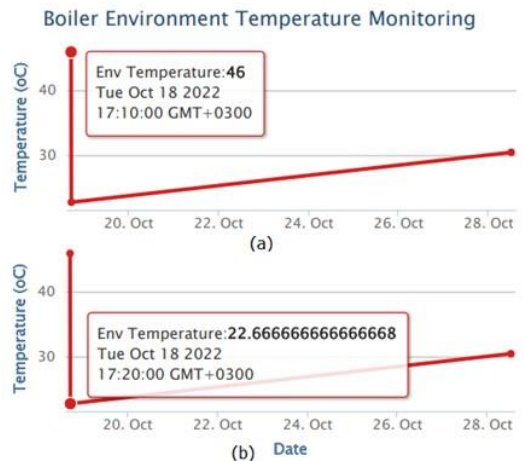

Fig. 14. Boiler installation environment temperature (a) abnormal conditions (b) normal conditions.

4.2.5 DHT22 sensor testing results for humidity monitoring

The DHT22 sensed the humidity percentage of the fuel tank in order to illustrate the moisture percentage during the steam production process. As fuel temperature may change, the humidity can also change which should affect the fuel combustion performance. During the experiment, the humidity was equal to 91% which made fuel combustion more efficient during day-shift and in some cases, the humidity was decreased to 58% which made fuel combustion moderate in night shift operation in RABEC Ltd. Fig. 15 shows the humidity observation on ThingSpeak platform during test performance.

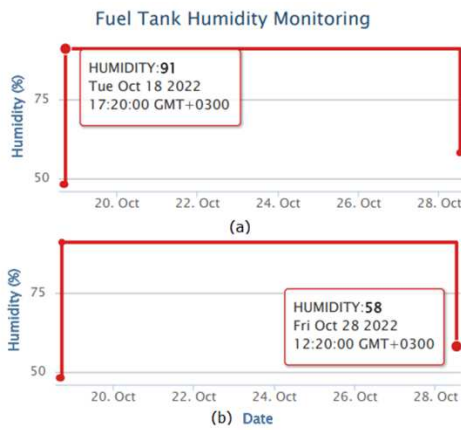

Fig. 15. Sensed fuel tank humidity percentage (a) Day-shift (b)Night-shift.

4.2.6 Pressure Sensor testing results

The fuel pressure is the essential parameter that was very interesting when monitoring was being conducted during this study. The fuel pressure was increased during the day shift when the industry was required to produce a high amount of banana wine production which reached up to 910Kpa while in the night shift the production was lower because of the small production that the industry had to produce. In this case, the pressure was decreased up to 1.26Kpa. Fig. 16 shows the pressure increase (day shift) where the amount of fuel consumption was high (a) and pressure decrease (night shift) during fuel pressure test performances.

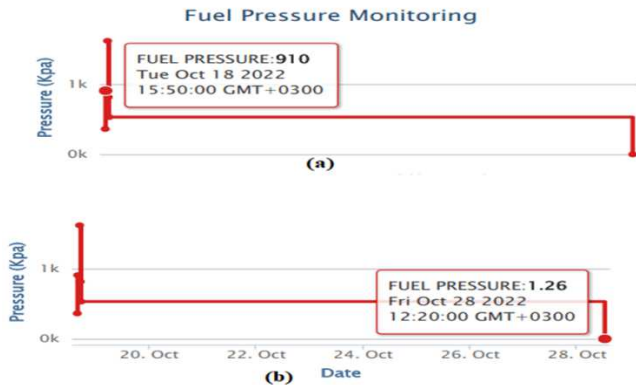

Fig. 16. Fuel pressure readings (a) high pressure (b) low pressure.

4.2.7 Thermistor sensor testing results

The fuel temperature plays an important role in fuel combustion during the steam production process. The fuel temperature was sensed in this scenario using a thermistor sensor and sent the information to ThingSpeak. The operator was enabled to check the fuel temperature conditions according to any change in fuel pressure. Fig. 17 demonstrates the thermistor reading of the sensed temperature of the fuel during the testing process where the fuel temperature raised up to 35°C and diminished to 24.37°C as shown in Fig. 18.

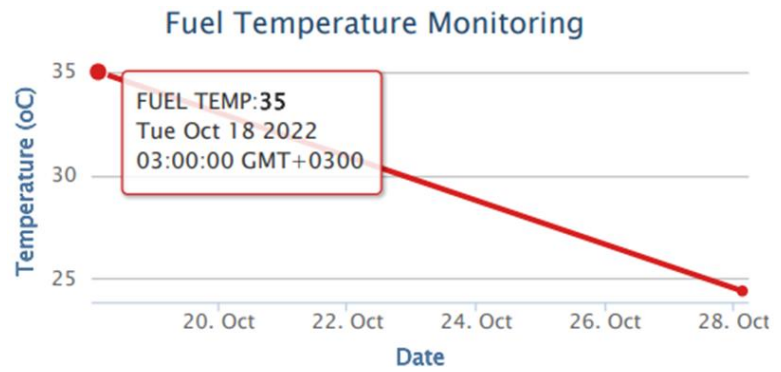

Fig. 17. Thermistor sensor value for raised fuel temperature.

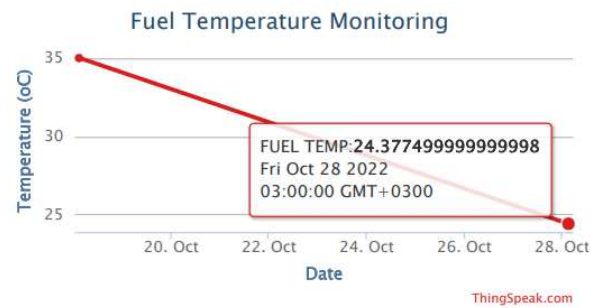

Fig. 18. Thermistor sensor value for diminished fuel temperature.

4.2.8 GSM testing results

The developed system sent the short message service (SMS) via the GSM module to the assigned operator's mobile phone. The SMS includes the fuel level in the tank if it falls below the minimum specified, the humidity state if it is abnormal, fuel pressure, the fuel temperature if it is also abnormal, and the gas detection states. The system also shows the other fuel data such as fuel pressure, fuel temperature, humidity percentage, and environmental temperature as shown in fig. 19.

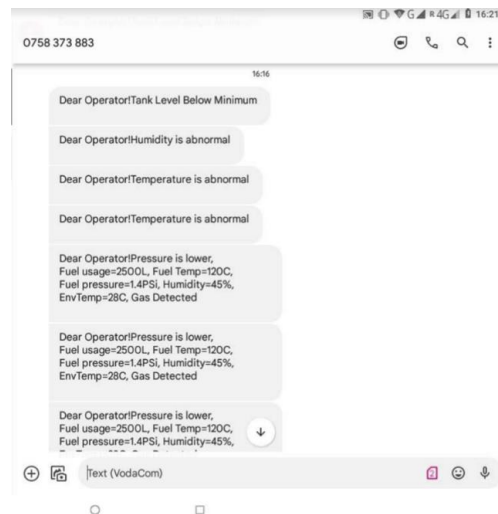

Fig. 19. GSM test results of fuel data monitoring and fuel conditions.

The developed system also sent other SMS indicating that fuel data are in good conditions to secure the plant operation without any abrupt plant shutdown occurrence/or disturbance. Fig. 20 shows the message arrived to the operator indicating the state of pressure, fuel usage, fuel pressure of 2.0Psi, humidity of 80% (abnormal), normal environmental temperature of 25°C with no detected gas.

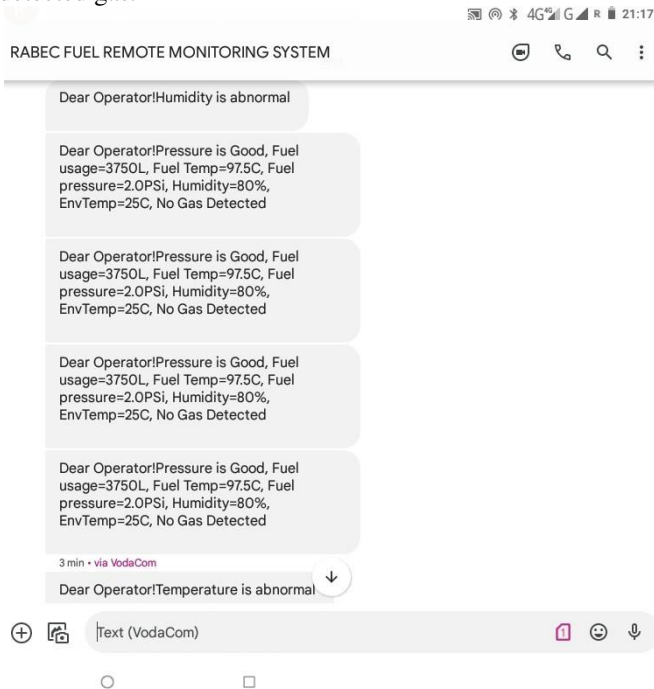

Fig. 20. SMS notification regarding good fuel data conditions.

Suddenly, the fuel temperature increased to 120°C while the fuel pressure is lower and reached to -0.1Psi. The fuel temperature was detected as abnormal. At this point, the operator was alerted about this fuel data condition while the humidity remained at 80%, and EnvTemp at 25°C. Fig. 21 indicates also the message notification sent to the operator for the alert purpose of the fuel data status during the steam boiler production process.

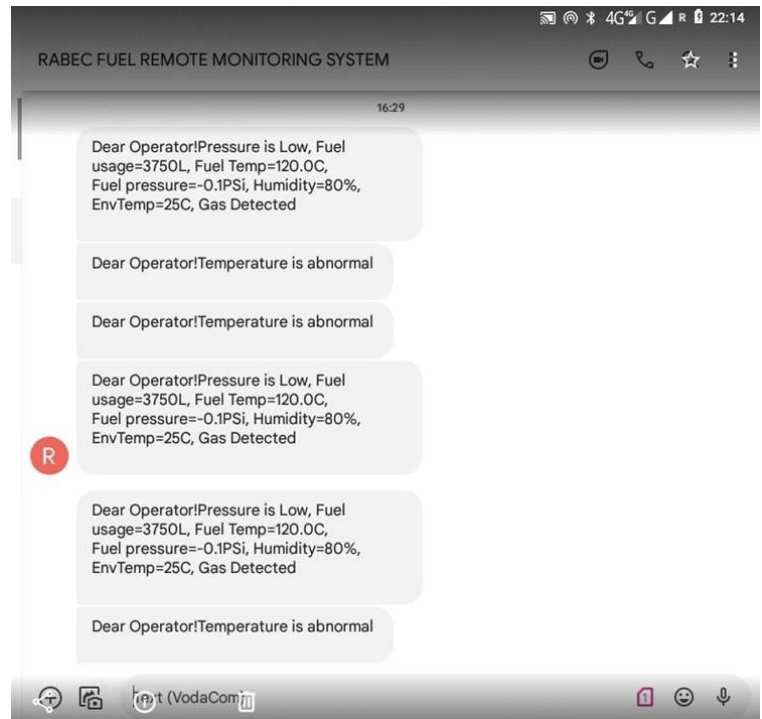

Fig. 21. Fuel data sent to the operator’s mobile phone regarding fuel conditions.

4.3 DEVELOPED FINAL PROTOTYPE

In this paper, the final prototype was developed according to the system design of both software and hardware parts. The sensing and actuating units were assembled and connected to the microcontroller in order to communicate themselves and send fuel data to LCD, mobile phone via GSM module, and ThingSpeak platform for webpage analysis. Fig. 22 indicates the integrated circuit of assembled units during the lab testing experiment and fig. 23 demonstrates the final prototype after the RABEC test experiment which was successfully done.

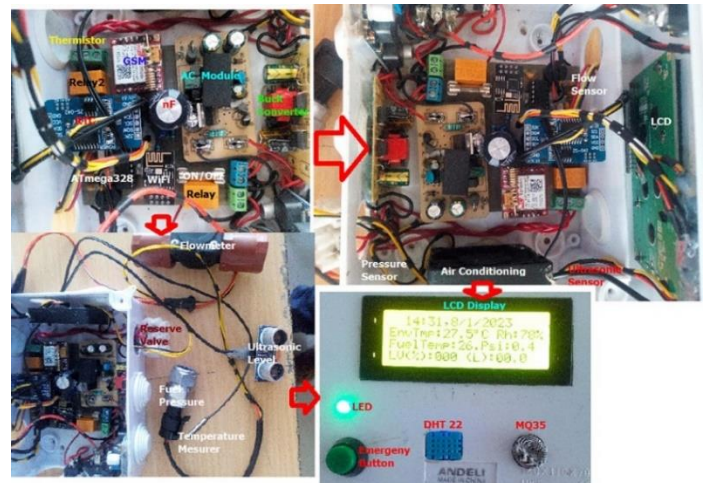

Fig. 22. Integrated circuit for developed system.



Fig. 23. Final Developed Prototype for Fuel Monitoring System.

The ATmega 328 microcontroller was powered by 5VDC voltage to control the entire hardware system. The GSM module sent the notification message to the user’s mobile phone regarding the current fuel data states. The LCD display was also connected to the system to display the amount of fuel data like fuel level, temperature, pressure, humidity, fuel usage, etc.. Fig. 24 indicates the PCB hardware architecture design of the whole IoT based fuel monitoring developed system.

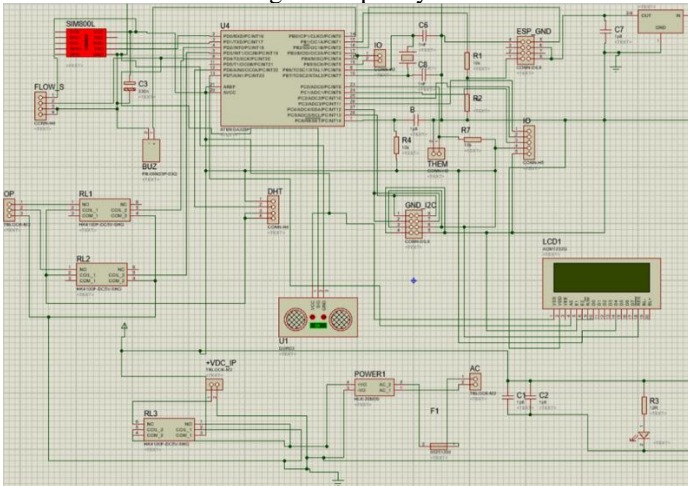

Fig. 24. The circuit diagram of the developed system.

The PCB hardware design (Fig. 24), has also been implemented in 3D for the proper design of the system board. Fig. 25 illustrates the 3D board that controls the whole developed IoT-based fuel monitoring system at RABEC Ltd.

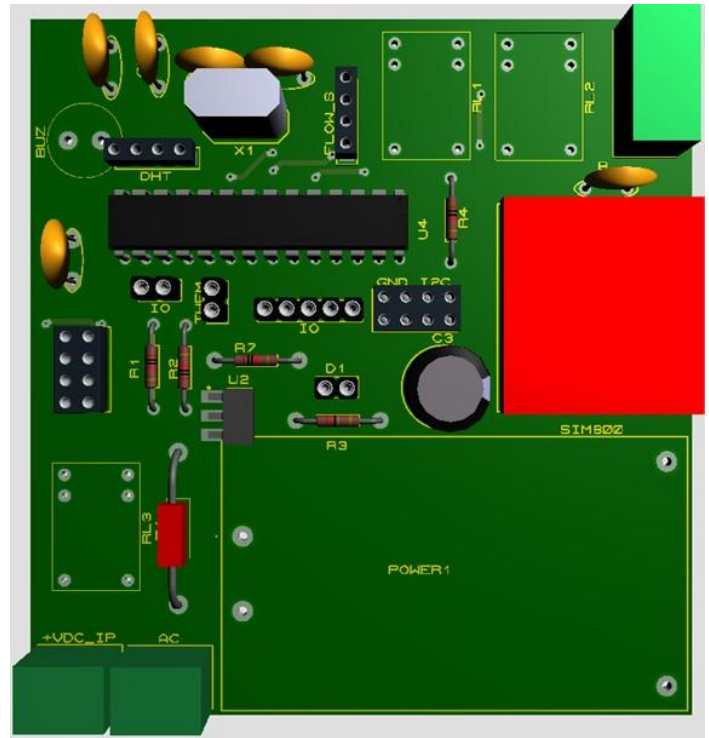

Fig. 25. 3D component site full view.

V. CONCLUSION AND FUTURE WORK

A remote IoT-based fuel monitoring system was developed and tested in this paper. Fuel data like fuel temperature, fuel pressure, fuel level, fuel flow discharge, humidity, and environment temperature were monitored and visualized on LCD. These fuel data conditions were also sent to the operator’s mobile phone via a GSM module for easiness monitoring conditions and accessed on the ThingSpeak webpage where any assigned employee can log in to visualize and analyze fuel data and log out. The fuel condition was set whenever the fuel level, humidity, and fuel temperature are greater than the threshold value to send an alert message and was successfully done. The fuel monitoring system at RABEC was improved by reducing limitations such as time-consuming, frequent accidents and death, human errors, and inconveniences. The performance of this study has been measured and provides efficiency and effectiveness of a 99.98% success rate compared to the current fuel monitoring system that is being used at RABEC Limited. Future work is recommended to deploy SCADA with HMI systems with IoT systems integration to monitor and control fuel usage.

Declarations

Funding Information

This work was supported by Center of Excellence for ICT in East Africa (CENT@EA) grant number: Cenit@ea-028 under Embedded and Mobile Systems (EMoS) program, The Nelson Mandela African Institution of Science and Technology (NM-AIST), Arusha, Tanzania.

Data Availability

The corresponding author will give the information that backs up the study's results upon request.

Conflicts of Interest

The authors state that they have no competing interests in the publication of this research.

VI. REFERENCES

- [1] P. E. S. G. Nkrumah P., "Automation of fuel tank level monitoring and measurement," *International Journal of Engineering Science and Invention (IJESI)*, vol. 7, no. 2, pp. 43-49, 2020.
- [2] S. W. Z. Qin-xin, "Developing Aanalysis for China's industrial boiler Future," *China Industrial Boiler*, Whuan, 2021.
- [3] Leverage B., "IoT for All," Use Case fuel level monitoring, 03 August 2020. [Online]. Available: <https://www.iotforall.com>. [Accessed 22 January 2022].
- [4] Z. H. R. Qiang, "Application of Internet of Things to Boiler Supervision and Management," *Journal of Industrial Boiler*, vol. IV, no. 1, pp. 50-54, 2014.
- [5] X. R. & Design, "Web-Enabled Instrumentation-Grade Data Acquisition," *ControlByWeb*, 18 December 2022. [Online]. Available: <https://www.controlbyweb.com/x420/>. [Accessed 23 March 2022].
- [6] R. D. Xytronix, "Fuel Tank Monitoring System," 27 September 2022. [Online]. Available: <https://www.controlbyweb.com/applications/fuel-tank-level-monitoring.html>.
- [7] M. Mohammed, "Fuel usage check and monitoring system in RABEC," *RAHA Beverages Company Limited*, Arusha, 2022.
- [8] L. M. P. G. P. Geethabai ME., "Design and Implementation of GSM Based Digital Fuel Meter and Fuel Theft Detection Using PIC Microcontroller," *IOSR Journal of Electronics and Communication Engineering*, pp. 11-14, 2020.
- [9] S. T. P. D. A. k. V. Baste, "Smart System to Measure Quality and Quantity of Fuel in Vehicle," *Bulletin Monumental*, vol. XXI, no. 5, pp. 59-63, 2020.
- [10] M. A.-C. K. A. A.-D. Sadeem Marouf, "System Design for Measuring and Monitoring Fuel Consumption Remotely Using Embedded System," *Journal of Physics: Conference Series*, vol. XVIII, no. 4, 2021.
- [11] P. G. P. S. P. K. R. Verma, "Fuel Management System," *International Journal of Advance Research and Innovative Ideas in Education*, vol. VII, no. 3, pp. 327-333, 2021.
- [12] S. R. G. S. Kunal D. Dhande, "Fuel Level Measurement Techniques," *Systematic Survey International Journal of Research in Advent Technology*, pp. 20-27, 2014.
- [13] P. Processing, "Main types of level sensors," 18 June 2022. [Online]. Available: <https://www.sstsensing.com>.
- [14] R. Energy, "Fuel Management & Remote Monitoring," 28 July 2022. [Online]. Available: <https://rapidenergy.co.uk/>.
- [15] P. N. A. C. T. G. S. B. S. E. Promise., "Automation of Fuel Tank Level Monitoring and Measurement," *International Journal of Engineering Science Invention (IJESI)*, vol. IX, no. 8, pp. 43-49, 2020.
- [16] S. R. F. Q. M. I. R. Raja F., "Gas Station Fuel Storage Tank Monitoring System using Internet of Things," *International Journal of Advanced Trends in Computer Science and Engineering*, vol. VIII, no. 16, pp. 531-535, 2019.



Boniface NTAMBARA was born in Rwanda in 1990. He received a BSc (Eng.) degree in Electrical Power Engineering from the University of Rwanda/College of Science and Technology, Rwanda in 2015, MSc in Industrial Engineering at Moi University, Kenya in 2022, MSc in Embedded and Mobile Systems (Embedded Systems Option). He is currently IEEE NM-AIST Student Branch Chair.



Andreas Solsbach received his Ph.D. in Computer Science and informatics. He is an expert in Environmental communication and sustainability (with a focus on sustainability reporting), Business Intelligence and Data Intelligence, Sustainability reporting, Document Engineering, Process Modeling, Enterprise Networks, Corporate communications, Environmental Information Systems, and Network publicity. Currently, Andreas is a lecturer in the Department of Computing Science, Business Informatics (Very Large Business Applications) at the University of Oldenburg



Devotha G. Nyambo is an experienced systems analyst and instructor who works on data-driven models and platforms on a regular basis. She graduated from the Nelson Mandela African Institution of Science and Technology with a Ph.D. in Information and Communication Science and Engineering/NM-AIST. Previously, she focused on dairy farming systems for cluster-based modelling and agent-based simulations of increased milk demand. She is now focusing on data-driven solutions for breakthroughs in health and small-scale agriculture systems, among other things. Devotha has been an AWARD fellow [African Women in Agricultural Research and Development] for over seven years, conducting research that affects East Africans and obtaining grants and scholarships, some of them being; from the Government of Tanzania through the Tanzania Commission for Science. She is currently a lecturer and researcher at NM-AIST.