

2013-07

Available Bandwidth Estimation Techniques (ABETS) For An Efficient Telemedicine Content Transport Network

Kayange, Daniel

IJERT

<https://dspace.nm-aist.ac.tz/handle/20.500.12479/2406>

Provided with love from The Nelson Mandela African Institution of Science and Technology

Available Bandwidth Estimation Techniques (ABETS) For An Efficient Telemedicine Content Transport Network

Daniel S. Kayange, Ramadhani Sinde and Arael Sam
*School of Computational and Communications Science and Engineering,
Nelson Mandela-African Institute of Science and Technology (NM-AIST),
Arusha, Tanzania.*

IJERT

Abstract

The ability to measure end-to-end Available Bandwidth (unused capacity) in the network path is useful for route selection in overlay networks, QoS verification, network management, traffic engineering and real-time resource provisioning, control flow and congestion, construction of overlay - routing infrastructure, topology building in peer to peer networks, and call admission control, dynamic encoding rate modification in streaming applications, capacity planning, intelligent routing systems, and design of transport layer protocols. This paper investigates at applying techniques and measurement of Available Bandwidth (AB) in the congestion control for the transmission of an efficient telemedicine content transport network by using an important ABETs tool like Pathload, IGI, and Pathchirp. This paper discusses measurement and simulation results of wired and wireless networks for the unused capacity in the network. The results can assist an organization or country in estimating the network bandwidth requirements depending on the ability of exchange multimedia data of an organization or country. The logistics could cater implementation of low cost telemedicine applications. The telemedicine systems could include wireless and wired medical interface and communication infrastructure. A simulation has been done to investigate the network quality of service.

I. Introduction

Rapid advances in information technology and telecommunications, and more specifically wireless and mobile communications, and their convergence (telematics) are leading to the emergence of a new type of information infrastructure that has the potential of supporting an array of advanced services for healthcare. The objective of this paper is to provide a measurement and simulation of the applications of the available bandwidth estimation for wireless and wired for medical interface and

communication infrastructure. We use extensive Internet and data connection for the existing telemedicine network measurements to show that these techniques estimate available bandwidth in wireless networks and wired networks. Finally, using both Internet and data connection measurements and MATLAB R2011b simulations, to explore how the measurement between wireless networks and wired networks differs, depending on that result an organization or country could estimate the network bandwidth requirements depending on the ability of exchange multimedia data of an organization or country.

The main objective of communication system design is to ensure the message signal is delivered efficiently and reliably subject to the following constraints: allowable transmit power, available channel bandwidth, and affordable cost of building the system. Further, in an over- lay, one can assume the cooperation of both the sender and the receiver, which is necessary for most probing techniques. Many available bandwidth estimation tools have emerged such as Pathload [1], IGI/PTR [2] and Pathchirp [3].

Definition and overview of ABE techniques

The available bandwidth (ABE) at a link is its unused capacity. Since, at any time, a link is either idle or transmitting packets at the maximum speed, the definition of the available bandwidth ought to look at the average unused bandwidth over some time interval T. Thus,

$$A_i(t, T) = \frac{1}{T} \int_t^{T+t} (C_i - \lambda_i(t)) dt,$$

Where $A_i(t, T)$ is the available bandwidth at link i at time t, C_i is the link's capacity, and λ_i is its traffic. The available bandwidth along a path is the minimum available bandwidth of all traversed links[4].

Why bandwidth is expensive

Bandwidth is a scarce resource. Bandwidth is an expensive due to the comparative weakness of the currencies of developing countries that have to pay in US dollars, Euros or other major currencies for most or all of their upstream international bandwidth. While the cost of the telecommunications link between two countries is generally shared, in the case of African countries (and possibly of many other developing countries) the cost of the international link is paid for entirely by the African country. This amounts to reverse subsidization of developed countries. The wired telecommunications networks in many developing countries reach only a small part of the population,

and many areas (even parts of cities) are not covered at all. The development of wired networks cannot follow the same course as it did in industrialized countries owing to small populations or low population densities in some areas, poverty, the rise of mobile and satellite communications. Furthermore, data transmission over the air is currently monetarily expensive [5].

Why telemedicine

Telemedicine promises an improvement of health care service quality in rural, urban, dense and high mobile areas by reducing cost, optimizing communication resources utilization, providing medical expertise from a distance and addressing lack laboratory / x-rays expertise. In order to implement the telemedicine in these areas, a low cost telemedicine system with acceptable quality for medical data transfer is required [6].

Examples of the real network path of telemedicine network here in Tanzania, the telemedicine connection are Muhimbili national hospital, Mwananyamala Regional Hospital, Amana Regional Hospital, Temeke Regional Hospital, Bagamoyo District Hospital and Mbeya Referral Hospital, These are the regional hospitals and referral Hospitals, the services are offered from Muhimbili National Hospital these are the physical findings per a very week, therefore the session is conducted as per time table given below for demonstration and the instruction how to cure that diseases:

TABLE I. Muhimbili National Hospital Case Presentation Timetable – Weekwise

DAY	DEPARTMENT CASE PRESENTATION	TIME
MONDAY	SURGERY	7:00AM– 9:00AM
TUESDAY	INTERNAL MEDICINE	8:00AM– 9:00AM
WEDNESDAY	CARDIAC	8:00AM - 9:00AM
THURSDAY	EMERGENCY MEDICINE	7:30AM- 8:30AM
FRIDAY	PEDIATRIC AND CHILD HEALTH	8:00AM - 9:00AM

This paper is organized as follows. We first discuss the related work in Section II. In Section III, we introduce Experimental setup for the Pathload. In Section IV, we present our application

of ABETs in end to end telemedicine services. We conclude in Section V

II. Related work

Much work has been done in the bandwidth estimation area during the recent years. In this section the emphasis is on state-of-the-art bandwidth measurement, measurements in wired networks and wireless networks and applications of bandwidth estimation for medical interface. Examples of probing tools which have emerged in recent years are Pathload [7], IGI/PTR [2], Abing [8], Spruce [4], pathChirp [9], DietTopp[9], Yaz [10], and ASSOLO. These methods differ in the size and temporal structure of probe streams, and in the way the available bandwidth is derived from the received packets [11]. There are different approaches to estimate the available bandwidth in an end-to-end Path: the probe gap model (e.g. Spruce, IGI) and the probe rate model (e.g. Pathload, PathChirp). PGM observes probing packet pair dispersions while PRM observes one way delays (OWD) in the probing packets. Both the PGM and PRM approaches utilize a train of probing packets to generate an averaged estimation and cope in that way with the burstiness nature of cross traffic.

Rate model

The rate model (self-induced congestion) is based on the following heuristic argument: If the rate of a probing stream exceeds of the path from the sender to the receiver, short term congestion happens at the tight link (i.e. the link with the smallest ABW). A queue builds up on the tight link with the interleaving of probe packets and cross traffic packets.

Gap Model

The gap model has several assumptions. (1) Cross traffic is of a fluid type. (2). FIFO queuing at all routers along the path. (3) The narrow link and the tight link are identical. (4) Packets must be queued together before being transmitted to the narrow link. (5) Accurate timing is needed to compute the packet gaps.

The probe gap model (PGM)

This model bases the exploits the information in the time gap between the arrivals of two successive probes at the receiver. A probe pair is sent with a time gap Δ_{in} , and reaches the receiver with a time gap Δ_{out} . Assuming a single bottleneck and that the queue does not become empty between the departure of the first probe in the pair and the

arrival of the second probe, then Δ_{out} is the time taken by the bottleneck to transmit the second probe in the pair and the cross traffic that arrived during Δ_{in} , as shown in Figure 1 below. Thus, the time to transmit the cross traffic is $\frac{\Delta_{out} - \Delta_{in}}{\Delta_{in}}$, and the rate of the cross-traffic is $\frac{\Delta_{out} - \Delta_{in}}{\Delta_{in}} \times C$, where C is the capacity of the bottleneck. The available bandwidth is:

$$A = C \times \left(1 - \frac{\Delta_{out} - \Delta_{in}}{\Delta_{in}}\right)$$

The probe rate model (PRM)

This is a model based on the concept of self-induced congestion, in which the tools send probe packet trains at increasing rates and the receiver observe variations in the average train one way delay looking for the turning point, or the point at which the delay of the probe packets starts increasing in a consistent basis. If one sends probe traffic at a rate lower than the available bandwidth along the path, then the arrival rate of probe traffic at the receiver will match their rate at the sender. In contrast, if the probe traffic is sent at a rate higher than the available bandwidth, then queues will build up inside the network and the probe traffic will be delayed. The available bandwidth is then estimated looking at the probe packet rate utilized when the turning point is found. At this point, the train rate is equal to the available bandwidth in the end-to-end path. Examples of tools in the probe rate model are Pathload [1] and Pathchirp [3]

Pathload [1] is a tool for estimating the available bandwidth of an end-to-end path from a host S (sender) to a host R (receiver), Pathload uses the Packet Rate Model and utilizes the Self-Loading Periodic Streams (SLoPS) [12] methodology. In general terms, SLoPS is based on the fact that the one way delay of a periodic packet stream increases when the rate of the probing traffic is higher than the available bandwidth in the path. Otherwise, there is no increase in the delay measured. A fleet of streams (of a fixed number of packets each) are sent at varying rates and the one way delay trend of each stream is then characterized at the receiver as either increasing or decreasing. When that delay is in a gray region where there is not clearly increasing nor decreasing trend (see Figure 1.1), the methodology presents a variation range of the available bandwidth.

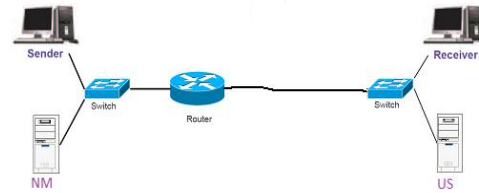

Figure 1. Architecture of Pathload

IGI [13] a series of packet trains is sent from the source to the destination with increasing initial gaps. The inter packet gap in a packet pair is measured at the source and at the destination and the distinction in the inter packet gaps is used to estimate the available bandwidth in the network. The bottleneck link rate is a direct measure of the spacing between the packets and links with higher available bandwidths maintain the spacing between the packets. Available bandwidth in a network is a dynamic metric that can change instantaneously and so a mean of samples measured over a period of time will be representative of the true available bandwidth. So IGI uses a train of packet pairs instead of just a packet pair to estimate the available bandwidth.

The final measurements, units: Mbps (Mega bits/Second)

Bottleneck Bandwidth: the bottleneck link capacity
 Competing Bandwidth: the throughput of background traffic for "IGI" algorithm
 Packet Transmit Rate: the "PTR" value, the probing rate of the packet train at the turning point
 Available Bandwidth: Competing Bandwidth, this is so called "IGI" value - Bottleneck Bandwidth

When pair of probing packets is sent, the competing cross traffic along the path introduces delays in the packet spacing and so is proportional to the packet spacing as seen in Figure 2. The above statement is true only in the scenario where the second packet arrives in the queue before the first packet leaves the queue. In this scenario the output gap is the sum of the time to process the first packet and the time to process the competing cross traffic at the bottleneck link. The initial gap between the probing packets has a significant effect on the IGI/PTR algorithms.

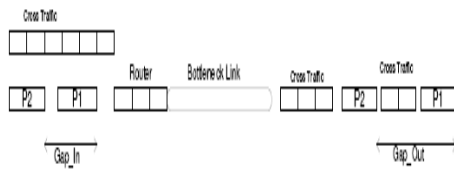

Figure 2. Packet pair probe gap model [2]

These techniques are used to experimentally determine the initial gap (D_{in}) that will yield a high correlation between the competing traffic throughput on the tight link and the output gap (D_{out}) at the destination. IGI finds an initial probing gap value so that a probing packet train interacts with the cross traffic in a non empty narrow link queue, which is called by the authors the Joint Queuing Region (JQR). In that region, there is a proportional relation between the gap when probing packets leave the queue (output gap) and the cross traffic. The authors find two components in the mathematical definition of the output gap under this JQR region:

$$\Delta_{out} = gB + \frac{B_c \Delta_{in}}{C_t}$$

PathChirp is a new active probing tool for estimating the available bandwidth on a communication network path. Based on the concept of "self-induced congestion," pathChirp features an exponential flight pattern of probes we call a chirp. Packet chirps offer several significant advantages over current probing schemes based on packet pairs or packet trains. By rapidly increasing the probing rate within each chirp, pathChirp obtains a rich set of information from which to dynamically estimate the available bandwidth.

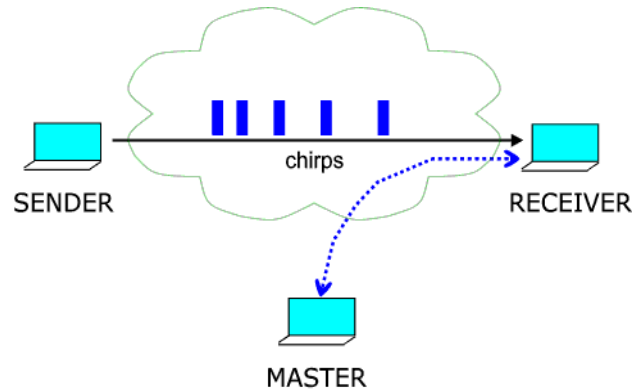

Figure 3 Architecture of PathChirp

Pathchirp [3] also uses the probe rate model. Instead of sending a packet train (or stream) at a specific rate as Pathload does, Pathchirp increases the probing rate within each train in an exponential manner. By doing that, Pathchirp captures delay correlation information using a smaller number of probing packets. Similar to Pathload, Pathchirp uses information of the relative OWDs of probe packets.

III. Experimental setup

The performance of the experiment of measurement and estimation is performed in a network testbed with Poisson, burst and self-similar synthetic cross traffic and in a real network path at the University of Nelson Mandela African Institute of Science and Technology[14].

a. Experiments

Using the testbed, the tools analyzed under this first evaluation approach are Pathload, IGI and PathChirp according to their estimation time, size of packets, number of packets per train and number of packet trains on the accuracy, convergence time and the intrusiveness of the tools under wireless bandwidth and wired bandwidth scenarios. The estimation time in the case of IGI and Pathload is provided directly by the tool.

Three main cases were studied. In the first phase, the tools are evaluated in a wired bandwidth environment. The second case evaluates the tools in wireless bandwidth network conditions. The last case evaluates the tools under variable load conditions[15].

b. Measurement results in wired bandwidth networks environment

This section presents measurements done with Pathload, IGI and PathChirp in all wired scenario.

The measurements have been performed in a testbed containing wired hops. Our testbed topology only consists of 140 wired hops, but we believe that our results illustrate the measurement problem for larger ad-hoc networks, consisting of several wired hops, as well.

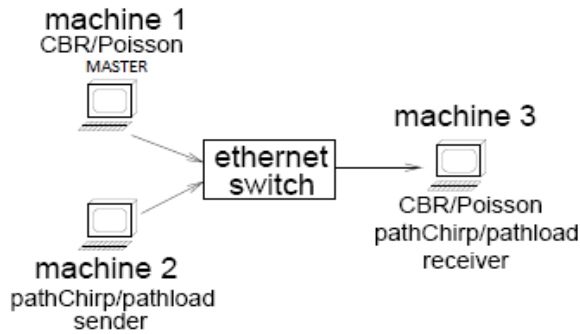

Figure 4 Testbed setup at the Nelson Mandela African Institute of Science and Technology.

The diagram in Figure 5, 6 and Figure 7 illustrates results from Pathload, IGI and PathChirp measurements in wired scenarios. We now compare pathChirp with pathload [7] using a simple test bed at the University of Nelson Mandela African Institute of Science and Technology depicted in Fig. 4. The goal is to compare their efficiency in terms of number of bytes used to obtain available bandwidth estimates of equal accuracy. PathChirp and pathload differ in their measurement methodology as well as their output quantities.

PathChirp provides a single estimate of available bandwidth per specified time interval (timestamp, available bandwidth). Pathload instead provides minimum and maximum bounds on the available bandwidth while taking a variable amount of time to make the estimate.

We performed twenty –four experiments for each tool. Both cross-traffic streams are exponentially distributed. The y-axis shows the measured Available bandwidth in Mbps, while the x- axis shows the twenty –four hours experiments are carried out for each tool.

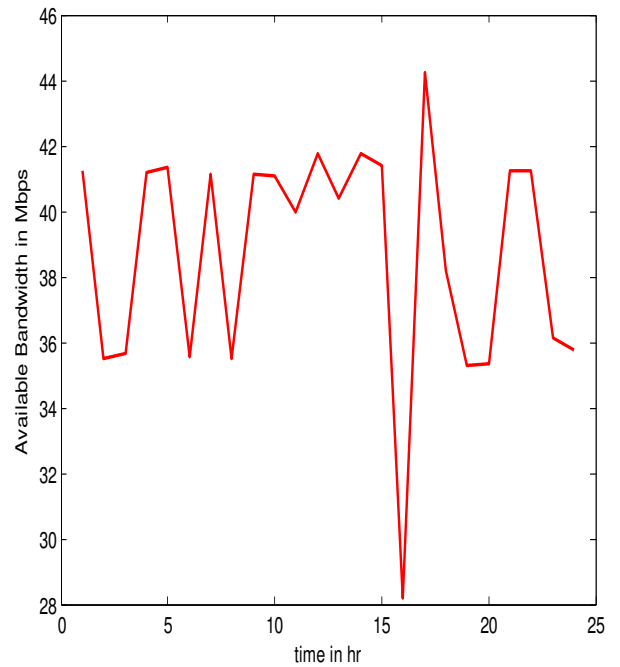

Figure 5. Testbed experiment using Pathload

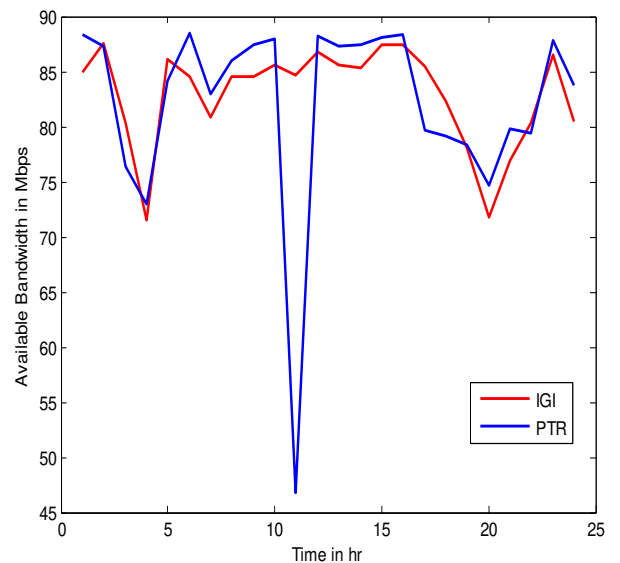

Figure 6. IGI measurements in wired accuracy on testbed

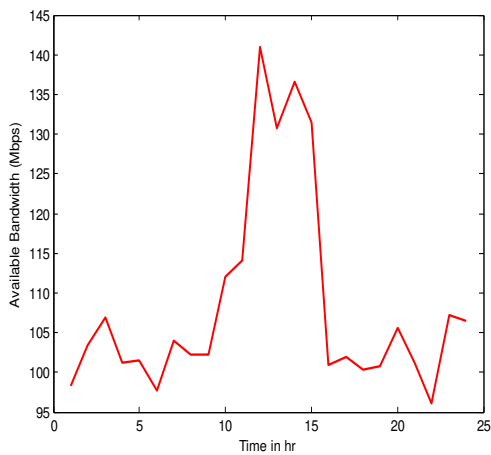

Figure 7. Testbed experiment using PathChirp

The diagram in Figure 6 is a comparison of the measured available bandwidth using IGI. The same testbed and cross traffic setup is used as in Figure 4. We see that both tools report good estimates value of the available bandwidth.

We have now given an indication that Pathload, IGI and Pathchirp estimates the available bandwidth in wired network with good accuracy, both compared to theoretical values and compared to one state-of-the-art bandwidth measurement tool.

c. Measurement results in wireless bandwidth networks environment

This subsection presents our results from measurements using Pathload, IGI and PathChirp where the bottleneck is a wireless link in the testbed as described in figure 4, which is the case in ad-hoc wireless networks. The measurements have been performed in a testbed containing wireless hops. Our testbed topology only consists of 140 wireless hops, but we believe that our results illustrate the measurement problem for larger ad-hoc networks, consisting of several wireless hops, as well.

Figures 8, 9 and 10 present the available bandwidth estimation (unused capacity in the real network path) for wireless measurement the result obtained from the simulation experiments of Pathload, IGI and Pathchirp with respect to time. We next compare Pathload and pathChirp using a simple test bed at the Nelson Mandela African Institute of Science and Technology depicted in Fig. 4. PathChirp and pathload differ in their measurement methodology as well as their output quantities.

We perform twenty –four experiments for each tool. Both cross-traffic streams are exponentially distributed. The y-axis shows the measured Available bandwidth in Mbps, while the x- axis shows the twenty –four hours experiments are carried out for each tool

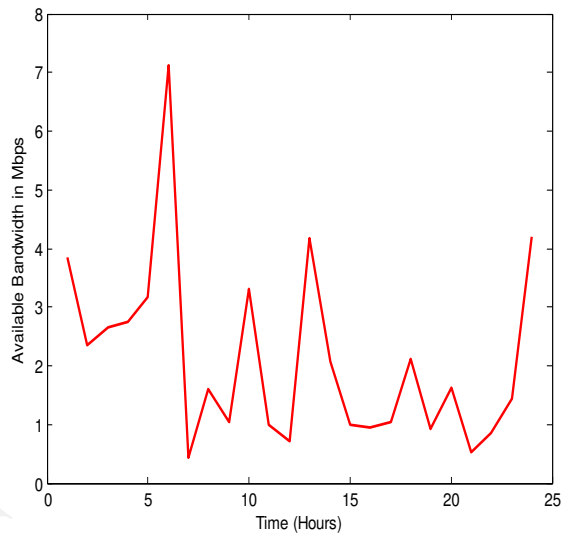

Figure 8. Testbed experiment using Pathload in Wireless networks.

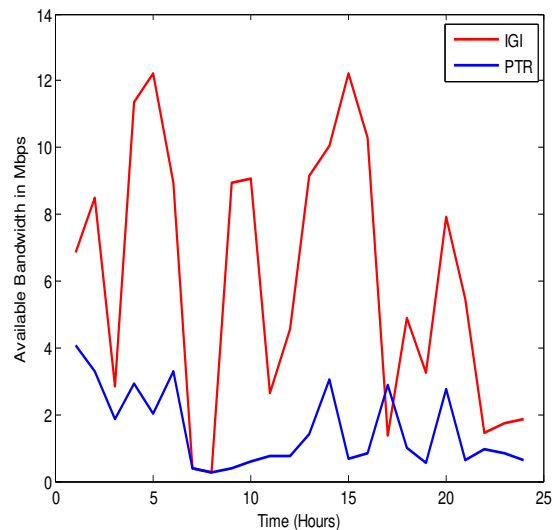

Figure 9. IGI measurement in wireless accuracy on testbed

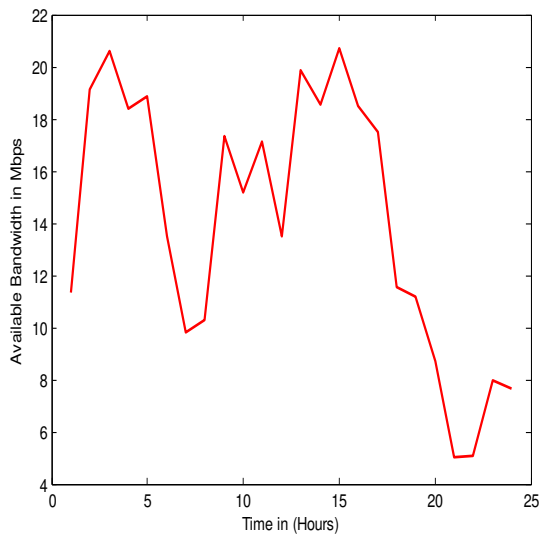

Figure 10. Testbed experiment using PathChirp in Wireless networks

Figure 9. present the estimation of the available bandwidth running in the wireless environment, it can be seen that the simulation using 500 byte packet sizes, 60 probing packets per train and continuous frequency provides the best accuracy possible but the worst convergence time, while comparing the two packet pair techniques—initial gap increasing (IGI) and packet transmission rate (PTR)—to characterize the available bandwidth on a network path. The two techniques experimentally determine an initial packet pair gap that will yield a high correlation between the competing traffic throughput on the bottleneck link and the packet gap at the destination [2]. By comparing the available bandwidth, these techniques estimate available bandwidth faster than Pathload techniques.

IV. Applications of bandwidth measurements in end to end telemedicine services.

There exist many potential applications of bandwidth measurement methods. For example: streaming media adaptation, server selection, network tomography, TCP improvement and service-level-agreement verification. These are potential benefit that active measurements could give

Telemedicine Congestion Control and its Applications

The work in this paper is focused on applying ABETs to Telemedicine congestion control. We believe that telemedical applications may be of use in many, if not all, medical specialties. However

this type of network facilitates learning through the exchange, transfer and distribution of medical information/knowledge, the generation and dissemination of new knowledge about how to collaborate effectively via telemedicine, and the application of this knowledge in telemedicine practice. Viewing telemedicine in this light directs our attention to outcomes not emphasized in most prior research, including the diffusion of medical knowledge and expertise, and the development of collaborative knowledge shared by the health care parties. In addition to documenting telemedical applications as solutions to specific local problems, successfully implemented telemedical applications

The telephone companies, has a standard interface consisting of a basic rate with dual 64-kbps voice/data channels and a T1 transmission primary rate of 1.544 Mbps. This rate is insufficient for the transfer of high-quality images, since, for instance, VHS-quality video requires about 1.2 Mbps and high-definition television up to 50 Mbps. The Switched Multimegabit Data Service (SMDS), which now operates at rates up to the T3 line rate of 44.736 Mbps, in available is some metropolitan areas and is expected to be accessible regionally in the near future. It is to be an OC-12 network with a line rate of 622.08 Mbps, which is equivalent to 2016 channels at 64 kbps. This capability will enable the Laboratory to carry out wideband communications to support its research in all areas, including telemedicine. Bandwidths of this order of magnitude are necessary for teleradiology and telepathology studies and research.

V. CONCLUSIONS

In this paper we have presented bandwidth measurement evaluation methods in both wired and wireless networks. Several simulations have been carried out using MATLAB R2011b to determine the difference between wired and wireless networks available bandwidth. The results suggest that the wired network environment have more available bandwidth compared to wireless networks, hence the wired networks are the most appropriate method for telemedicine services. One can use the results obtained to select the most appropriate network bandwidth requirements depending on the ability of exchange multimedia data of an organization or country, the logistics could cater implementation of low cost for the telemedicine applications.

Acknowledgments

We wish to thank the Nelson Mandela African Institute of Science and Technology (NM-AIST) and the School of Computation and

Communication Science and Engineering (CoCSE) for supporting this work and for allowing us to use their resources.

Comparing the accuracy of network simulators for packet-level analysis using a network testbed," WSEAS Transactions on Computers, vol. 2, pp. 700-707, 2003.

References

- [1] M. Jain and C. Dovrolis, "Pathload: A measurement tool for end-to-end available bandwidth," in In Proceedings of Passive and Active Measurements (PAM) Workshop, 2002.
- [2] N. Hu and P. Steenkiste, "Evaluation and characterization of available bandwidth probing techniques," Selected Areas in Communications, IEEE Journal on, vol. 21, pp. 879-894, 2003.
- [3] V. J. Ribeiro, R. H. Riedi, R. G. Baraniuk, J. Navratil, and L. Cottrell, "pathchirp: Efficient available bandwidth estimation for network paths," 2003.
- [4] J. Strauss, D. Katabi, and F. Kaashoek, "A measurement study of available bandwidth estimation tools," in Proceedings of the 3rd ACM SIGCOMM conference on Internet measurement, 2003, pp. 39-44.
- [5] L. Palen, M. Salzman, and E. Youngs, "Going wireless: behavior & practice of new mobile phone users," in Proceedings of the 2000 ACM conference on Computer supported cooperative work, 2000, pp. 201-210.
- [6] E. Supriyanto, H. Satria, and E. Putra, "A novel low cost telemedicine system using wireless MESH network," 2009.
- [7] M. Jain and C. Dovrolis, "End-to-end available bandwidth: Measurement methodology, dynamics, and relation with TCP throughput," in ACM SIGCOMM Computer Communication Review, 2002, pp. 295-308.
- [8] J. Navratil and R. L. Cottrell, "ABwE: A practical approach to available bandwidth estimation," in Proceedings of the 4th Passive and Active Measurement Workshop PAM 2003, 2003.
- [9] E. Goldoni and M. Schivi, "End-to-end available bandwidth estimation tools, an experimental comparison," in Traffic Monitoring and Analysis, ed: Springer, 2010, pp. 171-182.
- [10] A. F. Haque, M. H. Ali, and M. A. Kiber, "Bandwidth optimization of individual hop for robust data streaming on emergency medical application," Journal of Engineering and Applied Sciences, vol. 4, 2006.
- [11] A. Pásztor and D. Veitch, "The packet size dependence of packet pair like methods," in Quality of Service, 2002. Tenth IEEE International Workshop on, 2002, pp. 204-213.
- [12] M. Jain and C. Dovrolis, "End-to-end available bandwidth: measurement methodology, dynamics, and relation with TCP throughput," IEEE/ACM Transactions on Networking (TON), vol. 11, pp. 537-549, 2003.
- [13] K. Lai and M. Baker, "Nettimer: A tool for measuring bottleneck link bandwidth," in Proceedings of the USENIX Symposium on Internet Technologies and Systems, 2001.
- [14] L. Rizzo, "Dummynet: a simple approach to the evaluation of network protocols," ACM SIGCOMM Computer Communication Review, vol. 27, pp. 31-41, 1997.
- [15] G. F. Lucio, M. Paredes-Farrera, E. Jammeh, M. Fleury, and M. J. Reed, "Opnet modeler and ns-2: