

THE ROLE OF OLED DEVICES IN THE DEVELOPMENT OF SMART CITIES

UDC 711.45:004.7

721:004.7

621.385.2:535.37

**Snežana Đorić-Veljković¹, Nikola Mitrović², Sandra Veljković²,
Vojkan Davidović², Emilija Živanović², Ivica Manić²,
Danijel Danković²**

¹University of Niš, Faculty of Civil Engineering and Architecture, Niš, Serbia

²University of Niš, Faculty of Electronic Engineering, Niš, Serbia

Abstract. *In the course of the last few years, interest in the development of smart cities and progress of smart buildings has increased significantly. This development has been significantly increased due to the development of new technologies, innovative functional materials, electronic components and other products. At the same time, it is imperative to use those products that contribute to the preservation of the environment, and above all to energy saving. Thus, new technologies are becoming increasingly attractive, such as the one based on OLED (Organic Light Emitting Diode) technology, which is used in the production of mobile phones, tablet computers, other devices, as well as light sources. Although this technology has been generally known for more than half a century, commercial application of OLED components was not possible due to insufficient efficiency of products based on it. However, the continuous improvement of characteristics and efficiency enabled their more significant application in the past few years. The aim of this work is to provide adequate information about the possibilities of applying some innovative technologies in the planning and development of smart cities. Especially, becoming more familiar with the basic properties and application possibilities of OLED devices can lead to the life quality improvements of city spaces users.*

Key words: *Development of smart cities, OLED devices, application of device.*

Received June 30, 2023 / Revised August 1, 2023 / Accepted August 15, 2023

Corresponding author: Snežana Đorić-Veljković - University of Niš, Faculty of Civil Engineering and Architecture, Niš, Serbia
e-mail: snezana.djoric.veljkovic@gaf.ni.ac.rs

*Selected paper presented at the International Conference Sinarg 2023 held in Niš, Serbia on 14-15 September 2023.
© 2023 by University of Niš, Serbia | Creative Commons License: CC BY-NC-ND

1. INTRODUCTION

Creating a smarter planet can be achieved by applying a concept which involves: Instrumented, Interconnected and Intelligent. This concept of three I - 3I, promoted by IBM, implies that there are three basic pillars of forming a smarter planet [1, 2]. At the same time, Instrumented means that by using a remote sensor, information can be collected wherever it exists. Interconnected means that the collected information can be sent, received, or simply moved to where it will be useful. The third part of this concept - Intelligent, means that obtained information can be processed, analysed and based on it certain procedures that can be carried out in order to obtain the appropriate knowledge, which can be further used, applied... According to this, in Fig. 1 is presented the 3I concept.

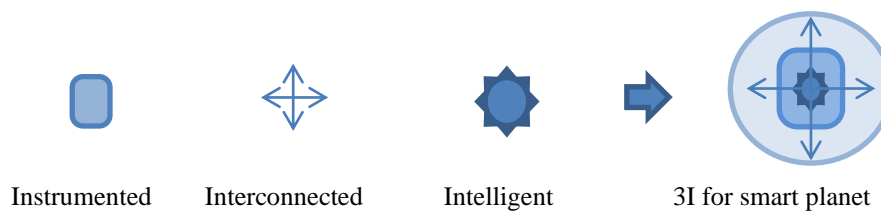

Fig. 1 Concept of 3I - three pillars for smarter planet

One of the elements in realizing the vision of a smarter planet, is certainly the formation of smart cities, in which the focus is especially on preserving the environment, available resources, saving energy, as well as ensuring efficient transport and communications. In such a city, the application of smart technologies is increasingly pronounced. Thereby, the application of the Internet of Things (IoT) system is very important and plays an increasingly pronounced role. Moreover, all these new technologies and novel products aim, above all, to improve people's quality of life.

It is important that one of progressively present novel technical achievements is OLED (Organic Light Emitting Diode). Namely, OLED devices are new electronic devices that, due to their characteristics, can have a really wide application in many areas. As it is known, they have significant applications for displays, televisions, tablets, mobile phones, screens for digital cameras, dashboards, in the automotive industry. These new systems and technologies based on the use of OLED devices have great advantages when it comes to production and design [3]. For instance, TVs made with OLED technology are only 4 mm thin, and they are thinner than those made with LED technology, because fewer layers are required to produce them.

In addition, the application of OLED devices as light sources, illuminating infrastructure and especially the decoration of a certain space is particularly important [4]. Thus, it is possible to install ones with transparent OLED elements instead of classic windows, so that they can serve as an artificial light source when there is no daylight. Application of these OLED components, as well as new equipment being perfected, can lead to significant reduction of energy consumption, but above all, artificial light would become more similar to daylight and more pleasing to the eye. Besides, innovative products, discovered innovations and quality solutions that were not available until now contribute to the improvement of automatic operation and control, as well as people's comfort and fast and better communication.

This paper presents the potential of applying some innovative technologies in the planning and development of smart cities, and especially some properties and possibilities of applying OLED devices that can lead to an improvement in the quality of life of users of urban areas.

2. INTRODUCTION PROPERTIES AND ADVANTAGES OF OLED DEVICES

An important property of OLEDs is that they do not contain hazardous materials (such as mercury) making them environmentally friendly devices [5]. Also, the light emitted by OLED is pleasant and contains less "blue light" in its spectrum, which can be harmful because the light is of higher energy. Namely, if the eye is exposed to this light for a long time, it can lead to the degradation and damage of the vision, as well as sleep disturbance. Unlike LED light sources (which are point sources and therefore have glare), OLED sources emit significantly uniform light, which is similar to natural light and therefore more pleasant to the eye, while the source efficiency is greater than 150 lm / W and colour reproduction rate is higher than 90 [6].

These devices have the advantages of being low cost, light, flexible, and easy to modify, making them ideal materials for various applications. Principally, OLED devices are made of several thin organic layers that are placed between two electrode layers and when current flows through them, light appears. Thereby, there are a several types of OLED devices, which can be classified into some categories: bottom emission, top emission, and both side emission-transparent (from the point of view of emitting directions) as well as normal and inverted structures (from the point of view of the stacking order of the electrodes) [7].

It is important to note that research on the properties of OLED devices is very important, especially in scientific studies, in order to achieve the best possible performance of these devices for practical application. Very important for OLED devices are current performances, like efficiencies, lifetimes, luminance–current, and especially current–voltage (I–V) characteristics. Typical I–V characteristic of the OLED device with the structure of glass/ITO(150nm)/MoO₃(10nm)/ α -NPD(40 nm)/Alq₃(30 nm)/DPB:Liq(25wt%)(43.5 nm)/Al(100 nm) are shown in Fig. 2. This I–V characteristic is presented in lin-lin (Fig. 2a) and log-lin (Fig. 2b) scale.

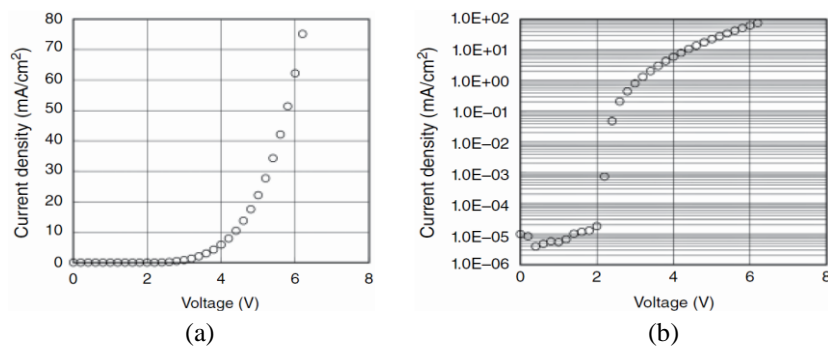

Fig. 2 Typical current-voltage characteristic of the OLED device with the structure of glass/ ITO/ MoO₃/ α -NPD/Alq₃/DPB/Al in lin-lin (a) and log-lin (b) scale, [7]

It can be seen that the turn-on voltage is 2.0 V and that the leakage level of this OLED device is close to 10^{-5} mA/cm². Standard OLED devices have a tendency to display a lower current level than 10^{-4} mA/cm² if they are properly made-up. Therefore, the information about the device failure can be obtained from the I-V characteristic (especially from the current presentation in a logarithmic scale) [7].

Owing to their improved lifetime, in addition to other good properties and the unique features, OLED devices show a promising potential not only for display and lighting uses, but for many other innovative applications [8].

Due to the great similarity in the operation of OLED devices and solar cells, flexible organic photovoltaic solar cells were realized. Namely, the organic material is coated over the surface or a layer of that mixture is sprayed on the surface, and uses the solar energy to create thin film organic photovoltaic solar cells. In addition, new technologies are creating engineering innovations, so it is now possible for organic solar cells and light-emitting diodes to be unified - combined in a single device [9]. Investigators succeeded in producing an organic solar cell that can simultaneously function as an efficient OLED, and current-voltage characteristic of such device is presented in Fig. 3. It can be achieved that below the open circuit voltage the diode functions as a solar cell, and above as an OLED. This organic optoelectronic diode absorbs ultraviolet and blue photons.

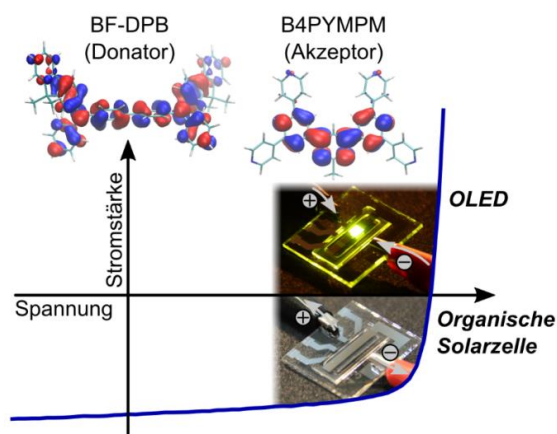

Fig. 3 Current-voltage characteristic of an organic optoelectronic diode that absorbs ultraviolet and blue photons, [9]

The molecular structures show the charge carrier distribution in the organic semiconductors used as electron donor BF-DPB (N4,N4'-Bis(9,9-dimethyl-9H-fluoren-2-yl)-N4,N4'-diphenylbiphenyl-4,4'-diamine) and as electron acceptor B4PYMPM (4,6-Bis(3,5-di(pyridin-4-yl)phenyl)-2-methylpyrimidine).

These discoveries can contribute to the development of more energy-efficient OLEDs in screens of television or displays of smartphone. The developed photovoltaic devices can be used for the efficient conversion of ultraviolet and blue photons (the high energy part of the optical electromagnetic spectrum) into the electrical power or as semi-transparent solar cells in glass facades. Also, in indoor applications they can be used for the electrical supply of Internet-of-Things devices which are increasingly present in ordinary life, and are an indispensable part of smart cities.

3. APPLICATION OF OLED DEVICES

It is clear that there is a constant search for better, more efficient solutions that can be applied, and the existing ones are improved. All these solutions and products are in the function of ensuring more efficient functioning and better quality of life for people, especially those in cities.

In Fig. 4a are presented flexible thin film solar cells which can be integrated into the building envelope and in Fig. 4b are presented transparent solar power windows, which can be a part of the building envelope [10]. Flexible thin-film solar cells can replace conventional materials in places such as roofs, skylights or facades and can represent an integrated photovoltaic unit in a building.



Fig. 4 Flexible thin-film solar cells (a) and transparent solar power surfaces (b), [10]

Transparent solar power surfaces can replace parts of windows. In this case, there are no moving parts involved in photovoltaic embedded systems and there is no associated electrical or acoustic noise. Also, it is obvious that these solar power surfaces use parts of existing surfaces of buildings or constructions. These characteristics show that there is a significant advantage of this use of solar energy compared to other green technologies.

In the upcoming smart cities, the challenge may be new infrastructures and networks, what requires innovation in providing novel facilities that will be able to receive, store and transmit information. At the same time, such facilities should provide the necessary energy for independent functioning. In addition, they could illuminate the environment and have other functions. In Fig. 5 is presented the cantilevering hybrid vertical structure that works as a stand-alone or a grid-connected smart tower-like object [11]. It can be used for multiple services, for integrative urban signage or lighting system.

The outer surface of the tower consists of three spirally twisted strips in which triangular plates are embedded. These panels cover the outer sides of the tetrahelix, which consists of tubular thin steel beams connecting the solid six-sided steel structure. The panels are made of an internal laminated glass structural panel with rounded edges. For this type of construction, glass was chosen as the optimal material due to its durability and other properties. Namely, regarding the possibilities offered by the lamination and bonding, electronic devices, such as photovoltaic cells, sensors, OLEDs and other lighting devices can easily be incorporated in the glass panels. Fig. 5 shows the tower, where photovoltaic panels (Fig. 5a), luminescent panels (Fig. 5b), and screens and sensors (Fig. 5c) are installed in the glass panels.

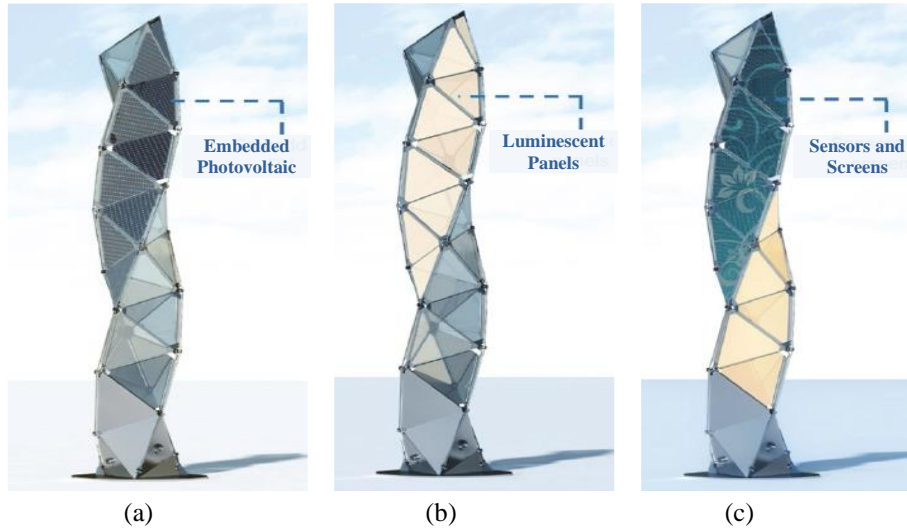

Fig. 5 Presentation of multifunctional towers where in glass panels are embedded photovoltaic (a), luminescent panels (b) and screens and sensors (c), [11]

The use of sensors is definitely necessary in smart cities because they collect data that is further distributed and used for further actions, which can contribute to making urban spaces comfortable and safe for people. That is why new, more efficient and cheaper solutions are constantly being developed to collect data. Special attention is paid to data transmission in a wireless sensor network [12].

Thus, sensor nodes can be placed alongside roads in order to collect relevant data that is valuable for road users during the driving duration. Thus, Fig. 6 presents one of the solutions for sensor nodes, using IoT, which can collect data such as air pollution on the road, weather parameters such as temperature and humidity, road description, speed limit, conditions such as traffic volume, activities maintenance and so on [13]. The data obtained with this device is displayed on an OLED-based screen that is used as the device's display. Fig. 6a presents an existing sign (small figure) and the name of the road

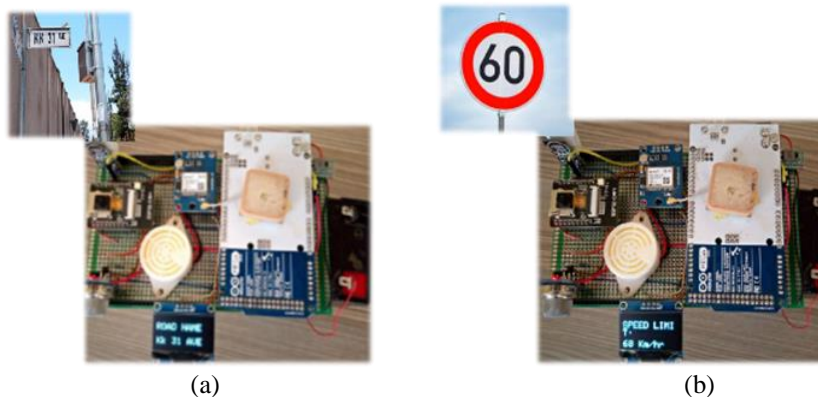

Fig. 6 Existing sign (small figure) and the presentation on OLED display for name of the road (a), and speed limit (b), [13]

that is shown on the sensor display, while Fig. 6b presents an existing sign (small figure) and speed limit that is shown on the sensor display.

Also, monitoring the weather forecast is very important in many cases, and the possibilities of cheaper and more efficient solutions for obtaining data are continuously being explored. In Fig. 7 is shown a low-cost weather monitoring system that extracts weather conditions (and weather forecasting) of any location that can be obtained from a cloud database management system and displays the obtained results on an OLED display.

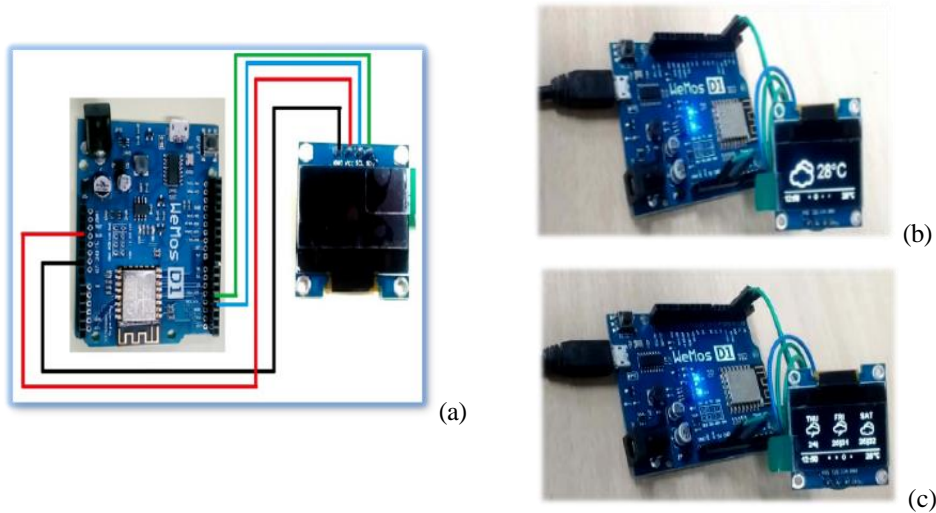

Fig. 7 Representation diagram of the system (a), temperature presentation on OLED display (b), and 3 days weather forecasting presentation on OLED display (c), [2]

In Fig. 7a is presented a schematic diagram of the system, while, in Fig. 7b and Fig. 7c are shown temperature and 3 days weather forecasting, respectively. For this system an ESP8266-EX microcontroller based Wemos D1 board is used and it is implemented on Arduino platform with which is possible to download the data from the cloud. In this way, it is possible to observe the weather conditions at any location and it is possible to access the current data of any station.

In addition to the mentioned presentations, the applications of transparent OLED that are applied to some other surface, such as a mirror, are especially attractive. The transparent OLED light source can completely cover the surface of the mirror or only a part of it. When it is off, it is transparent and practically a part of the mirror, and when it is on it becomes a source of pleasant white light. Interactive mirrors are innovative solutions that actually represent an OLED display. The advantages of interactive mirrors are enormous, and they can be integrated into both modern and traditional interiors. Such a mirror provides multiple possibilities and can be used for better organization or entertainment. It can be used for streaming music, YouTube videos, streaming TV, and exercise classes with the built-in Wi-Fi and high-quality bluetooth speakers. The mirror can also contain motion sensors to detect movement, so the mirror turns on when someone is nearby. In Fig. 8 are presented two different touch screen smart mirrors [14].



(a) (b)
Fig. 8 Touch screen smart mirrors, [14]

Also, contemporary circumstances, as well as unpredictable ones, have forced remote and hybrid work to become more ubiquitous. Therefore, there is a strong need for multifunctional office space. Although the concept of open and shared office space is becoming dominant, it has been observed that in many situations, there is a need for a certain degree of privacy. Transparent OLED can play a dominant role in meeting these requirements because it can be flexibly used in many ways, as it is presented in Fig. 9.

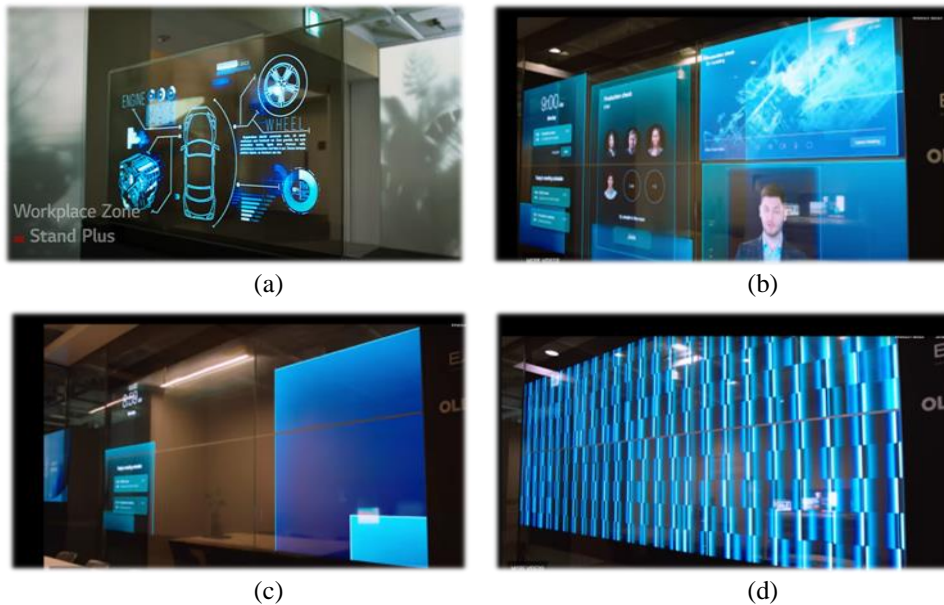

(a) (b)
 (c) (d)
Fig. 9 Transparent OLED device used as a monitor on the glass wall of the office during live meetings (a), online meetings (b), part of the open workspace (c) and private space in the same workspace (d), [15]

Thus, it can be used as a monitor on the glass wall of the office for meetings [15], whereby data can be presented on it as standard during live meetings (Fig. 9a) or online meetings (Fig. 9b). At the same time, when it is turned off, it can represent a part of the open workspace (Fig. 9c). However, by turning on the privacy mode, appropriate privacy can be ensured in part of that open space (Fig. 9d).

In this way, transparent OLED enables communication to take place freely in a space that is not segmented and has no opaque partitions. Thus, this transparent (glass) partition can at any time represent a screen on which appropriate contents can be found. In this manner, offered innovative application of OLED components enables the transformation of a certain space, representing a futuristic medium that is in harmony with the surroundings.

It is clear that the application of transparent OLED enables the achievement of completely new visual effects and ensures the formation process of innovative space [15]. This achieves the transformation of a space into a unique and superior space through sophisticated design and cutting-edge technology. Apart, transparent OLED can contribute to an innovative shopping experience (Fig. 10).

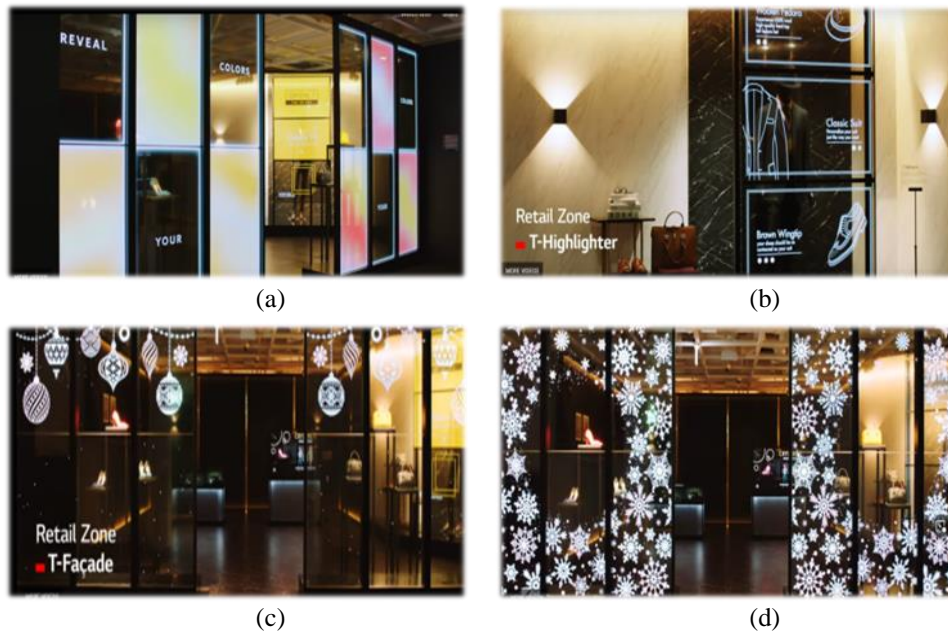

Fig. 10 Transparent OLED device displays detailed information about the respective brands and their products (a), (b), and contribute to an innovative shopping experience (c), (d), [15]

Namely, offline retail stores are increasingly accepted by customers and are developing because they provide customers with a different shopping experience and provide very detailed information about the respective brands and their products. Transparent OLED captures customers' attention by keeping the store open while overlaying various product information (Fig. 10a,b) providing an innovative approach to shopping (Fig. 10c,d). In this way, a new context for product advertisements is obtained and promotional effects are maximized.

4. CONCLUSION

Over the past few years, there has been a significant increase in interest in the advancement of smart cities and the evolution of intelligent buildings. This was possible thanks to the rapid development of new technologies, innovative functional materials, electronic components and various other products. OLED components play a special role in this, which can be used as screens in mobile phones, tablet computers, displays, various devices, and as light sources. These components have emerged as particularly promising because they are in line with environmental protection and energy efficiency, which has become the most important. This study aimed to provide the insight into the potential application of innovative technologies in the planning and construction of smart cities. In particular, gaining a deeper understanding of the basic properties and possibilities of different applications of OLED devices can contribute to improving the quality of life of city dwellers. As the journey toward smart cities continues, the integration of cutting-edge technologies like OLEDs can undoubtedly illuminate a path to a more sustainable and enhanced urban experience. In particular, new possibilities are offered by the integration of organic solar cells and diodes that have already been achieved, i.e. they are combined into one device. Additionally, the possibility of using OLEDs as displays that display data collected by appropriate sensors is significant, because the collection, distribution and presentation of a large amount of data is of particular importance in smart cities. The additional quality of these components, especially the transparent OLED, represents the possibility of using them for completely innovative applications. These devices make it possible to simultaneously provide the conditions imposed by the modern concept of working in offices, but also for the needs of people as users of the space for an appropriate degree of privacy. Innovative applications of transparent OLED can contribute to an innovative shopping experience, as well as a virtual experience in museums, various institutions, and homes.

Acknowledgement. *The work is the part of investigations supported by the Ministry of Science, Technological Development and Innovations of Republic of Serbia, within the research projects 451-03-47/2023-01/200095 and 451-03-47/2023-01/200102.*

REFERENCES

1. Valerie Lampkin, Weng Tat Leong, Leonardo Olivera, Sweta Rawat, Nagesh Subrahmanyam, Rong Xiang, "Building Smarter Planet solutions with MQTT AND IBM WebSphere MQ Telemetry", Books.google.co.in IBM RedBooks, 2012.
2. Ravi Kishore Kodali and Archana Sahu, "An IoT based Weather Information Prototype Using WeMos. Proc 2nd International Conference on Contemporary Computing and Informatics (ic3i)", Amity University, Noida, India, pp. 612-616, 2016.
3. Sandra Veljković, Aleksandra Ćurčić, Vojislav Mitić, Gordana Topličić-Ćurčić, "OLED Light Sources in Architecture", V International Symposium for Students of Doctoral Studies in the Fields of Civil Engineering, Architecture and Environmental Protection, PhIDAC 2019, pp. 199-205, Nis, Serbia, 24-25 October 2019.
4. Kanae Matsui, Katsutoshi Saito, "IoT-based OLED lighting control system for providing comfort space", IEEE SmartWorld, Ubiquitous Intelligence & Computing, Advanced & Trusted Computed, Scalable Computing & Communications, Cloud & Big Data Computing, Internet of People and Smart City Innovation, San Francisco, CA, USA, Accession Number: 17878639, 04-08 August 2017.

5. Snežana Đorić-Veljković, Jugoslav Karamarković, “Challenges and Possibilities of Application of Oled Light Sources”, Proc. International conference - Innovation as a Function of Engineering Development (IDE 2011), Niš, 103-108, 2011.
6. <https://www.energy.gov/eere/ssl/world-record-white-oled-performance-exceeds-100-lmw> [Accessed 15.7. 2023].
7. Mitsuhiro Kodan, “OLED Displays and Lighting”, John Wiley & Sons, Chichester, UK; Hoboken, NJ: 2016.
8. Snežana Đorić-Veljković, Nikola Mitrović, Sandra Veljković, Predrag Janković, Danijel Danković, “Innovative Applications of OLED Components in Arcitecture”, Proc. Building services & Architecture, University of Belgrade, Faculty of Architecture, Belgrade, pp. 139-147, 2021.
9. <https://www.led-professional.com/technology/light-generation/organic-solar-cells-and-light-emitting-diodes-united> [Accessed 15.7. 2023].
10. Patrizio Primiceri and Paolo Visconti, “Solar-Powered LED-based Lighting Facilities: an Overview on Recent Technologies and Embedded IoT Devices to Obtain Wireless Control, Energy Saving and Quick Maintenance”, Journal of Engineering and Applied Sciences, 12 (1), pp. 140-150, 2017.
11. Maurizio Froli, Francesco Laccone, “Hybrid GLAss-Steel Stele (HYGLASS): Preliminary Mechanical Study on a Smart Tetrahelical Cantilevering Tall Structure”, Conference on Architectural and Structural Applications of Glass, pp. 6.2181-1-6, 2018.
12. Sateesh Gudla, NageswaraRao Kuda, “A Reliable Routing Mechanism with Energy-Efficient Node Selection for Data Transmission Using a Genetic Algorithm in Wireless Sensor Network”, Facta Universitatis, Series: Electronics and Energetics, vol. 36, no 2, pp. 209 – 226, 2023.
13. Evariste Twahirwa, James Rwigema, and Raja Datta, “Design and Deployment of Vehicular Internet of Things for Smart City Applications”, Sustainability, 14, 176, pp. 14010176-1-16, 2022.
14. <https://prodisplay.com/touch-screens/interactive-screens/smart-mirror-touch-screen/> [Accessed 15.7. 2023].
15. <https://www.oledspace.com/en/products/transparent-oled/> [Accessed 15.7. 2023].

ULOGA OLED KOMPONENATA U RAZVOJU PAMETNIH GRADOVA

Tokom poslednjih nekoliko godina značajno je poraslo interesovanje za razvoj pametnih gradova i napredak u izgradnji pametnih zgrada. Ovaj razvoj je značajno povećan zahvaljujući razvoju novih tehnologija, inovativnih funkcionalnih materijala, elektronskih komponenti i drugih proizvoda. Istovremeno, neophodno je koristiti one proizvode koji doprinose očuvanju životne sredine, a pre svega uštedi energije. Zbog toga nove tehnologije postaju sve atraktivnije, poput one zasnovane na OLED (Organic Light Emitting Diode) tehnologiji, koja se koristi u proizvodnji mobilnih telefona, tablet računara, drugih uređaja, kao i izvora svetlosti. Iako je ova tehnologija opšte poznata više od pola veka, komercijalna primena OLED komponenti nije bila moguća zbog nedovoljne efikasnosti proizvoda zasnovanih na njoj. Međutim, kontinuirano unapređenje karakteristika i efikasnosti omogućilo je njihovu značajniju primenu u poslednjih nekoliko godina. Cilj ovog rada je da pruži adekvatne informacije o mogućnostima primene inovativnih tehnologija, kao što je i ova OLED, u planiranju i razvoju pametnih gradova. Posebno, upoznavanje sa osnovnim svojstvima i mogućnostima primene OLED uređaja može dovesti do poboljšanja kvaliteta života korisnika gradskih prostora.

Ključne reči: razvoj pametnih gradova, OLED komponente, primena komponenata