

An Isolated ZVS DC/DC Converter with Diode-connected MOSFET in Rectifier

Najmehossadat Nourieh

School of Physics, Engineering and
Computer Science, University of
Hertfordshire Hatfield, United
Kingdom

Email: n.nourieh@herts.ac.uk

Yichuang Sun

School of Physics, Engineering and
Computer Science, University of
Hertfordshire Hatfield, United
Kingdom

Email: y.sun@herts.ac.uk

Oluyomi Simpson

School of Physics, Engineering and
Computer Science, University of
Hertfordshire Hatfield, United
Kingdom

Email: o.simpson@herts.ac.uk

Abstract—This paper presents an isolated resonant zero voltage switching ZVS converter with a diode-connected MOSFET in a rectifier. The active resonant network is the composition of a resonant capacitor, a transformer leakage inductance and a diode-connected MOSFET. The output capacitor of the main switches together with their reverse recovery diodes provide zero-voltage switching condition for all switches. The input voltage/current of the proposed circuit is 0.35V/500uA while the output voltage/current is 1.5V/75uA. The simulated circuit in PSIM is presented to verify the proposed converter performance.

Index Terms – Isolated resonant DC-DC converter, zero-voltage switching (ZVS), diode-connected MOSFET.

I. INTRODUCTION

Boosting power density and efficiency are always the main requirements of modern power supplies. In this regard, soft-switching techniques are developed to reduce switching losses. In zero-voltage switching (ZVS) condition, not only the loss of voltage-current overlap is removed, but also the turn-on loss generated by reverse recovery of the PN junctions and the MOSFET output capacitance (C_{oss}), is eliminated precisely [1-3]. Generally, in resonant converter, different passive LC circuits are applied to provide soft switching condition. In resonant ZVS converter, we can considerably increase the switching frequency while thermal and switching conducting losses are kept low properly. Hence, a ZVS resonant converter can be one of the best options to be applied in power supplies [4], [5].

Today, there is an increasing demand for low-power supply in electronics loads [6], [7]. Diode-connected MOSFETs normally present lower conduction losses than the conventional PN/Schottky diodes [8].

This paper presents a DC/DC converter providing benefits of ZVS, resonance, isolation and diode-connected MOSFET for low-voltage low-current applications. Taking advantages from low switching, high efficiency, low EMI (Electromagnetic Interference), conducting and thermal

losses, isolation and high switching frequency range, this converter is convenient to be applied in applications such as battery charging purposes, domestic electronic appliances, wireless power charging of portable electronics, inductively-heated appliances, biomedical implants, telecommunication and other centralized modular, photovoltaic power optimizer and distributed power applications [4],[6]. The active resonant tank composed of transformer leakage inductance with a diode-connected MOSFET and a resonant capacitor presenting one of the differences of the proposed converter from the conventional LLC circuits [11], [12]. Hence, the reflected transformer leakage inductance on the transformer primary side is not problematic as it is absorbed by the resonant inductance. The working active resonant network is applied to drops switching-frequency deviation over the range of load variations as well as delivers ZVS condition for all switches [9],[11]. The inherent mechanism of this converter, due to its active resonant network, considerably restricts the switching frequency variations to proper small values (normally, 10% variations from full-load to zero-load). Therefore, components can be selected optimally. Theoretical analysis and simulation verifications are presented in detail in the following sections to verify the proper operation of proposed converter. Due to leakage inductance of transformer reflected at secondary side, the output stage does not need additional inductor; therefore, the total converter size is significantly reduced.

This paper is organized as follows: Section II provides information about the proposed new isolated ZVS resonant DC/DC converter and the operating modes and section III concludes the paper.

II. A NEW ISOLATED ZVS RESONANT DC/DC CONVERTER

The proposed isolated ZVS resonant DC/DC converter and its operating modes are presented in Fig. 1 and Fig 2 respectively. The converter shows seven operation modes. The inverter leg constitutes of switches Q_1 and Q_2 . The

capacitors C_1 and C_2 (in parallel with the MOSFET parasitic capacitance C_{oss}) are providing ZVS condition in class D [1], [4]. As a resonant tank the elements L_r and C_r are employed while the switch Q_r provides the active resonant tank. In the proposed circuit, the resonant inductor (L_r), which should be the sum of the external inductor and the transformer primary leakage inductance, is designed to be just the leakage inductance of the transformer which omits one of the external elements of the converter. The benefit of using Q_r is to stabilize the converter operation creating an active resonant tank. Its output capacitance will be absorbed by resonant capacitor C_r , subsequently, it will not be problematic in the operation of converter. The switches Q_3 and Q_4 in the output rectification are diode-connected MOSFETs which serve as very low loss switches for low power applications. For the analyses, it is assumed that all elements are ideal, the output capacitor is large enough to keep the output voltage constant in a switching cycle and the converter works in the steady state.

In Eq. (1), (2), (3) several parameters, which will be used in the following discussion, are defined. The parameter B is the converter normalized voltage gain " $B = nA = nV_o/V_s$ whereas α and β are used to simplify the equations. Shown in Fig. 2, the conduction angles of Q_1 and Q_2 are defined as φ_1 and φ_2 respectively. In all operating modes $I_{number} = i_r(t_{number})$. Furthermore, the parasitic inductance is also used as resonant inductance since its total value is around nH which will be added to the 25 μ H resonant inductance. In addition, Z_r and f_r are the resonance impedance and the resonance frequency respectively.

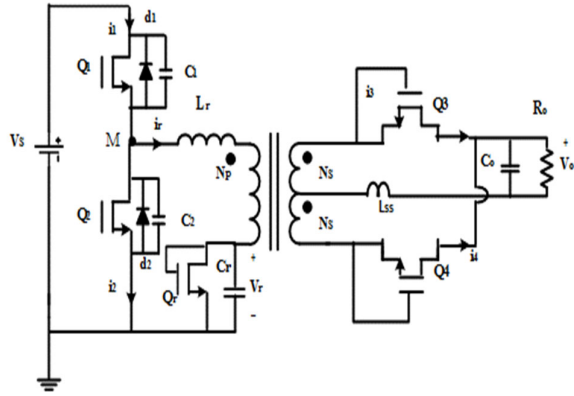

Fig. 1. The proposed isolated circuit

$$\omega_r = 2\pi f_r = \frac{2\pi}{T_r}, \quad R_o = \frac{n^2 V_o^2}{P_{out}} \quad (1)$$

$$B = n \frac{V_o}{V_s} = nA, \quad Z_r = \sqrt{\frac{L_r}{C_r}} \quad (2)$$

$$\alpha = \frac{C_r}{C_1 + C_2}, \quad \beta = \frac{1 + \alpha}{\alpha}, \quad \omega_\alpha = \sqrt{1 + \alpha \omega_r} \quad (3)$$

The proposed new isolated ZVS resonant DC/DC converter has the advantages of isolation in the applications where the isolation and safety are very critical. One of the most important advantages of this converter is the capability of being stepped-up or stepped-down, due to the transformer. This circuit also has the capability of producing wider range of output voltages which can cover more applications

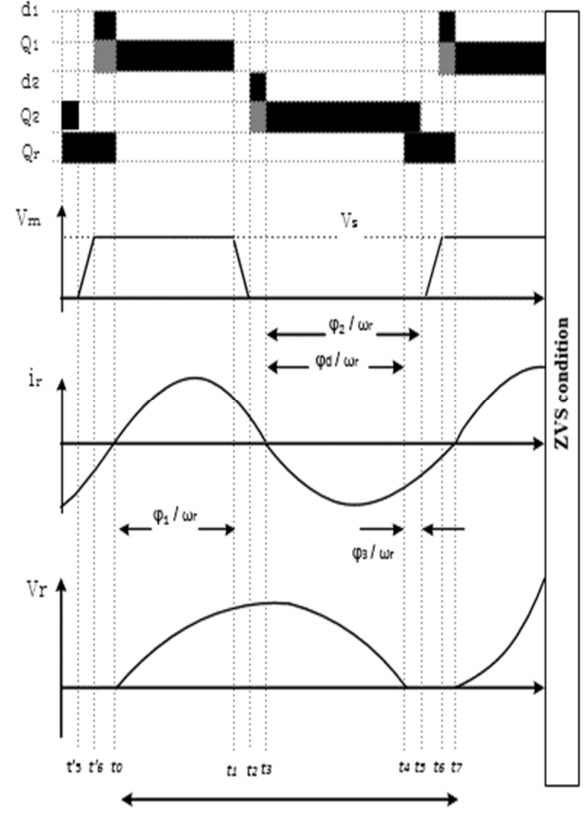

Fig. 2. The key waveforms of the proposed circuit

requirement. The schematic circuit of the proposed circuit combination plotted in software called PSIM is presented in Fig. 3.

This proposed circuit benefits from four advantage such as 1. Isolation (a. different voltage/current range, b. buck or boost application, c. safety), 2. ZVS condition (a. low switching loss, b. low capacitance loss, c. high power density), 3. Resonance (a. high switching frequency, b. high efficiency, c. low EMI and noise) and 4. Usage of MOSFETs in rectification part (a. low conduction loss, b. low thermal loss) that each mentioned specification adds advantages to the proposed circuit making it suitable for wide range of different applications as stated in the Section I. In the following paragraphs the operating modes of the converter are presented individually.

Mode I: In the period before t_0 , the diode d_1 is conducting to provide ZVS condition for Q_1 to be turned on in the time between t_0 to t_1 . Thus, at t_0 the resonant capacitor called C_r

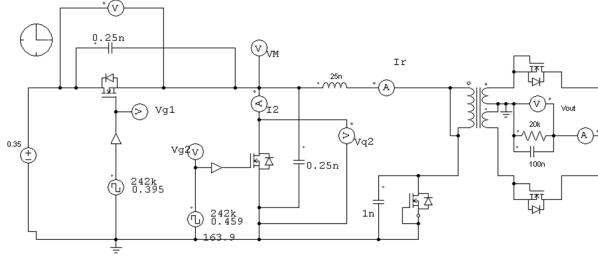

Fig. 3. The schematic of the proposed circuit

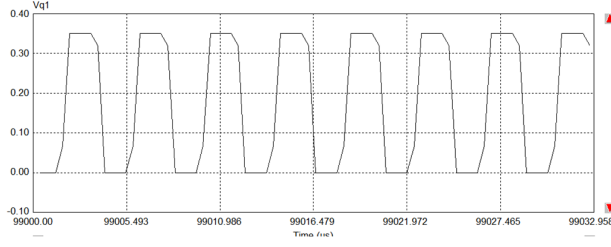

Fig. 4. The voltage of drain-source in Q_1

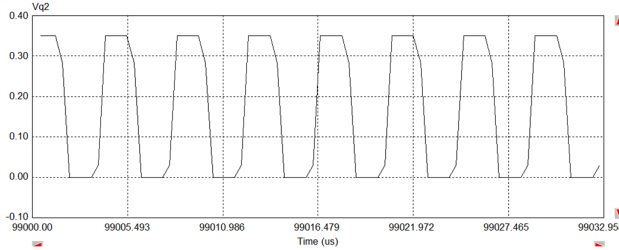

Fig. 5. The voltage of drain-source in Q_2

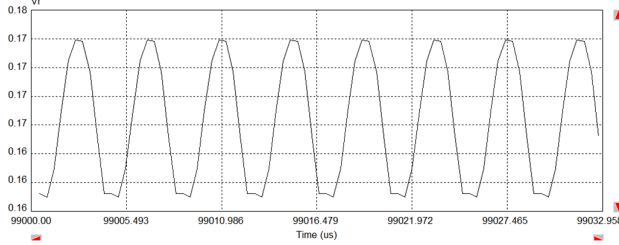

Fig. 6. The voltage of V_r

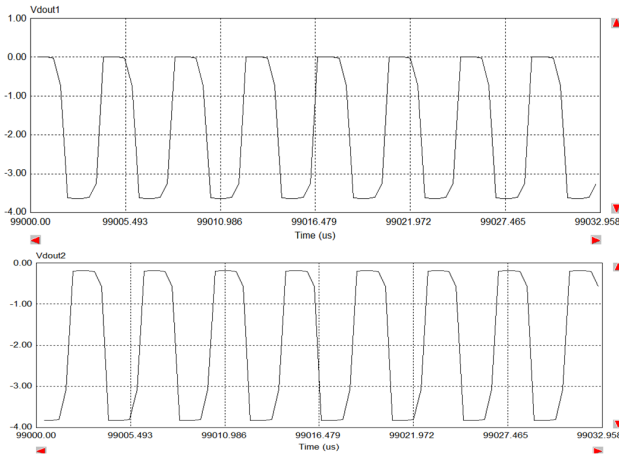

Fig. 7. The voltage of two output diode-connected MOSFETs

starts to be charged through Q_1 and L_r (by resonance with L_r) until t_1 .

$$V_r(t) = V_s(1 - B)[1 - \cos(\omega_r(t - t_0))] \quad (4)$$

$$i_r(t) = V_s/Z_r[(1 - B)\sin(\omega_r(t - t_0))] \quad (5)$$

Mode II: When the switch Q_1 is turned off at t_1 , the remained current available in L_r will flow through capacitors C_1 and C_2 . Hence, the voltage at node V_m will be decreased from V_s to zero.

$$V_M(t) = V_s[1 + \alpha(1 - B)(1 - \cos\varphi) - \alpha V(t)] \quad (6)$$

$$I(t) = (V_s/Z_r) \left[[(1 - B)\cos\varphi / (\sqrt{1 + \alpha})] \sin(\omega_a(t - t_1)) + [(1 - B)\sin\varphi_1] \cos(\omega_a(t - t_1)) \right] \quad (7)$$

Mode III: At t_2 , the diode d_2 is direct biased under ZVS condition at which the current flows until it reaches zero level at the time t_3 . In this interval, the signal for switch Q_2 would be ready to turning this switch on in the following mode.

$$T_3 = 1/\omega_r \left(\tan^{-1} \left(\frac{I_2}{(V_2 + B)} \right) \right) \quad (8)$$

$$V_3 = \sqrt{-2(1 - B)\cos\varphi_1 + (1 - B)^2 + 1 + 1/\alpha} \quad (9)$$

Mode IV: At t_3 , the energy stored in resonant capacitor (C_r) will be transferred to output stage through the elements L_r and Q_2 .

$$V_r(t) = V_s(1 - B)[I_3 \sin(\omega_r(t - t_0))] \quad (10)$$

$$I(t) = (B - V_3)\sin(\omega_r(t - t_3)) \quad (11)$$

$$I_4 = (B - V_3)^2 - B^2 \quad (12)$$

Mode V: At t_4 , the diode D_r is turned on under ZVS condition and the current i_r flows through it. The energy remained in L_r provides ZVS condition to turn the switch Q_1 on. Hence, the switch Q_2 will be turned off at t_5 under ZVS condition. In this mode the energy stored in L_r is transferred to the output stage.

$$V_r(t) = V_s[1 + \alpha(1 - B)\cos(\omega_r(t - t_4))] \quad (13)$$

$$I(t) = B \omega_r(t - t_4) + I_4 \quad (14)$$

Mode VI: In this mode, the voltage of node M (called V_m) will reach the zero level which leads to set the voltage of diode d_1 to make it ready to be turned on in the next mode and provide the ZVS turn-on condition for switch Q_1 .

$$V_r(t) = V_s[1 + \alpha(1 - B)\sin(\omega_r(t - t_5)) + \cos(\omega_r(t - t_5))] \quad (15)$$

$$I_6 = \sqrt{I_5^2 - \left(\frac{1+2B}{\alpha}\right)} \quad (16)$$

Mode VII: In t_6 , d_1 is turned on under ZVS condition and the resonant current flows through it until it reaches the zero level at t_7 . In this mode, the gate signal of Q_1 will be ready to turn it on in the next interval mode.

$$I_r(t) = (B + 1) \sin(\omega_r(t - t_6)) + I_6 \quad (17)$$

$$V_r(t) = V_s[(\alpha)(-1/2)(1 - B)\sin(\omega_r(\alpha)^{(-1/2)}(t - t_6)) + B\cos(\omega_r(\alpha)^{(-1/2)}(t - t_6))] \quad (18)$$

Due to having a reasonable ripple for the output DC signal, equations (18) and (19) have been considered to set the ripple to less than 0.01 for the DC output.

$$P_{out} = \frac{(V_{out})^2}{R_{out}} \quad (19)$$

$$\frac{\Delta V_{out}}{V_{out}} < 0.01 \quad (20)$$

TABLE I
PARAMETERS AND COMPONENTS OF THE CIRCUIT

| Symbol | Full-Load |
|-----------|-----------|
| V_S | 0.35V |
| V_O | 1.5V |
| P_{out} | 112uW |
| f_s | 242kHz |
| C_r | 1nF |
| L_r | 25nH |
| C_1 | 0.25nF |
| C_2 | 0.25nF |

Considering all the information given above, the elements of the circuit were designed and set to the closest suitable value to theoretical results in simulation in PSIM environment shown in Table I. Figure. 3 shows schematic of the converter plotted with the values of all designed elements which result in ZVS condition gained for primary side switches. In Fig. 4 and Fig. 5 the voltages of drain-source in primary side switches Q_1 and Q_2 are presented respectively. Moreover, Fig. 6 illustrates the voltage of resonant capacitor (C_r) while in Fig. 7 the voltages of secondary side diode-connected MOSFETs are shown in separate diagrams result in DC output signal.

III. CONCLUSION

In this paper a new DC/DC isolated resonant converter working under ZVS with diode-connected MOSFET in rectifier has been introduced which is capable of working in high frequencies such as radio frequencies with satisfying power conversion rate as well as low losses making it suitable for wide range of applications. The active resonant network is the composition of a resonant capacitor, a diode-connected MOSFET and a transformer leakage inductance which provides ZVS condition for the switches in the proposed converter.

REFERENCE

- [1] M. Jabbari, "Unified Analysis of Switched-Resonator Converters", IEEE Trans. on Power Electronics, Vol. 26, No. 5, 2011.
- [2] N. Nourieh, Y. Sun and O. Simpson, "A novel resonant ZVS power converter with self-driven synchronous rectifier for low-voltage high-current applications", IET Power Electronics, Vol. 14, No. 8, 2021.
- [3] R. Ashique and Z. Salam, "A Family of True Zero Voltage Zero Current Switching (ZVZCS) Nonisolated Bidirectional DC-DC Converter With Wide Soft Switching Range", IEEE Trans. on Industrial Electronics, Vol. 64, No. 7, July 2017.
- [4] A. Ayachit, F. Corti, A. Reatti and M. Kazimierzuk, "Zero-Voltage Switching Operation of Transformer Class-E Inverter at Any Coupling Coefficient", IEEE Trans. On Industrial Electronics, Vol. 66, No. 3, 2019.
- [5] L. Shouxiang, Z. Yifei, W. Bin and K. Smedley, "A Family of Resonant Two-Switch Boosting Switched-Capacitor Converter with ZVS Operation and a Wide Line Regulation Range", IEEE Transactions on Power Electronics, Vol. 33, No. 1, 2018.
- [6] M. Roíguez, G. Diego, M. Lamar, R. Prieto and J. Sebastián, "A Novel Adaptive Synchronous Rectification System for Low Output Voltage Isolated Converters", IEEE Trans on Industrial Electronics, Vol. 58, No. 8, 2011.
- [7] M. Alexander, R. Blanchard and R. Severn, "MOSFET Move in on Low Voltage Rectifier", MOSPOWER Applications Handbook, Siliconix Technical Article, PP. 5-87-5-84, 1984, Siliconix Inc.
- [8] K. Jin, L. Gue, and J. Wang, "A 10-MHz Resonant Converter With a Synchronous Rectifier for Low-Voltage Applications", IEEE Trans. on Power Electronics., Vol. 34, No. 4, 2019.
- [9] K. J. Woo and A. G. Woo, "A New LLC Series Resonant Converter with a Narrow Switching Frequency Variation and Reduced Conduction losses", IEEE Trans. on Power Electrons. Vol. 29, No. 8, 2011.
- [10] J. W. Yang and H. L. Do, "Soft-Switching Dual-Flyback DC-DC Converter With Improved Efficiency and Reduced Output Ripple Current", IEEE Trans. on Industrial Electronics, Vol. 64, No. 5, 2017.
- [11] E. Asa, K. Colak and D. Czarkowski, "Analysis of CLL Resonant Converter with Semi Bridgeless Active Rectifier and Hybrid Control", IEEE Trans. Industrial Electronics, Vol. 62, No. 11, 2015.
- [12] R. L. Lin and L. H. Huang, "Efficiency Improvement on LLC Resonant Converter Using Integrated LCLC Resonant Transformer", IEEE Trans. on Industrial Electronics, Vol. 54, No. 2, 2018.