



 **ICP VEGETATION** 

**22nd Task Force Meeting
of the ICP Vegetation**

**2 – 5 February 2009
Braunschweig, Germany**

Programme

Abstracts

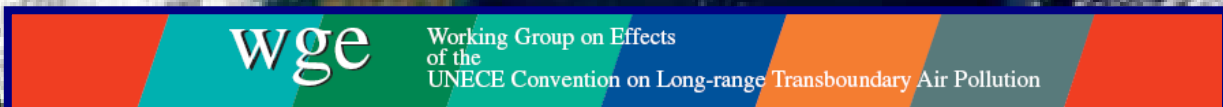
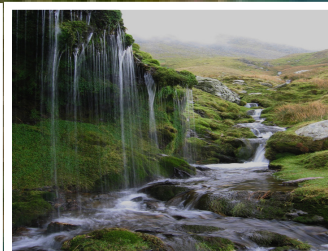

Organisers:

ICP Vegetation Programme Coordination Centre
Centre for Ecology and Hydrology,
Bangor, UK.

Institute of Biodiversity
Johann Heinrich von Thünen-Institute (vTI)
Federal Research Institute for Rural Areas, Forestry and Fisheries
Braunschweig

Organising Committee:



**Centre for
Ecology & Hydrology**

NATURAL ENVIRONMENT RESEARCH COUNCIL

*Harry Harmens
Gina Mills
Nina Menichino*

Local Organising Committee:



**Johann Heinrich
von Thünen-Institut**

*Jürgen Bender
Hans Weigel*



**Centre for
Ecology & Hydrology**
NATURAL ENVIRONMENT RESEARCH COUNCIL

Convention on Long-range Transboundary Air Pollution

Working Group on Effects

**International Cooperative Programme on Effects
of Air Pollution on Natural Vegetation and Crops**

Programme

**22nd Task Force Meeting
of the ICP Vegetation**

**2nd – 5th February, 2009
Braunschweig, Germany**



**Johann Heinrich
von Thünen-Institut**



Monday 2nd February, 2009

17:00 – 20:00 Registration in the City Hotel, Braunschweig

19:30 Welcome reception in the City Hotel, Braunschweig.

Tuesday 3rd February, 2009

8:00 Bus departs from the City Hotel to vTI

Note: participants staying in other hotels need to come to the City Hotel to take the bus to vTI.

Session 1: 09:00 – 10:45 Plenary session

Chair: Jürgen Bender

9:00 Welcome *Carsten Thoroë*, President of the Johann Heinrich von Thünen-Institute (vTI).

9:05 Welcome by *Christian Grugel*, Federal Ministry of Food, Agriculture and Consumer Protection.

9:20 *Matti Johansson* – News from the Convention Secretariat.

9:35 *Till Spranger* – Report from the ICP Modelling and Mapping.

9:45 *Marcus Schaub* et al. – Ozone concentration, exposures and visible injury on ICP Forests level II plots for 2000 – 2004.

9:55 *Harry Harmens* et al. – An overview of the achievements of the ICP Vegetation in 2008.

10:25 *Hans Weigel* et al. – Overview of research activities at the Institute of Biodiversity.

10:45 – 11:30 Coffee/tea and poster viewing

Session 2: 11:30 – 12:45 Plenary session

Chair: Håkan Pleijel

11:30 *Jürgen Franzaring* et al. – Establishing a European standard for biomonitoring - The grass culture method.

11:50 *Per Erik Karlsson* et al. – Ozone exposure and impacts on vegetation in the Nordic countries and Baltic States.

12:10 *Patrick Büker* et al. – Impact of air pollution on crops in South Asia and southern Africa.

12:30 Discussion on outreach activities.

12:45 – 14:00 Lunch

Session 3: 14:00 – 15:30 Two parallel sessions: Ozone and Heavy Metals/N

Session 3a: Ozone

Chair: Jürg Fuhrer

- 14:00 *Seraina Bassin et al.* – Effects of combined ozone and nitrogen deposition on yield, species composition, and the performance of individual plant species of a sub-alpine pasture.
- 14:20 *Sally Power et al.* – How does resource availability affect plant response to ozone?
- 14:40 *Kirsten Wyness et al.* – Ozone and nitrogen controls on carbon allocation within two semi-natural plant species.
- 15:00 *Ludger Grünhage et al.* – Ozone risk assessment for winter wheat at local scale: Evaluation of the UNECE flux approach.
- 15:20 Discussion

Session 3b: Heavy metals

Chair: Ludwig De Temmerman

- 14:00 *Harry Harmens et al.* – Spatial and temporal trends in heavy metal accumulation in mosses in Europe (1990-2005).
- 14:20 *Iliya Ilyin et al.* – Modelled EMEP heavy metal deposition vs. moss measurements: Evaluation of spatial patterns and long-term temporal trends.
- 14:40 *Marcel Holy et al.* – Europe-wide analysis of factors influencing the spatial variation of cadmium, lead and mercury concentrations in mosses
- 15:00 *Sébastien Leblond et al.* – Atmospheric deposition versus element concentration in mosses: case of nitrogen and other elements.
- 15:20 Discussion

15:30 – 16:00 Coffee/tea and poster viewing

Session 4: 16:00 – 17:45 Two parallel sessions: Ozone and Heavy Metals/N

Session 4a: Ozone

Chair: Ben Gimeno

- 16:00 *Jürg Fuhrer et al.* – Ozone flux in alpine grassland.
- 16:20 *Patrick Büker et al.* – Development and provisional application of a multi-layer grassland flux model.
- 16:40 *Felicity Hayes et al.* – A flux-effect relationship for above- and below-ground impacts of ozone on two semi-natural grassland species.
- 17:00 *Ignacio González Fernández et al.* – Modelling stomatal ozone flux of dehesa annual grasslands in central Spain.
- 17:20 General discussion on local parameterisations for flux models.

Session 4b: Heavy metals

Chair: Jesús Santamaría

- 16:00 *Harry Harmens* et al. – Spatial trends in nitrogen concentrations in mosses across Europe in 2005/2006.
- 16:20 *Harald Zechmeister* et al. – Total nitrogen content and $\delta^{15}\text{N}$ signatures in moss tissue: Indicative value for nitrogen deposition patterns and source allocation on a nation-wide scale.
- 16:40 *Karsten Mohr* – Biomonitoring of nitrogen pollution with bryophytes – possibilities and limitations.
- 17:00 *Willy Werner* et al. – Nitrogen concentrations and $\delta^{15}\text{N}$ -ratios in epiphytic lichen *Xanthoria parietina* in correlation to nitrogen deposition rates and $\delta^{15}\text{N}$ -ratios of colonised tree bark.
- 17:20 General discussion on biomonitoring of nitrogen pollution using mosses.
- 18:00 Bus departs to the City Hotel.**
- Evening** Meeting Scientific Committee Ozone Workshop: ‘Quantification of ozone impacts on crops and (semi-)natural vegetation’, November 2009, Ispra, Italy.

Wednesday 4th February, 2009

8:15 – 10:00 Sightseeing tour Braunschweig

Note: participants not attending the sightseeing tour need to be at the Burgplatz at **10:00** to take the bus to vTI.

10:00 Bus departs to vTI

10:30 – 11:00 Coffee/tea and poster viewing

Session 5: 11:00 – 12:45 Two parallel sessions: Ozone and Heavy Metals/N

Session 5a: Ozone

Chair: Gina Mills

- 11:00 *Gina Mills* – Update on the next Ozone Critical Levels Workshop, 10 – 12 November 2009, Ispra, Italy.
- 11:20 *Gina Mills* et al. – Results of the bean experiment 2008 and preparations for the 2010 biomonitoring experiment, followed by discussion on the future ozone work programme.

Session 5b: Heavy metals

Chair: Harry Harmens

11:00 *Eiliv Steinnes* – Strong and weak points of the moss biomonitoring technique for metal deposition studies as illustrated from 30 years experience in Norway.

11:20 *Harry Harmens* et al. – Uncertainties in the European moss data and preparations for the 2010 moss survey, followed by discussions on the future heavy metals and nitrogen work programme.

12:45 – 14:00 Lunch

Session 6: 14:00 – 15:30 Two parallel sessions: Ozone and Heavy Metals/N

Session 6a: Ozone

Chair: Patrick Büker

14:00 *Håkan Pleijel* et al. – Growth dilution/concentration effects of ozone and carbon dioxide on the content of starch, nitrogen, zinc, manganese and cadmium in wheat grain.

14:20 *Karine Vandermeiren* et al. – Impact of tropospheric ozone on food and feed quality of Brassica species (OFFQ).

14:40 *Elmien Heyneke* et al. – Interaction between SO₂ fumigation and drought stress on growth, photosynthesis and symbiotic nitrogen fixation in soybean using an open-top chamber facility.

15:00 Discussion on ozone workshop, November 2009, Ispra, Italy.

Session 6b: Heavy metals

Chair: Winfried Schröder

14:00 *Marina Frontasyeva* et al. – Moss biomonitoring of long-lived radionuclides in Belarus: 20 years after Chernobyl.

14:20 *Zdravko Spiric* et al. – Moss biomonitoring of trace elements in Croatia.

14:40 *Lotti Thöni* et al. – Response of mosses to atmospheric deposition of eight metals in Bulgaria and Switzerland - surveys 1990-2005.

15:00 *Ivan Suchara* et al. – Landscape factors significantly controlling element content distribution in mosses in the Czech Republic.

15:20 Discussion

Coffee/tea: 15:30 – 16:00

Session 7: 16:00 – 18:00 Plenary session

Chair: Harry Harmens

- Reporting back from ozone and heavy metals sessions.
- ICP Vegetation work programme 2009 – 2011, including items common to all ICPs/Task Force on Health.
- Collaboration with other relevant bodies/organizations such as Task Force on Reactive Nitrogen, Malé Declaration, TFIAM.
- Conclusions and review of the 22nd Task Force Meeting.

18:15 Bus departs to the City hotel.

19:30 Bus departs from the City hotel to the restaurant for the conference dinner.

Thursday 5th February, 2009

Bus will take participants from the City Hotel to Hannover Airport. Departure time will depend on the departure of flights of the majority of participants.

List of Abstracts of Oral Presentations

General

- Harmens, H., Mills, G., Hayes, F., Jones, M.L.M., Norris D.A., Hall, J., Cooper, D.M. and the participants of the ICP Vegetation. *An overview of the achievements of the ICP Vegetation in 2008.* (21)
- Franzaring, J., Klumpp, A., Beismann, H. *Establishing a European standard for biomonitoring - the grass culture method.* (16)

Ozone

- Bassin, S., Volk, M., Buchmann, N., Fuhrer J. *Effects of combined ozone and nitrogen deposition on yield, species composition, and the performance of individual plant species of a sub-alpine pasture.* (13)
- Büker, P., Emberson, L. and RAPIDC participants. *Impact of air pollution on crops in South Asia and southern Africa.* (14)
- Emberson, L. and Büker, P. *Development and provisional application of a multi-layer grassland flux model.* (15)
- Fuhrer, J., Hansson, M., Ammann, C. *Ozone flux in alpine grassland.* (18)
- González Fernández, I., Elvira, S., Alonso, R., Bermejo, V., Sanz, J., Gimeno, B.S. *Modelling stomatal ozone flux of dehesa annual grasslands in central Spain.* (19)
- Grünhage, L., Braden H., Bender J., Wojtkowiak J., Weigel, H.J., Hanewald K. *Ozone risk assessment for winter wheat at local scale: Evaluation of the UNECE flux approach.* (20)
- Hayes, F., Wagg, S., Mills, S., Davies, W. *A flux-effect relationship for above- and below-ground impact of ozone on two semi-natural grassland species.* (24)
- Heyneke, E., Van Heerden, P.D.R., Strasser, R.J. and Krüger, G.H.J. *Interaction between SO₂ fumigation and drought stress on growth, photosynthesis and symbiotic nitrogen fixation in soybean using an open-top chamber facility.*(25)
- Karlsson, P.E. *et al.* *Ozone exposure and impacts on vegetation in the Nordic countries and Baltic States.* (28)
- Mills, G., Hayes, F., Menichino, N. *Results of the bean ozone biomonitoring experiment 2008.* (30)
- Pleijel, H. and Uddling J. *Growth dilution/concentration effects of ozone and carbon dioxide on the content of starch, nitrogen, zinc, manganese and cadmium in wheat grain.* (32)
- Power, S.A., Khalid, S., Adrees, M., Green, E.R., Callaghan, N. *How does resource availability affect plant response to ozone?* (33)
- Schaub M., Ferretti M., Calatayud, V., Sanz, M.J. *Ozone concentration, exposures and visible injury on ICP Forests level II plots for 2000 – 2004.* (35)
- Vandermeiren K., De Bock M., Horemans N. Op de Beeck M. *Impact of Ozone on Food and Feed Quality Brassicacea (OFFQ).* (40)
- Wyness K., Jones L., Mills G., Barnes J., Jones D. *Ozone and nitrogen controls on carbon allocation within two semi-natural plant species.* (42)

Heavy Metals & Nitrogen

- Frontasyeva, M.V., Aleksiyenak, Yu.V. Steinnes E., Florek M., Sýkora I., Jeřkovský M., Ramatlhape I., Faanhof A. *Moss biomonitoring of long-lived radionuclides in Belarus: 20 years after Chernobyl.* (17)
- Harmens, H., Norris, D. and the participants of the moss survey. *Spatial and temporal trends in heavy metal accumulation in mosses in Europe (1990-2005).* (22)
- Harmens, H., Norris, D.A., Cooper, D.M., Hall, J. and the participants of the moss survey. *Spatial trends in nitrogen concentrations in mosses across Europe in 2005/2006.* (23)
- Holy, M., Pesch, R., Schröder, W., Harmens, H., Alber, R., Aleksiyenak, Y., Blum, O., Coskun, M., Dam, M., De Temmerman, L., Frolova, M., Frontasyeva, M., Grodzińska, K., Jeran, Z., Kubin, E., Kvietskus, K., Leblond, S., Liiv, S., Magnússon, S., Maňkovská, B., Miodrag, K., Rühling, Å., Santamaria, J., Steinnes, E., Suchara, I., Szymon, K., Thöni, L., Urumov, V., Yurukova, L., Zechmeister, H. *Europe-wide analysis of factors influencing the spatial variation of cadmium, lead and mercury concentrations in mosses.* (26)
- Ilyin, I. *Modelled EMEP heavy metal deposition vs. moss measurements: Evaluation of spatial patterns and long-term temporal trends.* (27)
- Leblond S., Croise L. Ulrich E., Rausch de Traubenberg C. *Atmospheric deposition versus element concentration in mosses: case of nitrogen and other elements.* (29)
- Mohr, K. *Biomonitoring of nitrogen pollution with bryophytes – possibilities and limitations.* (31)
- Saxena, D.K. Srivastava, K. Singh, S. *Monitoring of metal precipitation (2003-2007) by moss *Barbula constricta* from Mussoorie hills in India.* (To be confirmed) (34)
- Spiric Z., Frontasyeva M.V., Stafilov T., Steinnes E., Bukovec D. *Moss biomonitoring of trace elements in Croatia.* (36)
- Steinnes, E., Berg, T. *Strong and weak points of the moss biomonitoring technique for metal deposition studies as illustrated from 30 years' experience in Norway.* (37)
- Sucharova J., Suchara I., Holá M. *Landscape factors significantly controlling element content distribution in mosses in the Czech Republic.* (38)
- Thöni, L., Yurukova, L., Ilyin, I., Matthaei, D. *Response of mosses to atmospheric deposition of eight metals in Bulgaria and Switzerland - surveys 1990-2005.* (39)
- Werner, W.H., Boltersdorf, S.H. *Nitrogen concentrations and $\delta^{15}N$ -ratios in epiphytic lichen *Xanthoria parietina* in correlation to nitrogen deposition rates and $\delta^{15}N$ -ratios of colonised tree bark.* (41)
- Zechmeister, H.G., Richter, A., Smidt, S., Hohenwallner, D., Roder, I., Maringer, S., Wanek, W. *Total nitrogen content and $\delta^{15}N$ signatures in moss tissue: Indicative value for nitrogen deposition patterns and source allocation on a nation-wide scale.* (43)

List of Abstracts of Poster Presentations

Ozone

- Calatayud, V., Cerveró, J., Sanz, M.J. *Contrasting ozone sensitivity of evergreen and deciduous oaks.* (45)
- Calvo, E., Marco, F., Martin, C., Calatayud, V., Sanz, M. J. *Comparative ozone sensitivity of eight potato cultivars.* (46)
- Elvira, S., Alonso, R., Sanz, J., Bermejo, V., González-Fernández, I., Gimeno, B.S. *Ozone dose-response functions for annual Mediterranean herbaceous species.* (47)
- Goumenaki, E., Barnes, J. *Ozone risk assessment for crops in Crete, Greece.* (49)
- Salam, M.A., Islam, M.T. *Assessment of tropospheric ozone injuries in plants under ambient condition in Bangladesh.* (55)
- Smit, P.R., Büker, P., Krüger, G.H.J. *Biomonitoring of tropospheric ozone in South Africa, using white clover (*Trifolium repens* L. cv. Regal) biotypes: growth and physiological effects following ambient and elevated ozone exposure.* (58)
- Villányi, V., Csintalan, Z., Urmös, Z., Nagy, Z., Tuba, Z. *Some physiological features of commonly used bioindicators of tropospheric ozone.* (61)

Heavy Metals & Nitrogen

- Gimeno, B.S., Yuan, F., Fenn, M.E., Meixner, T. *Interactions between N deposition and fire in Mediterranean ecosystems. Efficiency of air pollution control abatement.* (48)
- Leblond, S., Galsomies, L., Deportes, I., Belon, E. *Assessing trace elements main inputs to agricultural soils: case study of the use of French moss survey.* (50)
- Maňková, B., Oszlányi, J. *Mosses and foliage of forest tree species as biomonitors of nitrogen pollution.* (51)
- Poikolainen, J., Piispanen, J., Karhu, J., Kubin, E. *Comparison of nitrogen concentration *Hylocomium splendens* and *Pleurozium schreberi* in Finland.* (52)
- Rabecz, G., Jócsák, I. *Bioindication investigation around an oil-refinery in Hungary based on moss technique (Temporal Trends 1991-2008).* (53)
- Saitanis K., Frontasyeva M.V., Steinnes E., Ostrovnaya T.M., Gundorina S.F., Tzamgizis L. *Ambient air monitoring using the moss bag technique in the Thriassion Plain, Attika, Greece.* (54)
- Santamaría, J.M., Ederra, A., González, L., Elustondo, D. *Retrospective analysis of $\delta^{15}\text{N}$ and $\delta^{13}\text{C}$ signatures in the natural park of Bertiz (Spain) using herbarium moss samples.* (56)
- Suchara I., Sucharová J., Holá M. *Temporal and spatial changes in element content distribution in moss in the Czech Republic in the last 15 years.* (59)
- Sucharová J., Suchara I., Holá M., Reimann C., Boyd R. *Biogeochemical exploration of forests as a basis for long-term landscape management in the Czech Republic. Introduction to project CZ0074.* (60)

Abstracts

Oral Presentations

EFFECTS OF COMBINED OZONE AND NITROGEN DEPOSITION ON YIELD,
SPECIES COMPOSITION, AND THE PERFORMANCE OF INDIVIDUAL PLANT
SPECIES OF A SUB-ALPINE PASTURE

Bassin S., Volk M., Buchmann N., Fuhrer J.

*Agroscope Reckenholz-Tanikon Research Station ART, Reckenholzstrasse 191, 8046
Zurich, Switzerland
Seraina.Bassin@art.admin.ch*

A field experiment was established in the central Swiss Alps at 2000 m a.s.l. to investigate the effects of elevated ozone (O₃) and nitrogen deposition (N), and of their combination, on aboveground productivity and species composition of sub-alpine grassland (mean ambient O₃ concentration: 45-47 ppb, background N deposition: 3-4 kg N ha⁻¹ y⁻¹). 180 monoliths were extracted from a species-rich *Geo-Montani-Nardetum* pasture and exposed in a free-air O₃-fumigation system to one of three levels of O₃ (ambient, 1.2 x ambient, 1.6 x ambient) and five levels of extra N (0, 5, 10, 25, 50 kg N ha⁻¹ y⁻¹).

During five years, aboveground biomass and the proportion of functional groups were measured annually. In the second and third season, the 11 most frequent plant species were analysed with the aim to detect subtle effects on leaf chlorophyll and N concentrations, leaf weight, specific leaf area (SLA), and δ¹⁸O and δ¹³C as proxies for gas exchange. We expected that the species' responsiveness to O₃ and N would be related to their functional traits and that N-induced changes in these traits would modify the species' response to O₃ via increased growth and higher leaf conductance (g_s).

The vegetation responded to the extra N input with an increase in aboveground productivity and altered species composition, but without changes due to elevated O₃. N input above 10 kg N ha⁻¹ y⁻¹ was sufficient to affect the composition of functional groups, with sedges benefiting over-proportionally. Most species reacted to N supply with the accumulation of N and chlorophyll, but with no change in SLA, g_s, and growth, except *Carex sempervirens* which showed increased water use efficiency (WUE) and higher leaf weight. Elevated O₃ reduced g_s in most species, but not significantly. Contrary to our expectation, the magnitude of the response to both O₃ and N was not related to species-specific traits such as SLA or g_s, and no O₃ x N interaction was observed.

In conclusion, since for most species neither N nor gas exchange limited growth, their short-term response to O₃ and N and to their combination was small. The substantial change in species composition observed in response to elevated N deposition, however, is related to the extraordinary ability of *C. sempervirens* to invest extra N into growth. Overall, the results after five years suggest that species-rich subalpine pastures are threatened by elevated N deposition rather than from increased O₃ exposure.

Bassin S., Volk M., Suter M., Buchmann N. & Fuhrer J., 2007. Nitrogen but not ozone affects productivity and species composition of subalpine grassland after 3 yr of treatment. *New Phytologist* 175, 523-534

Bassin S., Werner R.A., Sörgel K., Volk M., Buchmann N., Fuhrer J., 2009. Effects of combined ozone and nitrogen deposition on the in situ properties of eleven key plant species of a subalpine pasture. *Oecologia* 158, 747-756.

IMPACT OF AIR POLLUTION ON CROPS IN SOUTH ASIA AND SOUTHERN AFRICA

Büker, P., Emberson, L. and RAPIDC participants

Stockholm Environment Institute, York, University of York
Heslington, York, YO10 5 DD, U.K.

patrick.bueker@sei.se, lisa.emberson@sei.se

Phase III of the crops component of the RAPIDC¹ Programme focussed on developing risk assessment methods to investigate O₃ impacts on crop productivity in South Asia and southern Africa; with activities undertaken under the auspices of the Malé Declaration² and APINA³, respectively. This project had three main aims: i) to perform provisional modelling based risk assessments to define the extent and magnitude of potential impacts; ii) to perform experimental studies to compliment these regional scale risk assessment and iii) to develop methods to understand the socio-economic consequences of yield losses due to O₃.

The provisional risk assessments identified O₃ hot spot regions across the agriculturally important Indo-Gangetic plain region in South Asia and across central and eastern parts of southern Africa. Based on these regional risk assessments, experimental field sites were identified in 5 South Asian and 6 southern African countries. At all sites O₃ was monitored using passive samplers. Standardized experimental protocols were developed for regional conditions to enable application of the i) white clover clone bio-monitoring and ii) chemical protectant (using ethylenediurea, EDU) experimental methods.

Fig.1 shows the clover NC-S/NC-R clone biomass ratios, ranging from 0.5 to 1.06 (mean: 0.83) under 4-weekly mean O₃ concentrations of between 12 and 35 ppb (mean: 22 ppb). Results of the EDU study (Fig. 2) using mung bean (wheat, potato and spinach were also exposed) show yield losses of up to 63% (mean: 27%) under 4-weekly mean O₃ concentrations of between 17 and 61 ppb (mean: 38 ppb). Provisional economic loss assessments made for South Asia using European AOT40 dose-response relationships estimated losses in the region of ~ US\$ 3.9 billion per year for 4 staple crops.

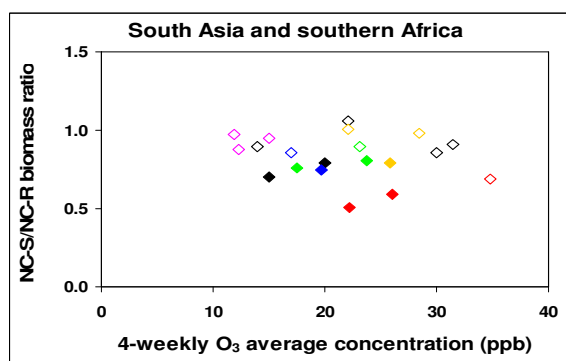

Fig. 1 NC-S/NC-R biomass ratio of clover against 4-weekly average O₃ conc. Different colours indicate different countries. Hollow diamonds = non-significant effects, filled diamonds = significant effects.

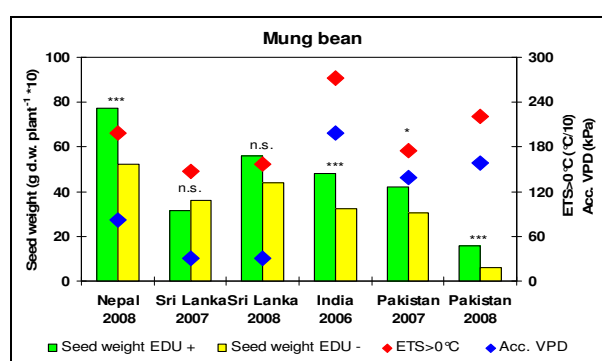

Fig. 2 Yield loss of non-EDU vs. EDU treated mung bean at different sites and years in South Asia, and accumulated effective temperature sum (ETS) above 0°C and accumulated VPD of experimental periods.

Future activities would develop collaborations between LRTAP and Malé Declaration and APINA, and specifically between the ICP Vegetation and crop activities in RAPIDC regions.

¹ Regional Air Pollution in Developing Countries; a project funded by the Swedish International Development Cooperation Agency (Sida)

² <http://www.rrcap.unep.org/issues/air/Maledec/>

³ Air Pollution Information Network for Africa, <http://www.sei.se/rapidc/apina.htm>

DEVELOPMENT AND PROVISIONAL APPLICATION OF A MULTI-LAYER GRASSLAND FLUX MODEL

Emberson, L., Büker, P.

*Stockholm Environment Institute, York, University of York
Heslington, York, YO10 5 DD, U.K.
lisa.emberson@sei.se, patrick.bueker@sei.se*

The existing DO₃SE⁴ grassland flux model (Ashmore et al., 2007) was used to develop a framework for a multi-layer canopy model version. The introduction of five canopy layers allowed for the incorporation of variable LAI fractions, light penetration and O₃ concentration in assessments of O₃ flux to canopy components. The model was parameterised for productive grasslands based on two species (*Lolium perenne* and *Trifolium repens*) representing grass and legume plant functional types using available primary and secondary European data. The influence of N supply on O₃ flux was considered predominantly through variations in parameterisation of LAI and g_{\max} . Although attempts were made to use the model to derive reliable flux-response relationships, this proved impossible due to the limited number of appropriate datasets.

A provisional application of the model was made at the European scale. Fig. 1 shows the seasonal profile of modelled canopy stomatal flux (Fst), accumulated stomatal flux (AFst) and AOT40 for two locations in Europe. The effects of simulated management cuts are clearly apparent in the periodic instances of reduced Fst.

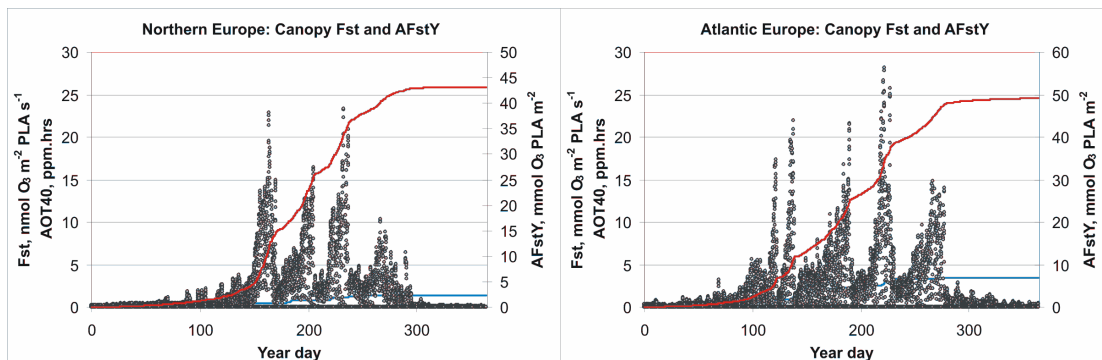

Fig. 1 Seasonal profiles of whole canopy stomatal flux (Fst, nmol O₃ m⁻² s⁻¹), accumulated stomatal flux above a threshold of Y (AFstY, mmol m⁻²) and AOT40 (ppm.hrs) for a Northern European and Atlantic Central European EMEP grid.

While the model provided values of total O₃ deposition and surface resistance in the expected range, a thorough evaluation is required before a reliable application of the model could be made at the European scale. However, the provisional modelling highlighted the importance of LAI both as a seasonal driver of total stomatal O₃ flux and deposition, as well as a key determinant of flux to different species within the canopy. Since this variable will be affected by factors such as soil water, management and N fertilization, future applications of the model will require a clear definition of the productive grassland system under investigation.

Ashmore, M.R., Büker, P., Emberson, L.D., Terry, A.C., Toet, S. (2007). Modelling stomatal ozone flux and deposition to grassland communities across Europe. *Environmental Pollution* 146, 659-670.

⁴ DO₃SE: Deposition of Ozone and Stomatal Exchange Model

ESTABLISHING A EUROPEAN STANDARD
FOR BIOMONITORING — THE GRASS CULTURE METHOD

Franzaring J.*, Klumpp A.*, Beismann H.**

* *Universität Hohenheim, Institut für Landschafts- und Pflanzenökologie (320), Ökologiezentrum 2, August-von-Hartmann-Str. 3, D-70599 Stuttgart*

** *VDI e.V., Kommission Reinhaltung der Luft im VDI und DIN - Normenausschuss KRdL, Postfach 10 11 39, D-40002 Düsseldorf, Germany. beismann@vdi.de*

Recently, the European Committee for Standardization (CEN) established within the Technical Committee 264 “Air Quality” a working group entitled “Biomonitoring methods with flowering plants” (CEN/TC 264/WG 30). The working group is currently developing a European standard for the bioindication of ozone effects (exposure of BelW3 tobacco) and a European standard for grass cultures. The secretariat is held by the German organisation KRdL (Kommission Reinhaltung der Luft im VDI und DIN). Another working group CEN/TC 264/WG31, which is developing biomonitoring methods with lower plants is held by AFNOR (L'Association française de Normalisation).

WG30 met twice in 2008 with participants from B, D, F, GR, PL, SLO and the UK. Work is currently dealing with merging the French¹ and German² grass culture guidelines, which are the only national standards, developed so far for this active bioindication method. Although studies using grass cultures for the biomonitoring of air pollution impacts have been performed in many European (e.g. within EuroBionet) and South American countries, the methods have not yet been fixed in international guidelines.

Examples of recent grass culture studies will be shown to inform the audience on the strengths of this active bioindicator method. In Germany, where the method was originally developed in the 1960s, investigations using standardised grass cultures were compulsive in local and regional air quality action plans (Luftreinhalteplan) in the 1980s and 1990s. While the method is not much used in such programs any more, it is still being applied from time to time in polluter-specific studies funded by the industry (polluters-pay-principle) and public bodies (regional action plans). Pre-grown ryegrass (*Lolium multiflorum* cv. Lema) is exposed for periods of four weeks in self-watering containers at a standard height at various locations around specific emitters or in regional networks. Thereafter the grass is harvested and chemical analyses are performed on the dried samples. Results of these analyses enable the clear identification of spatio-temporal impacts of air pollution and can be widely used in environmental impact studies or by industries proving that they operate efficient emission reduction systems. The pollutant concentrations determined in grass culture studies can also be related to existing EU reference levels, e.g. critical heavy metal and fluorine concentrations in animal feed³ and are thus a powerful tool to address potential pollutant impacts on the health of consumers.

¹ AFNOR (2008): NF X43-901. Biomonitoring of air quality - Active biomonitoring of air quality by ray-grass: from crops to sample preparation.² VDI (2003): VDI 3957 Part 2: Biological measuring techniques for the determination and evaluation of effects of air pollutants on plants (bioindication) - Method of standardised grass exposure. VDI/DIN Handbuch Reinhaltung der Luft, Band 1a, 28 pp. ³ EU (2005): Commission Directive 2005/87/EC amending Annex I to Directive 2002/32/EC on undesirable substances in animal feed as regards, lead, fluorine and cadmium. Official Journal, 06.12.2005, L 318/19-24.

MOSS BIOMONITORING OF LONG-LIVED RADIONUCLIDES IN BELARUS:
20 YEARS AFTER CHERNOBYL

Frontasyeva M.V.¹, Aleksiyenak Yu.V.¹, Steinnes E.², Florek M.³, Sýkora I.³,
Jeřkovský M.³, Ramatlhape I.⁴, Faanhof A.⁵

¹*Frank Laboratory of Neutron Physics, Joint Institute for Nuclear Research,
141980 Dubna, Moscow Region, Russia, E-mail: marina@nf.jinr.ru*

²*Norwegian University of Science and Technology, NO-7491 Trondheim, Norway*

³*Dept. of Nuclear Physics and Biophysics, Comenius University, Bratislava, SR*

⁴*Centre of Applied Radiation Science and Technology, North-West University
(Mafikeng Campus), Mmabatho, R SA*

⁵*South African Nuclear Energy Corporation, Pretoria, R SA*

Previous investigations have shown that 50% or more of radionuclides from aerial fallout are concentrated in the moss cover [1]. For the first time in the Republic of Belarus the well-established moss biomonitoring technique used to study atmospheric deposition of heavy metals and other trace elements was successfully applied for investigation of long-lived radionuclides some 20 years after the Chernobyl accident. Two hundred moss samples of *Hylocomium splendens* and *Pleurozium schreberi* were collected in the Gomel, Grodno and Minsk Regions in the summers of 2006–2008. Gamma spectrometry on the moss samples was performed in the low-level background counting laboratory of the Department of Nuclear Physics of the Comenius University in Bratislava, Slovakia, using an ORTEC HPGe detector (40 cm³) with a Be window, placed in a low-level background shield. The measuring time was 24 hours or more. A limited suite of samples was also measured at the South African Nuclear Energy Corporation using an ultra low level background counting facility (160 cm³ n-type HPGe Canberra BE5030 detector mounted in a lead shield of 13 cm lead of less than 50 Bq/kg and another layer of 2 cm less than 10 Bq/kg lined with 1 mm cadmium, 2 mm copper and 4 mm Perspex). Measuring time was one hour. Activities of natural radionuclides such as ⁴⁰K, ²¹⁰Pb and ²²⁶Ra were determined along with man-made ¹³⁷Cs. The ¹³⁷Cs activity in the moss partly reflects the initial deposition of ¹³⁷Cs fallout from the Chernobyl accident. The results obtained evidence that the levels of ¹³⁷Cs activity in the Gomel Region, predominantly caused by the Chernobyl radioactive fallout in 1986, are still 5–10 times higher than those in the neighbouring Minsk and Grodno Regions. Like active transport of naturally occurring caesium in moss [2], radioactive ¹³⁷C migrates from the older to the young shoots. Except for ²¹⁰Pb, the other measured radionuclides were most probably supplied to the moss by other mechanisms than atmospheric deposition.

[1] www.clu-in.org/download/remed/905b04001.pdf

[2] Frontasyeva M.V., Ermakova E.V., Steinnes E., Rahn K.A. Study of trace elements in annual segments of moss biomonitors using epithermal neutron activation analysis: link with atmospheric aerosol. «*Man-Made Radionuclides and Heavy Metals in the Environment*». Frontasyeva M.V., Vater P. and Perelygin V.P. – eds. Kluwer Academic Publishers, NATO Science Series, 2001, IV Earth and Environmental Sciences – Vol. 5, p. 165-170.

OZONE FLUX IN ALPINE GRASSLAND

Fuhrer J., Hansson, M., Ammann, C.

Air Pollution/Climate Group, AGROSCOPE Research Station ART, CH-8046 Zurich, Switzerland (juerg.fuhrer@art.admin.ch)

Long-term changes in alpine grassland (subalpine *Geo-Montani-Nardetum* pasture) exposed to increasing levels of ozone, in combination with different nitrogen (N) inputs, are currently studied at the experimental site Alp Flix (Sur), Switzerland (2000 m a.s.l.) In terms of botanical composition and physiological traits, the results obtained annually since 2004 suggest a low responsiveness to ozone of this semi-natural grassland ecosystem - independent of the level of N addition (Bassin et al., 2007; Bassin et al., 2009). Lack of an ozone response could be due to either a high detoxification capacity of the plants present, or to low rates of stomatal ozone uptake. The latter possibility was investigated in this analysis. The aims of the study were to use data for fluxes of trace gases, i.e. ozone and water vapour, measured during four weeks in June-July 2006 with dynamic chambers, to (i) calculate canopy stomatal conductance (g_s) to water vapour, and (ii) to compare the variation in 'observed' g_s with g_s calculated using published parameterizations of a simple multiplicative model (Jarvis-type) in combination with local meteorology.

Maximum g_s (g_{max}) derived from recalculation of water vapour fluxes in the dynamic chambers was estimated at $123 \text{ mmol (H}_2\text{O) m}^{-2} \text{ s}^{-1}$. This value of g_{max} is much lower compared to values in the literature, i.e. $734 \text{ mmol (H}_2\text{O) m}^{-2} \text{ s}^{-1}$. Accordingly, estimated actual g_s using parameterisation for f_{light} , f_{temp} and f_{VPD} obtained by minimizing the sum of the absolute residuals in the whole data set were much lower than those calculated with different model parameterizations. Hence, no parameterisation using published data explained the value of g_s estimated from chamber measurements well.

This comparison suggests that the vegetation at this high altitude site is characterized by very low rates of stomatal ozone uptake, compared to values for grasslands at lower altitudes. Using parameters obtained at lower altitudes in deposition models may thus lead to an over-estimation of ozone uptake and, hence, ozone risks. However, at this stage the values of g_s and g_{max} are considered preliminary and they need to be evaluated more extensively before any further use.

Bassin, S., Volk, M., Suter, M., Buchmann, N. & Fuhrer, J.: Nitrogen deposition but not ozone affects productivity and community composition of sub-alpine grassland after three years of treatment. *New Phytologist* 175, 523-534, 2007.

Bassin, S., Volk, M., Werner, R., Sörgel, K., Buchmann, N. & Fuhrer, J.: Effects of combined ozone and nitrogen deposition on the in situ properties of 11 key plant species of a subalpine pasture. *Oecologia* 158, 747-756, 2009.

MODELLING STOMATAL OZONE FLUX OF DEHESA ANNUAL GRASSLANDS IN CENTRAL SPAIN

González Fernández, I., Elvira, S., Alonso, R., Bermejo, V., Sanz, J., Gimeno, B.S.

CIEMAT, Avda. Complutense, 22. Ed 70. 28040, Madrid (Spain) E-mail:
ignacio.gonzalez@ciemat.es

Dehesa grasslands, one of the most characteristic landscapes of the central Iberian Peninsula, are frequently exposed to ambient ozone (O_3) levels reported as phytotoxic. A number of annual species dominating the herbaceous cover in this ecosystem have shown negative responses when exposed to O_3 (Gimeno *et al.*, 2004). Despite effects of O_3 on the biodiversity and productivity of semi-natural vegetation is an issue of rising interest, the number of studies focusing on dehesa grasslands is still scarce.

Current EMEP DO_3SE methodology for modelling the risk of O_3 impacts, involves the derivation of stomatal conductance using a multiplicative approach. However, this methodology presents some limitations in order to describe the inter-annual variability of plant phenology. High inter-annual variations of hydro-meteorological conditions can cause changes in the length of the growing season of annual communities. This may result into important variations of accumulated stomatal fluxes of O_3 ($AF_{st}Y$).

This work presents a coupled dynamic model (see Figure 1) designed to explore the interrelations between soil water availability, plant growth, the duration of the growing season and $AF_{st}Y$ of a dehesa pasture, using a simple, low input approach. Furthermore, the consequences of the observed inter-annual variability of pasture dynamics on modelled O_3 fluxes for dehesa pasture will be analyzed.

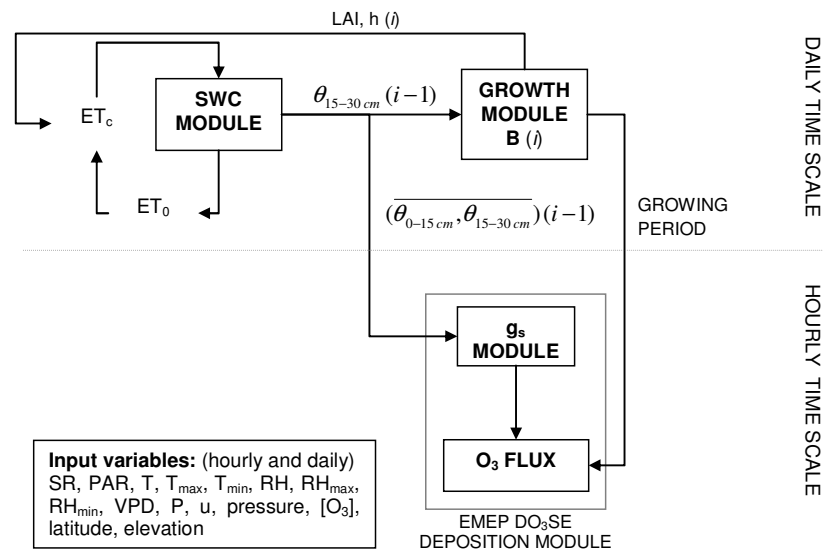

Figure 1. Diagram showing the modelling framework to predict stomatal fluxes of ozone for dehesa annual pastures.

References:

Gimeno *et al.*, 2004. *Environmental Pollution* **132**: 297-306.

OZONE RISK ASSESSMENT FOR WINTER WHEAT AT LOCAL SCALE: EVALUATION OF THE UNECE FLUX APPROACH

Grünhage L.¹⁾, Braden H.²⁾, Bender J.³⁾, Wojtkowiak J.¹⁾, Weigel, H.J.³⁾, Hanewald K.⁴⁾

¹⁾ *Department of Plant Ecology, Justus-Liebig University, Heinrich-Buff-Ring 26-32, D-35392*

Giessen, ludger.gruenhage@bot2.bio.uni-giessen.de

²⁾ *German Meteorological Service, Agrometeorological Research and Advisory Station, Bundesallee 50, D-38116 Braunschweig, harald.braden@dwd.de*

³⁾ *Institute of Biodiversity, Johann Heinrich von Thünen-Institute (vTI), Federal Research Institute for Rural Areas, Forestry and Fisheries, Bundesallee 50, D-38116 Braunschweig, Germany, juergen.bender@vti.bund.de*

⁴⁾ *Hessian Agency for the Environment and Geology, Rheingaustraße 186, D-65203 Wiesbaden, k.hanewald@hlug.de*

According to the Council Directives 96/62/EC Article 6 of 27 September 1996, 2002/3/EC of 12 February 2002 and 2008/50/EC of 21 May 2008 the air quality in the European Union has to be assessed and managed by means of sampling points for fixed measurement of concentrations of the respective air pollutant, here ozone. Therefore, local risk assessments have to be based on the parameters routinely measured by the air quality monitoring networks.

The flowchart given below summarizes the necessary steps in a local ozone risk assessment for crops by applying the UNECE flux approach. The method will be described and discussed in detail using empirical and observed data and models, respectively, for winter wheat. A working programme for improving the flux approach for local scale applications will be presented. While an appropriate risk evaluation must be transparent and understandable to the general public, the results may be illustrated by means of the colours of the traffic lights red, yellow and green similar to the MPOC approach.

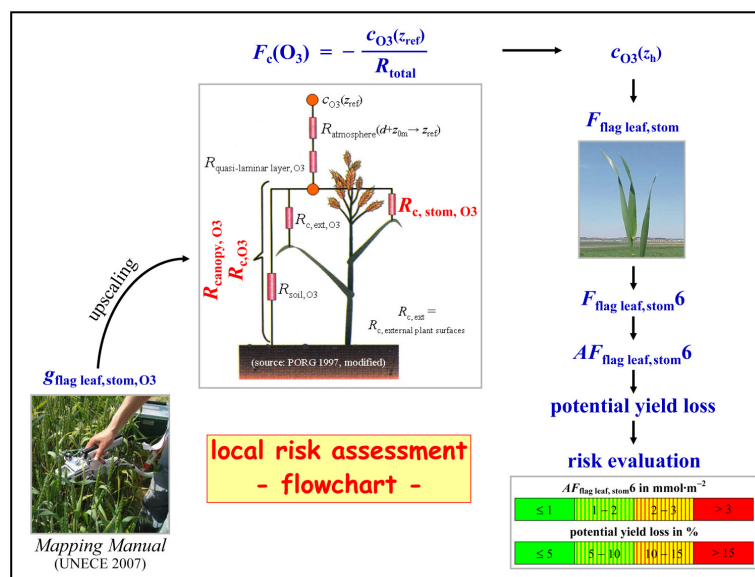

AN OVERVIEW OF THE ACHIEVEMENTS OF THE ICP VEGETATION IN 2008

Harmens, H.¹, Mills, G.¹, Hayes, F.¹, Jones, M.L.M.¹, Norris D.A.¹, Hall, J.¹,
Cooper, D.M.¹ and the participants of the ICP Vegetation

¹ *ICP Vegetation Programme Coordination Centre,
Centre for Ecology and Hydrology, Bangor, Gwynedd LL57 2UW, UK. hh@ceh.ac.uk*

The ICP Vegetation is an international programme that reports on the effects of air pollutants on natural vegetation and crops [1]. It reports to the Working Group on Effects (WGE) of the UNECE Convention on Long-range Transboundary Air Pollution (LRTAP). The ICP Vegetation focuses on two air pollution problems of particular importance: quantifying the risks to vegetation posed by ozone pollution and the atmospheric deposition of heavy metals to vegetation. In addition, the ICP Vegetation is taking into consideration impacts of nitrogen on vegetation, consequences for biodiversity and the modifying influence of climate change on the impacts of air pollutants.

At the 22nd Task Force Meeting we will report on the achievements of the ICP Vegetation in 2008, in particular regarding progress made with items to be reported to the WGE in 2009:

- Risk of damage to (semi-)natural vegetation communities in Europe;
- Flux-based assessment of risk of damage to managed pastures in Europe;
- Ozone exposure and impacts on vegetation in the Nordic Countries and the Baltic States;
- Temporal trends in heavy metal concentrations in mosses between 1990 and 2005 [2];
- Factors influencing the spatial variation in heavy metal and nitrogen concentrations in mosses.

Based on evidence provided by the ICP Vegetation on the widespread ozone damage to vegetation [3], the Executive Body of the LRTAP Convention decided at its 26th session in December 2008 that ozone effects on vegetation be incorporated in integrated assessment modelling, especially in work for the revision of the Gothenburg Protocol, and recommended that flux-based methods be used (ECE/EB.AIR.96). The Executive Body also noted that implementation of existing legislation would not attain the ambition levels set out in article 2 of the Gothenburg Protocol; in particular, it would not provide a significant reduction in effects of ozone on health and vegetation, and the policies aiming only at health effects would not protect vegetation in large areas of Europe.

Apart from looking back to our achievements in 2008, throughout the Task Force Meeting we will be discussing our future plans, in particular the medium-term work plan of the ICP Vegetation (2010 – 2011) and reporting of work plan items common to all ICPs/Task Force on Health to the WGE.

- [1] Mills, G., Harmens, H., Hayes, F., Jones, M.L.M., Norris D.A., Hall, J., Cooper, D.M. and the participants of ICP Vegetation. (2008). *Air pollution and vegetation*. ICP Vegetation Annual Report 2007/2008. ICP Vegetation Programme Coordination Centre, CEH Bangor, UK. ISBN: 978 1 85531 240 1.
- [2] Harmens, H., Norris, D. and the participants of the moss survey (2008). *Spatial and temporal trends in heavy metal accumulation in mosses in Europe (1990-2005)*. Programme Coordination Centre for the ICP Vegetation, Centre for Ecology and Hydrology, Bangor, UK. ISBN 978-1-85531-239-5.
- [3] Hayes, F., Mills, G., Harmens, H., Norris, D. (2007). *Evidence of widespread ozone damage to vegetation in Europe (1990 – 2006)*. Programme Coordination Centre for the ICP Vegetation, Centre for Ecology and Hydrology, Bangor, UK. ISBN 978-0-9557672-1-0.

SPATIAL AND TEMPORAL TRENDS IN HEAVY METAL ACCUMULATION IN MOSSES IN EUROPE (1990-2005)

Harmens, H.¹, Norris, D.¹ and the participants of the moss survey

¹ ICP Vegetation Programme Coordination Centre,
Centre for Ecology and Hydrology, Bangor, UK. hh@ceh.ac.uk

The first European moss survey was conducted in 1990/1 and has since then been repeated at five-yearly intervals. The most recent survey was conducted in 2005/6, with mosses collected from over 6,000 sites in 28 countries. Samples were collected according to a standardised protocol and concentrations for 10 – 12 heavy metals were determined in the last three years' growth segments. In 2005/6, *Pleurozium schreberi* was the most frequently sampled species (40.9%), followed by *Hylocomium splendens* (22.7%), *Hypnum cupressiforme* (18.0%), *Scleropodium purum* (11.6%) and other species (6.9%). European maps were produced using ArcMAP, part of ArcGIS, and were based on the EMEP 50 x 50 km² grid, displaying the mean heavy metal concentration for each cell [1].

In 2005/6, the lowest concentrations of heavy metals in mosses were generally found in (north) Scandinavia, the Baltic States and northern parts of the United Kingdom, although higher concentrations were reported near local sources. Relatively low concentrations of iron, mercury, nickel and vanadium were also observed in central Europe. Depending on metal, the highest concentrations were often found in Belgium and eastern European countries, with localised lower concentrations being present. Antimony concentrations were generally high in densely populated areas and in eastern European countries with high metal pollution levels.

The decline in emission and subsequent deposition of heavy metals across Europe has resulted in a decrease in the heavy metal concentration in mosses since 1990 for the majority of metals. Between 1990 and 2005, the concentration in mosses has declined the most for lead (72.3%, based on 16 countries), arsenic (71.8%, five countries), vanadium (60.4%, 11 countries), cadmium (52.2%, 16 countries) and iron (45.2%, 13 countries). An intermediate decrease was found for zinc (29.3%, 16 countries), copper (20.4%, 16 countries) and nickel (20.0%, 16 countries) and no significant reduction for chromium (2%, 14 countries). Since 1995, the arsenic concentration in mosses has declined by 21.3% (14 countries), whereas mercury showed no significant decline (11.6%, eight countries). Temporal trends in heavy metal concentrations in mosses are in agreement with trends in EMEP emission data (or modelled deposition data if available) for arsenic, cadmium, copper, lead, mercury, nickel (although the decline of nickel in mosses is lower than for emissions) and zinc, but not for chromium (as emissions declined). On a national or regional scale large deviations from the general European trend were found, i.e. temporal trends were country or region-specific, with no changes or even increases being observed since 1990. Therefore, even in times of generally decreasing metal deposition across Europe, temporal trends are different for different geographical scales.

[1] Harmens, H., Norris, D. and the participants of the moss survey (2008). *Spatial and temporal trends in heavy metal accumulation in mosses in Europe (1990-2005)*. Programme Coordination Centre for the ICP Vegetation, Centre for Ecology and Hydrology, Bangor, UK. ISBN 978-1-85531-239-5.

SPATIAL TRENDS IN NITROGEN CONCENTRATIONS IN MOSSES ACROSS EUROPE IN 2005/2006

Harmens, H.,¹ Norris, D.A.,¹ Cooper, D.M.,¹ Hall, J.¹
and the participants of the moss survey.

¹ ICP Vegetation Programme Coordination Centre,
Centre for Ecology and Hydrology, Bangor, UK. hh@ceh.ac.uk

Since 1990/1, the European moss survey has been repeated at five-yearly intervals and the most recent survey was conducted in 2005/6. For the first time 16 countries determined the nitrogen concentration in mosses (at almost 3,000 sites), as a pilot study in selected Scandinavian countries had shown that there was a good linear relationship between the total nitrogen concentration in mosses and atmospheric nitrogen deposition rates. Samples were collected according to a standardised protocol and the total nitrogen concentrations were determined in the last three years' growth segments using either elemental analysis (dry ashing) or the Kjeldahl method (wet ashing). *Pleurozium schreberi* was the most frequently sampled species (41.3%), followed by *Hylocomium splendens* (19.0%), *Hypnum cupressiforme* (18.1%), *Scleropodium purum* (15.5%) and other species (6.1%). European maps were produced using ArcMAP, part of ArcGIS, and were based on the EMEP 50 x 50 km² grid, displaying the mean nitrogen concentration for each cell [1].

The lowest total nitrogen concentrations in mosses were observed in northern Finland and northern parts of the UK, the highest concentrations were found in central and eastern Europe. The spatial distribution of the nitrogen concentration in mosses was similar to that of the total nitrogen deposition modelled by EMEP for 2004, except that the nitrogen deposition tended to be relatively lower in eastern Europe. However, the relationship between total nitrogen concentration in mosses and modelled total nitrogen deposition, based on averaging all sampling site values within any one EMEP grid square, shows considerable scatter. Actual nitrogen deposition values vary considerably within each EMEP grid cell due to for example topography, vegetation, local pollution sources and climate. The apparent asymptotic relationship shows saturation of the total nitrogen in mosses above a nitrogen deposition rate of ca. 10 kg ha⁻¹ y⁻¹. However, when the total nitrogen concentration in mosses was plotted against site-specific nitrogen deposition values in for example Switzerland, a strong positive linear relationship was observed.

Conclusion. The total nitrogen concentration in mosses can potentially be used as a surrogate to estimate total nitrogen deposition and identify areas with high nitrogen deposition at a high resolution. Due to the high local variation in nitrogen deposition, the relationship between nitrogen deposition and the nitrogen concentration in mosses will be most robust when deposition rates are measured at the moss sampling sites. The relationship is expected to be species-specific and might dependent on other factors such as nitrogen speciation, the contribution of wet and dry deposition to the total nitrogen deposition, the concentration of nitrogen in precipitation and local climate. These relationships and influencing factors require further investigation in order to improve the application of mosses as biomonitors of atmospheric nitrogen deposition at the European scale.

[1] Harmens, H., Norris, D.A., Cooper, D.M., Hall, J. and the participants of the moss survey (2008). *Spatial trends in nitrogen concentrations in mosses across Europe in 2005/2006*. Programme Coordination Centre for the ICP Vegetation, CEH Bangor, UK.

A FLUX-EFFECT RELATIONSHIP FOR ABOVE- AND BELOW-GROUND IMPACTS OF OZONE ON TWO SEMI-NATURAL GRASSLAND SPECIES.

¹Hayes, F., ¹Wagg, S., ¹Mills G., ¹Davies, W.²

¹Centre for Ecology and Hydrology, Environment Centre Wales, Deiniol Road, Bangor, Gwynedd, UK. LL57 2UW.

²Lancaster University, The Lancaster Environment Centre, Bailrigg Road, Lancaster, UK. LA1 4YW

Ranunculus acris and *Dactylis glomerata*, which are both components of upland grasslands, were established in two-species communities in 14 litre pots filled with topsoil. Communities were either well-watered or reduced-watered. Communities were exposed to eight ozone treatments in solardomes for 20 weeks, using an upland rural profile based on current background ozone concentrations in Snowdonia, North Wales, U.K. In addition to the current background treatment, with a 24h mean ozone concentration of 34 ppb, there were six treatments with incremental additions to this profile, up to a maximum 24h mean ozone concentration of 90 ppb, and one treatment with a reduction in ozone concentration, with a 24h mean ozone concentration of 16 ppb. Stomatal conductance measurements were made on both species using a porometer (AP4, Delta-T) over a range of environmental conditions.

A stomatal conductance model was developed for each species using a Jarvis-type multiplicative approach. A strong relationship between stomatal conductance and soil water content was shown for each species, with *Ranunculus acris* maintaining stomatal conductance rates at lower soil water content than *Dactylis glomerata*. For *Dactylis glomerata* there was an increase in senescence with increasing ozone concentration, and the flux model indicated that differences in the extent of senescence between the reduced -watered and well-watered plants were related to differences in ozone flux ($r^2=0.66$). There was not a clear relationship between either ozone concentration or ozone flux and senescence (or visible injury) for *Ranunculus acris*.

The total biomass of *Dactylis glomerata* decreased with increasing ozone concentration, with the total biomass lower in the reduced-watered plants compared to those which were well-watered. The flux model indicated that differences in biomass between the reduced- and well-watered plants for a given ozone treatment were related to differences in ozone flux, with a linear relationship between ozone flux and total biomass ($r^2=0.90$). There was not a clear relationship between either ozone concentration or ozone flux and biomass for *Ranunculus acris* as this species was less sensitive to ozone. In both *Dactylis glomerata* and *Ranunculus acris*, reduced-watered plants had a greater root biomass compared to well-watered plants. Whilst root biomass increased with increasing ozone concentration for the less sensitive *Ranunculus acris* ($r^2 = 0.7$), there was a large decrease in root biomass with increasing ozone flux for *Dactylis glomerata* ($r^2=0.88$). Again, the flux model indicated that differences in biomass between the reduced- and well-watered plants were related to differences in ozone flux. Regardless of direction of effect, the roots were more sensitive to ozone than the shoots for both species.

These results highlight the importance of soil moisture as a modifying factor in the determination of flux-effect relationships. *Dactylis glomerata* shows negative effects on both senescence and biomass (especially roots) with small increases in background ozone concentration and may even be affected by current UK ozone concentrations. In contrast, the less sensitive *Ranunculus acris* did not show a clear relationship between senescence or total biomass with either ozone concentration or ozone flux.

INTERACTION BETWEEN SO₂ FUMIGATION AND DROUGHT STRESS ON GROWTH, PHOTOSYNTHESIS AND SYMBIOTIC NITROGEN FIXATION IN SOYBEAN USING AN OPEN-TOP CHAMBER FACILITY

Heyneke, E., Van Heerden, P.D.R., Strasser, R.J. and Krüger, G.H.J

*North-West University, Potchefstroom, South Africa, 2520
elmien.heyneke@nwu.ac.za*

Air pollution emissions in South Africa are expected to increase in the short to medium term due to increased industrial activities and expected growth in socio-economic development. Although sulphur dioxide emissions from industry are no longer a major issue in Europe and North America as a result of the imposition of strict regulatory legislation, there is growing evidence of the effects of sulphur dioxide (SO₂) pollution in developing countries, including South Africa. South Africa has an extreme energy-intensive economy, resulting in substantial air pollution through its coal-fired power stations. The “Highveld” region forms the heartland of South Africa’s fast-growing economy and is also considered as the breadbasket of South Africa. Modelled SO₂ concentrations on the central highveld mostly range between 10 and 50 ppb, exceeding 50 ppb in source areas (Zunckel, *et al*, 2000). The study of the physiological and biochemical basis of SO₂ impacts on crop plants and the determination of critical levels under South African conditions is of paramount importance. Without this information, the quantification of impacts and the rational management of air pollution will remain bogged down by speculation and uninformed perceptions.

For the investigation of SO₂ impacts on crop plants, a battery of open top chambers was successfully commissioned and optimised for exposing plants to elevated levels of SO₂ (0, 50, 150 and 300 ppb SO₂). During the summer period of 2007, the effect of SO₂ on actively growing soybean (*Glycine max*) that were well watered or subjected to drought stress, was investigated to study the physiology of injury by measuring growth, photosynthesis and symbiotic nitrogen fixation in parallel. Our data with respect to growth, photosynthetic gas exchange, *chlorophyll a* fluorescence and *in vitro* measurement of Rubisco activity indicated a strong concentration dependent SO₂-induced inhibition. After only 7 days fumigation at a low SO₂ concentration (i.e. 50 ppb), photosynthesis was reduced without any accompanying visual injury symptoms. SO₂ exposure also resulted in large decreases in biomass accumulation of both well watered and drought stressed *Glycine max* plants. The reduction in biomass of the drought stressed plants were however the greatest. Yield reduction of up to 57 % occurred in plants exposed to the highest SO₂ concentration and simultaneously subjected to drought stress. Root nodule ureide content, which serves as a direct measure of the affectivity of the symbiotic nitrogen metabolism was inhibited at all treatment levels. This decrease in ureide content was greater in the SO₂ treated plants subjected to drought stress. Photosynthetic gas exchange parameters decreased severely with increasing SO₂ concentration, specifying the physiological and biochemical basis of inhibition. The *chlorophyll a* fluorescence data, pointing at impaired formation of end electron acceptors (ATP and NADPH), supported the gas exchange data. Our data not only highlights the inhibitory effect of SO₂ and the aggravating role of drought, but also provides insight into the physiological and biochemical basis of SO₂ constraints.

EUROPE-WIDE ANALYSIS OF FACTORS INFLUENCING THE SPATIAL VARIATION OF CADMIUM, LEAD AND MERCURY CONCENTRATIONS IN MOSSES

Holy, M.*, Pesch, R.*, Schröder, W.*, Harmens, H., Alber, R., Aleksiyenak, Y., Blum, O., Coskun, M., Dam, M., De Temmerman, L., Frolova, M., Frontasyeva, M., Grodzińska, K., Jeran, Z., Kubin, E., Kvietskus, K., Leblond, S., Liiv, S., Magnússon, S., Maňková, B., Miodrag, K., Rühling, Å., Santamaria, J., Steinnes, E., Suchara, I., Szymon, K., Thöni, L., Urumov, V., Yurukova, L., Zechmeister, H.

**Chair of Landscape Ecology University of Vechta
PO Box 1553D-49364 Vechta. mholy@iuw.uni-vechta.de*

Background and Goal. To assess factors influencing the concentrations of cadmium (Cd), mercury, (Hg) and lead (Pb) in mosses, pan-European data from the 2005 Moss Survey were analysed by means of correlation analysis, Classification and Regression Trees (CART) and Chi-square Automatic Interaction Detector (CHAID).

Methods. The data used for the statistical analyses encompassed element concentrations in mosses from 5456 (Cd), 3143 (Hg) and 5381 (Pb) sampling sites in 27 European countries (AT, BE, BG, BY, CH, CZ, DE, DK, EE, ES, FI, FR, IS, IT, LT, LV, MK, NO, PL, RS, RU, SE, SI, SK, TR, UA, UK). The moss data also included information on the altitude of the sampling sites, the sampled moss species and chemical analytical procedures. In addition, surface data on precipitation, sea distance, population density as well as an ecological land classification were intersected with the sampling sites and included in the analyses as predictor variables. Finally, the atmospheric emissions were included in terms of land use densities calculated from Corine Landcover, EMEP heavy metal emission data and distances to emission sources from the European Pollutant Emission Register (EPER).

Results. The results of the correlation analysis show highly significant correlations of the Cd concentrations in mosses with the distance to the sea, population density, urban land uses around the samplings sites as well as EMEP emission data. For Hg only a low correlation with precipitation and the distance to the sea could be detected. The Pb concentrations in mosses show highly significant correlations with the distance to the sea, population density, agricultural and urban land uses and the EMEP emission data. The decision tree analysis further revealed country-specific differences of the element concentrations for all three elements. After removal of the country from the set of predictors the sampled moss species were most frequently used as splitting variables followed by the EMEP and EPER data, the sea distance, urban land uses, ecological land classes and the altitude.

Conclusions. For the first time all European moss data were analysed statistically together with available geoinformation on atmospheric emissions, land use and natural land characteristics. The results reveal that the moss concentrations mirror the influence of anthropogenic emissions since emission related factors show the strongest correlations with the element concentrations in the mosses. The country specific differences of the element concentrations may distort cross-border patterns of the metal loads in the mosses.

MODELLED EMEP HEAVY METAL DEPOSITION VS. MOSS MEASUREMENTS: EVALUATION OF SPATIAL PATTERNS AND LONG-TERM TEMPORAL TRENDS

Ilyin, I.

Meteorological Synthesizing Centre East of EMEP, Krasina pereulok, 16/1, 123056 Moscow, Russia, ilia.ilyin@msceast.org

Atmospheric deposition fluxes of lead, cadmium and mercury simulated by EMEP atmospheric transport model MSCE-HM were compared with concentrations of these metals in mosses, obtained by moss surveys of 1990, 1995, 2000 and 2005. The study was focused on the analysis of spatial variability of the deposition fluxes and concentrations in mosses and their long-term temporal trends for Europe and a whole and for individual European countries.

For Europe as a whole the spatial pattern of modeled deposition fluxes and concentration in mosses are similar: In most cases regions with higher deposition overlap regions with higher moss concentrations and vice versa (Fig. 1). Similar situation were obtained when analyzing spatial patterns within individual countries (Fig. 2).

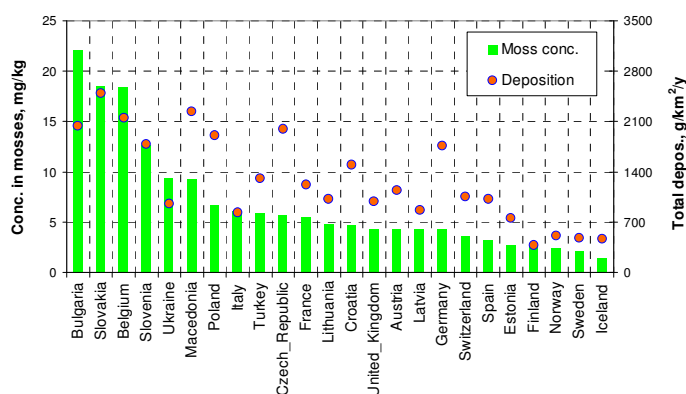

Fig. 1. Spatially mean concentrations of Pb in mosses (2005 survey) and EMEP calculated total deposition (averaged for 2003-2005 period) in European countries

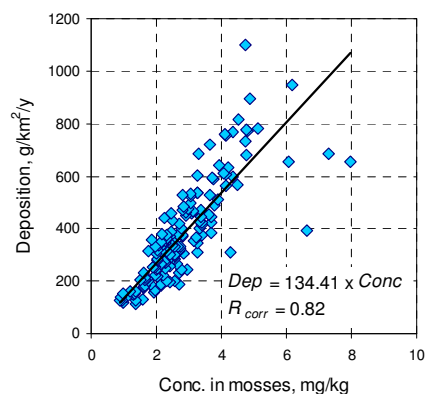

Fig. 2 Deposition vs. gridcell-averaged moss concentrations for Finland (Pb, 2005)

In most countries long-term temporal variability of calculated deposition for 1990 – 2005 period is similar to that of concentrations in mosses (Fig. 3). On average, depositions of lead declined about 3.3, and moss concentrations – 3.6 times, and of cadmium 1.7 and 1.9 times, respectively. For mercury the reduction of depositions (1.4 times) and concentrations in mosses (1.2) was evaluated for the period 1995-2005 and over few countries.

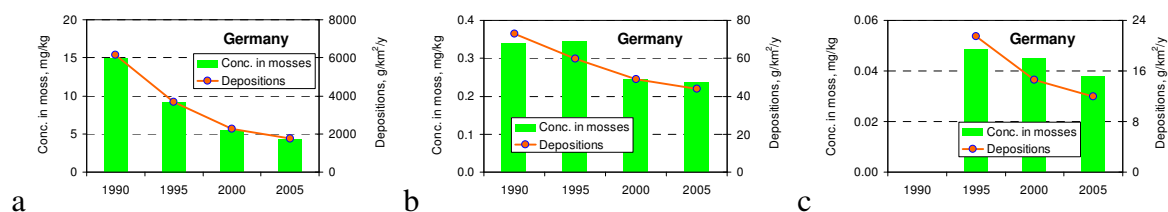

Fig. 3. Long-term trends of modeled depositions and measured concentrations in mosses of Pb (a), Cd (b) and Hg (c) in Germany

OZONE EXPOSURE AND IMPACTS ON VEGETATION IN THE NORDIC COUNTRIES AND THE BALTIC STATES

Karlsson P. E., *et al.*

Swedish Environmental Research Institute, Box 5302, SE-400 14 Gothenburg, Sweden, E-mail: pererik.karlsson@ivl.se

A network of ozone research scientists has been formed, aiming at reviewing scientific evidence for negative impacts of ozone on vegetation in northern Europe at current, and future, ambient or near-ambient ozone concentrations. In particular the importance of the current and future climate conditions with increasing temperature, prolonged growing season, possibly high humidity in combination with the long summer days at high latitudes will be highlighted. Near-ambient ozone concentrations were in this regard defined as below twice current ambient concentrations and below 20 000 ppb hours AOT40 April-September.

The focus of the network is policy-oriented and should eventually provide policymakers with scientific background material in order to promote the introduction of new, ozone-flux based concepts for the air pollution legislation within the LRTAP convention and the EU, in order to protect European vegetation against negative impacts of ozone.

A workshop was organized in Gothenburg in June 2008 and the workshop report has been submitted to ICP Vegetation and the LRTAP convention secretariat. A joint publication of articles on the topic is planned for a special issue of the scientific journal *AMBIO* during 2009.

ATMOSPHERIC DEPOSITION VERSUS ELEMENT CONCENTRATION IN MOSSES: CASE OF NITROGEN AND OTHER ELEMENTS

Leblond S.¹, Croise L.²Ulrich E.², Rausch de Traubenberg C.¹

¹ *Muséum National d'Histoire Naturelle, Paris, France, sleblond@mnhn.fr*

² *Office National des Forêts, Département Recherche et Développement, Fontainebleau,
France*

The use of terrestrial mosses as biomonitors of atmospheric contamination has been widely applied in recent decades. However, several studies have shown that element concentrations in mosses can be influenced by factors such as moss species, canopy drip, precipitation, altitude, etc. That's why, the relationships between concentration in mosses and deposition rates must be monitored as often as possible in various environment.

The monitoring manual of the European survey recommends the "sampling of mosses near long term monitoring stations of atmospheric heavy metal deposition". Like the previous campaigns in 1996 and 2000, during the French moss survey 2006, a specific attention was paid to collect moss samples closed to pre-existent atmospheric networks.

Twenty three sites, of the 2006 French moss survey, are common with the CATAENAT sub-network (Charge Acide Totale d'origine Atmosphérique dans les Ecosystèmes Naturels Terrestres) which is managed by the National Forest Office (ONF). This sub-network takes part in the monitoring of long term effects of atmospheric deposition on forest ecosystems (ICP Forests of UNECE-LRTAP).

Total deposition rate, of major elements, under or outside canopy are monitored, in the 23 sites, by throughfall samplers and bulk samplers located in open field inside forested areas. The correlation between values of Ca, N and Na concentrations in mosses and the annual atmospheric deposition rate (under and outside canopy), precipitation and foliar element concentrations are analysed.

The preliminary results of the Spearman correlation test show that a significant relationships between Ca, Na concentrations in mosses and the annual atmospheric deposition rate (under and outside canopy) can be observed. Whereas for nitrogen only the relationships with throughfall deposition is significant. For this element, forest canopy plays an important part on N concentrations in mosses.

RESULTS OF THE BEAN OZONE BIOMONITORING EXPERIMENT 2008

Mills, G., Hayes, F., Menichino, N.

*ICP Vegetation Programme Coordination Centre,
Centre for Ecology and Hydrology, Bangor, UK. gmi@ceh.ac.uk*

In 2008 ICP Vegetation participants conducted a pilot study to investigate the potential for *Phaseolus vulgaris* to be used as biomonitors in Europe. Bean seeds of the strains S156 (ozone sensitive) and R123 (ozone resistant) were received from Kent Burkey (North Carolina, USA), where they have been selected and developed as potential biomonitors of ambient ozone. Beans were grown by participants across Europe, assessed and harvested according to guidelines issued from the Coordination centre, which included that the pots should be well-watered and that as a minimum two assessments of visible injury should be carried out. Collected data was sent to the Coordination Centre.

A total of 14 sites from nine countries received bean seeds (seeds could not be received through customs in the Ukraine in time for the study). The beans were exposed to ambient air in 11 sites, and ozone exposure studies were carried out in four sites. Germination rates were high and beans grew well at all sites, although slugs were identified as a problem in northern areas.

At all sites a clear distinction in the extent of visible injury symptoms between the S and R biotypes was apparent, with the visible injury symptoms clear and easy to identify. Visible injury symptoms were observed on the S biotype at low ozone concentrations (12 hour mean < 35 ppb). At high ozone concentrations injury symptoms were also apparent on the R biotype, but to a lesser extent than on the S biotype. Typically there was little injury at flowering, and by harvest many leaves had senesced and abscised from the plant. At ambient ozone sites (where the 12 hour mean ozone concentration range was approximately 30 – 60 ppb) there was not a clear dose-response relationship for visible injury, although ozone exposure studies with limited replication at UK-Bangor over a large concentration range (12 hour mean approximately 15 – 90 ppb) showed a linear response of increasing injury on the S biotype with increasing ozone ($r^2=0.77$).

For bean pod weight, similarly there was no clear dose-response relationship (using the ratio of S pod weight / R pod weight in ambient air (12 hour mean approximately 30 – 60 ppb), however a relationship was observed in the ozone exposure studies at UK-Bangor (12 hour mean approximately 15 – 90 ppb). Generally, the results of the ambient ozone exposure fitted the existing relationship of S/R pod ratio shown in the USA, although there was a lot of scatter in the relationship. However the best ozone parameter for use with the effects data has not yet been identified, and no flux model exists for these plants to date.

Participants indicated that they judged the study to be a success and would be happy to repeat the study in future years. A more closely defined Protocol should be defined and used for further studies to allow more comprehensive comparisons between datasets.

BIOMONITORING OF NITROGEN POLLUTION WITH BRYOPHYTES – POSSIBILITIES AND LIMITATIONS

Mohr, K.

Chamber of Agriculture, Lower Saxony, D-26121 Oldenburg, Germany
Karsten.Mohr@lwk-niedersachsen.de

Increasing levels of pollution by inorganic nitrogen (NO_x , NH_y) leads to detrimental ecological effects such as reduced biodiversity, soil acidification, nitrate leaching and reduced tree vitality. Thus the quality and function of natural and semi-natural ecosystems are endangered in regions with high atmospheric nitrogen pollution. But also in many remote rural areas of Germany and other European countries with a low density of nitrogen sources (particularly road traffic and agriculture), the atmospheric input of atmospheric nitrogen exceeds critical loads. Because the amount of the nitrogen deposition depends also on local properties (exposure, climate, vegetation structure, N accumulation capacity) their determination is very difficult and needs expensive technical measures.

The use of bryophytes and other plants makes it possible to apply biomonitoring techniques to atmospheric nitrogen pollution (Mohr 2007). Bryophyte species are found on many nitrogen sensitive ecosystems such as forests or moorlands. The N concentration in the tissue of mosses reflects the atmospheric nitrogen input in these ecosystems. The spatial pattern of N concentrations in samples of *Pleurozium schreberi* and other bryophytes taken from pine forests in NW Germany corresponds with the ammonia pollution which mainly appears in intensively farmed regions in western parts of this region (Fig 1). Measured rates of the N deposition in adjacent pine forests correlate significantly with the nitrogen concentrations in the moss tissue.

Owing to the different structures of the vegetation canopy, the nitrogen deposition of different ecosystems varies as well. Moss samples taken from open land such as forest clearings or forest edges are affected by higher N inputs below or adjacent to trees and shrubs, depending on regional pollution (Fig. 2). The results suggest possible limitations using moss samples from open areas in Germany if they are not wide enough. Considering the possibilities and limitations, bryophytes are very suitable for the long-term biomonitoring of nitrogen air pollution.

Literature: Mohr K (2007): Biomonitoring von Stickstoffimmissionen – Möglichkeiten und Grenzen von Bioindikationsverfahren. UWSF – Z Umweltchem Ökotox 19(4) 255-264

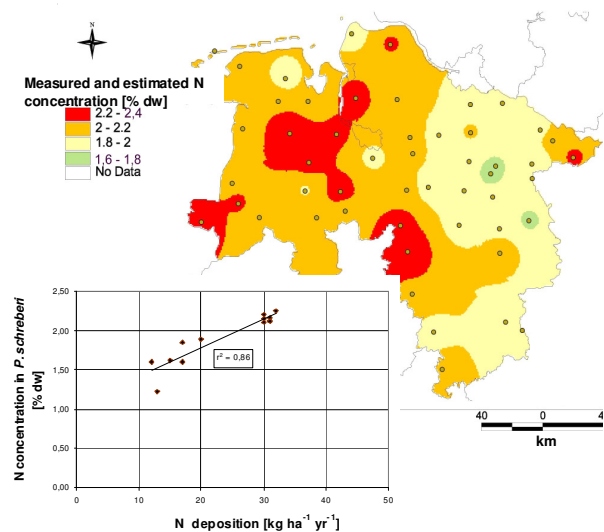

Fig. 1: Spatial pattern of nitrogen in moss tissue and correlation with the N ($\text{NH}_4\text{-N}+\text{NO}_3\text{-N}$) deposition

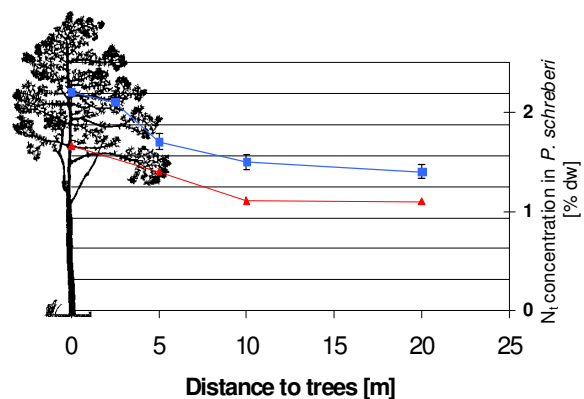

Fig. 2: N concentrations in moss tissue in the vicinity of trees

GROWTH DILUTION/CONCENTRATION EFFECTS OF OZONE AND CARBON DIOXIDE ON THE CONTENT OF STARCH, NITROGEN, ZINC, MANGANESE AND CADMIUM IN WHEAT GRAIN

Pleijel H., Uddling J.

*University of Gothenburg, Plant and Environmental Sciences, P.O. Box 461, 405 30
Göteborg, Sweden, hakan.pleijel@dpes.gu.se*

The scientific literature contains a large number of cases where growth stimulation by elevated CO₂ has been associated with a reduced concentration of nitrogen, while growth reduction by ozone was frequently observed to be adjoined by an increased concentration of nitrogen in wheat grain. Similar effects have been observed for other mineral constituents of the grain such as Zn, Mn and Fe, but in a very limited number of studies. In the present investigation a theoretical framework to study the association between the altered concentrations of grain mineral concentration and yield change caused by elevated/reduced CO₂ and/or elevated/reduced O₃ was applied to data from the literature to compare the yield dilution/concentration effects by these gases over a range of climatic conditions and cultivars of wheat. Unpublished data sets from Sweden were added for Zn, Mn and Cd.

For grain nitrogen 43 data sets, including data from four continents and 18 cultivars revealed a consistent pattern of grain protein changing by on average 70% for a 100% change in grain yield. The effect of CO₂ treatments was somewhat stronger than for O₃. For starch, there was no indication of a growth dilution/concentration effect by O₃ or CO₂, but a very strong correlation between a change in yield and the associated change in grain starch content based on data from eleven experiments. Eight data sets showed a 49% change in grain Zn for a 100% change in grain yield while the corresponding effect for Mn was an 81% change in grain content for a 100% in grain yield. The concentration of Cd had a considerable variation, which was not, however, strongly related to O₃ or CO₂ treatments. However, chamber enclosure tended to lead to promote Cd accumulation in grains.

The study shows that altered atmospheric conditions may have a profound effect on mineral concentrations of wheat grain, with potentially large effects on human nutrition.

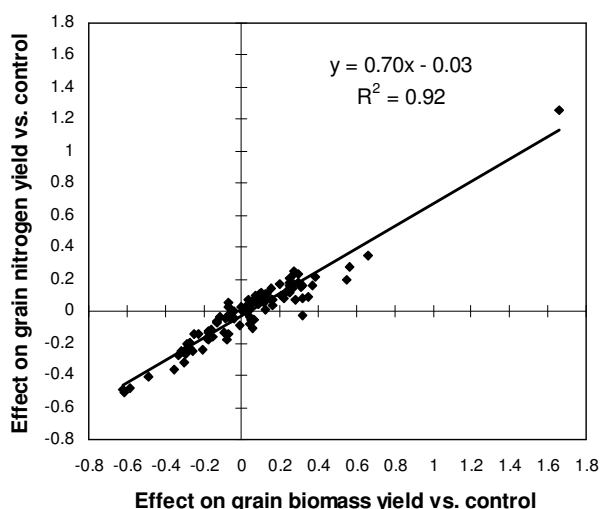

Figure 1. Effect by altered CO₂, O₃ and chamber enclosure on grain nitrogen harvest in relation to the effect on yield biomass harvest. An effect of 1 represents a 100% increase (a doubling) of nitrogen yield/grain yield. The pattern of response was very consistent over elevated and reduced CO₂, elevated and reduced O₃ and positive/negative chamber effects.

HOW DOES RESOURCE AVAILABILITY AFFECT PLANT RESPONSE TO OZONE?

Power, S.A., Khalid, S., Adrees, M., Green, E.R. & Callaghan, N.
Imperial College London, Silwood Park, Ascot, Berkshire SL5 7PY.
S.power@imperial.ac.uk

Despite a global increase in the rate of nitrogen deposition over the past several decades, growth of plants in many natural habitats is still primarily limited by low levels of soil nitrogen availability. However, experiments aimed at assessing the impact of tropospheric ozone on plants and plant communities typically use soils with high levels of nutrients and/or fertiliser additions. Since nutrient availability will affect productivity, metabolism and resource allocation, it is reasonable to expect that differing levels of nutrients, in particular nitrogen, will affect plant and ecosystem level response to ozone. Indeed, the few studies which have looked at this have provided some evidence that the magnitude of ozone effects is influenced by soil nutrient status.

During the past two years, we have carried out greenhouse and open top chamber experiments to test the hypothesis that soil nutrient limitation will exacerbate the effect of ozone on plant physiology and growth. The greenhouse study involved two levels of ozone (filtered air and 90 ppb) and two levels of soil fertility. Single species pots of *Cirsium arvense*, *Centaurea nigra*, *Holcus lanatus* and *Trifolium pratense* were exposed to ozone treatments 8 hours each day over a 40 day period. Results show a significant negative effect of ozone, and a positive effect of N, on biomass for all species except *H. lanatus*. This species had lower above- and below-ground biomass in ozone (compared to filtered air) at high N levels (-12.5%, -50%, respectively), but a higher biomass in O₃ at low N (+72% aboveground, +40% belowground). A similar interaction between ozone and nitrogen treatments was also seen for above-ground biomass in *T. pratense*, with a greater proportional reduction at high N.

A seven week ozone exposure experiment was carried out in a new Open Top Chamber Facility at Silwood Park, during summer 2008. Mixed (and single) species pots of *Plantago lanceolata*, *Trifolium pratense*, *Agrostis capillaries*, *Rumex acetosella*, *Lotus corniculatus* and *Festuca rubra* were established in artificial (low nutrient) soils (25% sand: 25% perlite: 25% vermiculite: 25% local sandy loam), and exposed to four different target concentrations (filtered air, 40, 70 and 100 ppb). Pots were watered weekly with Hoaglands solution (either minus N or with additional N equivalent to 50 kg ha⁻¹ over the growing season). Results of this study will be presented; preliminary analysis suggests that the detrimental effects of ozone may be greater at high nutrient levels. Although evidence from the literature is conflicting, the response to ozone of some plant species is clearly affected by soil nutrient availability. This has important implications for predicting the effects of tropospheric ozone on the natural environment under predicted future increases in global nitrogen deposition.



MONITORING OF METAL PRECIPITATION (2003-2007) BY MOSS *BARBULA CONSTRICTA* FROM MUSSOORIE HILLS IN INDIA.

Saxena, D.K., Srivastava, K.,* Singh, S.*

*Department of Botany,
Bareilly College, Bareilly, U. P. India.
dinesh.botany@gmail.com*

The moss *Barbula constricta*, was used as an active biomonitor for the estimation of atmospheric metal deposition and its seasonal trend to assess the pollution status of the Mussoorie and its adjoining areas. To find out the trend moss transplants were exposed for four months (representing winters, summer and monsoon data) at the distances of 1, 3, 5 and 8 km, during 2003 to 2007. Same were harvested and analyzed in accordance with the sampling protocol (U N E C monitoring manual, 2005-2006). Significantly higher levels of Zn, Pb and Cu ($p \leq 0.05, 0.01$), were measured in the moss harvested at the end of each season. For Zn and Pb the results showed very similar patterns with extremely high values in the immediate surroundings of the high traffic intensity area. Whereas, the moss bags exposed predominantly agricultural region exhibited somewhat different patterns for the copper, pointing to local pollution sources. The values of metals at different distances from the city centre were higher than in background samples treated as control. Results of seasonal and annual metal data were closely identical. However, highest values of metals were during summer followed by winter and lowest in monsoon. Rapid economic development and many fold increase in tourist activity, could be responsible for the same. It was found that the increase recorded in past 5 years, occurred in the sampling sites in the west of the study area could be due to proximity to the crowded habitat areas.

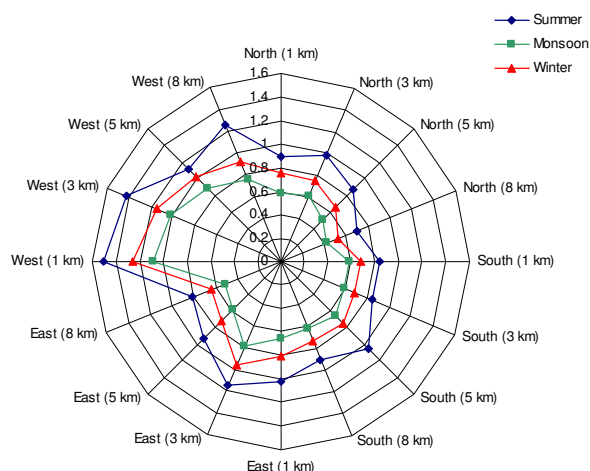

All the analytical results were revealed using statistically DMR test and are presented on contour maps obtained from SURFER program. Results from present moss surveys allow examination of both spatial and temporal trends of metals and also confirm the validity of moss *B. vinealis* as reliable biomonitor and recommend for the bio-mapping program.

Key words: *Barbula constricta*, *bio-monitoring*, *metal load*.

OZONE CONCENTRATION, EXPOSURES AND VISIBLE INJURY ON ICP FORESTS LEVEL II PLOTS FOR 2000 – 2004.

Schaub M.¹, Ferretti M.², Calatayud V.³, Sanz M.-J.³

¹ *Swiss Federal Research Institute WSL, Birmensdorf, Switzerland, marcus.schaub@wsl.ch*

² *TerraData environmetrics, Siena, Italy, ferretti@terradata.it*

³ *Fundación CEAM, Paterna, Spain, vicent@ceam.es*

Ozone (O₃) is the most pervasive and dangerous regional air pollutant for forest vegetation in Europe and elsewhere and its potential impact is likely to increase in the near future. When attempting to estimate the risk to forests due to O₃ in Europe, the status of the needed information can be summarized as follows: i) measurement-based, consistent and harmonized O₃ concentration data, which is a basic requirement for a risk assessment, are infrequent at remote forest sites. ii) A concentration-based approach for risk analysis is ambiguous in itself and site based estimates of stomatal flux for a more biologically sound risk analysis is very much data intensive. iii) Field evidence of O₃ effects on forests is limited and extrapolation of experimental results to *the real world* is problematic. With this background, and despite their limitations, large-scale monitoring programs are highly relevant for both scientists and policy makers as they offer the chance to *link forest health monitoring to O₃ monitoring*.

For the **AOT40 exposure analysis**, considerable exceedances of the critical level were detected at the majority of sites over the period 2000-2004. Exceedances are by far larger in southern plots, namely in Italy and Spain. However, passive sampling across Europe is still not fully harmonized in terms of frequency of sampling, and considerable gaps were obvious in the data coverage.

The analyses of the 2002-2004 data for **ozone-induced symptoms** demonstrate that elevated ambient ozone exposures harm the plant and cause visible symptoms on natural vegetation, every season. Although not significant and based on a few data, a positive trend between symptom development and increasing ozone concentrations could be detected and even more so for the AOT40 exposure values. However, the poor coverage of the data that fulfilled the data requirements does not allow any conclusions for temporal or regional trends.

There is a general agreement that **cumulative ozone uptake**, would lead to a biologically more relevant estimate of ozone risk as compared to external exposure indices such as AOT40, SUM0, and mean ambient ozone concentrations. It has been demonstrated that a risk assessment based on ozone flux to receptor sites within the leaf, rather than ozone exposure, could provide an improved estimate of the relative degree of risk of ozone damage to vegetation on a local as well as European scale. A comparison of estimated flux values with plant effects such as visible ozone injury or reduced growth is very much needed to confirm this hypothesis and further apply this approach.

Species-specific differences in ozone sensitivity, differences in microclimatic conditions and species composition are the main factors making it difficult to relate visible injury with ozone exposures or flux to determine critical levels or fluxes. The use of a **bio-indicator plant species** as a reference across all plots may solve the difficulties caused by species-specific differences in ozone sensitivity and differences in species composition.

Out of Lorenz, M., Fischer, R., Becher, G., Granke, O., Seidling, W., Ferretti, M., Schaub, M., Bacaro, G., Gerosa, G., Rocchini, D., Sanz, M. 2008. Forest Condition in Europe. 2008 Technical Report. Institute for World Forestry, Hamburg, 101 pp.

MOSS BIOMONITORING OF TRACE ELEMENTS IN CROATIA

Spiric Z., Frontasyeva M.V.¹, Stafilov T.², Steinnes E.³, Bukovec D.⁴

Oikon – Institute for Applied Ecology, Zagreb, Croatia, E-mail: zspiric@oikon.hr

¹*Frank Laboratory of Neutron Physics, Joint Institute for Nuclear Research, Dubna, Russia*

²*Sts. Cyril and Methodius University, Faculty of Sciences, 1000 Skopje, Macedonia*

³*Norwegian University of Science and Technology, Trondheim, Norway*

⁴*Croatian Natural History museum, Zagreb, Croatia*

To study atmospheric deposition of trace elements 98 moss samples were collected over the entire territory of Croatia during the summer and autumn of 2006. Results from epithermal activation analysis and atomic absorption spectrometry are reported for 42 elements. Analytical information is converted into GIS maps of elemental distributions over the sampled area.

It was revealed that air pollution in Croatia is predominantly caused by stationary fuel combustion sources: thermal power plants and energy conversion plants in Zagreb, Sisak, and Rijeka, Plomin and Osijek and combustion in small non-industrial furnaces. Pollution also comes from oil refineries in Sisak, Rijeka and Zagreb and oil production at Benicanci, Zutica, Struzec, and Ivanic Grad as well as from a natural gas production and processing plant in the Podravina region. Additional industrial emissions come from the petrochemical and fertilizer production in Kutina, petrochemicals in Zagreb, Omisalj and Sisak; steel mills in Sisak and Split; cement industry in Split, Nasice, Koromacno and glass industry (Lipik). Those locations appear to be particularly exposed to metal pollution.

STRONG AND WEAK POINTS OF THE MOSS BIOMONITORING TECHNIQUE
FOR METAL DEPOSITION STUDIES
AS ILLUSTRATED FROM 30 YEARS OF EXPERIENCE IN NORWAY

Steinnes, E.¹, Berg, T.^{1,2}

¹*Department of Chemistry, Norwegian University of Science and Technology,
NO-7491 Trondheim, Norway*

²*Norwegian Institute for Air Research, NO-2027 Kjeller, Norway*

Since 1977 five nationwide multi-element surveys of atmospheric metal deposition have been carried out in Norway using the moss *Hylocomium splendens*. In addition considerable efforts have been spent on inter-calibration of different moss species and transformation of concentrations in moss to absolute deposition ratios. Moreover the influence of precipitation chemistry on uptake efficiency and kinetics of some common key metals has been studied. In this communication some typical results from this work are presented and discussed.

It has become increasingly evident over the years that the elemental composition of the moss depends on a number of sources in addition to atmospheric deposition of pollutants. Results from the above surveys and other investigations have facilitated a critical evaluation of contributions from sources other than atmospheric deposition to the elemental composition of the moss, as well as processes leading to depletion of some elements in the moss. A proper recognition of these sources and processes is essential for the continued use of the moss technique in atmospheric deposition studies.

LANDSCAPE FACTORS SIGNIFICANTLY CONTROLLING ELEMENT CONTENT DISTRIBUTION IN MOSSES IN THE CZECH REPUBLIC

Sucharová J., Suchara I., Holá M.

*Silva Tarouca Research Institute for Landscape and Ornamental Gardening,
Květnové náměstí 391, CZ 252 43 Průhonice, Czech Republic; sucharova@vukoz.cz*

The content of 10–37 elements was determined in moss samples (more than 90% *Pleurozium schreberi* and *Scleropodium purum*) collected at 33, 196, 250 and 282 sampling plots in the Czech Republic in 1991, 1995, 2000 and 2005, respectively. The variability in the respective contents of 13 and 36 elements was evaluated for moss samples repeatedly collected at 152 and 247 identical sampling plots in 1995–2005 and 2000–2005. The selected landscape conditions operating at the sampling plots were examined as factors explaining the variability of the element content in the moss samples. The following conditions operating at the sampling plots and in a 5-km radius were tested: altitude, geomorphology (slope orientation, plains, bulges, plateaux, depressions, indifferent relief), wind (leeward, windward, indifferent), precipitation sums (annual, biennial, triennial), geology (rock types categorized by potential chemical properties into 6 classes), land-use (percentage of urbanised, forested and field areas). The classes of explanatory factors are defined in greater detail in the Czech moss reports, e.g. Sucharová and Suchara (2004). The distribution of the moss species did not correlate significantly with any explanatory variable, except for the Czech moss campaign 1991/1992. However, many explanatory factors (e.g., precipitation, urbanization, forest cover) correlated significantly with altitude.

The statistical analyses showed that the content variability of most elements in the moss samples in the Czech Republic can be substantially explained by the operation of altitude (negative correlations, except for Cs, Mn, Rb), precipitation sums (positive correlations, except for Mn), proportion of forest cover around the sampling plots (negative correlations, except for Rb). There were very similar correlations, but opposite to those for forest cover, for the element contents in moss and for areas of ploughed land. A significant and positive correlation of only about 10 elements, e.g., Ag, Bi, Cd, Fe, Mo, Pb, Zn and urbanization of the surroundings of the sampling plots was proved. The effects of the tested explanatory variables seem to be strong and relatively stable in the Czech landscape. Surprisingly, only exceptionally and rather accidentally significant correlations were found for the element content in mosses and the tested geomorphologic and wind classes. The element contents in mosses usually did not correlate significantly with the rock types. This finding may be important for the methodology of moss biomonitoring campaigns. However, due to increased atmospheric deposition of eroded soil and rock particles, the element content of most of the elements in moss increased in dry periods, and the number of significant correlations, mainly for the class of basic and ultrabasic rock types rose (11 in 1995 and 4 in 2000). In the case of granites rich in Cs and Rb, the content of these elements in moss can be significantly increased due to deposition of eroded humus debris enriched in Cs and Rb through cycling of elements and bioturbation of the forest floor in the forest ecosystem.

Reference:

Sucharová J., Suchara I. (2004): Bio-monitoring the atmospheric deposition of elements and their compounds using moss analysis in the Czech Republic. Results of the international bio-monitoring programme UNECE ICP-Vegetation 2000. Part I.- Acta Pruhoniana 77: 1-135.

RESPONSE OF MOSSES TO ATMOSPHERIC DEPOSITION OF EIGHT METALS IN BULGARIA AND SWITZERLAND - SURVEYS 1990-2005

Thöni, L.¹, Yurukova, L.,² Ilyin, I.³ Matthaei, D.¹

¹*FUB – Research Group for Environmental Monitoring, Alte Jonastrasse 83, CH-8640 Rapperswil, Switzerland, lotti.thoeni@fub-ag.ch*

²*Institute of Botany, Bulgarian Academy of Sciences, Acad. G. Bonchev Str., Bl. 23, BG-1113, Sofia, Bulgaria*

³*Meteorological Synthesizing Centre East of EMEP, Krasina pereulok 16/1, RU-123056 Moscow, Russia*

The aim of this study was to report on atmospheric deposition patterns and temporal trends from 1990 to 2005 assessed by mosses, comparing the situation in Bulgaria and Switzerland. A strong significant difference was found ($p=0.00000$) in the heavy metal content of mosses in Bulgaria and Switzerland with regard to Cd, Cu, Ni, V, Cr, Fe, Pb for the periods 1995, 2000 and 2005. For Zn, however, none was found in 1995 ($p=0.4$) and only relatively low values for 2000 ($p=0.001$) and 2005 ($p=0.019$). The recorded Bulgarian heavy metal concentrations were considerably higher than the Swiss ones (with exception of Zn). The median values in Bulgaria were nearly always higher, while Swiss medians were almost always below those of all participating European countries.

The biggest abatement step occurred in Switzerland between 1990 and 1995, in Bulgaria, however, between 2000 and 2005.

The greatest differences in heavy metal deposition between Bulgaria and Switzerland are (i) the density of the population (Switzerland 2.4 times higher), (ii) the averaged annual precipitation (over decades) (Bulgaria 600 mm, Switzerland 1500 mm), (iii) the importance of heavy industry in Bulgaria which is practical non-existent in Switzerland, and (iv) the environmental protection policies, which started earlier in Switzerland.

Points (i) and (ii) lead to the expectation of higher concentrations in Switzerland. In fact points (iii) and (iv) seem to have a far higher influence on metal concentrations in the mosses. In addition, high soil pollution in Bulgaria may have accessory effects.

On the whole, the estimated Pb values (taking the moss concentration) in Switzerland correspond to the modelled EMEP values, but not in Bulgaria (Fig. 1). Here, almost all estimated values were clearly higher than the modelled values. One possible reason for this could be uncertainties of reported national emissions in Bulgaria.

No distinct difference between Bulgaria and Switzerland was found for Cd; in both countries the values were roughly twice as high as those predicted by the models. The conclusion is that either the EMEP model underestimates the deposition, or the moss measurements overestimate it.

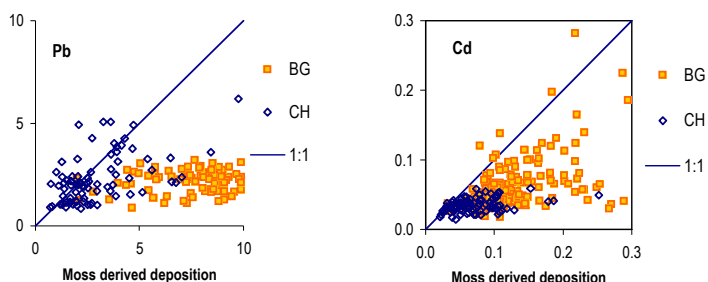

Fig. 1: Comparing the modelled (EMEP) with the moss based estimated deposition (in $\text{kg km}^{-2} \text{ year}^{-1}$) of the periods 1995, 2000 and 2005

IMPACT OF TROPOSPHERIC OZONE ON FOOD AND FEED QUALITY OF BRASSICA SPECIES (OFFQ)

Vandermeiren K.¹, De Bock M.²⁻³, Horemans N.², Op de Beeck M.³

¹ *Veterinary and Agrochemical Research Centre, leuvensesteenweg 17, B-3080 teruren, Belgium, kavan@var.fgov.be*

² *University Antwerp, Research Group of Plant Physiology, Groenenborgerlaan 171, B-2020 Belgium, Maarten.DeBock@ua.ac.be, nele.horemans@sckcen.be*

³ *University Antwerp, Research Group of Plant and Vegetation Ecology, Universiteitsplein 1, B-2160 Wilrijk, Belgium, maarten.opdebeeck@ua.ac.be*

The oxidative burst induced by O₃ and many other abiotic and biotic stress factors, activates signal transduction pathways that influence plant defence responses and the production of secondary metabolites which may have an impact on quality of horticultural and agricultural crops. *Brassica* vegetables such as cabbage, broccoli, Brussels sprouts etc...are important and widely consumed sources of vitamins for humans. Glucosinolates, phytochemicals that are found exclusively in plants of the family *Brassicaceae*, have been attributed anticarcinogenic properties, whereas for animal feed (e.g. in rapeseed meal) they decrease the digestibility and may cause goitre and haemolytic anaemia.

The main objective of this four-year research project is to evaluate the impact of increasing tropospheric O₃ pollution on changes in secondary metabolism influencing the quality of oilseed rape (*Brassica napus* L.) and broccoli (*Brassica oleracea* L. cv *Italica*), mainly in respect to health and safety aspects of the food chain. Therefore both plant species are subjected to short, acute O₃ episodes in environmentally controlled chambers, as well as a long term, moderately elevated O₃ exposure in Open-Top Chambers (OTCs). Physiological assessments of plant performance such as gas exchange and chlorophyll fluorescence measurements are carried out to identify the extent to which O₃ is causing a physiological stress response and to relate these events to biochemical and molecular changes at the leaf level. The biochemical analyses include the antioxidants ascorbate (vit C), α -tocopherol (vit E) and glutathione, total antioxidative capacity and glucosinolates. Gene expression is quantified by micro-array and real-time PCR. Oilseed rape and broccoli quality (protein, fatty acid, vitamin & glucosinolate content) and yield are evaluated at final harvest. The gas exchange measurements both in OTCs and open-field plots, under varying environmental conditions and O₃ concentrations, will be used for ozone flux modelling based on two approaches. The Emberson algorithm simulates stomatal conductance empirically as a direct function of environmental variables; a more mechanistic modelling approach combines mutually dependent sub-models of photosynthesis and stomatal conductance. The final purpose of this exercise is to obtain meaningful O₃ uptake-response relationships.

The presentation will give an overview of the experimental set-up and objectives, as well as the results that have been achieved during the first two years of the project (2007-2008).

Acknowledgements: This research is funded by the Belgian Science Policy within the research programme 'Science for a Sustainable Development' - contract SD/AF/02A.

NITROGEN CONCENTRATIONS AND $\delta^{15}\text{N}$ -RATIOS IN EPIPHYTIC LICHEN
XANTHORIA PARIETINA IN CORRELATION TO NITROGEN DEPOSITION RATES
 AND $\delta^{15}\text{N}$ -RATIOS OF COLONIZED TREE BARK.

Werner, W.H., Boltersdorf, S.H.

University Trier, Department of Geobotany, 54286 Trier, Germany,

werner@uni-trier.de, Stefanie.Boltersdorf@gmx.de

Epiphytic lichens have been proven to be important bioindicators of air pollution. In the present study, we tested whether the nitrogen concentrations of selected epiphytic lichen species can be used to estimate the deposition rates of these compounds in agricultural areas exhibiting a wide range of nitrogen deposition.

In summer 2006, epiphytic lichens (*Evernia prunastri*, *Hypogymnia physodes*, *Parmelia sulcata* and *Xanthoria parietina*) were sampled from, in total, 19 sites located in Western and Southwestern Germany (Münsterland/North Rhine-Westphalia and Rhineland-Palatinate). The samples were collected within a radius of 3 km around field stations for deposition measurement, from trees that met the requirements for bioindication with lichens (VDI directive 3799/1). Along with the lichens, bark samples were taken from the trees.

Xanthoria parietina proved to be different from the other investigated lichens in exhibiting the highest nitrogen concentrations. In areas with high nitrogen deposition rates we observed a shift in species composition to more N-tolerant lichen species, whereas nitrogen or better ammonium sensitive species doesn't exist anymore. Only in *X. parietina*, we found a significantly positive correlation of the nitrogen concentration with the nitrogen deposition rates of the entire study area. The nitrogen concentrations of *X. parietina* were more closely related to the deposition of total nitrogen and of ammonium than to nitrate deposition. In contrast, the nitrogen concentrations of the lichens did not correlate with those of the bark.

There exists significant differences in $\delta^{15}\text{N}$ -ratio in *Xanthoria* which growth under high ammonium deposition rates (especially in Münsterland /North Rhine-Westphalia) compared with *Xanthoria* which growth under nitrate dominated deposition. As expected, the $\delta^{15}\text{N}$ ratio is more negative in *Xanthoria* grown under high ammonia deposition, where the N-Deposition is from agricultural origin especially from animal keeping.

The $\delta^{15}\text{N}$ -ratios of lichens correlate with $\delta^{15}\text{N}$ -ratios of the bark. But nitrogen uptake from bark isn't very probable, because $\delta^{13}\text{C}$ ratios didn't correlate between lichens and bark. The similarity in ^{15}N -isotope pattern between lichen and bark may be better explained with the same atmospheric deposition type of nitrogen isotopes.

The study demonstrates the possibility to estimate the deposition of total nitrogen and of ammonium on the basis of the nitrogen concentration and $\delta^{15}\text{N}$ ratio of the epiphytic lichen *Xanthoria parietina*.

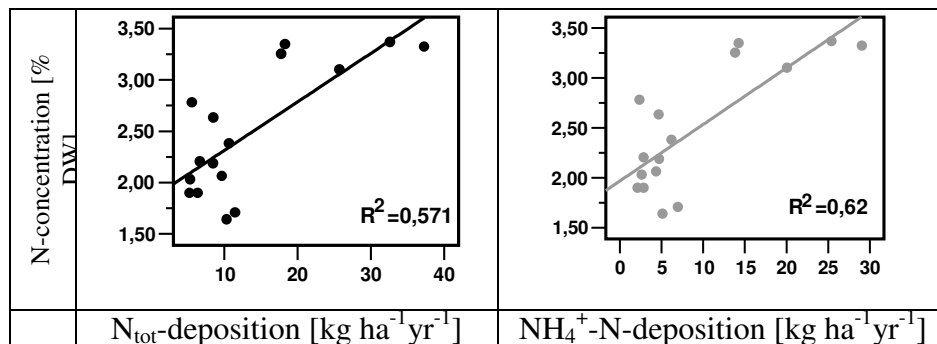

Fig.1:Correlation N-concentration *Xanthoria parietina* and the deposition of N_{tot} (left side) and NH₄⁺-N (right side) (N_{tot}: r=0,756***; n=16; p<0,001/ NH₄⁺-N: r=0,788***; n=16; p<0,001)

OZONE AND NITROGEN CONTROLS ON CARBON ALLOCATION WITHIN TWO SEMI-NATURAL PLANT SPECIES

Wyness, K.,¹ Jones, L.,¹ Mills, G.,¹ Barnes, J.,² Jones, D.³

¹*Centre for Ecology and Hydrology. Environment Centre Wales, Deiniol Road, Bangor Gwynedd, LL57 2UW, United Kingdom. kirnes@ceh.ac.uk*

²*Institute for Research on Environment & Sustainability, School of Biology, Devonshire Building, University of Newcastle, Newcastle-upon-Tyne, NE1 7RU*

³*School of the Environment and Natural Resources, Bangor University, Bangor Gwynedd, LL57 2UW*

Ranunculus acris and *Dactylis glomerata* were separately exposed to a factorial combination of eight ozone concentrations and two nitrogen treatments in solardomes. Individual plants were established in 2 litre pots filled with topsoil inoculated with soil from Keenly Fell, Northumberland (an upland calcareous grassland site containing both species). 24h mean ozone concentrations in the domes were 16, 34, 44, 51, 62, 73, 89 and 90ppb. The ambient ozone treatment of 34ppb was based on background ozone concentration in Snowdonia, North Wales, U.K. Nitrogen treatments of 0kg/ha/yr and 75kg/ha/yr in the form of NH₄NO₃ were applied weekly to each plant in tap water.

Above ground assessments of leaf count and senescence in *R. acris* were made over 12 weeks of treatment, A-C_i curves (net CO₂ assimilation rate, A, versus calculated sub-stomatal CO₂ concentration, C_i) were measured in weeks 8 and 13, and a full destructive harvest was completed in week 14. Increasing ozone treatment significantly increased senesced rosette leaf biomass (p=0.019), and significantly reduced root biomass (p=0.001). The effect of nitrogen treatment was not significant. There was no effect of ozone or nitrogen on the maximum rate of electron transport (J_{max}).

A-C_i curves were measured in week nine of the *D. glomerata* experiment, with a full destructive harvest in week 10. High N treatment significantly increased the biomass of both healthy and senesced above ground material compared to low N plants (p≤0.001 and p≤0.01 respectively), and therefore the total above ground biomass (p≤0.001). A trend for reduced above ground healthy (green) biomass in high ozone and high nitrogen treated plants was apparent, but this interaction was not significant (p=0.074). Ozone reduced the biomass of healthy leaves and increased senesced leaf biomass (p≤0.01 and p≤0.001 respectively), but not the total above ground biomass. There was a significant interaction between nitrogen and ozone effects on root biomass (p=0.017). The high N treated plants had an enhanced negative response to increasing ozone concentration, although overall root biomass remained greater than the low N plants at the highest ozone treatment. There was no significant effect of nitrogen or ozone on J_{max} and no difference between the N treatments in maximum carboxylation efficiency.

Although both species showed increased senescence and reduced root biomass in response to ozone, *R. acris* and *D. glomerata* responded differently to the combined treatment of ozone and nitrogen, highlighting important potential effects on community composition in natural ecosystems. Increased N input has synergistic effects on the *D. glomerata* response to ozone stress and may exacerbate reduction in carbon allocation below ground over time.

TOTAL NITROGEN CONTENT AND $\delta^{15}\text{N}$ SIGNATURES IN MOSS TISSUE:
INDICATIVE VALUE FOR NITROGEN DEPOSITION PATTERNS AND SOURCE
ALLOCATION ON A NATION-WIDE SCALE

Zechmeister, H.G.,^{1,2} Richter A.,³ Smidt, S.,⁴ Hohenwallner, D.,^{2,5} Roder, I.,⁵
Maringer, S.,³ Wanek, W.³

¹Faculty of Life Sciences; University of Vienna; Althanstraße 14, 1090 Vienna, Austria.
Harald.Zechmeister@univie.ac.at,

²ecotox-Austria; Company for Monitoring Environmental Pollution, Fleschgasse 22, 1130
Vienna, Austria.

³Department of Chemical Ecology and Ecosystem Research, Faculty of Life Sciences;
University of Vienna; Althanstraße 14, 1090 Vienna, Austria.

⁴Federal Research and Training Centre for Forests, Natural Hazards and Landscape (BFW),
Senkendorff-Gudent-Weg 8, 1130 Vienna, Austria.

⁵Umweltbundesamt, Spittelauer Lände 5, 1090 Vienna, Austria.

To evaluate a new N-monitoring programme in the framework of the UN-ECE ICP-Vegetation programme using mosses as bioindicators, 490 moss samples were collected at 220 sites in Austria and analysed for total N (N content) and $\delta^{15}\text{N}$ signatures. Within-site variability of N content and $\delta^{15}\text{N}$ signatures was tested for the first time on a large scale and was extremely low compared to between-site variability. Average within-site variance was 0.4‰ for $\delta^{15}\text{N}$ signature compared to 5.9‰ between-site variance of 68 sites. For N content, within- and between-site variance was 0.02% and 1.28%, respectively.

N content in moss tissue ranged between 0.76 % and 1.99 % and $\delta^{15}\text{N}$ signatures between -10.04 and -2.45. Altitude was significantly correlated with N content ($P = 0.021$) and $\delta^{15}\text{N}$ signatures ($P < 0.001$). When comparing moss data to deposition data from 35 measurement sites, significant correlations between N content and N deposition ($P = 0.014$) were found. Correlations were much better in areas with above average precipitations, whereas poor in dry areas. Increasing $\delta^{15}\text{N}$ signatures provided evidence for a change in N source and its respective isotopic composition with altitude (Fig.1), e.g. due to long-distance transport of reactive N or as a result of changes in the wet : dry deposition ratio.

Our study underlines that N deposition can generally be estimated by N content in mosses on a large scale, but that this approach has certain limitations, especially in areas with large differences in altitude and precipitation.

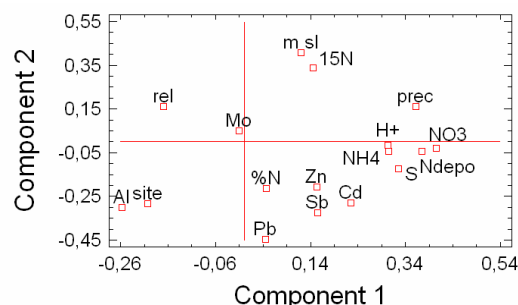

Fig. 1. Principle component analysis of selected data obtained by moss analysis (N content, $\delta^{15}\text{N}$, Al, Cd, Mo, Pb, Zn) and deposition data (N total, S total, NO_3^- , NH_4^+ , $\text{NO}_3^-/\text{NH}_4^+$ relation, H^+ , precipitation, altitude, type of site) for 35 stations; component 1=29.9 %, component 2=21.3%.

Abstracts

Poster Presentations

CONTRASTING OZONE SENSITIVITY OF EVERGREEN AND DECIDUOUS OAKS

Calatayud, V., Cerveró, J., Sanz, M.J.

Fundación C.E.A.M., Charles R. Darwin 14, Parc Tecnològic, 46980 Paterna, Valencia, Spain. Tel.: + 961318227; fax: + 961318190 ; E-mail address: calatayud_viclor@gva.es

In the framework of the project VegetPollOzone (Interreg IIIb, Medocc), the ozone sensitivity of four oak species was tested in Open Top Chambers. Plants of one evergreen (*Quercus ilex*) and three deciduous (*Q. faginea*, with small leaves, *Q. pyrenaica* and *Q. robur*, with large leaves) oaks were exposed both to filtered air and to enhanced but environmentally relevant ozone levels. In both years, *Q. pyrenaica* was by far the most sensitive oak, and the only evergreen species, *Q. ilex* was the most resistant. At the end of the growing season, CO₂ assimilation was significantly reduced and intercellular CO₂ concentrations (C_i) increased in all species except *Q. ilex*. In *Q. pyrenaica*, stomatal conductance (g_s) and Water Use Efficiency (WUE) were also significantly impaired in both years, and a significant decrease in chlorophyll content was observed the first year. Visible injury was consistent with physiological results: *Q. pyrenaica* experienced the highest rates of ozone injury and *Q. ilex* the lowest, with the other species showing intermediate values. The significant increase in above ground/below ground biomass ratio also confirmed *Q. pyrenaica* as the most sensitive species. Under experimental conditions, while the high g_s rates measured in *Q. pyrenaica* may have contributed to its high ozone sensitivity, the highest tolerance of *Q. ilex* is not related to low g_s values. Results of this study support the hypothesis that Mediterranean evergreen broadleaves, species well adapted to withstand severe stress conditions such as summer drought, might concomitantly be also more prepared to withstand ozone stress.

COMPARATIVE OZONE SENSITIVITY OF EIGHT POTATO CULTIVARS

Calvo E., Marco, F., Martín C., Calatayud, V., Sanz, M.J.

Fundación CEAM, C/Charles Darwin 14, Parque Tecnológico, 46980, Paterna, Valencia, SPAIN. espe@ceam.es

Some potato varieties are among the most ozone-sensitive crops in Mediterranean areas, frequently showing visible injury under current ambient ozone levels. Physiological, biomass, and visible injury responses to enhanced ozone levels have been studied in eight potato varieties (*Solanum tuberosum*, varieties Agria, Bartina, Charlotte, Desiree, Escort, Kondor, Lady Rosetta and Provento) in spring 2008. Tubers were cultivated in 11-litter containers inside greenhouses and exposed to two ozone concentrations: charcoal filtered air (control) and ambient enriched with 30 ppb of ozone. At the end of the experiment, fumigated plants of all varieties showed typical ozone symptoms and a decrease in leaf chlorophyll content, while plant senescence increased. In Charlotte, Desiree, Lady Rosetta and Provento varieties, net photosynthesis rate and stomatal conductance significantly declined. Above-ground biomass (in dry weight) and initial tuber production was also reduced in Charlotte and Provento, while Desiree and Lady Rosetta not shown significant response in above ground biomass and initial tuber production. Other cultivars, as Agria and Escort have been reduced aerial biomass production without affecting physiological variables, although only Agria has been reduce tuber production. As a result of this experiment, the following ranking of ozone sensitivity is proposed for the studied varieties: Charlotte, Desiree and Agria are the most sensitive varieties, Bartina, Provento and Lady Rosetta have an intermediate sensitivity, and Escort and Kondor are the most tolerant.

OZONE DOSE-RESPONSE FUNCTIONS FOR ANNUAL MEDITERRANEAN HERBACEOUS SPECIES

Elvira, S., Alonso, R., Sanz, J., Bermejo, V., González-Fernández, I., Gimeno, B.S.

Ecotoxicology of Air Pollution. CIEMAT (Ed. 70), Avda. Complutense 22. 28040 Madrid (Spain): susana.elvira@ciemat.es

Up to date ozone Critical Levels for herbaceous species defined under the Geneva Convention framework are based on the ozone exposure index AOT40. However, current knowledge about the mechanisms of ozone-induced effects indicates that plant ozone damage is more related to plant uptake than ozone ambient levels. Thus, in the last decade protection thresholds for crops and trees are moving towards a more mechanistic approach based on the O₃ absorbed by the plant (ozone dose). This approach requires advanced data sets comprising information about plant gas exchange behaviour of the most representative O₃-sensitive species.

Until now, although some attempts have been developed in order to apply this approach to herbaceous species, the complexity of these communities has prevented the Geneva Convention to propose Critical Levels for herbaceous species based on O₃ dose.

Compiling all the experimental OTC studies carried out in the Iberian Peninsula regarding ozone effects on annual Mediterranean species, the present work attempts to build a dose-response function for these species and to compare it with the exposure-response function already proposed (Gimeno *et al.*, 2004). Parameterization values for the EMEP DO₃SE model were acquired from previous works based on field measurements of *Trifolium* and *Bromus* species during two growing seasons (Alonso *et al.*, 2007; Gonzalez-Fernandez *et al.*, 2009).

REFERENCES:

- Alonso, R., Bermejo, V., Sanz, J., Valls, S., Elvira, S., Gimeno, B.S. 2007. *Environmental Pollution* **143** (3): 692-698.
- Gimeno, B.S., Bermejo, V., Sanz, J., de la Torre, D., Elvira, S. 2004. *Environmental Pollution* **132**: 297-306.
- González-Fernández, I., Bermejo, V., Alonso, R., Elvira, S., Sanz, J., Gimeno, B.S., 2009. Submitted to *Global Change Biology*.

INTERACTIONS BETWEEN N DEPOSITION AND FIRE IN MEDITERRANEAN ECOSYSTEMS. EFFICIENCY OF AIR POLLUTION CONTROL ABATEMENT.

Gimeno, B.S.¹, Yuan, F.,² Fenn, M.E.³, Meixner, T.²

¹ *Ecotoxicology of Air Pollution. CIEMAT. Avda. Complutense 22. 28040 Madrid. Spain
benjamin.gimeno@ciemat.es*

² *Dept. Of Hydrology and Water Resources. University of Arizona, Tucson. AZ85721. USA. ³
USDA Forest service, Pacific Southwest Research Station. 4955 Canyon Crest Drive.
Riverside, CA 92507. USA*

Recurrent fire is an integral component of Mediterranean forests. One of the consequences of forest fires is the atmospheric emissions of air particulated matter and gaseous compounds, which may have an impact on regional air quality and human health. Fire also influences water quality as postfire increases in mineral leaching rates of NH_4^+ and NO_3^- have been observed after fire.

Atmospheric N deposition may enhance the direct and indirect impacts of fire, through changing the chemical composition of different forest components, and increasing stand density or tree volume. These impacts affect the chemical properties of fuel and increase fuel loading in the ecosystem, thus enhancing forest flammability and increasing the risk of fire occurrence with associated impacts on fire severity and intensity.

Mixed conifer-forests of southern California are exposed to N deposition levels that impair C and N cycling, enhance forest flammability, increase the risk of fire occurrence and air pollution emissions in fire, and increase nitrate runoff both pre- and postfire. To test the interactive effects of N deposition and fire on environmental quality, a simulation study was carried out using a parameterization of the DAYCENT model for a mixed-conifer forest site currently experiencing $70 \text{ kg N ha}^{-1} \text{ yr}^{-1}$. Five deposition scenarios were defined ranging from 5 to $70 \text{ kg N ha}^{-1} \text{ yr}^{-1}$. Also five abatement strategies ranging from 0% to 100% reductions in N deposition were considered for each N-deposition scenario.

When the most extreme N-deposition scenario was compared to the lowest, fuel loads were increased by 121%, resulting in 70% increases in wildfire emissions of particulate matter, methane, carbon monoxide, carbon dioxide and sulphur dioxide. The estimated increase in wildfire nitrogen oxides emissions ranged from 56% to 210%. The larger values were derived from variations in fuel N content were taken into account. N deposition had a large effect on N export in stream water, for instance maximum N export reached up to 5 and 73 times higher than background levels after 169 years of N deposition under the 25 (N25) and 70 (N70) $\text{kg N ha}^{-1} \text{ yr}^{-1}$ scenarios, respectively. An acceptable N-export level of $0.5 \text{ kg ha}^{-1} \text{ yr}^{-1}$ was approximated when N deposition was reduced by 75-100% and 100% under the N25 and N70 scenarios, respectively. These were quite unrealistic abatement scenarios, especially in the case of N70 where 100% deposition reductions for more than 80 years would be needed. Therefore, early applications of air pollution control measures in combination with forest fuel management options should be considered.

OZONE RISK ASSESSMENT FOR CROPS IN CRETE, GREECE

Goumenaki E.^{1,2,*}, Barnes J.D.¹

¹*Environmental and Molecular Plant Physiology, Institute for Research on the Environment and Sustainability, School of Biology, Newcastle University, Newcastle Upon Tyne, NE1 7RU, U.K.*

²*School of Agricultural Technology, Technological Education Institute of Crete, P.O. Box 1939, 71004 Heraklion Greece*

**correspondence to: egoumen@steg.teicrete.gr*

An experiment using the NC-S/ NC-R clover biotype system was conducted and the necessary stomatal conductance and physical variables monitored in order to derive flux-response relationships in this study. A database comprising 208 measurements of stomatal conductance recorded on the resistant biotype, and 203 measurements made on the sensitive biotype, were used to parameterise a multiplicative, Jarvis-style ‘big leaf’ model. Incorporation of the influence of two additional factors (i) time of day (g_{time}) and (ii) the influence of ozone (g_{O_3}) on stomatal conductance improved the prediction capability of the models derived for both NC-S and NC-R. Since stomatal conductance responded to environmental variables in a different manner in the two biotypes, independent models were constructed for NC-S and NC-R. Plant biomass was harvested every 28 days. Four harvests were conducted during the course of the experiment: 15th April, 12th May, 12th June and 9th July.

Ozone concentrations experienced at the field site during the experimental period were atypical, in that concentrations were *ca.* 20% lower than recorded at comparable sites/elevations in the region over the past decade. As a consequence, ozone levels did not exceed the current critical exposure for the protection of crops and natural vegetation during the course of this field experiment. Nevertheless, ANOVA revealed a significant ($P < 0.001$) decline in NC-S:NC-R biomass ratio over the course of the season, biomass accumulation reducing 60% more over the course of the experiment for NC-S in comparison with that for NC-R. Although the investigation was limited to a single experiment performed at one Mediterranean site in a particular year, this observation implies that current UNECE critical exposure thresholds could be too high to protect the most sensitive types of vegetation under some conditions

Analysis of the dataset revealed that ozone uptake (AF_{st}) was a better predictor of changes in NC-S:NC-R biomass ratio recorded at the field site in Crete than all exposure-based indices. Ozone indices were calculated using the 28 d growth periods and the running totals over the entire growing season. The strongest relationship between tested flux-based indices and NC-S:NC-R biomass ratio was obtained using the NC-R accumulated flux over the course of the season ($r^2 = 0.94$, $P < 0.05$), though all correlations using accumulated fluxes employing thresholds up to $4 \text{ nmol m}^{-2} \text{ s}^{-1}$ were strong (and statistically significant) for both biotypes over the season. Data analyses using SUMXX indices resulted in marginally lower r^2 values ($0.86 < r^2 < 0.93$; $P < 0.05$) employing thresholds up to 30 ppb. Statistically significant relationships were not revealed for AOTX indices. Similar results were obtained for the AOTXm, with only the AOT20m index (for both biotypes) yielding a significant relationship regressed against NC-S:NC-R biomass ratio ($r^2 = 0.90$; $P < 0.05$). Analysis of effects by harvest period *versus* season revealed evidence of carry-over effects (i.e. cumulative effects) of the pollutant over the course of the season.

ASSESSING TRACE ELEMENTS MAIN INPUTS TO AGRICULTURAL SOILS: CASE STUDY OF THE USE OF FRENCH MOSS SURVEY

Leblond S.¹, Galsomies L.², Deportes I.², Belon E.³

¹ *Muséum National d'Histoire Naturelle, Paris, France, sleblond@mnhn.fr*

² *Agence de l'Environnement et de la Maitrise de l'Energie, Angers - Paris, France*

³ *SOGREAH, Echirolles, France*

In the context of the definition of a European thematic strategy on soil protection, a first assessment of contamination pressure by trace elements (TE) to agricultural France soils has been achieved.

Quantitative assessment of 10 trace elements (As, Cd, Cu, Cr, Hg, Ni, Mo, Pb, Se, Zn) to French agricultural soils are studied. According to the available data, six main sources of contamination are taken into account: pesticides, mineral fertilizers, animal effluents, liming materials, sludge and composts, atmospheric deposition. Due to a lack of atmospheric deposition data in rural area, TE input by air deposition has been assessed using the 1996 and 2000 French moss surveys data.

Data are collected to compute inputs at both national and department scales. The total annually inputs of the ten metals studied to the French agricultural soils are bounded by Mercury (12 tons.year⁻¹) and zinc (15 190 tons.year⁻¹). At a national scale, three TE groups can be made according to the total amount brought to soil: Zn, Cu, Cr > Pb, Ni > As, Mo, Se, Cd, Hg.

The contribution of each of the six TE sources to the average total amount brought to soil varied according to the elements. Atmospheric deposition is not a main source; however, it is always present and could reach 33% of the annual total input for Pb.

MOSESSES AND FOLIAGE OF FOREST TREE SPECIES AS BIOMONITORS OF NITROGEN POLLUTION

Maňkóvská, B., Oszlányi, J.

*Institute of landscape ecology, Slovak Academy of Science,
Štefánikova str. 3, P.O.BOX 254, 814 99 Bratislava, Slovakia
bmankov@stonline.sk*

The foliage N concentrations were determined in 405 permanent monitoring plots (PMP) in four National Parks (NP) and sixteen Landscape Protection Areas (NPA) and were compared with 3062 PMP in Slovakia. The foliage concentration of N ranged from 9.7 to 48.7 g.kg⁻¹ in conifers (*Picea abies* Karst., *Pinus silvestris* L.), and from 7.8 to 51.4 g.kg⁻¹ in broadleaved forests (*Fagus sylvatica* L., *Quercus robur* L.). An low level of N was determined in one LPA and a critical increase in four NPA. S/N ratio ranged from 0.08 to 0.176 in conifers, and from 0.078 to 0.253 in broadleaved tree species. S/N ratio was dislocated on 90% of localities when compared with range limit. Concentrations of N in the foliage of 3 forest tree species (1101 trees) from 24 sites of the Carpathian Mts. Forests -Czech Republic (CZ), Poland (PL), Romania (RO), Slovakia (SK) and Ukraine (U) are complemented with their concentrations related to the limit values. The foliage concentration of N. was (in g.kg⁻¹): for *Fagus sylvatica* L. 26.24±14.47(CZ); 28.2±18.15 (PL); 23.1±2.1 (RO); 23.9±3.6 (SK); 26.6±2.7 (U); 20.8 (threshold values); for *Picea abies* Karst.: 12.8±1.65 (CZ); 12.7±1.7 (PL); 15.2±1.96 (RO); 12.5±1.68 (SK); 16.6±0.8 (U); 13.9 (threshold values); and for *Abies alba* Mill.:12.5±1.4 (PL);12.1±1.2 (SK);13.9 (threshold values).

The results on atmospheric deposition of N in 6 Slovak sites using the moss biomonitoring technique are also presented. Concentrations of N (in g. kg⁻¹) in the 3year old segments of mosses (*Pleurozium schreberi*, *Hylocomium splendens* and *Dicranum* sp.) ranged from 19.6 to 27.3 (2000); from 9-24.9 (2005). In comparison the year 2000 with 2005 we are find out increase concentration N.

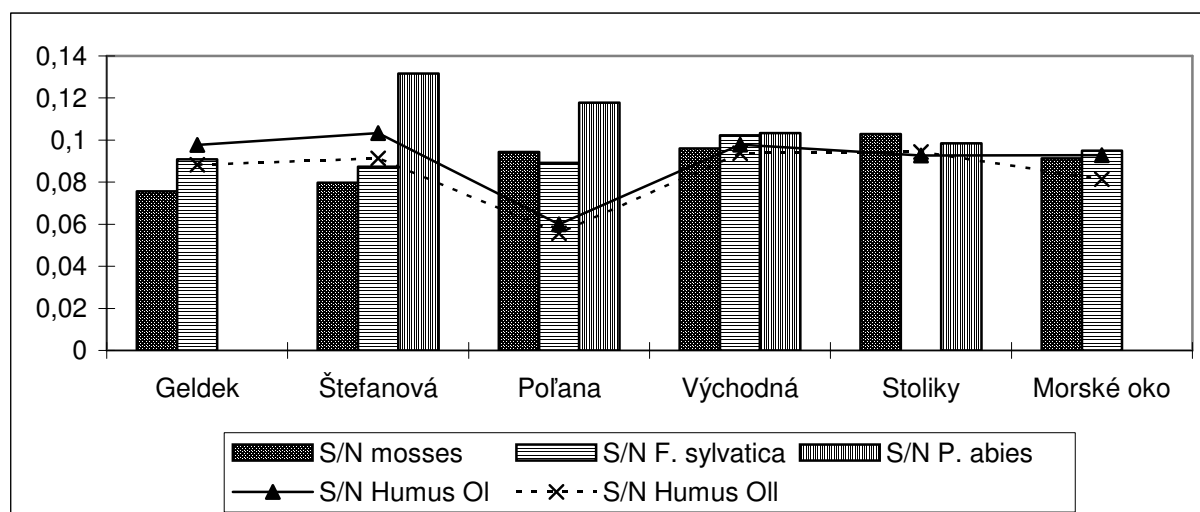

Ratio S/N in the mosses (P. screberi, H.splendens, Dicranum sp.), foliage of F. sylvatica, 1 year old needles P. abies; letter (OII) and raw humus (OI) (median in g.kg⁻¹) from Slovak part of Carpathian Mts.

Key words: Conifers, Broadleaved tree species, Mosses, Foliar analysis; Nitrogen

COMPARISON OF NITROGEN CONCENTRATION OF *HYLOCOMIUM SPLENDENS*
AND *PLEUROZIUM SCHREBERI* IN FINLAND

Poikolainen J., Piispanen J., Karhu J. & Kubin E.

Finnish Forest Research Institute, Muhos Research Unit
Kirkkosaarentie 7, FI-91500 Muhos, Finland
E-mail: jarmo.poikolainen@metla.fi

Nitrogen concentration of *Hylocomium splendens* and *Pleurozium schreberi* was compared on the basis of the samples collected in the survey carried out in 1990. The samples were collected from 313 permanent plots of the National Forest Inventory established in 1985-86.¹ The sample plot network consists of sample plot clusters. Samples of both moss species were collected from same plots of the cluster. The nitrogen concentrations were measured using the modified Micro-Kjeldahl method.² Effects of the habitats were studied by comparing the N concentration of mosses to forest site type, tree species, tree age and basal area of trees.

Nitrogen concentrations of both moss species were highest in Southern Finland, and they decreased on moving northwards. However, nitrogen concentrations of these moss species differed significantly from each other so, that the N concentration was consistently higher in *H. splendens* compared to *P. schreberi* ($p < 0.001$). The regional differences in N concentrations were caused mainly by nitrogen deposition. However, the habitat of mosses, especially forest site type, tree species and basal area of tree stand, had also remarkable effect on the N concentrations (Table 1). The variation of N concentration in mosses in different habitats was caused probably by stand throughfall and by herb vegetation.

Table 1. The nitrogen concentration of *Hylocomium splendens* and *Pleurozium schreberi* in relation to the tree stand of their habitats.

		n	<i>Hylocomium splendens</i> N%	<i>Pleurozium schreberi</i> N%
Forest site type	Grove and grove-like heaths	54	1.26	1.20
	Fresh heaths	172	1.04	0.99
	Dry and dryish heaths	72	0.95	0.85
	Alpine zone, rocks etc.	9	0.88	0.81
Tree species	Pine	146	0.96	0.89
	Spruce	134	1.13	1.09
	Broad-leaved trees	20	1.23	1.09
Tree age	< 40 years	66	0.99	0.90
	40-80 years	106	1.13	1.08
	80-120 years	92	1.06	1.02
	> 120 years	31	0.95	0.85
Basal area of trees	< 10 m ² /ha	68	0.96	0.85
	10-20 m ² /ha	115	1.04	0.99
	20-30 m ² /ha	86	1.14	1.10
	> 30 m ² /ha	24	1.14	1.15
Average concentration		313	1.05	0.99

References:

¹ Poikolainen, J., Kubin, E., Piispanen, J. & Karhu, J. (2004). Atmospheric heavy metal deposition in Finland during 1985-2000 using mosses as bioindicators. *Science of the Total Environment* 318, 171-185.

² Kubin, E. & Siira, J. (1980). On the suitability of the phenyl hypochlorite procedure for the determination of total nitrogen from plant and soil samples. *Aquilo Ser. Botanica* 17, 11-17.

BIOINDICATION INVESTIGATION AROUND AN OIL-REFINERY IN HUNGARY BASED ON MOSS TECHNIQUE (TEMPORAL TRENDS 1991-2008)

Rabnecz, J.,¹ Jócsák, I.^{1,2}

¹*Institute of Botany and Ecophysiology, Faculty of Agriculture and Environmental Sciences,
Szent István University, H-2103 Gödöllő, Páter K. str 1. Hungary,
e-mail: rabnecz.gyula@mkk.szie.hu*, ²*Crop Production Department, Agricultural Research
Institute of the Hungarian Academy of Sciences H-2462 Martonvásár, Brunszvik street 2,
Hungary*

Our first goal was to determine the air pollution level of heavy metals in the vicinity of an oil-refinery in Hungary using the cryptogam transplantation ecophysiological bioindication method (Tuba and Csintalan 1993). Secondly, our results had been compared to previous year's data.

Results of 2007/2008

The investigated periods were in June-July and in August-September of 2007, and in April-May of 2008. After the two months long investigation periods, remarkable pollution was detected at the term of June-July of 2007 by the elements Al, V, Cr, Co, Ni and Cu compared to the control site. In 2007 of August-September markedly high V, Cr, Ni, Zn load was detected compared to the other terms. These results might outcome from the extremely dry weather in the region which permits the appearance of the disturbing effects of windblown soil (Steinnes 1995).

In April-May, 2008 high Al, Fe, Cr, Ni, Cu, and extremely high Zn level measured. These peak data was observed at the South-East and East point of the oil-refinery. The Pb and V loads were the lowest, while Cd did not exceed the control level significantly. The measurement was may have been influenced by the wet and relatively cold April and May effected the decreasing of absolute elemental content which allows the leaching of elements from moss (Steinnes 1995).

Changing in air pollution compare to 1991

Remarkable decrease was observed in V, Cr, Ni and Fe content in the period of June-July of 2007 compared to 1991. The level of lead increased compared to actual controls. The August-September 2007 and April-May 2008 indicate the increase of Zn load.

Changing in air pollution compare to 2002/2003

In the investigating period of 2007 June-July, V content decreased and lead content increased. During the autumn exposition, V, Cr, Ni and Zn content elevated. The spring period indicated the elevation of Al, Ni, Fe and markedly Zn. These extreme high values were observed in connection with two sampling sites in 2007-2008, which was located in the South-East and East part of the oil-refinery. The origin of this observed pollution was partly due to the elemental load of previous years.

References

Steinnes E. A critical evaluation of the use of naturally growing moss to monitor the deposition of atmospheric metals. *Sci. Total Environ* 1995;160/161:243-249
Tuba, Z., Csintalan, Zs. (1993): The use of moss cushion transplatation technique for bioindication of heavy metal pollution. In: Markert, B. (ed.): *Plants as biomonitors. Indicators for heavy metals in the terrestrial environment.* 403-411. VCH Publisher, Inc. Weinhem, New York.

AMBIENT AIR MONITORING USING THE MOSS BAG TECHNIQUE
IN THE THRIASSION PLAIN, ATTIKA, GREECE

Saitanis K.¹, Frontasyeva M.V.², Steinnes E.³,
Ostrovnaya T.M.², Gundorina S.F.², Tzamgiazis L.¹

¹*Agricultural University of Athens, Iera Odos 75 Votanikos 11855/Athens, Greece,
E-mail: saitanis@aua.gr*

²*Joint Institute for Nuclear Research, 141980 Dubna, Russian Federation,
E-mail: marina@nf.jinr.ru*

³*Norwegian University of Science and Technology, NO-7491 Trondheim, Norway,
E-mail: eiliv.steinnes@chem.ntnu.no*

The moss *Sphagnum girgensohnii* was employed as accumulative biomonitor of airborne trace elements (Na, Mg, Al, Cl, K, Ca, Sc, Ti, V, Cr, Mn, Fe, Co, Ni, Cu, Zn, As, Se, Br, Rb, Sr, Mo, Ag, In, Sb, I, Cs, Ba, La, Ce, Sm, Tb, Dy, Yb, Lu, Hf, Ta, Hg, Th, U) determined by instrumental neutron activation analysis (INAA) in the agglomerations of Thriasion Plain, Attika, Greece. Moss bags were exposed to ambient air at 12 sites (8 moss bags at each site) covering an area of about 200 sq. km including industrial, urban, suburban, and rural districts. In order to explore the seasonal variation of the above pollutants, four sets of moss bags were exposed to the ambient air for 3, 6, 9 and 12 months respectively, starting from October 2004. Results of the exposure experiments revealed a clear differentiation of trace element pollutants within the local monitoring network. It was demonstrated that pollution levels differed considerably between the industrial/urban/ suburban and the surrounding rural sites. Pollution was influenced particularly by industrial and urban-traffic emissions. The biomonitoring sites located within or close to the industrial zone featured a much higher pollution load by trace elements than the others. Especially Mo, Ni, Hg, As, Sb, Cr, Fe, and Cu exhibited a very uneven distribution within the study area, with higher levels measured in moss bags exposed in sites located close to industries and major roads, and moderate to low levels in moss exposed at surrounding rural sites. Accumulation of Ni and V was influenced by other emission sources. Different elements exhibited different dynamics. The majority of the elements (e.g. Al, Ca, Ni, I, Zn, Cr, and As) accumulated over time, whereas other elements (e.g. Mn, Na, Cl, Br, and Hg) exhibited higher levels in the first winter months but were subsequently removed by leaching or evaporation during the following spring and summer months. Biomonitoring with moss bags provides additional information on environmental and human health aspects to the routine monitoring programmes that deliver data on environmental levels of particulate matter from continuous measurements, but do not provide details on the elemental composition of fine dust.

The authors acknowledge the Black Sea Economic Council (BSEC) for partial support of this study carried out in the framework of the international project “Revitalization of urban ecosystems through vascular plants: assessment of technogenic pollution impact”.

ASSESSMENT OF TROPOSPHERIC OZONE INJURIES IN PLANTS UNDER AMBIENT CONDITION IN BANGLADESH

Salam, M.A.,¹ Islam, M.T.²

¹Agronomy Division and ²Dept. of Environmental Science, Bangladesh Agricultural University, Mymensingh

A pot experiment was conducted at the field laboratory of the Dept. of Environmental Science, Bangladesh Agricultural University, Mymensingh to assess the visual ozone injury in White clover crops (*Trifolium repens* cv. Regal) during April'2007 to February'2008. Two genotypes of white clover were used. One was ozone susceptible (NC-S) and the other was ozone resistant (NC-R). Total plant dry matter was harvested 4 times at 28 days interval resulted in increasing biomass gradually in later harvests. The monthly mean ozone values collected from passive sampler during April to August'07 were recorded as 29.11, 34.77, 26.00, and 31.5 ppb respectively. Ozone concentration measured in December, 2007 and January, 2008 was also 17.5 and 21.5 ppb, respectively. These results on ozone concentrations in troposphere seemed to be changed with changing the temperature in Bangladesh Environment i.e. the ambient ozone concentration becomes higher in summer season as the temperature is higher. The susceptible NC-S showed visual ozone injury symptom from very slightly to slight (1-5% of injured leaves) whereas the resistant cultivar showed no visual injury symptom. NC-S generally produced less biomass than the NC-R.

Keywords: Ozone, clover, biomass, injuries.

RETROSPECTIVE ANALYSIS OF $\delta^{15}\text{N}$ AND $\delta^{13}\text{C}$ SIGNATURES IN THE NATURAL PARK OF BERTIZ (SPAIN) USING HERBARIUM MOSS SAMPLES

*Santamaría, J.M.; Ederra, A.; González, L. and Elustondo, D.

Universidad de Navarra, Irunlarrea nº 1. 31008 Pamplona (Spain). E-mail: chusmi@unav.es

The use of stable isotopes at natural abundance levels provides a powerful approach for understanding environmental interactions. Isotopic composition of elements, such as C and N, changes in predictable ways during their course through the biosphere, which makes them ideal tracers of the pathways and origin of these elements.

Temporal variations of C and N elements in the Natural Park of Bertiz (North of Spain) were investigated by comparing concentrations and $\delta^{13}\text{C}$ and $\delta^{15}\text{N}$ isotopes signatures of historical and recent samples of the mosses *Dicranum scoparium*, *Thamnobryum alopecurum*, *Thuidium tamariscinum* and *Hypnum cupressiforme* (see Figure).

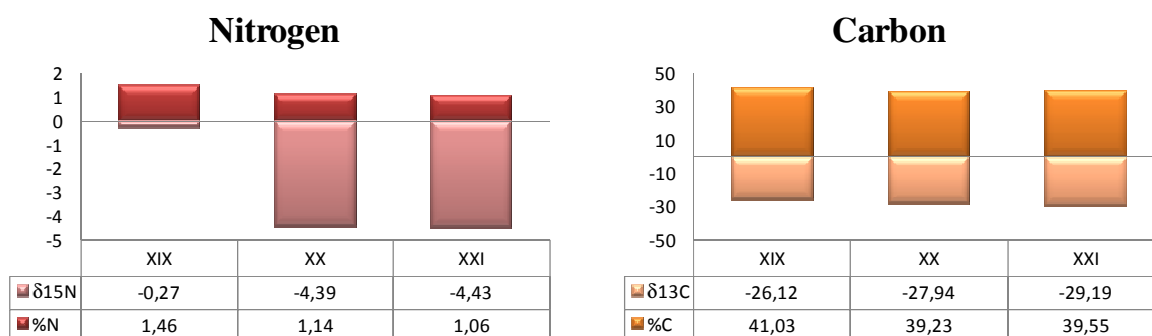

Figure. Comparison of N and C concentrations (%) and isotope signatures (‰) of mosses by century.

In contrast to other studies, N and C concentrations of mosses collected in Bertiz decreased from the 19th century to the 21st one. A plausible explanation for this may be found in the history of Bertiz during the XIX century. Then, the accomplishment of coal bunkers inside the forest was very frequent, in order to obtain charcoal to feed the numerous existing foundries in surrounding valleys. Consequently, it is very probable that a remote place like Bertiz were more contaminated by local activities at that time than at present.

Concerning the natural abundance of $\delta^{15}\text{N}$ and $\delta^{13}\text{C}$, in both cases values decreased progressively from 19th Century to the present time. In the case of N, a clear trend towards ^{15}N depletion has been observed, in agreement with the results obtained by other authors in herbarium studies. This may be related with the increasing of N inputs in the reduced form, which is consistent with the gradual intensification of agriculture in the studied area. On the other hand, ^{13}C abundance varied from -26.12‰ to -29.19‰, values included within the range of C_3 plants. The observed decreasing of $\delta^{13}\text{C}$ agrees with the depletion of ^{13}C detected in the atmosphere in the last decades due to the increasing of anthropogenic emissions as well as the fractioning by mosses against the heavy stable isotope of carbon.

In spite of the obtained results, it is obvious that the atmospheric concentrations of N and CO₂ have significantly increased since the Industrial Revolution; nevertheless, it is possible that the background pollution of Bertiz around the 19th Century were more elevated than at present, an area that actually is a Natural Park in which any anthropogenic activity is not developed.

Dry samples were grounded and analysed using an elemental analyzer (Carlo Erba Instrumentazione) coupled to an isotope ratio mass spectrometer (Delta C, Finnigan Mat) operating in continuous flow mode.

Samples were taken from the bryophytes stored in the herbaria PAMP of the University of Navarra, which contains specimens collected in Bertiz since 1879 (herbaria of Lacoizqueta and Fuertes & Álvarez), and separated in three different periods throughout the XIX, XX and XXI centuries.

Table I. Comparison of N and C concentrations and isotope signatures of mosses by century

Century	%N	δ ¹⁵ N	%C	δ ¹³ C
XIX	1,46	-0,27	41,03	-26,12
XX	1,14	-4,39	39,23	-27,94
XXI	1,06	-4,43	39,55	-29,19

BIOMONITORING OF TROPOSPHERIC OZONE IN SOUTH AFRICA, USING WHITE CLOVER (*TRIFOLIUM REPENS* L. CV. REGAL) BIOTYPES: GROWTH AND PHYSIOLOGICAL EFFECTS FOLLOWING AMBIENT AND ELEVATED OZONE EXPOSURE.

Smit, P.R.,¹ Büker, P.,² Krüger, G.H.J.¹

¹. *School of Environmental Sciences and Development, North West University Potchefstroom Campus, South Africa.*

². *Stockholm Environmental Institute, University of York, United Kingdom.*

E-mail: pieter.smit@nwu.ac.za^o, pb25@york.ac.uk^{oo}, gert.kruger@nwu.ac.za^{ooo}*

Ozone is one of the most unique molecules ever described by modern science. Having an irreplaceable task in protecting earth from damaging short wavelength solar radiation in the stratosphere, it is also one of the most phototoxic and relevant secondary pollutants present in the troposphere.

The aim of the study was the biomonitoring of tropospheric ozone levels, using ozone sensitive (NCS) and ozone resistant (NCR) biotypes of white clover (*Trifolium repens* L. cv. Regal). Parallel to the basic biomonitoring experiment, measurements were made to assess the effect of ozone on the physiological processes of the plants. The plants were exposed to ambient conditions (monthly average ozone concentration 22 ppb) at the experimental site in Potchefstroom South Africa, for two growth seasons (2005/06 and 2006/07), each season stretching over four periods of 28 days. During the 2008 growth season the two biotypes were exposed to elevated ozone levels under controlled conditions in an “open-top” chamber system. Plants were assessed for visible ozone injury and were harvested every 28 days to determine biomass yield. Chlorophyll-*a*-fluorescence, photosynthetic gas exchange, chlorophyll index and stomatal conductance of the experimental plants were measured.

The ozone biomonitoring assay, developed under European conditions, could be successfully carried out under southern-African conditions. Ambient ozone levels at Potchefstroom were however not high enough to cause either decisive visible ozone injury or significant differences in the physiological parameters measured. The biomass yield of the NCS biotypes was lower on average than that of the NCR biotype, pointing at ozone-induced constraints on the growth of NCS biotypes. A marked seasonal effect, in terms of physiological and growth parameters, was observed in both biotypes. It was apparent that environmental conditions such as humidity and temperature played an important role in the reaction of the plants to the ambient ozone levels.

Under the controlled elevated ozone level of 80 ppb maintained in open-top chambers, the sensitive biotypes showed clear visible ozone injury. No significant difference in the response of the two biotypes to the elevated ozone with respect to physiological and growth parameters were however observed.

The fact that the biotypes seemed to react differently in terms of yield and physiological parameters under different environmental conditions, suggests that the critical level of ozone for plants under southern African conditions is strongly affected by climatic conditions.

TEMPORAL AND SPATIAL CHANGES IN ELEMENT CONTENT DISTRIBUTION IN MOSS IN THE CZECH REPUBLIC IN THE LAST 15 YEARS

Suchara I., Sucharová J., Holá, M.

*Silva Tarouca Research Institute for Landscape and Ornamental Gardening,
Kvìtnové námìstí 391, CZ 252 43 Prùhonice, Czech Republic; suchara@vukoz.cz*

The temporal and spatial changes in element contents of mosses in the Czech Republic were determined through a comparison of differences in the element composition of moss samples repeatedly collected at identical plots in individual bio-monitoring campaigns. The relevant analytical data was made available for the content of 10 elements in moss at 22 sampling plots in the period 1991–2005, 13 elements in moss at 152 plots in the period 1995–2005 and 36 elements in moss for 247 plots in the period 2000–2005.

In the 1980s, major Czechoslovak metallurgical, engineering and chemical industries were aggregated mainly in northwestern Bohemia (Ústí nad Labem–Most districts), in northern, central, southwestern and northeastern Bohemia (Liberec–Jablonec, Slaný–Kladno, Pøíbram, Rokycany–Plzeò, Hradec Králové–Pardubice districts) and in southern and northeastern Moravia (Brno, Ostrava–Frýdek Místek districts). A radical reduction and restructuring of Czech heavy industry has taken place since 1990. Northwestern and northeastern parts of the Czech Republic formed sides of two of the most polluted regions of Central Europe, the so-called Black Triangle I and Black Triangle II.

The evaluation of the first Czech bio-monitoring results revealed a significant decrease in element content in moss, for example, As, Fe, Ni, Pb and V by 50–77% between 1991–1995 due to the closure of many industrial enterprises in the Liberec, Plzeò, Kladno, Slaný and Pardubice districts (no moss samples were collected in Moravia in the first moss survey 1991). Between 1995–, the decrease in element content in moss continued, but at a slower rate. For example, the average accumulation of As, Cd, Co, Hg, Pb, V and S in moss in 2000 was 25–50% lower than in 1995. A decrease in industrial production, reduced brown coal combustion, desulphurization of coal power plants (1994–1998) and reduced and ceased distribution of leaded petrol (1998–2000) led to decreased element accumulation in mosses. However, a relatively high accumulation of elements in moss persisted in the Ostrava, Most and Pøíbram regions and in the Jizerské Mts (affected by the operation of the nearby Turów power plant in Bogatynia, Poland). The most recent bio-monitoring campaigns in 2000 and 2005 most frequently showed an insignificant decrease by 2–%, or even an increase, in the element content in mosses. There were significant decreases only in the content of Bi, Co, Cr, Cu, Ga, Mo, Ni, Pb, S, Sn and Tl due to the reduced number of industrial enterprises. Increased production of electricity, car traffic density and the introduction of new plants may have brought the reduction in element accumulation in moss in the Czech Republic to a stop in recent years. The hot spots near Ostrava, Most, Pøíbram and Frýdlant are still in operation. There has also for a long time been a large hot spot of high accumulation of typical soil elements (Al, Fe, Ce, Ni, REEs, U, etc.) in mosses in southern Moravia. This area has been affected by increased precipitation of soil particles eroded from large fields in this highly agricultural region. This hot spot is dependent on weather conditions, which control the erosion rates. Eroded particles are transported across the Czech /Slovak and Czech/Austrian borders, which form a sort of soil dust triangle territory.

BIOGEOCHEMICAL EXPLORATION OF FORESTS AS A BASIS FOR LONG-TERM
LANDSCAPE MANAGEMENT IN THE CZECH REPUBLIC. INTRODUCTION TO
PROJECT CZ0074

Sucharová J.¹, Suchara I.¹, Holá M.¹, Reimann C.², Boyd R.²

*1 Silva Tarouca Research Institute for Landscape and Ornamental Gardening,
Kvìtnové námìstí 391, CZ 252 43 Prùhonice, Czech Republic; suchara@vukoz.cz*

*2. Geological Survey of Norway (NGU), NO7491 Trondheim, Norway;
Clemens Reimann@ngu.no*

Biogeochemical exploration of forest in the Czech Republic has been supported by Norwegian grants since summer 2008. The main goal of this project, approved for 2008–2010, is to recognise the distribution, mobility and potential hazards of approximately 35–40 elements in the landscape. Toxic, hazardous and other biologically active elements will be investigated in greater detail. The required data on these elements in the Czech landscape will be obtained by analyses of suitable media collected in coniferous forest ecosystems.

The network of 282 sampling plots used in the Czech moss monitoring campaigns (UNECE ICP-Vegetation) is being applied for purposes of this project. The following natural media were collected at these forest plots in 2005–2007:

Grass *Deschampsia flexuosa*, to assess the bioavailability of elements firmly absorbed in forest floor humus. The grass is common food for forest game.

Fern *Athyrium filix femina*, to assess the bioavailability of elements easily mobilised in a soil solution, and to determine the element concentrations in the potential element (hyper)accumulator. This fern a favourite food of deer.

Spruce (*Picea abies*) needles (one and two-year old), to evaluate the bioavailability of elements from the soil and the current nutritional conditions for spruce, the most abundant tree in the Czech forests.

Forest floor humus (Oh, H horizon), to determine the distribution of firmly absorbed elements and to reveal hot spots of long-term accumulated atmospheric deposition loads of elements archived in the forest floor.

Soil samples (mainly Be, Bi horizons), to determine the potential soil pool of elements and to assess their movement in soil profiles.

If needed, additional materials (e.g., wood cores, spruce bark, brook water) will be collected at the forest plots and analysed.

In samples of grass and spruce needles, the content of 38 elements is being determined using ICP-MS and ICP-OES instruments and Hg and CNS analysers. The content of Pb isotopes has been also determined. The element content in soil and humus samples and their basic properties (active and exchange reactions, loss-on-ignition, etc.) will be determined in relevant samples in 2009–2010.

The project results will be integrated and evaluated together with the CZ moss survey data obtained in 2005 and 2010 in order to obtain more comprehensive information about the distribution and the potential effects of the investigated elements in Czech coniferous forests potentially affected by markedly variable geological, climatic and pollution conditions.

More details about the project will be available from 2009 onwards on
www.norwaygrantCZ0084.eu

SOME PHYSIOLOGICAL FEATURES OF COMMONLY USED BIOINDICATORS OF TROPOSPHERIC OZONE

Villányi, V., Csintalan, Z., Urmös, Z., Nagy, Z., Tuba, Z

*Institute of Botany and Ecophysiology, Szent István University,
e-mail: novenytan@mkk.szie.hu*

Ozone pollution in the troposphere is one of the most important and widely spread environmental problems nowadays. The harmful effects of ozone on vegetation can be more precisely evaluated by using ozone bioindicator plants. In Hungary, the monitoring work started in 2007 applying the ozone bioindicator clover (*Trifolium repens* NC-S and NC-R clones) as test plant. In 2008, the ozone-sensitive and ozone-resistant bean strains (*Phaseolus vulgaris* S 156 and R 123 strains) were also included in our experiments. The main goals of our last year's investigations were to follow the ozone load at our experimental sites by the detection of symptoms and the changes in some specific physiological features (fluorescence induction and stomatal conductance) of test plants, furthermore to examine the effect of elevated atmospheric CO₂ level on their bioindicator characteristic. The clover and bean pots were located in two experimental sites, in a hilly region near to the capital city (Gödöllő site) and in a mountainous region (Szurdokpüspöki site) of Hungary. For cultivation of plants and for assessing the injuries the protocol of the ICP Vegetation was used. The elevated CO₂ treatment was carried out in open top chambers in Gödöllő. During 2008 the AOT40 values at the mountainous Szurdokpüspöki site were considerably higher than those at the Gödöllő site. While we could observe only visible ozone injuries on bean leaves, the clover clones proved to be more suitable for ozone bioindication since besides the symptoms other morphological (the number of flowers) and physiological characteristics (primarily the stomatal conductance) also markedly changed. In the case of bean strains the only parameter changed was the stomatal conductance and this change could only be observed at the strongly polluted Szurdokpüspöki site. Interestingly, the maximum quantum efficiency of photosystem II (Fv/Fm) was consistently higher at the ozone sensitive clover clone comparing to the resistant one. The elevated CO₂ clearly modified the effect of ozone, however only in the case of the clover clones. While the increasing temperature (glasshouse effect of OTCs) significantly increased the ozone sensitivity (higher degree of visible injuries and lower number of flowers), the elevated CO₂ level could diminish and even overcompensate this effect.