

DEVELOPMENT OF A WIRELESS ACCELERATION MEASUREMENT SYSTEM

TAKAHIRO YAMASAKI^{1*}, KANA OTA², MITSUHIRO MIYAMOTO²,
YUICHIRO AMANO³, MASATOSHI OKADA³, AND TOMOYUKI KIDO³

¹Shikoku Research Institute Inc
Civil Engineering Department
2109-8, Yashimanishimachi, Takamatu City, Kagawa Prefecture, Japan
e-mail: t-yamasaki@ssken.co.jp, web page: <http://www.ssken.co.jp>

²Kagawa University
Faculty of Engineering/And Design
2217-20, Hayashicho, Takamatsu City, Kagawa Prefecture, Japan
Web page: <https://www.kagawa-u.ac.jp>

³Shikoku Electric Power Company, Inc.
Civil & Architectural Engineering Department
2-5, Marunouchi, Takamatsu City, Kagawa prefecture, Japan
Web page: <https://www.yonden.co.jp>

Keywords: Acceleration Monitoring, Wireless sensor, 920MHz, Multipoint synchronization

Abstract. *The newly developed low-cost micro-electro-mechanical system (MEMS)-based acceleration sensors exhibit sufficient accuracy and stability to monitor the shaking of structures caused by an earthquake. We have developed a practical shaking-monitoring system using MEMS-based acceleration sensors and a 920 MHz multi-hop radio communication method that offers reliable radio wave communication, even within buildings. In this system, the base clock of each sensor unit must be closely synchronized to the master clock to minimize acceleration-induced phase synchronization error. In the proposed system, this error can be limited to three milliseconds in a system of multiple sensor units.*

1 INTRODUCTION

In the 1995 Hyogo-Ken Nanbu earthquake, many wood-framed residential structures and other traditionally built Japanese structures were damaged. Following the earthquake, interest in the study of earthquake resistance of historical buildings such as traditional wooden buildings has grown. The 1999 publication of Japanese guidelines for the seismic diagnosis of historical buildings^[1] led to widespread quantitative evaluation of the seismic performance of historical buildings and routine seismic reinforcement.

In the seismic diagnosis of historical buildings, it is important to understand the characteristics of building vibrations, using seismic measurement. However, such measurements must be conducted nondestructively to prevent damage to the structure, using a wireless acceleration measurement system that can be easily installed without wiring.

Many wireless acceleration measurement systems built with the inexpensive and highly

accurate micro-electro-mechanical system (MEMS) acceleration sensor are in current use. Generally, in acceleration measurement systems that work at multiple points simultaneously, time synchronization between sensors is important. Many such systems adopt highly accurate time synchronization methods using the Global Positioning System (GPS). Furthermore, in relation to the operation of acceleration measurement systems in buildings, it is necessary to establish stable and highly accurate time synchronization methods, even where GPS radio waves do not reach. In the time synchronization operations of wireless acceleration measurement systems intended for indoor use, the use of broadcast time stamps^{[2][3]} has been proposed.

Many of the wireless acceleration measurement systems currently in use employ radio waves in high-frequency bands such as the 2.4 GHz band. Large amounts of data can be transmitted easily by radio waves in this band. However, in the context of indoor use, these systems may not provide reliable communication, failing due to the interference of walls, other devices using the 2.4 GHz band, and walls. Therefore, we considered it desirable for wireless accelerometer systems used in buildings to employ radio waves in the 920 MHz band that enables stable communication even in buildings with much interference.

However, there are few wireless acceleration measurement systems that use 920 MHz band radio waves with highly accurate time synchronization in buildings and structures. The purpose of this study is to develop a wireless acceleration measurement system for use in buildings and constructions that can easily be installed.

This paper presents this system, which shows high time synchronization accuracy and stable communication performance.

2 A WIRELESS ACCELERATION MEASUREMENT SYSTEM

2.1 System overview

The newly developed wireless acceleration measurement system SwingMinder uses openATOMS communication technology, a wireless on-demand monitoring system developed by Y. Nakanishi.^[4] Many wireless sensors have been developed that use 2.4 GHz band radio waves, but SwingMinder uses 920 MHz radio waves, which enable long-distance communication of up to 1000 m per hop, with a radio wave output of 20 mW outdoors. This enables wireless communication paths that can transmit radio waves through concrete slabs in buildings.

SwingMinder includes a data-collection unit called the network computer (NC) and multiple acceleration sensor units called networked intelligent cells (NICEs). Figure 1 shows an NC and an NICE, and Figure 2 presents the system configuration of SwingMinder. The acceleration time history data recorded by each NICE are collected by the NC and are transmitted to external remote-monitoring devices through an internet network such as 3G/LTE. The transmitted data can be converted into a csv format, confirmed, and analyzed remotely.

Each NICE is equipped with a 32-bit micro controller unit (MCU) that is capable of performing real-time fast Fourier transform (FFT) processing while measuring acceleration time history data and saving them sequentially in a recording medium. By placing data-analytical capabilities in the NICE units, which then transmit only important data, we resolved the issue of communication limitations that can be present when 920 MHz band

radio waves are used. Additionally, because the trigger for starting acceleration measurement is placed within each NICE unit, only important data are recorded, and reducing the amount of data that must be transmitted.

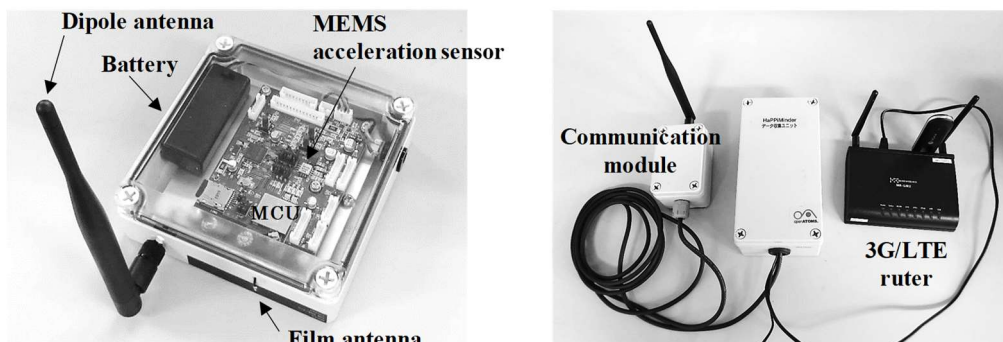

Figure 1. SwingMinder (left, NICE; right, NC)

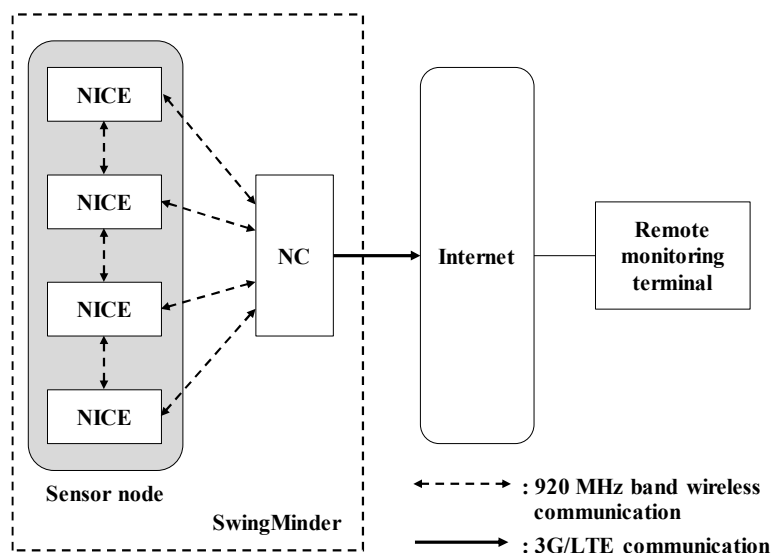

Figure 2. System configuration of SwingMinder

Long-term power outages can be predicted in earthquakes. The emergency power supply in each NICE is two lithium AAA batteries that deteriorate slowly, and these supplement the regular electrical power supply. They will enable each NICE unit to run for about 30 hours in conditions of power outage.

NICE uses ADXL355, a three-axis MEMS accelerometer built by Analog Devices, for its acceleration sensor. The ADXL355 can measure acceleration from 0.1 Gal to 8,000 Gal and registers tilt angles at 0.01° increments. To measure the primary wave, acceleration 10 seconds before the trigger is activated can be also measured. In addition, any acceleration at any time after trigger is released is also measured. The measurement specification of the NICE unit can easily be changed by rewriting the contents of the setting file that is saved on the memory card. The out shape of the NICE's resin case, which contains an MEMS

accelerometer, an MCU, and two lithium AAA batteries, is $125 \times 125 \times 35$ mm and can be installed in narrow space. Table 1 shows the main specifications and performance of the SwingMinder. The acceleration measurement range can be set at ± 2 G, ± 4 G, or ± 8 G, and the sampling frequency can be set at 100 Hz, 200 Hz, or 400Hz. NICEs are powered by 3.3V DC power, converted from power provided by 100 V outlets with an AC adapter.

Table 1. Performance specifications of SwingMinder

Wireless communication module	920 MHz multi-hop method Communication distance: 1000 m Communication speed: A few kbps to about 100kbps
Acceleration sensor	ADXL355 (analog device)
Acceleration measurement range	Set at ± 2 G, ± 4 G, or ± 8 G
Sampling frequency	Set at 100 Hz, 200 Hz, or 400 Hz
Power supply	With AC adapter (DC 3.3 V)
Operating time under conditions of power failure	About 30 hours (on backup built-in AAA lithium battery power source)

2.2 Time Synchronization between NICEs

When each NICE was tested with synchronization provided by the RC transmitter that is standard in an MEMS accelerometer, synchronization error between the NICEs was on the order of 100 milliseconds. Thus, the NICEs could not be synchronized within 5 milliseconds, as is required for simultaneous measurement at multiple points. Therefore, we equipped NICEs with high-precision programmable MEMS transmitters (with an error of 0.002% or less) to allow times to be accurately recorded at arbitrary intervals. In addition, between the NC and each NICE, the time was set at with accurate timing check at every 10 seconds, using the MCU internal time, which was maintained with high accuracy. Thus, the NICEs were designed to be able to synchronize times within ± 3 milliseconds, which was below the necessary time increment for acceleration measurement to be performed at a sampling frequency of 200 Hz.

2.3 Data transmission method between NICEs

Using 920 MHz band radio waves, SwingMinder can secure stable communication in buildings. However, because the communication speeds enabled by 920 MHz band radio waves is low, they would require long transmission times for communicating the large amount of data necessary to interpret the variable acceleration time history data for each floor of a building in an earthquake.

To solve this problem, SwingMinder creates acceleration time history data every 10 seconds and transmits them sequentially after acceleration is measured that exceeds the threshold. This evades the disadvantage of the slow communication speeds on the 920 MHz band and enables acceleration time history data to be collected quickly after an earthquake.

2.4 Calibration of NICES

The MEMS accelerometer used in SwingMinder calculates acceleration by electrically measuring the distance that the weight and silicon springs installed inside the accelerometer move. Because there is a known inherent error of the silicon springs in the accelerometer, an initial calibration of the accelerometer is required for accurate measurement.

We measured gravitational acceleration with 65 MEMS accelerometers without initial calibration and compared them to standard gravity values; this indicated that the maximum error between measured acceleration and standard gravity was about 4.0% in the x-axis, 4.5% in the y-axis, and 13.8% in the z-axis. This showed that unacceptable measurement error is possible if the NICE units are not properly calibrated.

An important factor in measurement error is sensitivity error, which refers to the variation in the slope of the input and output of the transfer function measured at +1 g and -1 g. Another factor is the initial absolute offset, which was measured immediately after manufacture. We calibrated these errors using the two-point calibration method.^[5]

With equations (2) and (3), the correction coefficients for the initial absolute offset and sensitivity errors were calculated. Then, using following equation (1), measurement acceleration was corrected. The accelerometer was calibrated using the same method for the y-axis and the z-axis.

$$X = (AX_1 \cdot a/g \cdot b)(X_0 + a \cdot AX_0) \quad (1)$$

$$AX_0 = -(X_1 + X_2)/(2a) \quad (2)$$

$$AX_1 = 2g/(X_1 - X_2)b \quad (3)$$

X : Measured acceleration after calibration(m/s²)

X_0 : Measured acceleration before calibration(m/s²)

AX_0 : Correction coefficient of initial absolute offset

AX_1 : Correction coefficient of sensitivity error

X_1 : Measured acceleration upward along the x-axis

X_2 : Measurement acceleration downward along the x-axis

a : Measurement resolution of acceleration

b : Integer actor

g : Standard gravity

3 EXPERIMENT TO EVALUTE TIME SYNCHRONIZATION ACCURACY BETWEEN NICE UNITS

3.1 Experimental method

To evaluate the time synchronization accuracy between the NICES, a simultaneous excitation experiment of 10 units was conducted using a two-axis shaking table. Figure 3 shows the experimental setup. First, 10 NICE (NICE00 to NICE09) were fixed to a wooden board with screws. Next, the wooden board was fastened to the shaking table with bolts, so that the NICES and the shaking table could be vibrated together. Then, the table was vibrated using the input waves shown in Table 2, and the acceleration of the shaking table was measured by the units. The excitation was conducted in the direction shown in Figure 3, set to the x and y directions. The sampling frequency of the NICE was set to 200 Hz, which is generally used for observation of seismic motion.

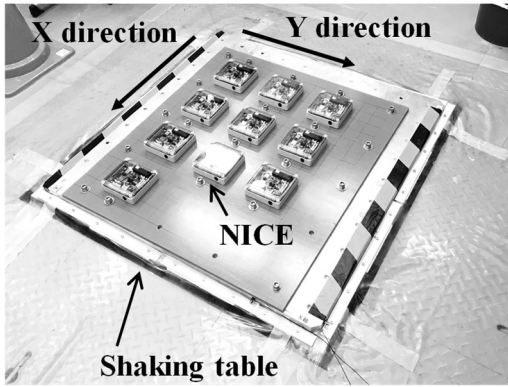

Figure 3. Experimental situation

Table 2. Excitation case

case	Input wave	Direction	Amplitude (mm)	Frequency (Hz)	Number of data
1-1	Sine wave	X	10.1	2	1024
1-2	Sine wave	X	10.1	5	1024
1-3	Sine wave	Y	10.1	2	1024
1-4	Sine wave	Y	10.1	5	1024
1-5	Sweep wave	X	2	0.1 - 20	4096
1-6	Sweep wave	X	2	20 - 0.1	4096
1-7	Sweep wave	Y	2	0.1 - 20	4096
1-8	Sweep wave	Y	2	20 - 0.1	4096

3.2 Results of the experiment

In cases 1-1 to 1-4, the time synchronization accuracy was evaluated using 1024 pieces of data where the sine wave was in a steady state for the time history data of each case. In cases 1-5 to 1-8, the time synchronization accuracy was evaluated using 4096 data, where clear sweep vibration was measured in the time history data of each case. Table 2 shows the number of data used for analysis in each case.

To quantitatively evaluate the time synchronization accuracy between each NICE, the time lag of the measurement acceleration was calculated for each frequency. The time lag between the NICE units can be evaluated by calculating the phase differences of the transfer functions of each NICE, relative to the reference NICE, using FFT. Equation (4) shows the relationship between the frequency and the period. Equation (5) shows the relationship between the phase differences and the time lag, such that by combining equations (4) and (5), we obtain equation (6), which shows that if there is a time lag between NICE, the phase difference changes with the frequency. Here, the phase difference is calculated by passing a straight line through the origin and assigning to each frequency slope of the time lag times 360. If there is no time lag, the phase difference is 0° .

$$f = 1/T \quad (4)$$

$$\theta = t_d/T \cdot 360 \quad (5)$$

$$\theta = 360 \cdot t_d \cdot f \quad (6)$$

f : Frequency (Hz)

T : Period (second)

θ : Phase difference (degree)

t_d : Time lag (second)

Figure 4 shows a representative analytical result for all excitation cases, with the amplitude and phase difference of the transfer functions of the acceleration measured by NICE09, relative to the one measured by NICE00. The horizontal axes of the graphs in Figure 4 show frequency, and the vertical axes show amplitude and phase differences. The results are shown up to the frequency of 20 Hz, the target for seismic response evaluation of buildings. In the graphs, the phase differences for time lags of ± 3 milliseconds are shown with dotted lines. The time lag is found to be within the ± 3 milliseconds set as the performance target because the phase difference is generally within the dotted lines in all excitation cases. Additionally, the same acceleration can be measured by each NICE unit because the amplitude of the

transfer function is approximately 1.0. The results of these tests suggest that each NICE unit produces highly accurate time synchronization.

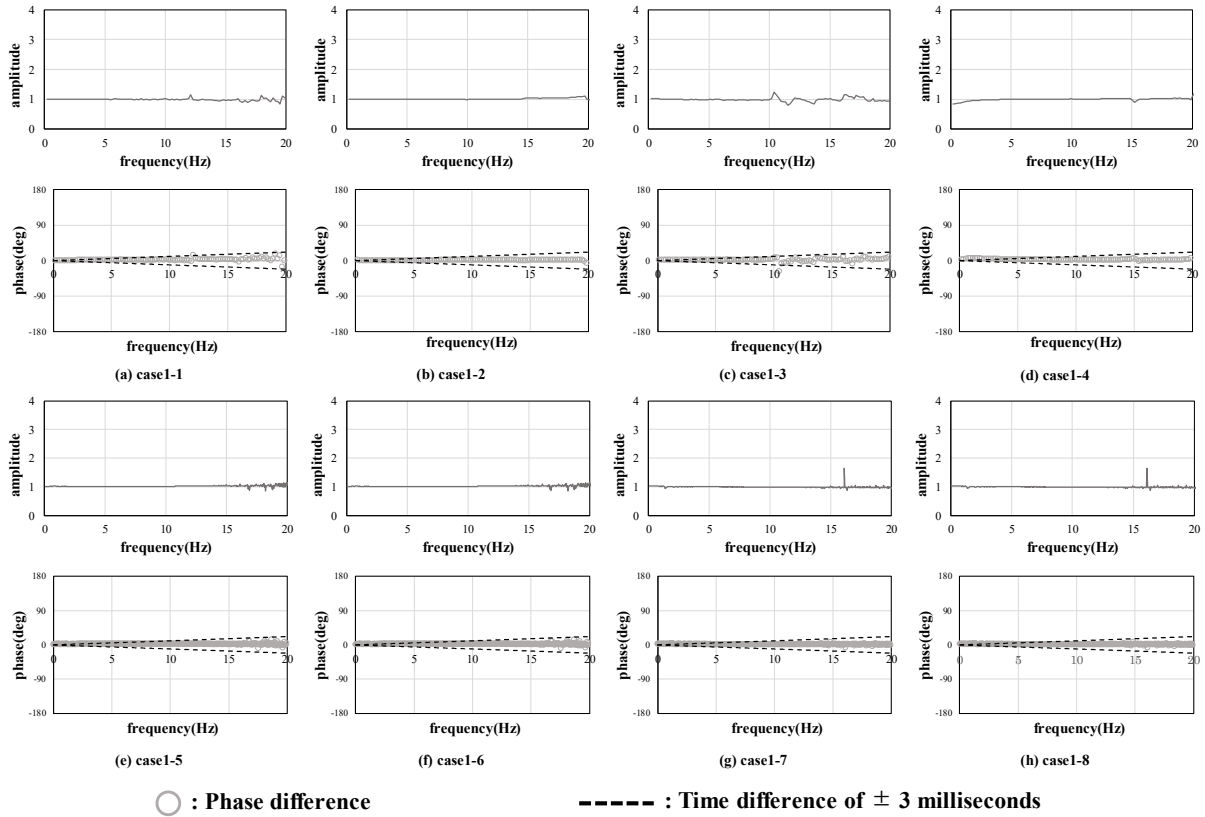

Figure 4. Transfer function between NICE00 and NICE09 (top: amplitude bottom: phase difference)

4 EXPERIMENT TO EVALUTE ACCELERATION MEASUREMENT ACCURACY OF NICE

4.1 Method of experiment

This chapter describes the contents and results of the excitation experiment used to simulate building motion in a simple three-layer model, conducted to evaluate the acceleration measurement accuracy of SwingMinder in structures. We created the three-layer model shown in Figure 5, which consisted of four square floors, with a length of 300 mm and a thickness of 30 mm, and four pillars, with a width of 30 mm, a thickness of 4.5 mm, and a height of 930 mm. The floors and pillars were made of aluminum, and each floor was equipped with an iron weight with a length of 250 mm, and a thickness of 18 mm to change the model weight. Four NICE units were installed on each floor of the model, which was placed on the shaking table, and one NICE was installed on table itself. Then, the table was vibrated, and the response acceleration on each floor was measured using the NICES. Additionally, to provide the reference values for the measured acceleration, calibrated reference accelerometers were also installed on each floor, and the response acceleration was measured with the reference accelerometer. The measurement accuracy of the NICES was

evaluated by comparing their results with acceleration measured by the reference accelerometer. The reference accelerometer measured acceleration at a sampling frequency of 240 Hz, and the NICE measured at a frequency of 200 Hz. Table 3 shows the excitation cases, and input waves were input in the x direction, as shown in Figure 5.

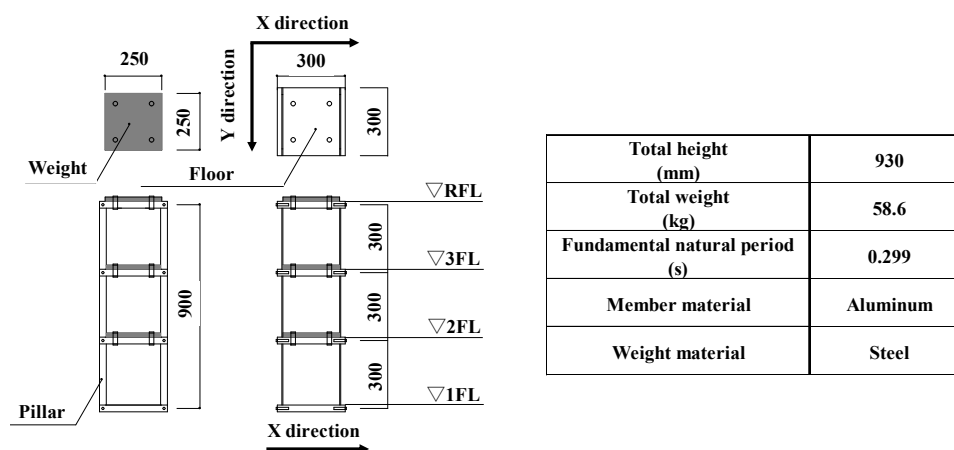

Figure 5. Outline drawing of the experimental model

Table 3. Excitation case

Case	Input wave	Amplitude (mm)	Frequency (Hz)	Duration (s)
2-1	Sweep wave	0.5	0.1–10	40
2-2	Sweep wave	0.5	10–0.1	40

4.2 Results of experiment

The sampling frequency of the acceleration measured by the reference accelerometers was converted from 240 Hz to 200 Hz and compared with to that measured by the NICES. To confirm the effects of the conversion of the sampling frequency on the results, the difference between the maximum measured acceleration before and after conversion was compared. The maximum difference was 0.11 m/s^2 , and the ratio of the maximum difference divided by the maximum acceleration before the conversion was 0.8%. These results suggest that the conversion of the sampling frequency had little effect on the comparison results.

Figure 6 shows the acceleration of each floor for each excitation case, measured simultaneously by a NICE and the reference accelerometer. The horizontal axis for each graph in Figure 6 shows the acceleration measured by a NICE, and the vertical axis shows the acceleration measured by the reference accelerometer. The solid line in each graph is a reference line representing the coincidence of acceleration. In each excitation case, the accelerations measured by the NICE and the reference accelerometer are plotted near the reference line. This finding suggests that the accelerations measured by the NICE and the reference acceleration are approximately equal. When SwingMinder is used as the acceleration measurement system in buildings, it is essential that it accurately measures the maximum acceleration in the building to enable proper seismic analysis.

Figure 7 gives a comparison of the maximum acceleration of each floor, as measured by

NICE and the reference accelerometer. The difference between the measurements was 0.41 m/s^2 on the rooftop. The difference between the results, divided by the maximum acceleration measured by the NICES, was 2.97%. This shows that the difference is small compared with the measured value, and that the measurement accuracy of SwingMinder is equivalent to that of a wired accelerometer.

This suggests that SwingMinder has sufficient measurement accuracy to be used as an acceleration measurement system in buildings.

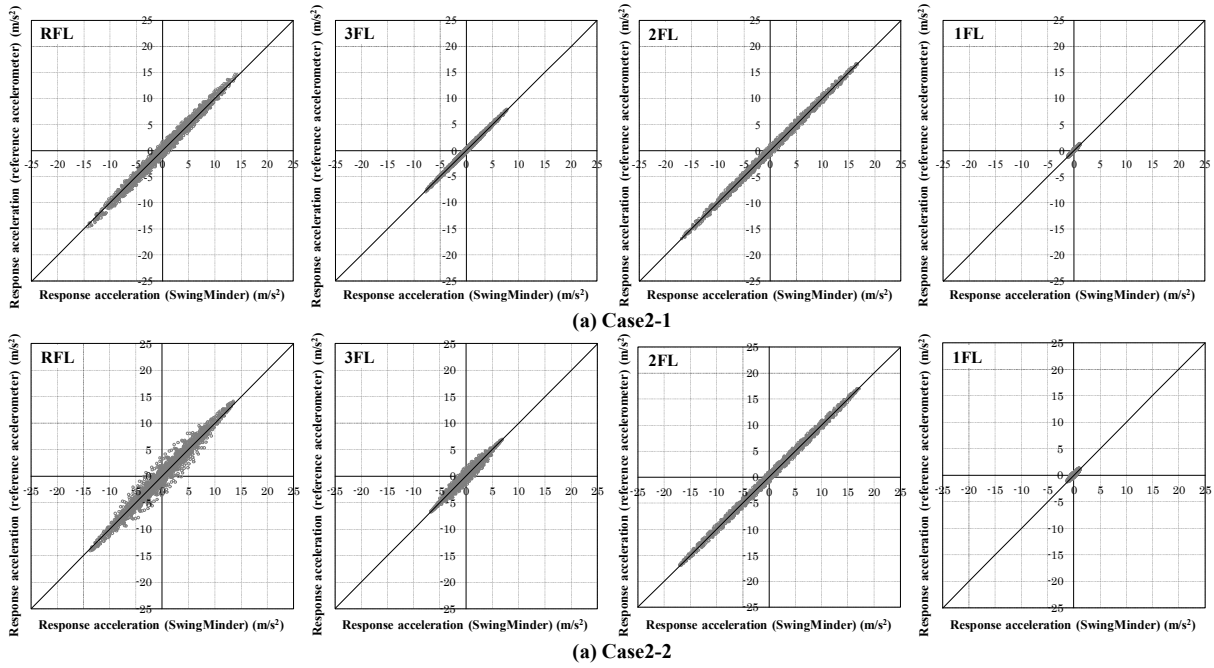

Figure 6. Comparison of response acceleration between NICE and reference accelerometer

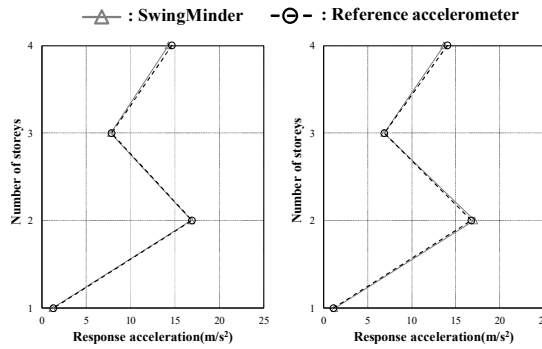

Figure 7. Comparison of maximum response acceleration (left, case 2-1; right, case 2-2)

5 VERIFICATION OF USABILITY IN ACTUAL BUILDINGS

5.1 Verification method

The experiments reported above showed that SwingMinder can be used as a wireless

acceleration measurement system. We also confirmed the usability of the SwingMinder system in actual buildings by installing it in 13 office buildings in the Shikoku region of Japan conducting earthquake observation. Figure 8 shows the specifications and locations of 13 buildings where seismic observation was conducted. NICES were installed on each floor, and seismic observation was conducted after the communication between the NICE and NC began. The sampling frequency of the NICE was 200 Hz, and the threshold for beginning the acceleration recording was 0.05 m/s^2 .

The acceleration data were recorded in some buildings shown in Figure 8 where earthquakes occurred in the Shikoku region during the observations. For example, an earthquake was observed at 15:37 on March 11 in Nanyo, Ehime Prefecture. The record was measured at Building C, and Figure 9 shows the earthquake information and the positional relationships between the epicenter and Building C. Building C is a seven-story reinforced concrete building, and NICES were installed on each floor, with the NC installed on the rooftop.

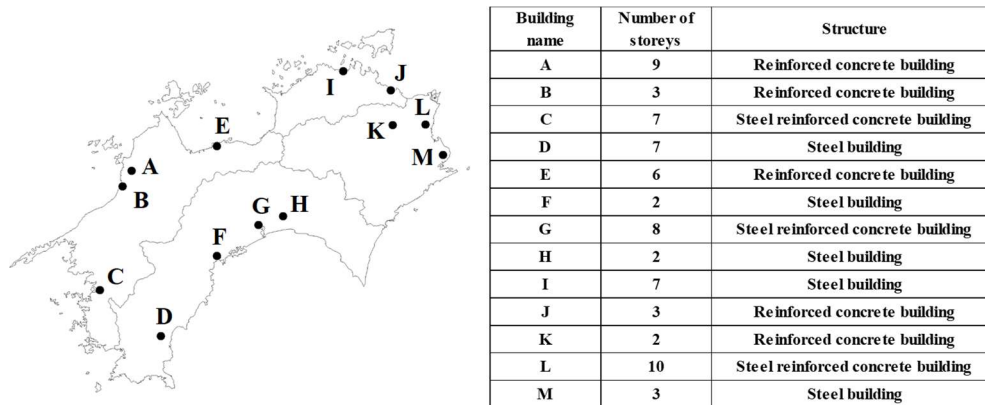

Figure 8. Target buildings used for verification

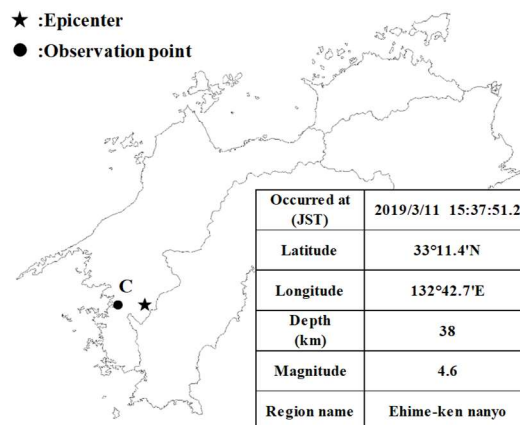

Figure 9. Epicenter information and observation points

5.2 Verification results

After SwingMinder was installed in Building C, we confirmed that the communication path between the NC and NICE units was open. In the time synchronization program of

SwingMinder, the time synchronization accuracy, as shown in section 3, was ensured by checking the status of the time synchronization using feedback signals between the NC and NICEs at regular intervals. Here, where the communication path between NC and NICE was open, we determined that time synchronization accuracy within ± 3 milliseconds was secured in Building C. Figure 10 shows the observation records for this building.

In Figure 10, the acceleration data for the x (east–west), y (north–south), and z (vertical) directions are shown, as measured without loss from all NICEs, from the first floor to the rooftop. Additionally, it was confirmed that the absolute value of the maximum acceleration increased progressively from lower to upper floors. In the case of the given earthquake, all the observation records were collected via the Internet from Kagawa Prefecture, which is remote from the building in Ehime Prefecture, approximately 10 minutes after the earthquake. The acceleration measurement accuracy of SwingMinder is founded on the accuracy of the MEMS accelerometer. Therefore, where NICEs are operating normally and acceleration measurement is possible, as in this verification, measurement records were collected with the acceleration measurement accuracy shown in section 5.

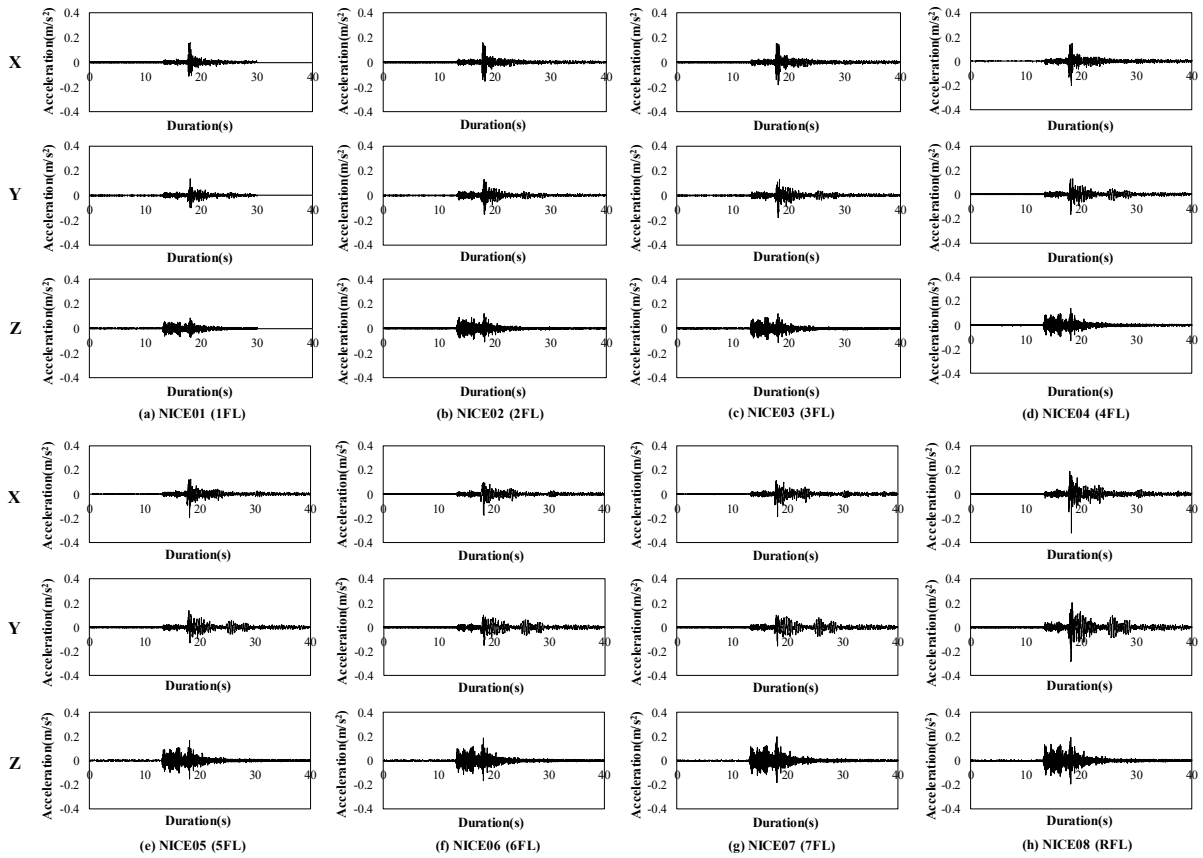

Figure 10. Observed acceleration time history for each floor in Building C

These results show SwingMinder is usable as an acceleration measurement system in actual buildings.

6 CONCLUSIONS

This study developed a commercial wireless acceleration measurement system with high time synchronization accuracy and stable communication capabilities within buildings, called SwingMinder. Verification tests were conducted on its synchronization and measurement accuracy and its usability in actual buildings, and the results are presented here. The following findings were obtained.

- SwingMinder has high time synchronization accuracy, with a time lag of each NICE within ± 3 milliseconds.
- The maximum measurement error between SwingMinder and the wired accelerometer was 2.97%, indicating that SwingMinder's measurement accuracy matched that of the wired accelerometer.
- The usability of the acceleration measurement system in actual buildings was verified, and the measured acceleration of the buildings was collected in a location that is remote from where the earthquake occurred.

These findings indicate that SwingMinder can be used as a wireless acceleration measurement system in actual reinforced concrete or steel buildings.

SwingMinder is also installed in traditional Japanese traditional buildings, and seismic observations have been carried out for the purpose of structural analysis. In the future, SwingMinder is expected to be used in more traditional Japanese buildings and other structures to provide seismic analysis and monitoring of structural health.

Acknowledgments. We are grateful to Y. Nakanishi for the development of SwingMinder. We are also grateful to N. Kotake and R. Fukuda for their assistance in the excitation experiments.

REFERENCES

- [1] Cultural Properties Protection Department, *Guideline for Assessing Seismic Resistance of Important Cultural Properties (Buildings)*, (2012).
- [2] Nagai, N., Mita, A., Yakoh, T. and Sato, T.: *Wireless Sensor for Structural Health Monitoring*, Journal of Japan Association for Earthquake Engineering, Vol.3, No.4 (2003), pp.1-13.
- [3] Sawada, M., Shiba, Y. and Oguni, K.: *Development of robust time synchronization method for wireless sensor network*, Journal of Japan Society of Civil Engineers A1 (Structural Engineering & Earthquake Engineering), Vol.65, No.1 (2009), pp.30-37.
- [4] Nakannishi, Y.: *Development and operation of the practical field monitoring systems based on openATOMS*, Proceedings of Annual Conference of Electronics, Information and Systems Society (2011), pp.724-727.
- [5] Allen Fan: *How to Improve the Accuracy of Inclination Measurement Using An accelerometer*, AnalogDialogue, Vol.52 (2018), Analog Devices.
- [6] Takahiro Yamasaki, Yuichiro Amano, Kana Ota, Mitsuhiro Miyamoto and Masatoshi Okada: *Development of wireless acceleration measurement system applied to structural health monitoring – Consideration for introduction to existing buildings -*, Journal of Structural and Construction Engineering (Transactions of AIJ), Vol.84, No.765, pp.1389-1399. (2019.11)