



5th

International Conference

<EnRe>

energy & responsibility

Book of
Extended Abstracts

Sebastijan SEME
Jurij AVSEC
Klemen SREDENŠEK

EDITORS



University of Maribor Press





University of Maribor

Faculty of Energy Technology

5th International Conference EnRe - Energy & Responsibility

Book of Extended Abstracts

Editors

Sebastijan Seme

Jurij Avsec

Klemen Sredenšek

June 2022

Title 5th International Conference EnRe - Energy & Responsibility

Subtitle Book of Extended Abstracts

Editors Sebastijan Seme
(University of Maribor, Faculty of Energy Technology)

Jurij Avsec
(University of Maribor, Faculty of Energy Technology)

Klemen Sredenšek
(University of Maribor, Faculty of Energy Technology)

Language editing Adele Gray

Technical editor Jan Perša
(University of Maribor, University Press)

Cover designer Jan Perša
(University of Maribor, University Press)

Cover graphics University of Maribor, Faculty of Energy Technology, 2022; flower from Pixabay.com, CC0, 2022

Conference 5th International Conference EnRe - Energy & Responsibility

Date and location 14th of June 2022, Velenje, Slovenia

International Scientific Committee Jurij Avsec (chairman), Marinko Barukčić, Amor Chowdhury, Nenad Cvetković, Goga Cvetkovski, Brigita Ferčec, Matej Fike, Adnan Glotić, Miralem Hadžiselimović, Željko Hederić, Gorazd Hren, Ankica Kovač, Samar Al Sayegh Petkovšek, Boštjan Pokorny, Zdravko Praunseis, Janez Rošer, Sebastijan Seme, Natalija Špeh, Bojan Štumberger, Gorazd Štumberger, Zdravko Virag, Peter Virtič, Mykhailo Zagirnyak, Marija Živić

Local organising Committee Jurij Avsec, Brigita Ferčec, Gašper Gantar, Boštjan Kranjc, Sonja Novak, Janko Omerzu, Sebastijan Seme, Karla Sitar, Klemen Sredenšek, Franc Žerdin

Published by University of Maribor, University Press
Slomškov trg 15, 2000 Maribor, Slovenia
<https://press.um.si>, zalozba@um.si

Issued by University of Maribor, Faculty of Energy Technology
Hočvarjev trg 1, 8270 Krško, Slovenia
Koroška cesta 62a, 3320 Velenje, Slovenia
<https://www.fe.um.si>, fe@um.si

Edition 1st **Published at** Maribor, Slovenia, June 2022

Publication type E-book **Available at** <https://press.um.si/index.php/ump/catalog/book/686>

CIP - Kataložni zapis o publikaciji
Univerzitetna knjižnica Maribor

629.97:502/504 (082) (0.034.2)

INTERNATIONAL Conference EnRe - Energy & Responsibility (5 ; 2022 ; Velenje)
5th International Conference EnRe - Energy & Responsibility [Elektronski vir] : book of extended abstracts : [14. June 2022, Velenje, Slovenia] / editors Sebastijan Seme, Jurij Avsec, Klemen Sredenšek. - 1st ed. - E-zbornik. - Maribor : University of Maribor, University Press, 2022

Način dostopa (URL):
<https://press.um.si/index.php/ump/catalog/book/686>
ISBN 978-961-286-602-0 (PDF)
doi: 10.18690/um.fe.5.2022
COBISS.SI-ID 110929923



© University of Maribor, University Press
Text © Authors & Seme, Avsec, Sredenšek, 2022

This work is licensed under the Creative Commons Attribution 4.0 International License.

This license allows reusers to distribute, remix, adapt, and build upon the material in any medium or format, so long as attribution is given to the creator. The license allows for commercial use.

Any third-party material in this book is published under the book's Creative Commons licence unless indicated otherwise in the credit line to the material. If you would like to reuse any third-party material not covered by the book's Creative Commons licence, you will need to obtain permission directly from the copyright holder.

<https://creativecommons.org/licenses/by/4.0>

ISBN 978-961-286-602-0 (pdf) **DOI** <https://doi.org/10.18690/um.fe.5.2022>

Price Free copy **For publisher** prof. dr. Zdravko Kačič, rector of University of Maribor

Attribution Seme, S., Avsec, J., Sredenšek, K. (eds.). (2022). *5th International Conference EnRe - Energy & Responsibility: Book of Extended Abstracts*. Maribor: University Press. doi: 10.18690/um.fe.5.2022

Table of Contents

PLENARY PROCEEDINGS	1
Challenges of the Energy Transition in the Šaleška Valley Mihael Sekavčnik	3
Quantifying Fast Voltage Variation Levels and Patterns Younes Mohammadi, Math H.J. Bollen	5
ENERGY MANAGEMENT AND ENGINEERING	9
Energy Renovation of Jesenice High School Boštjan Krošelj, Zdravko Praunseis	11
Reducing Carbon Footprint in an OEM Supply Chain Caused By Inadequate Interpretation of X-ray Results of Hidden Defects in Ductile Iron Castings Tadej Pavlin, Iztok Brinovar, Bojan Stergar, Zdravko Praunseis	15
Creating and Enabling Environments for Microgrids Supporting Collective Energy Measures – From Status Quo to a Microgrid-Friendly Policy Environment Lessons from a Slovenian Pilot Project in the Municipality of Selnica ob Dravi Tomaž Robič	19
The Seismic Monitoring System in the Velenje Mine and Preventive Rock Burst Measures Janez Rošer, Janez Mayer, Marko Es, Darian Božič	21
Self-sufficient Renewable Energy Supply for Military Sites – RESHUB Project Boštjan Drobnič, Robert Šipec, Tomaž Kutrašnik, Urban Žvar Baškovič, Mitja Mori	25
Utilising the Energy of Discharged Mining Water Using a Heat Pump Rolando Koren, Janez Rošer	29
RFCS Methenergy+ Project Methane Recovery and Harnessing for Energy and Chemical Uses at Coal Mine Sites Matjaž Kamenik, Janez Rošer	33
Transition Management vs Just Transition. The Place-based Governance Perspective in Western Macedonia, Greece Lefteris Topaloglou, Dimitris Theodoridis	37

Green Walls: An Eco-friendly System for Achieving Energy Efficiency in Buildings Dejan Tasić, Amor Chowdhury, Dalibor Igrac	41
A Hybrid Model for Predicting Surface Subsidence Above Underground Excavation Andrej Pal, Janez Rošer	45
Use of Remote Sensing Methods for the Planning, Design and Monitoring of the Velenje Coal Mine Environment Aleš Lamot, Janez Rošer	49
Just Transition and the Need for Monitoring and Assessing Mechanisms Dionysios Giannakopoulos, Dimitris Mavromatidis, Lefteris Topaloglou	51
Analysis Of Energy Efficiency and Energy Renovation Measures of a Single Unit House Iztok Brinovar, Tilen Sinkovič, Miralem Hadžiselimović, Bojan Štumberger, Gregor Srpčič, Klemen Sredenšek, Sebastijan Seme, Zdravko Praunseis	53
APPLIED ENERGY AND ALTERNATIVE HYDROGEN TECHNOLOGIES	55
Method of Best Available Technology and the Low-carbon Future of Combined Heat and Power Plants Dušan Strušnik, Marko Agrež	57
Design of wFoil 18 Albatross with Hydrogen Technologies Nejc Zore, Jurij Avsec, Urška Novosel	61
Energy and Applicative Analysis of the Use of Hydrogen in Road Transport in the Republic of Croatia Franco Krog, Jurij Avsec	63
The Global Future Trends of Hydrogen Production Jurij Avsec, Urška Novosel, Dušan Strušnik	67
Transport Sector and Hydrogen Through the 2022 Amendment of the Energy Statistics Regulation Klemen Deželak, Deja Jurgec	69
Heat Capacity of Phase-change Materials Obtained from Microscopic Properties Igor Medved, Anton Trník	71
The Impact of Coal and CO₂ Emission Coupon Market-Driven Prices on the Economic Operation of Thermal Power Plants Martin Brič, Jurij Avsec	73
Comparison of Teaching Methods in the Field of Engineering Between the University of the Azores, the University of Coimbra and the University Of Maribor Maria Joao Barros, Pedro Moura, Jurij Avsec	77
Optimisation of a Plate Heat Exchanger in a Solar Refrigeration System Antun Barac, Marija Živić, Zdravko Virag, Antun Galović, Matej Đuranović, Milan Vujanović	79

Numerical Prediction of Cavitation Erosion on a Hydrofoil Marko Pezdevšek, Andrej Predin, Matej Fike, Gorazd Hren	81
Energy of Water Spilled Over Hydropower Dams Matej Fike, Marko Pezdevšek, Gorazd Hren, Andrej Predin	83
ECOLOGY AND ENVIRONMENTAL PROTECTION	85
Carbon Management in a Circular Economy Teos Perne, Marko Šetinc	87
The Carbon Footprint and Sustainable Development of a Company Jure Gramc, Rok Stropnik, Mitja Mori	91
Reducing Carbon Footprint by Changing Energy Systems Drago Papler, Marijan Pogačnik	95
Life Cycle Assessment of Internal Combustion Vehicles, Electric Vehicles and Hydrogen Fuel Cell Vehicles Gašper Gantar	99
Restructuring the Saša Coal Region in Accordance With a Fair Transition Policy Franc Žerdin	103
Vulnerability of Karst Water Sources – Žegnan Spring and Ljubija Tributary (NE Slovenia) Natalija Špeh, Anja Bubik	107
Ecological Remediation of the Šalek Valley: Has it Already Been Completed? Klemen Kotnik, Samar Al Sayegh Petkovšek, Boštjan Pokorny	111
Plastics - A Burden or a Resource for Coastal Ecosystems Natalija Špeh	115
Reasons and Strategies for Reducing Health Risks Due to Pollution by Heavy Metals Resulting from Energy Production Borut Vrščaj	119
Evaluation of the Toxic Potential of Chemicals in Cosmetics Using Computational Toxicology Approach Špela Hvastja, Anja Bubik	123
Adsorption Properties of Geological Materials for CO₂ Storage Tanja Tajnik	127
Estimation of Real Driving Emissions Based on Data From OBD Matej Fike, Andrej Predin	129
RENEWABLE ENERGY, ELECTRICAL MACHINES AND SMART GRIDS	131
Analysis of a Fast Fault Current of Inverter-Interfaced Distributed Generations Boštjan Polajžer, Jernej Černelič	133

The Impact of Unbalanced Power Supply on Load Currents in Transient and Steady State Operation	137
Nina Štumberger, Gorazd Štumberger	
Next Generation Smart Grids (NG-SG) as a Foundation for Introducing New Services in the Energy Industry	139
Matjaž Kolar, Primož Beratanič	
Physical, Geographical, Technical and Economic Potential for Optimal Configuration of Photovoltaic Systems Using a Digital Surface Model	141
Primož Mavsar, Klemen Sredenšek, Sebastijan Seme	
Optimal Scheduling of Hydroelectric Power Plants on the Drava River	143
Sašo Kreslin, Adnan Glotić, Matjaž Eberlinc, Christian Hausleitner, Dominik Hentschel, Miloš Pantoš, Jernej Brglez, Matjaž Večernik, Lado Leskovec, Jernej Otič, Dalibor Kranjčič	
The Energy Self-sufficiency of the Research Facility at the Institute of Energy Technology	147
Nejc Friškovec, Manja Obreza, Klemen Sredenšek, Sebastijan Seme	
Future Trends in Photovoltaics: Hybrid Photovoltaic/Thermal System	149
Klemen Sredenšek, Iztok Brinovar, Gregor Srpčič, Miralem Hadžiselimović, Bojan Štumberger, Amor Chowdhury, Sebastijan Seme	
Static Modelling of Protection Relays in Modern Distribution Networks	151
Marek Höger, Peter Braciník, Michal Reguľa	
Framework for Automated Generation of Photovoltaic Potential Reports for Individual Buildings	155
Bizjak Marko, Uremović Niko, Sukič Primož, Voh Jurček, Štumberger Gorazd, Žalik Borut, Lukač Niko	
Validation of the T6 Temperature Class for an Explosion-proof Induction Motor	159
Gregor Srpčič, Miralem Hadžiselimović, Iztok Brinovar, Klemen Sredenšek, Sebastijan Seme, Bojan Štumberger	
The Possibility of Increasing the Amount of Renewable Energy Sources in the Distribution Network and Loss Reduction Using Active Elements	161
Eva Tratnik, Miloš Beković	
Usage of Active Elements for Providing Appropriate Voltage Profiles and Prevent Overload In Radial Distribution Networks	163
Marko Vodenik, Matej Pintarič, Gorazd Štumberger	
A PMSG Wind Turbine and Energy Storage Systems Featuring Low-voltage Ride-through Coordinated Control	165
Satish Kumar Peddapelli, Sajan Ch	
The Challenges of Charging Fleets of Electric Trucks in the Power System	169
Norina Szander, Péter Bajor	



<EnRe>
energy & responsibility

PLENARY PROCEEDINGS



CHALLENGES OF THE ENERGY TRANSITION IN THE ŠALEŠKA VALLEY

MIHAEL SEKAVČNIK

University of Ljubljana, Faculty of Mechanical Engineering, Ljubljana, Slovenia
mihael.sekavcnik@fs.uni-lj.si

Keywords: coal abandonment, renewable energy sources, district heating, sector-coupling, infrastructure

The EU Commission signed the Green Deal that will address achieving climate neutrality by 2050 and fulfil its international commitments under the Paris Climate Agreement. One of the most important measures in achieving climate neutrality is the abandonment of the use of coal as an energy source, which in Slovenia currently provides more than one third of dispatchable (flexible) electricity and is also a source of district heating in Ljubljana and the Šaleška Valley. Following the closure of the Zasavje mines and the local TET thermal power plant at the end of 2014, as well as the cessation of the use of imported coal in Ljubljana power station (TE-TOL) and the use of natural gas in new combined-cycle units, the Velenje coal mine and coal power plant in the Sostanj power plant (TEŠ) are due to close in 2033. In doing so, the Ministry of Infrastructure and the Šaleška Valley are counting on the possibility of drawing European funds for restructuring of the economy in the region, which is strongly marked by coal and power plant activities. In this study, the authors have left aside the issues relating to the demographic and educational structure of the population in the Šaleška Valley and instead consider some scenarios related to the consequences of such a decision for the valley and wider Slovenia. The fact is that the deficit of electricity and electricity system services coming from TEŠ (from Velenje lignite) will have to be compensated for, possibly by renewable energy sources, which requires a completely new concept of energy supply on both the production and consumption side in the whole of Slovenia. This means huge long-term investments in new energy sector

infrastructure, however, we are living in uncertain times, in which the war in Ukraine has shown in the most cruel way how sensitive the world is when it comes to dependence on energy imports. It is also clear that there is no unity at the EU level when it comes to responding to the Green Deal in the various member states. So, the question arises: How can we make the most meaningful use of the existing energy infrastructure in the Šaleška Valley for the further economic development of the region? At the same time, the need to provide district heating, which heats the entire Šaleška Valley from Velenje, Šoštanj and Topolšica, which is mainly supplied from cogeneration from TEŠ, should not be neglected. There are several 'simple' and popular solutions in the media – such as large heat pumps, a small nuclear reactor, geothermal heat, solar power plants – however, are these just cheap and enjoyable promises for political needs or perhaps the outlines of a new reality? The answers, of course, are never easy nor cheap. In addition to major changes in the entire economic systems, it will be necessary to change many energy-related habits that were also made possible by the energy source from the Velenje underground lignite mine.

QUANTIFYING FAST VOLTAGE VARIATION LEVELS AND PATTERNS

YOUNES MOHAMMADI, MATH H.J. BOLLEN

Luleå University of Technology, Skellefteå, Sweden
younes.mohammadi@ltu.se, math.bollen@ltu.se

Keywords: power quality, fast voltage variations, seeking patterns, unsupervised learning, kernel PCA, time series clustering, post-processing

This study addresses the issue of extracting sub-10-min patterns in fast RMS voltage variations from time-limited measurements at multiple locations worldwide. This is a rarely considered time scale in studies [1-3], however, it is one that could be of relevance for incorrect operation of end-user equipment such as lightning devices [4,5]. Moreover, short-term measurement intervals could be significant from the view of machine learning methods. To learn more about this time scale, the authors of this study propose an unsupervised machine learning method, which is applied to measurements from 57 low-voltage locations in 19 countries throughout the years 2009-2018 (Table 1). Fifteen initial clusters/patterns are then extracted and converted to ten new ones (Figure 1) using a cluster merging strategy with patterns highly similar to those used in the post-processing approach useful for multiple locations. The results, together with the applicable statistical power quality indices, show the effectiveness of the proposed scheme in defining patterns per location. The statistics indices analysis also confirms that both indices (quantifying variations) and the proposed scheme (quantifying levels and patterns) are required for a full picture of sub-10-min oscillations. Moreover, the extracted patterns for every single location (Figure 2) could be used by equipment manufacturers connected to the grid.

Table 1: Measurement dataset from multiple locations per country and type of customer.

Country	No. of measurement locations			No. of 1-s RMS voltage values	Measurement hours	No. of 10-min windows
	Other*	Hotel	Total			
Sweden	16	6	22	3348600	930.2	5581
China		6	6	601800	167.2	1003
Bosnia and Herzegovina		1	1	100200	27.8	167
Austria		3	3	301200	83.7	502
Italy		2	2	200400	55.7	334
Turkey		2	2	201000	55.8	335
Hong Kong		2	2	200400	55.7	334
India	1	2	3	288000	80.0	480
Spain		1	1	100200	27.8	167
Switzerland		2	2	200400	55.7	334
Romania		1	1	100200	27.8	167
Netherland		3	3	295800	82.2	493
Singapore		1	1	100200	27.8	167
Portugal		2	2	200400	55.7	334
Scotland		1	1	100200	27.8	167
United Kingdom		1	1	100200	27.8	167
Ireland		2	2	200400	55.7	334
Slovenia	1		1	100200	27.8	167
Zambia	1		1	100200	27.8	167
Total (19 countries)	19	38	57	6840000	1900	11400

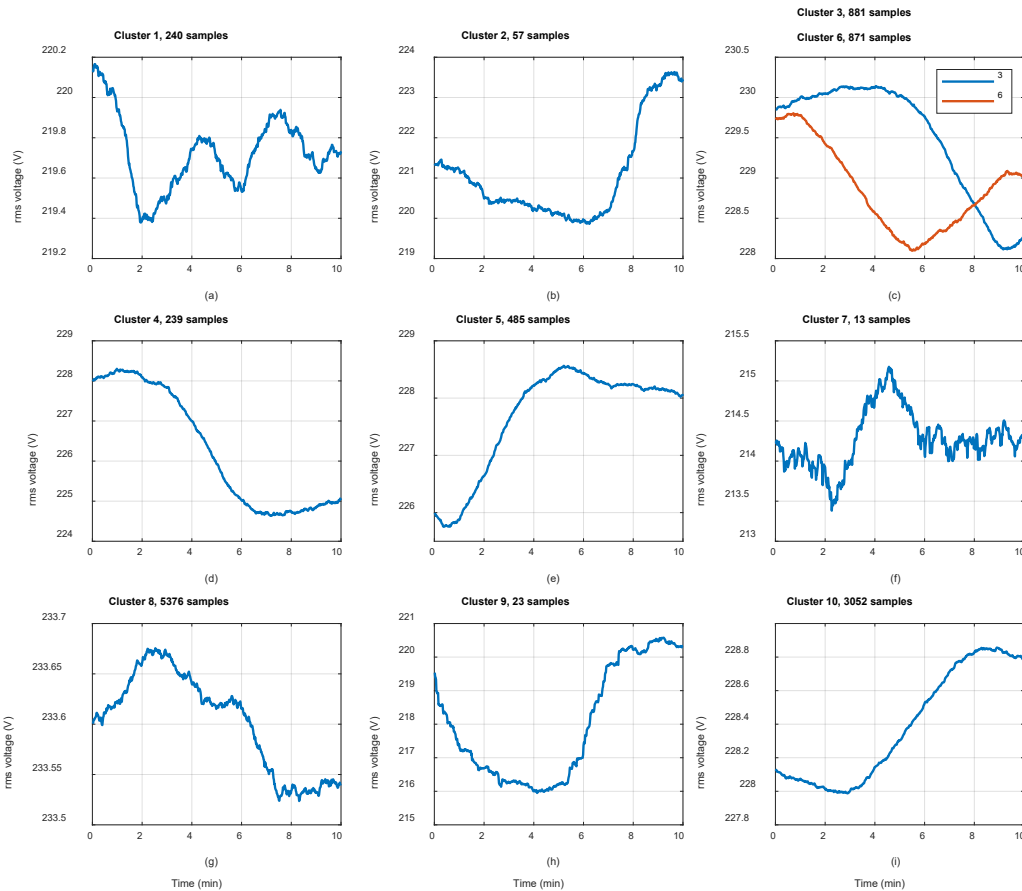
**Figure 1: Reconstructed patterns (cluster centres) including the number of samples belonging to each cluster: (a) Cluster 1 and 7; (b) Cluster 2; (c) Cluster 3 and 6; (d)-(f) Clusters 4-10 respectively.**

Source: own

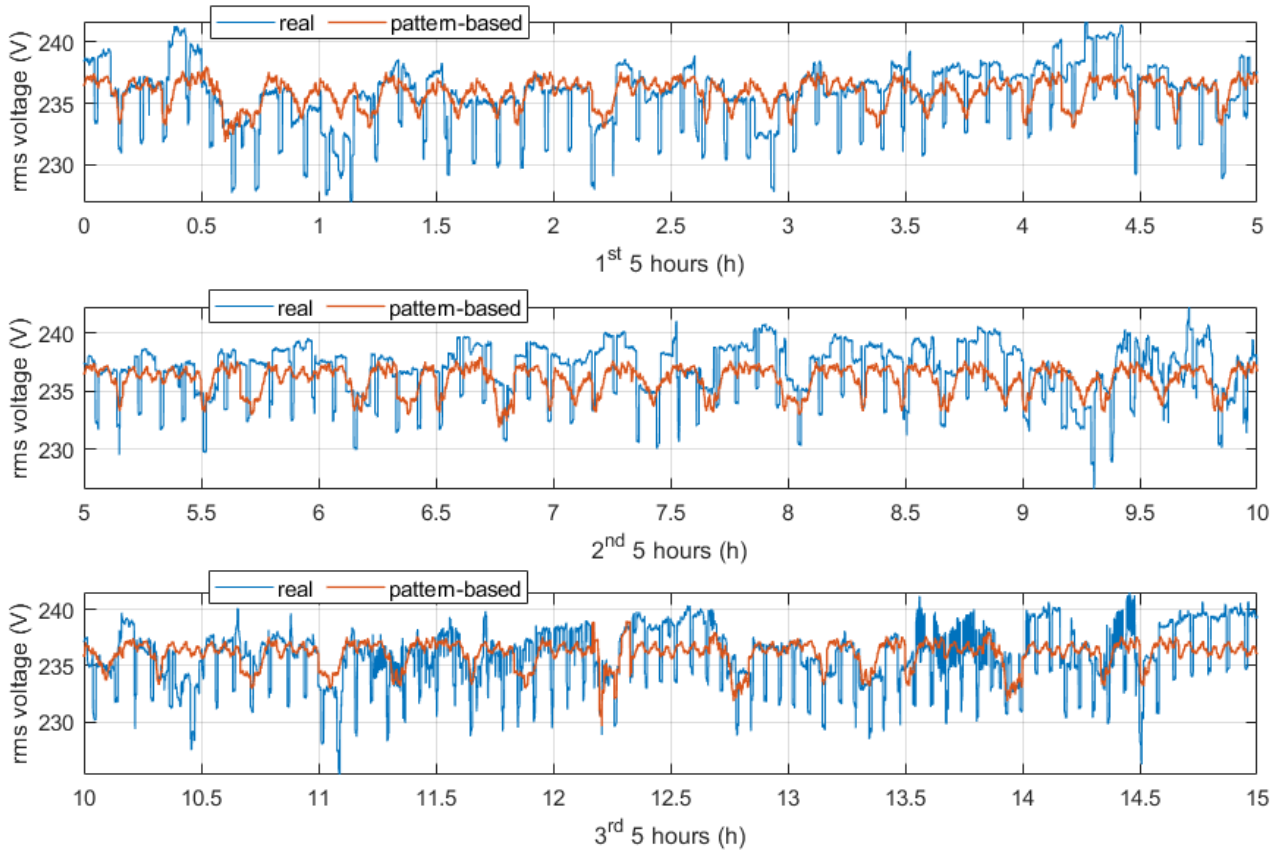

Figure 2: Real and pattern-based RMS voltage for the 1st, 2nd and 3rd 5 hours of the 35h measurements at location 47.

Source: own

References

- [1] Bollen MHJ, Gu IYH. *Signal Processing of Power Quality Disturbances*. 2005.
- [2] Bollen M, Milanović J, Cukalevski N. CIGRE/CIREN JWG C4.112 - Power Quality Monitoring. *Renew Energy Power Qual J* 2014;1,037-45.
- [3] Ge C, Oliveira RA de, Gu IY-H, Bollen MHJ. Deep Feature Clustering for Seeking Patterns in Daily Harmonic Variations. *IEEE Trans Instrum Meas* 2021;70:1-10.
- [4] Gil-de-Castro A, Bollen MHJ, Rönnberg SK. Variations in harmonic voltage at the sub-10-minute time scale. *Electr Power Syst Res* 2021;195:107163.
- [5] Bollen M, de Castro AG, Rönnberg S. Characterization methods and typical levels of variations in rms voltage at the time scale between 1 second and 10 minutes. *Electr Power Syst Res* 2020;184:106322.



<EnRe>
energy & responsibility

ENERGY MANAGEMENT
AND ENGINEERING



ENERGY RENOVATION OF JESENICE HIGH SCHOOL

BOŠTJAN KROŠELJ, ZDRAVKO PRAUNSEIS

University of Maribor, Faculty of Energy Technology, Krško, Slovenia
bostjan.kroselj@student.um.si, zdravko.praunseis@um.si

Keywords: energy renovation, thermal bridge, thermal envelope, heating, ventilation

This paper describes a proposed energy renovation of the worn-out building of Jesenice High School, which is in bad condition. The authors began by evaluating the current state of the building, which has been demonstrated based on energy indicators. The proposed renovation was then run theoretically and the results redisplayed with energy indicators. The paper concludes with a comparison of the results before and after the renovation and an evaluation of the renovation itself.

Current status

Jesenice High School consists of three parts. The main building, together with workshops, was built in 1949. In 1978, a gym was added. As the building is located on a bank, part of the ground floor is dug into the ground. It was found that the building has a net usable area of 7,480m². Of this, 6,934m² of space is heated. The building is heated by thermal energy supplied from the hot water district network. The temperature regime on the primary side is 130/70°C and 90/70°C on the secondary side. Two 356kW heat exchangers are installed between the primary and secondary heating circuits. Electricity is supplied through the public grid. The estimated installed electrical power is 250kW. The cold water supply is through the public network and it is then used mainly as sanitary water, which is prepared centrally within the heating station. The boiler has a capacity of 750 liters. Sanitary water in the toilets on the other floors is prepared in electric water

heaters. The thermal envelope of all three buildings consists of floors, partially excavated walls, exterior walls, doors, windows and roofs. The thermal envelope in all three buildings is in poor condition, as the external walls do not have built-in thermal insulation. Due to unsatisfactory drainage of the workshop roof, the facade is already badly damaged. The roofs of all three buildings are also in poor condition from an energy point of view. Based on the data obtained from the study of the building physics of thermal protection for the Jesenice High School building and with the help of the KI Energija 2014 programme, the authors calculated the energy indicators of the building. From the energy indicators shown, it is evident that the building is in a poor condition energy-wise and is very energy-consuming. The building is classified in the very high F class with 191kWh/m² of annual heat demand.

After renovation

Energy accounting could be used to monitor the use of energy and other energy or ecological indicators in a building. Since larger deviations of energy consumption values can be determined from the average, it is possible to determine the causes more quickly. This provides an insight into the condition of the building and systems at all times, thus allowing the determination of any urgent measures. The authors of this paper suggest a contact façade for the school, in which 18cm-thick thermal insulation made of expanded polystyrene is installed. When calculating the thickness of thermal insulation, it is necessary to take into account the requirements of the *Ekosklad* fund. In the event of a public tender, the school can apply for a grant from the fund. The condition is that the thermal conductivity of the insulation is $\lambda \leq 0.045$ (W/mK) or it can be smaller provided that $\lambda/d \leq 0.25$ (W/mK) (calculated by 1.1).

$$\frac{\lambda}{d} = \frac{0,039}{0,18} = 0,2167 \quad (1.1)$$

A thermal bridge is an area on a building where the envelope has the highest thermal conductivity. These areas are the result of improper construction and poor or deficient insulation performance. As the heat in these places passes more easily from the building to the surroundings, the surface at the exit point thus cools down. This causes moisture condensation and mould to form. The facilities have many thermal bridges and need to be tackled individually. Solutions for individual details must be implemented so that the thermal bridges will have the lowest possible value in the calculation of heat losses. Thermostatic valves with a flow regulator and pressure regulator must be installed in the

heating system. This method allows the heated water to be properly distributed throughout the heating system, resulting in energy savings of up to 35%. Hydraulic balancing of the heating system is also required for the better functioning of the radiators. Hot-water ceiling radiators are installed in the gym and workshops. The effect of ceiling radiation can be compared to the sun, which heats the air and objects near the floor. In terms of the need for ventilation, it is necessary to install a mechanical plant in the attic, which will be used for ventilation and air conditioning. An inlet-outlet device with a built-in heat pump and a waste heat recovery efficiency of around 90% would be used. All ventilation systems are equipped with automatic regulation, and modern fans with continuous speed or airflow adjustment are installed. Renewable energy sources would be included in the energy renovation. As part of the renovation of the roofs of all three buildings, the installation of photovoltaic modules made of polycrystalline solar cells is planned. Heat pumps are installed to prepare sanitary water, where the heat of the surroundings will be used.

Condition after renovation

As can be seen in Table 1 below, the energy class would improve significantly following renovation, from F to B1, with the heat required to heat 25kWh/m² per year. Table 1 shows the energy indicators before and after the renovation.

Table 1: Energy indicators before and after the proposed energy renovation

Energy indicators	Before	After
Energy class	F	B1
Heat required for heating (kWh/m ² a)	191	25
Energy supplied for the building (kWh/m ² a)	258	71
Primary energy (kWh/m ² a)	330	136
CO ₂ (kg/m ² a)	88	31
H'(t) (W/m ² K)	1,089	0,327

Conclusion

The implemented measures would result in all three buildings becoming more energy efficient and the amount of district heat consumed would reduce. Sanitary water for the needs of the school, gym and workshop would be prepared with the help of heat pumps, which fully utilise the heat of the environment. A solar power plant with a peak power of 330kW would be installed on the roof of the school and gym. It is calculated that the building will recoup the entire investment in just over 20 years. From an energy point of view, the planned renovation would be very successful.

Notes

Table 2: Nomenclature

(Symbols)	(Symbol meaning)
<i>m</i>	meter
<i>°C</i>	degrees Celsius
<i>W</i>	Watt
<i>h</i>	hour
<i>l</i>	liter
<i>K</i>	Kelvin
<i>kg</i>	kilo

References

- [1] Krošelj, Boštjan. (2019). Energy renovation of Jesenice high school: Master's thesis, Faculty of Energy Technology, University of Maribor, Krško, Slovenia.

REDUCING CARBON FOOTPRINT IN AN OEM SUPPLY CHAIN CAUSED BY INADEQUATE INTERPRETATION OF X-RAY RESULTS OF HIDDEN DEFECTS IN DUCTILE IRON CASTINGS

TADEJ PAVLIN, IZTOK BRINOVAR, BOJAN STERGAR, ZDRAVKO PRAUNSEIS

University of Maribor, Faculty of Energy Technology, Krško, Slovenia

tadej.pavlin@livar.si, iztok.brinovar1@um.si, bojan.stergar@um.si, zdravko.praunseis@um.si

Keywords: carbon footprint, ductile iron, X-ray inspection, cutting inspection, hidden mistakes, defects, porosity, inclusion, green energy, reduced production of energy, decrease in production emissions.

In the global market, the casting or foundry industry recorded a growth trend for ductile iron last year. Ductile iron is used due to its excellent mechanical properties, machinability and castability. The microstructure of nodular cast iron consists of a metal matrix and graphite extruded in beads and nodules. In recent years, the production of ductile iron castings has increased significantly for parts for heavy transport vehicles and containers for permanent disposal of nuclear waste, and it is expected that this trend of expansion will continue for at least the next twenty years. It is common knowledge in the casting industry that the current method of pouring in the form of sand means that the quality of products is never 100%. There can be defects on the raw surface and/or on the machining surface, as well as hidden defects inside the material. For casting products, defects can be detected on raw and machining surfaces and inside material defects by carrying out a visual inspection. The results of the inspection depend on the inspection method used. In general, basic methods of cutting or turning inspection are used in the casting industry, which means that products are classified in terms of whether or not they meet the drawing specification(s). The authors of this study focused on the hidden defects inside ductile

iron material, which can be detected by carrying out a cutting or milling inspection or through an X-ray inspection.

Why better detection of porosity can affect energy consumption

To reduce energy consumption in manufacturing processes, there is a lot of low-hanging fruit ready to pick in most industrial sectors, such as newer and more efficient equipment, insulation on buildings, using LEDs, more effective logistics, etc. However, the casting industry needs so much metal heating that this low-hanging fruit barely affects total energy consumption. In addition, anyone can grab this low-hanging fruit, while addressing internal defects on casting is much harder to address than switching off a monitor left on stand by, requiring years of engineering education in metallurgy, years of experience and a good brainstorming team. The reduction of defective parts is the most effective measure to reduce energy consumption but also the most challenging to address [1-4].

Why have casting defects become harder to address

The Original Equipment Manufacturing (OEM) supply chain has changed dramatically since the 1970s when automotive manufacturers and other large OEMs closed their own core processes into massive outsourcing and offshoring of labour-intensive casting and machining processes. There were advantages to this new paradigm as it allowed process optimisations to develop a new ecosystem of the specialised supply chain, niche companies, lower waste, faster R&D and lower costs. There are, however, some downsides [1, 3]. On the flipside, the carbon footprint of transporting parts increased and, even worse, dealing with non-conformant products became a challenge. The machining site is no longer within minutes of the foundry, where casted parts with porosity could simply be recast and replaced by a new casting. There were no accounts of KPIs and PPMs in the middle of the last century, only the memory of engineers who have since retired [1, 5]. While since the 19th and 20th centuries foundries were located in a building or just minutes and meters away from the machining sites of shipyards [6]. Dealing with rejects on casting has thus become a slow and time-consuming activity, ranging from being a nuisance to being problematic. One of the root causes of the increase in casting defects relates to the distance from design to casting, as 'Design for Manufacturing' needs good know-how and communication with the supplier, which is often not the case. On the quality side, the ISO 9000 quality management standard was established in 1987 with guidelines intended to increase business efficiency and customer satisfaction. Due to the

need for quality assurance in the automotive sector, QS 9000 was established in 1992, lead by Ford, General Motors and Chrysler in the US [4].

However, the automotive sector is not the most problematic sector in terms of casting defects, due to its batches, it is easier to achieve optimal conditions via trial and error than to monitor control and ensure casting process parameters [1]. Other sectors followed the automotive trend of offshoring and requiring specific quality systems. The second wave was aerospace and in 1998, US aerospace contractors established 9000 based on ISO 9000. For the third wave, Europe created the International Rail Industry Standards (IRIS) in 2005 [3, 6-8]. These waves correlate with some major changes in the casting sector landscape. Increasing quality demands and a reduction in business volume hit the automotive sector. The reduction of time from concept to serial and increased product customisation presents another challenge for foundries by creating a 'high mix, low volume' of parts. Lower quantities of batches also challenge casting optimisation [6,8] as well as distant 'Design for Manufacturing', smaller batches, and the technical challenges of detecting internal porosity. This becomes more necessary for critical safety components and difficult when even x-ray inspection is ineffective [1-8].

Conclusion

In recent years, many successful companies have been investing in reducing energy consumption and carbon footprint in all primary and secondary product manufacturing processes. Every step counts, since energy consumption can be drastically reduced by using proper planning process inspection methods in the casting industry.

Successful and leading corporations worldwide are joining the EcoVadis tool programme, thanks to its unified and standardised networking and comparison and introduction of good practice across organisations. The EcoVadis methodology for assessing a company's sustainability management systems is based on international standards such as the Global Reporting Index (GRI), ISO 26000 and the guiding principles of the Global Compact.

Notes**Table 2: Nomenclature**

(Symbols)	(Symbol meaning)
<i>t</i>	time
<i>X-ray</i>	Radiographic testing inspection
<i>GRI</i>	Global Reporting Index
<i>OEM</i>	Original equipment manufacturer

References

- [1] V. Anjos, Use of Thermal Analysis to Control the Solidification Morphology of Nodular Cast Irons and Reduce Feeding Needs, doctoral dissertation, Lisbon, Portugal, 2015
- [2] Ecovadis <https://support.ecovadis.com/hc/en-us/articles/115002653188-What-is-the-EcoVadis-assessment-process->, accessed date: 01.04.2022.
- [3] S. F. Fischer, A. Bührig-Polaczek, J. Brachmann, P. Weiß, Influence of nickel and cobalt on microstructure of silicon solution strengthened ductile iron, Materials Science and Technology, 31 Germany, 2015
- [4] C. H. Hsu, M. L. Chen and C. J. Hu, Microstructure and mechanical properties of 4% cobalt and nickel alloyed ductile irons, Materials Science and Engineering A 444.
- [5] R. Elliott: Cast Iron Technology, Butterworths, London, 1988
- [6] J. Zhou, Colour Metallography of Cast Iron, Spheroidal graphite Cast Iron - Part I, China Foundry, 2010.
- [7] Engineering choice - <https://www.engineeringchoice.com/radiography-testing/>, accessed: 31.03.2022.
- [8] L. Magnusson Aberg, C. Hartung, J. Lacaze, Trace elements and the control limits in ductile iron, 10th International Symposium on the Science and Processing of Cast Iron – SPCI10, Argentina, Mar del Plata, 2014.

CREATING AND ENABLING ENVIRONMENTS FOR MICROGRIDS SUPPORTING COLLECTIVE ENERGY MEASURES – FROM STATUS QUO TO A MICROGRID-FRIENDLY POLICY ENVIRONMENT LESSONS FROM A SLOVENIAN PILOT PROJECT IN THE MUNICIPALITY OF SELNICA OB DRAVI

TOMAŽ ROBIČ

Energy agency of Podravje (Energap) - Institution for sustainable energy use, Maribor, Slovenia
tomaz.robic@energap.si

Keywords: microgrids, energy communities, renewable energy, transnational policy environment, pilot site, microgrid model, energy and climate policy package

The aim of the ALPGRIDS project, which comprises seven pilot projects in Austria, France, Germany, Italy and Slovenia, is to increase the uptake of renewable energy sources (RES) in alpine regions. The pilot projects involve the deployment of microgrids: small-scale energy systems that can operate autonomously or be connected to the main grid. These systems group together RES producers and consumers and enable communities to generate renewable energy locally, thus reducing the risk of blackouts – a big problem in the Alps – and price volatility.

ALPGRIDS is developing a common understanding of microgrids and their benefits with a view to creating a transnational policy environment that favours the adoption of microgrid solutions, particularly local energy communities.

The project builds on six existing pilot sites to formulate an alpine microgrid model, an energy and climate policy package and a programme for replicating the model in the Alps and beyond. The process is supported by transnational activities such as workshops, site visits, summer schools and bilateral exchanges.

MICROGRIDS increase energy consumers' autonomy by enabling them to buy electricity from local producers at reasonable prices and make electricity networks more resilient in the event of emergencies. Further benefits include a reduction in electricity losses, a decrease in infrastructure costs and more opportunities for introducing new services.

The Slovenian ALPGRIDS project is carrying out a feasibility study for a microgrid connecting the municipal offices, a school, a nursery, a cultural centre and the fire station in Selnica ob Dravi. The school and possibly the fire station could serve as producers and users and the other buildings solely as users.

THE SEISMIC MONITORING SYSTEM IN THE VELENJE MINE AND PREVENTIVE ROCK BURST MEASURES

JANEZ ROŠER,¹ JANEZ MAYER,² MARKO ES,¹ DARIAN BOŽIČ¹

¹ Premogovnik Velenje, d. o. o., Velenje, Slovenia
janez.roser@rlv.si, marko.es@rlv.si, darian.bozic@rlv.si

² Alma Mater Europaea – ECM, Maribor, Slovenia
janez.mayer@almamater.si

Keywords: seismic monitoring system, rock bursts, seismic events, preventive measures, Velenje lignite mine

The Velenje lignite mine (Premogovnik Velenje) is located in Slovenia and has a mining level depth of around 40m to 150m below sea level. Lignite deposits are characterised by a high amount of enclosed methane gas, which can be released suddenly during the mining process. This poses great danger for the miners due to explosions, rock falls, bursting of walls or ejection of particles. In the past, rock bursts highly obstructed the reliability of coal production and the time plans for developing roadways. Since October 2016 a reengineered, extended seismic monitoring system has been established in the Velenje mine with newly developed receivers. The newly installed sensors can be used in a potentially explosive atmosphere.

A basic monitoring system was installed in 1998 to obtain information on the locations of rock falls or endangered areas. It was established with eight acceleration sensors in the underground and one 1D seismometer on the surface. The transient recorder from 1998 was a 16-bit data logger with a limited capacity of storage and time accuracy. Due to the sensors used (accelerometers were the only ex-proof sensors at that time) and the aging

process of the components, the sensitivity of this system was not sufficient, therefore a decision was taken to update the system.

In October 2016, a seismic monitoring system was installed and operated in a test phase. Since November 2016, the monitoring system has been operating with its eight 1D seismometer stations.

The system consists of two seismometers (velocity-proportional sensors) at the ground surface and six seismometers (velocity-proportional sensors) in different cavern fields at a depth of approximately 400 metres. The underground sensors are placed in a casing in horizontal boreholes. The L-10B/Ex sensors in the mine were produced by K-UTECH AG and have IBEXU15ATEX1131X permission. Therefore, the sensors can be used in a potentially explosive atmosphere.

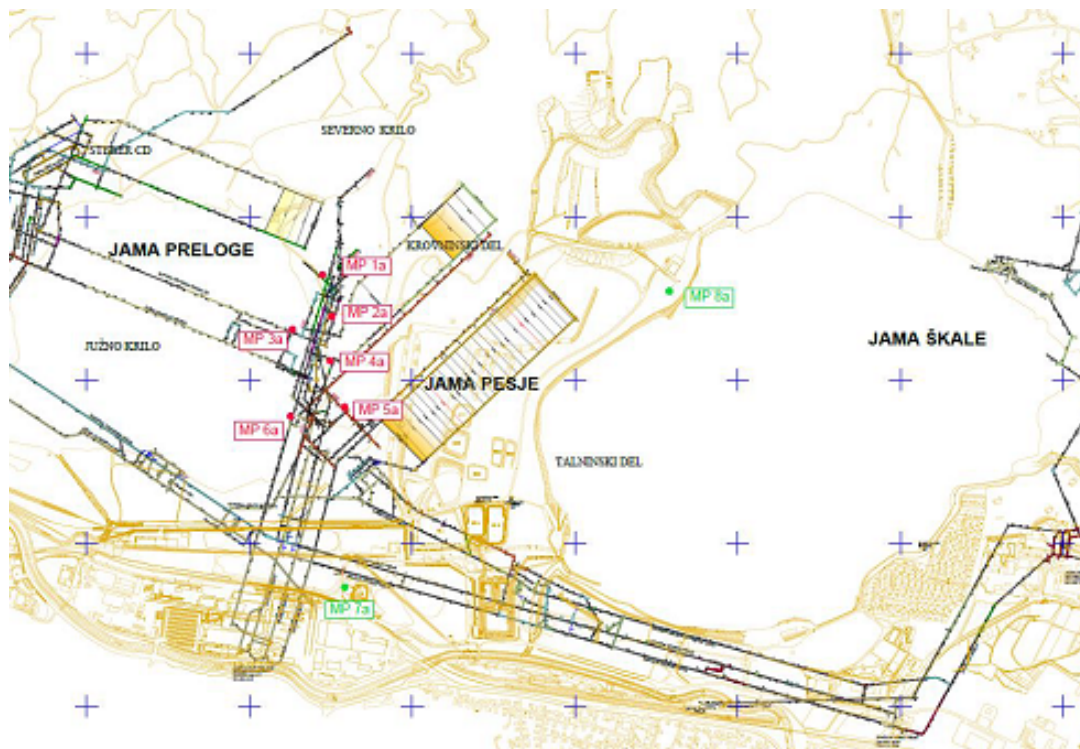

Figure 1: Map of seismic stations

Source: own.

Specially adapted borehole probes are used for installation in horizontal boreholes. During the latest sensor replacement, a 3D printed probe with a diameter of 150mm was used that was designed and developed at the Velenje lignite mine. The probe enables the mechanical coupling of the sensors. The data of the sensors are transferred by a modulation unit and cables to the central measuring unit.

One digital registration unit (KutecGeoLog data recorder) is installed at the surface in the maintenance building. The signals from all the locations of the seismometer cableways lead to the data recorder. For data transfer, modulation units and demodulation units are used. These components modulate and boost the signals. The signals are then demodulated again at the registration unit.

In the first year following installation, 3,348 seismic events were recorded and localised. Thereafter, there were five months without monitoring and after that, in the year 2018, there were 1,239 events, followed by 3,220 in the year 2019, 2,296 in the year 2020, 1,899 in the year 2021 and 935 in the year 2022 so far.

In addition to the location and number of seismic events, the power and the energy released are a criterion for the evaluation of the seismic activity. The energy release is calculated from the magnitude of each event using a relation of the Gutenberg-Richter law. In the first year (from November 2016 to September 2017), a huge amount of energy totalling 2,800 MJ was released. This meant enormous stress was placed on the geomechanical stability of the mine. In the following years, the energy released slowly declined – 123 MJ of energy was released in 2018, 486 MJ in 2019, 2.2 GJ in 2020, 171 MJ in 2021 and 15.6 MJ in the year 2022 so far.

It must be highlighted at this point that monitoring started in November 2016 and continued until the end of September 2017 before restarting in March 2018. Therefore, the statistics for years 2016, 2017 and 2018 are not complete, as is the case for the current year which is still in progress.

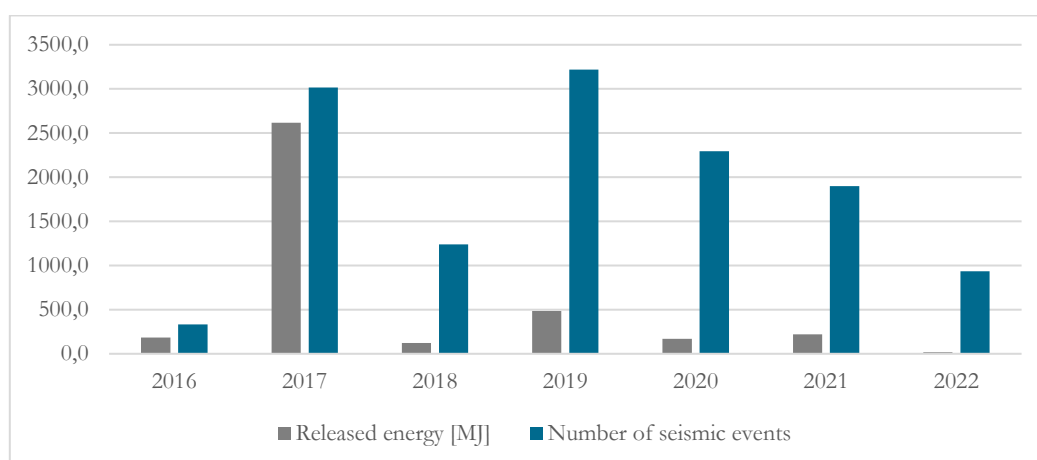

Figure 2: Graphical presentation of seismic events and energy released through the years

Source: own.

Over the years, the number of events has been slowly decreasing, and the same is happening with the energy released, albeit even more significantly. The decreased numbers result from systematic preventive measures in appropriate places and have become an important part of the Velenje mine safety monitoring system. Implementation of systematic preventive safety and production measures has significantly increased reliability.

From the acquired database, there is a notable connection between the location of the mining face, coal production and the frequency and strength of the seismic events. It is necessary to continue monitoring seismic events, collect more data, reduce the danger from rock bursts and improve the safety of mining operations.

SELF-SUFFICIENT RENEWABLE ENERGY SUPPLY FOR MILITARY SITES – RESHUB PROJECT

BOŠTJAN DROBNIČ,¹ ROBERT ŠIPEC,² TOMAŽ KATRAŠNIK,¹
URBAN ŽVAR BAŠKOVIČ,¹ MITJA MORI¹

¹ University of Ljubljana, Faculty of Mechanical Engineering, Ljubljana, Slovenia

bostjan.drobnic@fs.uni-lj.si, tomaz.katrasnik@fs.uni-lj.si, urban.zvar-baskovic@fs.uni-lj.si, mitja.mori@fs.uni-lj.si

² Republic of Slovenia, Ministry of Defence, Ljubljana, Slovenia

robert.sipec@gov.si

Keywords: renewable energy supply, P2X, hydrogen technologies, carbon footprint, military site

Adequate and reliable energy supply is crucial at all levels of human activities – from single households to entire geographic regions. Three types of energy consumption – heat, electricity, and transport – are usually considered separately, however, due to innovative technologies they are becoming more interconnected. Furthermore, with the increasing awareness of environmental protection, energy supply is moving from traditional fossil fuel-based to renewable and sustainable energy sources. The latter, however, inherently require energy storage facilities that provide a buffer between the independent dynamics of energy supply and energy consumption. This requires a new approach to designing energy systems, especially when autonomous operation of an energy system is expected or required.

Military sites – energy systems with specific requirements

Military sites can also be considered as energy systems with specific requirements for different types of energy consumption and specific operational constraints. While during normal operation a military site can rely on external sources of energy (utility grid, district heating, fuel supply), its energy system should be capable of autonomous operation in

critical situations when external sources are unavailable, e.g. natural disasters or even military aggression.

A military site situated in Slovenia was analysed in terms of energy consumption and potential on-site energy production. Simulations of different scenarios with renewable and hydrogen technologies were considered to find optimal system topology that provide sufficient energy supply for the system, system performance with different operating strategies and the carbon footprint of the system.

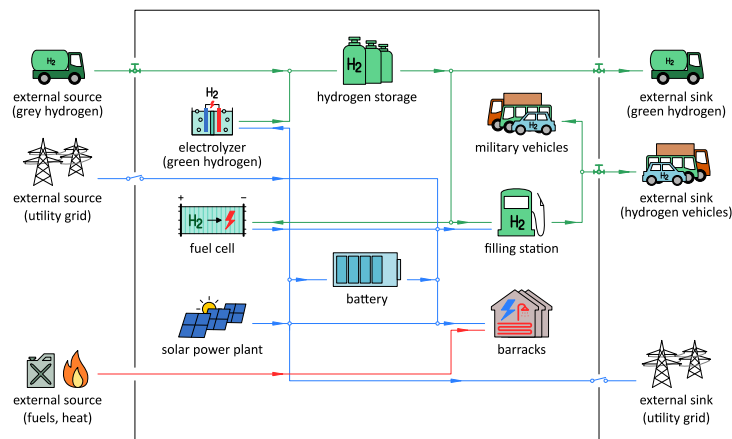

Figure 1: General system topology and energy flows through the system

Source: own.

All the energy, electricity, heat and fuel consumed are currently supplied from external sources, however, these will gradually be replaced by locally available renewable sources. The only feasible renewable source for the analysed case was solar energy. Therefore, the energy system (Figure 1) is based on a solar power plant for the production of electric energy and an electrolyser for converting electricity to hydrogen for energy storage and as fuel for vehicles. The heat is still provided from external sources (LPG and fuel oil).

Numerical modelling of feasible energy balance scenarios

A mathematical model was developed to calculate the electric energy and hydrogen mass balances of the entire system. The energy supply system must provide enough hydrogen for transportation purposes for on-site and external consumers. Different combinations of the size of the solar power plant (45,000m², 15,000m², 12,000m²) and the nominal power of the electrolyser (500kWe, 750kWe, 1,000kWe) were found that meet the requirements. Three scenarios were applied to each of the three topologies with three priority areas: i) maximum sale of electricity sale; ii) maximum sale of hydrogen; iii)

maximum self-sufficiency. The results are illustrated in Figure 2, where a notably larger amount of solar energy is produced in the scenario with the 500kWe electrolyser and 45,000m² solar power plant (denoted with 500) than the other two topologies. Consequentially, a large amount of electricity is available for sale regardless of the operating strategy. The smaller the solar plant, the less electricity is sent to the grid, and at the same time more energy needs to be provided from the grid. Less energy is also available for the grid in cases where hydrogen production is a priority (denoted with H2), however, more hydrogen is available for sale in these cases.

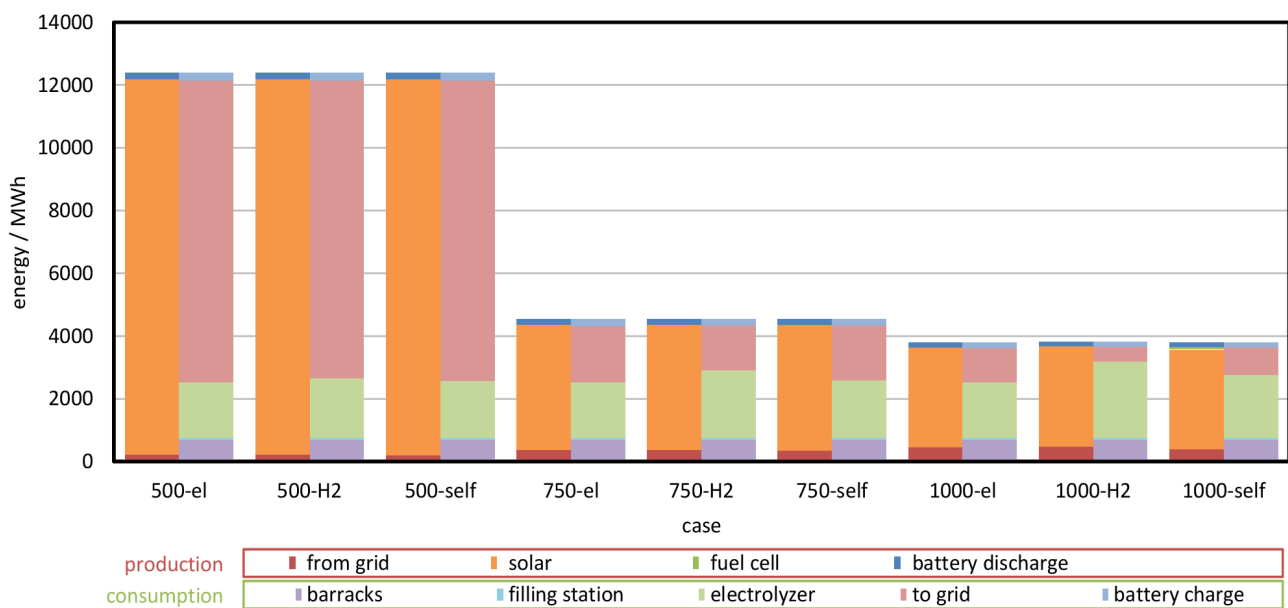

Figure 2: Energy production and consumption for three topologies with three scenarios ('case' describes the capacity of the electrolyser and the scenario, el = electricity sale, H2 = hydrogen sale, self = self-sufficiency)

Source: own.

Figure 3 illustrates the carbon footprint of two topologies (500kWe and 1,000kWe electrolyser power). Topology 1 is electricity production-oriented with a 500kW unit electrolyser and 45,000m² of solar panels. This results in a large amount of electricity and a small amount of hydrogen surplus available for sale. This represents an avoided carbon footprint for a military site, i.e. a negative carbon footprint (represents the 'computational' carbon sink in Slovenia).

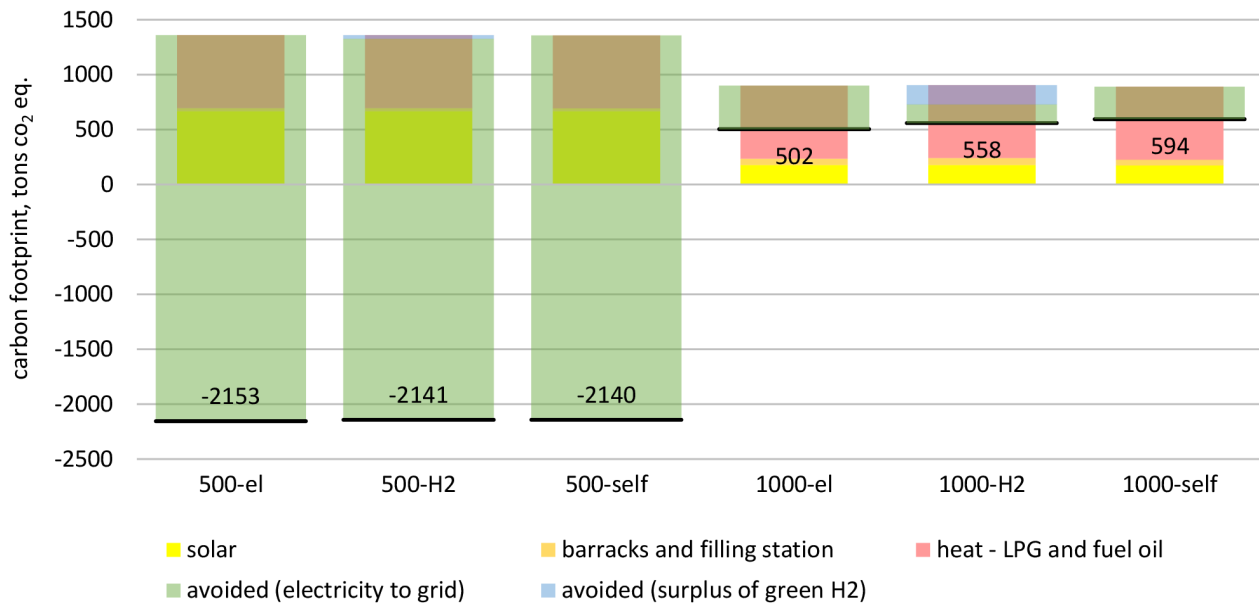

Figure 3: Environmental impact in terms of carbon footprint for topologies with a 500kW and 1,000kW electrolyser (el = electricity sale, H2 = hydrogen sale, self = self-sufficiency)

Source: own.

Conclusions

The analyses show that supplying an appropriate quantity of hydrogen is possible with an adequately sized renewable energy system. Heat, fuel and electricity from external sources as well as electricity from solar power plants all result in a positive carbon footprint. Requirements demand that the local energy supply system must be significantly oversized, however, the surplus energy can be distributed to external consumers and can replace non-renewable energy sources, e.g. electricity from the grid mix and grey hydrogen. This effectively reduces the overall carbon footprint and may also result in negative values, which means that the system is not only carbon-neutral, but also reduces the carbon footprint of a larger-scale system.

UTILISING THE ENERGY OF DISCHARGED MINING WATER USING A HEAT PUMP

ROLANDO KOREN, JANEZ ROŠER

Premogovnik Velenje d.o.o., Velenje, Slovenia
rolando.koren@rlv.si, janez.roser@rlv.si

Keywords: coal mining, heat pumps, greenhouse gases, mine water, water pumps, heating

In 2018, the European Commission presented its vision of a climate-neutral EU. The goal is to make the EU climate neutral in the economy by 2050 with zero net greenhouse gas emissions. This global climate action is at the heart of the Green Agreement under the Paris Agreement. In 2020, the Slovenian Ministry of Infrastructure issued the National Strategy for a Coal Exit and the Restructuring of Coal Regions in Line with Just Transition Principles, defining 2033 as the year by which the coal phaseout would be complete and the Premogovnik Velenje (hereinafter: PV) coal mine will be closed. Future-oriented thinking is beginning to raise questions about how to make usage of abandoned mine roadways and shafts, as the PV coal mine is currently the largest construction site in Slovenia with more than 50km of underground roads/facilities.

Water accumulates in the mine and must be regularly pumped to the surface in order to produce coal, otherwise there is a risk of water intruding into workplaces where lives and property are in danger. In addition, this causes wetting of rocks, a deterioration in working conditions due to increased humidity in the mine, a reduction in strength properties, and an increase in swelling of hills due to wetting of coal. The water enters the mine in different ways; from the aquifer insulation layers above the coal, part of the water is brought to the mine by miners, as it is used in the technological process of excavation, and a large part of the water flows into the mine from the so-called Triada, which was purposely drilled. The

water from the Triada is used in the aforementioned technological process, and a large part is intended for lowering the water pressure in the aquifer so that it can be excavated in areas exposed to thinner insulation layers. There are three pumping stations in use at the PV coal mine; a main pumping station on k.-43.5 (3 x HK 150-200 x 7, $P = 315\text{kW}$, $Q = 2.5\text{m}^3/\text{min}$, $H = 410\text{m}$), an auxiliary pumping station on k.-130 (3 x LHK 125-180 x 4, $P = 90\text{kW}$, $Q = 2.5\text{m}^3/\text{min}$, $H = 90\text{m}$) with two pools with a capacity of $1,500\text{m}^3$, and a collection swamp on k.-161 (Flygt, $P = 9\text{kW}$, $H = 31\text{m}$). Annually, approximately 1.2 million m^3 of wastewater is pumped from the mine. It makes sense to take advantage of the energy and constant flow of mine water with the help of a heat pump.

Pumping the water

Mine water is not pumped to the surface constantly. The system is adjusted so that the pumps start when the sensors detect an elevated water level in the reservoirs at the lowest point of the coal mine. The pumps run until the water level falls below the minimum amount of water in wastewater reservoirs. The pumping station on k.-41.5 is the only one of interest for the calculations. Three pumps are installed in this pumping station, but they never pump all at once (a maximum of two at a time; prevention of increased wear). On average, pumping is done five times a day, and each pumping takes about 3 hours and 40 minutes.

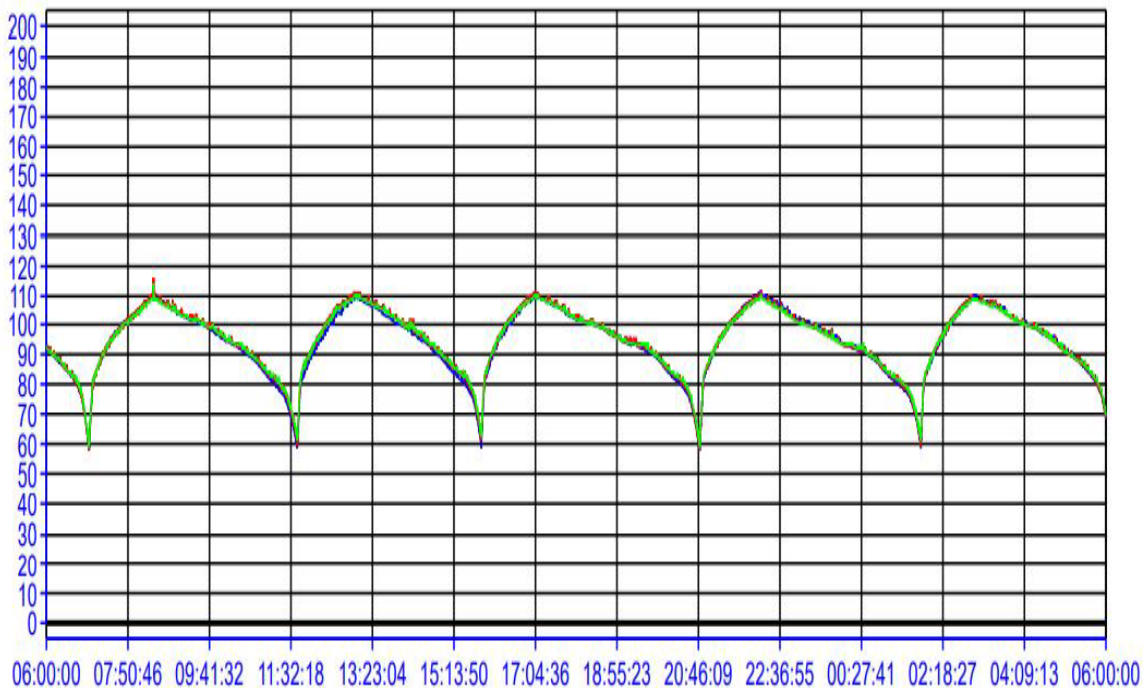

Figure 1: Pumping sequence on k.-41.5

Source: own.

Use of a heat pump on a wastewater system (location, choice of heat pump, calculation)

A heat pump (hereinafter referred to as HP) is a device that, with the help of electricity or another drive device, takes heat energy from the air, earth or water and adheres it to the air or water used for heating. There are several types of HP. For the purposes of this study, the authors have suggested the use of a monovalent water/water HP. The location of the HP must be close to the exit of the wastewater line (the main NOP shaft), or near the NOP administrative building. Depending on the flow during the operation of the pumps on k.-41.5 (approx. 200m³/h, temp. 20-21°C), the Vitocal 350-G Pro HP was chosen, which provides water at a temperature of 73°C on the secondary part. To achieve this, on the primary part, a water temperature of at least 20°C and a flow of 63.6m³/h is required.



Figure 2: Location of the HP

Source: own.

The heating value of this HP is 3.07. Depending on the guaranteed flow, three HPs could be installed that would be parallelly connected. The equation of the standard calculation of the heating number $COP = Q_h/P_{el}$ was used to calculate the heating power of the HP. The total heating power (heat removal from mining water) is $Q_h = 849.3\text{kW}$. On the basis of the discharge of water into the sewage system, $\Delta T = 3.53^\circ\text{C}$ or 17.65% was calculated, which does not pose a danger to the environment.

The PV uses a hot water pipeline from the Šoštanj thermal power plant to heat the mine in winter (the airflow into the mine is heated). The current connected power is 5.9MW. If three HPs were installed, 849.3kW would be obtained during the operation of the pumps in the pumping station on k.-43. The daily average power of the HP was calculated according to the operating time of the pumps in the pumping station on k.-41.5 (75% of the day); $\bar{Q}_{sk}, H = 636.975\text{kW}$; in winter 0.6MW of heat would be generated with the help of the HP for the purpose of heating the incoming air into the mine. The connected power could be reduced to 5.3MW. The calculated savings at the current price of the connected power is EUR 1,734.18/month. The mine air is currently heated according to the outside air temperature (outside temp.). The current heating system is set to start whenever the outside temperature is below 8°C for three consecutive days. In recent years, the mine air has been heated for 4 to 5 months. According to data, the annual savings are estimated at EUR 8,671. The estimated value of the entire investment is EUR 400,000. In the event that 50% co-financing or grants are applied, a payback period of 23 years has been calculated. Of course, the HP system could also be used for another purpose, i.e. for heating the water used by miners for bathing. In that case, the payback period would be much lower.

The matter will be even more interesting after the completion of coal mining at PV. Parts of the mine would be flooded to store a sufficient amount of geothermal energy, thus creating an accumulation suitable for the use of large HP to heat nearby settlements (for example, Mieres, Spain). A similar idea was realised by the Hunosa Group, which also owns an abandoned coal mine. The investment itself reached a value of EUR 1,500,000 (EUR 500,000 in grants). The estimated payback period of this project is 8 years, and the annual return of the HP to the company is EUR 120,000.

RFCS METHENERGY+ PROJECT METHANE RECOVERY AND HARNESSING FOR ENERGY AND CHEMICAL USES AT COAL MINE SITES

MATJAZ KAMENIK, JANEZ ROŠER

Premogovnik Velenje d.o.o., Velenje, Slovenia
matjaz.kamenik@rlv.si, janez.rosler@rlv.si

Keywords: ventilation air methane, abandoned mine methane, coal mining, methane recovery and harnessing, thermal or chemical upgrading, adsorption-based technologies, materials development, thermal and catalytic regenerative oxidisers, methanol, greenhouse gases

The Premogovnik Velenje (PV) coal mine cooperated in the EU METHENERGY+ project, cofounded by the Research Programme for Coal and Steel (RFCS). The RFCS is an EU-funded programme that supports research projects in the coal and steel sectors. It is funded via the revenues generated by the European Coal and Steel Community (ECSC) from liquidation assets, which are exclusively devoted to research in the coal and steel industry sectors.

The project title and subject is 'Methane recovery and harnessing for energy and chemical uses at coal mine sites'. The project took place from 2017 to 2020 and was coordinated by the University of Oviedo in Spain in the scope of an international consortium of eleven entities from Poland, Spain, the United Kingdom, Czechia, Greece, Slovenia and Sweden, combining universities, research institutions and industry (mostly Polish and Slovenian coal mines). The main challenge tackled by the project was the usage of methane released

from operating and abandoned mines (VAM¹ and AMM²) which is an environmental and safety hazard and a useful energy resource. Therefore, an assessment was made of the effective extraction, enrichment, purification and separation of methane, as well as its thermal or chemical upgrading and its use taking into account the specifics of coal mines site. The scope of the project was:

- 1) Optimisation of methane recovery (methane concentration and flow rate) at operating and flooded coal mines, considering the geological and operational features of the shafts.
- 2) Development of adsorption-based technologies for concentrating methane from VAM and AMM emissions, including the development of materials and process design and simulation. Different approaches were used to prepare the potential adsorbents, including the development of high-performance tailored materials or the use of waste materials from other processes as adsorbents.
- 3) Development of a membrane-based technology for the separation of methane from VAM and AMM emissions, including the development of perm-selective membranes using nanostructured materials and the modelling and simulation of these units on an industrial scale.
- 4) Exploration of the possibility of using thermal and catalytic regenerative oxidisers for the efficient and environmentally-safe combustion of these emissions (with and without previous methane enrichment).
- 5) Explore the possibility of transforming the methane contained in the studied emissions (with or without further enrichment) into other valuable chemicals, such as methanol or hydrogen.
- 6) Evaluation of the application of the above technologies for methane enrichment and utilisation, both in operating mines and in mines where coal mining activity has ceased.

The work carried out in the project work packages (WPs) was as follows:

WP1: Determination of the key properties of the mines that determine the methane desorption during mine flooding. Modelling the flooding of abandoned mines and predicting methane flows during operation and flooding of the mines.

¹ VAM – Ventilation air methane

² AMM - Abandoned mine methane

WP2: Preparation and testing of different materials as methane adsorbents (templated carbon materials, MOFs³, fly-ash derived zeolites, etc.). Modelling of adsorption isotherms and the kinetics of the adsorption processes. Proposal of adsorption configurations (mainly temperature swing adsorption). Development of codes for simulation of adsorption units. Selection of materials and safety studies.

WP3: Selection of materials for methane-selective membranes. Optimisation of the preparation of hydride ceramic-MOF membranes. Testing of the materials at lab scale. Development of a rigorous model for predicting methane separation from VAM using membranes.

WP4: Environmental and safety studies. Selection of materials. Operation of combustors with AMM.

WP5. Development of catalysts (Cu-loaded acid zeolites) for performing selective methane oxidation to methanol. Testing of the materials in a fixed-bed reactor (cyclic mode) and optimisation of the different steps of the process (methane adsorption, methanol desorption, catalyst regeneration). Preliminary design and economic evaluation.

WP6: Systematic comparison of methods used for methane draining from mine sites, methane concentration strategies and upgrading procedures. Development of an investor guide for the implementation of upgrading approaches considering the three stages. Design of the upgrading of VAM emission integrated approaches considering both methane concentration and thermal upgrading. An integrated temperature swing adsorption process with thermal regenerative combustion or a gas turbine was considered. Depending on the results obtained in the other WPs, the resulting approach combined concentration steps, methane extraction procedures, combustion devices and chemical reactors [1].

As there are several mining companies involved, different technical solutions were offered depending on the characteristics of each mine site. Among the studied approaches, combining an adsorption process and a gas turbine seems the most attractive approach for future implementation. This project proposes a combination of three strategies to solve this significant problem:

³ Metal-organic framework

- 1) Optimise the ventilation procedures to get the highest CH₄ concentrations extractable under safe conditions. This activity has been extended to abandoned and flooded mines to achieve higher methane concentrations.
- 2) The development of procedures for concentrating the methane in these emissions. The most promising technologies are those based on adsorption and membrane technologies.
- 3) Study of combustion and chemical transformation technologies in the presence of oxygen. In previous research, it has been observed that flow reversal combustors provide the best performance for the combustion of these emissions, however, several underexplored aspects remain, such as the environmental effects, the control strategies and integration with the overall energy management system of the plant.

The project was executed through wide dissemination and exploitation of results. It should be noted that an important part of the results was published. In terms of the industrial exploitation of the results, an in-depth deep study of the methane release during mine operation and flooding would be very beneficial in designing ventilation systems. For example, the planning of the next fan stations and ventilation systems for underground mines could be explored in future considerations of the findings of this project.

References

- [1] METHENERGY+. Universidad de Oviedo. <http://www.unioviado.es/METHENERGY/>, 2022

TRANSITION MANAGEMENT VS JUST TRANSITION. THE PLACE-BASED GOVERNANCE PERSPECTIVE IN WESTERN MACEDONIA, GREECE

LEFTERIS TOPALOGLOU,¹ DIMITRIS THEODORIDIS²

¹ University of Thessaly, Volos, Greece

ltopaloglou@lga.gr

² Regional Association of Local Governments of Western Macedonia, Kozani, Greece

dtheodoridis@peddm.gov.gr

Keywords: just transition, place-based governance, spatial justice, social justice

This paper attempts to examine to what extent the governance modes of transition in the region of Western Macedonia (Greece) are effective and just, and whether they embed transition management, spatial justice, and place-based elements. To this end, the hypothesis tested in this paper is that spatial justice and place-based policy can make a positive contribution to just and well-managed transition. In this framework, the question examined is not about ‘who is in charge for designing and implementing transition policies?’, but about ‘what is the balance and mix of transition policies at the central, regional, and local levels of administration?’. The article critically discusses the concept of transition as a fundamental societal change through the lens of efficiency and justice. Thus, the notions of transition management and spatial justice are thoroughly explored. It also embeds the concept of ‘place’ in this discussion. Therefore, the challenges, opportunities, and shortcomings of the place-based approach in the course of transition are examined. The empirical section contains a particular field research with questionnaires completed by experts about the region of Western Macedonia in Greece are presented and discussed. Given that transition implies a profound and long-lasting societal, economic, and

environmental transformation, new and pioneering modes of governance are necessary to tackle such a multifaceted challenge. The discourse about place, policies, and governance, reveals the need for focusing on balance and mix of inclusive and multi-scalar policies instead of defining governance structures and bodies in charge for implementing transition policies. The launched transition governance model in Greece considerably deviates from the EU policy context (see Figure 1). In fact, substantial shortcomings in terms of legitimacy, inclusiveness, and public engagement and overall effectiveness have been recorded. The empirical evidence reveals a rather clear top-down model than a hybrid one. The findings show that the governance model employed in the case of Western Macedonia, neither embeds spatial justice nor incorporates a place-based approach. Viewing the long-term process of transition through the lens of governance and policymaking, this paper challenges the assertion that the traditional top-down governance model is the most effective and fair approach. In this setting, the notions of transition management and spatial justice are thoroughly explored. The concept of 'place' is also embedded in this discussion. To this end, the challenges, opportunities and shortcomings of the place-based approach are analysed. Given that transition is by nature a multifaceted, multi-level and multi-actor process, an effective and just transition governance, should reflect the views of different actors. In this sense, it seems that multi-level governance models for regions in transition need to harness existing interactions among different levels and actors.

After having touched upon the process of transition regarding the notions of 'management' and 'justice', the concepts of spatial justice and the place-based approach are embedded into governance transition practices. In this respect, the gap between, efficiency and equity, redistributive logic (needs, results), and development policy (inclusive development) can be bridged through the so-called 'spatial-territorial capital' and spatially just multi-level governance.

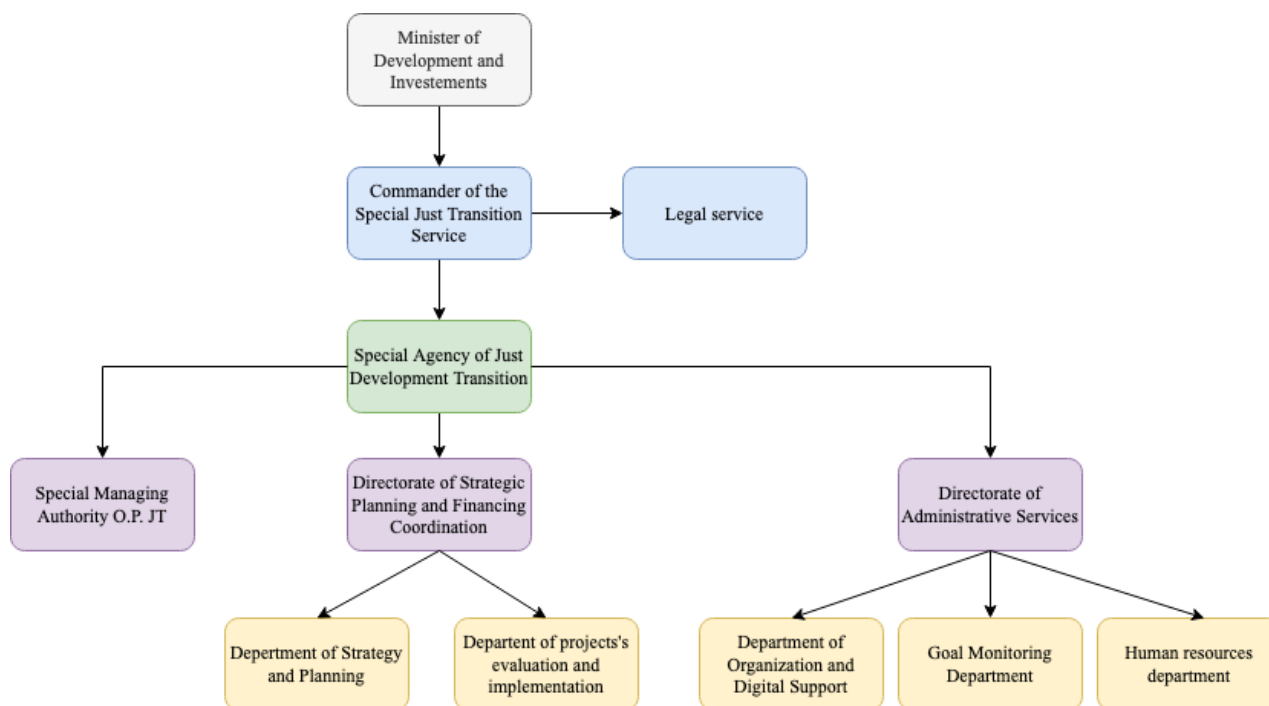

Figure 1: The structure of Special Body for Coordination of Just Transition

Source: Law 4872/10-12-2021, diagram elaborated by authors

Acknowledgements

A major part of these research paper has been developed within the context of the *Decarb Project* <https://projects2014-2020.interregurope.eu/decarb/> of the INTERREG EUROPE Programme

GREEN WALLS: AN ECO-FRIENDLY SYSTEM FOR ACHIEVING ENERGY EFFICIENCY IN BUILDINGS

DEJAN TASIĆ, AMOR CHOWDHURY, DALIBOR IGREC

University of Maribor, Faculty of Energy Technology, Krško, Slovenia
dejan.tasic@student.um.si, amor.chowdhury@um.si, dalibor.igrec@um.si

Keywords: energy efficiency, green wall, heat losses, modelling

Population growth and an ever-increasing demand for energy are redirecting people to start using energy more wisely and efficiently. In order to reduce greenhouse gas emissions, people have become aware that not only is it essential to reduce the usage of fossil fuels and switch to renewable energy sources but also to change the way energy is perceived and used. Changing a living habitat to a better sustainable place has become a significant issue in a global aspect. Since there is no doubt that sustainable energy and efficient use of energy are the future of preserving our planet, there are solutions to help tackle such matters. Turning our homes into energy-efficient habitats that immensely reduce the usage of energy, thus becoming energy efficient, has attracted the attention of the European Union (EU), which now heavily invests in such sectors. The term energy efficiency is already broadly used in Slovenia and, due to various directives, the country has committed to increasing the percentage of energy-efficient buildings in the short-term future. There are several ways to emphasise the benefits of energy efficiency and there are different areas where energy efficiency can be applied.

Green walls are described as vertical structures (gardens) that have various types of plants or other greenery attached to them. Plants are planted in a growth medium that consists of stone, water and soil. A built-in irrigation system is featured in a green wall for sustaining living greenery. It can improve the energy efficiency of buildings in cities, where it is vital to reduce energy consumption, hence they count as a sustainable technology that

acts as a natural insulation system. Irrigation system also improve the urban climate (reducing the surface temperature of buildings, urban air temperature, regulating CO₂ concentration), and improve air and water quality. In addition to good thermal and acoustic performance, they also serve as a great aesthetic structure, which helps to diversify the city landscape. There are also disadvantages such as intensive maintenance due to the vegetation and a need for a durable supporting construction [1]. While green walls are almost non-existent in Slovenia, there are already significant efforts being made in countries with large urban areas, such as Japan and Singapore, especially because of large heat island phenomena and high humidity.

The proposed model [2] (building wall) is a theoretical approach with the same dimensions (surface area of 25m²) in each cardinal direction (north, south, east and west) and is not based on a structure of a real, present-time case. The location of the 'structure' was set in Maribor, Slovenia (the location is important for assessing values such as solar radiation and external air temperature). Different types of main wall assemblies were set as examples: an energy-efficient wall (highly energy-efficient masonry with thermal insulation – Type A), a highly energy-inefficient wall (old masonry with no thermal insulation – Type B) and an energy-inefficient wall (concrete with some thermal insulation – Type C).

The simulation models should only be considered as a simple interpretation of calculating heat losses through such wall assemblies, since more complex calculations would require computations for a real-time practical case. The calculation of the reduction in CO₂ emissions relates to the aforementioned annual heat losses. The assessment of the models was based on mathematical predetermined terms only, nonetheless, these models serve as good analytical research base for exploring such matters in an area of an innovative approach to energy efficiency.

Through the simulations, the authors concluded that the heat losses for each type of wall would indeed decrease on an annual level, if each type had a green wall installed in front of the main wall. Based on the results, it can also be assumed that the more energy-inefficient the wall is, the more appropriate it is to install a vertical green wall in front of it. However, the green wall cannot be a 'layer' that could single-handedly solve the problem of energy inefficiency of assembly of the main wall. In terms of CO₂ emissions, the calculations showed that such emissions would decrease drastically.

References

- [1] F. Convertino, G. Vox, E. Schettini: *Heat transfer mechanisms in vertical green systems and energy balance equations*, International Journal of Design & Nature and Ecodynamics, vol. 14, No.1, January 2019, p.p.7-18
- [2] D. Tasić: *Analytical modelling of achieving energy efficiency with green walls*, Master's thesis. University of Maribor, Faculty of Energy Technology, 2019

A HYBRID MODEL FOR PREDICTING SURFACE SUBSIDENCE ABOVE UNDERGROUND EXCAVATION

ANDREJ PAL,¹ JANEZ ROŠER²

¹ University of Ljubljana, Faculty of Natural Sciences and Engineering, Ljubljana, Slovenia
andrej.pal@ntf.uni-lj.si

² Premogovnik Velenje d.o.o., Velenje, Slovenia
janez.roser@rlv.si

Keywords: underground excavation, subsidence prediction, fitted plane, centroid, modified sigmoid

Mining is essential to modern life, providing the raw materials on which modern society is based and which are critical to the pursuit of the sustainable development goals. To meet the growing demand for minerals, the scale of mining activity in many countries is steadily increasing, with exploitation taking place at ever greater depths and using ever more productive mining methods [1]. The effects of underground mining are reflected on the surface in large vertical deformations (subsidence) that cause damage to facilities within and in the wider vicinity of the mining area. Awareness of the importance of protecting both the environment and surface facilities has led to increased research in ground subsidence prediction in recent decades [2].

Subsidence prediction models vary widely because of differences in excavation methods and the specifics of individual mineral deposits [3]. The objective of this research was to develop a hybrid prediction model that combines several proven solutions and allows prediction of subsidence for any point within the observation area, regardless of the monitoring method chosen.

To predict the subsidence of any point, the statistical approach was used of fitting the modified sigmoid function in Eq. 1.1 [4] to the subsidence data obtained by continuous monitoring.

$$f(t) = a + \frac{b-a}{2} \left(1 + \frac{\frac{t-p}{s}}{\sqrt{1 + \left(\frac{t-p}{s}\right)^2}} \right) \quad (1.1)$$

This type of prediction is based on the evaluation of accuracy, prediction of the time of the next term measurement (next epoch), and the time of final subsidence or consolidation when further subsidence is negligible, and the last measurement (final epoch) can be made. By dividing the mining influence area into rectangular sectors, with each sector containing a cloud of points and a plane that matches those points, the forecast can be implemented in any monitoring scheme. Since each fitted plane is defined by four vertices with a centre point (centroid) representing all influences within the sector, and the height of the centroids varies between different epochs while their plane coordinates are constant, the calculated heights can be used as input data for fitting the modified sigmoid function.

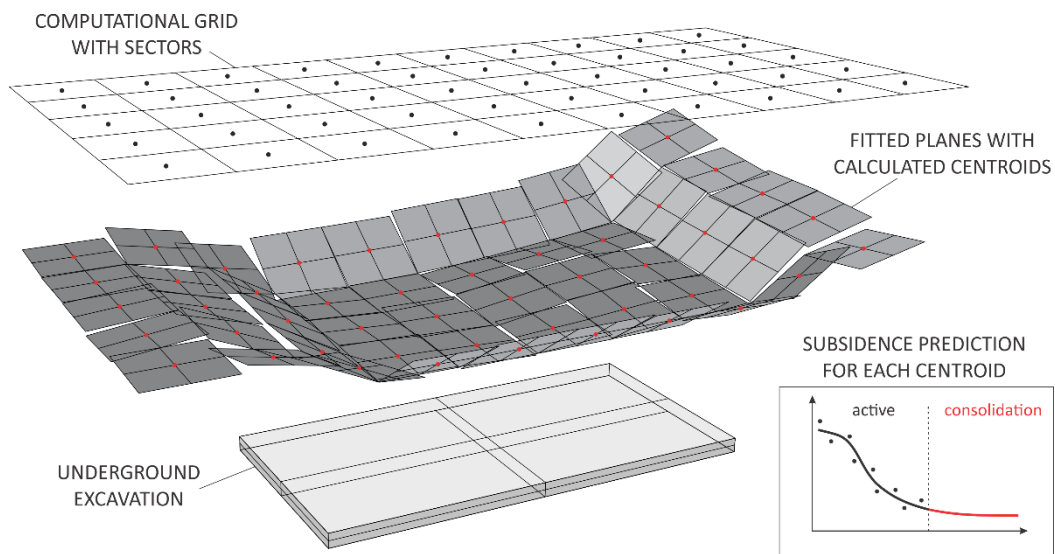

Figure 1: The concept of the hybrid model for predicting surface subsidence above underground excavation.

Source: own.

The hybrid model, which includes a sigmoid model, a computational grid with sectors and a comparison of scanned terrain point clouds, helps optimise the remediation of damaged terrain above underground excavation. this was achieved through timely detection of intensive subsidence areas and classification of computational grid sectors. The model was

successfully verified on the measured subsidence of the area within the active mining area of the Velenje coal mine. The authors found that the proposed novel method is a good basis for predicting surface subsidence for which conventional monitoring is not available, and that it allows future measurements to be adjusted to the predicted subsidence dynamics, which is time and cost efficient.

Notes

Table 1: Nomenclature

(Symbols)	(Symbol meaning)
a	upper asymptote
b	point of influence
p	point of influence
s	abscise scale parameter
t	time variable

References

- [1] Dubiński, Józef, 2013, *Sustainable development of mining mineral resources*, Journal of Sustainable Mining, vol. 12(1): pp.1-6.
- [2] Whittaker, B. N.; Reddish, D. J. 1989. *Subsidence: occurrence, prediction, and control*. Elsevier Science & Technologystr.
- [3] Bahuguna, P. P.; Srivastava, A. M. C.; Saxena, N. C. 1991. *A critical review of mine subsidence prediction methods*. Mining science & technology, vol. 3(3): pp.369-382.
- [4] Rošer, J.; Potočnik, D.; Vulić, M. 2018. *Analysis of dynamic surface subsidence at the underground coal mining site in Velenje, Slovenia through modified sigmoidal function*. Minerals, vol. 8(2): pp.74-87.

USE OF REMOTE SENSING METHODS FOR THE PLANNING, DESIGN AND MONITORING OF THE VELENJE COAL MINE ENVIRONMENT

ALEŠ LAMOT, JANEZ ROŠER²

Premogovnik Velenje d.o.o., Velenje, Slovenia
ales.lamot@rlv.si, janez.roser@rlv.si

Keywords: remote sensing, LiDAR, aerophotogrammetry, point cloud, laser scanner, mobile mapping, mining, monitoring, design

Mines need a monitoring system in many places to improve the rehabilitation of the mining area and to manage and enhance safety as well as the environment. The main aim of this paper is first to describe remote sensing methods, then to introduce the use of remote sensing technologies in the field of mining at the Velenje Coal Mine.

Remote sensing technology is widely used in surveying and mapping and building mapping as well as in mining, detection of earth resources, monitoring of environmental pollution and in the fields of metallurgy, geology, agriculture, forestry, water conservancy, weather, oceans, etc. [1]. During the rehabilitation process of a mining area, evidence-based assessments are required by state law. Using remote sensing methods can help to provide evidence that rehabilitation works are in progress, have been completed, and are of the quality required and in the planned scope [2]. As a part of monitoring the movements, deformations and state of terrain in the wider area of the Velenje Coal Mine, measurements were carried out with remote sensing technologies using aerophotogrammetry and airborne LiDAR (*Light Detection and Ranging*) scanning. The main results of these measurements are a georeferenced digital orthophoto image digital photograph map and a georeferenced point cloud obtained from LiDAR surveys, from

which it is possible to model the 3D state of the terrain and determine the state and surface changes in the mining area [3].

With the development of advanced tools in the field of spatial laser measurement, sufficiently accurate mobile hand-held laser scanners are now available, where scanning takes place dynamically, e.g. during movement, without the need for stationary stands and support points. That latter proved to be a great advantage in capturing the spatial clouds of points of buildings in the pit of the Velenje Coal Mine. In the first phase of using a mobile handheld scanner, the results are mainly used for visualisation and rough dimension measurements in the obtained 3D point clouds, while in second phase they are used as point clouds for design, redesign and control [4].

The use of remote sensing in the mining industry is on the rise as it offers the possibility of use in various engineering fields. Surveying methods of large areas as well as underground mine facilities using remote sensing technologies combined with corresponding computer programmes already outperform traditional surveying methods. Using drones to observe mining areas and handheld mobile scanners shortens measurement time and consequently reduces costs and increases productivity. The Velenje Coal Mine uses drones for surveying the mining area to produce 3D models of terrain and mobile scanners to produce 3D models of underground objects. Thus, drones are used to detect subsidence caused by mining, to calculate the volume status of the coal depot, to calculate the volume of subsidence, and to calculate the quantities in the preparation of the subsided terrain and in the aftermath of mining. Mobile scanners are used to determine the state of buildings and underground facilities, and 3D models are used for control and design in mining and civil engineering.

References

- [1] Tamrat Mekonnen, Dr. Bedru Hussien: *Application of Remote Sensing in Mining*, Global Scientific Journals, Volume 9, issue 8, august 2021.
- [2] Sebeom Park, Yosoon Choi: *Applications of Unmanned Aerial Vehicles in Mining from Exploration to Reclamation: A Review*, Minerals, MDPI, 2020.
- [3] Drago Potočnik, Aleš Lamot, Janez Rošer, Milivoj Vulić: *Subsidence monitoring above longwall "-80c" of Velenje Coal Mine using various surveying methods*, 6th International Symposium MINING AND ENVIRONMENTAL PROTECTION, Vrdnik, Serbia, 2017.
- [4] Janez Rošer, Aleš Lamot: *Applying unmanned aerial vehicle – drone in Mining industry*, 13th Mining, Geotechnology and Environment Scientific Conference at "45th jump over the leather", Ljubljana, Slovenija, 2017.

JUST TRANSITION AND THE NEED FOR MONITORING AND ASSESSING MECHANISMS

DIONYSIOS GIANNAKOPOULOS,¹ DIMITRIS MAVROMATIDIS,²
LEFTERIS TOPALOGLOU³

¹ The Centre for Research and Technology, Thessaloníki, Greece
d.giannakopoulos@certh.gr

² Regional Development Fund of Western Macedonia, Kozani, Greece
mavromatidis@gmail.com

³ University of Thessaly, Volos, Greece
ltopaloglou@lga.gr

Keywords: just transition, monitoring mechanisms, observatory, governance

The primary aim of the European Green Deal is to move towards climate neutrality in a socially just and inclusive way. To this end, the EU has set up the so-called 'Just Transition Mechanism' (JTM), which will provide funding and technical assistance to the regions of the EU most affected by the transition to a green economy. However, in addition to securing sufficient resources and providing technical assistance for their utilisation, a key factor for the successful outcome of the transition in coal dependent regions is its governance mechanism and the engagement of the public/citizens. This term refers to the various ways in which different actors and stakeholders engaged in and influenced by the transition work together to achieve the collective goal.

Recent texts of European cohesion strategies make it clear that the new feature of the new European regional policy and the new NSRFs focuses on a place-based governance approach. This reflects a departure of European politics from horizontal and one-size-fits-all policies. This is done for two reasons, which are: (a) the utilisation of local knowledge and local territorial capital deals better with problems, and (b) the transfer of the level of decision-making and implementation of policies as close as possible to the citizens to whom they concern. The territorial approach to governance envisages a strong

role for local communities (not necessarily the central one) and strong synergies of the three levels of government. In addition, it seeks to enhance the effectiveness as well as the legitimacy of policies in the perception of citizens who suffer the consequences of their success or failure.

An effective governance model, however, should be accompanied by an effective mechanism for scientifically monitoring, analysing, evaluating and formulating substantiated policy proposals. In the context of setting up and operating a Just Transition Observatory, it could be a valuable support mechanism, providing it has the presumption of multi-level expertise and objectivity, deep knowledge of local specificities and legitimacy to institutionally represent the public interest at the local level. In practice, the observatory could function as an independent evaluation body (with periodic reports or focused studies) of the course of the energy transition programmes, identifying potential difficulties, recording the impacts, results and outcomes and providing policy recommendations. The observatory will systematically publish periodic reports and ex-post evaluations based on predefined indicators. In addition, the observatory will be able to take networking initiatives to national and international levels, thus mobilising scientific debate and scientific thinking on issues related to fair transition through conferences, workshops, discussion papers, etc.

Given that just transition plans include a number of important transformational policies and transformational plans, the crucial question that arises is whether regional and central policy makers have the tools to evaluate these transformational policies and transformative projects. In this regard, it is necessary to design evaluation models based on predefined indicators and criteria that will be jointly defined in the context of public consultation. This will ensure the objectivity on the basis of commonly agreed indicators and objectives on the one hand, while on the other, the legitimacy and acceptance of both strategic policies and specific investment plans.

This paper attempts to examine to what extent there is room for the establishment of Just Transition Observatory Platforms along the coal dependent areas. More specifically, it explores the potential of such a mechanism to monitor, analyse and evaluate the clean energy transition and provide robust policy recommendations. To this end, Just Transition Observatories will operate as an independent evaluation mechanism producing evidence-based reports and studies on the clean energy transition. On this basis, the observatories will be able to deliver periodic reports, based on indicators, comparative analysis and policy recommendations. In addition, such mechanisms could enhance networking at EU, national and local levels, thus mobilising scientific dialogue and debate on the clean energy transition.

ANALYSIS OF ENERGY EFFICIENCY AND ENERGY RENOVATION MEASURES OF A SINGLE UNIT HOUSE

IZTOK BRINOVAR, TILÉN SINKOVIČ, MIRALEM HADŽISELIMOVIĆ,
BOJAN ŠTUMBERGER, GREGOR SRPČIČ, KLEMEN SREDENŠEK,
SEBASTIJAN SEME, ZDRAVKO PRAUNSEIS

University of Maribor, Faculty of Energy Technology, Krško, Slovenia
iztok.brinovar@um.si, tilen.sinkovic@student.um.si, miralem.h@um.si, bojan.stumberger@um.si, grega.srpcic@um.si,
klemen.sredensek@um.si, sebastijan.seme@um.si, zdravko.praunseis@um.si

Keywords: energy efficiency indicators, energy renovation, thermography, thermal transmittance

Energy efficiency of buildings is an important element of the European Union (EU) climate and energy policy and is crucial for sustainable development and climate protection. According to statistics, the building sector is responsible for almost 40% of total energy consumption and more than 36% of CO₂ emissions in the EU [1,2]. A large share of buildings in Slovenia and other European countries are over 40 years old and most of them are energy inefficient. Therefore, the renovation of existing buildings has a significant energy saving potential, thus it is necessary to correctly calculate the energy savings that can be obtained in a renovation project.

This paper covers an analysis of energy efficiency and energy renovation measures of a single-unit house in Slovenia. The correct data collection, the main variables that affect consumption, and people's usage habits are fundamental elements in an energy renovation project of a building. The energy efficiency assessment was carried out on the basis of a systematic approach. A proper energy audit was carried out in order to properly evaluate

the energy performance of the building. The thermal properties of the envelope of a building strongly affect its annual energy requirements, therefore the building envelope was also inspected using a thermal imaging camera. Additionally, the thermal transmittance (U) of the building envelope was determined on the basis of in-situ measurements, as thermal transmittance is crucial in heat loss calculations. Thermal transmittance can be determined using various methods as shown in [3], and it is necessary to understand the requirements, advantages and limitations of each. The thermometric method (THM) was used to determine thermal transmittance. The criteria for installing the temperature probes are shown in Figure 1a, while the measurement results for determination of thermal transmittance are shown in Figure 1b.

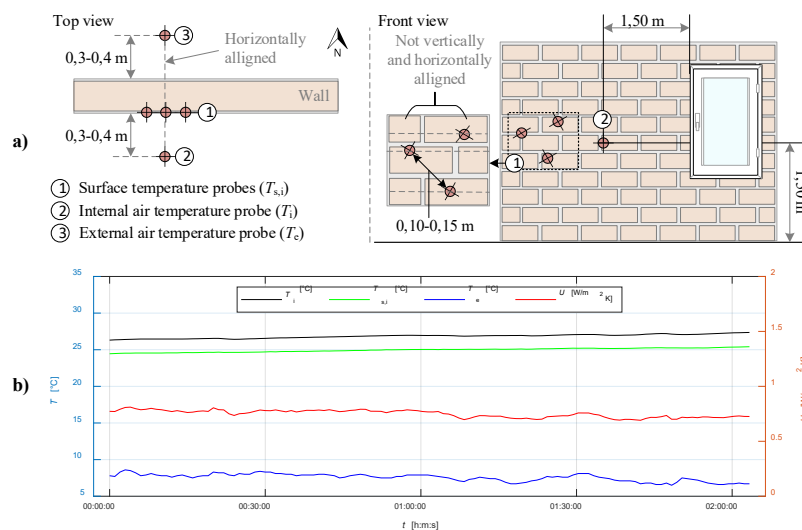

Figure 1: a) Criteria for mounting the temperature probes, b) Measurement results
Source: own.

Based on the data collected data and the measurements performed, an analysis was performed of the energy efficiency and energy renovation measures. The calculation of the energy efficiency indicators and annual energy use was carried out in accordance with SIST EN ISO 13790:2008, PURES 2010 and technical guideline TSG-1-004.

References

- [1] Azizi S., Nair G., Olofsson T.: *Adoption of Energy Efficiency Measures in Renovation of Single-Family Houses: A Comparative Approach*, Energies, p.p.1-16, 2020.
- [2] Artola I., Rademaekers K., Williams R., Yearwood J.: *Boosting Building Renovation: What Potential and Value for Europe?*, Study for ITRE Committee, 2016.
- [3] Bienvenido-Huertas D., Moyano J., Marin D., Fresco-Contreras R.: *Review of in situ methods for assessing the thermal transmittance of walls*, Energies, p.p.356-371, 2019.



<EnRe>
energy & responsibility

APPLIED ENERGY AND
ALTERNATIVE HYDROGEN
TECHNOLOGIES



METHOD OF BEST AVAILABLE TECHNOLOGY AND THE LOW-CARBON FUTURE OF COMBINED HEAT AND POWER PLANTS

DUŠAN STRUŠNIK, MARKO AGREŽ

Energetika Ljubljana d.o.o., TE-TOL Unit, Ljubljana, Slovenia
dusan.strusnik@gmail.com, marko.agrez@energetika.si

Keywords: alternative facilities, best available technology, combined plant, heat recovery, hydrogen, low carbon, methanisation, natural gas, steam recovery

The low-carbon development strategy and ecological awareness of combined heat and power (CHP) plants is the key factor that enables further development of such systems. CHP plants are subject to rigid European ecological guidelines, which dictate the pace of development of global thermal power engineering. For this purpose, the European Union issued a special directive for the promotion of heat and power cogeneration, which is established using the best available technology (*BAT*) method. Even though the production of electricity using carbon-free technologies is on the rise, the production of electricity using fossil fuel combustion cannot be completely avoided. The significance of the operation of CHP plants is particularly reflected in the provision of tertiary services to the electric power system as well as regulation of network frequency, particularly in winter months when electricity production using carbon-free technologies is limited. In CHP systems, the low-carbon future is intricately linked to high investment costs, which impact the final price of energy. Using the *BAT* method, this article describes the advantages of energy production in CHP plants, and provides an example of the restructuring of a larger CHP system into a low-carbon plant as well as guidelines for further development.

The BAT method of alternative facilities refers to European Directive 2004/8/ES [1] on the promotion of production of heat and power in a cogeneration process. The BAT method of alternative facilities compares the energy efficiency of a CHP system with that of facilities in separate production or production of energy products in substitute facilities. The level of production efficiency is determined using the results of fuel savings. If heat and power production by means of a CHP system is more efficient than that in alternative facilities, the CHP system consumes less fuel, system efficiency is improved, and emissions of greenhouse gases and the toxicity of gases are lower. A schematic presentation of the model of the BAT method of alternative facilities is shown in Fig. 1.

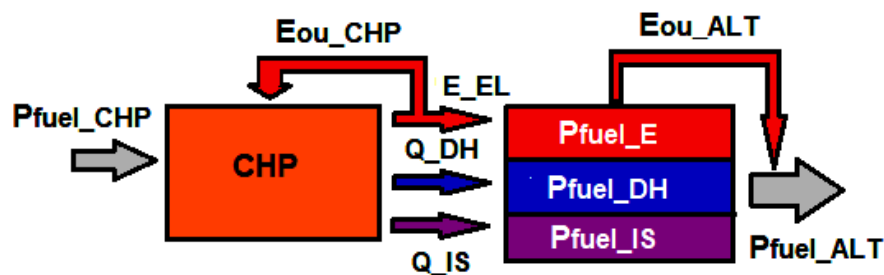

Figure 1: Schematic presentation of the model of the BAT method of alternative facilities

Source: own.

In large CHP systems, the combustion process with the purpose of increasing the enthalpy of a working medium is carried out by means of fossil fuel combustion. The type of fuel combusted is intricately linked to the chemical composition and corresponding greenhouse gas emissions. The low-carbon transformation of a large CHP system is intricately linked to the use of low-carbon or carbon-neutral fuels, such as biomass, biomass fraction of waste, hydrogen, etc. Replacement of the fuel type in CHP systems is intricately linked to high investment costs, because in order to achieve high efficiency it is necessary to opt for BAT. This raises a question as to what extent preserving the existing plant makes sense. However, replacing solid fuel with gas fuel, taking into account a high-efficiency BAT, results in the replacement of the entire CHP system.

The low-carbon property of the gas-steam CHP system in comparison to the CHP solid fuel system is mainly reflected in the type of fuel, because gaseous fuels have a lower carbon content and a higher hydrogen content. This corresponds to combustion products of such fuels because emissions of CO_2 (carbon dioxide) greenhouse gas decrease and those of water vapour or water increase. The carbon footprint of such gas-steam CHP plants can further improve, because the latest gas turbines, such as the Siemens SGT 800

gas turbine, can, in combination with natural gas, operate with a hydrogen volume fraction of as much as 75% [2]. With the further development of steam turbine burners, hydrogen volume fraction in combination with natural gas will further increase. Likewise, gas turbines can also be powered by biogas.

The results of the model of the BAT method of alternative facilities show that the fuel savings of the CHP system depend on system load. At a 40% system load, the fuel savings of the CHP system equal 27%, while at a 100% system load, the fuel savings of the CHP system equal 34%.

The low-carbon transformation of a large CHP system is intricately linked to the use of low-carbon or carbon-neutral fuels. The low-carbon future of the plants described may be further improved, since, in combination with natural gas, the latest gas turbines may operate with as much as a 75% hydrogen volume fraction. Hydrogen may also be obtained from surplus green energy and mixed with natural gas in the methanisation process.

However, special attention must also be dedicated to the possibility of using biomass fraction of waste, because the combustion of the fraction increases carbon neutrality. Biomass fraction of waste is currently deposited at landfills or transported to incineration sites, largely abroad. In the case of combustion of the fraction, heat is also generated, which may be used rationally by means of CHP systems for the production of electric and thermal energy.

References

- [1] Directive 2004/8/EC of the European Parliament. Available: <https://eur-lex.europa.eu/legal-content/EN/TXT/PDF/?uri=CELEX:32004L0008&from=DE>
- [2] Siemens Energy. Available: <https://www.siemens-energy.com/global/en/offerings/power-generation/gas-turbines/sgt-800.html>

DESIGN OF wFOIL 18 ALBATROSS WITH HYDROGEN TECHNOLOGIES

NEJC ZORE, JURIJ AVSEC, URŠKA NOVOSEL

University of Maribor, Faculty of Energy Technology, Krško, Slovenia
nejc.zore@student.um.si, juri.j.avsec@um.si, urska.novosel@um.si

Keywords: wFoil 18 Albatross, hydrofoil, fuel cell drive, hydrogen technology

This article discusses the design of fuel cell propulsion for wFoil 18 Albatross foil vessels. The aim of this article is to determine the economic viability of such propulsion. The wFoil 18 Albatross was chosen due to its high-speed, low-power propulsion system.

The hydrogen propulsion system for the Albatross vessel consists of the following parts:

- Electric motor (Emrax 188) to convert electricity into mechanical energy
- Battery (LG RESU 3.2EX | LG Battery System), which provides electricity in the event of an emergency or adds the necessary energy to run the engine at maximum power
- Controller (EmDrive 500), which provides enough energy to pass between the elements of the propulsion system
- Fuel cell (Hydrogenics HYPM-HD 30 POWER MODULE), which is the primary source of energy
- The tank (tank for hydrogen gas type 3) stores hydrogen as fuel

Figure 1 shows the position of the propulsion system components in the lateral section that was produced in the Solidworks computer programme.

The brackets indicate the parts that have been selected for the hydrogen propulsion system. The approximate weight of all these parts is 249.1kg and the price of all these parts is about EUR 55,254. All prices are from 2020 and are subject to change.

The main idea in constructing this charging station is the use of seawater and solar energy or renewable energy sources for hydrogen production. Figure 2 shows the process for obtaining and storing hydrogen. The components of the charging station are solar cells (LG NeON 2), desalination (CRYSTAL EX PURE), electrolysis (Nel C Series C10), and a charging station (Haskel (version with air compressor)).

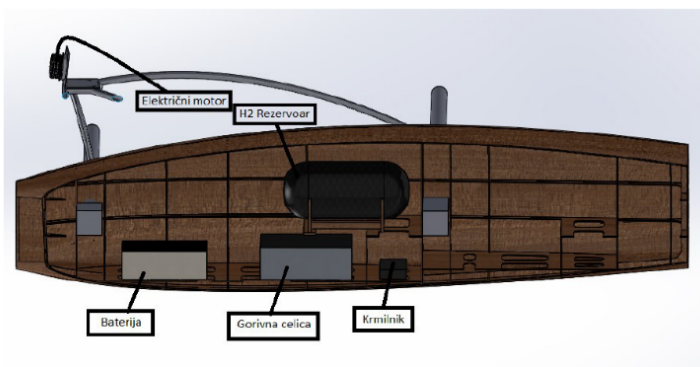

Figure 1: Position of propulsion system components in lateral section

Source: own.

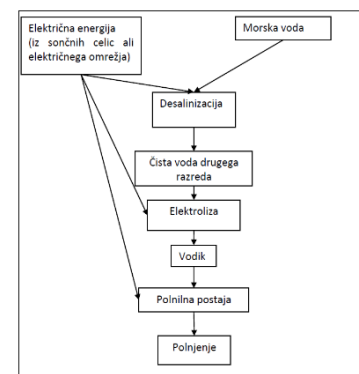

Figure 2: Design of hydrogen charging station

Source: own.

The brackets indicate the parts that have been selected for the charging station. The approximate weight of all these parts is 10,236 kg and the price of all these parts is about EUR 517,664. All prices are from 2020 and are subject to change. The current fuel cell technology is suitable for propulsion of the wFoil 18 Albatross, however, it is not economically comparable to a petrol engine.

Another drawback is the heavier weight than the internal combustion drive. Hydrogen technologies will remain uncompetitive with internal combustion engines until material and production prices reduce. However, they are environmentally friendly and have higher efficiencies than conventional propulsion systems.

References

- [1] N. Zore (2020): The design of the vessel wFoil 18 Albatross with hydrogen technologies, Thesis, Faculty of Energy Technology, University of Maribor, Krško.

ENERGY AND APPLICATIVE ANALYSIS OF THE USE OF HYDROGEN IN ROAD TRANSPORT IN THE REPUBLIC OF CROATIA

FRANCO KROG, JURIJ AVSEC

University of Maribor, Faculty of Energy Technology, Krško, Slovenia
franco.krog@student.um.si, jurij.avsec@um.si

Keywords: hydrogen, hydrogen technologies, hydrogen production, transport

Road transport is an indispensable part of everyday life. Over the last 20 years, there have been rapid price increases, a gradual reduction in the stock of petroleum products and concern for the environment, which has given rise to the need for new fuel. This need is further fueled by environmental awareness and the desire to reduce emissions of greenhouse gases such as carbon dioxide and toxic gases such as carbon monoxide and nitrogen oxides. As greenhouse gas awareness and clean air, especially in urban centres, have become an important part of energetics, new fuel for cars will have to be found. An alternative to internal combustion engines are cars with hydrogen technologies. When referring to hydrogen technology, this means fuel cells. A fuel cell car is similar to an electric car. It differs in the fuel cells, hydrogen tank and components needed for its operation.

To calculate how much hydrogen would be needed, it is first necessary calculate the energy based on the amount of fuel used:

$$E_{D,trg} = N_{D,trg} * HHV_D = 1,836,209,633 \text{ l} * 37 \frac{\text{MJ}}{\text{l}} = 6.8 * 10^{10} \text{ MJ} \quad (1.1)$$

$$E_{B,trg} = N_{B,trg} * HHV_B = 790,201,017 * 33.7 \frac{\text{MJ}}{\text{l}} = 2.67 * 10^{10} \text{ MJ} \quad (1.2)$$

As has already been calculated, the energy value of the fuel placed on the market is $9.47 * 10^{10} MJ$. The calorific value of hydrogen is 141.88MJ/kg.

$$m_{H_2} = \frac{E_{trg}}{H_s} = \frac{9.47 * 10^{10} MJ}{141.88 \frac{MJ}{kg}} = 6.67 * 10^8 kg \quad (1.3)$$

For the total energy placed on the market of $9.47 * 10^{10} MJ$ and an energy value of hydrogen of 141.88MJ/kg, on the Croatian market, $6.67 * 10^8$ kilogrammes of hydrogen would be required.

Theoretically, this calculation is accurate. Calculation of energy given on the market is not the desired result because this energy also includes energy consumed in lorries and maritime transport and additional fuel is already included due to engine losses. From experience it is known that the efficiencies of conventional engines range from 20-50%. The cell most commonly used in cars, the PEM FC, has an efficiency of 60%, which is a higher value than internal combustion engines. In the second calculation, the required amount of hydrogen will be determined by using the average mileage and consumption of a hydrogen car. For the purposes of this calculation, a car on fuel cells will be used – Toyota Mirai.

$$(Consumption_{H_2})_{15,000km} = PG_{TM} * d = 0.76 \frac{kg}{100km} * 15,000km = 114kg \quad (1.3)$$

To calculate the total hydrogen required, a total figure of 1,666,413 will be used.

$$m_{H_2} = N * m = 1,666,413 * 115kg = 1.92 * 10^8 kg \quad (1.5)$$

For a car consumption of 0.76kg/100km and an energy value of hydrogen of 141.88 MJ/kg, the Croatian market would need $1.92 * 10^8$ kg of hydrogen. Figure 1 illustrates a comparison of annual costs based on fuel type.

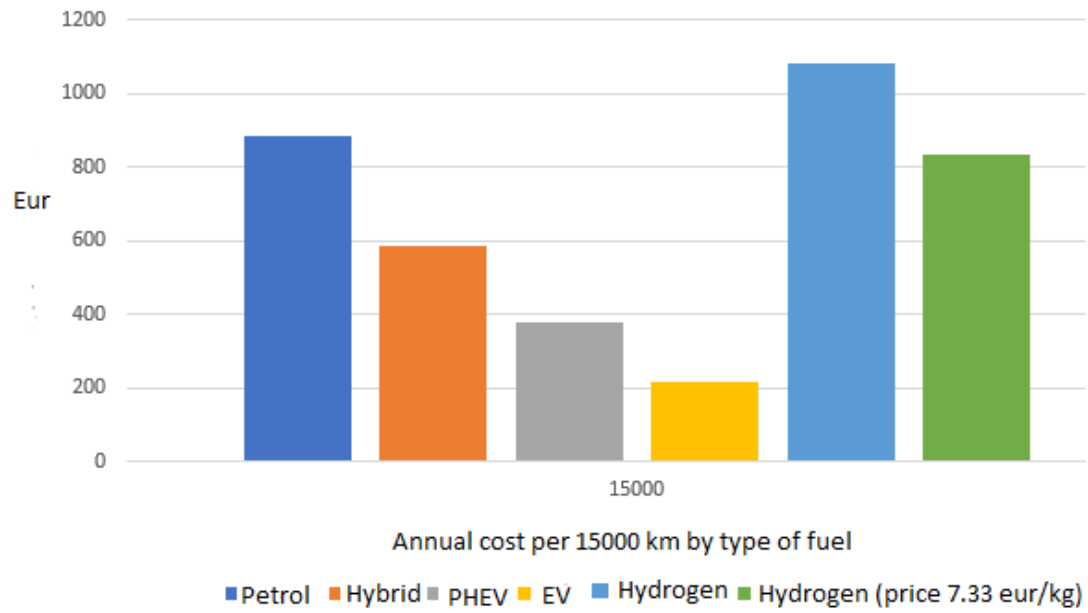

Figure 1: Annual cost of fuel type per 15,000km

Source: own.

References

- [1] F. Krog (2020): Energy and applicative analysis of the use of hydrogen in road transport in the Republic of Croatia, Thesis, Faculty of Energy Technology, University of Maribor, Krško.

THE GLOBAL FUTURE TRENDS OF HYDROGEN PRODUCTION

JURIJ AVSEC,¹ URŠKA NOVOSEL,¹ DUŠAN STRUŠNIK²

¹ University of Maribor, Faculty of Energy Technology, Krško, Slovenia

jurij.avsec@um.si, urska.novosel@um.si

² Energetika Ljubljana d.o.o., TE-TOL Unit, Ljubljana, Slovenia

dusan.strusnik@gmail.com

Keywords: hydrogen, hydrogen technologies, hydrogen production, solar hydrogen production

The world currently consumes about 93 million barrels of oil per day and 104 trillion cubic feet of natural gas per day, releasing greenhouse gases that lead to global warming. In contrast, hydrogen is a clean energy carrier. Due to ecological and demographic impacts, there is a high probability of a series of changes occurring on our planet over the next 50 to 70 years. One of the most important factors in improving the ecology will therefore undoubtedly be the introduction of environmentally friendly technologies, which certainly include fuel cells. Japan, being one of the most advanced countries, has already started the process of introducing fuel cells in the railway sector for slower trains, Tokyo bought more than 100 hydrogen Toyota buses for the 2020 Olympic Games, and the city of Berlin has started the process to purchase hydrogen fuel cell buses. In addition, Germany has begun production of submarines and ships with fuel cell technology, and in South Korea, the largest cogeneration units with fuel cells to date have been built. Apart from critical ecological problems, automotive groups are being forced to develop new technologies, which is added to by the fact that scientists predicted a decrease in the extraction of fossil fuels after 2020. In addition, the war in Ukraine is having a significant impact on thinking about the energy independence of individual countries.

For the mass use of hydrogen technologies, it is necessary to produce huge amounts of hydrogen at a relatively affordable price. The article will describe the potential of mass production of hydrogen. An overview is provided of hydrogen production technologies in connection with nuclear power plants and thermal power plants. To this end, excess energy and waste heat could be used to produce hydrogen. A special chapter also describes technologies for the production of hydrogen using renewable sources.

TRANSPORT SECTOR AND HYDROGEN THROUGH THE 2022 AMENDMENT OF THE ENERGY STATISTICS REGULATION

KLEMEN DEŽELAK, DEJA JURGEC

Statistical Office of the Republic of Slovenia, Ljubljana, Sloveni.
address: klemen.dezelak@gov.si, deja.jurgec@gov.si

Keywords: energy statistics, energy policies, transport sector, hydrogen

In January 2022, the European Commission (EC) adopted the most encompassing amendment of the energy statistics regulation conducted to date [1]. Energy statistics have traditionally focused on energy supply, nuclear energy and fossil energies, while in recent times the essential focus has turned to increased knowledge and monitoring of final energy consumption and the renewable energy sector. The EC regulation on energy statistics [2] introduces a common framework for the production, transmission and circulation of comparable energy statistics in the European Union. Due to the fast pace of technological progress, energy statistics must also develop continuously. In terms of official energy data, the evolution of energy policies, the importance of establishing appropriate targets and the observing of progress in reaching them are significant aspects in the sense of modern, developed energy statistics. Updates within the reported energy statistics are therefore required to reflect the growing changes. With the aforementioned amendment, the European Statistical Office will publish new and detailed high-quality data on several segments, including decentralised production of electricity, improved data on final energy consumption in the service sector and for transport activities [3, 4], some new energy carriers, such as hydrogen [5], some specific data on grid losses during transmission and distribution of electricity and gas, etc. Within the proposed research, some categories related to the transport sector and hydrogen will be analysed in detail [4], [5].

To date, reports have required data on net production by sector (energy, manufacturing and construction, transport, other sectors: households, services, agriculture, forestry, other) from all fuels combined. Under the new regulation, there is mandatory reporting of detailed data on final energy consumption for the transport sector. Of these, more detailed end-use data are reported for rail transport (freight and passenger transport), road transport (by mode of transport, split into freight and passenger transport), aviation, navigation, different fuels and energy sources.

The amendments to the regulation also include new developments in the collection of hydrogen data. A new joint questionnaire will be developed for these purposes. The new combined questionnaire should include questions on domestic production (split by energy and the three carbon capture and storage categories) storage (physical, chemical) and stocks (initial, final). In addition, transformation and the energy sector (split as in other joint questionnaires), end use (in manufacturing, transport, services, households, other), imports, exports (by country) and transmission and distribution losses, production capacities (broken down by energy/fuel and the three carbon capture and storage categories) should be included.

References

- [1] European Commission: *Commission Regulation (EU) 2022/132 of 28 January 2022 amending Regulation (EC) No.1099/2008 of the European Parliament and of the Council on energy statistics, as regards the implementation of updates for the annual, monthly and short-term monthly energy statistics*, Official Journal of the European Union, 2022
- [2] European Commission: *Regulation (EC) No.1099/2008 of the European Parliament and of the Council of 22 October 2008 on energy statistics*, Official Journal of the European Union, 2008
- [3] Emil Velinov, Josef Bradáč: *Automotive Business Development in Central and Eastern Europe: Future Challenges and Perspectives*. International Conference on Automotive Industry, 2020
- [4] Rick Wolbertus, Robert van den Hoed, Maarten Kroesen, Caspar Chorus: *Charging infrastructure roll-out strategies for large scale introduction of electric vehicles in urban areas: An agent-based simulation study*, Elsevier, 2021
- [5] Jang Jin-Sub, Chunjoong Kim, Nak-Kwan Chung: *Temperature-Dependence Study on the Hydrogen Transport Properties of Polymers Used for Hydrogen Infrastructure*, Published online, 2021

HEAT CAPACITY OF PHASE-CHANGE MATERIALS OBTAINED FROM MICROSCOPIC PROPERTIES

IGOR MEDVEDĚ,¹ ANTON TRNÍK²

¹ Slovak University of Technology, Faculty of Civil Engineering Department of Materials Engineering and Physics, Bratislava, Slovakia
igor.medved@stuba.sk

² Constantine the Philosopher University in Nitra, Faculty of Natural Sciences and Informatics, Department of Physics, Nitra, Slovakia
atrnik@ukf.sk

Keywords: heat capacity peak, first-order phase change, domain size distribution, averaging

Phase change materials (PCMs) have been widely used for thermal energy storage in various applications. The primary characteristics needed for the proper design and correct performance of PCM systems include the specific latent heat, ℓ , and the temperature of a phase change, T_{pc} , at which ℓ is released (or absorbed). It should be possible to determine ℓ and T_{pc} from the peaks in the heat capacity vs. temperature plots. However, these peaks are wide, thus making this determination obscure. Even in simple cases of PCMs that are free from effects such as thermal hysteresis and supercooling, and even during measurements when PCMs are close to their equilibriums (i.e. the kinetic effects are negligible), the peaks are still wide. In this simple case, the peaks can be explained as being results of purely equilibrium effects of finite sizes (or surface effects) in micro- to nano-sized domains that occur in PCMs (see Fig. 1). The peaks are then averages of the peaks associated with all domains. By applying this approach [1-4], it is possible to fit the experimental peaks with the theoretical results of this study with very good accuracy (see Fig. 2). Sensible and latent heats can be separated and the phase change temperature T_{pc} can be determined as the temperature where the enthalpy has a discontinuity.

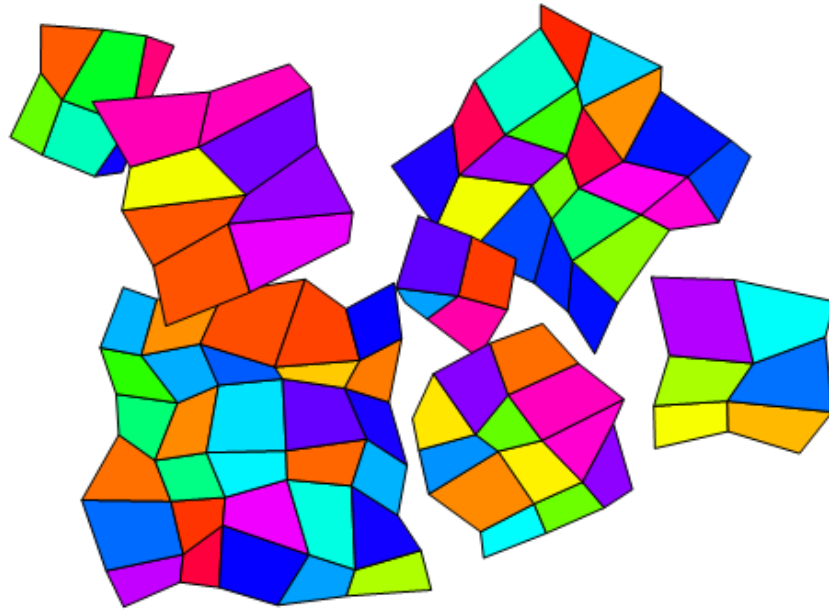

Figure 1: A schematic picture of domains, shown as small tetragons, in a granular material composed of grains. In reality, the shapes and orientations of domains and grains are more complex. The colours are used here to distinguish the domains. Domains may be equal to grains or could be just parts of grains.

Source: own.

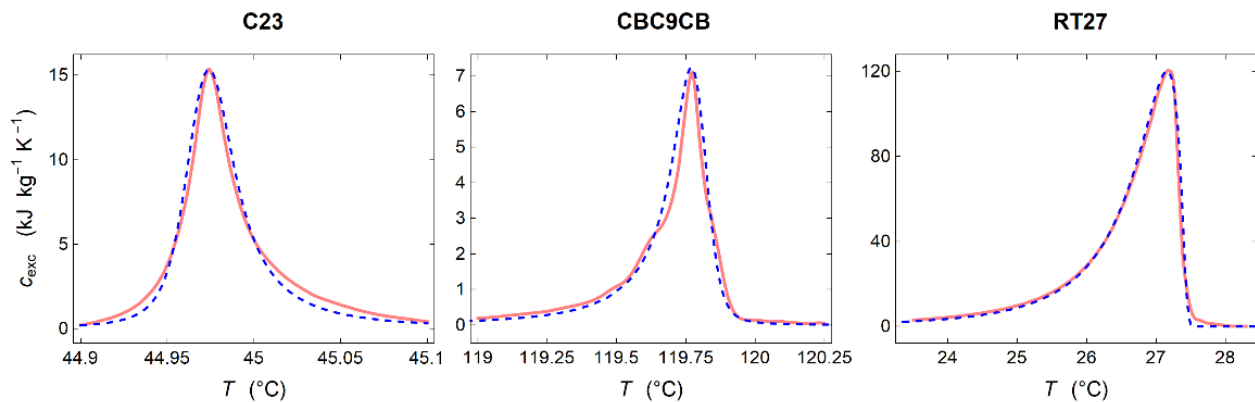

Figure 2: The excess heat capacity obtained from experiment (full lines) and from theory (dotted lines) for three examples of PCMs

Source: own.

References

- [1] I. Medved', A. Trník, L. Vozár: *Modeling of heat capacity peaks and enthalpy jumps of phase-change materials used for thermal energy storage*, Int. J. Heat Mass Transf. 107: 123-132, 2017.
- [2] I. Medved', M. Jurči: *Fractal modelling of polycrystalline PCMs*, AIP Conf. Proc. 2275: 020021, 2020.
- [3] I. Medved', M. Jurči, A. Trník: *Role of surface effects in the determination of phase change temperature of PCMs*, AIP Conf. Proc. 2429: 020026, 2021.
- [4] I. Medved', M. Jurči, A. Trník: *Determination of phase change temperature of materials from adiabatic scanning calorimetry data*, J. Therm. Anal. Calorim., 2022 (in press).

THE IMPACT OF COAL AND CO² EMISSION COUPON MARKET-DRIVEN PRICES ON THE ECONOMIC OPERATION OF THERMAL POWER PLANTS

MARTIN BRICL, JURIJ AVSEC

University of Maribor, Faculty of Energy Technology, Krško, Slovenia
martin.bricl@student.um.si, jurij.avsec@um.si

Keywords: heat capacity peak, first-order phase change, domain size distribution, averaging

Energy is of strategic importance for the development of our society as well as the economy. Despite large financial investments and efforts to produce the majority of electricity from renewable sources, the share of fossil fuel electricity production [1] – especially coal – is still very high and even increasing in developing countries. The movement of energy prices and their supply (i.e. mainly coal and crude oil) are influenced by both social and natural factors. The social factors include greater autonomy of companies in setting energy prices, political factors, disrupted energy supply due to political or military conflicts, and social controversy over environmental impacts. The main natural factor that affects energy supply is climate change, which affects the amount of precipitation in a certain geographical area, resulting in hotter summers than usual and low river water levels in dry periods, which prevents the operation of hydropower plants and makes it difficult to cool closed primary cycles in nuclear power plants. This, of course, is subsequently reflected in the reduction of electricity production [3]. In Figure 1 below, the currently operating thermal power plants are highlighted in yellow and newly designed thermal power plants that are under construction or undergoing commissioning are highlighted in purple.

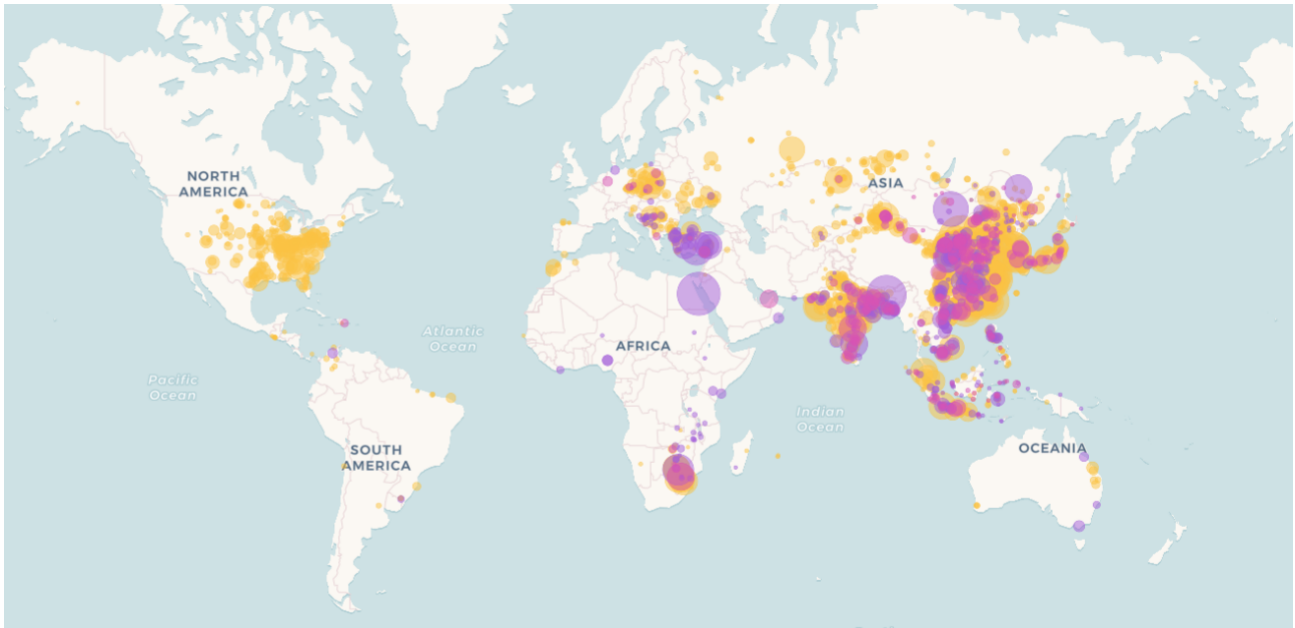

Figure 1: Geographical location of existing operating thermal power plants (yellow) and newly designed thermal power plants (purple)

Source: <https://www.carbonbrief.org/mapped-worlds-coal-power-plants>. CC0 [2]

The main purpose of power plants is to change the primary form of energy into the form required. This transformation needs to be achieved with the highest possible efficiency and the lowest possible unnecessary losses to the environment [3-5]. Aware of the fact that fossil fuels are limited and that a breakthrough in electricity supply is needed, there has been a large increase in the modernisation of electricity production from fossil fuels in recent years. Plants are being modernised and upgraded to achieve greater efficiency in the production of electricity from fossil fuels [6]. The European Union's energy target is to produce half of its electricity from renewable sources by 2030 [7]. The current share of electricity produced from renewable sources is 29%. In December 2016, the European Commission issued a new directive that aims to achieve to set the goals cost-effectively [8]. The first such measure was that the members of the European Union had to set national targets for 2020, which will help monitor progress and achieve the targets for 2030. From 2021 onwards, member states must not achieve lower results than those set out in the 2020 target from the aspect of the production of electricity from renewable sources [9]. By accelerating the use of renewable resources, the European Commission wants to reduce energy costs in the common European space as well as achieve independence from fossil fuels. It is also important to note that European companies involved in renewable energy technology hold 30% of all patents that are directly integrated into energy production from renewables and are therefore crucial for its efficient operation, use and further development. New changes are also expected in the

field of emission coupons in the coming period. It should be noted that the European Commission renewed the scheme through the issuance and trading of allowances after 2020. The European Commission's actions have significantly increased the value of emission allowances and economically forced large emitters of greenhouse gas to adapt, modernise and limit their greenhouse gas emissions. Thermal power plants are important for providing a sufficient amount of electricity and heat produced in the network and are more flexible in their production, such as for example hydropower plants and plants for the production of electricity from renewable sources. According to the accompanying statistics on the economic efficiency of existing thermal power plants, the current situation is as follows: 42% of all thermal power plants are operating at a loss, by 2030 this share is expected to rise to 56%, and by 2040 to 72%. The poorer economic performance of thermal power plants is mainly due to the rising prices of the primary fuel – coal – as well as the higher operating costs of treatment plants due to increasingly stringent local legislation and increasing costs of purchasing emission coupons that allow carbon dioxide emissions. The current loss in the operation of thermal power plants is compensated by electricity consumers. In this research paper, the authors describe the impact of market-driven prices of coal and carbon dioxide emission coupons on the economically viable operation of thermal power plants. Based on the Matlab code, the authors illustrate different operating scenarios through the example of a thermal power plant with one boiler unit [10-17]. It is almost indisputable that the use of fossil fuels has contributed to changes in our atmosphere and we will all bear the burden of such changes in the environment in the future (the greenhouse effect). More worrying than the realisation of, and confrontation with, the needed change is the fact that as a civilisation, we are very rigid in adapting to rapid change and are still partially or completely dependent on fossil fuels. Therefore, we need to find the proper way to exploit the presence of fossil fuels with as little impact on the environment as possible.

References

- [1] J. Oman, 'Generatorji toplote', Univerza v Ljubljani, Fakulteta za strojništvo, Ljubljana 2005.
- [2] Mapped worlds coal power plants. (n.d.). V *Carbonbrief*. Pridobljeno s: <https://www.carbonbrief.org/mapped-worlds-coal-power-plants>.
- [3] M. Tuma, 'Energetski sistemi: preskrba z električno energijo in toploto', 3. izdaja; Ljubljana, Fakulteta za strojništvo, 2004.
- [4] H. Horst H, 'Nauk o toploti, 1. natis / izdajo pripravila Mateja Šmalc po izvirniku', Ljubljana: Tehniška založba Slovenije, 1997.
- [5] B. Kraut, 'Krautov strojniški priročnik, 14. slovenska izdaja / izdajo pripravila Jože Puhar, Jože Stropnik', Ljubljana: Littera picta, 2007.

- [6] Z. Rant, 'Termodinamika: knjiga za uk in prakso', Ljubljana: Fakulteta za strojništvo, 2000.
- [7] Uradni list Evropske unije: Uredba (EU) 2018/842 Evropskega Parlamenta in Sveta, 'Zavezujoče zmanjšanje emisij toplogrednih plinov za države članice v obdobju 2021 do 2030 kot prispevek k podnebnim ukrepom za izpolnitev zavez iz Pariškega sporazuma ter o spremembi Uredbe (EU) št. 525/2013', 30.5.2018.
- [8] M. Trošt, T. Centrih, Z. Petan, 'Evropska trgovačna shema z emisijskimi kuponi v tretjem trgovačnem obdobju in njen vpliv na trg z električno energijo', 11. konferenca slovenskih elektroenergetikov, Laško, 2013.
- [9] European Union - European Commission, 'The EU Emission Trading System (EU ETS)', European Union, Publications Office, 2013.
- [10] Laboratorij i vještine - MATLAB; Uvod u SIMULINK, Zagreb, 2006.
- [11] J. N. Rai, H. Naimul, 'International Journal of Advancements in Research & Technology, Performance Analysis of CCGT Power Plant using MATLAB/Simulink Based Simulation', Department of Electrical Engineering, Delhi Technological University, Delhi, India, 2013.
- [12] S. Oblak, I. Škrjanc, 'Matlab s simulnikom – Priročnik za laboratorijske vaje', Ljubljana, Fakulteta za elektrotehniko, 2008.
- [13] R. Karba, 'Modeliranje procesov', Ljubljana, UL, Fakulteta za elektrotehniko, 1999.
- [14] Z. Kariž, 'Osnove krmilne tehnike I', Ljubljana, Tehniška založba Slovenije, 1988.
- [15] G. Klančar, 'Teorija regulacij', Zbirka rešenih nalog; Ljubljana, UL, Fakulteta za elektrotehniko, 2011.
- [16] B. Zupančič, 'Modeliranje in obdelava signalov', Ljubljana, UL, Fakulteta za elektrotehniko, 2011.
- [17] C. Carlsson, 'Modelling and Experimental Validation of a Rankine Cycle Based Exhaust WHR System for Heavy Duty Applications', Department of Electrical Engineering, Linköpings Universitet, 2012.

COMPARISON OF TEACHING METHODS IN THE FIELD OF ENGINEERING BETWEEN THE UNIVERSITY OF THE AZORES, THE UNIVERSITY OF COIMBRA AND THE UNIVERSITY OF MARIBOR

MARIA JOAO BARROS,¹ PEDRO MOURA,² JURIJ AVSEC³

¹ University of The Azores, Faculty of Sciences and Technology, Ponta Delgada, Azores, Portugal
maria.jf.barros@uac.pt

² University of Coimbra, Department of Electrical and Computer Engineering, Coimbra, Portugal
pmoura@uc.pt

³ University of Maribor, Faculty of Energy Technology, Krško, Slovenia
jurij.avsec@um.si

Keywords: comparison of teaching methods, University of the Azores, University of Coimbra, University of Maribor

Teaching techniques are basically similar all over the world. Nevertheless, certain differences emerge throughout the learning process. The article will describe the similarities and differences in methods of teaching techniques that the authors observed between the University of the Azores and the University of Coimbra – both in Portugal, as well as the University of Maribor, Slovenia. While the University of Coimbra is one of the oldest universities, the authors have included two other universities in order to be able to draw a comparison. The University of the Azores operates on three islands in the middle of the Atlantic Ocean, namely in the city of Ponta Delgada on the island of Sao Miguel, and the islands of Faial and Terceira. Both of the Portuguese universities are characterised by the enrollment of a large number of foreign students. The University of Maribor is the second largest university in Slovenia and operates in the city of Maribor

and some other cities. Particular emphasis will be placed on three faculties: the Faculty of Sciences and Technology (University of Azores), the Faculty of Sciences and Technology (University of Coimbra) and the Faculty of Energy (University of Maribor), located in the cities of Krško and Velenje. A comparison of the teaching methods will be provided taking into account a case of normal conditions and that of an epidemic (e.g. COVID-19).

OPTIMISATION OF A PLATE HEAT EXCHANGER IN A SOLAR REFRIGERATION SYSTEM

ANTUN BARAC,¹ MARIJA ŽIVIĆ,¹ ZDRAVKO VIRAG,² ANTUN GALOVIĆ,²
MATEJ ĐURANOVIĆ,¹ MILAN VUJANOVIĆ²

¹ University of Slavonski Brod, Mechanical Engineering Faculty, Slavonski Brod, Croatia
abarac@unisb.hr, mzivic@unisb.hr, mduranovic@unisb.hr

² University of Zagreb, Faculty of Mechanical Engineering and Naval Architecture, Zagreb, Croatia
zdravko.virag@fsb.hr, antun.galovic@fsb.hr, milan.vujanovic@fsb.hr

Keywords: solar refrigeration system, plate heat exchanger, optimisation, Pareto frontier

One of the ways to replace fossil fuels with renewable energy sources is to use a solar refrigeration system in which the solar organic Rankine cycle drives a vapour compression refrigeration cycle. In this system, plate heat exchangers function as a liquid heater and evaporator of the ORC module, and the aim of their optimisation is to reduce the initial investment and operating costs for the heat exchanger – two contradictory requirements. The paper describes a multi-criteria thermo-economic optimisation of plate heat exchangers, with the aim of achieving minimum annual operating costs at the lowest possible investment cost. The input data for optimisation of the heat exchanger are the mass flow rate of the working fluid and the heating fluid, and the heat exchanger duty. These data come from the thermo-economic optimisation of the whole system. The calculation and optimisation of plate heat exchangers were performed using the EES (Engineering Equation Solver) software [1], which allows the input of geometric features and development of user functions for calculating the overall heat transfer coefficient and drop in pressure in both flows in the heat exchanger. The calculation is in accordance with existing literature [2, 3]. In addition, an economic model was created to consider the total investment for the fabrication and installation of a heat exchanger, as well as the annual operating costs of the heat exchanger. The annual operating costs include the cost of power loss due to a drop in pressure in the heat exchanger, which comes at the expense

of the net power of the cycle. The objective function for optimisation of the heat exchanger is defined in terms of the weighted sum of the total investment cost and the annual operating costs. Thus, by varying the weight factor in the objective function, a Pareto frontier with suboptimal solutions is obtained. Optimisation of the heat exchanger was performed on four operating fluids: R1234yf, R1234ze (E), R152a and R290, and the obtained Pareto frontiers are shown in Figure 1. It can be seen that the R152a fluid proved to be the best, since it requires the least initial investment for the given annual operating costs.

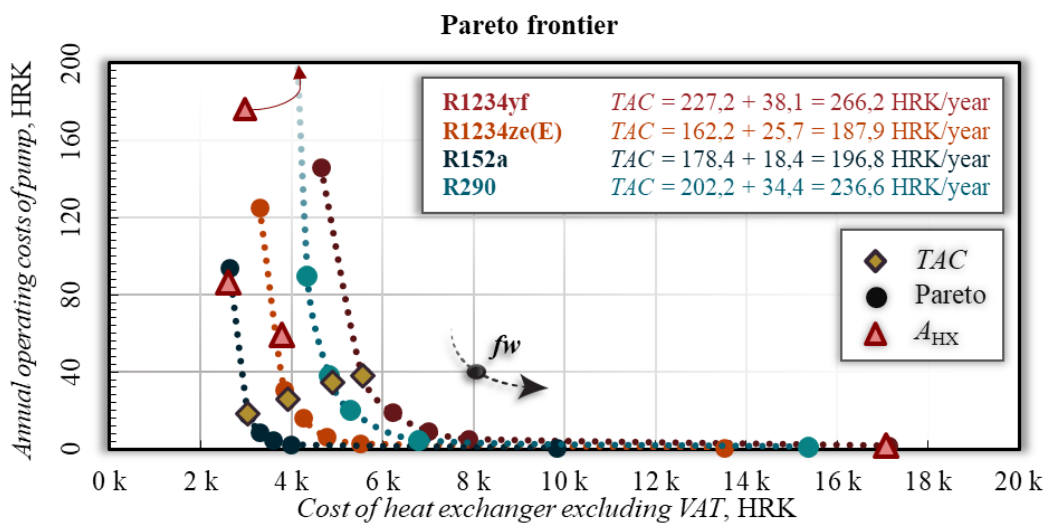

Figure 1: Pareto frontiers of the annual operation cost of pumps and annual repayment of the HE

Source: own.

References

- [1] F-Chart Software, 'Engineering Equation Solver' <https://fchartsoftware.com/ees/>, v11.351., May, 2022.
- [2] F. A. S. Mota, E. P. Carvalho, and M. A. S. S. Ravagnani, 'Modeling and Design of a Plate Heat Exchanger', *Heat Transf. Stud. Appl.*, No. July, 2015.
- [3] J. Lee and K. S. Lee, 'Friction and Colburn factor correlations and shape optimization of chevron-type plate heat exchangers', *Appl. Therm. Eng.*, vol.89, pp.62-69, 2015.

NUMERICAL PREDICTION OF CAVITATION EROSION ON A HYDROFOIL

MARKO PEZDEVŠEK, ANDREJ PREDIN, MATEJ FIKE, GORAZD HREN

University of Maribor, Faculty of Energy Technology, Krško, Slovenia
marko.pezdevsek@um.si, andrej.predin@um.si, matej.fike@um.si, gorazd.hren@um.si

Keywords: hydrofoil, cavitation, erosion, Ansys CFX

The authors of this paper conducted a numerical study in which they predicted cavitation around a NACA 0018-45 hydrofoil. A block-structured computational mesh was created in ICEM CFD. Transient simulations were performed in Ansys CFX where the SST turbulence model with Reboud's correction was used. For the cavitation modelling, the Schnerr-Sauer cavitation model with the recommended values was used. Data of the total vapour volume in the domain for all timesteps was used in the FFT analysis, where a shedding frequency of 59 Hz was recorded, which is consistent with the results from existing literature.

The result from Ansys CFX were then imported into Matlab where the potential power applied to the surface was calculated. The locations with the highest values of the mean potential power applied to the surface are at the trailing edge, which is in agreement with experimental results from existing literature.

Cavitation model

The mass transfer rate in the Schnerr and Sauer model is proportional to $\alpha(1 - \alpha)$.

$$\dot{m} = \begin{cases} F_{vap} \frac{\rho_v \rho_l}{\rho} \alpha(1 - \alpha) \frac{3}{R_B} \sqrt{\frac{2P_v - P}{3\rho_l}} & \text{if } P < P_v \\ F_{cond} \frac{\rho_v \rho_l}{\rho} \alpha(1 - \alpha) \frac{3}{R_B} \sqrt{\frac{2P - P_v}{3\rho_l}} & \text{if } P > P_v \end{cases} \quad (1.1)$$

$$R_B = \left(\frac{\alpha}{1 - \alpha} \frac{3}{4\pi n} \right)^{\frac{1}{3}} \quad (1.2)$$

The recommended values for the two coefficients are $F_{vap} = 1$ and $F_{cond} = 0.2$. The recommended values for the bubble number density is $n = 10^{13}$.

Cavitation Erosion Potential

The potential energy of the vapor structures can be structured as:

$$E_{pot} = (p - p_v)V_v \quad (1.3)$$

The potential power for the void fraction derivative term is defined as:

$$P_{pot}|_{p=cst} = -(p - p_{sat}) \left(\frac{dV_v}{dt} \right) \quad (1.4)$$

The analytical expression for the solid angle of a planar triangle is written as:

$$\tan\left(\frac{1}{2}\Omega\right) = \frac{\vec{R}_1 \cdot (\vec{R}_2 \times \vec{R}_3)}{R_1 R_2 R_3 + (\vec{R}_1 \cdot \vec{R}_2)R_3 + (\vec{R}_1 \cdot \vec{R}_3)R_2 + (\vec{R}_2 \cdot \vec{R}_3)R_1} \quad (1.5)$$

The potential power applied to each surface element j and for all volume elements i can be defined as:

$$\frac{P_{matj}}{\Delta S_j} = \frac{1}{\Delta S_j} \sum_{i|\vec{x}_{S_j} \vec{x}_{cell_i} \cdot \vec{n}_j > 0} \frac{\Omega_{ij}}{4\pi} P_{pot_i} \quad (1.6)$$

ENERGY OF WATER SPILLED OVER HYDROPOWER DAMS

MATEJ FIKE, MARKO PEZDEVŠEK, GORAZD HREN, ANDREJ PREDIN

University of Maribor, Faculty of Energy Technology, Krško, Slovenia
matej.fike@um.si, marko.pezdevsek@um.si, gorazd.hren@um.si, andrej.predin@um.si,

Keywords: hydropower, spilled water energy, energy loss, hydropower dams

Due to climate change, natural disasters, including floods, are becoming more frequent. Floods result from the overflow of rivers and streams and affect the operating regime of hydroelectric power plants. In fact, during flood events, hydropower plants must spill water over dams to maintain safe operation, particularly the stability and strength of the dam structure, and to protect hydraulic machines from being exposed to the effects of water debris. From an energy point of view, any spilled water is an irrecoverable loss of energy. Consequences can be seen of numerous releases and environmental impacts resulting from the unrestricted exploitation of natural resources. One such consequence is the release of a high amount of natural water energy (such as heavy rain) in a short amount of time. With the equipment installed, it is not possible to process such a large amount of water, thus resulting in a loss of energy.

The paper deals with the overflow of water over dams (upper discharge) in the chain of hydroelectric power plants on the Sava River in the southern part of Slovenia. The Sava River was chosen because of its character; it is a typical sub-Alpine river. Flood events are more frequent in spring, when the snow melts in the Alps, and in autumn when heavy rainfall occurs. The flow rates are often too large for the installed capacity of the existing hydropower plants. Therefore, for the purposes of this paper, the losses are estimated. The added installed capacity could increase the existing production, thus reducing imports of electricity to Slovenia.

Four hydropower plants are installed and one is planned on the lower region of the Sava River in Slovenia. In the direction of flow, these are the Boštanj HPP, the Arto-Blanca HPP, the Krško HPP and the Brežice HPP. Construction of the final one – the Mokrice HPP – is planned in the coming years. The chain of HPPs operates under installed conditions, meaning it has river flow rates up to 500m³/s. The accumulation basins of the Brežice and Mokrice HPPs have the role of equalising the daily water flow variability from the upstream HPPs on the Sava River. It is also possible to overflow excess water during extreme river flows through installed safety structures (bypass overflow fields) in front of the Brežice and Mokrice HPPs. The Boštanj, Arto-Blanca and Krško HPPs do not have large reservoirs, therefore all three hydroelectric power plants are of the run-of-the-river type.

Data on the water level and spilled water in individual hydropower plants were collected between 2015 and 2019. The volume of spilled water, the number of spilled events and the estimated energy loss were calculated. The volume of spilled water is calculated from the flow rate data for individual HPPs. The difference in the amount of spilled water between the HPPs is due to different reservoirs capacities and operating regimes. More than 4,200 million m³ of water was spilled and 3,316h of overflows were recorded at the Krško HPP in the given period. The average amount of spilled water volume per year for all four HPPs is 3,370 million m³. The share of spilled water and the ratio of spilled water are increasing in line with the total volume of water, and, on average, is 12.5% at all four hydropower plants. The energy loss for all hydropower plants due to spilled water is 96 GWh per year on average.

The authors of this paper believe that spilled water over a barrier or locks could be used for energy production. All the water that does not go through the turbine track is irretrievably lost. In future, it can be expected that an even more significant amount of water will be spilled due to climate change.



<EnRe>
energy & responsibility

ECOLOGY AND
ENVIRONMENTAL PROTECTION



CARBON MANAGEMENT IN A CIRCULAR ECONOMY

TEOS PERNE, MARKO ŠETINC

Geopolis d.o.o., Ljubljana, Slovenia
teos.perne@gmail.com, marko.setinc@geopolis.si

Keywords: gasification, carbonaceous materials, heterogenous waste, biomass, synthesis gas, synthesis methane

Global warming is caused by the transition of carbon into the atmosphere. Life is based on this element, and it provides the comfort we enjoy through the variety of substances and materials in which it occurs. The problem with the use of carbonaceous materials is its one-way nature, or rather is it only circular to the extent of the amount of carbon ‘consumed’ by biomass for its growth or left in solid form in landfills. The problem is that carbonaceous materials cannot be recycled mechanically or at low temperatures in the way metals can, i.e. in endless cycles as carbon materials, without exception their quality decreases with each cycle due to their heterogeneity, thus they eventually end up in landfill or an incinerator.

This raises the question of whether a circular economy of carbon from natural or fossil sources without further straining the atmosphere is technically feasible. The only possible way to reuse carbonaceous materials is to completely decompose them into their basic components. To this end, technology should allow for the indiscriminate acceptance of heterogeneous and composite raw materials. Any material containing hydrocarbons should be subjected to such a thermo-chemical process at the end of its lifecycle. Disposal should only be allowed for inorganic materials without hydrocarbons, and even in this case certain substances, such as phosphorus and rare metals, should be reused.

The technology that satisfies the above condition is the gasification of solid materials, a process known since the beginning of the industrial revolution. The first commercial installation of dry distillation dates back to 1812, while the first commercial gasifier dates back to 1832. Gasification technology allows the conversion of hydrocarbons via synthesis gas (a mixture of CO and H₂) back to virgin raw materials, just like recycling metals. However, there is a major technological problem with gasification that prevents its commercial expansion and applicability by today's technical standards: the occurrence of tars, which are an inevitable part of the process itself. This paper presents an innovative gasification technology, which addresses this problem in such a way that the final product is a synthetic gas without the presence of tars and represents a new raw material suitable for synthetic processes, such as synthetic methane or methanol. Figure 1 presents the testing of pilot device in Vransko.



Figure 1: Testing of pilot device in Vransko

Source: own.

Two fundamental problems of gasification technology were addressed with innovative gasification technology:

1. Fundamental gasification problem: tar formation in its process
2. Input materials problem: content of Cl and S elements in certain fractions of waste

The technology configuration includes a catalyst with a partial oxidation process and a thrust steam gasifier, which works on the 'updraft' gasification principle. It enables production of producer gas rich in tars, which is the main construction goal and the main difference separating this novel gasification system from existing gasification systems. This

demand also significantly expands the possibility of using gasification materials, which must support the formation of tar as much as possible. Heterogeneity, humidity and dust load are therefore advantages or a must for process optimisation – **the gasification process with pronounced concentration of tars**. Detail descriptions are evident from the P-1900002 and P-1900003 patents.

The technology has been developed to level TRL 6 on the base of a 700kW pilot gasifier. The catalyst itself was reconstructed to avoid carbon deposits due to heterogenous producer gas. The concept was confirmed using a 3MW catalyst which was tested on Ankur's downdraft gasifier in Ruše (presented in Figure 2). Table 1 presents the testing results from the development of the system in 2015.



Figure 2: 3MW catalyst

Source: own.

Table 1: Example of testing results from the development of the system in 2015 (vol%; air was used as the oxidiser)

	25.5.	25.5.	9.6.	10.6.	10.6.
	Product gas	Product gas	Syngas	Syngas	Syngas
CO	28.6%	29.1%	11.9%	13.9%	12.6%
CO ₂	5.8%	7.6%	8.4%	11.7%	7.3%
CH ₄	2.1%	2.3%	1.5%	0.6%	2.4%
O ₂	1.7%	0.1%	0.1%	0.6%	0.5%
H ₂	20.1%	24.2%	19.7%	11.5%	20.4%
N ₂	41.7%	36.7%	58.4%	61.7%	56.8%
LHV	6.5MJ/Nm ³	7.1MJ/Nm ³	4.1 MJ/Nm ³	3.2MJ/Nm ³	4.8MJ/Nm ³
HHV	7MJ/Nm ³	7.6MJ/Nm ³	4.6 MJ/Nm ³	3.4MJ/Nm ³	5.3MJ/Nm ³

The selected type of gasifier with its specific gasifying process enabled the second problem to be solved – the Cl and S presence in waste materials. The gasification process is slow and ‘wet’, and the same adsorption reaction between alkaline additive and Cl and S can already take place in the gasifier. In terms of the efficiency of adsorption, several tests have been performed with increased concentrations of PVC and rubber as well as added calcite or lime. Under optimal conditions, the adsorption efficiency exceeds 99% and the final limits have not yet been reached.

The goal of using heterogeneous carbonaceous materials such as waste and biomass residues to produce clean tar and S/Cl-free syngas, without the need to clean them in downstream filters, was achieved and confirmed. In the near future, two more project tasks will commence an upgrade of the gasification system with SOFC fuel cells and its implementation to the pressure mode. The current basic development is carried out with a low-pressure gasification system using air as an oxidant. In the case of synthetic applications, it will be necessary to develop high-pressure systems that will enable more optimal capacities for the supply of small- and medium-sized chemical plants (50 to 100MW of gasifier input power) for the production of synthesis gases such as synthesis methane.

THE CARBON FOOTPRINT AND SUSTAINABLE DEVELOPMENT OF A COMPANY

JURE GRAMC, ROK STROPNIK, MITJA MORI

University of Ljubljana, Faculty of Mechanical Engineering, Ljubljana, Slovenia
jure.gramc@fs.uni-lj.si, rok.stropnik@fs.uni-lj.si, mitja.mori@fs.uni-lj.si

Keywords: carbon footprint, sustainable development, environmental impacts, GHG Protocol, greenhouse gas emissions, global warming, sensitivity analysis

Background and introduction

Global warming and other environmental issues are growing problems that affect more people every year. One of the biggest reasons for the higher concentration of greenhouse gases (GHG), and consequently global warming, are industrial activities. To limit the damage, it is necessary to reorganise the industry in accordance with sustainable development guidelines. One of the key indicators today is carbon footprint, which helps to identify the environmental impacts of companies. This is very important in terms of meeting the future sustainability goals that are the part of the EU guidelines.

GHG methodology

The GHG Protocol is used as the main methodology in accordance with the ISO 14064-1:2012 standard. The GHG Protocol categorises sources of GHG emissions as direct and indirect sources. GHG emission sources are further divided into three scopes – scope 1, scope 2 and scope 3. Scope 1 are direct sources, scope 2 are indirect sources from heat and electricity, and scope 3 are all other indirect sources of GHG emissions. Scope 1 and 2 are more carefully defined because these two scopes are mandatory in GHG emissions reporting.

A Carbon footprint and identification of 'hot spots'

The carbon footprint shown below in Table 1 was calculated for all scopes for a medium-sized company in the plastics industry. Scopes 1 and 2 are more controllable in terms of data gathering, whereas scope 3 represents a challenge for companies, since upstream and downstream data is needed that is not controlled by the company. For the case shown, the activities observed in scope 3 were: purchased goods and services, upstream and downstream transportation and distribution, waste generated in operations, business travel and employee commuting.

Table 1: Carbon footprint of scope 1, scope 2 and scope 3

Activity	Carbon footprint [t CO ₂ e]
Total Direct GHG Emissions (Scope 1)	76.5
Vehicles	61.1
Forklifts – diesel, LPG	8.6
Delivery vehicles and trucks – diesel	11.8
Passenger cars – diesel	40.7
Fugitive emissions - R410 A refrigerant	15.4
Total Indirect GHG Emissions (Scope 2)	159.8
Electricity consumption – hydro	38.2
District heating consumption – CHP (coal)	121.6
Total Indirect GHG Emissions (Scope 3)	17,915.5

The hot spot in scope 1 is the 'passenger cars' activity, which is responsible for 53% of scope 1 GHG emissions. In scope 2, the hot spot is represented by the 'district heating consumption' activity. District heating consumption is responsible for 76% of scope 2 GHG emissions and 51% of scope 1 and scope 2 GHG emissions. Scope 3 has a significantly higher carbon footprint than scope 1 and 2 primarily because of purchased goods, which are mainly plastic granulates and contribute 95% of scope 3 GHG emissions.

Sustainable goals measures

The author of this study proposes different mitigation activities that companies could implement. The results of the activities reflect a reduction in carbon footprint and are illustrated in Figure 1. Mitigation activity A is the use of hybrids for the company's vehicle fleet. Mitigation activity B is the electrification of the company's vehicle fleet. The author proposes different types of electricity source: hydro, PV and the Slovenian mix. As can be seen in Figure 1, Activity B achieves greater reductions than Activity A. Mitigation activity C is electrification of the company's forklifts. The same electricity sources are used as in Activity B. In the case of an electric forklift with electricity from the Slovenian mix, the

carbon footprint increases. Mitigation Activity D is the use of a different energy source for electricity. Hydro, PV and the Slovenian energy mix are compared. The hydro energy source used by the company has the lowest carbon footprint. If the company used a different electricity energy source, its carbon footprint would increase. Mitigation activity E is the use of different energy sources for heat. A comparison is made of district heat from a CHP power plant run on coal with heat from a local furnace run on biomass and natural gas. Using a local furnace on biomass for heat supply is the greatest proposed mitigation activity.

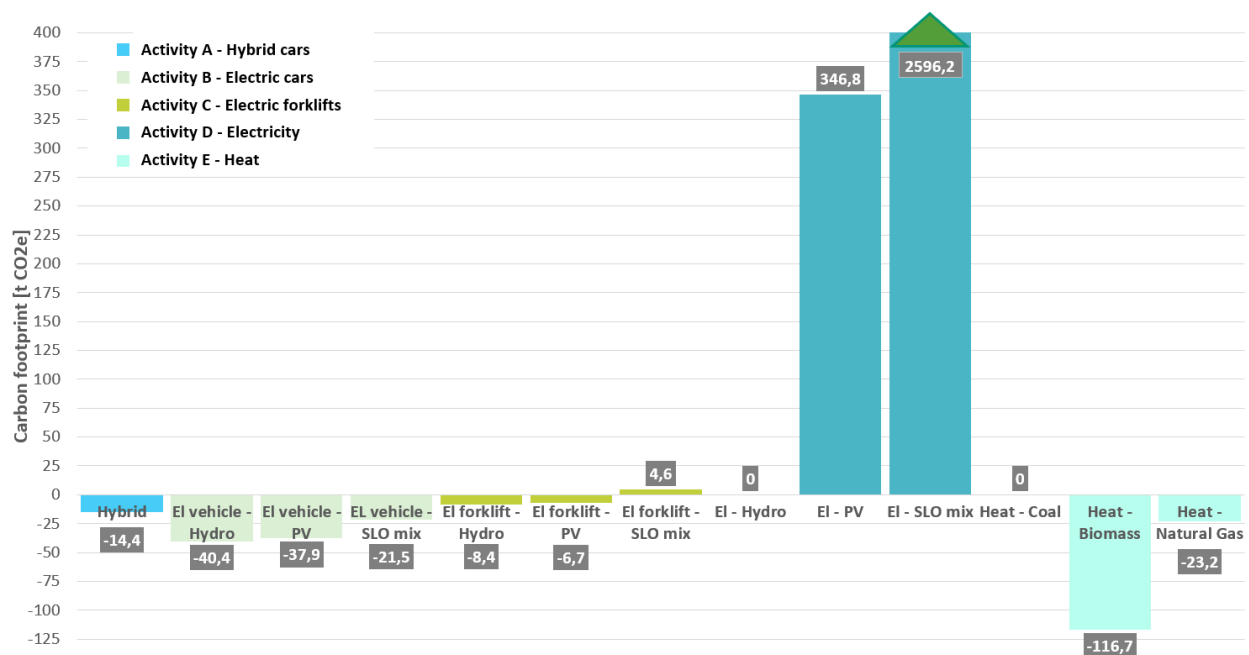

Figure 1: Comparison of different activities to reduce carbon footprint

Source: own.

Conclusion

In the paper, the author briefly describes the carbon footprint of a company in the plastics industry. Although scope 3 represents 98.7% of GHG emissions, the emphasis is on mitigation of scope 1 and 2 activities, because the company has more control over these activities. If the company implemented all the most optimistic mitigation activities, it could reduce its scope 1 and 2 carbon footprint by 55%. The next step for the company should be the use of the methodology for the quantification of mitigation activities.

REDUCING CARBON FOOTPRINT BY CHANGING ENERGY SYSTEMS

DRAGO PAPLER, MARIJAN POGAČNIK

Biotehniški center Naklo, Naklo, Slovenia
drago.papler@bc-naklo.si, marijan.pogacnik@bc-naklo.si

Keywords: energy efficiency, renewable energy barriers, energy efficiency, carbon footprint, economics

Since its construction in 2006, the use of energy products at the Naklo Biotechnical Centre has been changing in type and quantity according to alternative energy solutions and taking into account European and Slovenian requirements in the field of efficient energy use, with environmental effects in terms of CO₂ reduction.

The Biotechnical Centre has been at its current location, Strahinj 99, since 1989. At that time, the school took over the property including stables and outbuildings. In 2004, a cattle barn and a horse barn were built, which were heated using liquefied petroleum gas (LPG). Due to the needs of practical training and the distance from the parent school in Kranj, the premises for practical training on the property were renovated. These rooms were also heated using liquefied natural gas (LNG).

The Naklo Biotechnical Centre follows a sustainable development policy and, alongside its basic educational role, aims to be an example of good practice in the field of agricultural economy. The buildings of the Naklo Biotechnical Centre have relatively high energy needs due to its activities throughout the day, the large number of people and the large heating areas. It uses electricity from the public distribution grid and heat energy for its energy supply. Over 12,000m² of space is heated throughout the Biotechnical Centre, with varying electricity and heat requirements for individual rooms. A school building with a

sports hall was also built on the site in 2006 and is heated using extra light fuel oil (ELKO). Two 550kW furnaces were installed in the boiler room.

In 2007, a photovoltaic (PV) power plant with a capacity of 89,835kW was built on the cattle and horse stables, which was expanded in 2008 and fed into the public distribution grid. In 2016, the PV plant was connected to the centre's internal electricity grid under the PX3 scheme, which provides approximately 30% of the centre's electricity needs. This has led to a reduction in the carbon footprint, as the energy is derived from the sun with no additional emissions. The greenhouses for horticultural needs have their own heating system run on ELKO, which, in line with the strategy to use different energy sources for educational purposes, will be replaced by a heat pump using a water borehole.

With an awareness of the environmental impacts, the heat energy for heating presented a major challenge for the Naklo Biotechnical Centre, an important element of which is raising awareness about a clean environment. In line with its business strategy and establishment of the ISO 14001:2015 environmental standard, the management of the centre pursues important business and environmental objectives, including a reduction in energy costs, waste and materials, and educating and motivating stakeholders to act responsibly towards the environment. By receiving the ISO 14001:2015 certification in 2019, the Naklo Biotechnical Centre is committed to continuously improving its environmental performance. Therefore, the management of the centre has adopted alternative technological solutions to reduce its carbon footprint. The average annual consumption is 100,000 litres of ELKO, which translates into 260 tonnes of CO₂ equivalent.

In 2014, a dairy and fruit workshop was built using the centre's own funds and EU funds. The energy used for heating and technological processes was wood chips, with a stove power of 150kW. In order to make the technological use of energy in the butane gas kitchen more cost-effective, a connection to the public natural gas distribution network of Domplan Kranj was made in 2016. In 2021, the school building and the sports hall were connected to the system. An investment was made in rehabilitation of the heating installations by installing a Weishaupt gas burner, gas fittings, a gas line with a ball valve with a thermocouple, a natural gas pressure regulator, a rotary gas meter for gas flow measurements and other equipment, internal gas installation, burner start-up and adjustments, flue gas emission measurements and measurement protocols.

The difference in carbon footprint between fuel oil and natural gas results in a difference of 0.7kg of emissions CO₂ equivalent/litre or 70 tonnes of CO₂ equivalent. The savings in terms of societal benefits are evaluated by taking into account the ecological benefits, taking into account the price of CO₂ emission allowances.

The paper will analyse the development changes of the heating systems, calculate the CO₂ equivalent emission change equivalents depending on the heating systems and simulate the solutions after the final withdrawal of ELKO from the centre and its replacement by natural gas.

In the next step, calculations of economic indicators, such as payback period of the investment, net present value, internal rate of return, cost-effectiveness and return on investment, will be carried out in terms of the change of energy sources from a cost-competitive perspective.

By simulating the heating experience in relation to the outside temperature and energy consumption, a risk assessment will be produced, which will be presented in terms of changes in energy quantity, price fluctuations and maintenance costs.

The economic and environmental impacts of energy switching will be elaborated through a Cost-Benefit Analysis (CBA) from the point of view of climate change and CO₂ equivalent savings.

In accordance with the Regulation on the environmental charge for air pollution by carbon dioxide emissions (Official Journal of the European Union No.48/18 and 168/20), the CBA takes into account the value of CO₂ emission allowances according to the Decision on the average price in 2020, which is EUR 24.31/t and EUR 52.89/t for 2021.

The increase in energy prices in 2020-2030 is expected to be influenced by rising gas prices due to increased demand and the war in Ukraine and thus increased CO₂ pollution, which will have an impact on the price of CO₂ emission allowances.

The Naklo Biotechnical Centre is a responsible sustainable educational institution that educates young generations and should also set an example in the use of energy systems that are energy efficient and environmentally sound.

LIFE CYCLE ASSESSMENT OF INTERNAL COMBUSTION VEHICLES, ELECTRIC VEHICLES AND HYDROGEN FUEL CELL VEHICLES

GASPER GANTAR

Faculty of Environmental Protection, Velenje, Slovenia
gasper.gantar@fvo.si

Keywords: Life Cycle Assessment (LCA), vehicles

Transport is an important cause of several environmental issues, including air pollution and climate change. In the transport sector, a number of EU-level policies have been put in place to tackle sectoral environmental impacts and support the transition towards a low-carbon, circular economy [1].

Both electric and hydrogen fuel cell vehicles are classified as ‘zero emission vehicles’ because they produce zero tailpipe emissions at the point of use. However, the question arises what emissions and other environmental impacts result from the production of electricity and hydrogen.

There are many conflicting claims about the environmental impacts caused by electric vehicles and hydrogen fuel cell vehicles. One of the most common ones is that electric vehicles and hydrogen fuel cell vehicles do not cause any emissions. On the other hand, there is an view that mere production and handling of battery packs after the end of their life causes greater negative impact on the environment than the use of a conventional vehicle, and that hydrogen production causes greater environmental impacts than the use of fossil fuels [2].

In order to make an informed decision, it is important to understand environmental impacts of vehicles throughout their entire lifecycle. The Life Cycle Assessment (LCA) enables the comparison of different technologies and fuel options. In our study, the environmental impacts of six types of light-duty vehicles were compared: the vehicles with internal combustion engines (petrol, diesel, CNG and LPG), the electric vehicles and the hydrogen fuel cell vehicles.

LCA methodology

The first step in an LCA is to define its goal and scope. The goal is to explore the environmental impact of a certain vehicle. The LCA analysis covers: 1) vehicle production (used materials and auxiliary materials, production technologies), 2) transport of materials between the supplier and vehicle producer and transport of vehicles from the vehicle producer to the point of sale, 3) use of vehicles including emissions from the production of fuel and maintenance of vehicles and 4) vehicle end-of-life. The input data was gathered from literature. EcoInvent 3.8 database was used as a main source of secondary data.

Case study

European C-segment passenger car with assumed vehicle lifetime of 15 years and 300,000 km was used as a case study example. Real-world fuel consumption is based on average EU28 use profile. A fuel mix is based on EU-27 base blend. An electricity mix is based on Slovenian database.

Results

Comparison of GHG emissions (in tons of CO₂-e) for different medium passenger vehicles is presented in Figure 1. While a type of transport might be zero emission at the point of use, this is in fact not really the case if we consider the complete life cycle. Nevertheless, the electric vehicle has the lowest GHG emissions in the entire life cycle and is followed by the hydrogen fuel cell vehicle. Even more importantly, there is a further room for improvement (shown with a blue arrow) when using 100% green electricity or 100% green hydrogen in the use phase.

The electric vehicles and hydrogen fuel cell vehicles both have higher embedded GHG emissions from vehicle production than any conventional internal combustion vehicle. Considering the production of electrical vehicles, the battery pack and the size of that battery pack has a significant impact on the overall result. For the hydrogen fuel cell vehicle, the increase in embedded GHG emissions results from the on-board hydrogen cells and the hydrogen storage system.

The production of electricity and hydrogen consumed during the use phase is the most significant input variable for the vehicle’s use stage and also its entire Life Cycle Assessment.

Other life phases, eg. the transport of materials between the supplier and vehicle producer and transport of vehicles from vehicle producer to point of sale, maintenance of the vehicle and end-of-life of vehicles have significantly lower environmental impacts.

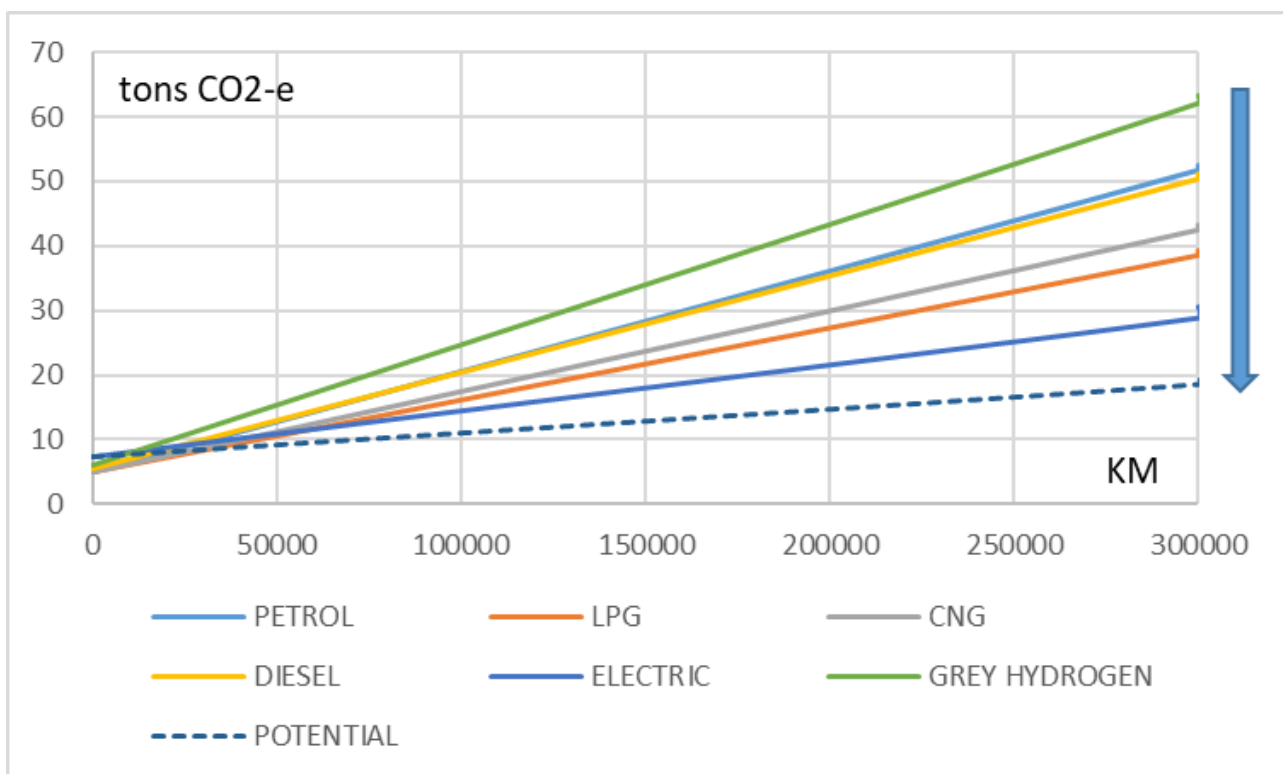

Figure 1: Comparison of GHG emissions for the medium-sized passenger vehicles in Slovenia

Source: own.

Notes**Table 1: Nomenclature**

(Symbols)	(Symbol meaning)
CNG	Compressed natural gas
LCA	Life Cycle Assesment
LPG	Liquefied petroleum gas
CNG	Compressed natural gas

References

- [1] Nikolas Hill et. all: *Determining the environmental impacts of conventional and alternatively fuelled vehicles through LCA*, European Commission, DG Climate Action, 2020.
- [2] Kiersten Biemann: *Electric mobility – The sustainable solution?*, ifu Hamburg, 2019.

RESTRUCTURING THE SAŠA COAL REGION IN ACCORDANCE WITH A FAIR TRANSITION POLICY

FRANC ŽERDIN

CRTI SAŠA, Velenje, Slovenia
franc_zerdin@yahoo.com

Keywords: restructuring, transition policy, Velenje coal mine, Šoštanj power plant

The Savinjska-Šaleška (SAŠA) region is at a turning point. The closure of the Velenje Coal Mine and the coal-fired power station in Šoštanj is rapidly approaching; consequently, the need for services provided by their economic and other business partners is declining.

As the region is and will continue to change due to the dwindling coal industry, we need to find answers to the questions of what kind of region its inhabitants will value and appreciate, accept as a desired and worthy destination in which to live, where they will want to start a family and in which we will strive for a comfortable life of each individual and the successful development of the region as a whole. By knowing how to encourage the pursuit of higher added value for every inhabitant of the region, it will also be possible to provide respectable added value for the entire restructured region.

Regardless of the expected changes and threats that are present and will occur, the region's restructuring process must be seen primarily as an opportunity for changes, including those that coincide with the European Union's efforts to move member states to a carbon-free society.

VISION

‘The Savinjska-Šaleška region will make a fair transition from a coal region to a region with happy people and a green, friendly and liveable environment.’

We will succeed if we have clearly defined goals, knowledge as well as wise and courageous decision-makers in the region and the country.

SOCIO-ECONOMIC SITUATION OF THE SAŠA REGION

Given the experience gained in the European Union and the developed world, it takes at least 20 years to make a fair transition from a coal region with such diverse and demanding mining, geological and sociological conditions as are present in the Velenje Coal Mine, which has been operating for almost 150 years. The scale of the problem is dictated by the size of the exploitation area, the unique thickness of the coal seam and the excavation method with the demolition of the roof layers. Nowhere in the world have the consequences of coal mining been as multifaceted as in the Šaleška Valley.

By 2020, 145 million tons of lignite had been mined in the Šaleška Valley. Due to coal mining, more than 800 ha of quality agricultural land were degraded, the villages of Škale, Pesje, Preloge, Gaberke and Družmirje and large areas of Šoštanj and Velenje were completely demolished, 1,550 people were relocated, 818 residential and commercial buildings were flooded and demolished and there was a major stagnation in the development of the settlements of Metleče and Topolšica. In 145 years, 143 miners have been fatally injured and difficult working conditions in the mine have resulted in thousands of workers sustaining life-changing injuries. Two churches were torn down, more than 1,500 graves had to be relocated from three large, now submerged, cemeteries, three primary schools, cultural centres and fire stations, as well as many sports and other infrastructure facilities were demolished and hundreds of kilometres of roads were damaged and destroyed.

Due to the high tax paid for coal mining by the local community in the Šaleška Valley so far, there needs to be a fair and honest transition from coal mining activities. In addition to high-quality rehabilitation of the vast areas of degraded land, construction of embankments around sinkhole lakes, regulation of watercourses, etc., it will also be necessary to replace the lost jobs in the coal mining and energy sectors as well as job losses in the chain of companies connected with coal mining and power engineering. According

to the calculations of internationally recognised experts and trade unions, this amounts to the need to replace approximately 5,000 jobs.

A fair transition also requires the regulation of optimal conditions for the safe and age-appropriate life of an increasing number of elderly people in the region, both in terms of housing and health. In recent years, the Velenje Coal Mine and the Šoštanj Power Plant have made great efforts to solve problems related to the ecological rehabilitation of the region, build alternative housing for inhabitants of degraded areas, purchase alternative building and agricultural land across the country, rehabilitate damaged land and establish new activities. Due to high costs, many problems remain unresolved. A 3-9% cost of mining damages was included in the price of coal, depending on the extent and complexity of the problems that had to be solved in individual years. The state did not participate in covering of the costs of repairing the mining damage, even though it should have, as the Cola Mine has had to adapt to the owner's requirements in terms of the size of production, which also included overtime work on Saturdays, Sundays and holidays, with the aim of providing an adequate amount of heat and electricity.

GEOGRAPHICAL PICTURE OF THE SAVINJSKA-ŠALEŠKA REGION

The Savinjska-Šaleška region is very geographically diverse. From the northwest to the southwest it stretches all the way from the Kamnik-Savinja Alps to the valleys and forests of the Upper Savinja Valley. It also includes the entire Šaleška Valley, which includes the Municipality of Velenje and the Municipalities of Šoštanj and Šmartno ob Paki.

The Savinjska-Šaleška region comprises the area of ten municipalities; in addition to the already mentioned three from the Šaleška Valley, the region includes the municipalities of Solčava, Luče, Ljubno, Gornji Grad, Rečica ob Savinji, Mozirje and Nazarje. It makes sense to define these municipalities as an integral part of the coal region, as they are strongly intertwined with municipalities from the Šaleška Valley, with historical, economic and cultural ties in many areas of public and private life and have always been an important source of work force for the Velenje Coal Mine and Šoštanj Power Plant.

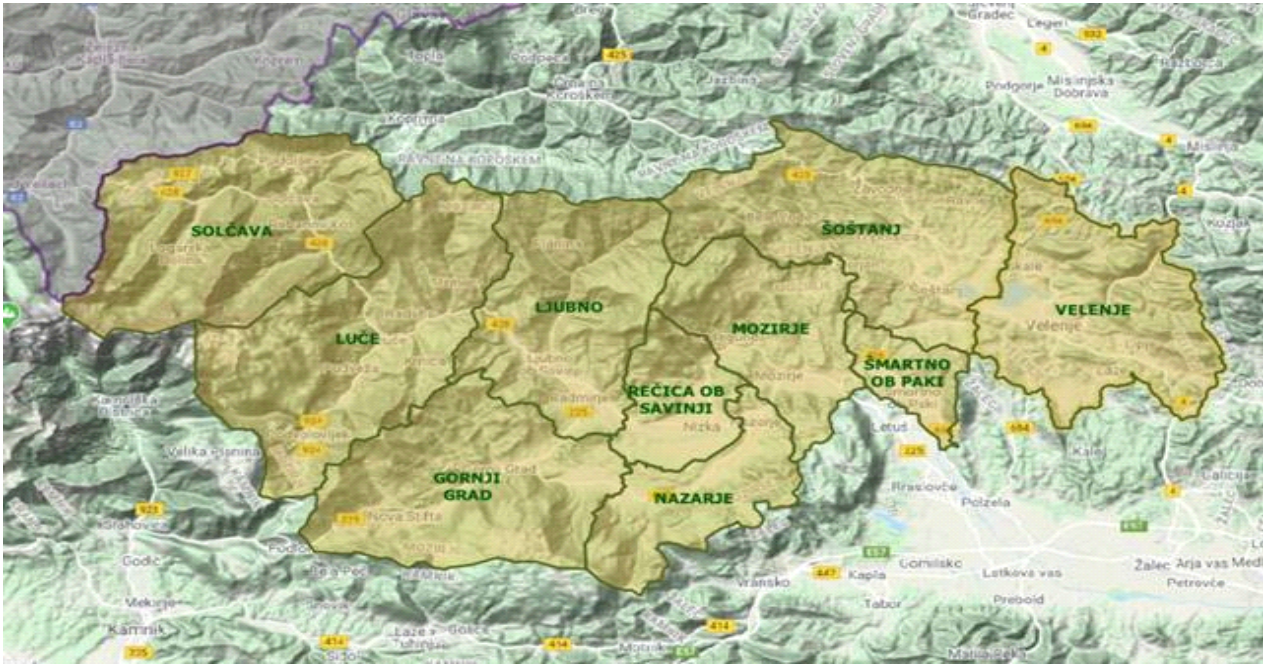

Figure 1: Municipalities of the Savinjska-Šaleška region

Source: Print screen, own.

The region covers 705.6km² in size and has a population of 61,800. This represents about 3% of the population of Slovenia and the region occupies 2.9% of the entire territory of Slovenia.

For decades, the Savinjska-Šaleška region has been one of the largest, if not the largest, energy basins in the country, producing heat, electricity and cooling energy, all through the conversion of coal energy. In addition to coal reserves, the SAŠA region is rich in solar energy and biomass, as well as water resources, which offers it the opportunity to develop a green economy and green jobs. An alternative to today's economy in the region can be offered by a sustainable economy based on the rational use of raw materials and energy, with an emphasis on renewable energy sources, diversified and more environmentally friendly transport, waste recycling and tourism.

VULNERABILITY OF KARST WATER SOURCES – ŽEGNAN SPRING AND LJUBIJA TRIBUTARY (NE SLOVENIA)

NATALIJA ŠPEH, ANJA BUBIK

Faculty of Environmental Protection, Velenje, Slovenia
natalija.speh@fvo.si, anja.bubik@fvo.si

Keywords: karst water sources, vulnerability, drinking water, monitoring, water quality indicators, human impact, Ljubija tributary, Žegnan spring

The study areas comprise two water reservoirs: The Žegnan spring in the Municipality of Rečica ob Savinji and the Ljubija tributary in the Municipality of Šoštanj. Both are registered as water protection areas (WPA). The Ljubija tributary is active, since it provides drinking water for around 30,000 people [1]. The Žegnan spring used to be a source of fresh water supply until 1986 [2].

The most important and demanding task of water supply is to secure the adequate quality and sufficient quantities of drinking water, even during periods of drought period when the need for the water increases. On a global level, karst water resources cover approximately a fourth, and a third of Europe's drinking water demands [3-5]. In Slovenia, as much as 97% of the population is supplied with drinking water from underground aquifers [6], and almost half of the country's drinking water needs is obtained by pumping water from karst aquifers [7]. As karst aquifers are highly vulnerable to pollution, karst water resources require proper and consistent management. In Slovenia, large karst areas are usually quite remote and, due to their unfavourable topography and climatic conditions, less suitable for intensive settlement and the concentration of various activities. These are mainly wooded areas or areas dominated by extensive farming [8].

Taking in account the nature, low retention and low self-purification capacity of karst aquifers, in addition to their rapid infiltration from surface to groundwater and swift underground flow, the authors of the paper intend to check the threat to water reservoirs. In addition to natural factors, the water quality [6, 9-11] was monitored, using general physical and chemical parameters (turbidity, pH value, electrical conductivity, water temperature and hardness). The human impact was also proven and the nitrate content was measured as an indicator of nutrient status in water, focusing on otherwise extensive agricultural activity in the research areas. The authors checked the characteristics of the Ljubija tributary and the Žegnan spring twice a month throughout 2020, in the wet and dry seasons, in groundwater (LGW and ŽSGW) and surface water (LSW and ŽSSW) respectively. Additionally, all the indicators were compared to the precipitation data.

The precipitation data 10 days prior to sampling showed very similar precipitation regimes in both areas in 2020, with the first precipitation peak in summer (June-Aug) and the second in autumn (Sep-Nov). The total annual rainfall was above 900mm (Table 1). The data on peak precipitation corresponds to the continental climatic conditions (Cfb subtype according to the Köppen-Geiger climate classification, annual precipitation 1,000-1,400mm), but with decreased annual rainfall in 2020, which coincides to the less rainfall-rich climate type of eastern Slovenia and draws attention to potential changes.

Table 1: Precipitation data 10 days prior to sampling in both study areas [12]

	Mar-May (mm)	June – Aug (mm)	Sept - Nov (mm)	Dec - Feb (mm)	DRY SEASON (mm)	WET SEASON (mm)	ANNUAL SUM (mm)
Ljubija tributary	152.3	381.9	252.8	138.4	287.8 (31.1%)	637.6 (68.9%)	925.4
Žegnan spring	164.0	297.2	296.2	158.4	272.4 (29.8%)	642.4 (70.2%)	914.8

The general physical and chemical parameters (turbidity, pH value, electrical conductivity, water temperature and hardness) were within the recommended values throughout the whole observation period, in accordance with the natural features of the areas, with no statistically significant or unusual deviations. For the precipitation regime, it would be useful to check a longer timescale. In the catchment area of the Ljubija tributary – an important water supply area for the Savinja-Šalek subregion – the concentration of nitrates was very low irrespective of the time of sampling. No precipitation or season dependent changes were observed. Due to the values below 3.5mg/L in groundwater and even below 2mg/L in surface waters, values cannot be related to anthropogenic influence. In the Žegnan spring, slightly higher concentrations of nitrates were measured compared to the

area of the Ljubija tributary. Consistent with natural water flow and area characteristics, higher concentrations of nitrates were determined in ŽSGW than in ŽSSW, which is the opposite of the catchment area of the Ljubija tributary. The precipitation regimes did not affect the nitrate variations on the surface and in the ground water, regardless of whether it was a dry or wet season.

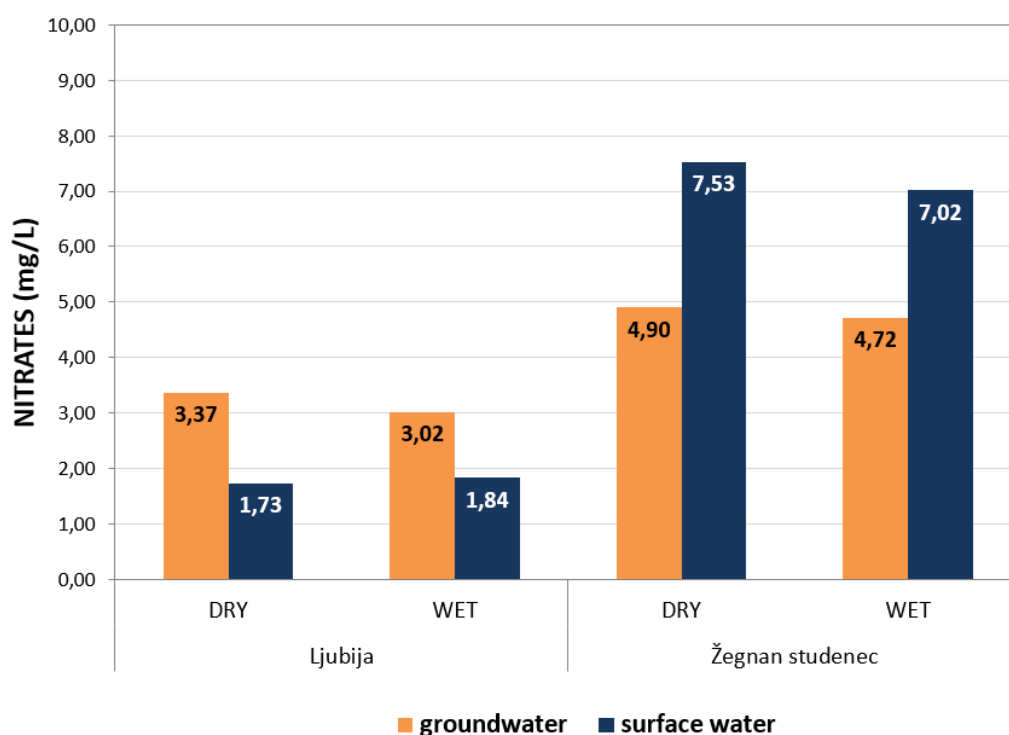

Figure 1: Variations in nitrates variations, wet and dry seasons, ground and surface water of the areas of the Ljubija tributary and the Žegnan spring

Source: own.

The contact karst springs-scale field study conducted throughout the year 2020 included one potential and another active water supply area located in northeast Slovenia. The authors analysed their features in the frame of a potential karst hazard, drinking water supply and WPA. The vulnerability of the areas in terms of nitrates was excluded in the year 2020. Precipitation, or more precisely seasonal precipitation characteristics, did not pose a risk of extreme deviations of water parameters. The authors concluded that the intensity of human activities have not exceeded the previous natural conditions and self-purifying capabilities of the bodies of water researched. However, prudent and sustainable management is also required in the future to prevent overburdening these water sources.

References

- [1] N. Špeh, A. Bubik, B. Barborič: *Vodnoekološke razmere na območju doline Zaloka*, Geografski vestnik: časopis za geografijo in sorodne vede, 93 (2), p.p.57-71, 2021.
- [2] *Ordinance on the protection zones of the Župnekovo žrelo and Žegnani studenec water source*, Official Gazette of the Republic of Slovenia, No.13/87, 1987.
- [3] A. Hartmann, N. Goldscheider, T. Wagener, J. Lange, M. Weiler: *Karst water resources in a changing world: Review of hydrological modeling approaches*, Rev. Geophys., 52 (3), pp.218-242, 2014.
- [4] Z. Stevanović: *Managing Karst aquifers—conceptualizations, solutions, impacts*. In: Stevanović, Z. (Ed.) *Karst aquifers – characterisation and engineering*. Springer International Publishing, Switzerland, p.p.403-419, 2015.
- [5] Ravbar, N., Petrič, M., Blatnik, M., Švara, A.: *A multi-methodological approach to create improved indicators for adequate karst water source protection*, Ecological Indicators, 126, p.p.1-14, 2021.
- [6] *Monitoring in ocenjevanje stanja površinskih in podzemnih voda v Sloveniji*, Agencija Republike Slovenije za okolje, Ljubljana, 2016.
- [7] J. Prestor, P. Meglič, M. Janža, M. Bavec, M. Komac: *Hidrogeološka karta Slovenije 1: 250.000*. Geološki zavod Slovenije, 2008.
- [8] M. Petrič, N. Ravbar: *Kraški vodni viri in njihovo varovanje*, Kras: trajnostni razvoj kraške pokrajine. Ljubljana, 2008.
- [9] *Drinking Water Directive 98/83/EC*, The European Commission, 1998.
- [10] *Groundwater Directive 2006/118/EC*, The European Commission, 2006.
- [11] *Water Framework Directive 2000/60/EC*, The European Commission, 2000.
- [12] *Arhiv meritev. Opazovani in merjeni meteorološki podatki po Sloveniji*. Agencija Republike Slovenije za okolje, Ljubljana, Medmrežje, 2021.

ECOLOGICAL REMEDIATION OF THE ŠALEK VALLEY: HAS IT ALREADY BEEN COMPLETED?

KLEMEN KOTNIK, SAMAR AL SAYEGH PETKOVŠEK, BOŠTJAN POKORNY

Faculty of Environmental Protection, Velenje, Slovenia
klemen.kotnik@fvo.si, samar.petkovsek@fvo.si, bostjan.pokorny@fvo.si

Keywords: Šalek Valley, electricity production, industry, road transport, pollution, degradation, ecological remediation

In the decades after World War II, the Šalek Valley experienced unique development. First in terms of coal and electricity production, and later industry-based development. These activities resulted in several environmental problems which culminated in the 1980s and 1990s. During this period, the Šalek Valley was considered one of the most polluted and environmentally degraded areas in Slovenia [1].

The pollution and degradation of the environment required a quick and effective response from the local as well as the wider community. In the context of broader socio-economic and political changes, the environment has become one of the most important items of local and state policy, and due to increasing ecological awareness, the political value of ecology has also increased rapidly.

Spatial distribution and the complexity of environmental issues required a professional-political interdisciplinary approach with the coordinated and active participation of various stakeholders (politics, profession, interested public, economy, etc.) and the area has experienced a comprehensive case study of ecological remediation in just three decades. Numerous legislative acts (e.g. the Decree on air protection in the area of the municipality of Velenje, 1990) and strategic and operational documents were adopted, which were directly and indirectly implemented in practice (e.g. remediation programmes in the field

of air, water and soil in the municipality of Velenje; Local Agenda 21; Municipal environmental protection programmes) [1,2], and companies adapted and adjusted their operations to the latest environmental standards, etc.

The Šoštanj Thermal Power Plant must be highlighted, as it adopted an ecological remediation programme (e.g. desulphurisation of exhaust gases, primary measures to reduce NO_x, closed water cycle). At the same time, the efficiency of the remediation measures in terrestrial (e.g. forest ecosystem) and aquatic ecosystems (e.g. Lake Velenje, Paka River) of the Šalek Valley was measured/monitored [3,4].

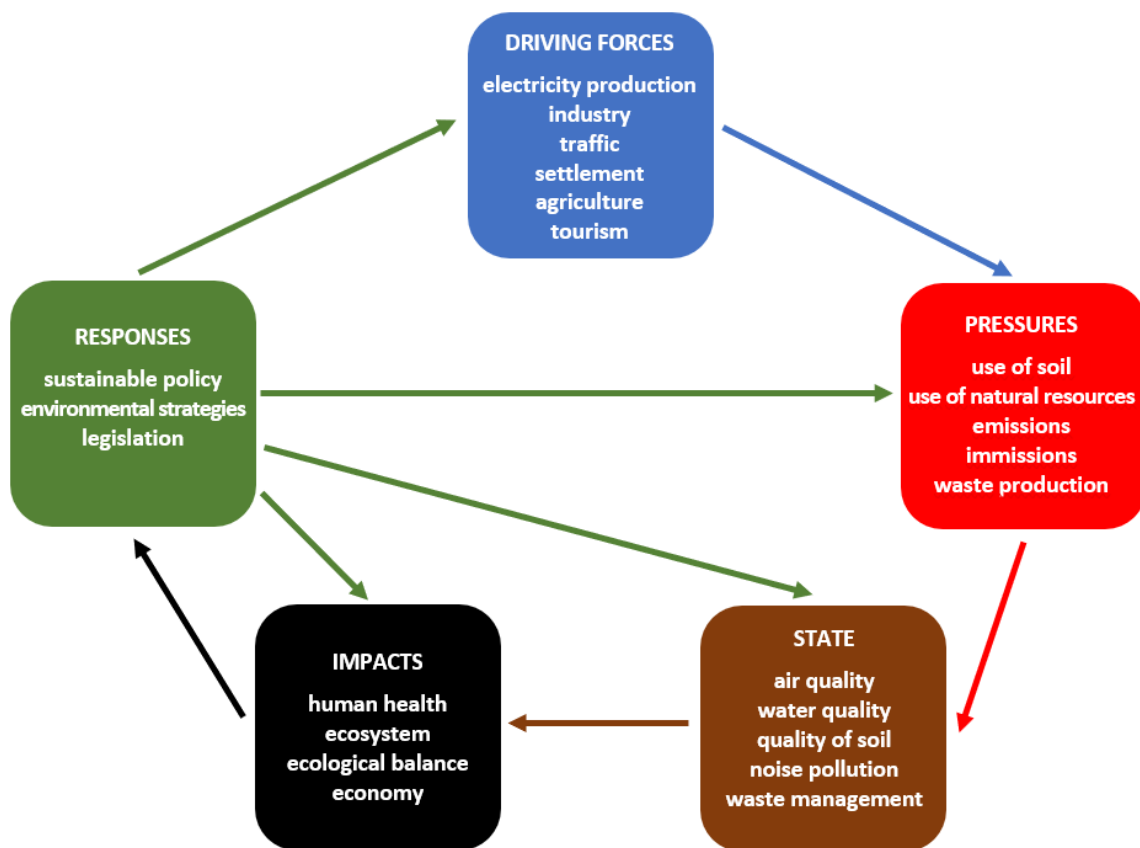

Figure 1: DPSIR (driving forces, pressures, state, impacts, and responses) model

Source: own.

Regardless of the many environmental achievements, ecological remediation in changed forms and content and based on other challenges is still taking place today. The driving forces that have generated most of the environmental problems in the past have received the most attention in the context of environmental remediation (Figure 1). However, the primacy of environmental problems in the recent period is taken over by activities that were (un)justifiably marginalised in the recent past.

Increased road transport causally with spatial development needs to be highlighted. Although air pollution from transport has decreased over the last decade due to the introduction of fuel quality standards, Euro emission standards for vehicles and the use of cleaner technologies, concentrations of air pollutants are still too high. Local approaches to dealing with transport-environmental related problems follow EU guidelines, such as shifting transport to the least polluting and efficient modes of transport, using more sustainable transport technology, fuels, and infrastructure, and ensuring that transport prices fully reflect negative environmental and health impacts.

References

- [1] Kotnik, K., Šterbenk, E., 2019. *Poročilo o stanju okolja v Mestni občini Velenje*. Visoka šola za varstvo okolja, Velenje.
- [2] Kotnik, K., Šterbenk, E., Mrak, I., 2020. *Občinski program varstva okolja za Mestno občino Velenje 2021 – 2025*. Visoka šola za varstvo okolja, Velenje.
- [3] Al Sayegh Petkovšek, S., Poličnik, H., Ramšak, R., Mavec, M., Pokorny, B., 2010. *Ecological remediation of the Šoštanj thermal power plant with respect to sustainable development of the Šalek Valley, Slovenia*. *Thermal science*, vol.14, no.3, str. 773-782.
- [4] Al Sayegh Petkovšek, S., Jelenko, I., Kopusar, N., Mazej Grudnik, Z., Poličnik, H., Ramšak, R., Vrbič Kugonič, N., Zaluberšek, M., Pokorny, B., 2010. *Okoljska sanacija Šaleške doline*. 3rd International Conference Energy Technology and Climate Changes. 20-21 June 2013, Velenje.

PLASTICS - A BURDEN OR A RESOURCE FOR COASTAL ECOSYSTEMS

NATALIJA ŠPEH

Faculty of Environmental Protection, Velenje, Slovenia
natalija.speh@fvo.si

Keywords: coastal pollution, plastic debris, Slovenia, Kornati, Elaphiti, Pašman, Croatia

Plastic waste is unacceptable in any habitat, although it defines the way we live today [1]. Plastics deliver numerous benefits to society. They help feed the world in a safe and sustainable manner, contribute to more energy-efficient buildings and houses, allow great fuel savings in all means of transport ensuring the transition to green mobility, and are key materials in innovation and in reducing energy demand while reducing greenhouse gas emissions [2].

The study area comprises 1) the Kornati, 2) the Elaphiti aquatory and 3) the island of Pašman in the Zadar archipelago. The inventory of the coastlines of the Adriatic islands also determined the representation of the countries of origin of the sea debris (in terms of packaging). Finally, data was introduced data from a Slovenian survey, ordered by the Ministry for the Environment and Spatial Planning to the Institute for Water of the Republic of Slovenia (IWRS) and the National Institute of Biology, Marine Biological Station Piran.

The aim of the study was to explore the features of the spatial distribution and share of plastic debris washing up on the shores of three remote island areas compared to the Slovenian coastal area. In terms of the Croatian survey areas, they are isolated, mostly depopulated regions, except during summer, whereas the Slovenian coastline is quite urbanised.

The Croatian coastal areas were researched in 2018, 2019 and 2021, using a sea kayak as a means of transport. The survey was organised by the Faculty of Environment Protection, Velenje. The methodology was prepared in cooperation with the University of Zadar, Department of Geography. Data for the debris deposited ashore Slovenia were collected in 2017 [3].

The censuses were carried out in spring, when, due to the seasonally variable dynamics of the circulation of marine currents in the Adriatic Sea, higher quantities of marine debris are expected [4], [5].

The indicator method was used in a systematic inventory of the coastal ecosystem of the Croatian islands [6], [7]. The selection was based on their relevance and the possibility of comparing different coastal areas. The method was preliminarily developed for the Kornati archipelago. The authors focused on 1) the composition, b) the quantity and 3) the number of waste sites on the coast. The IWRS method followed Directive 56/2008/EC [8], where only the number of waste/100m and the total mass are inventoried.

Four Adriatic coastline areas impacted by marine debris are described, all of which are economically dependent on tourism, which can also be classed as a driving force of pollution. In terms of the physical-geographical factors, the authors assumed the wind direction and the southeast west Adriatic current (WAC) along the western Adriatic coast as the prevailing influence in relation the distribution of sea debris in the Adriatic Sea. Therefore, the distance to the Otranto Gate has determined the level of the coast area burden and sea litter deposited ashore.

The Slovenian research method focused on debris material. The authors found that the shore is mainly polluted by plastic waste (81.1%), followed by glass and ceramics (12.8%), metals (1.8%), textiles and paper waste (1.2%), wood (1%), rubber waste (0.7%) and other unidentified waste (0.1%). The most common plastic waste is: cigarette butts and filters (25%), pieces of polystyrene (9%) and pieces of plastic (8.4%) (for which no source can be identified), shopping bags (4%), and cotton buds (3.6%). The amount of litter increased over the period from 2014 to 2017, while the weight of the distributed litter on the coast was decreased. It is assumed that marine litter is getting lighter and smaller [3].

In accordance with EC Decision 2017/848 [9] and Directive 56/2008/EC [8], the authors evaluated the essential features of marine waters under the jurisdiction of the Republic of Slovenia. Debris has one of the greatest exposed and recognised anthropogenic impacts on the status of marine waters. Their assessment in the microplastics category is reported with an increasing trend in the Slovenian part of the Adriatic Sea. Data for the larger categories (meso, macro, megaplastics), which are partly a stock for microplastics, and should be surveyed similar to the Croatian pattern. This would upgrade the monitoring of Slovenia's marine waters under the jurisdiction of the Republic of Slovenia. The industry has a commitment to focus relentlessly on ensuring plastics continue to enable and deliver benefits valued by society, while minimising their environmental footprint [2].

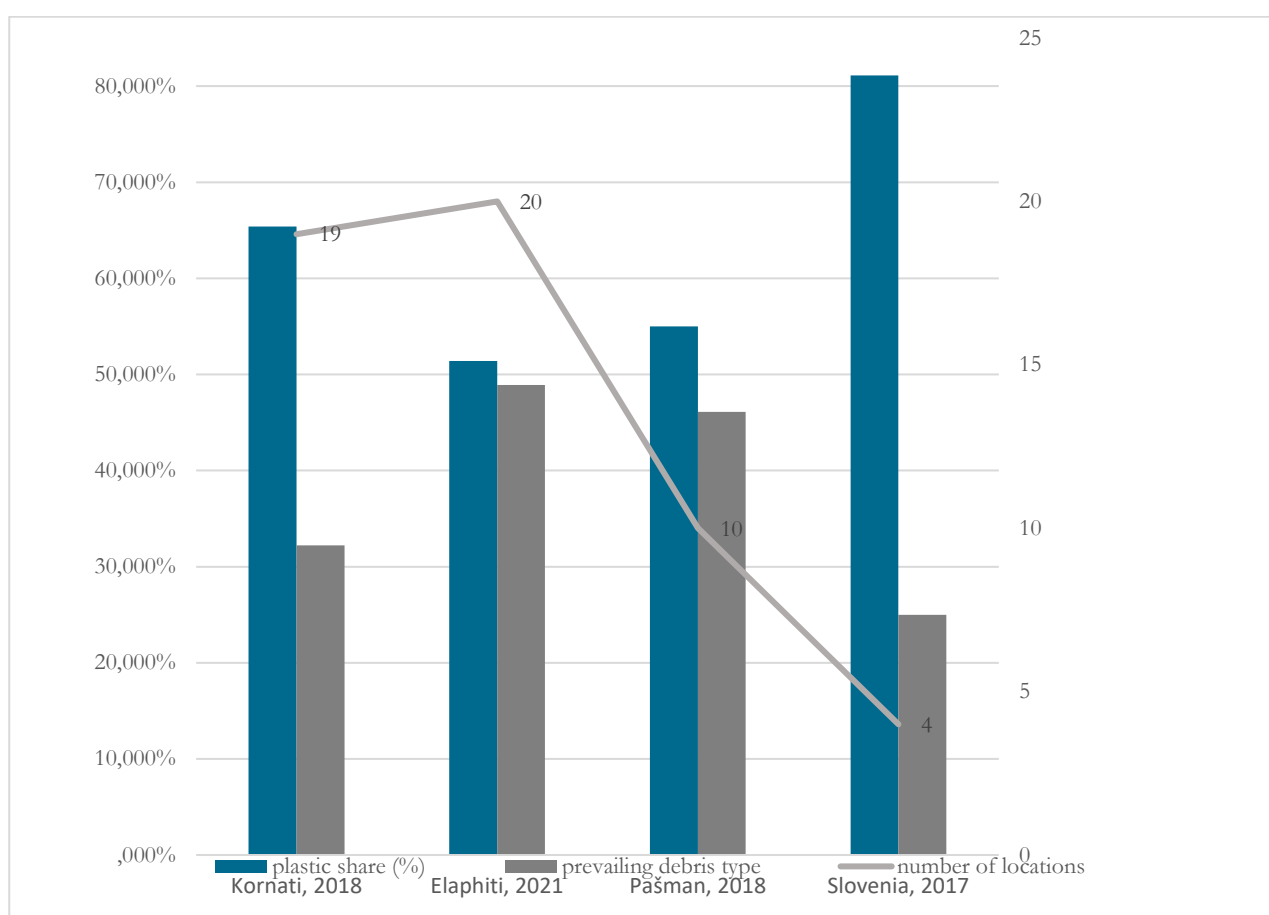

Figure 1: Share of plastics and prevailing debris type at the researched coastal locations

Source: own.

In terms of the share of debris plastic, the highest value was recorded for the Slovenian locations (81.1%), followed by the Kornati (65.4%) area. The island of Pašman accounted for a 55% share while the Elaphiti archipelago had the lowest share of 51.4%.

The indicator of the prevailing type of litter exposed the highest share of biomass in the Elaphiti aquatory (48.9%), 46.1% of the litter on the island of Pašman was fishing equipment (category other) while in the Kornati area, 32.1% was household debris (nautical tourism). In Slovenia, cigarette butts and filters accounted for the highest share (25%).

References

- [1] Plastics Europe, 2021. <https://plasticseurope.org/>
- [2] Plastics Europe, 2022. <https://plasticseurope.org/>
- [3] Ministry of Environment and Spatial Planning of the Republic of Slovenia: Update of the Initial Assessment of the State of Marine Waters under the Jurisdiction of the Republic of Slovenia, 2019. https://www.gov.si/assets/ministrstva/MOP/Dokumenti/Voda/NUMO/presoja_stanja_morskih_voda_2cikel.pdf
- [4] Institute for Water of the Republic of Slovenia (IWRS): DeFishGear project, 2017. <https://defishgear.net/images/pdf/leaflet/defishgear-leaflet-sl.pdf>
- [5] S., Liubartseva, G., Coppini, R., Lecci, S., Creti: *Regional approach to modeling the transport of floating plastic debris in the Adriatic Sea*, Marine Pollution Bulletin, Volume 103, Issues 1-2, 2016, Pages 115-127, ISSN 0025-326X, <https://doi.org/10.1016/j.marpolbul.2015.12.031>.
- [6] M., Kovač Viršek, K., Klančnik, Š., Koren, H., Caserman, K., Jarni A., Popit, U., Robič, R., Kaučič, Š., Trdan, S., Šantl: *Upgrading methodologies for monitoring and assessment of the marine environment: Report on the results of pilot monitoring of macro- and micro-waste in the surface layer of the water column and on the seabed, and on the results of sampling and analysis of microplastics in organisms - final report. 2018. III/11.*
- [7] N., Špeh, R., Lončarić, K., Breznik, M., Surić. *Burden of the Coastal Area with Solid Waste in Kornati National Park (Croatia)*. V: M., Krevs (ur.). *Hidden geographies*, (Key challenges in geography. 2021, Springer Nature. doi: 10.1007/978-3-030-74590-5_7.
- [8] N., Špeh, A. Čuka: *Challenges of waste management in isolated coastal environments: A case study of Pašman island, Croatia*. V: *EUGEO 2021 : 8th EUGEO Congress on the Geography of Europe : June 28-July 1, 2021, Prague, Czechia : book of abstracts*. [Prague]: Faculty of Science of Charles University: Czech Geographical Society. [2021], str. [163]. <https://guarant.eu/eugeo2021/files/book/eugeo-2021-book-of-abstracts.pdf>. [COBISS.SI-ID 70408707]
- [9] *Directive 2008/56/EC* of the European Parliament and of the Council (Marine Strategy Framework Directive), 2008.
- [10] *Directive (EU) 2017/848* amending Directive 2008/56/EC of the European Parliament and of the Council, 2017.

REASONS AND STRATEGIES FOR REDUCING HEALTH RISKS DUE TO POLLUTION BY HEAVY METALS RESULTING FROM ENERGY PRODUCTION

BORUT VRŠČAJ

Faculty of Environmental Protection, Velenje, Slovenia
borut.vrscaj@fvo.si

Keywords: soil, contamination, human health risks, soil ecosystem services, monitoring

Fossil fuel combustion, smelting, energy and industrial production, waste disposal and transportation are the main anthropogenic sources of contaminants or, in other words, potentially toxic elements (PTE) in the environment. Energy production, especially the combustion of Cd-rich coals, release heavy metals such as Cd, Cu, Pb and Zn into the atmosphere. In the past, before the use of filters in thermal power plants, the production of electric energy emitted significant amounts of heavy metals (HM) into the atmosphere, from where they were deposited in surface waters, biota and soil where they enriched natural concentrations (natural backgrounds [2,6]). Whilst it is true that the impact of modern power plants is much less than it was decades ago, the burdens of environmental pollution from the past continue to threaten human and ecosystem health.

Soil is a natural resource – a relatively thin layer that covers rock or other parent material and consists largely of weathered or altered mineral particles, organic matter and soil biota. Among the many physical, chemical and biotic properties, fertility is considered a virtue and complex property of soil that critically enables life in terrestrial ecosystems. In addition, soil provides a number of important ecosystem services [5] that are essential for humans, animals locally and climate globally. It is important to maintain healthy soil [15].

For this reason, the new EU Soil Strategy for 2030 has been prepared and will be adopted in 2023 [3,16]. The Government of the Republic of Slovenia is actively participating in the discussions on the EU Soil Directive [9].

Extensive research has shown that soil pollution can seriously affect the main ecosystem services provided by soil [4] and has a direct and indirect impact on human and ecosystem health, both of which are closely related to soil quality and, in particular, its pollution level [7]. Soil is considered as a sink and, when the HM binding capacity of soil is exceeded, it is also considered a source of pollution. Soil acts as a perfect trap: pollutants are adsorbed on soil particles, mainly clay and organic matter, and can be released when chemical conditions in the soil change. In this way, the HM become bioavailable, thus posing a risk to human and ecosystem health.

Human health risk assessments [7] evaluate the danger of the release of contaminants from soil particles. According to the Food and Agricultural Organisation of the United Nations (FAO) 'Risk assessment approaches are similar worldwide and consist of a series of steps to be taken to identify and evaluate whether natura

l or human-made substances are responsible for polluting the soil, and the extent to which that pollution is posing a risk to the environment and to human health' [4]. Remediation of polluted soils is an important process for improving the environment and human living conditions. Researchers are constantly developing new methods for soil remediation. Unfortunately, soil remediation is usually limited by the significant cost, time constraints and, most importantly, collateral damage (excavation, transportation, dust and noise emissions, disposal area) that occurs to the environment, infrastructure and living conditions of residents. Where soil cannot be remediated for local reasons, land use should be adjusted to minimise the risk of contaminated soil to the environment and human health. The first step is to spatially assess soil contamination in the affected areas [10]. Land use can also be changed or appropriate planning decisions can be made to change land use and limit the pathways and movement of contaminants from soil into the human body or further into the ecosystem.

Gardening in urban areas is a recreational and social activity that is growing in importance. On polluted soils, gardening can lead to significant dietary HM exposure, especially in the case of Cd contamination [1]. The application of protective measures can significantly reduce the health risk on low-polluted soils [8,11-14].

This paper describes the mechanism of heavy metal binding in soil and briefly discusses the bioavailability and pathways of heavy metal exposure to humans (ingestion, food chain, inhalation and dermal contact). Strategies are then proposed for effective spatial identification of human health risks due to soil contamination associated with urban and agricultural land use. Finally, the importance of raising public awareness of soil pollution and sharing scientific knowledge on how to live safely and reduce human health risks in areas affected by industrial pollution is noted.

References

- [1] Alterra - Sustainable soil management, Alterra - Soil, water and land use, Sub-department of Toxicology, VLAG, WIMEK, R.P.J.J. Rietra, G. Mol, I.M.C.M. Rietjens, and P.F.A.M. Römkens. 2017. *Cadmium in soil, crops and resultant dietary exposure*. Wageningen Environmental Research, Wageningen. DOI:<https://doi.org/10.18174/403611>
- [2] Manfred Birke, Clemens Reimann, Uwe Rauch, Anna Ladenberger, Alecos Demetriades, Fabian Jähne-Klingberg, Koen Oorts, Mateja Gosar, Enrico Dinelli, and Josip Halmić. 2017. GEMAS: Cadmium distribution and its sources in agricultural and grazing land soil of Europe — Original data versus cl-transformed data. *Journal of Geochemical Exploration* 173, (February 2017), 13-30. DOI:<https://doi.org/10.1016/j.gexplo.2016.11.007>
- [3] EU Parliament. 2021. EU Soil Strategy for 2030. Retrieved November 22, 2021 from https://ec.europa.eu/environment/publications/eu-soil-strategy-2030_en
- [4] FAO (Ed.). 2018. *Soil Pollution: a Hidden Reality*. FAO, Rome, Italy. Retrieved from <http://www.fao.org/global-soil-partnership/resources/highlights/detail/en/c/1127426/>
- [5] Clemens Geitner, Michele Freppaz, Jurka Lesjak, Elisabeth Schaber, Silvia Stanchi, Michele D'Amico, and Borut Vrščaj. 2019. *Soil Ecosystem Services in the Alps. An introduction for decision-makers*. Kmetijski inštitut Slovenije [Agricultural Institute of Slovenia], Ljubljana.
- [6] Mateja Gosar, Robert Šajn, Špela Bavec, Martin Gaberšek, Valentina Pezdir, and Miloš Miler. 2019. Geochemical background and threshold for 47 chemical elements in Slovenian topsoil. *Geologija* 62, 1 (March 2019), 5-57. DOI:<https://doi.org/10.5474/geologija.2019.001>
- [7] Laura Poggio, Borut Vrščaj, Erwin Hepperle, Rainer Schulin, and Franco Ajmone Marsan. 2008. Metals pollution and human bioaccessibility of topsoils in Grugliasco (Italy). *Environmental Pollution* 167, (2008), 680-689. DOI:<https://doi.org/doi:10.1016/j.envpol.2008.08.009>
- [8] Tomaž Vernik and Borut Vrščaj. 2014. Težke kovine v tleh vrtov. *Biobrazda* 2, 6 (2014).
- [9] Vlada RS. 2021. Stališče Vlade RS do Strategije EU za tla za leto 2030.
- [10] Borut Vrščaj, Laura Poggio, and Franco Ajmone Marsan. 2008. A method for soil environmental quality evaluation for management and planning in urban areas. *Landscape and Urban Planning* 88, 2-4 (December 2008), 81-94. DOI:<https://doi.org/10.1016/j.landurbplan.2008.08.005>
- [11] Borut Vrščaj, Ana Seifert, Janez Bergant, Tomaž Kralj, and Marjan Šinkovec. 2015. *Navodila za vzorčenje tal - Ukrepi za remediacijo onesnaženih tal na vrtovih in območjih vrtničkarstva in ukrepi za zmanjšanje prehoda težkih kovin iz tal vrtov v vrtnine v Celju*. Kmetijski inštitut Slovenije [Agricultural Institute of Slovenia], Ljubljana, Slovenia [Slovenia].
- [12] Borut Vrščaj, Ana Seifert, Janez Bergant, Tomaž Kralj, and Marjan Šinkovec. 2015. *Pridelava vrtnin na vrtovih mesta Celje - Ukrepi za remediacijo onesnaženih tal na vrtovih in območjih vrtničkarstva in ukrepi za zmanjšanje prehoda težkih kovin iz tal vrtov v vrtnine v Celju*. Kmetijski inštitut Slovenije [Agricultural Institute of Slovenia], Ljubljana, Slovenia [Slovenia].
- [13] Borut Vrščaj, Ana Seifert, Janez Bergant, Tomaž Kralj, and Marjan Šinkovec. 2015. *Ukrepi za varno vrtnarjenje - Ukrepi za remediacijo onesnaženih tal na vrtovih in območjih vrtničkarstva in ukrepi za zmanjšanje prehoda težkih kovin iz tal vrtov v vrtnine v Celju*. Kmetijski inštitut Slovenije [Agricultural Institute of Slovenia], Ljubljana, Slovenia [Slovenia].

- [14] Borut Vrščaj, Ana Seifert, Janez Bergant, Tomaž Kralj, and Marjan Šinkovec. 2015. *Vsebnost kovin v tleh in sprejem kovin iz tal v vrtnine - Ukrepi za remediacijo onesnaženih tal na vrtovih in območjih vrtničarstva in ukrepi za zmanjšanje prehoda težkih kovin iz tal vrtov v vrtnine v Celju* [The heavy metal content in soils and uptake of metals to vegetables - Measures to reduce the HM uptake to the garden vegetables in Celje. Kmetijski inštitut Slovenije [Agricultural Institute of Slovenia], Ljubljana, Slovenia [Slovenia].
- [15] Global Soil Health Indicators and Assessment | FAO SOILS PORTAL | Продовольственная и сельскохозяйственная организация Объединенных Наций. Retrieved May 9, 2022 from <https://www.fao.org/soils-portal/soil-degradation-restoration/global-soil-health-indicators-and-assessment/ru/>
- [16] Common Forum - EU Soil Strategy debate - Soil Directive Alternative. Retrieved May 3, 2021 from https://www.commonforum.eu/eusoilstrat_SoilDirectiveAlternative.asp

EVALUATION OF THE TOXIC POTENTIAL OF CHEMICALS IN COSMETICS USING COMPUTATIONAL TOXICOLOGY APPROACH

ŠPELA HVASTJA, ANJA BUBIK

Faculty of Environmental Protection, Velenje, Slovenia
anja.bubik@fvo.si, spelahvastja@hotmail.com

Keywords: GreenGate, Erasmus+, cosmetics, computational toxicology, public awareness, Toxtree, toolbox, safety assessment

In today's fast-developing world with massive expansion of different chemicals, there is an urgent need for their effective characterisation and assessment of their safety. This is also the case in the field of cosmetics and personal care products, where a vast variety of new products are released onto the market on a daily basis. *In silico* toxicology is one type of toxicity evaluation that uses computational methods to analyse, simulate, visualise or predict how harmful a chemical can be [1]. In modern science *in silico* means experimental techniques performed by computers. Computational methods are gaining more attention and are also preferred by regulatory authorities as an alternate safety assessment for *in vivo* or *in vitro* approaches. The Environmental Chemicals Agency (ECHA), which is responsible for implementing and administering the EU's REACH chemicals legislation and maintains one of the world's largest regulatory databases on chemicals, is also developing and supporting *in silico* approaches [2]. The quantitative structure-activity relationship (QSAR) approach represents one of the modern methods in computational toxicology analysis and can be used for rapid prediction of various toxicological endpoints. It is a computational modelling method for studying and identifying relationships between the structural properties of chemicals and their properties [1, 3].

The ongoing Erasmus+ project titled '*GreenGate – Towards responsible choice and healthy use of cosmetic products*' is addressing the problem of insufficient knowledge and awareness among adults about harmful substances in cosmetics, cleaning and laundry products which are used on a daily basis (Figure 1). It also highlights the incorrect choice and use of these products, which can have a negative impact on the health of users and the health of the environment, therefore offering solutions. The project follows the *European Chemicals Strategy for Sustainability: Towards a Toxin-Free Environment (2020)*, one of the elements of the European Green Deal, which also sets out a new long-term vision for the management of chemicals in the European Union.



Figure 1: GreenGate project

Source: Project GreenGate (EU Erasmus+ programme)

Some consumers might find the ingredients and reading the labels an unsolvable and confusing challenge, which leaves them unaware of what a product really contains. To solve this issue, *GreenGate* also aims to create various innovative e-learning solutions and promote the use of computational toxicology data and tools. Some preliminary tests have already been performed to find the easiest, most user-friendly and reliable computer tools for determining the toxic potential of cosmetic ingredients and to equip adults with the knowledge and skills to make the right choices and use healthy products. For the purposes of this paper, the authors chose two QSAR tools – QSAR Toolbox and Toxtree [4, 5] – for the research of harmful chemicals, such as dibutyl phthalate (DBP), triclosan, zinc pyrithione and others. These two tools not only help to educate and inform consumers about the potentially toxic chemicals in products used every day while helping to protect the environment, but also prevent massive increases in animal testing, thus reducing it to a minimum, as well as optimising the leading related compounds with a decreased toxicity, providing a better understanding of how chemicals and pharmaceuticals work, predict toxicity using a category approach before they are synthesised and aim to achieve sustainable development green chemistry.

The authors' future aim is to test as many chemicals as possible, based on a review of existing literature and ECHA guidelines with the goal of confirming existing data and gaining some new information on chemicals, which are still widely used without any restrictions or only have minor restrictions, in cosmetic products.

References

- [1] A.B. Raies and V.B. Bajic: *In silico toxicology: computational methods for the prediction of chemical toxicity*, WIREs Computational Molecular Science, 6, p.p.147-172, 2016.
- [2] *Environmental Chemicals Agency (ECHA)*: <https://echa.europa.eu/en/home>
- [3] A. Cherkasov et.al.: *QSAR Modeling: Where Have You Been? Where Are You Going?*, Journal of Medicinal Chemistry, 57, p.p.4977-5010, 2014.
- [4] S. Bhatia, T. Schultz, D. Roberts, J. Shen, L. Kromidas, A.M. Api: *Comparison of Cramer classification between Toxtree, the OECD QSAR Toolbox and expert judgment*, Regulatory Toxicology and Pharmacology, 71, p.p.52-62, 2015.
- [5] *QSAR ToolKit*: <https://qsartoolbox.org/about/>

ADSORPTION PROPERTIES OF GEOLOGICAL MATERIALS FOR CO₂ STORAGE

TANJA TAJNIK

Faculty of Environmental Protection, Velenje, Slovenia
tanjatajnik@gmail.com

Keywords: carbon dioxide; carbon capture and storage; CCS; adsorption; rocks; gravimetric method

Greenhouse gas emissions, and CO₂ in particular, have become an increasing concern in the power generation industry. The power sector is responsible for the majority of greenhouse gas emissions, especially as CO₂ is released through the combustion of fossil fuels. Many mechanisms are being investigated to reduce CO₂ emissions, one of which is carbon capture and storage (CCS). There are several approaches to capture CO₂. Some are based on capturing CO₂ near the source of emission, others on recovering CO₂ from the atmosphere, possibly long after its emission. Some require the use of new technologies that have yet to be developed; others rely on the use and control of natural mechanisms or a combination of both.

CCS involves injecting CO₂ under high pressure into very deep underground rock layers. In many areas, these rocks already securely hold fluids such as oil, natural gas, or water that is too salty to be used - saline aquifers. A number of natural confinement mechanisms hold these natural fluids in place, often for millions of years. These mechanisms can do the same for CO₂. CO₂ itself is safely trapped in rock layers in many places around the world. Geologists searching for CO₂ reservoirs look for rock formations that already contain fluids and therefore have been shown to have these mechanisms. Evaluating the realistic CO₂ adsorption capacities of different rocks is important for understanding the processes associated with CO₂ storage. In this paper, the adsorption properties of rocks

for CO₂ (limestone, sandstone, marl, mudstone, claystone, siltstone, and metamorphic rocks) are investigated using a gravimetric method. Measurements were made at 21°C and pressures ranging from 1 to 4 MPa. Sandstone (and clay with sand/sandstone) showed the highest adsorption capacity at 21°C. The highest content of in situ CO₂ in the measured samples was 21.4 kg/t. The CO₂ adsorption capacities were lower than the previous results for various coal samples. The results suggest that the adsorption of CO₂ in rocks may play an important role in storing CO₂ in subsurface rocks. For the storage of CO₂ in rock masses, we need to select a suitable rock type that can safely store enough CO₂ and contribute to the mitigation of climate change.

An important motivation for this study was the opportunity to reduce carbon emissions from Slovenia's largest thermal power plant, Šoštanj Thermal Power Plant (TEŠ), which generates on average one-third of Slovenia's energy and, in emergency situations, more than half of the national demand.

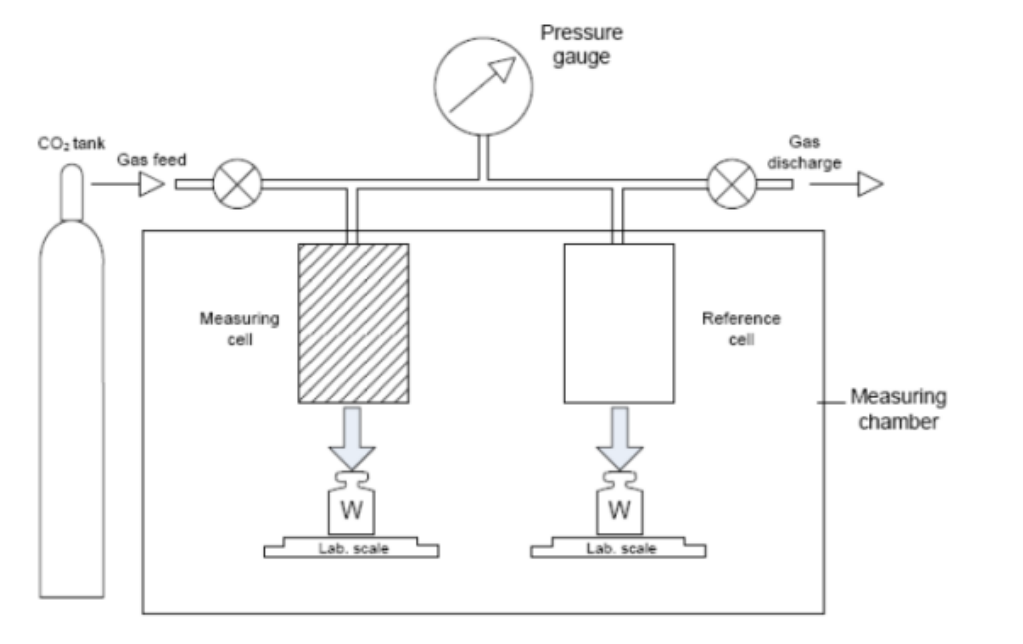

Figure 1: System for gravimetric measuring of the CO₂ amount in geological materials - MAS-54

Source: own.

CO₂ adsorption capacities were determined by a gravimetric method. From our work, it can be concluded that sandstone is the material that adsorbs the most CO₂, probably due to its composition and other properties such as porosity and permeability. It can be seen that pressure has an effect on the amount of CO₂ adsorbed in almost all geological materials. The exception is sandstone, where a lower pressure resulted in a higher adsorption capacity of the material.

ESTIMATION OF REAL DRIVING EMISSIONS BASED ON DATA FROM OBD

MATEJ FIKE, ANDREJ PREDIN

University of Maribor, Faculty of Energy Technology, Krško, Slovenia
matej.fike@um.si, andrej.predin@um.si

Keywords: vehicle, diesel engine, exhaust emission levels, real driving emissions

A fundamental factor leading to technology development in all branches of industry is the need to reduce its negative impact on natural environment. Transport is one of the most dynamically changing fields of economy, particularly due to the ever-changing exhaust emission levels. It was considered that type approval tests carried out in laboratory conditions (on a chassis dynamometer) are not sufficient. Complementary exhaust emissions testing in real traffic conditions has been introduced to amend that. Such real traffic conditions maybe characterized by variability of parameters while the values of exhaust emissions cannot be greater than those specified in the relevant regulations. According to the Commission Regulation (EU) 2016/646 of 20 April 2016 amending Regulation (EC) No. 692/2008 a new emissions norm Euro 6d-Temp has been established. The requirements of this norm are an extension of the Euro 6 emissions norm regarding road exhaust emissions of nitrogen oxides (NO_x) and the particle number (PN) emissions for passenger cars, as well as introducing conformity factors (excess emissions) which have been given the value of 1.43 (from 2020). The real driving emissions (RDE) procedure has been introduced in the European Union by Regulation 2017/1151 of 1 July 2017 and updated by Regulation 2017/1154 of 7 July 2017.

The aim of this study was to compare and evaluate the production of exhaust emissions from a vehicle with diesel engine with the Euro 6 emission standard. The measurements data were obtained with ELM 327 OBD scanner. The scanner was connected to the car's OBD port and was used to communicate with the OBD system of vehicle. Further, the android app was used, which communicates with the OBD system of vehicle using Bluetooth connectivity and records data received from a car for further evaluation and processing.

Measurements were performed during real operation, which means that the results are fully usable and applicable in practice. A commercially available family car was selected. Two real driving tests were performed. The total distance of the test routes was 96 km and 261 km, respectively. The results from the individual driving test allowed the determination of the exhaust emissions. Emissions of CO₂ and NO_x were monitored as a matter of priority. On the first test route 4.8 liters of diesel fuel was used. Calculated fuel consumption was 5.02 l/100 km. Emission of CO₂ was 12.68 kg or 132 g CO₂/km. From sensor NOx2 data emissions of NO_x were calculated 0.0296 g/km. On the second test route 10.34 l of fuel was spend and the average fuel consumption was 3.96 l/100 km. The concentrations of CO₂ and NO_x emissions were 105 g/km and 0.0215 g/km, respectively. Average CO₂ and NO_x emissions were in line with Euro 6 emissions standard, but further analysis of the data showed (figure 1) that instantaneous emissions were much higher than the permitted limits.

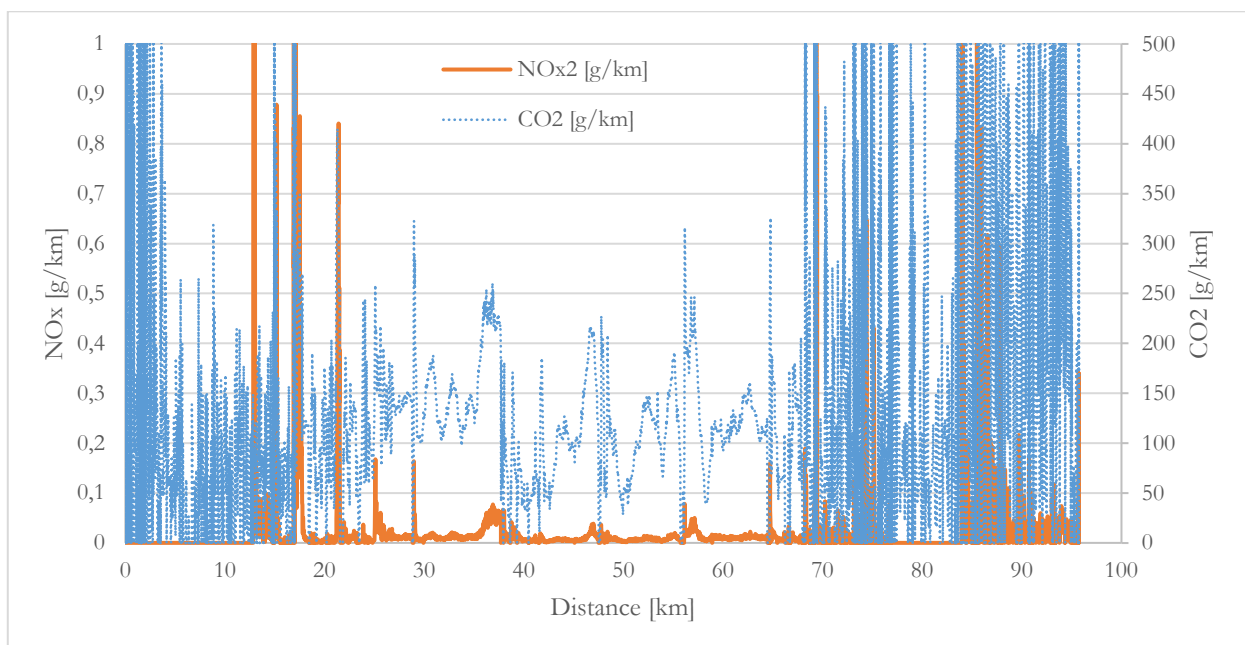

Figure 1: Instantaneous emissions of NO_x and CO₂ for route 1

Source: own.



<EnRe>
energy & responsibility

RENEWABLE ENERGY, ELECTRICAL
MACHINES AND SMART GRIDS



ANALYSIS OF A FAST FAULT CURRENT OF INVERTER-INTERFACED DISTRIBUTED GENERATIONS

BOŠTJAN POLAJŽER, JERNEJ ČERNELIČ

University of Maribor, Faculty of Electrical Engineering and Computer Science, Maribor, Slovenia
bostjan.polajzer@um.si, jernej.cernelic@um.si

Keywords: battery energy system, fast fault current, photovoltaic power plant, power electronic inverter, requirements for generators

Inverter-interfaced distributed generation (IIDG) can inject a fast fault current (FFC) at the connection point in case of symmetrical and asymmetrical network faults [1], as specified by a relevant transmission system operator. Requirements for FFC provision have already been implemented in national network codes, e.g. the Slovenian requirements [2] are similar to the German ones [3]. Static requirements for FFC activation are given by the FFC-voltage droop characteristics, separately for the positive- and negative-sequence components. The parameters of the FFC-voltage characteristics proposed in [2] are $\pm 20\%$ for the voltage dead-band, a slope (droop) $2 \leq \Delta I_{pu} / \Delta U_{pu} \leq 6$, whereas the maximal value should not exceed 80% of the overcurrent protection setting of the IIDG. However, the magnitude of line currents is limited to a typical value 1.2pu of an inverter capacity. Furthermore, the network code [2] prioritises a reactive FFC, while an active current should be readjusted continually. The dynamic requirements for FFC activation are given by a delay time of 20ms, a step response time of 30ms, and a settling time of 60ms. Further requirements are also given for a total FFC activation time and for FFC deactivation. Note that the discussed FFC provision in Slovenia only applies to new IIDGs with a rated capacity of 150kW and over [4]. New generations of generic IIDG models incorporate balanced FFC injection based on a voltage sag logic [5], however,

existing literature mainly suggests control approaches for unbalanced FFC injection during asymmetrical network faults. A comprehensive review is given in [6]. The authors' previous research on FFC injection was limited to phasor-based IIDG models, applied to a typical Slovenian 20kV network with radial feeders and the Nord-East part of the Slovenian 110kV network, wherein only transmission network faults were considered [7,8]. The results show more significant FFC injection by IIDGs in a weak transmission network, thus emphasising a negative-sequence FFC-voltage characteristic during asymmetrical faults. Furthermore, the response of the IIDGs significantly affects distance protection operation at the receiving end of the transmission line, albeit only in the cases of resistive faults. Moreover, distance protection operation is additionally influenced by the network topology, i.e. in radial network topology, operation of the remote relay can be delayed due to a largely seen impedance. Operation of the overcurrent protection during faults at the distribution level has yet to be examined. This study discusses the FFC injection of the most typical types of IIDGs in Slovenia, i.e. photovoltaic, and battery energy storage. Instantaneous IIDG models are considered using different FFC injection concepts. Figures 1 and 2 show the time responses of a MATLAB/Simulink model of a 1MWp photovoltaic power plant during a symmetrical and asymmetrical network fault. A reactive FFC of 1.2pu was injected in both cases while keeping the nominal active current. Furthermore, line currents were limited to 1.2pu. Symmetrical responses are obtained during the symmetrical network fault, while responses during the asymmetrical network fault are asymmetrical. The settling time of line currents (magnitudes and angles) is within the required 60ms. The active reduction in power as well as the increase in reactive power are more significant during the asymmetrical network fault.

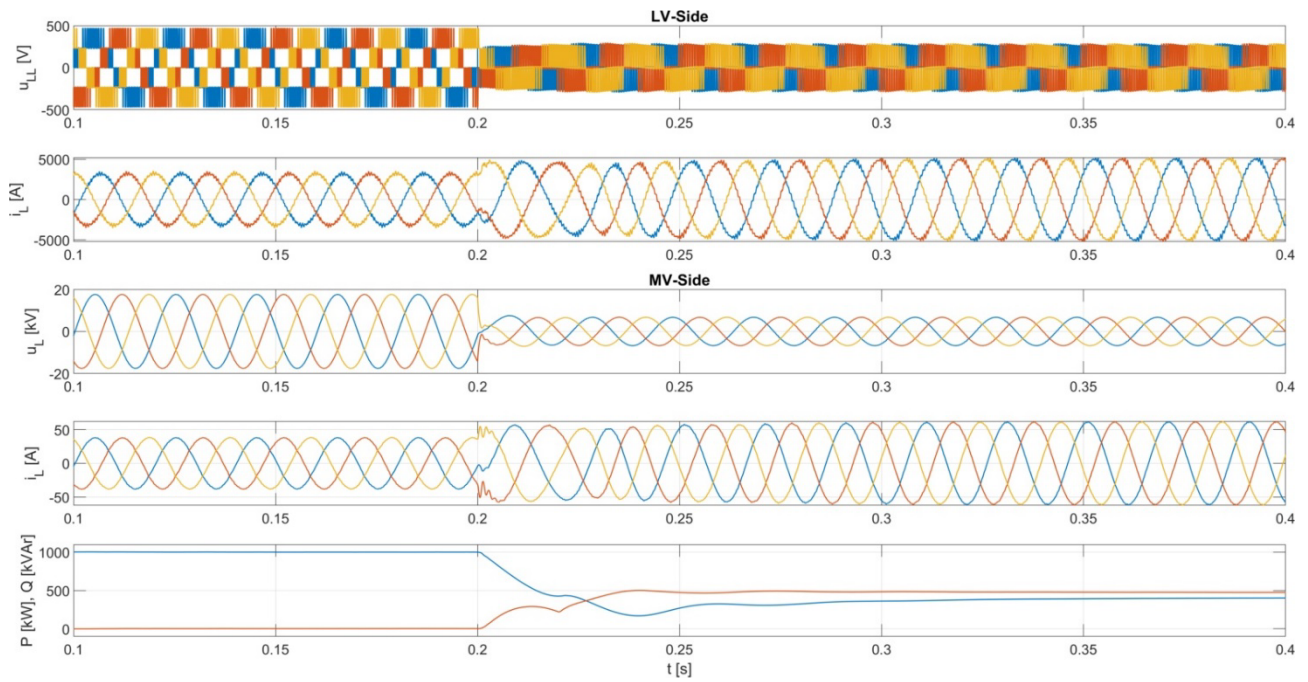

Figure 1: Time responses of a 1MWp photovoltaic power plant model with an FFC injection during a symmetrical network fault at 0.2 sec

Source: own.

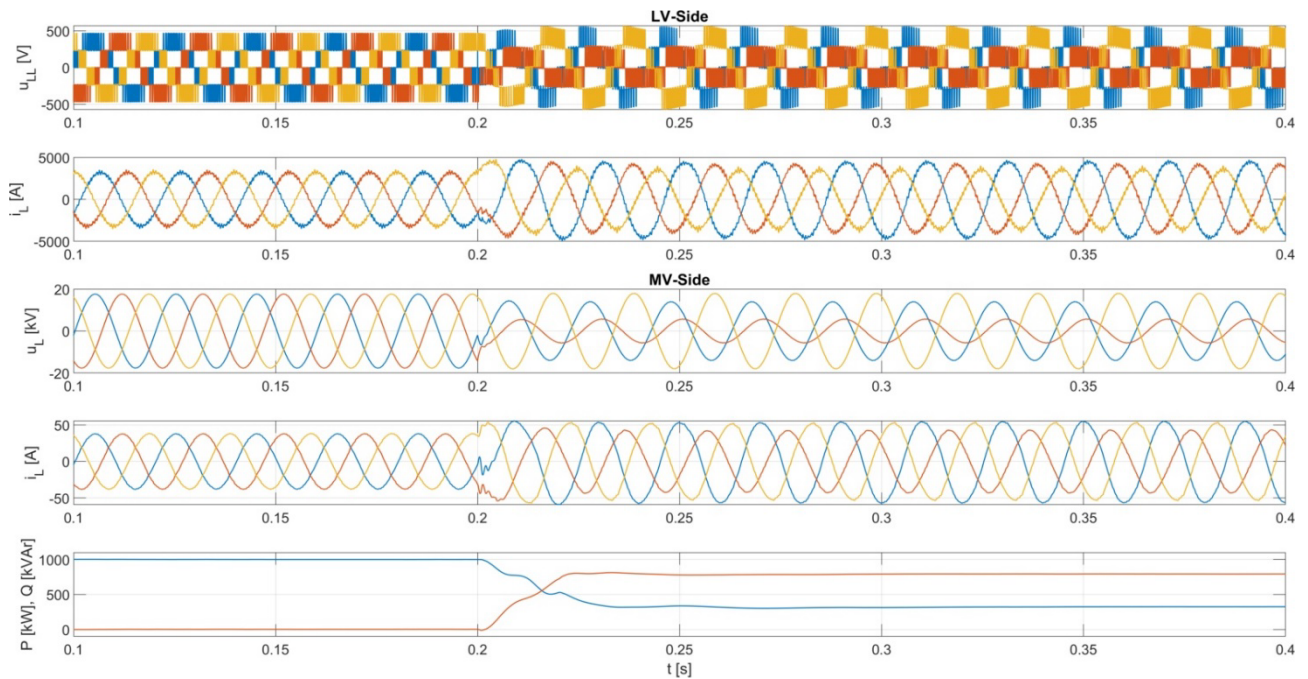

Figure 2: Time responses of a 1MWp photovoltaic power plant model with an FFC injection during an asymmetrical network fault at 0.2 sec

Source: own.

References

- [1] EUR-Lex. Establishing a Network Code on Requirements for Grid Connection of Generators; Commission Regulation (EU) 2016/631; European Union: Brussels, Belgium, 2016.
- [2] Potrditev predloga neizčrpnih zahtev iz Uredbe Komisije (EU) 2016/631 (in Slovenian), Energy Agency, Maribor, November 2018.
- [3] VDE-AR-N 4120:2017-05, Technical Requirements for the Connection and Operation of Customer Installations to the High-voltage Network (TCC High-Voltage), VDE Verlag GmbH, Berlin, May 2017.
- [4] Odobritev Predloga spremembe nacionalnega praga za elektroenergijske module tipa B (in Slovenian), Energy Agency, Maribor, February 2022.
- [5] E. Farantatos: Model User Guide for Generic Renewable Energy System Models; Technical Update 3002014083; EPRI: Palo Alto, CA, USA, 2018
- [6] D. Celik; M.E. Meral: Voltage Support Control Strategy of Grid-Connected Inverter System under Unbalanced Grid Faults to Meet Fault Ride through Requirements. IET Gener. Transm. Distrib., 14, 3,198-3,210, 2020.
- [7] B. Polajžer, M. Pintarič, M. Topler, B. Grčar: Steady-State Response of Inverter-Interfaced Distributed Generations During Transmission Network Faults. IEEE International Conference IEEEIC/I&CPS Europe, Bari, Italy, 2021.
- [8] B. Polajžer, B. Grčar, J. Černelič, J. Ritonja: Power-Based Concept for Current Injection by Inverter-Interfaced Distributed Generations during Transmission-Network Faults. Applied Sciences, 11(21), 2021.

THE IMPACT OF UNBALANCED POWER SUPPLY ON LOAD CURRENTS IN TRANSIENT AND STEADY STATE OPERATION

NINA ŠTUMBERGER,¹ GORAZD ŠTUMBERGER²

¹ RWTH Aachen University, Aachen, Germany
nina.stumberger@rwth-aachen.de

² University of Maribor, Faculty of Electrical Engineering and Computer Science, Maribor, Slovenia
gorazd.stumberger@um.si

Keywords: unbalanced supply voltages, load currents, steady state, transients, Dommel's method, increase in released heat

Three-phase loads connected to the grid are designed for permanent operation when they are supplied with symmetrical three-phase voltages with rated parameters. Unfortunately, the supply voltage can become unbalanced due to faults and other causes of unexpected grid operation. The commonly accepted tools for the treatment of grid operation under an unbalanced voltage supply are the sequence components (zero – homopolar (0), positive (1), and negative (2)) that can be used only for quasi-steady-state operation. The objects of observation and analytical treatment using an analytical approach based on sequence components are often induction machines and their derating due to unbalanced supply voltages [1-2]. The level of voltage unbalance is usually given by the ratios among the positive V_1 , the negative V_2 , and the zero V_0 sequence phasor RMS values [3] (1.1).

$$VUF = \frac{V_2}{V_1}, \quad ZSVUF = \frac{V_0}{V_1} \quad (1.1)$$

In this study, Dommel's method [4] is applied to evaluate the impact of unbalanced supply voltages, with different VUF and ZSVUF values, on the currents of three-phase balance Y and D connected loads considering subtransient, transient and quasi-steady-state region of operation. The sum of squared instantaneous current values is normalised in each observation region to evaluate to what extent the unbalanced supply voltages influence the heat release in the form of Joule losses.

Figure 1 shows the applied Dommel's method-based circuit models for transient calculation of the current time behaviour of Y and D connected loads supplied with unbalanced voltages. Figure 2 shows the time behaviours of the three-phase currents of Y and D connected loads for $VUF=10\%$ and $ZSVUF=10\%$.

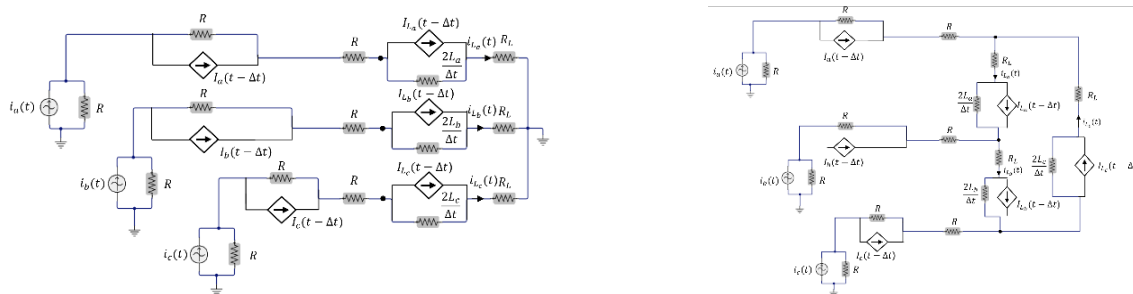

Figure 1: Dommel's model for Y and D connected 3 phase loads

Source: own.

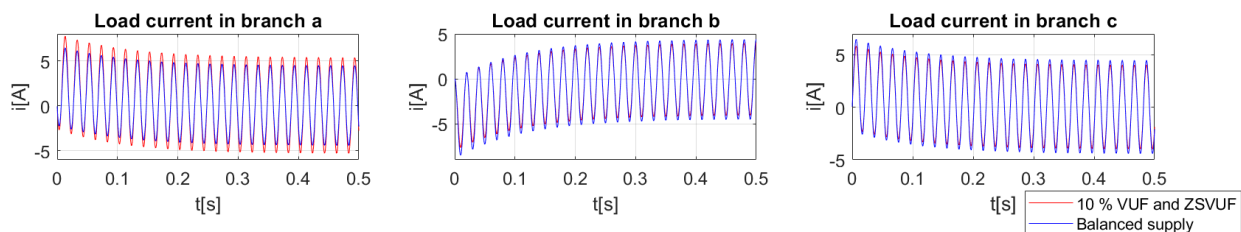

Figure 2: Calculated current time-behaviours of Y connected loads for VUF=10% and ZSVUF=10%

Source: own.

References

- [1] Enrique. C. Quispe, Ivan. D. Lopez: *Effects of unbalanced voltages on the energy performance of three-phase induction motors*, 2015 IEEE Workshop on Power Electronics and Power Quality Applications (PEPQA), p.p.1-6, 2015
- [2] Jawad. Faiz, Hamid. Ebrahimpour: *Precise derating of three-phase induction motors with unbalanced voltages*, Fortieth IAS Annual Meeting. Conference Record of the 2005 Industry Applications Conference, p.p.485-491, 2005
- [3] IEEE: *IEEE Recommended Practice for Monitoring Electric Power Quality*, IEEE, p.p.25-28, 2019
- [4] Jos. Arrillaga: *Computer modelling of electrical power systems*, Wiley, p.p.162-164, 2001

NEXT GENERATION SMART GRIDS (NG-SG) AS A FOUNDATION FOR INTRODUCING NEW SERVICES IN THE ENERGY INDUSTRY

MATJAZ KOLAR,¹ PRIMOŽ BRATANIČ²

¹ SODO d.o.o., Maribor, Slovenia

matjaz.kolar@sodo.si

² iLOL informacijske tehnologije d.o.o., Ljubljana, Slovenia

primoz@ilol.si

Keywords: smart grid, communication, services, networks

There is a growing awareness in society that energy and natural resources are limited. The efficient management of energy-generating products and natural sources decreases the consumption thereof and consequently lowers the environmental impacts. With a view to pursuing sustainable development, EU member states have adopted guidelines, the implementation of which will contribute to a decrease in electricity consumption and emissions and an increase in the share of production from renewable sources.

In order to be able to honour the commitments made, distribution networks must be upgraded with new technologies and interconnected in terms of communications. A system which is connected in this way has become known as a 'smart grid'. These advanced technologies also consist of, among others, advanced metering systems. Due to rapid technological development, particularly of the communication components of metering devices, the introduction of smart grids entails huge investment costs.

It is on this basis that a question arises as to whether the latest generation of meters (known as 3G PLC), the communication component of which is based on the OFDM modulation, will meet the throughput requirements which – apart from meter reading services performed for the purposes of billing – are dictated by new services (e.g. demand-response, dynamic tariffing...) as well as by services to emerge in the future. It could be said that when selecting optimal communication solutions in terms of technology and price, operators are facing the following challenges related to the mass introduction of smart grids:

- the use of traditional (PLC) communications within a network that was not initially designed for data transfer
- the use of public networks based on the IP protocol which, including their security mechanisms, have also become a universal platform for transferring sensitive information in the energy industry; such platforms have become known as the Internet of Things (IoT)

To make the decision easier, the paper depicts the practical limitations and issues encountered within traditional (PLC) networks with an emphasis on the OFDM modulation, making the IoT solution more adequate, especially in the long run, in particular if the introduction is planned with the view to achieving maximum synergy effects on related networks and the investments are also rationalised. The paper also describes some practical experience with an IoT solution that is used within the Sincro Grid project as well as some relevant services which are made possible by near-real-time data.

PHYSICAL, GEOGRAPHICAL, TECHNICAL AND ECONOMIC POTENTIAL FOR OPTIMAL CONFIGURATION OF PHOTOVOLTAIC SYSTEMS USING A DIGITAL SURFACE MODEL

PRIMOŽ MAVSAR, KLEMEN SREDENŠEK, SEBASTIJAN SEME

University of Maribor, Faculty of Energy Technology, Krško, Slovenia

E-mail address: primozmusa@hotmail.com, klemen.sredensek@um.si, sebastijan.seme@um.si

Keywords: photovoltaic system, photovoltaic potential, economic potential, LiDAR, optimisation, optimal configuration

The paper is in the form of a doctoral dissertation that deals with the photovoltaic potential of the selected area [1,2]. The method used divides the photovoltaic potential into four categories: physical, geographical, technical and economic. The photovoltaic potential is considered holistically, both from a technical and economic point of view. Individual potentials were determined on the basis of a 20-year average of measurements of the density of global and diffuse solar radiation on a horizontal surface near the study area. The economic potential was determined by taking into account the hourly electricity prices for a period of seven years. The impact of surface orientation and inclination on the photovoltaic potential for each potential category is shown. Based on the results of calculations of the maximum value of potentials when changing the surface configuration, the optimal configuration of the photovoltaic system for each individual potential was determined. In addition to this method, the differential evolution optimisation method is described, which determines the optimal configuration in an innovative and quicker way. For each individual potential, the digital surface model generated from the LiDAR data shows which areas have the greatest potential. The emphasis is on roofs. From the areas that would be potentially suitable for the installation of a photovoltaic system, the

individual potential for each month of the year, for the whole year and the annual average is calculated. The shading of the surroundings is also taken into account. It has been established that the price of electricity has a great influence on the economic potential of the photovoltaic system, as shown in Figure 1.

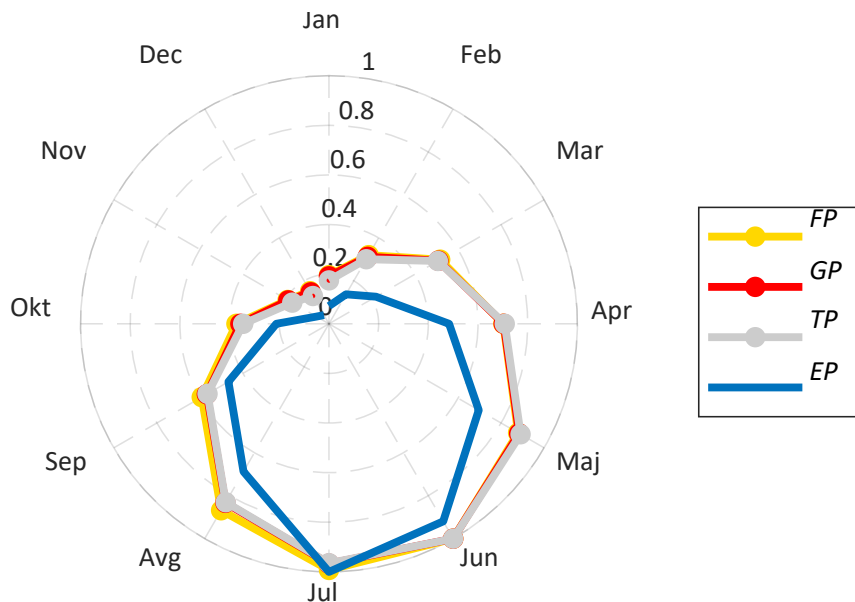

Figure 1: Comparison of PP, GP, TP and EP of the considered area

Source: own.

The results show that it will be necessary to pay more attention to economic potential than technical potential when installing photovoltaic systems in the near future and that annual produced electricity will no longer play the primary role but rather cash flows (income). This also results in a change in optimal configuration parameters compared to the method that only takes into account maximum electricity production or technical potential, which can have a strategic impact on decision-making policies to introduce PV systems in both urban and rural environments.

References

- [1] P. Mavsar: *Fizični, geografski, tehnični in ekonomski potencial za optimalno konfiguracijo fotonapetostnih sistemov s pomočjo digitalnih posnetkov območja*. doctoral dissertation, University of Maribor, Faculty of Energy Technology, 2021
- [2] K. Sredenšek, B. Štumberger, M. Hadžiselimović, P. Mavsar, S. Seme: *Physical, geographical, technical and economic potential for the optimal configuration of photovoltaic systems using a digital surface model and optimisation method*, Energy [Online ed.]. 2021, vol.242, art. 122971, pg. 1-13

OPTIMAL SCHEDULING OF HYDROELECTRIC POWER PLANTS ON THE DRAVA RIVER

SAŠO KRESLIN,¹ ADNAN GLOTIĆ,² MATJAŽ EBERLINC,²
CHRISTIAN HAUSLEITNER,³ DOMINIK HENTSCHEL,³ MILOŠ PANTOŠ,⁴
JERNEJ BRGLEZ,² MATJAŽ VEČERNIK,² LADO LESKOVEC,² JERNEJ OTIČ,²
DALIBOR KRANJČIČ¹

¹ Dravske elektrarne Maribor, d. o. o., Maribor, Slovenia
saso.kreslin@dem.si, dalibor.kranjcic@dem.si

² Holding Slovenske elektrarne d.o.o., Ljubljana, Slovenia

adnan.glotic@hse.si, matjaz.eberlinc@hse.si, jernej.brglez@hse.si, matjaz.vecernik@hse.si, lado.leskovec@hse.si, jernej.otic@hse.si

³ Siemens, Munich, Germany

christian.hausleitner@siemens.com, dominik.hentschel@siemens.com

⁴ Infinitas d.o.o., Ljubljana, Slovenia

milos.pantos@infinitas.si

Keywords: hydro scheduling and optimization, hydropower plant modelling and simulation, optimization techniques.

The HSE Group strives to take advantage of the synergies of a wide range of its production facilities with the aim of maximizing business efficiency. The operational and cost properties of individual production units differ from each other, so it is possible to achieve technically and/or economically more efficient production with an adequate combination of production schedules. Given the increasing intensity and complexity of production management, it is important to support the processes of planning electricity production and provision of ancillary services with an adequate system for optimisation of electricity generation and provision of ancillary services.

In order to materialize beforementioned aims, HSE started a project named “Introduction of a comprehensive optimisation system for electrical generation and ancillary services” in December 2021 by starting the implementation process of “joint Resource Optimization and Scheduler – jROS” solution from SIEMENS. Implementation will cover modelling of all controllable production units of HSE’s subsidiaries – Dravske elektrarne Maribor d.o.o. (DEM), Soške elektrarne Nova Gorica d.o.o. (SENG) and Termoelektrarna Šoštanj d.o.o. (TEŠ). In this paper some experiences related to modelling DEM/Hydro Power Plants on Drava River will be presented by focusing to specifics of Hydro Power Plant Zlatoličje.

jROS

jROS [1] is the component of Spectrum Power™ for the portfolio management of generation resources. It is integrating many applications and thus covering many aspects of optimizing power plants and contracts with seamless data flow between generation planning and energy trading. By using one versatile platform the administration efforts are expected to be minimized so users such as planners, dispatchers and traders may concentrate on their core business and thus making faster and most optimal decisions.

Implementation challenges

The biggest consideration in achieving the optimal scheduling is to obtain models of the hydropower plants (HPPs) that would adequately mathematically describe the dynamic behaviour of operating variables (i.e. water levels, heads, discharges etc.), at the same time the models should be simple enough to decrease the overall calculation time of the selected optimization procedure [2] – [4]. In this paper, the hydrological model is based on the complex topological structure consisting of the reservoirs, hydro generating units, channels and spillways. These components are determined by the water continuity equation, the reservoir and channel characteristics, the hydro generating unit characteristics and the hydrological constraints. Such modelling approach is a part of the Siemens HTC (Hydrothermal Coordination) tool consisting of the joint Resource Optimization and Scheduling (jROS) package.

The generated schedules are obtained by Mixed Integer Linear Programming (MILP) [5], [6]. This optimization technique has the following advantages when solving the hydro scheduling problem [6]: the nonlinearities can be efficiently incorporated by using the piecewise linear approximation [7] and the discrete nature of the problem can be introduced by adding integer variables or constraints.

The presented paper is focusing on the section of the Drava River between the HPP Mariborski otok and HPP Zlatoličje, with the Melje dam placed in-between, as shown in the Fig. 1.

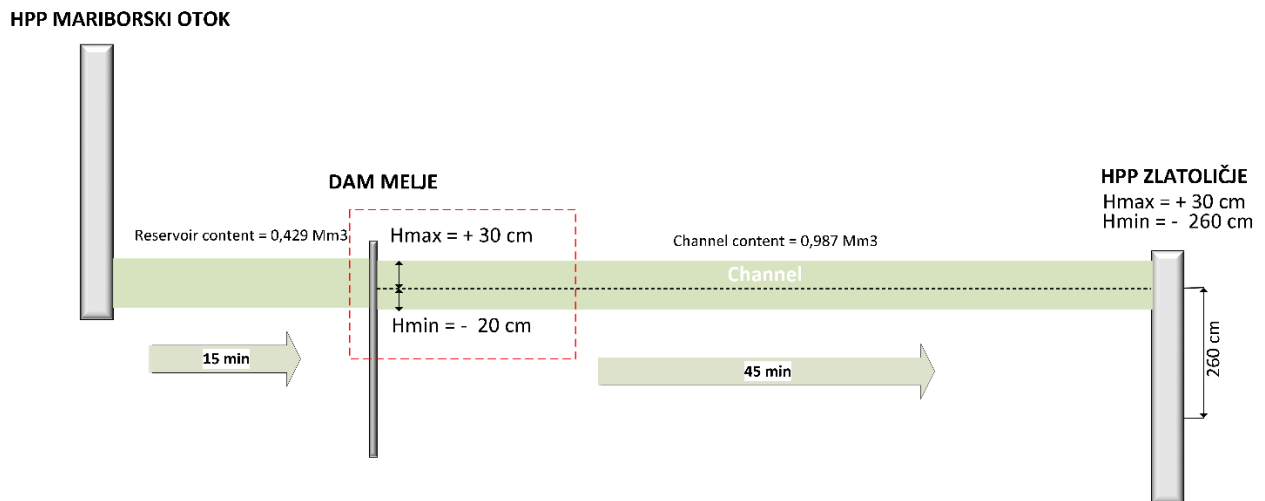

Figure 1: The section of the Drava River showing the Melje dam and HPPs Mariborski otok and Zlatoličje.

Source: own.

In this configuration, special attention is given to the following main points:

- The water accumulation capacity of both the HPP Mariborski otok reservoir and channel in front of the HPP Zlatoličje is relatively small in terms of the longest possible production time of the HPP Zlatoličje (i.e. approx. 30 minutes) that can be achieved without any flows released through the upstream HPP Mariborski otok.
- Water delay time from the upstream HPP Mariborski otok to the Melje dam, and from the Melje dam to the downstream HPP Zlatoličje is approx. 15 and 45 minutes, respectively.
- The water level at Melje dam can vary only in a very narrow range (+30, -20) due to the regulatory restrictions – see the marked red area in Fig. 1.

The paper describes the project group modelling activities and it gives a detailed overview of the proposed modelling solution based on the curve characteristics and the MILP technique.

References

- [1] SIEMENS, *Joint Resource Optimization and Scheduler, All forecasting and planning*, online resource: <https://assets.new.siemens.com/siemens/assets/api/uuid:d07e3975-0b9a-4a34-9daf-bf2160bf6ebd/sidg-b10057-00-7600jros-brochureen-300.pdf>.
- [2] Al Thaeer Hammid et al.: *A Review of Optimization Algorithms in Solving Hydro Generation Scheduling Problems*, Energies – MDPI, 2020.
- [3] Iram Parvez et al.: *Modeling and Solution Techniques Used for Hydro Generation Scheduling*, Water – MDPI, 2019.
- [4] Jiehong Kong et al.: *An overview on formulations and optimization methods for the unit-based short-term hydro scheduling problem*, Electric Power Systems Research – Elsevier, 2020.
- [5] Javier Garcia-Gonzalez et al.: *Short-term Hydro Scheduling with Cascaded and Head-Dependent reservoirs based on Mixed-Integer Linear Programming*, IEEE Porto Power Tech Conference, 2001.
- [6] Gary W. Chang et al.: *Experiences with Mixed Integer Linear Programming Based Approaches on Short-Term Hydro Scheduling*, IEEE Transactions on Power systems, 2001.
- [7] Claudia D'Ambrosio et al.: *Piecewise linear approximation of functions of two variables in MILP models*, Operations Research Letters – Elsevier, 2009.

THE ENERGY SELF-SUFFICIENCY OF THE RESEARCH FACILITY AT THE INSTITUTE OF ENERGY TECHNOLOGY

NEJC FRIŠKOVEC, MANJA OBREZA, KLEMEN SREDENŠEK, SEBASTIJAN SEME

University of Maribor, Faculty of Energy Technology, Krško, Slovenia

nejc.friskovec@student.um.si, manja.obreza@student.um.si, klemen.sredensek@um.si, sebastijan.seme@um.si

Keywords: photovoltaic system, battery storage system, energy self-sufficiency, research facility

The paper provides an analysis of the energy self-sufficiency of the research facility at the Institute of Energy Technology, Faculty of Energy Technology, University of Maribor. The research facility is powered by a hybrid photovoltaic/thermal (PV/T) system on its rooftop in combination with a battery storage system. The main goal of this paper is to evaluate the energy self-sufficiency of the facility and find more consistent approaches and solutions to improving energy self-sufficiency using measurement data.

Micro-grids have developed and expanded rapidly in the past decade, leading to positive impacts on the electricity grid and environment [1-3]. Building self-sufficiency has long been seen as comprehensive energy production and consumption, although such an approach can cause several problems. The main problems are observing energy flow in real-time and finding that self-sufficiency is no longer provided. Therefore, different energy storage systems have been introduced to achieve the energy self-sufficiency of the research facility. In this case, energy self-sufficiency will be ensured by using a PV/T system combined with a cobalt-free lithium phosphate (LFP) battery storage system. The PV/T system positioned on the roof of the facility includes 10 PV/T modules with a total installed power of 3,300W_p. The battery storage system and several temperature sensors

are housed in the building. Figure 1 illustrates a power flow analysis of the research facility for June and December.

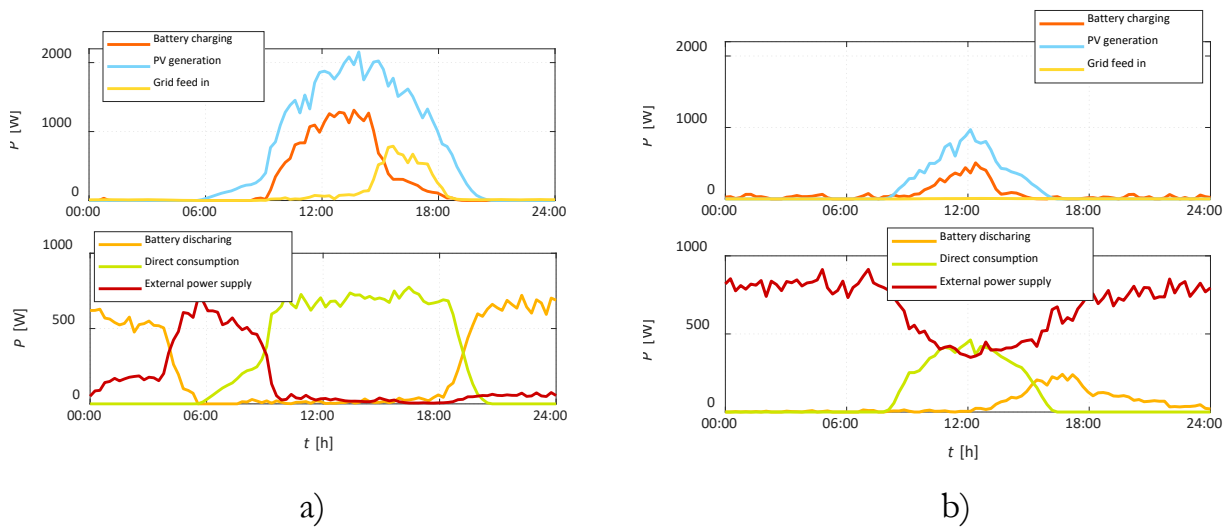

Figure 1: Power flow analysis of the research facility for a) June and b) December

Source: own.

As in any household building, the consumption and production of electricity in the research facility primarily depend on weather conditions (solar radiation, ambient temperature), as shown in Figure 1. Therefore, self-sufficiency and self-consumption rates are 79% and 84% for June and 19% and 99% for December. It is evident that the highest PV production and self-sufficiency ratio is in June, as shown in Figure 1a (low part of the external power supply), whereas the highest self-consumption ratio (99%) is in December, when almost no electricity flows back into the electricity grid due to low PV production.

The main purpose of this paper is to provide a thorough analysis of self-sufficiency and self-consumption rates for an existing research facility equipped with a PV/T system and a battery storage system. Additional analysis and findings are presented in the full paper.

References

- [1] Chr. Lamnatou, D.Chemisana, C. Cristofari: *Smart grid and smart technologies in relation to photovoltaics storage systems, buildings and the environment*, Renewable Energy, Vol.185, p.p.1376-1391, 2020.
- [2] S. Seme, K. Sredenšek and Z. Praunseis: *Smart grids and net metering for photovoltaic systems*, International Conference on Modern Electrical and Energy Systems (MEES), pp.188-191, 2017.
- [3] K. Sredenšek, I. Brinovar, G. Srpčič, B. Štumberger, M. Hadžiselimović, S. Seme: *Energy supply of institute of energy technology*, Proceedings of full papers, 14th International Conference on Applied Electromagnetics PES 2019, 2019.

FUTURE TRENDS IN PHOTOVOLTAICS: HYBRID PHOTOVOLTAIC/THERMAL SYSTEM

KLEMEN SREDENŠEK, IZTOK BRINOVAR, GREGOR SRPČIČ,
MIRALEM HADŽISELIMOVIĆ, BOJAN ŠTUMBERGER, AMOR CHOWDHURY,
SEBASTIJAN SEME

University of Maribor, Faculty of Energy Technology, Krško, Slovenia
klemen.sredensek@um.si, iztok.brinovar1@um.si, grega.srpcic@um.si, miralem.h@um.si, bojan.stumberger@um.si,
amor.chowdhury@um.si, sebastijan.seme@um.si

Keywords: hybrid photovoltaic/thermal system, photovoltaic system, heat pump, waste heat

The paper provides a comprehensive view of future trends in photovoltaics, especially innovative hybrid photovoltaic/thermal systems (PV/T). The findings and results are based on a pilot hybrid PV/T system installed at the Institute of Energy Technology, Faculty of Energy Technology, University of Maribor. The main goal of this paper is to describe the advantages of a hybrid PV/T system compared to a commercial photovoltaic (PV) system as well as its potential for mass integration for self-sufficiency in households or multi-purpose facilities and industry. There are a lot of alternative technologies for obtaining energy from renewable energy sources, which, unfortunately, are not applicable or have not yet appeared on the market. Photovoltaic systems are the most promising technology for electricity production and are breaking all records in terms of the installed capacity of production units. However, the disadvantage of PV systems is the low efficiency of energy conversion and the reduction in lifespan due to temperature exposure. Engineers have therefore developed a new, innovative hybrid PV/T system with a higher energy yield due to the cooling of the system. Due to the high prices of electricity and other energy sources, self-sufficiency solutions based on PV systems and heat pumps represent the most common solutions in Slovenia [1]. The main advantages of PV/T

systems over commercial PV systems are the higher energy yield and the production of waste heat generated due to cooling. Current self-sufficiency systems use the electrical energy produced to cover the consumption of the heat pump. Increased production of electrical energy can significantly reduce the installed capacity of the PV/T system, while waste heat can reduce the consumption of the heat pump [2]. Both advantages are mainly reflected in economic terms, despite the increased investment costs of PV/T components, which are about 20% higher than for commercial PV systems. The pilot PV/T system described in this paper includes 10 PV/T modules with a total installed power of 3,300W_p, a thermal energy storage tank (500 litres) and a cobalt-free lithium phosphate (LFP) battery storage system (7.7kWh). Figure 1 illustrates the monthly values of the electrical and thermal energy produced by the pilot PV/T system.

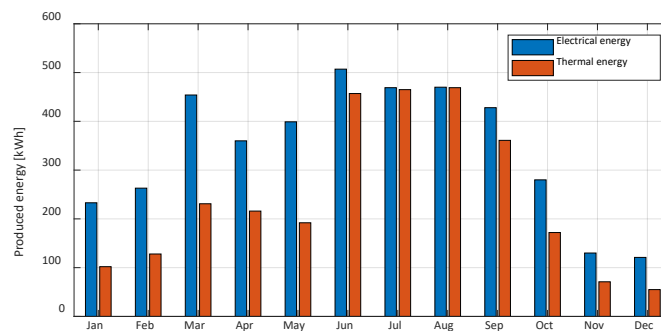

Figure 1: Monthly values of electrical and thermal energy production of a PV/T system (2021)

Source: own.

As illustrated in Figure 1, the PV/T system produces almost the same share of electrical and thermal energy in the summer months, while in all other months, thermal energy production is approximately 50% lower than the production of electrical energy. Based on the findings, it is evident that the PV/T system contributes to the commercial PV system in terms of higher electricity production (4,857 kWh/year) and additional heat production (3,231 kWh/year), which can be used to lower the consumption of the heat pump or other low-temperature applications. The primary purpose of this paper is to describe future trends in photovoltaics, especially hybrid PV/T systems, which represent an alternative to commercial PV systems. Additional analysis and findings will be presented in the full paper.

References

- [1] K. Sredenšek, S. Seme, B. Štumberger, M. Hadžiselimović, A. Chowdhury, Z. Praunseis: *Experimental validation of a dynamic photovoltaic/thermal collector model in combination with a thermal energy storage tank*, Energies, Vol.14, p.p.1-21, 2021.
- [2] S. Sami: *Modelling and Simulation of a Novel Combined Solar Photovoltaic-Thermal Panel and Heat Pump Hybrid System*, Clean Technologies, pp.89-113, 2018.

STATIC MODELLING OF PROTECTION RELAYS IN MODERN DISTRIBUTION NETWORKS

MAREK HÖGER, PETER BRACINÍK, MICHAL REGULA

University of Žilina, Faculty of Electrical Engineering and Information Technology, Žilina, Slovakia.
marek.hoger@uniza.sk, peter.bracinik@feit.uniza.sk, michal.regula@feit.uniza.sk

Keywords: protection relay, fault, operation, modelling

During the last decade, distribution network operators have faced several challenges. On the one hand, the operation of the distribution grid has been significantly affected by the increasing penetration of renewable energy sources, resulting in problems with voltage stability, overloading of network elements and operation planning. Moreover, the increasing penetration of electric vehicles is expected to significantly affect consumer behaviour. On the other hand, meanwhile, there is continuous pressure from the regulatory authorities to increase the quality of supply, reduce the number of outages and strengthen the resilience of the network. Modern distribution automation devices, including field automation and modern digital protection relays, are a key element in the process of improving the security of supply. However, the key element in enhancing network security is the cooperation of all system elements and not just the performance of individual devices. The process of designing an effective protection system is a very difficult task, especially in urban networks that often have a meshed topology.

To properly design the structure and settings of the protection system, it is necessary to model the reactions of the individual protection devices, including the related measurement and switching hardware. The structure of a typical protection system is shown in Figure 1.

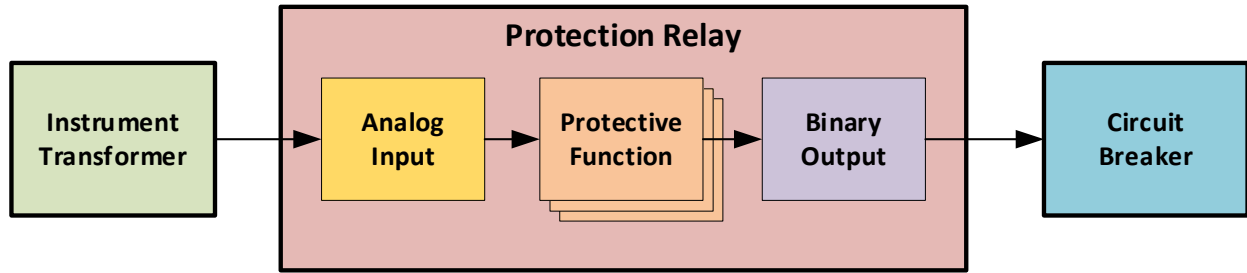

Figure 1: Basic structure of a typical protection system

Source: own.

The modelling of a protection system consists of a series of consequent steps. The first step is to determine the accuracy of the current transformer (CT) providing information about the fault current [1]. While the accuracy class of the CT defines the expected behaviour of the transformer during the fault, the real accuracy of the output signal provided to the protection relay is affected by several factors, including the overall loading of the transformer and the amplitude of the fault current. The secondary current at the output of the CT including the error term can be expressed as follows [2]:

$$\begin{aligned}
 I_{FS} &= I_{Fp} \cdot (r_{CT} \pm \epsilon_{a\%}); \epsilon_{a\%} \\
 &= \epsilon_{1\%} + \left(\frac{I_{Fp}}{I_{CTp}} - 1 \right) \cdot \frac{\epsilon_{ALF\%} - \epsilon_{1\%}}{ALF_a - 1},
 \end{aligned} \tag{1.1}$$

Where I_{Fp} , I_{Fs} is the fault current at the primary and the secondary side of the CT respectively, r_{CT} is the nominal ratio of the CT, $\epsilon_{a\%}$ is the actual ratio error, ALF_a is the actual accuracy limit factor of the CT and $\epsilon_{ALF\%}$, $\epsilon_{1\%}$ is the ratio error of the CT at ALF and at nominal current.

In the next step, the individual protective functions of the relay will calculate the value of the fault current with a defined accuracy, affecting the error term of the current I_{Fs} . Based on the value of the fault current and the start value of the protective function, a decision during the simulation needs to be made as to whether the protective function will start ($I_{FS} - \epsilon > I_{st}$), block ($I_{FS} + \epsilon \leq I_{st}$), or if the start is uncertain. In cases where the protection function will start or the start is uncertain, the switching time is determined based on the characteristic of the protective function. In cases of an inverse time characteristic, the resulting tripping time and its error term are determined using the corresponding formula (IEC, IEEE) [3] according to the error propagation theory [4] in terms of the accuracy of the internal timer. In cases where there is a complex system of several protective functions, the final tripping/blocking signal is derived from the

protection function with the shortest tripping time. In the last step, the speed of binary outputs, opening coil activation time as well as the switching time of the circuit breaker needs to be taken into account.

Acknowledgement

This work has been supported by KEGA grant No.053ŽU-4/2021 named ‘Innovation of MSc. study programme Electric Power Engineering at FEIT UNIZA in the context of new requirements for power network automation and management.

References

- [1] A. Hargrave, M.J. Thompson, B. Heilman: Beyond the knee point: A practical guide to CT saturation, 71st Annual Conference for Protective Relay Engineers (CPRE), 2018
- [2] P. Fonti: Current transformers, Cahier technique No.194, Schneider Electric, 2000
- [3] J.L. Blackburn, T.J. Domin: Protective Relaying, CRC Press, 2007
- [4] J.R. Taylor: An Introduction to Error Analysis, University Science Books, 1997

FRAMEWORK FOR AUTOMATED GENERATION OF PHOTOVOLTAIC POTENTIAL REPORTS FOR INDIVIDUAL BUILDINGS

MARKO BIZJAK, NIKO UREMOVIĆ, PRIMOŽ SUKIČ, JURČEK VOH,
GORAZD ŠTUMBERGER, BORUT ŽALIK, NIKO LUKAČ

University of Maribor, Faculty of Electrical Engineering and Computer Science, Maribor, Slovenia

m.bizjak@um.si, niko.uremovic@um.si, primoz.sukic@um.si, jurcek.voh@um.si, gorazd.stumberger@um.si, borut.zalik@um.si,
niko.lukac@um.si

Keywords: photovoltaic potential, building, framework

Investments in photovoltaic systems are one of the pillars of the 2030 EU policy framework for energy and climate [1]. Investors require a systematic overview of the assessment of photovoltaic potential in order to support decisions relating to the investment in photovoltaic systems. An automatic framework for generating reports to assess the photovoltaic potential of any building in Slovenia was developed and is described in this extended abstract. The framework is performed in three stages, as shown in Figure 1.

During the data preprocessing stage, the framework automatically obtains LiDAR (Light Detection and Ranging) data from a public database and processes it for each location to take into account shade from the surroundings. The measurements of direct and diffuse radiation from the closest meteorological stations of each location are used to calculate solar radiation [2], which is performed during the second stage, where the simulation is performed. During the final stage, reports are generated.

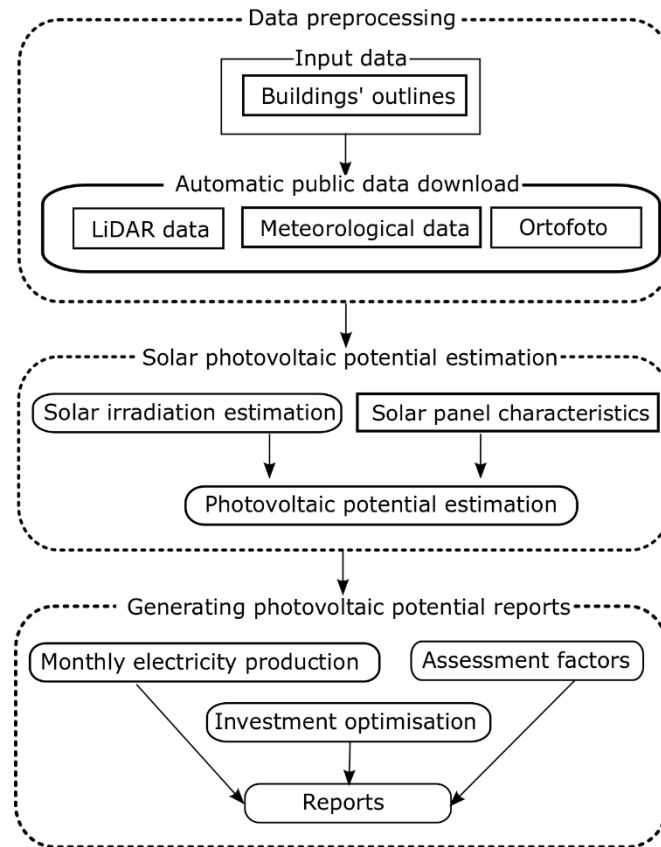

Figure 1: Workflow of the framework.

Source: own.

In order to assess photovoltaic potential, the characteristics of three solar panels provided by an investor are considered. In addition to the dimensions of the solar panels, the non-linear characteristics that affect efficiency in relation to the received irradiance are considered in hourly time steps. The reports include general information of each property, the mapped influences of each considered assessment factor (aspect, inclination, shade, ...), and the solar and photovoltaic potential [3]. The electricity production is provided on a monthly level for each type of panel, as shown in Figure 1. The photovoltaic potential is first given for a case when the whole roof would be used for the installation of solar panels as a measure for total capacity. The maximum capacity was given as the rated power and estimated using the number of possible installations of solar panels in relation to the dimensions of each panel.

An additional case for improved return of investment is provided by excluding the highly shaded roof areas, as shown in Figure 2. The mapped solar irradiation that is shown as an example in Figure 2 provides a detailed insight into the suitability for solar panel installation of each square metre of the roof of the selected building.



Figure 2: The received solar radiation of the selected building for a case excluding the highly shaded roof.

Source: own.

References

- [1] F. DeLlano-Paz, P. Martínez Fernandez, and I. Soares, 'Addressing 2030 EU policy framework for energy and climate: Cost, risk and energy security issues', *Energy*, vol.115, pp.1347-1360, 2016.
- [2] N. Lukač, D. Žlaus, S. Seme, B. Žalik, and G. Štumberger, 'Rating of roofs surfaces regarding their solar potential and suitability for PV systems, based on LiDAR data', *Appl. Energy*, vol.102, pp. 803-812, 2013.
- [3] N. Lukač, S. Seme, D. Žlaus, G. Štumberger, and B. Žalik, 'Buildings roofs photovoltaic potential assessment based on LiDAR (Light Detection And Ranging) data', *Energy*, vol. 66, pp.598-609, 2014.

VALIDATION OF THE T6 TEMPERATURE CLASS FOR AN EXPLOSION-PROOF INDUCTION MOTOR

GREGOR SRPČIČ, MIRALEM HADŽISELIMOVIĆ, IZTOK BRINOVAR,
KLEMEN SREDENŠEK, SEBASTIJAN SEME, BOJAN ŠTUMBERGER

University of Maribor, Faculty of Energy Technology, Krško, Sloveni
grega.srpcic@um.si, miralem.h@um.si, iztok.brinovar1@um.si, klemen.sredensek@um.si, sebastijan.seme@um.si,
bojan.stumberger@um.si

Keywords: induction motor, temperature class, over-load test, temperature rise test

Explosion-proof induction motors are designed to operate in hazardous areas which contain gases, vapours or dust that can form a flammable mixture if mixed with air. The enclosure of an explosion-proof induction motor is designed to withstand an explosion of a specified gas that may occur within the motor enclosure. However, the motor is also constructed to prevent an explosion of a specified gas or vapour. The maximum surface temperature of the equipment must be lower than the ignition temperature of the potential gas or dust mixture. IEC temperature classes are defined in Table 1. [1-4]

Table 1: Maximum surface temperatures for IEC temperature classes

IEC Temperature class (T-code)	T1	T2	T3	T4	T5	T6
Maximum surface temperature	450°C	300°C	200°C	135°C	100°C	80°C

In order to validate the T6 surface temperature class for the considered explosion-proof induction, motor load and overload tests were carried out. [3], [4] The results of both measurements can be seen in Figure 1.

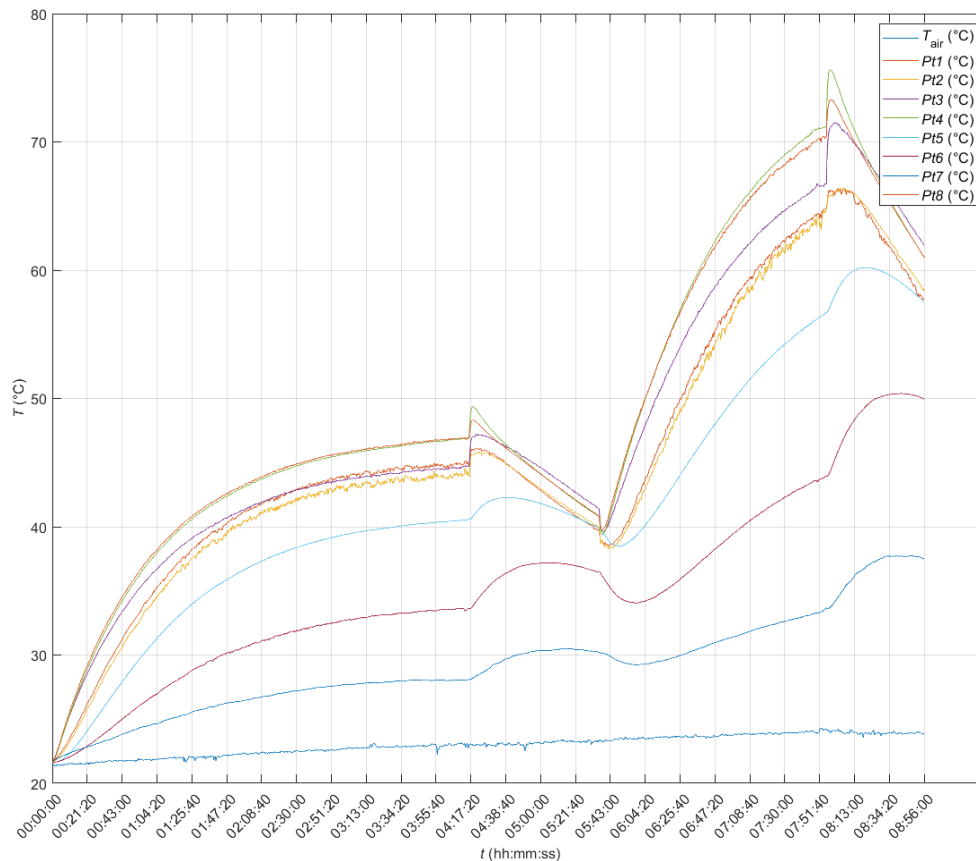

Figure 1: Logged measurements of air and motor surface temperatures of overload test

Source: own.

According to the test results of surface temperatures seen in Figure 1, the considered explosion-proof induction motor can be classified into the T6 IEC temperature class. In addition, the correct working of the PTC thermistor was confirmed during the overload test.

References

- [1] Petroleum and Chemical Industry Committee: *IEEE Guide for the Application of Electric Machines in Zone 2 and Class I, Division 2 Hazardous (Classified) Locations*, IEEE Std 1349™-2021, 2021.
- [2] ABB: *Motors and drives in potentially explosive atmospheres*, 2018, available at: https://library.e.abb.com/public/8def9dd8a82b4041972aa518c9e21f88/Potentially_explosive_atmospheres_guide_3AUA0000037223_RevD_EN_lowres.pdf.
- [3] I. Brinovar, G. Srpčić, S. Seme, B. Štumberger, M. Hadžiselimović: *The classification of explosion-proof protected induction motor into adequate temperature and efficiency class*, AIP conference proceedings: Thermophysics 2017, issue 1, pp.05001-1-05001-5, 2017.
- [4] G. Srpčić, I. Brinovar, K. Sredenšek, S. Seme, M. Hadžiselimović, B. Štumberger: *Heating of explosion-proof protected induction motors at different frequencies*, Proceedings of full papers. 14th International Conference on Applied Electromagnetics PES 2019, 26-28 August 2019 Niš, Serbia.

THE POSSIBILITY OF INCREASING THE AMOUNT OF RENEWABLE ENERGY SOURCES IN THE DISTRIBUTION NETWORK AND LOSS REDUCTION USING ACTIVE ELEMENTS

EVA TRATNIK, MILOŠ BEKOVIĆ

University of Maribor, Faculty of Electrical Engineering and Computer Science, Maribor, Slovenia
eva.tratnik@um.si, milos.bekovic@um.si

Keywords: distribution network, load flow analysis, active elements, optimisation method

The European Union's goal is to be climate neutral by 2050. To achieve the goal, it is necessary to increase the amount of renewable energy sources in the distribution network.

The aim of this paper is to develop an optimal location for a PV system in a distribution network. As the number of PV systems keeps increasing, their effects on the distribution network are becoming more serious. To integrate a high number of PV systems in the distribution network, a load flow analysis should be carried out. To keep voltage profiles within limits, network reconfiguration, active elements and reactive power compensation are used. The proposed procedure for integrating the accommodation of a PV system and reducing distribution network losses is performed through a case of a real medium-voltage model, as shown in Figure 1. The network considered within the following case study is part of a network operated by Elektro Celje. The considered network operates exclusively radially. To demonstrate the synergistic effects achieved by simultaneous consideration of allocation of the PV system, a series of simulation scenarios are performed. In this paper, the authors analyse the test distribution network and show the current situation and the problems arising from excessive integration of renewable energy sources. Thereafter,

using the differential evolution algorithm, they determine the optimal size and position of the dispersed energy sources to meet the criterion of appropriate network conditions.

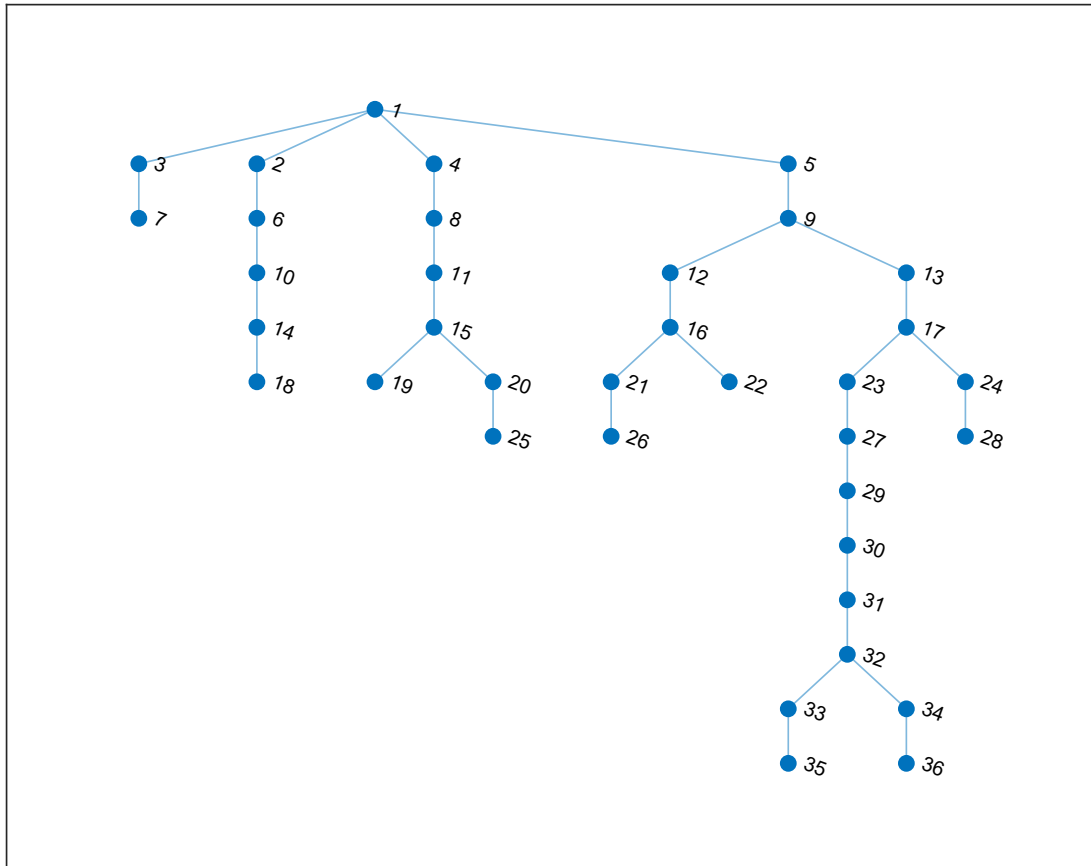

Figure 1: Graphic presentation of a distribution network

Source: own.

The evolution of a distribution network from a passive to an active part of a system offers vast space for research and different approaches to network operating. The proposed procedure will provide a reduction in annual losses.

USAGE OF ACTIVE ELEMENTS FOR PROVIDING APPROPRIATE VOLTAGE PROFILES AND PREVENT OVERLOAD IN RADIAL DISTRIBUTION NETWORKS

MARKO VODENIK, MATEJ PINTARIČ, GORAZD ŠTUMBERGER

University of Maribor, Faculty of Electrical Engineering and Computer Science, Maribor, Slovenia

marko.vodenik1@um.si, matej.pintaric@um.si, gorazd.stumberger@um.si

Keywords: voltage profile, distribution network, load flow calculations, active network elements, energy flexibility

This article deals with the issue of providing appropriate voltage profiles and preventing congestion of network elements in distribution networks. Active network elements and network users' energy flexibility services are used to provide an appropriate voltage profile and prevent congestion in distribution networks. Active network elements include an OLTC (On-load tap changer), reactive power compensation devices, electricity storage devices, distributed energy sources and network users' energy flexibility services, where the active consumer adjusts the consumption, production and storage of electricity. Based on the BFS (Backward Forward Sweep) load flow computation method, case studies are performed for the discussed distribution network, where the measurement results were available. The distribution network is a LV (low voltage) radial distribution network with three branches and 39 nodes, as shown in Figure 1.

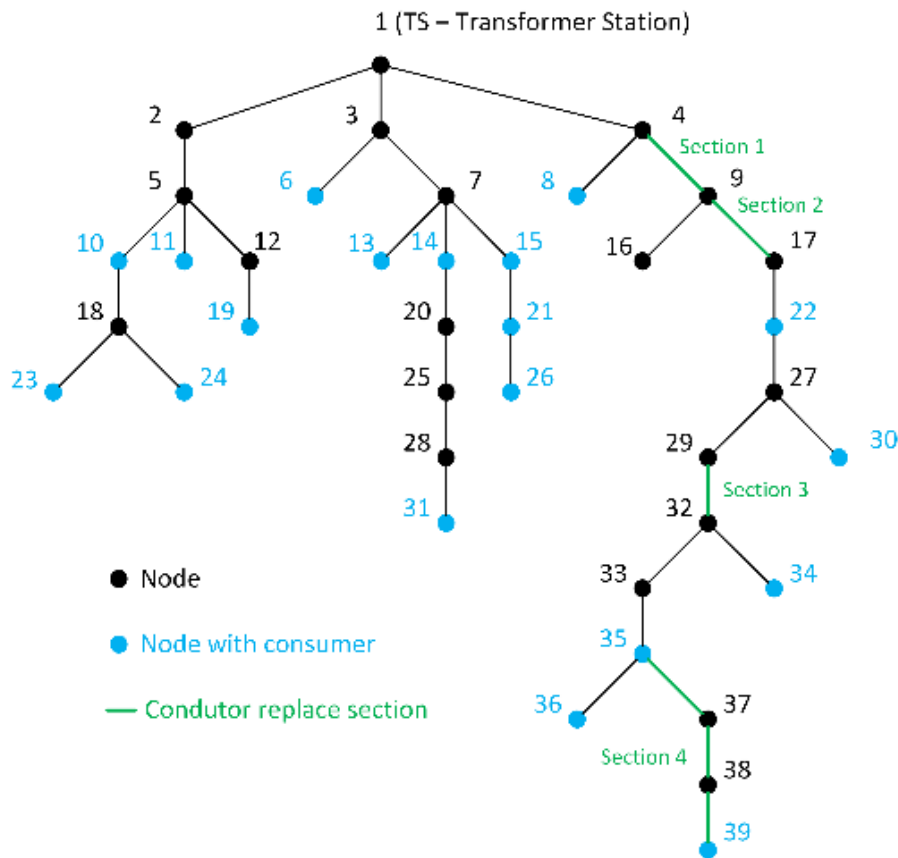

Figure 1: Radial structure of the network

Source: own.

The case studies for preventing overload of the distribution transformer are performed with a battery storage system and network users' energy flexibility services. The case studies for providing appropriate voltage profiles are performed with all listed active elements and a combination of different active elements. In addition, the providing of appropriate voltage profiles is performed by replacing the existing conductors with those of a larger cross-section. This article describes technically acceptable solutions that can provide an appropriate voltage profile and prevent the overloading of network elements in the most demanding operating conditions.

References

- [1] Ettore. Bompard, Enrico. Carpaneto, Gianfranco. Chicco, Roberto. Napol: *Convergence of the backward/forward sweep method for the load-flow analysis of radial distribution systems*, International Journal of Electrical Power & Energy Systems, Volume 22, Issue 7, p.p.521-531, 2000
- [2] Krishneel. Prakash, Avneel. Lallu, F. R. Islam, Kabir Al. Mamun: *Review of Power System Distribution Network Architecture*", 2016 3rd Asia-Pacific World Congress on Computer Science and Engineering, Suva, p.p.124-128, 2016. DOI:10.1109/APWC-on-CSE.2016.030
- [3] Marko. Vodenik: *Usage of active elements for providing proper voltage profiles in distribution networks*, DKUM, 2021

A PMSG WIND TURBINE AND ENERGY STORAGE SYSTEMS FEATURING LOW-VOLTAGE RIDE-THROUGH COORDINATED CONTROL

SATISH KUMAR PEDDAPELLI, SAJAN CH

Osmania University, College of Engineering, Telangana, India
satish8020@yahoo.co.in, sajan4315@gmail.com

Keywords: LVRT, PMSG, WECS, energy storage system, fuzzy-logic controller, rotor inertia, pitch angle control

Climate change due to carbon emissions is a truly global issue that needs strict action to reduce its threatening impacts. Shifting to renewable energy and transitioning to low-carbon energy is implicit for a more sustainable and cleaner environment [1]. Wind energy has made considerable advances in renewable energy generation due to the environmental impact of traditional energy sources. In many nations, a significant penetration of grid-connected wind energy has arisen as a recent trend. However, difficulties with power generation loss owing to grid faults have also occurred. The importance of low-voltage ride-through (LVRT) in wind energy conversion systems has been highlighted by recent technological advancements (wind energy conversion systems (WECS)). LVRT, on the other hand, is a strategy for maintaining the connectivity of WECS in the event of a grid failure. Designing controllers for rotor-side converters, grid-side converters, DC-link capacitors, and flexible alternating current transmission system (FACTS) devices are the most challenging element of LVRT. Numerous controller techniques and FACTS devices are available to improve LVRT. During LVRT augmentation, controller techniques are more important in enhancing the MPPT and optimising the parameters. FACTS devices are divided into three types: series, shunt, and series-shunt connecting devices, all of which are critical in providing reactive power assistance to the grid under unbalanced conditions.

In the past decade, a lot of work has been done on induction-generator-based WECS. Doubly-fed induction generator-based WECS makes use of partially rated converters, thus reducing the cost of power electronics in the system; however, the disadvantages are fewer poles, lower efficiency and frequent maintenance [2]. Additionally, the wind energy market trend is shifting from doubly-fed induction generated (DFIG) to permanent magnet synchronous generator (PMSG)-based WTs. The intriguing advantages of PMSGs are variable speed operation, extraction of wind power during low speeds, less requirements for a gearbox, fewer rotor losses, less wear and tear of the rotor parts and high reliability [3]. The disadvantages of PMSGs include the huge diameter of the machine, the high cost of primary energy consumption (PEC) and permanent magnets, and PEC losses. PMSGs with a power electronic converter is coupled to the grid in order to achieve complete control over the active and reactive power. However, PMSG-based WECS with a full rating converter is affected by the fault in the grid, thus leading to an increase in voltage at the DC link capacitor [4]. Furthermore, the imbalance in the mechanical and electrical units of WECS damage the generator and power electronic converter by generating the over-currents and over-voltages in the system [5]. Particularly, finding a solution for over-currents and over-voltages indirectly enhances the LVRT capability. The LVRT capability is achieved based on the grid parameters, such as voltage during the fault, voltage recovery and response time during overshoots, as well as turbine parameters such as rotor speed, rotor current and DC bus voltage [6]. A block diagram of the PMSG along with the controllers is shown in Figure 1.

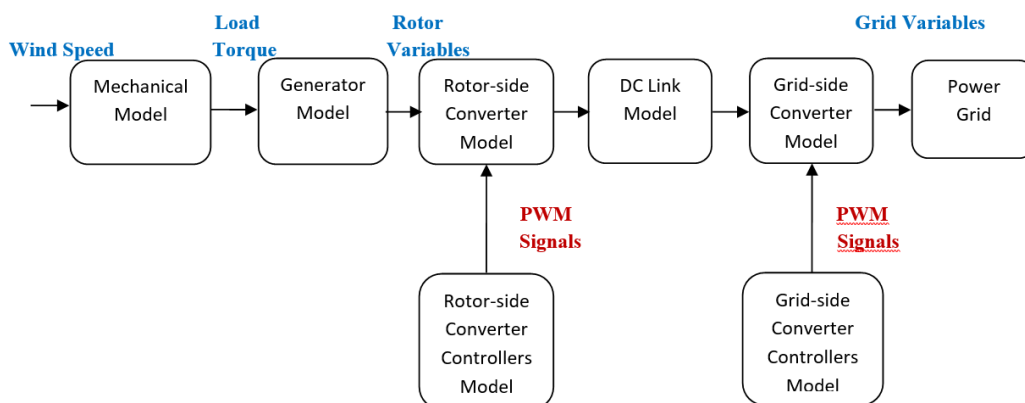

Figure 1: Block diagram of the permanent magnet synchronous generator with controllers to support low voltage ride through capabilities

Source: own.

The mechanical power of WT's is given as :

$$P_m = \frac{1}{2} \rho A C_p(\lambda, \beta) v_{wind}^3 \tag{1}$$

Where C_p - power coefficient, λ - tip speed ratio, β - pitch angle, A - blade swept area and v_{wind} - wind speed. In this paper, a fuzzy-based LVRT approach is proposed that takes into account the rotor inertial response capabilities and pitch angle control response of a WT, as well as the state of charge (SoC) of an energy storage system (ESS). The rotor speed is near to the rated speed in high wind speed situations, and there is a tiny amount of reserve energy in the form of rotor inertia. The ESS SoC can change over time and may have a limited amount of reserve energy for charging during a grid outage. The pitch angle control response in fuzzy-based LVRT control is provided to address this issue and gain greater reserve energy for LVRT. By analysing the combined response of pitch angle and rotor inertia controls in the wind turbine, more stable LVRT control is possible [7]. The fixed torque control in the rotor and fixed ramp rate control in the pitch system is used. A fuzzy-logic controller is used to determine the fixed torque control value, which takes into account the reserve energies of a WT and an ESS. Commonly used energy storage systems to improve the capability of LVRT include battery energy storage systems (BESS), flow battery energy storage system (FBESS), electrical double layer capacitors (EDLC), flywheel energy storage systems (FESS) and superconducting magnetic energy storage (SMES) [8]. Simulations utilising the MATLAB/Simulink SimPowerSystems toolbox will be used to validate the effectiveness of the suggested strategy.

Table 1: Comparison of energy storage systems used to improve the capability of LVRT capability of PMSG-based WECS

Energy Storage System	Discharge Power Range	Daily Discharge (%)	Discharge Efficiency	Stored Energy Range	Life Cycle (Years)
FESS	0.1-2MW	100	0.93	0.1-60MJ	> 10
SMES	0.1-2MW	10-15	0.95	0.1-60MJ	> 20
BESS	0.05-50MW	0-5	0.98	0.005-50MWh	≤ 20
FBESS	0.1-5MW	0-3	0.98	0.005-120MWh	≤ 20
EDLC	0-0.3MW	5-20	0.80	0.01-120MWh	≤ 10

References

[1] Rania A. Ibrahim, Nahla E. Zakzouk: A PMSG Wind Energy System Featuring Low-Voltage Ride-through via Mode-Shift Control, Applied Sciences, pp.1-29, 2022.

- [2] Rupam Basak, Gurumoorthy Bhuvaneshwari, Rahul R. Pillai: Low-Voltage Ride-Through of a Synchronous Generator-Based Variable Speed Grid-Interfaced Wind Energy Conversion System, *IEEE Transactions on Industry Applications*, pp.752-762, 2020
- [3] Ravikiran Hiremath, Tukaram Moger: Comprehensive review on low voltage ride through capability of wind turbine generators, *Int Trans Electr Energ Syst*, John Wiley & Sons Ltd, pp.1-39, 2020
- [4] Nasiri M, Milimonfared J, Fathi S: A review of low-voltage ride-through enhancement methods for permanent magnet synchronous generator based wind turbines. *Renew Sust Energ Rev.*, pp.399-415, 2015
- [5] Ebrahimzadeh E, Blaabjerg F, Wang X, Bak CL: Harmonic stability and resonance analysis in large PMSG-based wind power plants, *IEEE Trans Sustainable Energy*, pp.12-23, 2018
- [6] Jenisha CM, Ammasaigounden N, Kumaresan N, BhagyaSri K: Power electronic interface with de-coupled control for wind-driven PMSG feeding utility grid and DC load, *IET Power Electron*, pp.329-338, 2017
- [7] Chunghun Kim, Wonhee Kim: Enhanced Low-Voltage Ride-Through Coordinated Control for PMSG Wind Turbines and Energy Storage Systems Considering Pitch and Inertia Response, *IEEE Access*, pp.212557-212567, 2020
- [8] Om Prakash Mahela, Neeraj Gupta, Mahdi Khosravy, Nilesh Patel: Comprehensive Overview of Low Voltage Ride Through Methods of Grid Integrated Wind Generator, *IEEE Access*, pp.99299- 99326, 2019

THE CHALLENGES OF CHARGING FLEETS OF ELECTRIC TRUCKS IN THE POWER SYSTEM

NORINA SZANDER,¹ PÉTER BAJOR²

¹ Faculty of Organisation Studies in Novo mesto, Novo mesto, Slovenia
norina.szander@medifas.net

² Dunaújváros University of Applied Sciences, Department of Mechanical Sciences, Dunaújváros, Hungary
bajorp@uniduna.hu

Keywords: electric truck charging, power system challenges

The electric power need of future truck fleets provides several challenges and opportunities for the electricity supply sector in terms of charging and temporal storage, the possibility of grid balancing and many more aspects. In the first part of this paper, the authors describe the field of vehicle-grid cooperation, as the introduction and penetration of electric battery and hydrogen fuel cell-driven road freight vehicles require a new approach from the side of charging and fuelling infrastructure. As long as autonomous trucks are not widespread enough, it is not only the distance that can be covered with the battery capacity that matters, but also the hours of service and other safety and shipping constraints.

In the case of electric battery charging, a lot depends on the appropriate grid conditions at parking areas and fuel stations. The renewal and development of the electric grid is essential for these special needs, while the competition between the concurrent technologies is still open. The electric grid was initially established for lighting needs, however, today the main consumers are stationary rotating machines (pumps, fans, compressors, etc.), and electric- or hydrogen-driven vehicles will apply for their share in the foreseeable future. Therefore, it is necessary to provide sustainable, secure and reliable electricity supply during the transition to zero-emission road freight systems.

In this paper the authors introduce a conceptual framework for further analysis, covering data management as well as grid and energy management issues and the available charging time distribution based on observing the truck flow at some Hungarian rest areas along the main transport corridors.

Although there are possibilities for extending driving hours or limited rest periods for drivers of self-driven vehicles in the near future, this scenario can highlight the critical factors of infrastructure development that stakeholders and decision makers should consider when investing in a typically long-life infrastructure such as the electric grid.

5TH INTERNATIONAL CONFERENCE ENRE - ENERGY & RESPONSIBILITY BOOK OF EXTENDED ABSTRACTS

SEBASTIJAN SEME, JURIJ AVSEC, KLEMEN SREDENŠEK (EDS.)

University of Maribor, Faculty of Energy Technology, Maribor, Slovenia
sebastijan.seme@um.si, jurij.avsec@um.si, klemen.sredensek@um.si

Abstract The tendency to improve energy devices, the impact of environmental factors and the development of new technologies for the exploitation of sustainable resources contribute to the fact that we have witnessed intensive energy development in the last decade. The two most important Slovenian energy pools, located in Velenje and Krško, are at the turning point of renovation, and are facing major challenges in the design and planning of modern energy devices. The current generation faces a great ethical responsibility to leave their descendants a world with as little human impact on the environment as possible. Therefore, communication between experts and researchers, discussion and exchange of different views for the future is of the utmost importance, which is exactly the purpose of the EnRe Conference.

Keywords:

renewable energy and energy storage systems, classic energy systems, policies and strategies for res, alternative energy systems, energy conversions, energy transfer, electrical machine, thermal machines, mathematical methods in energy, engineering, environmental protection, micro and nano energetics, hydrogen technologies, low carbon technologies and strategies, nuclear energy, smart buildings, smart cities and smart grids





University of Maribor

Faculty of Energy Technology

14. June 2022, Velenje, Slovenia