

**The dynamics of regionalisation and trade:  
Yorkshire clay tobacco pipes  
c1600-1800**

VOLUME II  
**APPENDICES**

Thesis submitted in accordance with the requirements of the  
University of Liverpool for the degree of Doctor in Philosophy by  
Susan Denise White

December 2002

# **IMAGING SERVICES NORTH**

Boston Spa, Wetherby

West Yorkshire, LS23 7BQ

[www.bl.uk](http://www.bl.uk)

# **THESIS CONTAINS**

## **VIDEO**

## **CD**

## **DVD**

## **TAPE CASSETTE**

## Appendices – Contents

1.	List of Yorkshire pipe makers.....	322
2.	Transcriptions of selected wills, inventories and other documents relating to Yorkshire pipe makers.....	365
3.	Collections summaries – Part I.....	379
	• <i>Cleveland</i>	
	Hartlepool Museum Services, Hartlepool.....	379
	Tees Archaeology, Hartlepool.....	380
	Dorman Museum, Middlesbrough.....	387
	• <i>County Durham</i>	
	Bowes Museum, Barnard Castle.....	388
	• <i>East Riding of Yorkshire</i>	
	Sewerby Hall, Bridlington.....	401
	Humber Archaeological Partnership, Hull.....	406
	Wilberforce House Museum, Hull.....	416
	Stothard Collection.....	425
	Rayner Collection.....	426
	• <i>Merseyside</i>	
	National Clay Tobacco Pipe Archive, Liverpool.....	464
	Higgins Collection.....	466
	Stocks Collection.....	466
	White Collection.....	467
	• <i>Lincolnshire</i>	
	Scunthorpe Museum and Art Gallery.....	474
	• <i>North Yorkshire</i>	
	Raines Collection.....	479
	Tierney Collection.....	490
	Yorkshire Dales Museum of Lead Mining, Earby.....	494
	Mercer Art Gallery, Harrogate.....	496
	Dales Countryside Museum, Hawes.....	502
	English Heritage Store, Helmsley.....	504
	Ryedale Folk Museum, Hutton-le-Hole.....	515
	Manor House Museum, Ilkley.....	518
	Beck Isle Museum of Rural Life, Pickering.....	525
	Richmondshire Museum, Richmond.....	530
	Scarborough Borough Council, Lonsborough Lodge, Scarborough.....	535
	Butterfield Collection.....	543
	The Craven Museum, Skipton.....	544
	Thirsk Museum.....	551
	Whitby Museum.....	553
	York Archaeological Trust, York.....	558
	York Castle Museum, York.....	619
	• <i>South Yorkshire</i>	
	Abbey House Museum, Leeds.....	629
	Doncaster Museum and Art Gallery.....	636
	Rotherham Museum.....	653

ARCUS, Sheffield .....	659
Kelham Island Industrial Museum, Sheffield.....	665
Sheffield City Museum.....	672
• <i>West Yorkshire</i>	
Bradford Museum.....	677
Wood Hall Archaeological Trust.....	680
Tolson Memorial Museum, Huddersfield .....	696
Pontefract Museum.....	706
Denham Collection.....	712
Wakefield Museum and Art Gallery .....	714
West Yorkshire Archaeological Services (WYAS) .....	737
Mayfield Collection.....	766
Richardson Collection .....	770
<b>Collection Summaries – Part II</b> .....	<b>771</b>
• <i>English Collections</i>	
Oswald Collection .....	771
Grosvenor Museum, Chester .....	772
Cleveland County Archaeological Unit.....	772
Carlisle Archaeological Unit .....	772
Carlisle Museum and Art Gallery.....	773
Abbot Hall Art Gallery and Museum, Kendal.....	773
Royal Albert Memorial Museum, Exeter .....	773
Austin Collection.....	773
Lampeter Archaeological Unit .....	776
Brackenridge Collection.....	776
Salford Museum and Art Gallery .....	777
Central Excavation Unit, Portsmouth.....	777
Fox Collection .....	777
English Heritage .....	777
Elkins Collection .....	780
North West Archaeological Trust (NWAT).....	780
Dagnall Collection.....	785
Jennings Collection .....	785
York Excavation Group.....	786
Newark Museum .....	786
The Bassetlaw Museum, Retford .....	787
Somerset County Museum, Taunton.....	787
Dept. of Archaeology, Sheffield.....	787
University of Sheffield .....	787
South Yorkshire Archaeological Unit .....	787
Birmingham Museum and Art Gallery.....	788
• <i>Overseas Collections</i>	
Akerhagen Collection, Sweden .....	788
Historic St Mary’s City, Maryland, USA.....	789
Maryland Archaeological Conservation Laboratory, Maryland, USA.....	791
Association for the Preservation of Virginia Antiquities, Jamestown, Virginia, USA.....	791
Virginia Dept. of Historic Resources, Richmond, Virginia, USA.....	792
Colonial Williamsburg, Virginia, USA .....	792

Flowerdew Hundred, Virginia, USA .....	793
Virginia Foundation for Archaeological Research, Virginia, USA .....	793
<b>4. Guidelines for using the clay tobacco pipe record system .....</b>	<b>794</b>
<b>5. Notes for recording stamped marks .....</b>	<b>800</b>
<b>6. Clay tobacco pipes from Sandal Castle .....</b>	<b>810</b>
<b>7. Data summaries by geographical sub-division and period .....</b>	<b>834</b>
<b>8. Results from the bowl height and width ANOVA tests.....</b>	<b>884</b>

## Appendix 1: Yorkshire Pipe-makers 1600-1800

The following list of pipe-makers is arranged alphabetically by initial. The town the maker was working in and the dates of the maker's working life are given in brackets. The working life is taken to be from the time a maker obtained their freedom until their death. Wherever possible the following information is given for each maker: -

<b>Born:</b>	The date and any details of parentage or place of birth where known
<b>Baptised:</b>	The date and place of baptism where known
<b>Apprenticed:</b>	Details of who the individual was apprenticed to and the dates where known
<b>Freedom:</b>	Date when the pipe-maker took his freedom
<b>Married:</b>	Date of any marriage and the name of the spouse together with any further information, for example death of one spouse and subsequent marriages
<b>Children:</b>	Names, dates and any further information relating to children
<b>Died:</b>	Date of death and place of burial where known

Any additional information relating to the pipe-makers life is also given.

### References:

BQR	Bradford Quarter Sessions Rolls (West Riding Archives) searched by D A Higgins in 2001.
BIW	Borthwick Institute, York
HPR	Halifax Parish Registers (West Riding Archives) searched by D A Higgins in 2001.
HTPR	Holy Trinity Parish Records, Hull, which were searched by Martin Stothard on behalf of Gareth Watkins in the early 1980s.
IGI	International Genealogical Index compiled by the Mormons.
RArch	Rotherham Archives and Local Studies Library – Corporation Deeds (213/C Ref. 79/1 Westgate XIV). Searched by D A Higgins in 2002.
SMPR	St Mary's Parish Records, Hull, which were searched by Gareth Watkins in the early 1980s.
SMRPR	St Mary's, Rawmarsh Parish Registers (Archives and Local Studies Library, Rotherham) searched by author and D A Higgins in 2002.
Sun Assurance	Details of Yorkshire pipe-makers who took out fire insurance policies with Sun Assurance between 1718 and 1841, searched by Philip Woollard in 2001.

All other references are given in the bibliography.

**Asquith and Cottam (Hull) (1790-1803)**  
Working in Blanket Row (Oswald 1975, 202; Watkins 1979, 105)

**AA Ambrose Ambler (Leeds) (c1669)**  
Known from a trade token of 1669 showing two pipes and a roll of tobacco but may refer to a dealer in pipes or tobacco rather than a pipe-maker (Oswald 1975, 199; Berry 1982, 371)

**EA Elizabeth Atkinson (Hull) (1670-1681)**  
**Married:** Hugh Atkinson (pipe-maker) (Watkins 1979, 105)  
**Died:** Buried July 1681 (HTPR)  
Had at least four apprentices - John Chapman Freed 1670; George Fowler Freed 1670; John Page, Freed 1673 and Henry Norman, Freed 1674 (Sheppard 1912, 10).

**HA Hugh Atkinson (Hull) (1644-1663/1670)**  
**Freedom:** 21.11.1644 on payment of a fine of 40s (Sheppard 1912, 7)  
**Married:** Elizabeth (Buried July 1681) (HTPR)  
**Died:** Sometime between 1663 and 1670 (Watkins 1979, 105)  
Had at least three apprentices who were freed in 1653, 1660/1 and 1663 (*ibid*).

**HA Henry Ardon (Rotherham) (1681)**  
**Children:** Henry (apprenticed to Elias Trickett, Cutler in Sheffield) (Crossley *in litt* 6.1.1992)

**IA John Aray (York) (1768-1804)**  
**Born:** Son of William baptised 16.11.1735 at Linton on Craven (Andrews *in litt* 30.5 1998)  
**Married:** (1) Elizabeth Holmes 6.6.1762 (died 6.11.1787 of dropsy, aged 56, buried 9.11.1787) (Andrews 1991, 69)  
(2) Elizabeth Newton 2.2.1789 (*ibid*)  
**Children:** Rawson (baptised 29.1.1764; later to become a pipe-maker) (*ibid*)  
Frances (born 1765; died 22.2.1792 aged 26, in childbed giving birth to son Robert on 18.2.1792, natural son of Robert Gowland, pipe-maker of Hull. She was buried 24.2.1792 her son buried in a pauper's grave 10.3.1792) (*ibid*)  
Elizabeth (baptised 22.1.1768; buried 15.9.1768) (*ibid*)  
William (baptised 6.5.1771) (*ibid*)  
John (baptised 16.9.1772; buried 13.4.1775) (*ibid*)  
**Died:** 17.1.1804 aged 68 years; buried 20.1.1804 (*ibid*)  
At the time of his son Rawson's baptism in 1764 John was described as a shoemaker. It was not until the baptism of his daughter Elizabeth, in 1768, that he was described as a pipe-maker (Andrews 1988, 89).

**IA John Atkinson (Hull) (1747-1752)**  
**Freedom:** 1727 (Watkins 1979, 105)

**Died:** Buried 26.1.1752 (HTPR)  
Voted in the 1747 polls in Hull (Sheppard 1912, 16).

**RA Rawson Aray** (York) (1778-1832)  
**Born:** Son of John Aray, shoemaker (baptised 29.1.1764) (Andrews 1987d, 1)  
**Apprenticed:** To Alice Holmes of York for 7 years by indenture 1778 (*ibid*)  
**Married:** Eleanor (*ibid*)  
**Children:** Sarah (2<sup>nd</sup> daughter) (born 30.1.1790; baptised 18.2.1790) (*ibid*)  
Elizabeth (3<sup>rd</sup> daughter) (born 23.10.1791; baptised 9.5.1791 – there is an obvious error here as the baptism date is before the birth date) (*ibid*)  
Mary (4<sup>th</sup> child and 4<sup>th</sup> daughter) born 18.1.1794; baptised 29.1.1794) (*ibid*)  
Child (unclear if this is a boy or a girl) (born 7.3.1797; baptised 17.3.1797) (*ibid*)  
**Died:** Buried 21.11.1832 aged 69 years (*ibid*)  
In 1812 Rawson Aray was elected steward of the Brotherly Society based in York. The Society, made up of York businessmen, met in a public house in Stonegate and acted as an early Building Society (*ibid*).

**WA William Armitage** (Potovens, Wakefield) (1680-1681)  
Appears in the West Riding Quarter Sessions Rolls for 1680-1681, together with Robert Cliffe, when they are fined 'for digging clay for pipes, pots and other earthen ware' (Brears 1967, 42)

**WA William Atkinson** (Doncaster) (1778-1807)  
**Born:** 1726 (Andrews 1993. 1)  
**Married:** Sarah  
**Children:** Jonathan (baptised 15.11.1778 at Laneham, Notts) (*ibid*)  
Jane (baptised 21.9.1780 at Laneham, Notts. Married Benjamin Hodgson, pipe-maker 15.9.1802) (*ibid*)  
**Died:** Buried 3.12.1807 aged 81 (*ibid*)  
It is not clear if William Atkinson practised his trade in Doncaster, as he appears to have moved here from Nottinghamshire quite late in life (*ibid*)

**AB Abraham Boyes** (York) (1645-1681)  
**Born:** Son of Francis Boyes (IGI)  
**Freedom:** 1645 (purchased as a trunk and tobacco pipe-maker, not being qualified as the son of a Freeman) (Oswald 1975, 204; Berry 1982, 371; Andrews 1991, 70)  
**Married:** (1) Elizabeth (died 1660, buried 28<sup>th</sup> March) (*ibid*)  
(2) Frances Buckton on 1.8.1660 (*ibid*)  
**Children:** Sarah (baptised 30.6.1661; later married John Whitekerr, pipe-maker) (*ibid*)  
Abraham (baptised 8.2.1662; buried 9.2.1663) (*ibid*)  
Isaac (baptised 4.12.1664) (*ibid*)  
Ann (baptised 26.11.1665) (*ibid*)



Samuel (baptised 13.10.1667) (*ibid*)  
Mary (baptised 31.10. 1669) (*ibid*)  
Christopher (16.12.1671; later to become a pipe-maker)  
(*ibid*)  
Elias (baptised 13.2.1673) (*ibid*) (Buried 12.7.1678)  
(Andrews 1987b, 3)

**Died:** 18.2.1681 (Andrews 1991, 70)

Abraham took a number of apprentices including John Wright in 1663, freed on payment of £1; Ralph Beeforth, 1.5. 1668 and Matthew Mattison on 23.10.1668 (*ibid*). Token issued in 1670 depicting three pipes in a triangle (Oswald 1975, 204; Lawrence 1979, 80; Berry 1982, 371; Andrews 1987b, 3). Hearth tax returns for 1671 lists 6 hearths for Abraham Boyes, (Andrews 1991, 70).

**AB Arthur Brayne** (Piercebridge) (1665)

Known from a trade token but may be a dealer in pipes or tobacco rather than a pipe-maker (Oswald 1975, 199)

**BB Benjamin Bell** (Hull) (1696-1734)

**Married:** Elizabeth Harrill 3.5.1696 (buried June 1726) (HTPR)

**Children:** Benjamin (buried June 1713) (*ibid*)  
Robert (Bound apprentice to his father in 1709) (Watkins 1979, 107)

**Died:** Buried 19.10.1734 (HTPR)

Paid poor rates in Humber Ward in 1715/16 (*ibid*). Had at least four apprentices between 1713 and 1724. Voted in the 1724 election (Oswald 1975, 202). Working at Finkle Street between 1724 and 1726, but not in 1727 (Watkins 1979, 105).

**CB Christopher Boyes** (York) (1711-1725)

**Born:** 1671 (Andrew 1991, 71)

**Baptised:** 16.12.1671 (*ibid*)

**Freedom:** 1711 at age of 40 (*ibid*)

**Married:** 30.5.1699 to Dorothy Jackson of York (Dorothy died and was buried at Holy Trinity, Goodramgate on 15.7.1721) (*ibid*)

**Children:** Abraham (baptised 5.3.1699/1700) (IGI) (buried 11.3.1699/1700) (Andrews 1987a, 29)  
Christopher (baptised 18.12.1702) (Andrews 1991, 71)  
Rebecca (baptised 16.7.1706) (*ibid*)  
James (baptised 5.6.1707, buried 16.10.1707) (*ibid*)  
Samuel (baptised 18.5.1708) (*ibid*)

**Died:** 1725 aged 53, buried on 13<sup>th</sup> August at St Martin's, Coney Street (*ibid*)

Christopher took on two apprentices, first George Hart, on 2.2.1722 and second Charles Dunning on 29.9.1723. First recorded as a pipe and trunk maker in 1723 (Andrews 1988, 89). His Will, dated 6<sup>th</sup> August, states that he leaves 'unto my son Samuel Boyes and his heirs the back part of the same house with the kitchen, two chambers, with chamber and garrets above and ye little yard and pipe shop with free passage – and to my daughter Rebecca

my leased house in North St., in the tenure of Mr Baynes and others'.  
(Andrews 1987a, 30)

- CB Charles Brickill (Brickhill) (Rawmarsh) (1783-1787)**  
**Married:** Mary Green (daughter of Thomas Green) (SMRPR)  
**Children:** Mary (baptised 28.9.1783; buried 17.2.1786) (*ibid*)  
John (baptised 28.8.1785; buried 19.12.1786) (*ibid*)  
William (baptised 7.12.1788) (*ibid*)  
Hannah (baptised 18.4.1790) (*ibid*)  
Charles (buried 31.1.1878) (*ibid*)
- FB Francis Balden (York) (1643)**  
**Born:** Son of Kirk Balden (Andrews 1991, 70)  
**Apprenticed:** To Gabriel Westaby 1643 (*ibid*)
- FB Frances Boyes (York) (1681-1713)**  
**Born:** Daughter of Simon Buckton of York, baptised 30.10.1632  
(Andrews 1991, 71)  
**Married:** Abraham Boyes 1.8.1660 (*ibid*)  
**Children:** See entry for Abraham Boyes  
Appears to have taken over the business by when her husband died. She appears to have taken five apprentices William Barnet on 21.12. 1688; William Gill on 18.5.1688, George Dean on 20.5.1703 and Edmund Hillary on 27.4.1713 as well as Andrew Hall who took his freedom in 1702 on payment of £1 (*ibid*).
- GB George Benn (Piercebridge) (1665)**  
Known from a trade token but may be a dealer in pipes or tobacco rather than a pipe-maker (Oswald 1975, 199)
- HB Henry Brownbill (York) (1793)**  
**Married:** Hannah (late of Warrington)  
**Children:** Ann (born 4.3.1793; baptised 8.3.1793) (Andrews 1991, 71)  
There are no other references to Henry Brownbill in York. However, it is possible that he moved to Liverpool, as a Henry Brownbill is reported to be working there between 1796-1824 (Lawrence 1979, 81).
- HB Henry Byram (Wrenthorpe, Wakefield) (1670s-1709)**  
Recorded as working at Potovens from the 1670s, appears in records up to 1709 (Brears 1967, 42)
- IB Joseph Birch (York) (1713-1725)**  
**Married:** Ann Coal 11.5.1713 (Andrews 1991, 70)  
**Died:** 21.2.1725 (Lawrence 1979, 81)  
Possibly a journeyman or worker (Andrews 1991, 70)
- IB Jacob Brown (Hull) (1720)**  
**Apprenticed:** To Robert Burrill (1) in 1720 (Watkins 1979, 107)

- IB James Buckley (Barnsley) (c1687)**  
(Oswald 1975, 199)
- IB John Burrell (York) (1720-1726)**  
**Apprenticed:** To Robert Burrill of Hull (Watkins 1979, 107)  
**Freedom:** 22.8.1721 on payment of £25 (Oswald 1975, 204; Andrews 1991, 72)  
**Married:** Margaret Bunnell 7.9.1720 (*ibid*)  
**Children:** Elizabeth (baptised 2.5.1723) (*ibid*)  
Samuel (baptised 13.2.1725) (*ibid*)  
Lawrence (1979, 81) lists 'several children baptised 1722-4'.  
John is recorded in the 1724 Hull Polls (Oswald 1975, 204) and appeared in court on the 17.8.1726 for non payment of a debt (Andrews 1991, 72)
- PB Phillipp Barnard (Aberford, Nr. Leeds) (1684)**  
**Children:** Thomas (Moore 1988, 12)  
**Died:** by 1684 when his son, Thomas, aged 20, left for Jamaica bound to a John West for 4 years (*ibid*)
- RB Robert Batt (Hull) (1724)**  
**Apprenticed:** To William Potter (2) in 1724 (Watkins 1979, 107)
- RB Robert Beacroft (Hull) (1767)**  
**Apprenticed:** To Samuel Goldwell in 1749 (*ibid*)  
**Freedom:** 1767 (*ibid*)
- RB Robert Bell (Hull) (1709-1734)**  
**Born:** Son of Benjamin Bell, pipe-maker (*ibid*)  
**Apprenticed:** To his father Benjamin in 1709 (*ibid*)  
**Freedom:** By patrimony 1710 (*ibid*)  
**Children:** Jane (buried May 1723) (HTPR)  
Benjamin (buried July 1718) (*ibid*)  
**Died:** Buried 1.11.1734 (*ibid*)  
Robert had apprentices between 1717 and 1725. Voted in 1724 (Oswald 1975, 202). Paid poor rates 1724-1725 when he appears to have been working in Finkle Street, next door to his father (Watkins 1979, 107)
- RB Robert Bibby (Hull) (1671)**  
**Apprenticed:** To Edward Fowler in 1671 (*ibid*)  
On Fowler's death the indenture was changed to his widow, Barbara, in 1676 (*ibid*).
- RB Robert Burrill (1) (Hull) (1675-1735)**  
**Apprenticed:** To Henry Norman (1) in 1675 (*ibid*, 108)  
**Freedom:** 2.8.1683 (Sheppard 1912, 8)  
**Married:** Ann Sincler 18.11.1685 (buried 2.6.1706) (HTPR)  
**Children:** Anne (buried 21.4.1695) (*ibid*)  
Robert (buried December 1697) (*ibid*)

Unnamed son (apprenticed to his father, freed 1709)  
(Watkins 1979, 108)

Unnamed son (apprenticed to his father, freed 1723) (*ibid*)

Robert (apprenticed to his father, freed 1727) (*ibid*)

**Died:** Buried 6.1.1735 (HTPR)

Robert had seven apprentices between 1685 and 1727. He voted in 1724 Polls (Oswald 1975, 202; Watkins 1979, 108).

**RB Robert Burril (2) (Hull) (1727-1774)**

**Born:** Son of Robert Burrill (1) (Watkins 1979, 108)

**Freedom:** By patrimony in 1727 (*ibid*)

Voted in elections in 1747 (Oswald 1975, 202), 1754 and 1774 (Watkins 1979, 108).

**SB Samuel Bickerdike (Leeds) (1793-1835)**

Appears in directories (Oswald 1975, 199)

**SB Simon Bickerdike (Leeds) (1798-1808)**

Appear in Leeds Directory 1798-1808 (Lawrence 1973, 190)

**SB Samuel Boyes (York) (1708-1733)**

**Born:** Son of Christopher Boyes, baptised 18.5.1708 (Andrews 1991, 71)

On 20<sup>th</sup> October 1725 Samuel was allowed 6 months to take up his freedom but there is no record that he ever did. Also, in 1725, he inherited the pipeshop and tools that had belonged to his father. In 1733 his apprentice, George Hart, took his freedom as a trunkmaker on payment of £1 (*ibid*).

**SB Samuel Burrell (Hull) (1724)**

Voted in polls on 23<sup>rd</sup> January 1724 (Sheppard 1912, 16)

**TB Thomas Bagshaw (Rotherham) (1750)**

**Baptised:** Son of Richard Bagshaw 26.11.1731 (Andrews *in litt* 1998)

**Married:** Francis Crosland 27.12.1750 (*ibid*)

**Children:** Ann (baptised 24.11.1754) (*ibid*)

**TB Thomas Bateman (Hull) (1688)**

**Apprenticed:** To Thomas Cooke in 1688 (Watkins 1979, 108)

**TB Thomas Bilton (Hull) (1757-1802)**

**Apprenticed:** To Michael Westerdale (1) in 1757 (*ibid*)

**Freedom:** 1765 (*ibid*)

**Children:** Robert (Freed in 1802) (*ibid*)

Thomas appears to have been working in Leeds (*ibid*). Acted as a witness in 1767 (*ibid*). Voted in the 1774 polls in Hull (Sheppard 1912, 16).

**WB William Barnett (York) (1688)**

**Apprenticed:** To Mrs Boyes 21.12.1688 (Andrews 1991, 70)

- WB William Best (Hull) (1686-1703/1740)**  
**Apprenticed:** To Francis Wood in 1686 (Watkins 1979, 108)  
**Freedom:** 14.7.1698 (Sheppard 1912, 8)  
**Died:** A W Best buried 9.4.1703 (HTPR)  
 Another W Best buried 7.4.1740 (*ibid*)  
 A William Best of Blackfriargate is recorded in the Poor Rates 1724-1727 (Watkins 1979, 108).
- WB William Bracebridge (1) (Hull) (1676-1720)**  
**Apprenticed:** To Henry Norman (1) in 1676 (*ibid*)  
**Children:** William (freed by patrimony 1728) (*ibid*)  
**Died:** Buried December 1720 (HTPR)  
 William appears as a witness on apprenticeship records in 1692/93 (Watkins 1979, 108)
- WB William Bracebridge (2) (Hull) (1728)**  
**Freedom:** By patrimony 1728 (*ibid*)
- Cottam, Asquith and Johnson (Hull) (1791)**  
 Appears in a 1791 directory (Oswald 1975, 203)
- Cottam and Johnson (Hull) (1792)**  
 A Hull directory of 1792 lists Cottam and Johnson as pipe-makers in High Street (Watkins 1979, 108).
- DC Daniel Clay (Halifax) (1687)**  
 Apprentice to George Gill, referred to in his will (Oswald 1975, 199)
- HC Henry Coates (Leeds) (c1666)**  
 Known from a trade token of 1666 showing a roll of tobacco but may refer to a dealer in pipes or tobacco rather than a pipe-maker (*ibid*; Berry 1982, 371). NB. Oswald gives a date of 1665, but Berry illustrates the token, which clearly reads 1666.
- IC Isaac Cary (York) (1654-1672)**  
**Born:** Son of Zacharias, labourer (Andrews 1991, 72)  
**Freedom:** By patrimony 1672 (Oswald 1975, 204; Andrews 1991, 72)
- IC John Chambers (Hull) (1724-1749)**  
**Apprenticed:** To Benjamin Bell in 1724 (Watkins 1979, 109)  
**Married:** ? (died 1749) (SMPR)  
**Died:** A John Chambers buried November 1727 (HTPR)  
 Another John Chambers buried 4.4. 1684 (*ibid*)  
 Another John Chambers buried 13.9.1736 (*ibid*)  
 Another John Chambers buried 12.3.1743 (*ibid*)  
 Another John Chambers buried December 1751 (*ibid*)  
 Watkins found a number of John Chambers and it is unclear which burial relates to John Chambers the pipe-maker.

- IC John Chapman (1) (Hull) (1670-1683)**  
**Apprenticed:** To Elizabeth Atkinson (Watkins 1979, 109)  
**Freedom:** 3.11.1670 (Sheppard 1912, 10)  
 John had apprentices of his own in 1671, Thomas Cooke and in 1675, Francis Wood (*ibid*) and also in 1678/9 and 1682 (Watkins 1979, 109).  
 Appears to have still been working in 1683 as he is named in an entry in the Corporation Bench Book under the date 23<sup>rd</sup> July 1683 in connection with an application by Nicholas Tarboton to become a Burgesse of the Corporation (Sheppard 1912, 12).
- IC John Chapman (2) (Hull) (1764)**  
**Apprenticed:** To William Westerdale in 1764 (*ibid*)
- IC James Coverdale (Hull) (1720)**  
**Apprenticed:** To Richard Tock (1) in 1720 (*ibid*)
- IC Jonathan Crosland (Rotherham) (1747-1772)**  
**Married:** Mary Parker 15.1.1747 (Andrews *in litt* 30.5.1998)  
**Children:** Joseph (baptised 4.3.1752; appears to have been apprenticed to John Salt, cutler in Sheffield from 1764 for 8 years and then George Pearson, also in Sheffield for one year in 1772 (*ibid*; Crossley *in litt* 6.1.1992)
- PC Philip Carbut (Hull) (1722)**  
**Apprenticed:** To William Potter (2) in 1722 (Watkins 1979, 109)
- RC Robert Carbut (Hull) (1730-1740)**  
**Apprenticed:** To Henry Norman (2) in 1730 (*ibid*)  
**Died:** Buried 29.4.1740 (HTPR)
- RC Robert Chapman (Hull) (1674-1692)**  
**Apprenticed:** To Edward Fowler 1674 (Sheppard 1912, 11)  
**Freedom:** 28.7.1681 (*ibid*, 7)  
**Married:** (1) Anne (buried April 1724) (HTPR)  
 (2) Elizabeth (buried 24.7.1747) (*ibid*)  
**Children:** Jane (buried 31.3.1692) (*ibid*)  
 Had a number of apprentices between 1699 and 1740 (Watkins 1979, 109), including Benjamin Taylor in 1720 (Sheppard 1912, 11).
- RC Robert Cliffe (Potovens) (1680)**  
 Appears in the Quarter Sessions Rolls for 1680-1681, together with William Armitage, when they are fined 'for digging clay for pipes, pots and other earthen ware' (Brears 1967, 42)
- SC Samuel Constable (Hull) (1724)**  
**Apprenticed:** To Henry Norman (2) in 1724 (Watkins 1979, 109)
- TC Thomas Chapman (Hull) (1682-1708/1721)**

**Apprenticed:** To Thomas Cooke in 1682 (*ibid*)  
**Freedom:** 1700 (*ibid*)  
**Children:** Elizabeth (buried 16.10.1696) (HTPR)  
**Died:** A Thomas Chapman buried 6.1.1708 (*ibid*)  
Another Thomas Chapman buried August 1721 (*ibid*)  
Thomas witnessed the indenture of an apprentice pipe-maker in 1706.  
(Watkins 1979, 109).

**TC Thomas Cooke (Hull) (1678/9-1720)**

**Born:** 1656 (*ibid*)  
**Apprenticed:** To John Chapman (1) 1671 (Sheppard 1912, 11)  
**Freedom:** 13.2.1679 (*ibid*)  
**Married:** (?) Mary Skinner 30.8.1702 (HTPR)  
**Children:** Sarah (buried 5.3.1686) (*ibid*)  
**Died:** 7.2.1720 aged 64 (Sheppard 1912, 11)  
Sheppard notes that in *Gent's History of Hull*, 1735 page 50 the inscription from a headstone of a grave on the south side of Holy Trinity Church is quoted 'Here lieth the body of Thomas Cooke, pipe-maker, who died the 7<sup>th</sup> of February, 1720, aged 64'.

**TC Thomas Craven (Hull) (1727-1741/1751)**

**Freedom:** By patrimony 1727 (Watkins 1979, 109)  
**Children:** Unnamed daughter (died 1730) (SMPR)  
Unnamed daughter (died 1738) (*ibid*)  
**Died:** A Thomas Craven buried 3.6.1741 (HTPR)  
Another Thomas Craven buried 25.1.1751 (*ibid*)

**TC Thomas Crew (Sheffield) (1721-1733)**

**Children:** William (baptised 9.2.1721; buried 5.5.1722) (Andrews *in litt* 30.5.1998)  
Elizabeth (baptised 21.6.1723) (*ibid*)  
Mary (baptised 1.8.1724) (*ibid*)  
John (baptised 11.6.1726) (*ibid*)  
Thomas (baptised 7.7.1727; buried 1.2.1729) (*ibid*)  
Joseph (baptised 9.10.1728) (*ibid*)  
William (baptised 13.6.1731) (*ibid*)  
J??? (son buried 22.10.1732) (*ibid*)  
???? (son buried 10.5.1733) (*ibid*)

**WC William Carr (York) (1725-1728)**

**Children:** William (baptised 16.12.1725) (Lawrence 1979, 81; Andrews 1991, 72)  
Elizabeth (baptised 27.6.1728; buried 9.7.1728) (*ibid*)

There is also a William Carr working later in the 18<sup>th</sup> century in Hull, but the dates at which he baptised children are 20-30 years later, which suggests that there were two makers of this name.

**WC William Carr (Hull) (1717-1756)**

**Apprenticed:** To Benjamin Bell in 1717 (Watkins 1979, 109)

**Freedom:** 1724 (*ibid*)  
**Children:** Richard (buried 28.8.1740) (HTPR)  
John (buried June 1756) (*ibid*)

William witnessed apprentice and freedoms in 1732, 1764 and 1772. Voted in 1754 and 1774 (Watkins 1979, 109). Andrews (1988, 90) notes that a Will Carr is recorded as 'billeting soldiers in the St Martin's, Coney Street and St Wilfred parishes' in 1756 in Hull. There is a William Carr recorded in York between 1725 and 1728 and it is possible that this maker moved to work there for a few years immediately after completing his apprenticeship.

**Cottam, Askwith and Johnson** (Hull) (1791)  
Listed in directories (Oswald 1975, 203).

**CD Charles Dunning** (York) (1723-1734)

**Apprenticed:** To Christopher Boyes 29.9.1723 (Andrews 1991, 74)  
**Freedom:** 1733 listed as a trunk maker and pipe-maker (*Oswald 1975, 204*)  
**Married:** Elizabeth Harrison 2.10.1732 (Andrews *in litt* 30.5.1998)  
**Children:** Mary (baptised 15.1.1733) (Andrews 1991, 74)  
George (baptised 29.4.1734) (*ibid*)

Christopher Boyes died before Charles's apprenticeship was complete, it is therefore possibly that it was transferred to Christopher's son, Samuel Boyes (*ibid*).

**GD George Dean** (York) (1703)

**Apprenticed:** To Frances Boyes 20.5.1703 (*ibid*)

**ID John Dalton (1)** (Hull) (1695-1723)

**Apprenticed:** To Robert Burrill (1) (Watkins 1979, 109)  
**Freedom:** 23.10.1695 (Sheppard 1912, 11)  
**Children:** John (Freed by patrimony 1723) (Watkins 1979, 110)  
**Died:** By 1723 (*ibid*)

**ID John Dalton (2)** (Hull) (1723-1724)

**Freedom:** By patrimony 1723 (*ibid*)  
Voted in 1724 (Oswald 1975, 204)

**ID John Davison** (Hull) (1798)

**Apprenticed:** To Edward Blyth in 1798 (*ibid*)

**ID Jacob Davy** (York) (1721)

**Freedom:** 1721 (Brooks *in litt* 15.6.1998)

**ID John Dawson** (York) (1677-1703)

**Freedom:** 1677 as a pipe-maker (Oswald 1975, 204; Andrews 1991, 73)  
**Children:** William (freed 1702, no trade given) (*ibid*)  
Sarah (baptised 10.2.1677; buried 21.12.1699) (*ibid*)  
**Died:** Buried 29.2.1703 (*ibid*)



John did jury service in October 1666. In 1671 he was listed in the Hearth Tax records as having 'two hearths in St. Helen's parish'. He did more jury service on 8.4.1687. He appears to have taken two apprentices, Francis Wilkinson, who was bound apprentice on 15.12.1679 and Robert Morley who took his freedom on payment of £1 in 1703 (*ibid*).

**ID James Day (York) (1717-1721)**

**Born:** son of James Day, tanner (Andrews 1991, 73)

**Freedom:** by patrimony in 1721 (Oswald 1975, 204; Andrews 1991, 73)

**Children:** Ann (baptised 17.3.1717; buried 3.11.1718) (*ibid*)  
Thomas (baptised 17.4.1719; buried 8.9.1719) (*ibid*)

From the information given in the registers, it is impossible to say if the two children, Ann and Thomas, were Thomas's children or siblings, ie. his father's children (*ibid*).

**ID John Duncan (York) (1677)**

**Freedom:** 1677 (Oswald 1975, 204)

**MD Michael Dunn (Birstall) (c1759-1816)**

**Born:** c1759 possibly in Leeds (Atkin *in litt*)

**Married:** Margaret Dodson 5.1.1783 at Rawmarsh (Brooks 1989, 3)

**Died:** 1816 aged 57 (*ibid*)

Prior to her marriage to Michael, Margaret had two illegitimate children, Ann (baptised 17.9.1775) and Joseph (baptised 1.8.1779) who went on to be a pipe-maker in Birstall (*ibid*).

**PD Peter Davison (Hull) (1798)**

**Children:** John (Bound apprenticed in 1798) (Watkins 1979, 110)  
Peter working as a pipe-maker when his son was bound apprentice to Edward Blyth (*ibid*).

**TD Thomas Dean (Hull) (1753)**

**Apprenticed:** To Michael Westerdale (1) in 1753 (*ibid*)

**WD William Dawson (York) (1700-1702)**

**Freedom:** 1702 (Brooks *in litt* 15.6.1998)

Appears in directories 1700-1702 (Oswald 1975, 204)

**WD William Dodgson (York) (1712-1713)**

**Born:** Son of Oswald Dodgson, Cobbler (Andrews 1991, 74)

**Freedom:** by patrimony 1712 (Lawrence 1979, 81)

**Married:** Sarah Calton 17.2.1713 (Andrews 1991, 74)

**Died:** Buried 3.2.1759 (*ibid*)

The burial of a William Dodgson is recorded on 3<sup>rd</sup> February 1760 whose occupation was given as a merchant taylor. It is possible William changed his trade from pipe-maker to a 'more lucrative one' (Andrews 1988, 90). However, Andrews (1987d, 5) also notes that a Mr William Dodgson was

buried on 3<sup>rd</sup> February 1759 'under the second blue stone from the vestry door'.

**IE John Eggleston (Hull) (1672-1698/1742)**

**Apprenticed:** To Susanna Kilham, the widow of Thomas Kilham, in 1672 (Sheppard 1912, 11)

**Freedom:** 23.10.1679 (*ibid*)

**Children:** Jane (buried September 1683) (HTPR)  
Unnamed son (buried 22.12.1695) (*ibid*)

**Died:** A John Eggleston buried 10.1.1698 (*ibid*)  
Another John Eggleston buried 25.10.1742 (*ibid*)

A John Eggleston paid poor rates in Austin Ward in 1695 (*ibid*).

**IE John Ellicar (Hull) (1691)**

**Apprenticed:** To Henry Norman (1) in 1683 (Watkins 1979, 110)

**Freedom:** 20.6.1691 (Sheppard 1912, 8)

**AF Anthony Fawcet (Dent) (c1670)**

Known from a 1670 trade token which shows two pipes and crossed pipes; may refer to a dealer in pipes or tobacco rather than a pipe-maker (Oswald 1975, 200; Berry 1982, 370)

**BF Barbara Fowler (Hull) (1676)**

**Married:** Edward Fowler

Apprenticeship transferred from her husband in 1676, presumably at the time of his death (Watkins 1979, 110).

**CF Charles Farnehill (York) (1669-1673)**

**Freedom:** 1669 (no trade given) (Andrews 1987d, 5) but Berry (1982, 371) has Farnehill's freedom by redemption in 1670.

**Children:** Frances (born 1672; buried 28.9.1673) (Andrews 1987b, 4). Name appears on a 1669 trade token together with a pipe and a roll of tobacco (Oswald 1975, 204; Berry 1982, 371). Recorded in the Hearth Tax Returns for 1671 as having 5 hearths in Minster Yard (*ibid*).

**EF Edward Fowler (Hull) (1656-1676)**

**Apprenticed:** To Hugh Atkinson in 1656 (Sheppard 1912, 10)

**Freedom:** 18.6.1663 (*ibid*, 7)

**Married:** Barbara Atkinson, daughter of Hugh ?Atkinson, 22.1.1664 (HTPR)

**Children:** Edward (buried 20.4.1666) (*ibid*)  
Thomas (buried 15.7.1669) (*ibid*)

**Died:** ?1676 (Watkins 1979, 110)

Edward took Robert Chapman apprentice in 1674 (Sheppard 1912, 10).

**GF George Fowler (Hull) (1663-1681)**

**Apprenticed:** To Elizabeth Atkinson in 1663 (Watkins 1979, 110)

**Freedom:** 30.9.1670 (Sheppard 1912, 10)

- Died:** 1681 (HTPR)
- WF William Farnhill** (York) (1689)  
**Apprenticed:** To Richard Shaftoe (1) 1.7.1689 (Andrews 1991, 74)
- WF William Finch** (Rawmarsh) (1748)  
**Apprenticed:** To Richard Schorah 1748 (Oswald 1975, 200)
- GG George Gill** (Halifax) (1687)  
 Date of a will listed by Oswald (1975, 200)
- GG George Gillott** (Sheffield) (1775-1822)  
**Married:** Ann How at St Peter's Cath. 14.11.1775 (Andrews *in lit* 1998)  
**Children:** William (baptised 15.3.1776) (*ibid*)  
 Joseph (baptised 13.11.1778) died ? (*ibid*)  
 Mary (baptised 18.1.1778; died ?) (*ibid*)  
 Sarah (baptised 1.8.1779) (*ibid*)  
 Hannah (baptised 30.1.1780) (*ibid*)  
 John (baptised 23.4.1786) (*ibid*)  
 Joseph (baptised 18.9.1787) (*ibid*)  
 Mary (baptised 24.10.1790; died ?) (*ibid*)  
 Mary (baptised 30.3.1817) (*ibid*)  
 George appears in Baines Directory as a pipe-maker in New Street (*ibid*)
- IG John Gill (1)** (Halifax) (1673)  
 Date of a will listed by Oswald (1975, 200)
- IG John Gill (2)** (Potovens, Wakefield) (1709-1717)  
 Brears (1967, 42) notes that between 1709 and 1717 the Gill family moved to Red Hall, Snow Hill, near Potovens.
- IG Judith Gill** (Potovens, Wakefield) (1692/93-1709)  
 Appears in the Quarter Sessions Rolls for 1692/93 in connection with a claim against other pipe-makers who were copying her IG mark in order to improve their sales (Brears 1967, 42). Held a 'poor cott.' at Potovens (*ibid*).
- IG John Goldwell (1)** (Hull) (1699-1743)  
**Apprenticed:** To Robert Chapman in 1699 (Watkins 1979, 110)  
**Freedom:** 1707 (*ibid*)  
**Married:** Sarah (buried 9.5.1741) (HTPR)  
**Children:** Samuel (Freed by patrimony 1745) (Watkins 1979, 110)  
**Died:** Buried 21.4.1743 (HTPR)  
 John was working in Blanket Row 1724-1736 (Watkins 1979, 110)
- IG John Goldwell (2)** (Hull) (1774)  
 Voted in 1774 (Oswald 1975, 203)
- IG Joseph Green** (Hull) (1725)

- Apprenticed:** To John Robson in 1725 (Watkins 1979, 111)
- MG Matthew Goodbarne** (Hull) (1716-1726)  
**Apprenticed:** To Robert Burrill (1) in 1716 (Watkins 1979, 111)  
**Freedom:** 1727 (*ibid*)
- RG Robert Gowland** (Hull) (1784-1815)  
**Apprenticed:** To Thomas Westerdale in 1784 (*ibid*)  
The indenture relating to Robert's apprenticeship appears to have been cancelled before the expiry date by consent of both parties; Working in High Street 1790-1791 and probably work until 1815 (*ibid*).
- RG Richard Greaves** (Rawmarsh) (1747)  
**Married:** Martha Wild 10.8.1747 (SMRPR)
- SG Samuel Goldwell** (Hull) (1745-1774)  
**Freedom:** By patrimony 1745 (*ibid*).  
Took at least four apprentices between 1749 and 1802. Voted in 1747, 1757 and 1774. Known to be working in Blanket Row 1747-52, in the premises previously used by his father (*ibid*). Took out a Sun Alliance insurance policy for £200 on his property in 1762 (Oswald 1975, 203).
- TG Thomas Gill** (Wakefield) (1773-1787)  
Appears in the West Riding Quarter Sessions and Land Tax Returns for 1773-1787 (Lawrence 1973, 191)
- TG Thomas Goodbarn** (Hull) (1699-1712)  
**Apprenticed:** To Thomas Cooke in 1699 (Watkins 1979, 111)  
**Freedom:** 1706 (*ibid*)  
Thomas was a witness in Apprentice Records in 1712 (*ibid*).
- WG William Gill** (York) (1694)  
**Born:** Baptised 10.6.1681, son of William Gill (Andrews 1991, 74)  
**Apprenticed:** To Frances Boyes 18.5.1694 (*ibid*)
- AH Andrew Hall** (York) (1702-1753)  
**Apprenticed:** To Frances Boyes (*ibid*)  
**Freedom:** 6.5.1702 as a trunk and pipe-maker on payment of £1 (Oswald 1975, 204; Andrews 1991, 74)  
**Children:** Rowland (took freedom by patrimony 1739 as a coachmaker)  
John (took freedom by patrimony 1753 as a staymaker) (*ibid*)
- AH A Hillary** (?Pontefract) (c1740-1780)  
Identified from a pipe stem found at Wood Hall Moated Manor, Womersley.
- AH Alice Holmes** (nee Rawson) (York) (1730-1778)  
**Married:** Christopher Holmes 31.12.1730 (Andrews 1991, 75)  
**Children:** (see Christopher Holmes below)  
Took Rawson Aray apprentice 10.10.1778 (*ibid*, 76)

**CH Christopher Holmes (York) (1724-1764)**

**Born:** son of Ralph Holmes, a pipe-maker (Andrews 1991,76)

**Apprenticed:** To his father in 1724 (*ibid*)

**Freedom:** by patrimony 1730 (*ibid*) Oswald (1975, 204) gives a date of 1732

**Married:** Alice Rawson 31.12.1730 (Andrews 1991, 76)

**Children:** Unnamed daughter (baptised in Gainsborough 1732) (*ibid*)

Rawson (baptised 4.9.1737; buried 31.7.1743) (*ibid*)

William (baptised 5.8.1740) (*ibid*)

Sarah (baptised 5.4.1741; buried 11.7.1741) (*ibid*)

William (baptised 12.9.1742) (*ibid*)

Sarah (baptised 8.7.1745) (*ibid*)

Alice (baptised 17.2.1748; buried 27.1.1750) (*ibid*)

Christopher (buried 10.2.1750) (*ibid*)

**Died:** 1764 (buried 13.3.1764) (*ibid*)

Took an apprentice, Thomas Watson, on 5.11.1737. Christopher's widow, Alice, continued her husbands business and was still working in 1778 (*ibid*).

**EH Edmund Hillary (York) (1721-1729)**

**Born:** son of John Hillary, cordwainer (Andrews 1991, 75)

**Freedom:** by patrimony 1721(Oswald 1975, 201; Andrews 1991, 75)

**Children:** Anne (baptised 11.8.1722) (*ibid*)

Susanna (baptised 20.12.1724; buried 25.3.1729) (*ibid*)

Mary (buried 20.3.1728) (*ibid*)

Records show that in 1729 Edmund gave evidence in a case of insult (Andrews 1988, 91).

**GH George Hart (York) (1722-1757)**

**Born:** Son of Elizabeth Hart, widow (Andrews 1991, 74)

**Apprenticed:** To Christopher Boyes 2.2.1722 (*ibid*)

**Freedom:** 1733 on payment of £1 (*ibid*)

**Children:** Jane (baptised 5.11.1751; buried 27.6.1752) (*ibid*)

Mary (baptised 2.10.1753) (*ibid*)

John (baptised 30.1.1757) (*ibid*)

Christopher Boyes died in 1725 and it appears that George's apprenticeship was transferred to Christopher's son, Samuel Boyes (*ibid*)

**GH George Hodgson (Hull) (c1668)**

Known from a trade token of 1668 showing a man smoking but may refer to a dealer in pipes or tobacco rather than a pipe-maker (Oswald 1975, 203; Berry 1982, 370)

**GH George (or Geoffrey/Godfrey) Hutchinson (Halifax) (1780-1853)**

Appears in the West Riding Quarter Sessions records, Polls and Directories (Oswald 1975, 200)

**IH John Hall (Rawmarsh) (1750-1766)**

**Children:** Anne (baptised 8.12.1750) (SMRPR)

Hannah (baptised 9.3.1766) (*ibid*)

John was recorded as a pipemaker in both 1750 and 1766 when his children were baptised.

- IH John Hayes** (Leeds) (1798-1835)  
Appears in the Leeds Directories and Poll books for 1798-1835 (Lawrence 1973, 191)
- IH John Henfray** (Rotherham) (1668-1704)  
**Married:** Sarah Bothomley 12.11.1668 (Andrews *in litt* 30.5.1998)  
John Henfray is referred to in 1704 in W. Blagby 'The Old Meeting House' 1906 (Oswald 1975, 200).
- IH Issac Hodgeson** (Leeds) (1740-1760)  
Known from a roll-stamp stem mark lettered ISSAC HODGSON MAKER IN LEEDS (Pcode 23535).
- IH John Holmes** (York) (1758)  
(Oswald 1975, 204) Oswald attributes this reference to information from E J Berry. John Holmes not listed in Andrews work.
- IH John Horsfield** (Bradford) (1728) (BQR ref. QS1/67/6)  
**Married:** Mary (*ibid*)  
John's wife Mary was accused of stealing money from an Eliz Mercer and was tried at the Assizes in York. In spite of strong suspicions of her guilt there was insufficient evidence to find her guilty. A petition was submitted appealing against this ruling resulting in Mary being sent to the gaol at York castle to await deportation to 'collonys or plantations in America' for a period of seven years. For a full transcription of the petition and the order detailing the sentence, see Appendix 2.
- IH John Howton** (Hull) (1784)  
**Apprenticed:** To Samuel Silkwood in 1784 (Watkins 1979, 111)
- IH John Hutchinson** (Hull) (1725-1783)  
**Apprenticed:** To Richard Tock (1) in 1725 (*ibid*)  
**Children:** William (apprenticed in 1776) (*ibid*)  
Ann (Buried 25.4.1783) (HTPR)  
John was working as a pipe-maker in 1776 when he witnessed the apprenticeship of his son (Watkins 1979, 111).
- MH Mark Hesp** (York) (c1790-1820)  
**Born:** Son of John (Andrews 1980s, 9)  
**Baptised:** 20.6.1747 at Wintringham (*ibid*)  
**Freedom:** As a coal merchant in 1784 (*ibid*)  
**Married:** Ann, buried 14.4.1808 aged 69, death due to decline (*ibid*)  
**Children:** Mark, apprenticed to his father as a coal merchant 5.9.1785; died 1808, aged 35 years (*ibid*)

Mark began his life as a coal merchant, taking up pipemaking in the early 1790's. He had a number of apprentices including George Mason (1792), Robert Lazenby (1794), Anthony Nelson (1796), George Sickling (1797), George Shaftoe (1802) and Thomas Lawton (1807) at least three of whom went on to become master pipe-makers in their own right (*ibid*)

**RH Ralph Hare (Hull) (1727-1754)**

**Apprenticed:** To Robert Burrill (1) in 1727 (Watkins 1979, 111)

**Freedom:** 1727 (*ibid*)

Voted in 1747 and 1754 (Oswald 1975, 203)

**RH Ralph Holmes (York) (1694-1730)**

**Born:** son of Thomas Holmes, a pipe-maker (Andrews 1991, 76)

**Freedom:** by patrimony 1694 (Oswald 1975, 204; Andrews 1991, 76)

**Children:** Thomas (baptised 24.9.1699; took freedom as a pipe-maker 1721) (*ibid*)

Ralph (took freedom 1713) (*ibid*)

Christopher (apprenticed to his father 13.4.1724; took freedom 1730 at the age of 24) (*ibid*)

Frances (baptised 13.10.1728; buried 31.10.1728) (*ibid*)

Ralph was described as a trunk maker when his son Thomas took his freedom in 1721. By the time he took on his son Christopher as an apprentice, in 1724, he was described as a pipe-maker (Andrews 1988, 91).

**SH S Hillary (Pontefract) (c1740)**

Known from marked pipe-stems found at Horsefair, Pontefract (Lawrence 1973, 192). Oswald (1975, 200) gives a date of c1750.

**TH Thomas Harcastle (Amsterdam) (17<sup>th</sup> Century)**

**Born:** Ripon (Duco 1981, 335)

**TH Thomas Holmes (1) (York) (1657-1694)**

**Freedom:** 1657 as an innholder (Lawrence 1979, 81)

**Married:** Mary Whitfield 13.7.1658 at St Martin's, Coney Street (Andrews 1991, 76)

**Children:** Ralph (freed 1694) (*ibid*)

Not listed as a pipe-maker until 1694 on the freedom of his son (*ibid*)

**TH Thomas Holmes (2) (York) (1721-1755)**

**Born:** Son of Ralph Holmes, a trunkmaker (Lawrence 1979, 81)

**Freedom:** by patrimony in 1721 as a tobacco pipe-maker (Oswald 1975, 204; Andrews 1991, 77)

**Children:** John (baptised 23.12.1727) (*ibid*)

Rebecca (baptised 20.5.1734) (*ibid*)

Tomlinson (daughter, baptised 2.1.1739) (*ibid*)

**Died:** Buried 12.2.1755 (*ibid*)

Records show that in 1739 a Thomas Holmes appeared in court on charges of felony and assaulting the arresting constable (Andrews 1988, 91).

- WH William Hodgson (Leeds) (c1669)**  
Known from a trade token of 1669 showing a man smoking but may refer to a dealer in pipes or tobacco rather than a pipe-maker (Oswald 1975, 200; Berry 1982, 371).
- WH William Hutchinson (Hull) (1776)**  
**Apprenticed:** To Samuel Goldwell in 1776 (Watkins 1979, 111)
- II James Johnson (Hull) (1792)**  
Listed in directories (Oswald 1975, 203)
- RJ Richard Jackson (Hull) (1763)**  
**Apprenticed:** To Samuel Goldwell in 1763 (Watkins 1979, 112)
- EK Elex. Kitchen (Hull) (1709)**  
**Apprenticed:** To Henry Norman (2) in 1709 (*ibid*)
- MK Michael Kenny (Hull) (1714)**  
**Apprenticed:** To John Goldwell (1) in 1714 (*ibid*)
- SK Susanna Kilham (Hull) (1672-1679)**  
**Married:** Thomas Kilham  
Took John Eggleston apprentice in 1672, who took freedom in 1679 (Sheppard 1912, 9; Watkins 1979, 112)
- TK Thomas Kilham (or Kellam) (Hull) (1653-1671/1679)**  
**Freedom:** 6.10.1653 (Sheppard 1912, 7)  
**Apprenticed:** To Hugh Atkinson (*ibid*)  
**Married:** Susanna (*ibid*, 9)  
**Children:** Leonard (born 25.11.1653) (HTPR)  
Susanna (buried 24.2.1666) (*ibid*)  
**Died:** By 1671 or 1679 (Watkins 1979, 112; Sheppard 1912,9)  
Thomas had at least two apprentices one in 1664 and another in 1666. Watkins (1979, 112) states that Thomas was dead by 1679 as his widow has an apprentice of her own admitted freeman in that year Watkins (1979, 112). However, Sheppard (1912, 9) states that Thomas must have died in or before 1671 because in the following year, ie. 1672, his widow took John Eggleston apprentice. Presumably this is the same apprentice who became a freeman in 1679.
- WK William Kyte (Hull) (1700-1722)**  
**Freedom:** 1700 (Watkins 1979, 112)  
**Apprenticed:** To Robert Burrill (1) in 1685 (*ibid*)  
**Children:** Rachel (buried October 1703) (HTPR)  
Jane (buried January 1706) (*ibid*)  
**Died:** 1722 (SMPR)
- CL Christopher Laze (Netherlands) (1632-1655)**



**Born:** In Yorkshire (Anon 2000)  
**Married:** Barbara Cornelisdr van Eijck between 1632 and 1635 (*ibid*)  
Appears in a number of court records. In 1640 took a Wouter Tucker to court for failure to pay for a delivery of pipes; also in 1640 gave evidence to an enquiry into an inheritance; and in 1646 acted as witness at the marriage of a step-daughter (*ibid*). Also in 1646 Christopher, together with Andries Jansz, were charged with the non-payment of a bill of 172 guilders for the supply of pipe clay (*ibid*). In 1655 Christopher was convicted of theft and sentenced to be flogged and two years banishment from Leiden to Rhineland (*ibid*).

**HL Henry Ludlam (Rotherham) (1669)**

**Children:** Elizabeth (eldest) (BIW Vol 50, Fol. 192)  
Alice (2<sup>nd</sup> daughter) (*ibid*)  
Joyce (youngest) (*ibid*)

Will dated 6.4.1669 in which Henry leaves all 'the goods that is in the little parlor behind the shopp and one longe table ... and one bay mare' to his second daughter Alice. In addition he leaves to Alice 'all the tobacco in the warehouse' which suggests that Henry was also selling tobacco. The rest of his estate is to be divided equally between his wife, who is un-named, and to his remaining two daughters Elizabeth and Joyce (*ibid*). A transcript of the will can be found in Appendix 2

**HL Henry Lund (Hull) (1700)**

**Apprenticed:** To Henry Norman (1) (Watkins 1979, 112)  
**Freedom:** 1700 (*ibid*)

**IL John Leconby (Hull) (1666-1694)**

**Apprenticed:** To Thomas Kilham (Sheppard 1912, 7)  
**Freedom:** 16.8.1666 (*ibid*, 11)

John had at least two apprentices of his own in 1679 and 1694 (Watkins 1979, 112)

**LL Lemuel Lumley (York) (1780-1803)**

**Born:** Son of Samuel Lumley of Doncaster) (Andrews 1987d, 10)  
**Married:** Mary (died 30.8.1803; buried 2.9.1803 aged 53 years) (*ibid*)  
**Children:** Dinah (baptised 19.4.1780) later married Joseph Deacon (*ibid*)

Lemuel (1<sup>st</sup> son) (born 31.10.1786; baptised 7.11.1786; died of whooping cough 4.8.1789 and buried 6.8.1789) (*ibid*)

Elizabeth (5<sup>th</sup> daughter) (born 8.12.1789; baptised 13.12.1789) (*ibid*)

Lemuel (2<sup>nd</sup> son) (born 9.1.1791; baptised 16.1.1791; died 16.9.1803 aged 14 years) (*ibid*)

Jane (6<sup>th</sup> daughter) (Born and baptised 13.1.1793) (*ibid*)

Thomas (3<sup>rd</sup> son) (born 27.6.1795; baptised 28.6.1795; died 25.2.1796 in the getting of teeth, buried 28.2.1796) (*ibid*)

Thomas (4<sup>th</sup> son) (born 9.7.1797; baptised 10.7.1797) (*ibid*)

William (born 21.11.1799; baptised 1.12.1799) (*ibid*)

- Died:** 14.2.1803 aged 46 years, buried 17.2.1803 (*ibid*)
- RL Robert Lazenby (York) (1794)**  
**Apprenticed:** To Mark Hesp 1794 (Andrews 1980s, 9)
- SL Samuel Leeland (1) (Hull) (1719)**  
**Apprenticed:** To Richard Tock (1) in 1719 (Watkins 1979, 112)
- SL Samuel Leeland (2) (Hull) (1727)**  
**Freedom:** By patrimony in 1727 (*ibid*)
- SL Samuel Lumley (1) (Rotherham) (1723-1731)**  
**Married:** Maria Littleforth 30.6.1723 (Oswald 1975, 201) (?Mary, widow of Samuel Lumley buried 19.10.1753)(Andrews *in litt* 30.5.1998)  
**Children:** Dorothy (baptised 16.2.1726) (*ibid*)  
Samuel (baptised 3.11.1731) (*ibid*)  
Samuel's son, also called Samuel, became a pipe-maker and moved to Doncaster, where he died in his 30s. Samuel (1) may well have moved to Doncaster to take over his son's business and help raise his grandchildren from the late 1760s (see Samuel (2) below). However, a record for the burial in Doncaster of a Mary Lumley in 1753 states that she was a widow of Samuel Lumley. Lumley is a common name in Yorkshire, as is Samuel and Mary, and it may be that this burial is not the wife of Samuel Lumley (1) the pipe-maker. Samuel's grandson, Lemuel, went on to become a York pipe-maker (Andrews 1993, 4).
- SL Samuel Lumley (2) (Doncaster) (1731-1766/69)**  
**Born:** Son of Samuel (baptised 3.11.1731, Rotherham) (Andrews 1993, 4)  
**Married:** Ann Bleasby 24.12.1753 (IGI) (buried 23.2.1769) (Andrews 1993, 4)  
**Children:** Lemuel (baptised 6.2.1755, Doncaster; later to become a pipe-maker in York) (*ibid*)  
Mary (baptised 5.4.1756) (*ibid*)  
Peter & Deborah (presumably twins, baptised 11.12.1757; buried 16.12.1757) (*ibid*)  
Zebulon (baptised 1.2.1759; buried 9.3.1765) (*ibid*)  
Dinah (baptised 16.12.1760 – daughter of Samuel Lumley Snr) (Andrews *in litt* 30.5.1998)  
Elizabeth (baptised 14.4.1762) (*ibid*)  
Thomas (baptised 14.4.1764) (*ibid*)  
Margaret (baptised 2.6.1766; buried 25.3.1773) (*ibid*)  
**Died:** Between 1766 and 1769  
At first glance the documentary record appears confusing, especially with regard to exactly when Samuel Lumley (2) died. Samuel must have been alive until about 1766 since he baptised children at regular intervals until that date. Andrews notes that Samuel must have died around 1769 since when his wife, Ann, was buried in that year she was described as 'widow of

Samuel Lumley'. The death of Samuel around 1766-9 would, however, appear to be at odds with an advertisement in the *York Courant* dated 2<sup>nd</sup> April 1782, which offers for rent '*...the house lately occupied by Samuel Lumley. There is a Pot, Furnace, Mold, Grates, and everything necessary on the Premises for the Business.*' (Fowler *et al* 1979, 60). The property in question appears to be the house and pipe works in Church Street, Doncaster, which has been found in excavations (see Chapter 5). In 1767 a map of Doncaster was prepared to show the extent of Corporation property (Buckland *et al* 1989, 10). This map seems to have been prepared prior to selling off blocks of land for development. In 1767 the area later to be occupied by the Lumley kiln was clearly shown as garden plots, showing that the pipeworks must have been built after that date. If Samuel was already dead by 1769 it is hard to see how so much kiln debris could have accumulated on the site in such a short period. Looking at the ages of Samuel's children provides one explanation. When his widow died in 1769 there were still at least five children who appear to have been alive, the eldest of whom was Lemuel, aged 14. Having been orphaned, these children would have needed someone to care for them. The most likely scenario is that their father, Samuel (2), had built a new pipe works on the former Corporation land just before his death. Samuel's father, also called Samuel, was a pipe-maker, recorded working in Rotherham from at least 1723 to 1731. When Samuel (2) died his father may well have moved to Doncaster to take over the new works and help look after the children. When the children's mother died, Samuel (1) would have been able to look after his five young grandchildren. He would also have been able to teach his young grandson, Lemuel, the art of pipemaking. By 1780 Lemuel had married and was working as a pipe-maker in York. The 1782 advertisement in Doncaster offering the pipe works for rent refers to it as the house '*lately occupied by Samuel Lumley*' (*ibid*). This would make sense if Lemuel had just left home to set up his own business in York. Furthermore, Samuel (1) would have been about 80 by this time and so he is likely to have either retired or died at around this date. This scenario would explain the large amount of Samuel Lumley kiln waste found on the site as well as the confusing documentary references. It also provides a tight date range of no more than 1768-1782 for the kiln waste. There are, however, two other pieces of evidence from the documentary sources that do not fit in with this scenario. First, the death of a Mary Lumley in 1753 clearly states '*widow of Samuel Lumley*'. If this is taken to be the wife of Samuel (1) and has simply been mis-read as Mary, rather than Maria, it would indicate that Samuel was dead by this date. Although this may be pure coincidence as Lumley is a common name around Doncaster and Rotherham at this date, and both Samuel and Mary were popular names in the eighteenth century. Second, the baptism record for Dinah, daughter of Samuel Lumley (2) clearly states she is the daughter of Samuel Lumley senior (Snr). The use of this phrase in the records would suggest that there was another Samuel Lumley in Doncaster at this date, possibly even a close member of the same family. It is possible, therefore, that there is a third Samuel Lumley who may be the person responsible for the quantity of kiln waste found in Church Street.

- SL** ?**Samuel Lumley (3)** (Doncaster) (c1766/69-1782)  
No records as yet studied that refer directly to a Samuel Lumley (3) but his presence is implied in the baptism record of Dinah, ?daughter of Samuel Lumley (2) in Doncaster, where it clearly states that she is the daughter of Samuel Lumley Snr (Andrews *in litt* 30.5.1998)
- TL** **Thomas Law** (York) (1739-1749)  
**Born:** son of Peter Law, a labourer, baptised 12.9.1725 (Andrews 1991, 78)  
**Apprenticed:** To William Ramsden for 8 years in 1739 (*ibid*)  
**Married:** Elizabeth Boyes 4.8.1747 (*ibid*)  
**Children:** Ann (baptised 26.6.1748; buried 22.7.1748) (*ibid*)  
Elizabeth (baptised 26.11.1749) (*ibid*)
- VL** **Valentine Lawson** (Hull) (1726-1735)  
**Apprenticed:** To John Robson in 1726 (Watkins 1979, 112)  
**Freedom:** 1735 (*ibid*)
- WL** **William Lee (1)** (Rotherham) (1655-1680/81)  
**Married:** Elizabeth Ardan 16.10.1655 (Oswald 1975, 201; Andrews *in litt* 30.5.1998)  
**Children:** Mary (baptised 13.1.1656) (*ibid*)  
Elizabeth (baptised May 1666) (*ibid*)  
William (baptised 27.3.1670) (*ibid*)  
Ann (baptised 2.4.1678) (*ibid*)  
Sarah (baptised 22.1.1678) (*ibid*)  
Francis (BIW Vol 59, Fol. 19)  
**Died:** By 1681. Record of a will dated 29.1.1680/81 (*ibid*)  
In William's will of 29<sup>th</sup> January 1680 he leaves six pairs of tobacco pipe moulds and two screws to his son Francis. A transcript of the will can be found in Appendix 2.
- WL** **William Lee (2)** (Rotherham) (1692)  
**Children:** Thomas (apprenticed to Thomas Oxley, cutler, 1692)  
(Crossley *in litt* 6.1.1992)
- BM** **Benjamin Marsden** (Rotherham) (1737-1749)  
**Married:** Hannah Rodgers 26.7.1737 (Andrews *in litt* 30.5.1998)  
**Children:** James (baptised 4.1.1737/8) (*ibid*)  
Hannah (baptised 28.11.1742) (*ibid*)  
Benjamin's son, James, was apprenticed to a Samuel Fowler, cutler, in 1749 (Crossley *in litt* 6.1.1992)
- GM** **George Mason** (York) (1792-1839)  
**Born:** Son of George and Ann (Oswald 1975, 201; Andrews *in litt* 1998)  
**Baptised:** 30.11.1777 (*ibid*)

- Apprenticed:** To Mark Hesp of York for 7 years by indenture in 1792  
(Andrews 1987d, 12)
- Freedom:** 1800 (*ibid*)
- Married:** Mary Peirs 1803 (*ibid*)
- Died:** 1839 aged 63 years, buried 7<sup>th</sup> February (*ibid*, 13)
- George took at least three apprentices, George Marshall (29.4.1817); Ingram Haw (3.7.1823); William Oldridge (28.12.1836). He also appears in the 1830 and 1832 polls (*ibid*, 12)
- GM George Middleton (York) (1707)**  
**Freedom:** 1707 (Oswald 1975, 204)
- IM John Mabson (York) (1673)**  
**Freedom:** 1673 (Lawrence 1979, 81)
- IM John Mansfield (Hull) (1732)**  
**Apprenticed:** To Michael Westerdale (1) in 1732 (Watkins 1979, 112)
- IM John Marshall (York) (1673- 1674)**  
**Born:** Son of William Marshall, Miller (Andrews 1987b, 5)  
**Freedom:** 1673 (Oswald 1975, 204; Andrews 1991, 82)  
**Married:** Jane Temperton 9.6.1674 (*ibid*)
- IM John Mason (York) (1673)**  
**Freedom:** 1673 (Brooks *in litt* 15.6.1998)
- IM John Michael (Hull) (1693)**  
**Apprenticed:** To Thomas Cooke in 1693 (Watkins 1979, 112)
- IM John Middleton (York) (1679-1713)**  
**Born:** Son of George Middleton, a merchant tailor (Andrews 1991, 84)  
**Freedom:** by patrimony 1679 as a trunkmaker (Lawrence 1979, 81; Andrews 1991, 84)  
**Married:** Mary (buried 2.1.1710) (*ibid*)  
**Children:** Ann (buried 27.6.1686) (*ibid*)  
Elizabeth (buried 9.4.1695) (*ibid*)  
George (freed 1707) (Lawrence 1979, 81; Andrews 1991, 84)  
John is listed as a pipe-maker when his son George took his freedom (*ibid*)
- IM James Mitchell (Rotherham) (1782)**  
Appears in Rotherham Quarter Sessions in 1782 (Lawrence 1973, 192)
- IM John Mitchell (Halifax) (1781)**  
Appears in Wakefield Quarter Sessions in 1781 (*ibid*)
- MM Matthew Mattison (York) (1668)**  
**Apprenticed:** To Abraham Boyes 23.10.1668 (Andrews 1991, 84)

- RM Robert Morley (York) (1703-1727)**  
**Freedom:** 1703 on payment of £1 (Oswald 1975, 204; Andrews 1991, 85)  
**Married:** Jane Pearson 18.9.1721 (*ibid*)  
**Children:** Francis (freed as a staymaker in 1739) (*ibid*)  
**Died:** Buried 18.10.1727 (*ibid*)
- TM Thomas Mason (York) (1786)**  
(Oswald 1975, 204)
- TM Thomas Mason (Leeds) (1796)**  
Appears in the Liverpool Polls 1796 (*ibid*, 201)
- TM Thomas Missingtine (Hull) (1717)**  
**Apprenticed:** To Robert Chapman in 1702. (Watkins 1979, 112)  
Thomas witnessed an apprenticeship in 1717 (*ibid*).
- WM William Mason (York) (1698)**  
**Freedom:** 1698 (Brooks *in litt* 15.6.1998)
- WM William Moore (York) (1662-1681)**  
**Born:** son of Will Moore, a currier (Andrews 1991, 84)  
**Freedom:** by patrimony 1662 as a trunk maker (Lawrence 1979, 82)  
In the Hearth Tax Returns for 1671 William Moore is listed as having 2 hearths (Andrews 1987d, 14). Andrews (1991, 84-85) notes that a Will Moore, trunkmaker, did jury service on 10.10.1674. William Moore took an apprentice, Ralph Holmes, on 9.5.1681. He also appears to have issued an undated trade token with four pipes and the lettering YORKE on the obverse and WILL MOORE IN STONE-GATTE TUNKMAKERHIS HALFPENNY on the reverse (Andrews 1991, 84-5; Lawrence 1979, 82; Berry 1982, 371, Plate 1, No. 2). Berry (1982, 371) also lists a William Moore, mariner, was made free in York in 1667 and is described as a pipemaker.
- WM William Mowbray (Hull) (1679)**  
**Apprenticed:** To Henry Norman (1) in 1679 (Watkins 1979, 112)
- AN Anthony Nelson (York) (1796)**  
**Apprenticed:** To Mark Hesp 24.11.1796 (Andrews 1987d, 14)
- CN Christopher Norman (Hull) (1724)**  
**Freedom:** By patrimony 1724 (Watkins 1979, 112)  
**Children:** Josh(ua) (buried 21.6.1738) (HTPR)  
Jas (*sic*) (buried 13.10.1746) (*ibid*)
- HN Henry Norman (1) (Hull) (1674)**  
**Apprenticed:** To Elizabeth Atkinson (Sheppard 1912, 10)  
**Freedom:** 10.9.1674 (*ibid*)

- Married:** Anne Lund 12.11.1703 (possibly second wife) (HTPR)
- Children:** John (still born 1681) (SMPR)  
 Elizabeth (still born 1682) (*ibid*)  
 Jane (buried 31.2.1688) (HTPR)  
 Robert (buried 26.10.1691) (*ibid*)  
 David (buried 29.9.1695) (*ibid*)  
 William (buried December 1710) (*ibid*)  
 Henry (Freed by patrimony in 1700) (Watkins 1979, 112)  
 Christopher (freed by patrimony in 1724) (*ibid*)
- Died:** Buried 17.6.1708 (HTPR)
- Henry had at least seven apprentices, including two of his sons Henry and Christopher, Nathaniel Westall and Robert Burrill between 1675 and 1700. In 1686 he appears to have purchased a property in the Ropery, which he later mortgaged to Thomas Cooke and finally sold in 1704 (Watkins 1979, 112).
- HN Henry Norman (2) (Hull) (1700-1759)**  
**Freedom:** By patrimony 1700 (Watkins 1979, 113)  
 In 1726 he purchased a property which his father had previously sold in 1704, the Ropery and took out mortgages on this property in 1731, 1745, 1747, 1749 and 1759. His heirs disposed of the Ropery in 1761. Henry had a number of apprentices between 1702 and 1720. He voted in the 1724 and 1754 polls (Oswald 1975, 203).
- TN Thomas Nayler (Halifax) (1687)**  
 Apprentice to George Gill, referred to in his will (Oswald 1975, 201)
- WN William Nichols (Hull) (1731-1741)**  
**Apprenticed:** To Michael Westerdale (1) in 1731 (Watkins 1979, 113)  
**Freedom:** 1741 (*ibid*)
- CP Christopher Peters (Amsterdam) (17<sup>th</sup> Century)**  
**Born:** Ripon (Duco 1981, 335)
- GP George Parkin (Rotherham) (1787)**  
**Children:** John (apprenticed in 1787 to Benjamin Shemeld, Scissorsmith, at Attercliffe) (Crossley *in litt.* 6.1.1992).
- IP John Page (Hull) (1666-1707)**  
**Apprenticed:** To Elizabeth Atkinson in 1666 (Sheppard 1912, 10)  
**Freedom:** 8.10.1673 (*ibid*)  
**Died:** Buried 13.3.1707 (HTPR)  
 Watkins (1979, 113) notes a John Page working in Cambridge in 1683.
- IP I Powell (?unknown) (c1740-1780)**  
 Known from pipe stem fragments.
- MP Margaret Plaxton (York) (1777-1790)**  
**Married:** William Plaxton, pipe-maker (Andrews 191, 87)

- Children:** (See William Plaxton below)  
**Died:** of palsy 26.7.1790 (buried 28.7.1790) (*ibid*)  
 Continued to run the family business following her husband's death in 1777 (*ibid*).
- MP Matthew Powell (Wakefield) (1690-1701)**  
**Married:** Alice (Walker 1939, 478)  
**Died:** by 1701 when his widow appears in records relating to a dispute over the proceeds of a cottage in Stanley at Potovens (*ibid*). Matthews widow is also listed in the Manor Books in 1709 as holding a 'cottage and a garth of 26p' (Brears 1967, 42)  
 Appears in the Quarter Sessions Rolls in 1690 accused of 'neglecting to teach his apprentices the art of pipemaking at Potovens' (*ibid*). Bound by an indenture of May 1698 to 'teach Hester Beckett's .... children the trade of making tobacco pipes at Potovens' (Walker 1939, 478).
- RP Robert Page (Hull) (1685)**  
**Freedom:** 1685 (Watkins 1979, 113)
- TP Thomas Pashley (Doncaster) (1787)**  
 Appears in the Quarter Sessions Records for Tinsley, Doncaster (Oswald 1975, 201)
- TP Thomas Pate (Hull) (1654-1661)**  
**Apprenticed:** To Hugh Atkinson in 1654 (Sheppard 1912, 10)  
**Freedom:** 1661 (Oswald 1975, 203)
- WP William Palmer (Hull) (1713-1740)**  
**Apprenticed:** To Henry Norman (?2) in 1713 (*ibid*)  
**Freedom:** 1721 (*ibid*)  
**Married:** Dorothy (buried 14.6.1746) (HTPR)  
**Children:** Ann (buried 19.3.1742) (*ibid*)  
 Thomas (buried 22.9.1740) (*ibid*)  
 Voted in 1724 (Oswald 1975, 203).
- WP William Pattinson (Hull) (1700)**  
**Apprenticed:** To Thomas Cooke (*ibid*)  
**Freedom:** 1700 (*ibid*)
- WP William Plaxton (York) (1730-1777)**  
**Born:** son of Thomas Plaxton, baptised 3.9.1716 (Andrews 1991, 87)  
**Apprenticed:** To William Ramsden 1.1.1730 (*ibid*)  
**Freedom:** 1739 (Oswald 1975, 204)  
**Married:** Margaret (died of palsy 26.7.1790; buried 28.7.1790) (*ibid*)  
**Children:** Charles (baptised 4.10.1761; died aged 18 1.2.1782; buried 4.2.1782) (*ibid*)



- Died:** buried 17.8.1777 aged 61; death 'due to decay' (*ibid*)  
 William's son, Charles, died of exposure in a field near Deighton, having been refused accommodation. William's widow, Margaret, continued the business until at least 1782 and probably until her death in 1790 (*ibid*).
- WP William Potter (1)** (Sculcoates, a suburb to the north of Hull) (1709)  
**Children:** Unnamed son bound apprentice in 1709 (Watkins 1979, 113)
- WP William Potter (2)** (Hull) (1709-1757)  
**Apprenticed:** To John Goldwell in 1709 (*ibid*)  
**Freedom:** 1717 (Watkins 1979, 113)  
**Children:** William (buried May 1732) (HTPR)  
 Had at least two apprentices in 1722 and 1724. Voted in 1724, 1747 and 1754 (Oswald 1975, 203). Was witness for an apprentice in 1757 (Watkins 1979, 113)
- BR Brian Remy** (Hull) (1717)  
**Apprenticed:** To John Goldwell (1) in 1717 (*ibid*)
- HR H Robinson** (Yarm)  
 Pipe stem recovered from excavations in Hartlepool with a stamped mark reading H ROBINSON/YARM (Edwards 1985, Fig 8; Pcode 02024)
- IR John Read** (Hull) (1727-1754)  
**Apprenticed:** To Nicholas Tarboton (2) (*ibid*, 114)  
**Freedom:** 20.7.1727 (Sheppard 1912, 11)  
**Children:** Robert (died 1737) (SMPR)  
 Robert (buried 22.3.1745) (HTPR)  
 Voted in 1747 and 1754 (Oswald 1975, 203)
- IR John Robson** (Hull) (1713-1754)  
**Apprenticed:** To Benjamin Bell in 1713 (Watkins 1979, 114)  
**Freedom:** 1723 (*ibid*)  
 John had at least three apprentices between 1725 and 1751. Voted in 1724 and 1754 (Oswald 1975, 203)
- IR John Robinson** (Hull) (c1747)  
 Voted in 1747 (Oswald 1975, 203) but may be a misreading of John Robson (Watkins 1979, 114)
- IR James Rothere** (Halifax) (1748-1784)  
**Apprenticed:** To J Windle (Oswald 1975, 201)  
 Appears in Apprenticeship Rolls for 1748 (Brooks *in litt* 15.6.1998) and in the Quarter Sessions records (Oswald 1975, 201).
- IR Jeremiah Ryal** (Hull) (1796-1806)  
**Apprenticed:** To Thomas Westerdale in 1796 (Watkins 1979, 114)  
**Freedom:** 1806 (*ibid*)

- TR Thomas Rhodes (Sheffield) (1754)**  
Appears in the Quarter Sessions Records for 1754 at Brightside, Brierlow (Oswald 1975, 201)
- WR William Ramden (York) (1741)**  
**Freedom:** 1741 (Brooks *in litt* 15.6.1998)
- WR William Ramsden (York) (1727-1763)**  
**Freedom:** 1727 (Andrews 1991, 87)  
**Married:** (1) Susanna (buried 6.10.1744) (*ibid*)  
(2) Elizabeth (*ibid*, 88)  
**Children:** Susanna (baptised 16.11.1722; buried 12.2.1730) (*ibid*, 87)  
Mary (baptised 6.2.1725; buried 9.8.1738) (*ibid*)  
**Died:** Buried 22.8.1763 (*ibid*, 88)  
William appears in the will of Christopher Boyes, where he is referred to as 'a friend' (Andrews 1988, 92). Took two apprentices, the first William Plaxton in 1730 and the second Thomas Law in 1739. He did jury service in 1728 and 1745. On 20.8.1763 an inventory was made of William Ramsden's goods, which were valued at £18.10.0 (Andrews 1991, 87-88). There appears to be some confusion over the spelling, Lawrence (1979, 82) suggests that William Ramsden may be the same person as William Ramsdell who voted in 1741 (see William Ramsdell below).
- WR ?William Ramsdell (York) (1727-1741)**  
**Freedom:** 1727 (Oswald 1975, 204)  
Voted in 1741 (*ibid*). Oswald lists this maker as William Ramsdell or Ransdell (*ibid*) but the dates are the same as for William Ramsden (above) and it is possible that Ramsdell/Ransdell and Ramsden are the same man.
- WR William Ramsdill (Hull) (1708)**  
**Apprenticed:** To Robert Chapman in 1708 (Watkins 1979, 114)
- WR William Raven (Hull) (1705)**  
**Apprenticed:** To Thomas Cooke in 1705 (*ibid*)
- Simms and Bickerdyke (Leeds) (1798)**  
(Oswald 1975, 202)
- BS Benjamin Stevenson (Hull) (1718-1726)**  
**Apprenticed:** To Henry Norman (?) 1718 (Watkins 1979, 113)  
**Freedom:** 1726 (*ibid*)
- CS Christopher Smith (Rotherham) (1724-1742)**  
**Married:** Anne Sympson 22.10.1724 (Oswald 1975, 201; Andrews *in litt* 30.5.1998)  
**Children:** Sarah (baptised 5.1.1728) (*ibid*)  
Hannah (baptised 17.10.1742) (*ibid*)

- DS David Stather (Hull) (1702)**  
**Apprenticed:** To Henry Norman (2) in 1702 (Watkins 1979, 114)
- ES Edward Sargeant (Hull) (1740)**  
**Apprenticed:** To Robert Chapman (*ibid*)  
**Freedom:** 1740 (*ibid*)  
Edward was fined for not taking up his freedom in due time (*ibid*)
- GS George Shaftoe (York) (1718)**  
?Token; information from E J Berry but not in Berry 1982 (Oswald 1975, 204)
- GS George Sickling (York) (1797)**  
**Apprenticed:** To Mark Hesp 13.5.1797 (Andrews 1987d, 16)
- HS Henry Stanley (Beverley) (1662-1670)**  
**Freedom:** 1662/3 (Watkins 1979, 114)  
Henry is referred to in the Beverley Borough Records for 1669/70 (*ibid*)
- IS Jonathan Scorer (Scorah) (1) (Rawmarsh) (1687-1719)**  
**Married:** Elizabeth (buried 16.1.1696) (SMRPR)  
**Children:** Thomas and Margaret (twins - baptised 14.4.1687) (*ibid*)  
Richard (baptised 19.9.1689) (*ibid*)  
**Buried:** 11.3.1719 (SMRPR)  
The burial record in 1719 is the first time that Jonathan is referred to as a pipemaker.
- IS Jonathan Scorah (2) (Rawmarsh) (1764-1821)**  
**Married:** Sarah Beal (Banns 13<sup>th</sup>, 20<sup>th</sup> & 27<sup>th</sup> May 1758; marriage 5.6.1759) (SMRPR)  
**Children:** Richard (baptised 26.7.1760) (*ibid*)  
Mary (baptised 31.1.1762; buried 12.2.1769) (*ibid*)  
Jonathan (baptised 24.4.1764) (*ibid*)  
William (baptised 20.5.1766) (*ibid*)  
Elizabeth (baptised 10.7.1768) (IGI)  
Ann (baptised 25.11.1770) (*ibid*)  
John (baptised 1.11.1773) (SMRPR)  
Matthias (baptised 26.1.1776) (IGI)  
Appears in the Marques of Rockingham papers; Doncaster Quarter Sessions and West Riding Registry of Deeds between 1767 and 1821 (Lawrence 1973, 193). Enclosure award of 1781 states that plot 453 (3a 1r 38p with an annual payment for tithes of 3s 6d) is owned by Thomas Oates, but occupied by Jonathan Scorah (Munford *in litt* 15.10.2002).
- IS John Scott (Hull) (1788)**  
**Children:** Joseph (Freed 1796) (Watkins 1979, 114)
- IS Joseph Scott (Hull) (1788-1851)**  
**Born:** Son of John Scott (*ibid*)

**Apprenticed:** To Thomas Westerdale in 1788 (*ibid*)  
**Freedom:** 1796 (*ibid*)  
**Married:** ?Martha (Born in Horncastle 1785) (*ibid*, 115)  
**Children:** Joseph Henderson Scott 1816 (Freed as a pipe-maker 1839) (*ibid*, 114)  
**Died:** By 1851 (*ibid*. 115)

Joseph had at least four apprentices between 1805 and 1815 and was working at least three different locations in Hull between 1810 and 1839 (Dagger Lane 1810-26, Posternage 1831 and Stewart's Yard 1834-9)(*ibid*, 114-115)

**IS John Shaftoe (1) (York) (1712-1739)**

**Freedom:** 1712 on payment of £1 (Oswald 1975, 204; Andrews 1991, 90)  
**Married:** Susannah Hanworth 28.8.1668 (Andrews *in litt* 30.5.1998 and 1992, 6)  
**Children:** John (freed 1733) (Lawrence 1979, 82)  
Mary (baptised 21.11.1712) (*ibid*)  
Frances (baptised 27.4.1715) (*ibid*)  
William (buried 4.12.1715) (*ibid*) Oswald give burial date of 1716 (1975, 204)  
Abraham (baptised 14.1.1717; buried 9.6.1717) (Lawrence 1979, 82)  
**Died:** Buried 17.2.1739 (*ibid*)

Andrews (1991, 90) notes that John Shaftoe appeared before the courts on 17.1.1719 and was ordered 'to keep the peace towards William Hutchinson and the civil people'. On 7.10.1726 and again on 13.1.1727 he was bound over on £20, with a Richardson Dent, 'to answer a charge of slander against a Walter Wernnick'. John appeared in court, yet again, on 22.1.1730 and 30.4.1730 this time to give evidence against a Jane Scott.

**IS John Shaftoe (2) (York) (1733-1759)**

**Born:** c1707, son of John Shaftoe, pipe-maker (Andrews 1992, 6)  
**Freedom:** 1733 (Oswald 1975, 204)  
**Married:** Soon after his release from his apprenticeship c1728. (Andrews 1992, 6).  
**Children:** Un-named child baptised in Hull (*ibid*)  
Un-named child baptised in Gainsborough 1729 (*ibid*)  
Un-named child baptised in Gainsborough 1731 (*ibid*)  
Elizabeth (baptised in York 6.3.1732) (*ibid*)  
Mary (baptised 28.5.1736; buried 1745) (Andrews 1991, 90)  
Beatrice (baptised 8.6.1740; buried 19.8.1741) (*ibid*)  
John (baptised 1.7.1742) (*ibid*)  
Beatrice (baptised 3.7.1745; buried 6.5.1746) (*ibid*)  
Un-named child born in York (Andrews 1992, 6)  
**Died:** Buried 9.11.1759 (Andrews 1991, 90)

John's father sent him to Hull, where he had been baptised in 1707. Andrews suggests this may be due to his father's second marriage (1992, 6). John served an apprenticeship with John Goldwell commencing in 1721

(Andrews 1992, 6). On his return to York he claimed his freedom *per patres*, c1733 (Andrews 1991, 90). John appeared in court on a number of occasions, the first 14.7.1738 to give evidence against a Dority Noble and William Tranby who were accused of assaulting a Matthias Sutton and 'unlawfully taking his ox'. The second occasion was on 8.10.1756 when he appeared before the courts on charges of 'trespass and taking two horses to the common pound' (*ibid*). In 1757, when he is listed as a labourer, as a result of drunk and disorderly conduct in court where he abused a witness waiting to give evidence against him, he 'was ordered to the House of Correction until sureties were found for his good behaviour' (Andrews 1992, 6).

- IS John Shafton** (?Rawmarsh) (1731)  
**Married:** Mary (buried 27.4.1731) (SMRPR)
- IS John Silkwood** (Hull) (1723-1754)  
**Apprenticed:** To Robert Burrill (1) (Watkins 1979, 115)  
**Freedom:** 1723 (*ibid*)  
**Children:** Priscilla (buried 8.12.1741) (HTPR)  
                  Unnamed son (freed 1768) (Watkins 1979, 115)  
Voted in 1724 and 1754 (Oswald 1975, 203).
- IS John Storey** (York) (1713-1715)  
**Freedom:** 16.9.1713 on payment of £1 (Andrews 1991, 91)  
John was bound apprentice to a Richard Shafton, presumably Richard Shaftoe (2). He did jury service 5.10.1715 (*ibid*).
- MS Marmaduke Scutt** (Hull) (c1774)  
Voted in the polls in Hull in 1774 (Sheppard 1912, 16).
- MS Mathias Scorah** (Rawmarsh) (1800-1818)  
**Born:** Son of Jonathon Scorah (baptised 26.1.1776) (IGI)  
**Married:** Mary Brameld (Bramald) daughter of John Brameld (SMRPR)  
**Children:** Elizabeth (baptised 21.9.1800) (*ibid*)  
                  Ann (baptised 24.4.1803) (*ibid*)  
                  Mary (baptised 24.3.1805) (*ibid*)  
                  Hannah (baptised 14.5.1809) (*ibid*)  
                  Harriet (baptised 18.8.1811) (*ibid*)  
                  Matthias (born 31.5.1813; baptised 22.8.1813) (*ibid*)  
                  Sarah (born 2.1.1814; baptised 12.3.1814) (*ibid*)  
                  Charlotte (born 1.11.1816; baptised 24.11.1816) (*ibid*)  
                  Dinah (baptised 30.7.1818) (*ibid*)
- RS Richard Scorah** (1) (Rawmarsh) (1718-1767)  
**Married:** Mary Calver 23.10.1718 (buried 9.3.1767)(IGI; SMRPR)  
**Children:** Elizabeth (baptised 31.5.1720) (Andrews *in litt* 30.5.1998)  
                  Mary (baptised 18.3.1721) (*ibid*)  
                  Jonathan (baptised 16.10.1736) (*ibid*)

A Richard Scorer son of Jonathan Scorer was baptised at Rawmarsh on September 19<sup>th</sup> 1689 and it is possible that this is the same Richard who is recorded as a pipemaker when he married in 1718 (SMRPR). Took William Finch apprentice in 1748 (Oswald 1975, 201; Andrews *in litt* 30.5.1998). Richard is presumed to have worked until at least 1767 as Mary was described as his wife rather than his widow when she was buried (SMRPR).

**RS Richard Scorah (2) (Rawmarsh) (1783-1793)**

**Married:** Elizabeth Capper (daughter of John Capper) 5.10.1783 (SMRPR)

**Children:** George (baptised 20.5.1784; buried 18.10.1785) (*ibid*)  
Mary (baptised 12.2.1786) (*ibid*)  
Ann (baptised 8.4.1787) (*ibid*)  
Sarah (baptised 2.4.1793) (*ibid*)

**RS Richard Shaftoe (1) (York) (1675-1706)**

**Freedom:** purchased in 1675 (Andrews 1991, 90); Oswald (1975, 204) gives the date as 1673

**Married:** (1) Sarah Hanworth 20.6.1669 (buried 11.3.1691) (Andrews 1991, 90)  
(2) Eilis (?Alice/Elizabeth) Smith 24.7.1692 (*Andrews in litt* 30.5.1998)(buried 5.8.1698) (Andrews 1991, 90)

**Children:** John (baptised 29.11.1669) (*ibid*)  
Elizabeth (baptised 29.11.1671; buried 7.12.1672) (*ibid*)  
Joseph (baptised 9.9.1673) (*Andrews in litt* 30.5.1998)  
Elizabeth (baptised 24.9.1676) (*ibid*)  
Edward (baptised 21.4.1678; buried 27.12.1678) (Lawrence 1979, 82; Andrews 1991, 90)  
James (baptised 24.6.1683; buried 1.7.1683) (*ibid*)  
Sarah (born 1684; later married William Spacey, pipe-maker) (*ibid*)  
Richard (baptised 30.1.1686) (*ibid*)  
James (baptised 12.9.1689; buried 15.9.1689) (*ibid*)  
Grace (baptised 11.7.1693) (*ibid*)  
Ann (baptised 26.10.1695; buried 5.8.1698) (*ibid*)  
George (baptised 27.6.1697; freed 1718) (Lawrence 1979, 82; Andrews 1990, 90)

**Died:** Buried 7.3.1706 (*ibid*)

Richard first came to York in the 1660s and that he possibly originated from Leeds. He took a William Farnhill apprentice on 1.7.1689 and a girl by the name of Katherine Dawson apprentice on 29.5.1696. Andrews suggests that it would be unusual if she had been apprenticed as a pipe-maker and suggests that a domestic role was more likely. Richard's will is dated 13.5.1705 and in this he lists his children Joseph, Elizabeth, William, Richard, George, Grace and Sarah as his beneficiaries, but it is his son Richard to whom he leaves his 'worke tooles belonging to the pipe making traide in my backe shopp' (*ibid*).

**RS Richard Shaftoe (2) (York) (1706-1725)**

- Born:** Son of Richard Shaftoe (1), baptised 30.1.1686 (Andrews 1991, 91)
- Children:** Elizabeth (baptised 24.10.1725) (*ibid*)  
 Inherited his father's tools and workshop 7.3.1706 (*ibid*)
- RS Robert Stubbing (Rotherham) (1691)**  
**Children:** Richard (apprenticed to Mark Trickett, cutler, 1691)  
 (Crossley *in litt* 6.1.1992)
- SS Samuel Searge (Hull) (1706-1714)**  
**Apprenticed:** To Henry Norman (2) in 1706 (Watkins 1979, 115)  
**Freedom:** 1714 (*ibid*)
- SS Samuel Silkwood (Hull) (1768-1784)**  
**Born:** son of John Silkwood (Watkins 1979, 115)  
**Freedom:** by patrimony 1768 (*ibid*)  
 Voted in the polls in Hull in 1774 (Sheppard 1912, 16). Took an apprentice in 1784 (Watkins 1979, 115).
- TS Thomas Silborne (Hull) (1694-1702)**  
**Apprenticed:** To John Leconby in 1694 (Watkins 1979, 115)  
**Freedom:** 1702 (*ibid*)
- TS Tobias Skelton (Hull) (1682)**  
**Apprenticed:** To Henry Norman (1) in 1682 (*ibid*)
- WS William Shaftoe (York) (1712)**  
**Freedom:** 1712 (Oswald 1975, 204)
- WS William Skinner (Hull) (1795)**  
**Apprenticed:** To Thomas Westerdale in 1795 (*ibid*)
- WS William Smith (Hull) (1712)**  
**Apprenticed:** To Thomas Cooke in 1712 (Watkins 1979, 115)
- WS William Spacey (York) (1706-1710)**  
**Born:** son of John Spacey, bodice maker (Andrews 1991, 91)  
**Freedom:** by patrimony 1706 (Oswald 1975, 204; Andrews 1991, 19)  
**Married:** Sarah Shaftoe (daughter of Richard Shaftoe, pipe-maker)  
 16.2.1706 (*ibid*)  
**Children:** Richard (Baptised 10.12.1707 (*ibid*); freed 1728 (Lawrence 1979, 82))  
 Jane (baptised 28.11.1708) (*ibid*)  
**Died:** Buried 9.4.1710 (*ibid*)
- BT Benjamin Taylor (Hull) (1727-1768)**  
**Apprenticed:** To Robert Chapman in 1711 (Watkins 1979, 116)  
**Freedom:** 20.7.1727 (Sheppard 1912, 8)

**Children:** Joseph (freed in 1768) (Watkins 1979, 116)

**IT John Taylor (Hull) (1720)**

**Apprenticed:** To Henry Norman (2) in 1720 (*ibid*)

**IT Joseph Taylor (Hull) (1768)**

**Born:** Son of Benjamin Taylor (*ibid*)

**Apprenticed:** To his father (*ibid*)

**Freedom:** By Patrimony in 1768 (*ibid*)

**NT Nicholas Tarboton (1) (Sculcoates, a suburb north of Hull) (1682-1698)**

**Freedom:** of Selby before 1682 (Oswald 1975, 203); of Hull 24.1.1690 (Watkins 1979, 116)

**Children:** Thomas (freed 1709) (*ibid*)

Nicholas (2) (Freed 1720) (*ibid*)

William (Freed 1720) (*ibid*)

**Died:** Buried 20.7.1698 (HTPR)

Nicholas Tarboton served an apprenticeship in Selby and came to Hull in 1682 or 1683. He wanted to carry on his business in Hull but was prevented from doing so because he was not a freeman. An entry in the Corporation Bench Book for 23.7.1683 (Sheppard 1912, 12) states that 'this Bench refused to make him [Nicholas Tarboton] a Burgesse, and ordered him to remove himself and family from hence, being informed that there were more Burgesses already in that trade than finds employment'. Nicholas went as far as Sulcoates where he established himself as a pipe-maker. He arranged to bind himself as apprentice to Francis Wood for seven years. He took up his freedom on 24<sup>th</sup> January 1690 still being described as '*Nicholas Tarboton de Sculcoates*'. It would appear that he carried on business at Sculcoates whilst nominally apprenticed to Francis Wood (*ibid*, 8). Paid poor rates in Humber Ward 1695. Paid 1/- which was a very large amount. (HTPR)

**NT Nicholas Tarboton (2) (Hull) (1720-1747)**

**Born:** In Sulcoates 1689, son of Nicholas Tarboton (1) (Watkins 1979, 116)

**Freedom:** By patrimony in 1720 (*ibid*)

**Children:** Anne (buried April 1718) (HTPR)

Had at least two apprentices one bound in 1723, one freed in 1727. Voted in 1724 and 1747 (Oswald 1975, 203)

**RT Richard Taite (Selby) (1679-1680)**

Oswald (1975, 202) lists a Richard Taite who was named in a sale of land in 1679/80.

**RT Richard Thompson (York) (1796)**

**Apprenticed:** To Mark Hesp 31.5.1796 (Andrews 1987d, 18)

**RT Richard Tidham/Tidfall (Hull) (1656)**

**Married:** Mary Bell, Widow, 1.11. 1656 (HTPR)



- RT Ralph Tirry (York) (1749)**  
Reference to Ralph Tirry made in an edition of the *York Courant* dated 5.9.1749. 'Whereas William Plaxton, pipe-maker, left his shop in Spurriergate, York, sometimes since. This is to acquaint all gentlemen and others, that they may be furnish'd with long and short Pipes, made in the same Moulds, and by the same Hands that made them before, and may be furnished by Wholesale or Retale at the same Prices as before' by their humble servant Ralph Tirry' (Andrews 1991, 92)
- RT Richard Tock/Tuck (1) (Hull) (1724-1746)**  
**Children:** Richard (Freed 1739) (Watkins 1979, 116)  
Robert (Freed 1746) (*ibid*)  
Voted in 1724 (Oswald 1975, 203). Appears in the Poor Rate returns of 1735. (Watkins 1979, 116)
- RT Richard Tock (2) (Hull) (1739)**  
**Freedom:** By patrimony 1739 (*ibid*)
- RT Robert Tock (Hull) (1746-1754)**  
**Freedom:** By patrimony 1746 (*ibid*)  
Voted in 1724 and 1754 (*ibid*)
- TT Thomas Tarboton (1) (Hull) (1648)**  
**Married:** Mary (buried 14.4.1648) (HTPR)
- TT Thomas Tarboton (2) (Hull) (1709-1754)**  
**Born:** Son of Nicholas Tarboton (1) (Watkins 1979, 116)  
**Freedom:** By patrimony 1709 (*ibid*)  
Voted in the 1724 and 1754 (Oswald 1975, 202)
- TT Thomas Thompson (Rotherham) (1723)**  
**Married:** Esther Wharton 23.5.1723 (Andrews *in litt* 30.5.1998)
- TT Thomas Thompson (Hull) (1774)**  
**Apprenticed:** To William Westerdale 1767 (Watkins 1979, 116)  
Voted in the 1774 polls in Hull (Sheppard 1912, 16).
- TT Thomas Thornaby (Hull) (1725)**  
**Apprenticed:** To Robert Bell in 1717 (Watkins 1979, 116)  
**Freedom:** 1725 (*ibid*)
- TT Thomas Turner (Leeds) (1744-1749)**  
**Apprenticed:** To Joseph Windle of Leeds 1744-1752 (Brooks 1989,3)  
**Married:** Susanna (*ibid*)
- WT William Tarboton (Hull) (1720-1724)**  
**Born:** Son of Nicholas Tarboton (1) (Watkins 1979, 116)

**Freedom:** Admitted freeman of Hull by patrimony 1720 (*ibid*)  
Voted in Hull, where he took his freedom, in 1724 but appears to have moved to Grimsby as he took an apprentice there in the same year (*ibid*, 117)

**WT William Taylor (Hull) (1657-1666)**

**Apprenticed:** To Thomas Kilham in 1657 (Sheppard 1912, 11)

**Freedom:** 15.12.1664 (*ibid*, 7)

Brooks (*in litt* 15.6.1998) gives a date of 1666 for a William Taylor but does not state from which source she obtained this date.

**DU David Ufhay (Hull) (1685)**

**Apprenticed:** To Robert Burrill (1) in 1685 (Watkins 1979, 117)

**WV William Vennis (Hull) (1723)**

**Apprenticed:** To Nicholas Tarboton (2) in 1723 (*ibid*)

**EW Edward Wright (York) (1684)**

**Freedom:** 1684 (Oswald 1975, 204)

**FW Francis Wilkinson (1) (York) (1693-1731)**

**Freedom:** 1690 (*ibid*)

**Children:** Mary (baptised 31.8.1690) (Andrews 1991, 94)

Francis (baptised 8.8.1692; buried 23.1.1693) (*ibid*)

Francis (freed in 1721 as a pipe-maker) (Lawrence 1979, 82; Andrews 1991, 94)

**Died:** Buried 3.11.1731 (*ibid*)

Francis is first recorded as a pipe-maker in 1693 when his son, also called Francis, was buried. The burial entry for 3.11.1731 could refer to either Francis Wilkinson (1) or (2) (*ibid*).

**FW Francis Wilkinson (2) (York) (1721)**

**Born:** son of Francis Wilkinson (1) (Lawrence 1979, 82)

**Freedom:** by patrimony 1721 as a pipe-maker (Oswald 1975, 204; Andrews 1991, 94)

**FW Francis Wilday (York) (1643)**

**Born:** Son of Simon Wilday (*ibid*)

**Apprenticed:** To Gabriel Westaby of York in December 1643 (Andrews 1987b, 2)

**FW Francis Wood (Hull) (1675-1743)**

**Apprenticed:** To John Chapman in 1675 (Watkins 1979, 117)

**Freedom:** 30.9.1682 (Sheppard 1912, 11)

**Children:** Richard (buried 26.5.1687) (HTPR)

**Died:** Buried 17.10.1743 (*ibid*)

Within the first year of his freedom took Nicholas Tarboton (1) apprentice. In 1681 took William Best apprentice (Sheppard 1912, 11). Also appears to

have taken apprentices in 1682-1689/990, and 1686-1698 (Watkins 1979, 117)

**GW Gabriel Westoby (York) (1619-1643)**

**Freedom:** 1635 as a trunk maker by purchase (Andrews 1991, 94)  
1646 as a pipe-maker (Oswald 1975, 204)

**Children:** John (Buried 19.7.1619) (Andrews 1987b, 2)  
Elizabeth (baptised 19.8.1621) (Andrews 1991, 94)

Gabriel took four apprentices, two in 1633 as trunk makers – Mark Burn of Doncaster and Robert Beckwith; and two in 1643 as apprentice trunk and tobacco pipe-makers - Francis Balden and Francis Wilday (*ibid*).

**GW George Wilson (York) (1716)**

**Died:** Buried 14.6.1716 (Lawrence 1979, 82; Andrews 1991, 95)  
Andrews (1991, 95) notes that George was almost certainly a journeyman.

**HW Henry Wilkins (Amsterdam) (1640-c1669)**

**Born:** In York 1614 (Duco 1981, 400)

**Married:** (1) Sara Thomasdr. 5.5.1640 (originally from London, widow of a pipe-maker originally from Kent by the name of Tomas Thomasz.); died 1649 (*ibid*)  
(2) Eva Willems of Amsterdam 11.9.1649 (*ibid*)

**Children:** Rogier (born 1641) (later became a pipe-maker) (*ibid*)  
Elizabeth (Lijsbeth) (born 1645) (*ibid*)  
Edward (Evert) (born c1649) (*ibid*)

**Died:** By 1669 (*ibid*)

At the time of Sara's death in 1649 the three children, Rogier aged 8, Elizabeth aged 4 and Edward aged 3 months, 'brought to the orphan's court' (*ibid*).

**IW Joseph Walton (Hull) (?1730/2-1754)**

**Apprenticed:** To John Goldwell (1) in 1730 according to Watkins (1979, 117) and in 1732 according to Oswald (1975, 203)

**Freedom:** 1738 (*ibid*)

Voted in 1747 and 1754 (*ibid*), but according to Oswald (1975, 203) this information applies to Joseph Watson (see below).

**IW James Watson (Rotherham) (prior to 1806)**

**Married:** Elizabeth (RArch)

**Children:** George (*ibid*)

Indenture dated 30.6.1806 regarding the mortgage of '... piece or parcel of ground and the messuage tenement or dwelling house, burning house and stove or drying house thereon erected and built situate and being at the bottom of a certain street called Westgate in Rotherham, aforesaid as the same premises are now in the possession or occupation of the said James Watson...' to Nathaniel Cosins for the sum of £53. Further indenture of 13.9.1824 refers to this property being in a 'runiated state and untenanted' (*ibid*)

- IW John Watson (Halifax) (1664)**  
 Appears in Wakefield Court Rolls for 1664 (Brooks *in litt* 15.6.1998). Refers to a 'pipe furnace' causing a nuisance. Watson objected to the charge but was still found guilty and fined £10. Watson also presented at Brighthouse '[he] shall not at any time hereafter burne any pipes in any furnace now builded and made upon the backside of his dwellinge house in Halifax whereby the people passing alonge the streets may be annoyed with the smoke thereof, upon payne to forfeit for every time so doinge the summe of Twenty shillings' (Fraser *in litt* 21.8.2000).
- IW John Watson (Hull) (1680)**  
 Brooks (*in litt* 15.6.1998) gives a date of 1680 for a John Watson but does not state from which source she obtained this date.
- IW ?Joseph Watson (Hull) (1747-1754)**  
 Voted in elections (Oswald 1975, 203). Possible confusion with Joseph Walton (above).
- IW Jacob West (York) (1721)**  
**Freedom:** 1721 (*ibid*)
- IW John West (York) (1710-1721)**  
**Children:** James (baptised 11.8.1695; freed 1721 as a mariner) (Andrews 1991, 94)  
 ?Jonathon (freed 1710 as a linen weaver) (Lawrence 1979, 202; Andrews 1980s, 32)  
 John is described as a linen weaver at the time of his son, James, baptism in 1695 but is described as a pipe-maker when his son, James, obtains his freedom in 1721 (*ibid*)
- IW John Whitekerr (York) (1677-1681/2)**  
**Married:** Sarah (daughter of Abraham Boyes) (Andrews 1991, 94)  
**Children:** 'chrisom child' (born and buried in York 27.5.1677) (*ibid*)  
 Abraham (born 8.9.1678) (*ibid*)  
 Frances (buried 15.2.1682, daughter of widow Sarah Whitekerr) (*ibid*)  
**Died:** 1681 (within nine months prior to birth of Frances) (*ibid*)  
 Andrews (1987, 5) notes that 'no pipes of his [John Whitekerr] have been found' and therefore suggests that he may have been working as a journeyman for Abraham Boyes. Andrews also suggests that John Whitekerr is the same person as John Whiteacre from Chilcompton in Somerset who was apprenticed to Flower Hunt of Bristol in 1670, but later moved to York (*ibid*). John Whitekerr appears to have died between May 1681 and February 1682 (Andrews 1991, 94).
- IW John Wilde (Rotherham) (1722-1750)**  
**Married:** Anne Littleforth 9.8.1722 (Oswald 1975, 202; Andrews *in litt* 30.5.1998)

**Children:** Sally (baptised 23.9.1750) (*ibid*)

**IW John Windle (Halifax) (1763)**

Took out a fire insurance policy with Sun Assurance on 30.6.1763 where his details appear as 'John Windle of Halifax in the County of York, Pipemaker, on his now dwelling house situated in Gibbet Lane in Halifax aforesaid brick and stone and slated £400' (Fire insurance policy with Sun Assurance No. 200247, Vol 144)

**IW Joseph Windle (Halifax) (1744-1775)**

**Died:** 1775 (Oswald 1975, 202)

Appears in the Apprenticeship Rolls for 1744, 1748 and 1749 (Brooks *in litt* 15.6.1998). 'The most ingenious tobacco pipe-maker in England' (Thoresby Soc. Vols 38-39).

**IW I (J) Windle (Leeds) (c1780-1820)**

Lettering I WINDLE IN LEEDS appears on three bowls found in Coventry and dated on typological grounds to 1780-1820 (Muldoon 1979, 277)

**IW James Woddell (Hull) (1772)**

**Apprenticed:** To William Westerdale in 1772 (Watkins 1979, 117)

**IW Joseph (John) Wood (Halifax) (1687)**

**Apprenticed:** To George Gill (Oswald 1975, 202)

Referred to in George Gill's will (*ibid*)

**IW John Wright (York) (1663-1697)**

**Apprenticed:** To Abraham Boyes (Andrews 1991, 95)

**Freedom:** 1663 on payment of £1 as a pipe-maker (*ibid*)

**Children:** Peter (baptised 8.7.1639) (*ibid*)

John (freed 1697) (Oswald 1975, 204)

**MW Michael Westerdale (1) (Hull) (1714-1757)**

**Apprenticed:** To Benjamin Bell in 1714 (Watkins 1979, 117)

**Freedom:** 1721 (*ibid*)

**Children:** Isabel (buried August 1727) (HTPR)

**Died:** Buried 22.4.1757 (*ibid*)

Michael had at least five apprentices between 1732 and 1765. Voted in 1724 and 1747 (Oswald 1975, 203)

**MW Michael Woodward (Easingwold) (c1668)**

Known from a trade token of 1668 showing a man smoking but may refer to a dealer in pipes or tobacco rather than a pipe-maker (Oswald 1975, 202; Berry 1982, 370)

**MW Matthew Wright (Hull) (1717)**

**Apprenticed:** To Thomas Cooke in 1717 (Watkins 1979, 117)

- NW Nathaniel Westall (Hull) (1695)**  
**Apprenticed:** To John Leconby in 1679 (Watkins 1979, 117)  
**Freedom:** 1695 (Oswald 1975, 203)  
 Although Nathaniel was bound apprentice to John Leaconby he appears to have taken his freedom from Henry Norman (1) (*ibid*). Brooks (*in litt* 15.6.1989) gives a date of 1694 for Nathaniel Westall but does not state from which sources she obtained this date.
- NW Nicholas Westall (Hull) (1688)**  
 Listed in an unpublished manuscript post 1964 (Place nd) although no sources are given.
- RW Roger Wilkins (Amsterdam) (1633-1649)**  
**Born:** In York c1607 (Duco 1981, 400)  
**Married:** (1) Dorothea Willems from Den Briel in 1633 (*ibid*)  
 (2) Elsie Green from England in July 1649 (*ibid*)  
**Children:** Joannes (later called Jan; baptised 2.1.1639; became a pipe-maker) (*ibid*)  
 7 other children from both marriages (*ibid*)  
 Possibly a brother of Henry Wilkins. At the time of his first marriage to Dorothea Willems, Roger is described as a hairdresser. A Rogier Wilkins is referred to in the Orphanage register for 15.6.1649 when he is described as a pipe-maker. A uncle called Thomas Bird is also referred to in this document and appears to have been related to Rogers wife and also to the pipe-maker Edward Bird. At the time of his second marriage to Elsie Green of England, he signed the document with his monogram RW as it appears on his pipes. (*ibid*)
- SW Samuel Welch (Hull) (1798)**  
**Apprenticed:** To Michael Westerdale (2) in 1798 (Watkins 1979, 117)
- SW S W Wilson, Clay Smoking Pipe Manufacturer (Leeds) (1729-1943)**  
 A catalogue exists for S W Wilson, clay smoking pipe manufacturer in Crosland Yard, Pontefract Lane, Leeds and states that the 'Old Firm' was established in 1729. Correspondence survive in the archives of York Castle Museum suggesting that the firm ceased production around 1943 when Mr Wilson offered a work bench and tools to the Museum. Mr Wilson states in his letter dated 15<sup>th</sup> November 1943 'some time ago you asked me to supply you with a bench and machine for making clay pipes. I beg to inform you that I can now let you have same as I am closing down my pipe works. If you still want this please let me know when you can call for same, as I want to leave the works by the end of November.'
- TW Thomas Watson (Halifax) (1687)**  
**Apprenticed:** To George Gill (Oswald 1975, 202)  
 Referred to in George Gill's will (*ibid*).
- TW Thomas Watson (York) (1737-1750)**  
**Apprenticed:** To Christopher Homes 5.11.1737 (Andrews 1988, 92)

**Married:** Jane Jewitt 13.9.1747 (Andrews 1991, 93)

**Children:** Barbara (baptised 23.6.1748) (*ibid*)

John (born 22.10.1750; baptised 30.10.1750) (*ibid*)

Andrews (1988, 92) notes that a Thomas Watson of the same parish (St. Michael-le-Belfry) can be traced from 1750-1776 as an innholder. Andrews suggests this is the same man and expresses doubt that Watson continued to make pipes after 1750 'unless... as a sideline to his occupation as an innkeeper'.

**TW Thomas Westerdale (Hull) (1790-1806)**

Appears in the 1790 directory as a pipe-maker in Finkle Street (Oswald (1975, 203) says 1791). Took a number of apprentices including Joseph Scott freed in 1796, William Skinner bound in 1795, Robert Gowland bound in 1795 and an un-named apprentice from 1796-1806 (Watkins 1979, 117-118).

**TW Thomas Wild (?1) (Rotherham) (1716)**

**Children:** Robert (apprenticed to William Smith, file smith at Attercliffe, 1716 for 9-10 years) (Crossley *in litt* 6.1.1992)

**TW Thomas Wild (?2) (Rotherham) (1718)**

**Married:** Elizabeth Wainwright 14.4.1718 (Oswald 1975, 202; Andrews *in litt* 30.5.1998)

**TW Thomas Wild (?3) (Rotherham) (1777)**

Appears in the Quarter Sessions Records for Sheffield 1777 (Oswald 1975, 202)

**TW Thomas Wright (York) (1684)**

**Freedom:** 1663 (as a brick layer) (Andrews 1991, 95)

**Children:** Edward (freed 1684) (*ibid*)

Thomas listed as a pipe-maker in 1684 on the freedom of his son, Edward (i.e. not himself freed in 1684 as per Lawrence 1979, 82). Thomas is possibly the brother of John Wright, also freed in 1663 as a tobacco pipe-maker (Andrews 1991, 95).

**WW William Wainwright (1) (Rotherham) (1709)**

**Children:** William (apprenticed to Samuel Hartley, cutler, 1709) (Crossley *in litt* 6.1.1992)

**WW William Wainwright (2) (Rotherham) (1722)**

**Married:** Charlotte Steel 10.4.1722 (Oswald 1975, 202; Andrews *in litt* 30.5.1998)

**WW William Wainwright (3) (Rotherham) (1781)**

**Children:** Thomas (apprenticed to John Gill, Razor grinder, in 1781 for 7 years) (Crossley *in litt*. 6.1.1992).

**WW W Watson (Rotherham) (1775-1800)**

No documentary evidence. Pipe bowl bearing the moulded lettering W WATSON ROTHERHAM in relief around the rim found in association with the Lumley kiln in Doncaster.

- WW William Westerdale (Hull) (1754-1774)**  
Voted in 1754 and 1774 (Oswald 1975, 203) and took at least three apprentices between 1764 and 1774 (Watkins 1979, 118)
- WW William White (Hull) (1751)**  
**Born:** Son of William White of Grimsby  
**Apprenticed:** To John Robson in 1751 (*ibid*)
- WW William Wild (Rotherham) (1764-1774)**  
**Married:** Sarah Marsden 5.11.1764 (Andrews *in litt* 18.6.1998)  
Mentioned in Guest's History in 1774 (Oswald 1979, 202).
- WW William Windle (Halifax) (1725)**  
**Married:** Ann Sharp, of Halifax Sept 1725 (HPR ref. D53/1/9)
- ?? Un-named maker (Halifax) (c1706)**  
(Goodchild *in litt* 23.11.2000)
- ?? Un-named maker (Halifax) (c1727/28)**  
(*ibid*)
- ?? Un-named maker (Bradford) (c1718)**  
(*ibid*)
- ?? ?Un-named maker (Ecclesfield) (c1687)**  
Possible pipe-maker. Appears in the Quarter Sessions Rolls for the West Riding and is listed as a 'piper' (*ibid*)



## **Appendix 2: Transcriptions of selected apprenticeship indentures, wills, inventories and quarter sessions documents.**

This appendix contains transcriptions of the following documents relating to Yorkshire clay tobacco pipe-makers and to the growing of tobacco in Yorkshire. The documents have been transcribed by the author unless otherwise stated. All spellings are as the original documents.

- Will of Henry Ludlam of Rotherham, 1669 (Borthwick Institute, York Vol. 50 Fol. 192)
- Order to suppress the growing of tobacco in Yorkshire, 1677. Wakefield Record Office, Ref. QS1/16/4/6/3
- Will of William Lee of Rotherham, 1680 (Borthwick Institute, York Vol. 59, Fol. 19)
- Will of Richard Shafton (Shaftoe) of York, 1705 (Transcribed by John Andrews)
- Inventory of William Spacie of York, 1710 (Transcribed by John Andrews)
- Will of Christopher Boyes of York, 1725 (Transcribed by John Andrews)
- Inventory of Christopher Boyes of York, 1725 (Transcribed by John Andrews)
- Petition regarding Mary, wife of John Horsfield of Bradford, pipemaker, Bradford July 1728. (Wakefield Record Office, Ref. QS1/67/6)
- Sentencing of Mary Horsfield, Bradford 17<sup>th</sup> July 1728) (Order Book 1728-33 – Wakefield Record Office, Ref. QS10/16)
- Will of William Ramsden of York, 1769 (Transcribed by John Andrews)
- Apprenticeship indenture of Joseph Scott to Thomas Westerdell, 1788 (Transcribed by Peter Rayner)

### **Will of Henry Ludlam, of Rotherham 1669**

In the name of God Amen. The sixth day of Aprill in the yeare of our Lord one thousand six hundred sixtie nine I Henry Ludlam of Rotherham in the County of York Pipemaker sick in body but in perfect memory blessed be God for it, doe make this my last will and testament. First I give and bequeath my soule unto the hands of God that gave it and my body to the earth from whence it came, and I doe give unto Alice my second daughter all the goods that is in the litle parlor behind the shop and one longe table in the greate parlor and one bay mare and all the tobacco in the warehouse, further my will and mind is that I give all the rest of my estate to my wife and Elizabeth my eldest daughter and Joyse my youngest daughter to be equally divided amongst them three and my funerall charges to be paid out of their three parts witnesse ?Ralen Hurt, John ?Duro his mark, William Kay, John Richmond, William Stanley.

### **Order to suppress the growing of tobacco in Yorkshire, 1677.**

To his majesties justices of the peace in the county of Yorkshire att their next sessions for the sayd county. To be left with Mr Richard Taylor wayter and searcher of his majesties customes att York.

After my hearty commendacions being informed that notwithstanding all former meanes used to prevent or suppress the planting of tobacco in England the laws in that behalfe are still violated by planting it in diverse parts of your county. I have therefore thought it necessary to remind you of the said law and particularly of that made 22<sup>nd</sup> and 23<sup>rd</sup> of his majesties reigne, desiring that you will take care to issue your warrants to the respective high constables, petty constables and tything men and persue all other the trusts and the powers committed to your charge in this behalfe, wherein not doubting but you will use your endeavours as in a matter of soe great importance not only to his majesties customs, but to the trade and navigation of this kingdome, I bid you very heartily farewell and remayne

Gent

### **Will of William Lee of Rotherham, 1680**

William Lee late of Rotherham in the County of Yorke, Pipemaker, being weak of body but of sound and perfect memory did the the [sic] 29<sup>th</sup> of January 1680 make his will nuncupative by word of mouth as followeth. Impremis he gave to his eldest sonne Francis Lee six pair of tobacco pipe moulds and two screws and if he was not content with that then twelve pence and nothing else, the rest of his goods and chattalls he gave to his wife Elizabeth towards the bringing up of his children and this he declared in the presence of us whose names are subscribed.

Thomas Greane  
Martha ?Scholey  
?Chester ?Woolline

**Will of Richard Shafton (Shaftoe) of York, 1705 (Transcribed by John Andrews)**

In the name of God Amen, I Richard Shafton of the City of Yorke Tobacco pipe maker do make and ordain this my last Will and Testament: imprimis I give unto my son Joseph Shafton twenty shillings to be paid only upon the psonall demanding of the same, being in full of what he shall demand out of my psonall estate. I give unto my daughter Elizabeth the now wife of Willm ffoster twelve pence which with what I have heretofore given her is in full of her filial or childs part. I give to my son William Shafton twelve pence which with what I have heretofore given him is in full of his portion. I give to my son Richard Shafton five pounds to be paid withing twelve Calendar months next after my deceas; I also give unto the said Richard Shafton all my worke tooles belonging to the Pipe making Traide in my backe shop. I give to my Son George Shafton fifteen pounds Viz; five pound to be paid when hee goes apprentice and ten pounds to be paid him when hee is loose from his apprenticeship. I give unto my daughter Grace Shafton the somme of tenn pounds to be paid at her marriage or when she attaines the age of one and twenty yeares. But if either George Shafton or Grace Shafton shall happen to dye before their Legacies become due, that then the legacy of him or her so dying shall go to the survivor of them. I give and bequeath unto my daughter Sarah Shafton the somme of twenty pounds and one silver Cupp. And my will is that my daughter Sarah shall take care to brig upp the said Grace and George Shafton until they be fitt or apprentices or other services. And I order her to have the benefit or use of what I leave them until then. I also give unto my said Daughter Sarah all the rest residue and remainder of all my psonall estate and do hereby make her sole Executrix of this my last Will and Testament:

In witness whereof I have hereunto putt my hand and seale and published this my last Will and Testament the thirteenth day of May Anno Dni 1705

Signed sealed published and declared to be my  
Last Will and Testament in the presence of  
James Moxon (signed)  
John Spacie (signed)  
Mark Walden Jnr (mark)  
Tho. Lessington (signed)

Signed and sealed  
Richard Shafton

Note: Probate was granted in 1709 to the executrix Sarah Spacey wife of William Spacey, with William Spacey Tobacco Pipe maker of York and Henry Sleggs Clothier of York sureties.

**Inventory of William Spacie of York, 1710 (Transcribed by John Andrews)**

An Inventory of ye goods of Will[ia]m Spacie late of ye City of Yorke dec[eas]ed

	£: s: d
Impr[im]is in ye little Chamb[e]r: one bedstead w[i]th bedding and curtains	2:00:00
It[em] 9 Chaires and a Chest of Drawers	0:19:00
It[em] 1 lookeing glass and 6 pictures	0:05:00
Goods in ye great chamb[e]r: 3 beds w[i]th beadsteads & all belonging to them	3:00:00
It[em] 6 chests and a trunke	0:10:00
It[em] 1 stand & a writer liedge and a table frame and 1 ovell table	0:06:00
In ye Garrett one bushel 3 tubbs 3 p[ai]r paniors a Close Stoole & a panne & 2 Close baskitts	0:09:00
It[em] 6 doz[en] bark beesoms & 4 doz[en] ling beesoms	0:07:00
It[em] 13 p[ai]r[s] Sheets and 13 p[ai]r[s] Pillow-beares	3:02:00
It[em] 6 doz[en] napkins	1:10:00
It[em] 4 table Cloths	0:06:00
It[em] other Course napkins	0:10:00
It[em] Silver Plate	3:00:00
In ye Parlor 2 tables and a forme	0:13:00
It[em] 6 Chaires and a Stoole	0:04:00
It[em] 2 Cushions	0:06:00
It[em] 2 warming panss & a mortar & 3 Candlesticks	0:07:00
It[em] pewter	2:10:00
It[em] beds and beadsteads and beding	2:00:00
It[em] In ye Kitching 1 Jack and rainge and other iron things w[i]th iron potts and panss	1:12:00
In ye Shopp Moulds Clay and pipes w[i]th worke tooles	3:06:00
It[em] one Lead cestren	0:12:00
It[em] washing Tubbs	0:02:00
It[em] Shopp goods to ye Vallue	0:13:00
It[em] Bacon and Cheese	1:10:00

-----  
29:07:06  
-----

Jno: Gaile  
Rob: Jackson  
Hen: Sleggs  
James Todd (marke)

**Will of Christopher Boyes of York, 1725 (Transcribed by John Andrews)**

I, Christopher Boyes, of the City of York, trunkmaker, being of p'fect mind and memory do ordain this my last Will in form following: I give to my sone Christopher Boyes one hundred and forty pounds in money and goods viz, the money I lately paid Mrs Spendlove for him, one hundred thirtythree pounds or thereabouts and the rest in furniture which, with my wife's jointure of the forepart of the house I dwell in is in full for his the portion & which furniture is already in his possession.

Item. I give and devise to my son Samuel Boyes and his heirs the back part of the same house with the kitchen, two chambers, the chamber and garrett's above and ye little yard and pipeshop with free passage, Ingresse, Egresse, Regresse, to and from ye street to these back the other, its appurtences without interruption of ye owner or occupier of the fores'd.

Item. I give to my daughter Rebecca Boyes all my leased house in North Street in the tenure of Mr Baynes and others . . . . . and whatever belongs thereto.

And if my sone Samuel be not minded to follow my trade, but his sister should be so minded I order that she shall have these back part as tenant to her brother Samuel as long as she thinks fit at six pounds per annum. Also I appoint & make my son Samuel and daughter Rebecca joint exec'rs hereof & legators of my debts owing to me. Those upon bonds and specialities excepted for satisfying ye debts I owed & of my goods, chattels & p'sonal estate undisposed of equally to be divided between them. But if either of my executors are discontented with their share and will not be advised & reconciled by my friends, hereafter names or some . . . . . neighbours but occasion any suit at law or in Equity touching any part of my estate, the executor of such suit shall forfeit his or her share to my other executor to whome I herebygive the same accordingly and I do appoint and desire my good friends . . . . . Wilkinson Ald William Ramsell and Mr James Dodworth to act as . . . . . of my Will and moderate any dissents or controversy which may arise among my children and I do make void all other Wills whatsoever.

Written of my hand and seal this sixth day of August 1725.

Signed, sealed and published before us and attested same by subscribing our names in ye testatore.

James Dodworthy  
William Ramsdell  
. . . . . Wilkinson

**Inventory of Christopher Boyes of York, 1725 (Transcribed by John Andrews)**

An inventory of the goods & chattels & personalle estate of Christopher Boyes, trunkmaker, in the City of York dec'd August ye 16<sup>th</sup> 1725 by . . . . .

Item	Contents of his purse & apparel	10:00:00
	In the kitchen, range & ( )	00:15:00
	Jack 15s iron fenders 6s	01:01:00
Item	Spitts & frying pan	00:10:00
	5 pr of tongs	00:02:06
	3 fire shovels	00:01:06
	1 Gallow balk (?) 7 3 re?kous brigs(?)	00:03:00
	1 broiling iron & ( . . . . . )	00:02:06
	3 smoothing irons in heaters	00:05:00
	1 iron pot, 1 iron pan	00:09:00
	1 brass pot	00:06:00
	6 pans 1 skellit	00:15:00
	tea kettle & coffee pot	00:08:00
	brass mortar & fender	00:05:06
	snuffers, diskes & other brasses	00:08:00
	warming pan	00:06:00
	bellows 2s 6d copper 1s	00:03:06
	3 dressers & shelves	01:15:00
	1 oval table and 5 chairs	00:05:00
	20 pewter dishes & a cheeseplate	02:06:08
	3 doz & 8 plates at 8s a dozen	01:09:04
	1 flagon & quart mustard 6oz salt	00:03:06
		-----
		21:11:00
In the hall.		
	A looking glass	02:00:00
	An oval table & cain chairs & a courtchair	01:01:00
	A glass (sconces?)	00:01:00
	A chafeing dish	00:00:09
	A table in the passage	00:01:06
	A silver tankard @ 18 ounces & ½ at 5s	04:12:06
	Silver mugg 5 ounces & ½ at 5s	01:07:06
	Salvers pounds 4 penny 10 at 5s	02:01:00
	2 salts 3 ounces 3 penny 10 at 5s	00:15:09
	4 spoons 4 ounces 16 penny ( )	01:04:00
	2 cups 6 ounces & ½ 8 penny worth	01:14:00
		-----
		13:01:06
In the far shoppe.		
	3 male trunks	01:04:00
	2 port mantles	01:02:00
	6 trunks covered	00:17:00
	10 trunks joined, wigg boxes & pasteboard boxes	00:15:00
		-----
		03:18:00

<b>In the chamber over the entry</b>	
A looking glass	00:01:00
1 pr of drawers	00:10:00
An oak cupboard	00:02:00
1 oval table	00:01:06
ffather beads, bolster & pillows wth 6 ( ) at 8s	02:12:00
1 red rug	00:05:00
bedstead & hangings	00:05:00
close stoole & pan	00:02:06
	-----
	03:19:00
 <b>In the street chamber</b>	
Feather beds, bolsters & pillows	02:10:00
2 blankitts	00:06:00
Quilt	00:05:00
Green rug	00:07:06
Bedstead & hangings, curtain	00:10:00
1 table, 3 trunks, 5 chairs	00:15:00
1 seeing glass, 5 chairs	00:07:00
stand, teaboard & 2 pictures	00:01:00
3 cushions 1s, stool 6d	00:01:06
	-----
	05:03:00
 <b>In the chamber of Mr Smiths shop</b>	
1 feather bed, bolster & pillows	02:16:00
2 blankitts 6s, quilt 6s	00:12:00
bedstead, curtain rods, hangings	00:15:00
drawers & table	01:00:00
teatable, seeing glass	00:12:00
6 chairs, 15 pictures over chimney	00:18:00
stoole & writing desk	00:01:00
curtain rods & stand	00:01:00
	-----
	06:15:00
 <b>In the chamber over the hall</b>	
1 featherbed, bolster & pillows	02:17:06
3 blankitts 18s, quilt 10s	01:08:00
bedstead, hangings, curtain rails, cords	01:00:00
seeing glass 10s, stand 6d	00:10:06
case of drawers, table	01:02:06
armchair & 6 cain chairs	01:10:00
	-----
	08:08:06

A screen & table leafe	00:03:00
A large table leafe	00:04:06
Window curtains & rods, 1 pr sheets, pillow cloths marked	00:10:00
1 pr of sheets & pillow cloths marked	00:10:00
1 pr of sheets & pillow cloths marked	00:06:00
1 pr of pillow cloths marked	00:06:00
1 pr of sheets, marked, old sheet	00:02:00
1 turned sheett	00:02:00
4 pr of coarse sheets	00:12:00
1 pr ( ) & pillow bears	00:03:00
4 pr sheetts & pillow cloths	00:06:00
1 pr sheetts & pillow cloths	00:06:00
5 bolster clotts & towels	00:02:06
A table cloth, marked	00:06:00
2 doz napkins	01:04:00
6 coarse napkins, 1 table cloth	02:10:00
	-----
	[07:15:00]
In the chamber over the back kitchen	
Feather bed	03:04:00
Quilt 10s, 3 blankitts 10s	01:00:00
Hanging 10s, beadstead 10s	01:00:00
A glass, a table, 4 chairs & 1 stand	00:12:06
1 rugg, 6 blankitts & cover	00:08:06
A bedbolster & pillows	02:16:00
Quilt 6s, 3 blankitts 1s 6d	00:10:06
Bedstead & hangings 5s	00:05:00
A table 5s	00:05:00
	[10:01:06]
In the garrett	
Bed 5 s @ 4 ( )	01:00:00
3 ruggs	00:07:00
1 table 3 boxes	00:07:06
In the little chamber	
Bed ( ) @ 16s	01:16:00
2 beadsteads	00:05:00
	-----
	03:15:06



In the closet

2 hundred & an ½ of pasteboards	03:10:00
9 horseskins	02:00:00
15 calveskins	00:15:00
7 seals	00:08:00
12 red bassons	00:04:06
shears ( ) and other tools	00:09:06
19 rams of whitecap paper	03:19:00
clay by estimate 40 tons	40:00:00
brass moulds	01:07:00
20 slitt deals	01:10:00
iron rack 5s 6b great cupboard 2s 6d	00:06:00
drying grates 25	00:12:06
( ) 21 @ 3d	00:05:03
boards 15 screws 11g	04:02:00
turfs 30000	03:00:00
lead cestern and 2 troughs	01:05:00
joynts 20 doz	00:10:00
locks & keys	00:05:00
stock in pipes 6 gross	00:15:00
800 (rabits ?)	00:02:00
5000 sprigs	00:07:00
locke joyntes 18 doz	00:06:00
trunk handles 16 doz	00:05:04
chain 8 yds	00:02:00
corner plates 18	00:01:00
locks 2 doz	00:04:00
locks 5 more	00:01:05
locks 5 doz	00:04:06
trunknails	00:01:00
handles 3 doz	00:01:00
2 cubbitt stools	00:01:00
6 yds of cloth	00:01:06
napkin press	00:05:00
2 copper pipes for bakeing	00:04:00
2 washing tubbs	00:02:00
	-----
	67:12:06
	-----
In all	159:12:00

We whose names are handwritten have apprized the goods in this schedule  
containing 4 sides of paper

Witness our hands

Robert Smith  
Martin Pallister  
Leo Matthews  
Will Ramsdale

**Petition regarding Mary, wife of John Horsfield of Bradford, pipemaker,  
Bradford July 1728.**

To the Honorable the Bench of Justices att Bradford.

The humble petition of several of the inhabitants of the townshipp of Bradford, sheweth that Mary wife of John Horsfield of Bradford affordsaid pipemaker – some time before the last assises at York was committed to York Castle upon suspicion of entering the house of one Elizabeth Mercer widdow of Bradford afforsaid and taking there feloniously a considerable sume of money and had her tryall therefore att the said last assises, but the evidence not being full enough to induce the jury to find her guilty, shee was acquitted but not without the strongest suspicion of guilt. Since her deliverance shee the said Mary Horsfield hath again been taken upp and committed to ye house of correction on suspicion of the felonious taking out of the house of Wm Tring (?) of Bradford aforesaid Innholder in ye night time several sorts (?) of linen and is to take her tryall therefore att these present sessions and she the said Mary Horsfield hath committed diverse other felonyes in ye said town of Bradford but hath not been prosecuted for the same and ye petitioners now understanding that the said Mary still persists in her felonious designs and remains obstinate and incorrigible notwithstanding her confinement in ye two several Gaols which putts your petitioners and ye rest of the inhabitants of Bradford under angerous apprehensions after her releasement for prevention wherefore and to keep your petitions and the rest of the inhabitants safe in their houses from such desperate offenders, your petitioners prays judgement of transportation upon her being found guilty if the same by your honours shall be thought expedient. If not that particular directions bee given for ye severe scourging of her body and ye petitioners shall ever prays(?).

Wm Wright, Wm. Rawson  
George Fletcher, Ro.Stansfield  
John Atkinson  
John Northend, Rich. Thompson  
Thomas Walker, Abm Swaine  
Wm Lister, Jere (?) Wilson  
Joseph ???

## **Sentencing of Mary Horsfield, Bradford 17<sup>th</sup> July 1728.**

Whereas Jeremiah Oates, Thomas Walker and Mary Horsefield have severally been judicated and convicted at the said sessions of diverse ffelonys by them severally and respectively committed within the said Riding. The sentence of the said court was and at is ordered that they the said Jeramiah Oates, Thomas Walker and Mary Horsefield and every of them be transported into some of his majesties collonys or plantations in America there to be for the space of seven years, and it is further ordered that they the said Jeremiah Oates, Thomas Walker and Mary Horsefield be committed to and confined in his majesties Gaol the castle of York until such time as they can be sent from thence in order to be transported – To the Goaler [sic] or keeper of his majesties Goal [sic] the Castle of York.

**Will of William Ramsden of York, 1769 (Transcribed by John Andrews)**

In the name of God Amen. I William Ramsden of the City of York, pipemaker, being of perfect mind, memory and understanding, thank God for the same, do make this my last Will and Testament in manner following (that is to say) I give and bequeath unto my dear wife Elizabeth Ramsden all my personal estate & effects of what nature or sort soever the same are and do hereby make and appoint her sole executrix of this my last Will and Testament. In witness whereof I have hereunto set my hand and seal the twentyfourth day of September in the year of our Lord One thousand Seven hundred and sixty.

William Ramsden

Signed, Sealed, Published  
and declared by the said  
William Ramsden as and  
for his last Will and Testament  
in the presence of

And'w Bulmer  
Rich'd Pickering

An appraisement made of goods of William Ramsden in Goodramgate in York,  
deceased the 20<sup>th</sup> August 1763 'praised by us whose names are hereunto subscribed.

Purse and apparel	£6 0 0
In the house and kitchen; one clock ten pewter dishes, eighteen plates one pewter case, three tables, nine chairs, one iron range and plates and tongs, one jack, one pot, one pan, one warming pan with other necessaries	£4 0 0
In the chamber: one bed & stocks hangings and bedding, one chester of drawers one corner cubbert with one silver pint and two spoons with other necessaries	£6 0 0
In the garrett; one bed, bedstocks and bedding & one chest.	£2 10 0
	-----
Total	£18 10 0

Hen Royston  
Rob't Taylor  
John Miles

**Apprenticeship indenture of Joseph Scott to Thomas Westerdell, 1788**  
(Transcribed by Peter Rayner)

*NB: This is a pre-printed document with blanks left for the relevant details to be added by hand. The text in bold appears as hand-written text in the original document.*

This indenture made the **twenty eighth day of October** in the **twenty ninth** year of the reign of our sovereign Lord **George the third** by the Grace of God, of Great Britain, France and Ireland, King, Defender of the faith, &c and in the Year of our Lord one thousand seven hundred and eighty eight – between **Joseph Scott son of John Scott of the town and county of Kingston Upon Hull. Pipe maker of the one part, and Thomas Westerdell of the town and county of Kingston Upon Hull – aforesaid shipwright and chapman – of the other part,** witnesseth, that the said **Joseph Scott** hath of his own free will, and with the consent of **his father** put and bound himself apprentice to and with the said **Thomas Westerdell** with him after the manner of an apprentice, to dwell, remain, and serve from the **first day of January last past** for, during, and until the term of seven years, then next following, be duly completed and ended. During all which term the said apprentice his said master well and truly shall serve; his secrets shall keep; his lawful commands shall do; fornication or adultery he shall not commit; hurt or damage to his said master he shall not do or consent to be done, but to his power shall let it, and forthwith, unless he be about his said Masters business there to be done; at dice, cards, tables, bowls, or any other unlawful game he shall not play; the goods of his said Master he shall not waste or lend, or give them to any person without his Master licence. Matrimony with any woman within the said term he shall not contract, nor from is Masters service at any time absent himself; but as a true and faithful apprentice he shall order and behave himself towards his said master and all his family, as well in words as deeds, during the said term. And true and just accounts of all his said Masters goods, chattels and money committed to his charge on which shall come to his hands, faithfully he shall give at all times, when thereunto required by his said Master, his executors, administrators, or assigns; and the said **Thomas Westerdell the Master.** For himself, his executors, administrators, and assigns, doth covenant, promise and grant by these presents, to and with the said **Joseph Scott, the said apprentice,** that he the said Master, his executors, administrators, or assigns, shall and will teach, learn, and inform him the said apprentice, or cause him to be taught, learnt, and informed in the **art or business of a pipemaker** which he the said Master now useth after the best manner of knowledge that he or they may or can, with all the circumstances thereunto belonging. And also shall find and provide to and for the said apprentice sufficient and enough meat drink and lodging suitable for such an apprentice during the said term and likewise to find shoes for his said apprentice for and during the first three years of his said apprenticeship – the said **John Scott the father taking care to find for his son all the rest of his apparel, cloathing, and washing during all the term aforesaid.** And for the true performance of all and singular the covenants and agreements aforesaid, each of the parties aforesaid doth bind himself unto the other firmly by these presents. In witness whereof, the parties above-

named to the present indentures interchangeably have set their hands and seals the day and year above written.

Sealed and delivered (being first duly stamped)  
in the presence of

**John Scott (his mark)**

**Joseph Scott**

**Mary Westerdell**

**Thos Westerdell**

**John Yeoman**

**May at 23 – 1796**

**Joseph Scott served his time as specified in the indenture to me**

**Thos Westerdell**

**Memorandum** – This indenture must bear the day it is executed, and what money or other thing is given or contracted for with the apprentice, must be inserted in words at length, and the duty paid to the stamp office, if in London or within the weekly bills of mortality, within one month after the execution; and if in the country, and out of the said Bills of Mortality, within two months, to a distributor of the stam(p) or his substitute; otherwise the indenture will be void, the Master or Mistress forfeit fifty pounds and another penalty, and the apprentice is disabled to follow his trade or to be made free.

### **Appendix 3: Collection Summaries – Part I**

Part I of this appendix contains details of those collections recorded specifically for the purposes of this research. For each collection the name, collection code, contact name and address has been given. A brief summary of the nature of each collection is also given. All seventeenth and eighteenth century pipes have been recorded in detail on the Yorkshire Database and a selection from each collection have been illustrated in order to give an indication of the range of bowl forms present. These summaries have been arranged alphabetically by place, i.e. county then town.

A brief description of the notable pipes from the nineteenth-century from each collection is given for completeness and, in some instances, a selection of these have been illustrated.

Stamped marks from all periods have been impressed and details logged for the National Clay Tobacco Pipe Stamp Catalogue (NSC).

All illustrations in this appendix are at 1:1 and have been drawing by the author unless otherwise stated. All illustrations are arranged chronologically by site for each collection. In the captions, unless otherwise stated, all fragments are not burnished and all bowls have no internal bowl cross.

**Collection Name:** Hartlepool Museum Service

**Collection Code:** 0156

**Contact Name:**

**Address:** Sir William Grey House, Hartlepool, Cleveland

**Description:**

Collection recorded 1<sup>st</sup> June 1998. Miscellaneous collection of approximately 50 bowls, mainly nineteenth or twentieth century, some not accessioned. Marked or notable pieces include the following:

- Burns cutty pipe with lettering along the side of the stem.
- 88'87'1 – Pipe with an animal climbing up a tree, ?opossum; stem missing but rest complete.
- Bowl with Masonic motifs dating from c1820-1860 with the lettering HILTON/ WHITBY moulded round the rim.
- 134'81'1 – Complete pipe with the lettering RUTHERFORD/THE WORKMAN in incuse letterings along the side of the stem.
- 3'84 – Pipe commemorating the Royal Jubilee 1837-1887 with the lettering A ADAMS/GATESHEAD along the side of the stem.
- 20'88 – Cadger bowl with brown varnish and the lettering McDOUGALL/ SCOTLAND along the sides of the stem.
- 46'83 – stub-stemmed bowl with LITTLE GEM on the right-hand side and the registration number 452747 on the left-hand side.
- 46'83 – Stoneware bowl
- 63'84 – Large Gambier head pipe (man with a beard) with enamel decoration, pattern number 866.

**Collection Name:** Tees Archaeology  
**Collection Code:** 0142  
**Contact Name:** Mr Robin Daniels  
**Address:** Hartlepool, Cleveland

**Description:**

Collection recorded 1<sup>st</sup> June 1998. The collection has a large number of pipes ranging in date from the seventeenth century through to the nineteenth and early twentieth century. In addition to the seventeenth and eighteenth century material recorded in detail for the Yorkshire Database and the National Stamp Catalogue a number of later nineteenth century pipes were recorded, the most notable are as follows:

- Yarm 1977 – Complete bowl dating c1800-1840 with the lettering H.ROW/YARM around the rim and with the bowl decorated with enclosed flutes and foliage.
- Yarm 1977 – Acorn style bowl with the lettering .ROW/Y... around the rim, presumably as above.
- SCW96 – Early nineteenth century bowl with a thistle and rose design; leaf decorated seams and the moulded initials WB.
- HMG86 – includes some very large context groups of good fresh material looks like it may be kiln waste although a large number of fragments have been smoked. All long stemmed pipes with pale green/yellow glaze. Includes plain bowls; ones with leaf decorated seams; hearts and foliage above enclosed flutes; religious figure groups above flutes, flowers etc. A group worthy of further study.
- TGP91 – Group includes strips of squashed pipe clay that may be production waste.

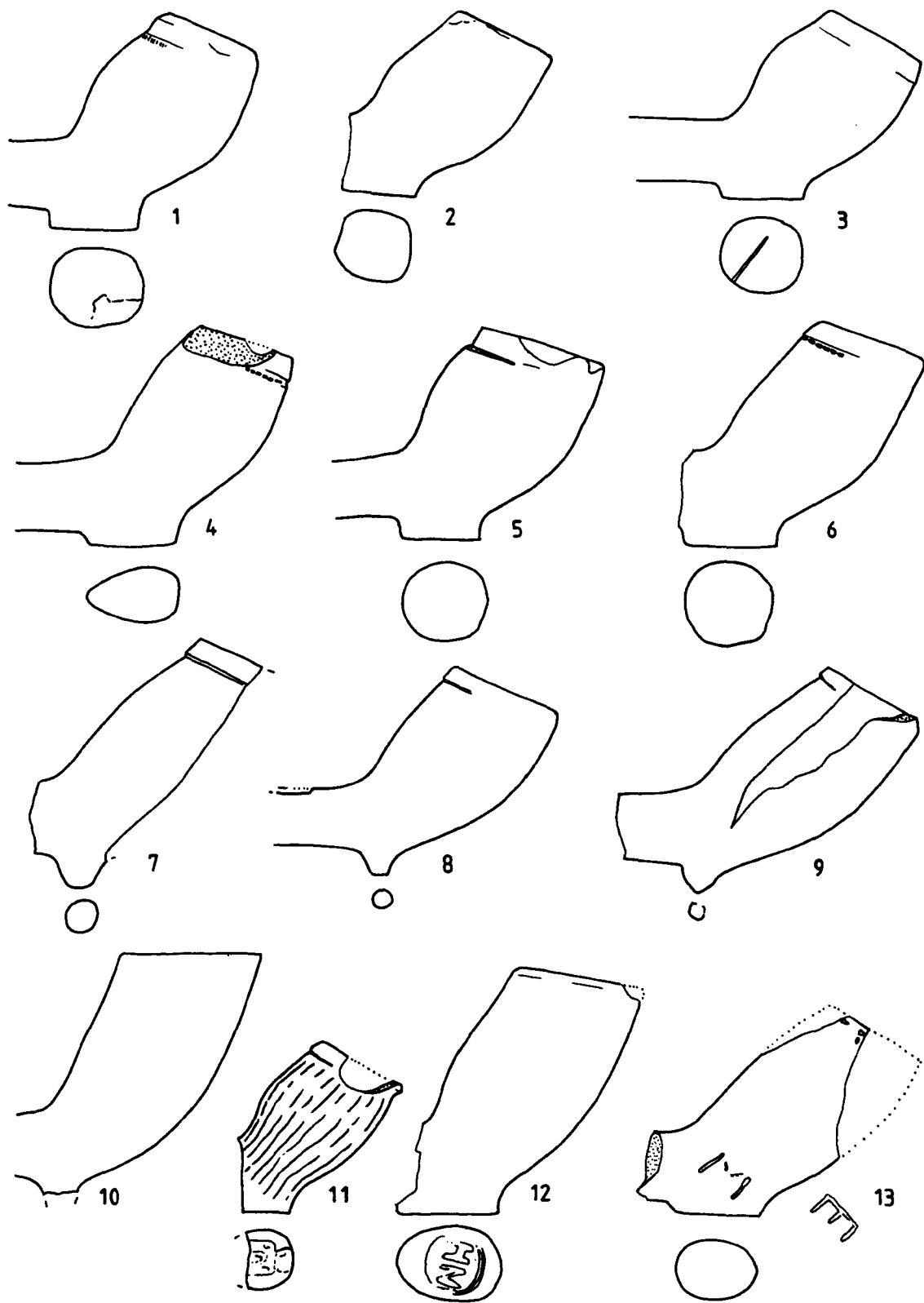
- 1.01 Heel type bowl dating from c1660-1680 from the Boroughgate Excavation, 1970 (Acc No. SK70 A12 (2)); rim bottered and half milled; stem bore 8/64". (Pcode 07090).
- 1.02 Heel type bowl dating from c1645-1660 from Brotton Playing Field (Acc No. OBPF/74 Trench D3); rim bottered but not milled; stem bore 8/64". (Pcode 07122).
- 1.03 Heel type bowl dating from c1660-1680 from Brotton Playing Field (Acc No. BPF77 Trench J); rim bottered but not milled; stem bore 8/64". Milled heel. (Pcode 07117).
- 1.04 Heel type bowl dating from c1660-1680 from Brotton Playing Field (Acc No. BPF 18/4/79 Trench N); rim bottered and fully milled; stem bore 6/64". (Pcode 07113).
- 1.05 Heel type bowl dating from c1660-1680 from Brotton Playing Field (Acc No. BPR77 Trench K); rim bottered and half milled; stem bore 8/64". (Pcode 07119).



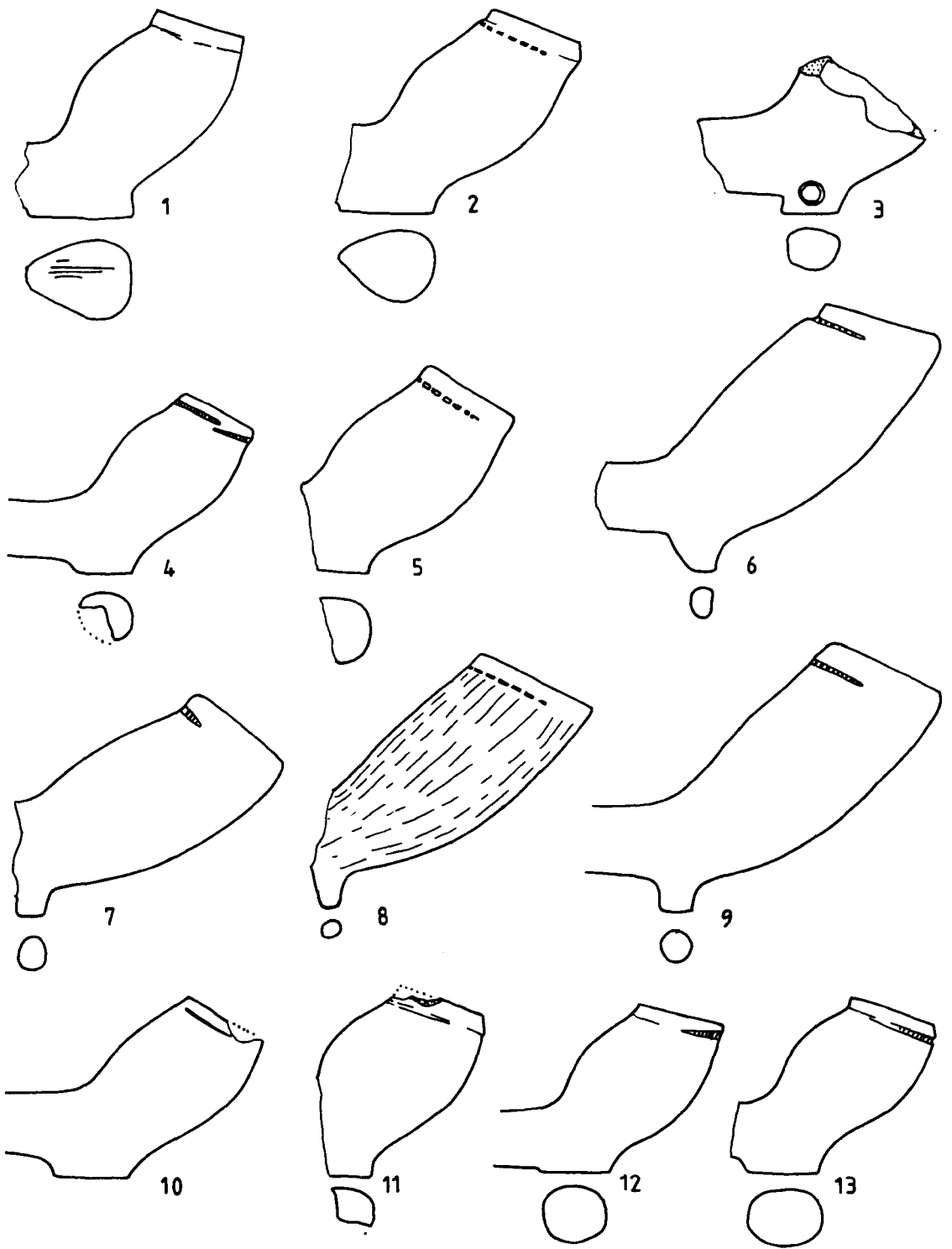
- 1.06 Heel type bowl dating from c1670-1690 from Brotton Playing Field (Acc No. OB4/75 Trench E); rim bottered and one quarter milled; stem bore 6/64". (Pcode 07121).
- 1.07 Spur type bowl dating from c1670-1690 from Brotton Playing Field (Acc No. OBPF77 Trench J); rim bottered but not milled; stem bore 7/64". (Pcode 07124).
- 1.08 Spur type bowl dating from c1670-1700 from Brotton Playing Field (Acc No. BPF78 Trench L); rim bottered but not milled; stem bore 6/64". (Pcode 07118).
- 1.09 Spur type bowl dating from c1690-1710 from Brotton Playing Field (Acc No. BPF Trench L); rim bottered and one quarter milled; stem bore 6/64". (Pcode 07116).
- 1.10 Bowl dating from c1700-1770 from Brotton Playing Field (Acc No. OB4/75); rim cut but not milled; stem bore 5/64". (Pcode 07120).
- 1.11 Heel type bowl dating from c1620-1640 from Church Walk, Hartlepool (Acc No. HCW72 F15 D-1 1160.97); good burnish; rim bottered and milled around all of the surviving rim stem bore 5/64". Marked with a castle on the heel. Possibly Scottish. (Pcode 02023).
- 1.12 Heel type bowl dating from c1680-1710 from Church Walk, Hartlepool (Acc No. HCW72 F14 D-3 1160.97); rim bottered but not milled; stem bore 6/64". Marked with the initials HN on the heel. (Pcode 02022).
- 1.13 Heel type bowl dating from c1680-1700 from Church Walk, Hartlepool (Acc No. HCW72 F15 D-2 1154.97); rim bottered but not milled; stem bore 7/64". Marked with the initials EM on the sides of the bowl. Possible moulded decoration round rim; possible Norfolk maker (Atkin 1985b). (Pcode 07058).
- 2.01 Heel type bowl dating from c1650-1670 from Middlegate, Hartlepool (Acc No. HMG86 A (114)); rim bottered and one quarter milled; stem bore 6/64". (Pcode 07073).
- 2.02 Heel type bowl dating from c1650-1675 from Middlegate, Hartlepool (Acc No. HMG86 A (114)); rim bottered and one quarter milled; stem bore 6/64". (Pcode 07072).
- 2.03 Heel type bowl dating from c1700-1750 from Middlegate, Hartlepool (Acc No. HMG86 A (113)); stem bore 5/64". Marked with the initials OW on the sides of the heel. No rim surviving. (Pcode 07071).
- 2.04 Heel type bowl dating from c1640-1660 from Morrison Hall, Hartlepool (Acc No. HMH87 A (122)); rim bottered and fully milled; stem bore 7/64". (Pcode 07083).

- 2.05 Heel type bowl dating from c1650-1670 from Morrison Hall, Hartlepool (Acc No. HMH87 A (122)); rim bottered and three quarters milled; stem bore 7/64". (Pcode 07084).
- 2.06 Spur type bowl dating from c1670-1690 from Morrison Hall, Hartlepool (Acc No. HMH87 A (121)); rim bottered and half milled; stem bore 7/64". (Pcode 07080).
- 2.07 Spur type bowl dating from c1680-1710 from Morrison Hall, Hartlepool (Acc No. HMH87 A 03); rim bottered and one quarter milled; stem bore 7/64". (Pcode 07087).
- 2.08 Spur type bowl dating from c1680-1720 from Morrison Hall, Hartlepool (Acc No. HMH87 A (121)); average burnish; rim bottered and half milled; stem bore 7/64". (Pcode 07081).
- 2.09 Spur type bowl dating from c1680-1710 from Morrison Hall, Hartlepool (Acc No. HMH87 A (122)); rim bottered and one quarter milled; stem bore 8/64". (Pcode 07085).
- 2.10 Heel type bowl dating from c1640-1660 from the Rosedale Abbey Excavation, 1970 (Acc No. RE 5/70); rim bottered and one quarter milled; stem bore 5/64". (Pcode 07089).
- 2.11 Heel type bowl dating from c1640-1660 from West Street (Acc No. YWS75 1 Area AC III); rim bottered but not milled. (Pcode 07134).
- 2.12 Heel type bowl dating from c1640-1660 from Westgate (Acc No. 1976/8 GW9); rim bottered and fully milled; stem bore 6/64". (Pcode 07132).
- 2.13 Heel type bowl dating from c1635-1650 from Westgate (Acc No. 1976/8 GW13); rim bottered and fully milled; stem bore 6/64". (Pcode 07128).
- 3.01 Heel type bowl dating from c1650-1670 from Westgate (Acc No. 1976/8 GW10); rim bottered and three quarters milled; stem bore 6/64". (Pcode 07126).
- 3.02 Bowl dating from c1660-1680 from Westgate (Acc No. 1976/8 GW2); rim bottered and three quarters milled (Pcode 07129).
- 3.03 Heel type bowl dating from c1660-1680 from Westgate (Acc No. 1976/8 GW28); rim bottered but not milled; stem bore 7/64". (Pcode 07130).
- 3.04 Heel type bowl dating from c1700-1770 from Westgate (Acc No. 1976/8 GW109); rim cut but not milled; stem bore 6/64". Marked with the initials RH on the sides of the heel. (Pcode 07127).
- 3.05 Bowl dating from c1680-1710 from the Friar Street Excavation, 1988 (Acc No. HFS88 A (01)); good burnish; rim bottered and three quarters milled; stem bore 6/64". (Pcode 07060).

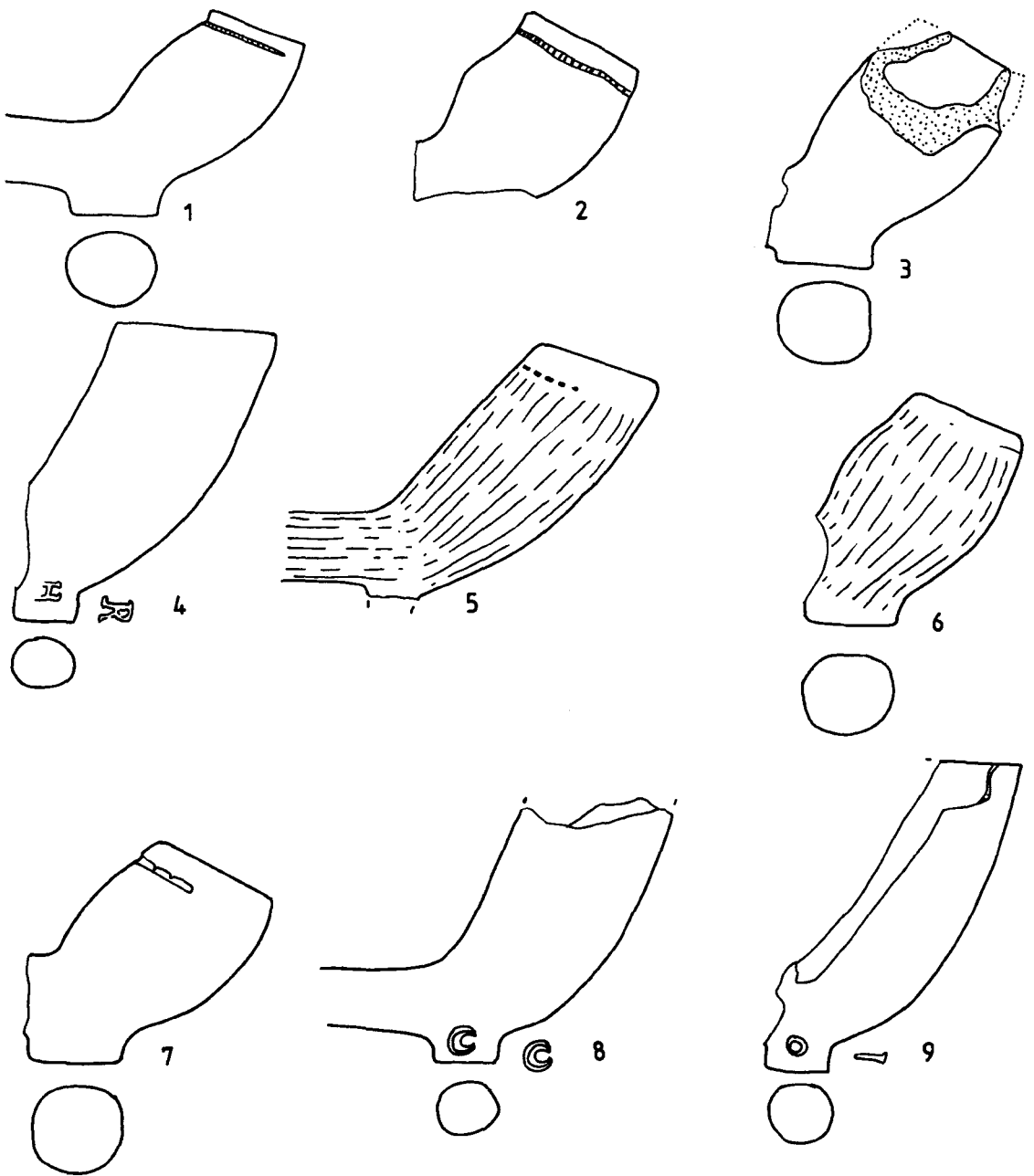
- 3.06 Heel type bowl dating from c1650-1670 from Yarm (Acc No. Y80 (49)); poorly burnished; rim bottered but not milled; stem bore 7/64". (Pcode 07102).
- 3.07 Heel type bowl dating from c1660-1680 from Yarm (Acc No. Y77 (0)); rim bottered and one quarter milled; stem bore 7/64". (Pcode 07096).
- 3.08 Heel type bowl dating from c1700-1750 from Yarm (Acc No. Y77 (0)); stem bore 5/64". Marked with a crescent moon motif on sides of heel. (Pcode 07095).
- 3.09 Heel type bowl dating from c1700-1750 from Yarm (Acc No. 1977.8Y (0)); rim cut. Marked with the initials IO on the sides of the heel. (Pcode 07093).



**Figure 1:** Pipes from the collections of Tees Archaeology. Scale 1:1.



**Figure 2:** Pipes from the collections of Tees Archaeology. Scale 1:1.



**Figure 3:** Pipes from the collections of Tees Archaeology. Scale 1:1.

**Collection Name:** Dorman Museum  
**Collection Code:** 0157  
**Contact Name:** Ms Louise Rolley  
**Address:** Middlesborough, Cleveland

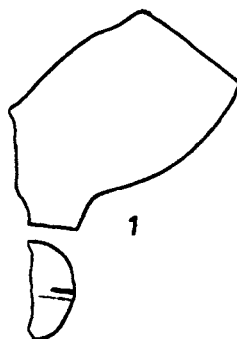
**Description:**

Collection recorded on 2<sup>nd</sup> June 1998. The majority of the collection consisted of later nineteenth-century material. There were three or four earlier pipes but most of these seem to be on loan from York Castle museum. The seventeenth- and eighteenth-century fragments were recorded in detail for the Yorkshire Database.

The most notable pieces of the collection's later material are as follows:

- 1317/75 – an abraded Sherlock Holmes bowl
- D56/1974 – a late nineteenth-century bowl with leaf facing the smoker; leaf rib and three wide flutes.
- M1595/1979 – Plain thick, Irish style bowl with reworked stem mouthpiece.
- 136m/75 – Death or glory bowl
- RAOB bowl with roll spur and moulded milling
- M1239/1988 – Ally Sloper bowl
- M1596/1979 – reworked stem of a C Crop pipe bearing the registration number 159329.
- D56/1974 – bowl with a head on each side of the bowl and the relief moulded lettering JOHN BRIGHT/REFORM on left-hand side and W GLADSTONE /REFORM on the right-hand side.
- 1361/74 – spur bowl with the lettering TW moulded on the bowl facing the smoker.

4.01 Heel type bowl dating from c1650-1670 from Newport (Acc No. M36/1977); rim bottered and one quarter milled; stem bore 8/64". Surface smooth and shiny but no obvious burnish lines. (Pcode 08107).



**Figure 4:** Pipe from the collections of the Dorman Museum, Middlesborough.  
Scale 1:1.

**Collection Name:** Bowes Museum

**Collection Code:** 0143

**Contact Name:**

**Address:** Barnard Castle, County Durham

**Description:**

Collection recorded in two separate visits, 3<sup>rd</sup> May 1995 and 3<sup>rd</sup> June 1998. In June 1998 three boxes of pipes, one from Chester-le-Street and two from Piercebridge, were taken back to Liverpool for recording. These boxes were returned in April 1999.

Approximately 70-80 bowls and marked or decorated stems dating from the seventeenth or eighteenth century were recorded. These included a large group from Dalden Tower, which produced pipes mostly of late seventeenth-, or early eighteenth-century date.

The collection included a good group of complete clay pipes from the nineteenth century. The most notable of these are as follows:

- C.CROP LONDON pipe, registration number 373036. Stub-stemmed Duchess of Devonshire complete with vulcanite mouthpiece; good condition; smoked.
- 1965.40.3 – RAOB with leaf decorated stems; turquoise tip; Southorn/Broseley 24 stem stamp.
- 1965.40.10 – Hussars pipe; turquoise tip; Broseley 24 stem mark; stem broken and repaired.
- 1965.40.7 – Burns cutty pipe; turquoise tip; Broseley 24 stem mark.
- 1965.40.8 – Small thorn design; Broseley 24 stamp; turquoise tip; stem broken and repaired.
- 1965.40.1 – Acorn bowl with branch spur/ Southorn stamp; turquoise tip.
- 1965.40.6 – Plain bowl with oval stem and Broseley 24 stamp; turquoise tip.
- 1965.40.5 – Plain spur bowl with deep moulded milling; Broseley 24 stamp and turquoise tip.
- 1972.19.11a – TW facing; heart with Erin under on left-hand side and hatched heart on right-hand side; complete; no tip coat; mould number on left-hand side but this is unclear.
- 1972.19.11b – Hatched shamrock on left-hand side with “vine” under; harp on right-hand side; leaf on heel; 151 on left-hand side of stem.
- 1972.19.11c – Lion and unicorn with shield and arms; mould 157 on left-hand side.
- Two complete pipes with metal covers and SCOTLAND on right-hand side of stem.
- 1965.584 – complete football cadger pipe; registration number 241693
- 1964.368 – complete lades head with bonnet pipe
- 1964.366 – complete pipe with Legs of Man motif; moulded milling; turquoise tip; mould number 602 on left-hand side of stem.
- 1964.360 – Complete plain spurless bowl
- Complete churchwarden type with moulded stem twist and brown-varnished tip.
- Three Pollock pipes with yellow tips.



- 5.01 Spur type bowl dating from c1610-1640 from Dalden Tower (Acc No. DAL 89 A415); rim bottered but not milled. (Pcode 07173).
- 5.02 Heel type bowl dating from c1640-1660 from Dalden Tower (Acc No. DAL 88 A185); average burnish; rim bottered and fully milled. (Pcode 07165).
- 5.03 Heel type bowl dating from c1640-1670 from Dalden Tower (Acc No. DAL 86 A032); rim bottered and fully milled. (Pcode 07156).
- 5.04 Heel type bowl dating from c1640-1670 from Esp Green (Acc No. ESG 79 J2); rim bottered but not milled. (Pcode 07182).
- 5.05 Heel type bowl dating from c1660-1680 from Dalden Tower (Acc No. DAL 87 A113); rim bottered but not milled. (Pcode 07159).
- 5.06 Heel type bowl dating from c1660-1680 from Esp Green (Acc No. ESG 79 J2); rim bottered but not milled. (Pcode 07181).
- 5.07 Heel type bowl dating from c1670-1680 from Easington (Acc No. ESH 89); rim bottered and half milled. From east wing, south turret. (Pcode 07180).
- 5.08 Heel type bowl dating from c1660-1680 from Dalden Tower (Acc No. DAL 88 A207); rim wiped; milled on all surviving rim. (Pcode 07167)
- 5.09 Heel type bowl dating from c1680-1710 from Dalden Tower (Acc No. DAL 85 A016); rim bottered but not milled. Marked with the initials HI on the sides of the heel. (Pcode 07138).
- 5.10 Heel type bowl dating from c1680-1710 from Dalden Tower (Acc No. DAL 87 A083); rim wiped but not milled. (Pcode 07158).
- 5.11 Heel type bowl dating from c1680-1710 from Dalden Tower (Acc No. DAL 89 A043). (Pcode 07169).
- 5.12 Heel type bowl dating from c1680-1710 from Dalden Tower (Acc No. DAL A015). Marked with the initials HI on the sides of the heel. (Pcode 07174).
- 5.13 Heel type bowl dating from c1690-1710 from Dalden Tower (Acc No. DAL 88 A165); rim bottered but not milled. Groove ?created by bottering tool, around all surviving rim. (Pcode 07161).
- 5.14 Heel type bowl dating from c1680-1710 from Dalden Tower (Acc No. DAL 88 A164). Marked with a star on the sides of the heel. (Pcode 07160).
- 5.15 Heel type bowl dating from c1690-1740 from Dalden Tower (Acc No. DAL 85 A016); rim internally trimmed and cut but not milled. (Pcode 07139).
- 5.16 Heel type bowl dating from c1690-1740 from Dalden Tower (Acc No. DAL 85 A016); rim cut but not milled. (Pcode 07142).

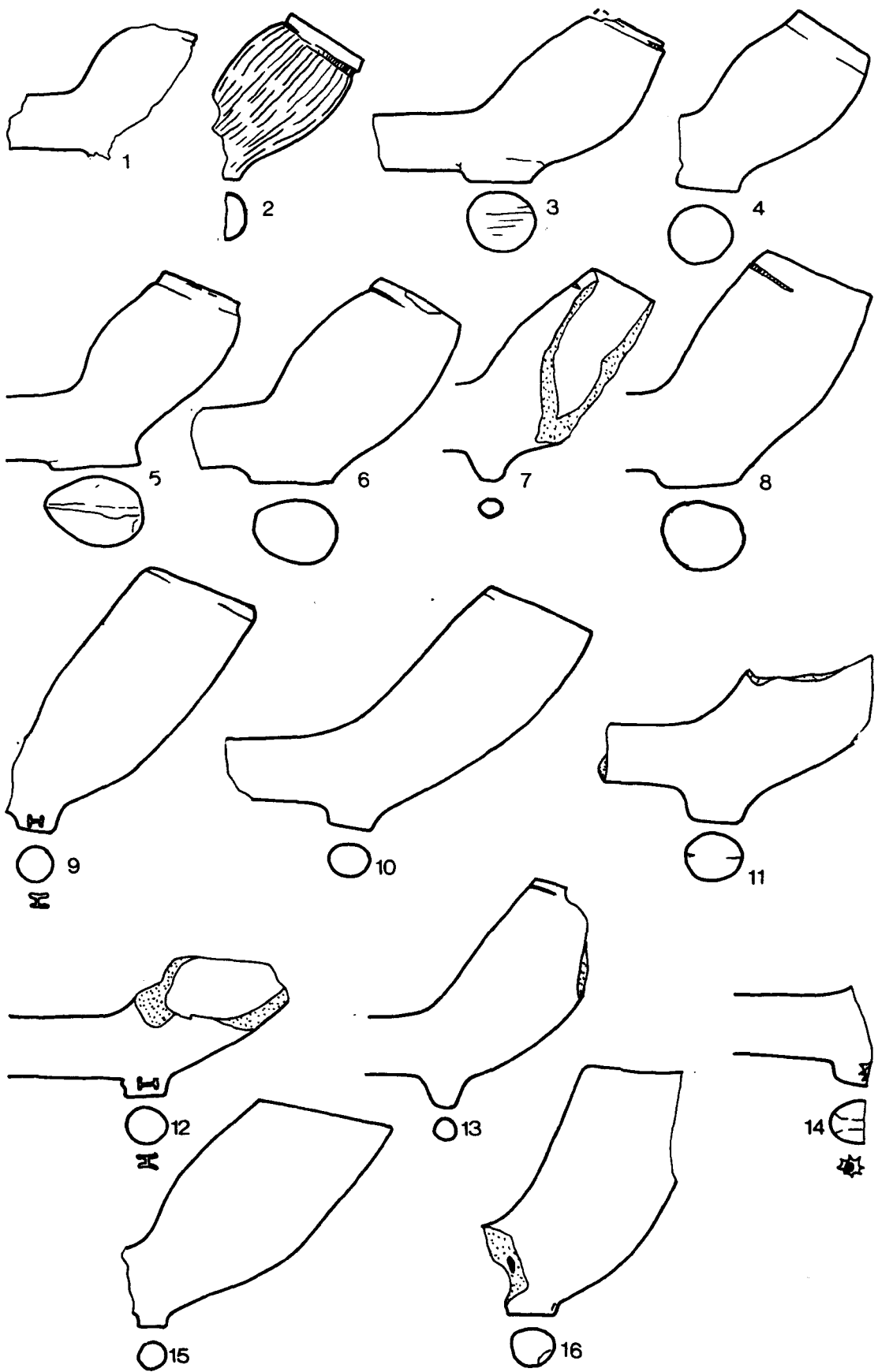
- 6.01 Heel type bowl dating from c1690-1740 from Dalden Tower (Acc No. DAL 85 A016); rim wiped but not milled. Spur appears to have been broken off and scar trimmed. (Pcode 07140).
- 6.02 Heel type bowl dating from c1700-1770 from Dalden Tower (Acc No. DAL 85 A016); rim internally trimmed and cut but not milled. Marked with the initials IH on the sides of the heel. (Pcode 07137).
- 6.03 Heel type bowl dating from c1700-1770 from Dalden Tower (Acc No. DAL 85 A016); rim cut but not milled. Marked with the initials HI on the sides of the heel. (Pcode 07141).
- 6.04 Heel type bowl dating from c1700-1770 from Dalden Tower (Acc No. DAL 89 A356); rim cut but not milled. Marked with the initials HH on the sides of the heel. (Pcode 07170).
- 6.05 Heel type bowl dating from c1700-1770 from Dalden Tower (Acc No. DAL 85 A016); rim cut but not milled. Marked with the initials IH on the sides of the heel. (Pcode 07143).
- 6.06 Heel type bowl dating from c1700-1770 from Dalden Tower (Acc No. DAL 88 A286). Marked with the initials HH on the sides of the heel. (Pcode 07168).
- 6.07 Heel type bowl dating from c1700-1770 from Dalden Tower (Acc No. DAL 29 (016)); rim cut but not milled. Marked with the initials HH/I on the sides of the heel; milled stem. Possible repair to stem that has been disguised by milled decoration. (Pcode 07136).
- 6.08 Heel type bowl dating from c1600-1699 from Dalden Tower (Acc No. DAL 88 A165); (Pcode 07162).
- 6.09 Stem fragment with milled decoration dating from the 17<sup>th</sup> or 18<sup>th</sup> century from Dalden Tower (Acc No. DAL 016 Sf. 29).
- 6.10 Stem fragment with milled decoration dating from the 17<sup>th</sup> or 18<sup>th</sup> century from Dalden Tower (Acc No. DAL89.A358 Sf. 305).
- 6.11 Stem fragment with milled decoration dating from the 17<sup>th</sup> or 18<sup>th</sup> century from Dalden Tower (Acc No. DAL 016 Sf. 29).
- 6.12 Stem fragment with milled decoration dating from the 17<sup>th</sup> or 18<sup>th</sup> century from Dalden Tower (Acc No. DAL88.A206).
- 6.13 Bowl dating from c1680-1740 from Dalden Tower (Acc No. DAL 86 A037); Marked with the initials HH on the sides of the stem. Lettering in sans serif script. (Pcode 07157).

- 7.01 Heel type bowl dating from c1610-1640 from Middle Chare, Chester-le-Street (Acc No. CLS A38 5); rim bottered and fully milled; bore 8/64". (Pcode 07316).
- 7.02 Heel type bowl dating from c1610-1640 from Middle Chare, Chester-le-Street (Acc No. CLS A37 1); rim bottered; milled on all surviving rim; bore 8/64". (Pcode 07295).
- 7.03 Heel type bowl dating from c1640-1660 from Middle Chare, Chester-le-Street (Acc No. CLS A34 1); rim bottered but not milled; bore 8/64". (Pcode 07292).
- 7.04 Heel type bowl dating from c1640-1660 from Middle Chare, Chester-le-Street (Acc No. CLS A50 1); rim bottered and fully milled; bore 7/64". (Pcode 07321).
- 7.05 Heel type bowl dating from c1650-1675 from Middle Chare, Chester-le-Street (Acc No. CLS A37 3); rim bottered; three quarters milled; bore 8/64". (Pcode 07297).
- 7.06 Heel type bowl dating from c1660-1680 from Middle Chare, Chester-le-Street (Acc No. CLS A38 20); rim bottered; milled on all surviving rim; bore 7/64". Marked with the initials WS on the heel Similar to a London Type 13. (Pcode 07309).
- 7.07 Heel type bowl dating from c1650-1675 from Middle Chare, Chester-le-Street (Acc No. CLS A38 21); rim bottered but not milled; bore 6/64". Similar to a London Type 13. (Pcode 07310).
- 7.08 Heel type bowl dating from c1640-1670 from Middle Chare, Chester-le-Street (Acc No. CLS A37 2); rim bottered and fully milled; bore 7/64". Similar to a London Type 13. (Pcode 07296).
- 7.09 Heel type bowl dating from c1660-1680 from Middle Chare, Chester-le-Street (Acc No. CLS A13 1); rim bottered but not milled; bore 7/64". Similar to a London Type 13. (Pcode 07287).
- 7.10 Heel type bowl dating from c1660-1680 from Middle Chare, Chester-le-Street (Acc No. CLS A38 22); rim bottered but not milled; bore 7/64". Similar to a London Type 13. (Pcode 07311).
- 7.11 Heel type bowl dating from c1680-1710 from Middle Chare, Chester-le-Street (Acc No. CLS A1 13); rim bottered but not milled; bore 5/64". Similar to a London Type 13. (Pcode 07271).
- 8.01 Heel type bowl dating from c1625-1650 from Piercebridge general (Acc No. PB/HS77 22.9 GT); rim bottered but not milled; stem bore 7/64". Bag labelled PB/HS77 (GT)/1. (Pcode 07227).

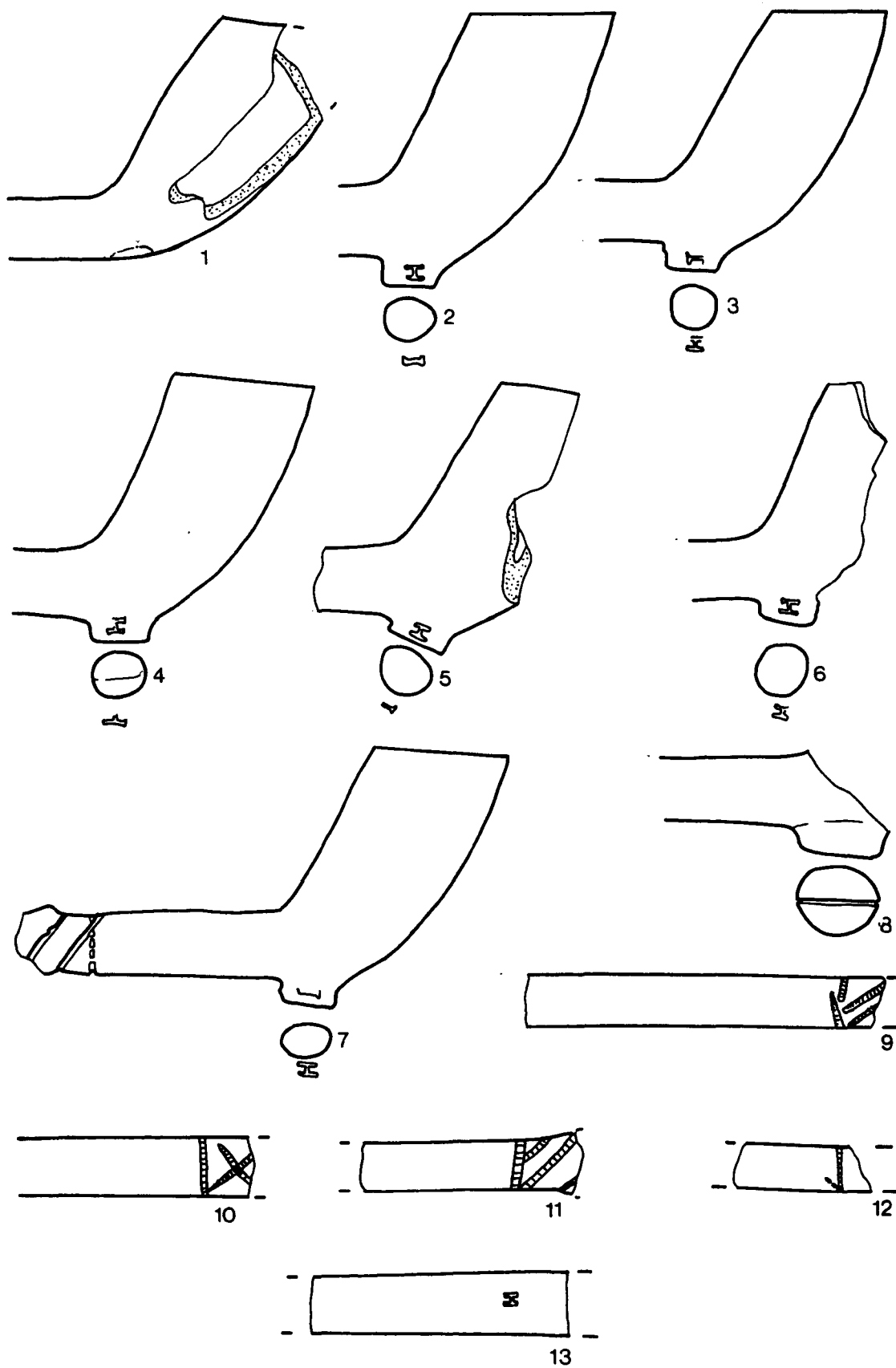
- 8.02 Heel type bowl dating from c1645-1660 from Piercebridge general (Acc No. PB/HS77 25.1 AT2); rim bottered but not milled; stem bore 7/64". Marked with the initials I?G on the heel. Possible John Grayson of Newcastle; bag labelled PB/HS77 (AT)/8. (Pcode 02123).
- 8.03 Heel type bowl dating from c1650-1670 from Piercebridge general (Acc No. PB/TV78 22.4 AS); rim bottered and three quarters milled; stem bore 7/64". Bag labelled PB/TV78 (AS)/2. (Pcode 07246).
- 8.04 Heel type bowl dating from c1640-1670 from Piercebridge general (Acc No. PB/HS 78 17.4 PP); rim bottered and fully milled; stem bore 7/64". Bag labelled PB/HS78(PP)/1. (Pcode 07223).
- 8.05 Heel type bowl dating from c1640-1670 from Piercebridge general (Acc No. PB/HS 77 26.3 AT2); average burnish; rim bottered and fully milled; stem bore 8/64". Bag labelled PB/HS77 (AT)/4. (Pcode 07222).
- 8.06 Heel type bowl dating from c1660-1680 from Piercebridge general (Acc No. PB/GV76 (38) 2B); rim bottered but not milled; stem bore 6/64". York Type 9; bag labelled PB/GV76 (38)/1. (Pcode 07204).
- 8.07 Heel type bowl dating from c1660-1680 from Piercebridge general (Acc No. PB/HS78 12.7 PX); good burnish; rim bottered but not milled. Marked with the initials I? on the heel. Similar to a York type 9; bag labelled PB/HS78 (PX)/1. (Pcode 02124).
- 8.08 Heel type bowl dating from c1650-1670 from Piercebridge general (Acc No. PB/GV76 (38) 2B); rim bottered and three quarters milled; stem bore 8/64". Bag labelled PB/GV76 (38)/3. (Pcode 07203).
- 8.09 Heel type bowl dating from c1650-1670 from Piercebridge general (Acc No. PB/GV76 (38) 2B); rim bottered and half milled; stem bore 6/64". Marked with the initials IB on the heel. Bag labelled PB/GV76 (38)/2. (Pcode 02121).
- 8.10 Heel type bowl dating from c1660-1680 from Piercebridge general (Acc No. PB/TT77 20.7 C2); rim bottered but not milled; stem bore 7/64". Bowl badly abraded; bag labelled PB/TT88 (C)/3. (Pcode 07245).
- 8.11 Heel type bowl dating from c1660-1680 from Piercebridge general (Acc No. PB/GV76 (8) C); rim bottered and one quarter milled; stem bore 8/64". York Type 10; bag labelled PB/GV76 (8)/3. (Pcode 07214).
- 8.12 Heel type bowl dating from c1660-1680 from Piercebridge general (Acc No. PB/HS77 8.3 AQ); rim bottered and milled around all of the surviving rim; stem bore 7/64". Bag labelled PB/HS77 (AQ)/2. (Pcode 07233).
- 8.13 Heel type bowl dating from c1660-1680 from Piercebridge general (Acc No. PB/GV76 (52) 2A); rim bottered and half milled; stem bore 6/64". Bag labelled PB/GV76 (52)/2. (Pcode 07209).

- 8.14 Spur type bowl dating from c1650-1680 from Piercebridge general (Acc No. PB/GV76 (16) 2B); rim bottered and one quarter milled; stem bore 7/64". Spur type; Tyneside type 6; bag labelled PB/GV76 (16)/16. (Pcode 07188).
- 9.01 Spur type bowl dating from c1650-1680 from Piercebridge general (Acc No. PB/GV76 (38) 2B); rim bottered and one quarter milled; stem bore 7/64". Spur type; Tyneside type 6; bag labelled PB/GV76(38)/5. (Pcode 07202).
- 9.02 Spur type bowl dating from c1660-1680 from Piercebridge general (Acc No. PB/GV76 (16)/9); rim bottered and three quarters milled; stem bore 7/64". Marked with a dot on the sides of the bowl. Similar to Tyneside type 8; raised dot on LHS of bowl. (Pcode 07200).
- 9.03 Spur type bowl dating from c1650-1680 from Piercebridge general (Acc No. PB/GV76 (16) 2B); rim bottered but not milled; stem bore 7/64". Marked with a dot on the sides of the bowl. Tyneside type 6; bag labelled PB/GV76 (16)/8. (Pcode 07189).
- 9.04 Heel type bowl dating from c1680-1720 from Roman Fort (Church Chare) (Acc No. CC90 41); stem bore 6/64". No rim. (Pcode 07267).
- 9.05 Heel type bowl dating from c1680-1740 from Piercebridge general (Acc No. PB/ER77 1/5); Marked with a star above the initial R on the side of the heel. Tyneside form and mark. (Pcode 25323).
- 9.06 Heel type bowl dating from c1680-1710 from Roman Fort (Church Chare) (Acc No. CC90 216); stem bore 7/64". Marked with the initials MP on the sides of the heel. No rim. (Pcode 07263).
- 9.07 Heel type bowl dating from c1680-1710 from Piercebridge general (Acc No. PB/TT77 9.8 C(5)); rim bottered but not milled; stem bore 5/64". Stem has part of a Tyneside stem stamp; bag labelled PB/TT77 (C)/4. (Pcode 02130).
- 9.08 Heel type bowl dating from c1680-1710 from Roman Fort (Church Chare) (Acc No. CC90 2); rim internally trimmed and bottered but not milled; stem bore 6/64". Marked with the initials MP on the sides of the heel. (Pcode 07254).
- 9.09 Heel type bowl dating from c1680-1710 from Roman Fort (Church Chare) (Acc No. CC90 2); rim bottered but not milled; stem bore 6/64". Marked with the initials MP on the sides of the heel. (Pcode 07255).
- 9.10 Heel type bowl dating from c1680-1710 from Roman Fort (Church Chare) (Acc No. CC90 2); rim bottered but not milled; stem bore 5/64". Marked with the initials IH on the sides of the heel. (Pcode 07257).
- 9.11 Spur type bowl dating from c1690-1710 from Roman Fort (Church Chare) (Acc No. CC90 2); rim bottered and one quarter milled; stem bore 7/64". (Pcode 07256).

- 9.12 Spur type bowl dating from c1690-1710 from Roman Fort (Church Chare) (Acc No. CC90 25); rim bottered and half milled; stem bore 6/64". (Pcode 07264).
- 10.01 Spur type bowl dating from c1690-1710 from Roman Fort (Church Chare) (Acc No. CC90 2); rim bottered but not milled; stem bore 5/64". Very shiny surface but not burnished. (Pcode 07253).
- 10.02 Spur type bowl dating from c1690-1710 from Roman Fort (Church Chare) (Acc No. CC90 2); rim bottered and half milled; stem bore 6/64". (Pcode 07252).
- 10.03 Heel type bowl dating from c1680-1720 from Roman Fort (Church Chare) (Acc No. CC90 2); rim bottered but not milled; stem bore 6/64". Marked with the initials MP on the sides of the heel. (Pcode 07258).
- 10.04 Heel type bowl dating from c1700-1770 from Roman Fort (Church Chare) (Acc No. CC90 2); stem bore 6/64". Marked with the initials IG/C on the sides of the heel. No rim. (Pcode 07251).
- 10.05 Spur type bowl dating from c1740-1800 from Roman Fort (Church Chare) (Acc No. CC90 58); stem bore 5/64". Marked with the initials IH on the sides of the spur. No rim. (Pcode 07269).
- 10.06 Heel type bowl dating from c1650-1680 unprovenanced material; rim bottered but not milled; stem bore 6/64". (Pcode 07135).

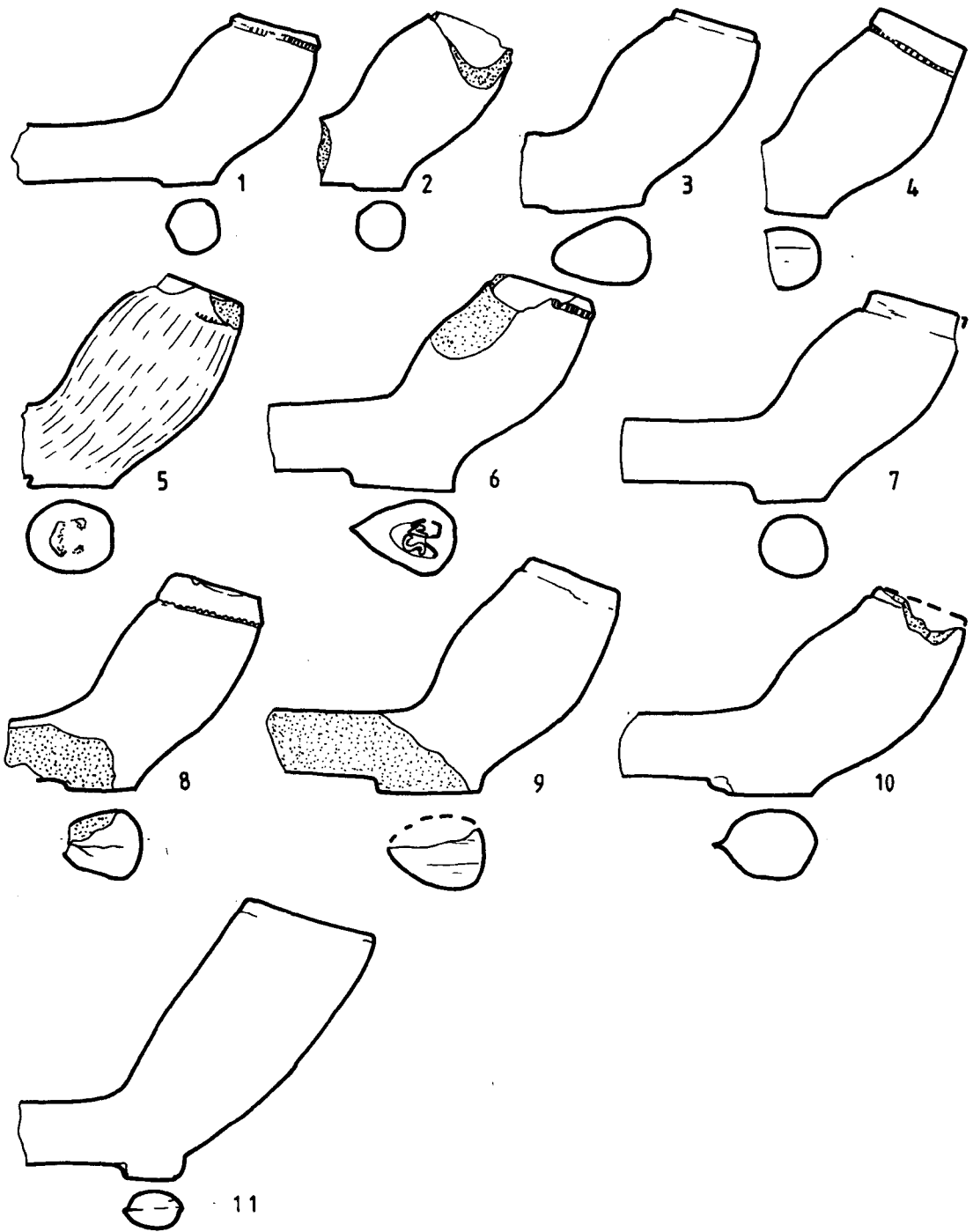


**Figure 5:** Pipes from the collections of the Bowes Museum, Barnard Castle. Scale 1:1.

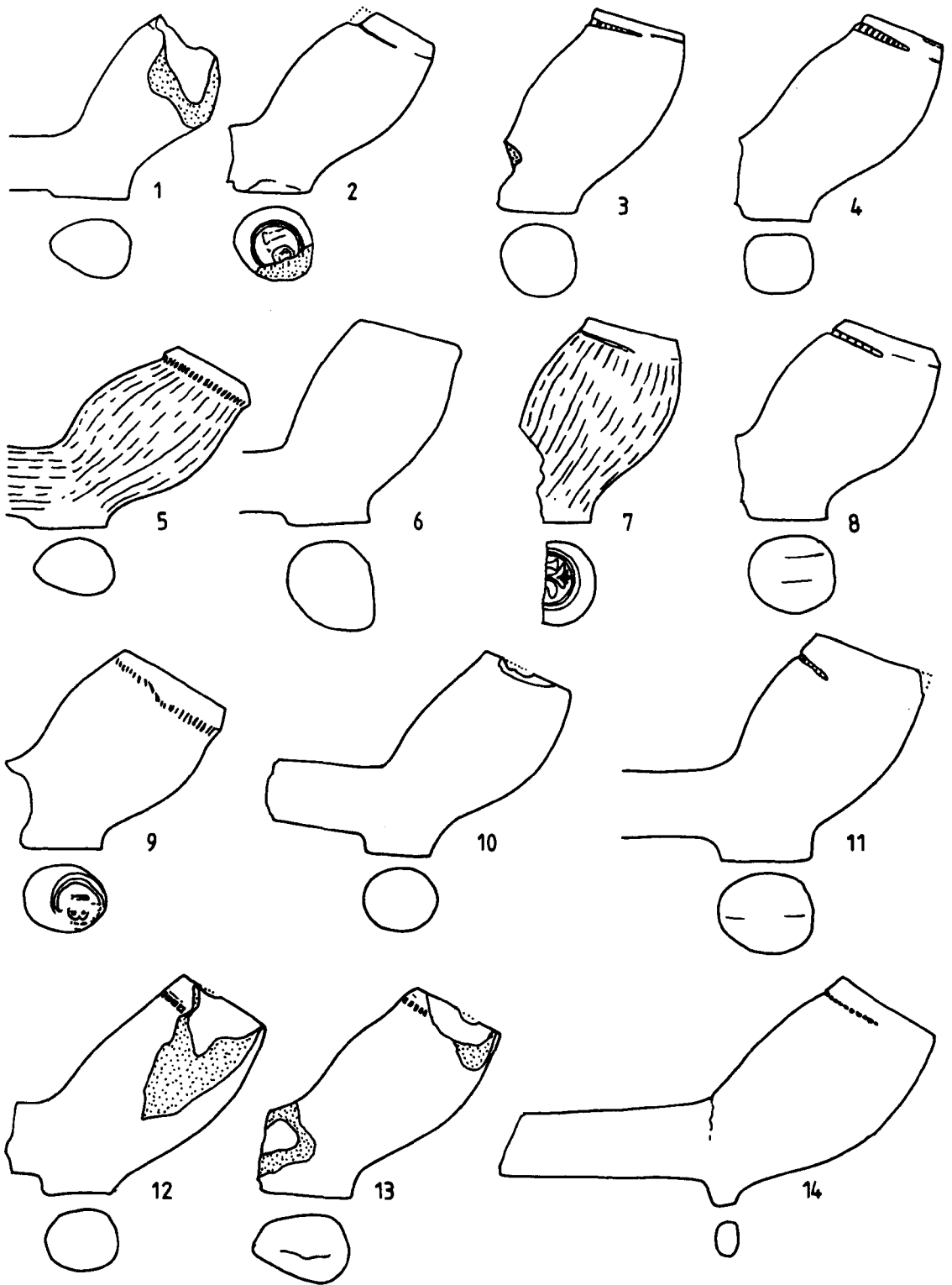


**Figure 6:** Pipes from the collections of the Bowes Museum, Barnard Castle. Scale 1:1.

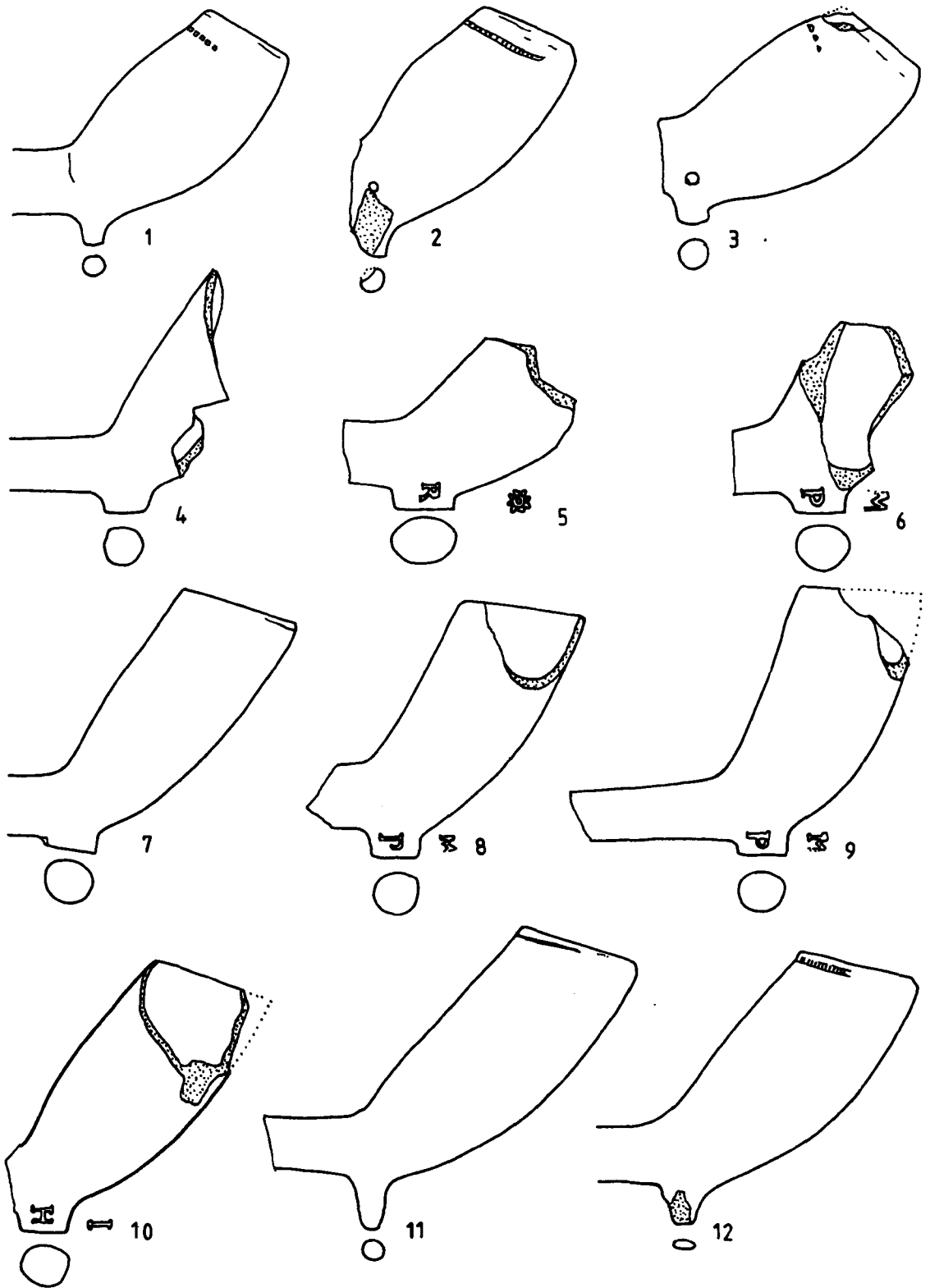




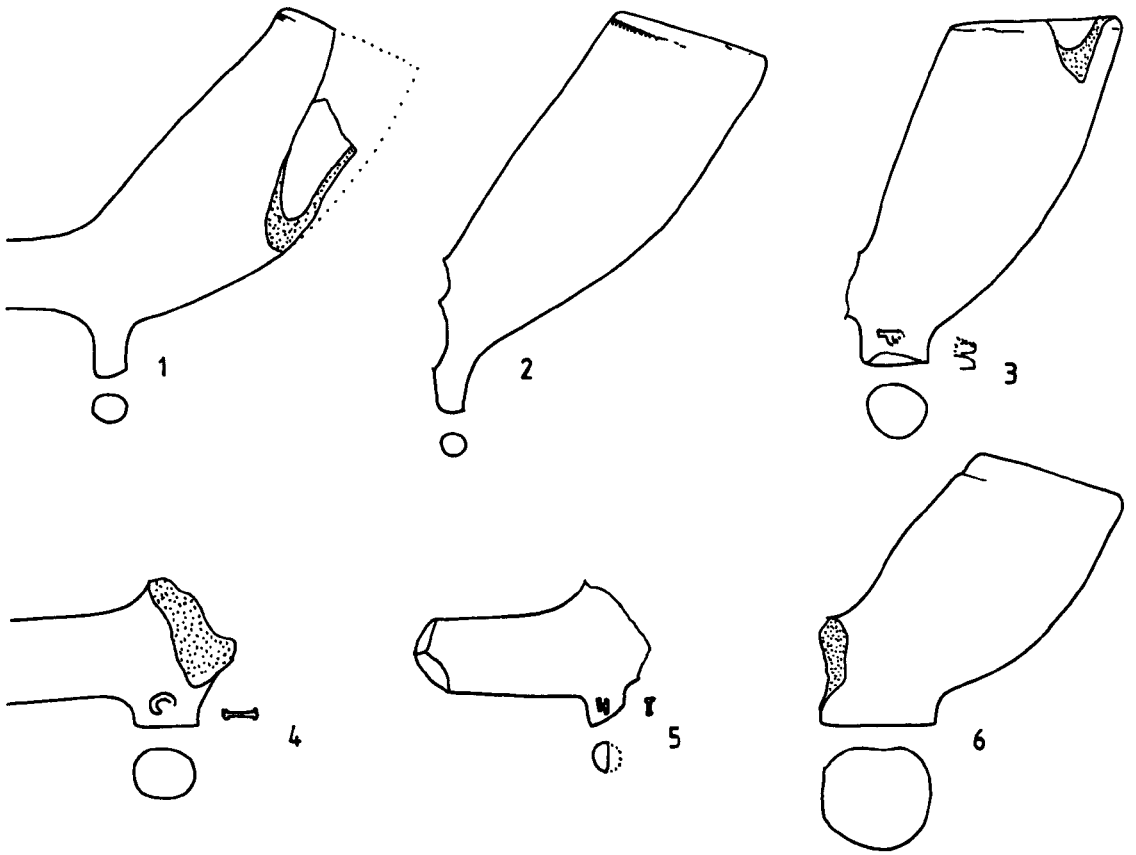
**Figure 7:** Pipes from the collections of the Bowes Museum, Barnard Castle. Scale 1:1.



**Figure 8:** Pipes from the collections of the Bowes Museum, Barnard Castle. Scale 1:1.



**Figure 9:** Pipes from the collections of the Bowes Museum, Barnard Castle. Scale 1:1.



**Figure 10:** Pipes from the collections of the Bowes Museum, Barnard Castle. Scale 1:1.

**Collection Name:** Sewerby Hall  
**Collection Code:** 0158  
**Contact Name:** Ms Moya O'Mullane  
**Address:** Bridlington, East Riding of Yorkshire

**Description:**

Collection recorded 5<sup>th</sup> June 1998. The collection consisted of a range of pipes from the seventeenth through to the nineteenth and early twentieth centuries. Also in the collection were a set of pipe moulds and a branding iron marked 'R Goforth'. A total of 29 bowls dating from the seventeenth and eighteenth century were recorded in detail for the Yorkshire Database. Of the remaining collection the most notable items are as follows:

- 1993/1011-1024 – bags of nineteenth-century kiln waste from New Pasture Lane, Bridlington. This includes a large number of wasted bowls studied by Earnshaw.
- Pieces of clay sheet smeared on paper, which would have been used to place over the pipes to protect them from discolouring fumes during firing.
- Large collection of un-glazed nipple mouthpieces.
- Large collection of cut mouthpieces glazed a pale yellow/green.
- 1998/34.39 – Stub stem socket pipe dating from c1840-1900 marked L.AIGUIER MARSEILLE.
- Turkish chibouk (cup and saucer type pipe).
- 1998/34.39 – Large and coarsely made socket of an ethnic pipe
- Terracotta stub stem pipe modelled as a horse's head, possibly South European.
- Ethnic stone pipe in the form of a bird.
- Two footballer cadgers, one with a repaired stem one with a broken stem.
- A number of pipe moulds including four churchwardens.

11.01 Heel type bowl dating from c1650-1670 from Sewerby Road, opposite the priory (Acc No. 1993/1032); rim bottered and three quarters milled; stem bore 6/64". This pipe has been published - Earnshaw 1988. (Pcode 08130).

11.02 Heel type bowl dating from c1660-1690 from Chapel Street (Acc No. 1993/476); rim internally trimmed and bottered and three quarters milled; stem bore 8/64". (Pcode 08120).

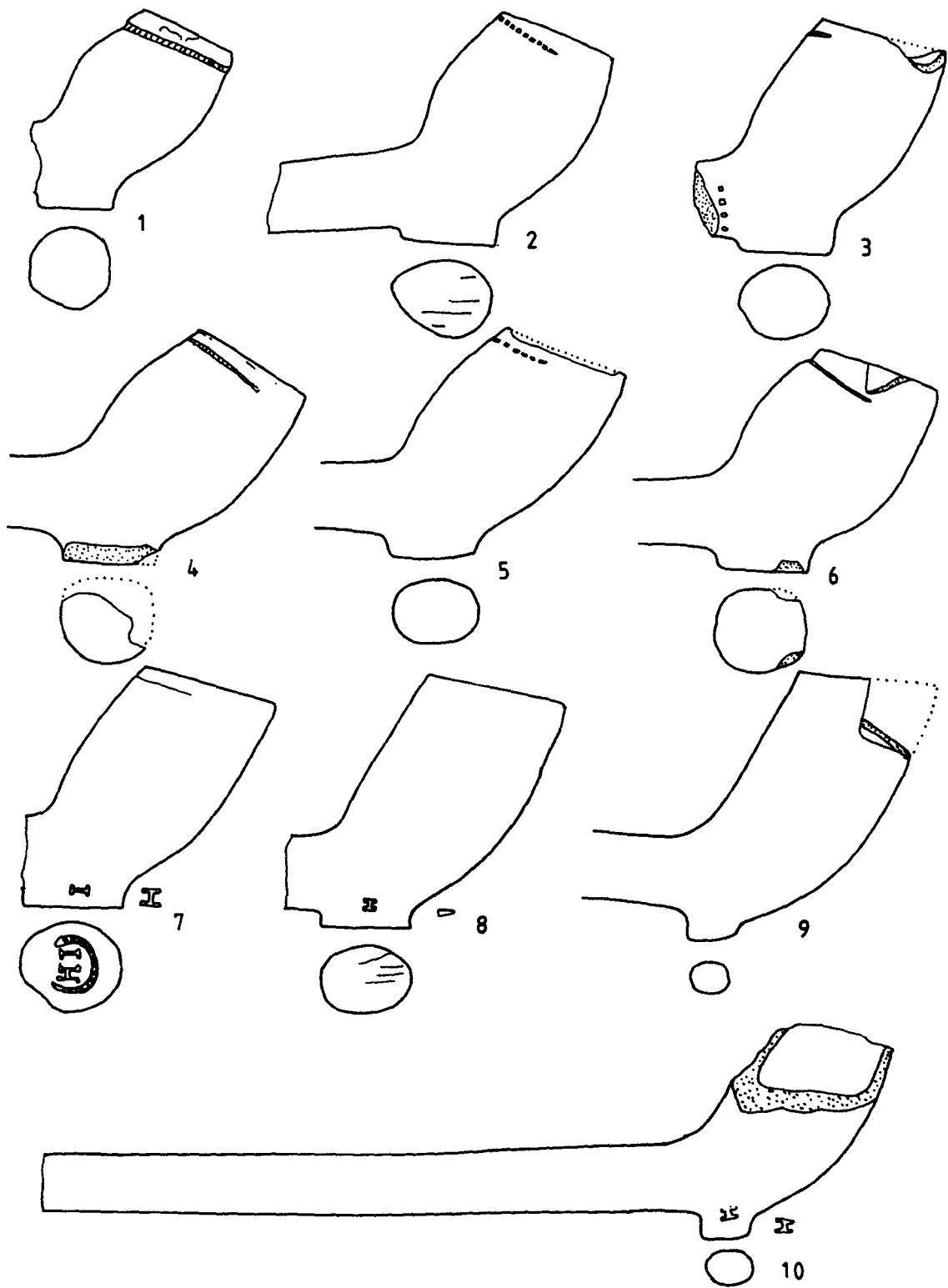
11.03 Heel type bowl dating from c1660-1700 from the Old Town (Acc No. 1993/1027); milled around all of the surviving rim; stem bore 6/64". Milled spur. (Pcode 08129).

11.04 Heel type bowl dating from c1660-1700 from Eastern Road Allotments; rim bottered and one quarter milled; stem bore 8/64". Hull Type 2G; found in field behind former Eastern Road allotments. (Pcode 08121).

11.05 Heel type bowl dating from c1670-1700 from Spring Bank Lane (Acc No. 1993/743 A.51.89); rim bottered and three quarters milled; stem bore 6/64". (Pcode 08131).

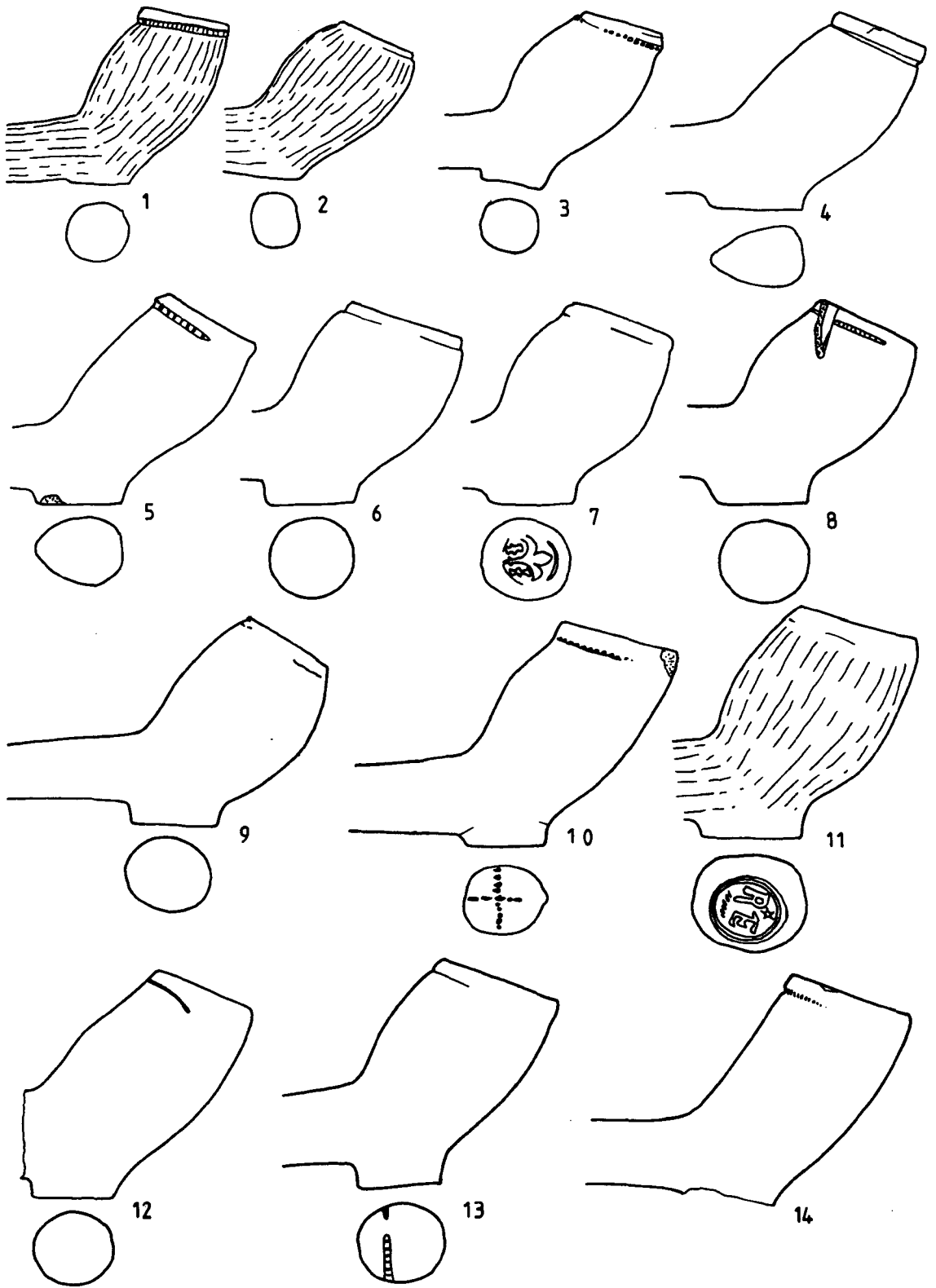
- 11.06 Heel type bowl dating from c1660-1680 from Kirkgate (Acc No. 1993/928 KB80 A5 (19)); rim bottered but not milled; stem bore 5/64". (Pcode 08123).
- 11.07 Heel type bowl dating from c1680-1710 from Kirkgate (Acc No. 1993/944); rim bottered but not milled; stem bore 6/64". Marked with the initials IH on the heel, plus moulded HI on sides of heel. This pipe has been published - Earnshaw 1988. (Pcode 02083).
- 11.08 Heel type bowl dating from c1680-1710 from Kirkgate (Acc No. 1993/945 KB40 A4); rim cut but not milled; stem bore 6/64". Marked with the initials IH on the sides of the heel. This pipe has been published - Earnshaw 1988. (Pcode 08128).
- 11.09 Heel type bowl dating from c1700-1770 from Kirkgate (Acc No. 1993/941 KB80 A4 F4); rim cut but not milled; stem bore 5/64". Marked with the initials H? on the sides of the heel. (Pcode 08124).
- 11.10 Heel type bowl dating from c1700-1770 from Kirkgate (Acc No. 1993/941 KB80 A6 F4); stem bore 5/64". Marked with the initials HH on the sides of the heel. No rim surviving. (Pcode 08125).
- 12.01 Heel type bowl dating from c1640-1660 unprovenanced material from Beverley (Acc No. 37); good burnish; rim bottered and fully milled; stem bore 8/64". (Pcode 08108).
- 12.02 Heel type bowl dating from c1640-1660 unprovenanced material from Beverley (Acc No. 37); average burnish; rim bottered but not milled; stem bore 8/64". (Pcode 08110).
- 12.03 Heel type bowl dating from c1640-1660 unprovenanced material from Beverley (Acc No. 37); rim bottered and fully milled; stem bore 7/64". (Pcode 08109).
- 12.04 Heel type bowl dating from c1640-1670 unprovenanced material from Beverley (Acc No. 37); rim bottered but not milled; stem bore 7/64". (Pcode 08111).
- 12.05 Heel type bowl dating from c1660-1680 unprovenanced material from Beverley (Acc No. 37); rim bottered and half milled; stem bore 6/64". (Pcode 08112).
- 12.06 Heel type bowl dating from c1660-1680 unprovenanced material from Beverley (Acc No. 37); rim bottered but not milled; stem bore 8/64". (Pcode 08113).
- 12.07 Heel type bowl dating from c1660-1680 unprovenanced material from Beverley (Acc No. 37); rim internally trimmed and bottered but not milled; stem bore 6/64". Marked with the initials II flanking a fleur-de-lys on the heel; very highly fired ?waster. (Pcode 02084).

- 12.08 Heel type bowl dating from c1660-1680 unprovenanced material from Beverley (Acc No. 37); rim bottered and half milled; stem bore 7/64". (Pcode 08115).
- 12.09 Heel type bowl dating from c1660-1680 unprovenanced material from Beverley (Acc No. 37); rim bottered but not milled; stem bore 6/64". Labelled "This is a danes pipe dug up in Friars Lane Feb 28/80 bought for."; ?waster. (Pcode 08117).
- 12.10 Heel type bowl dating from c1670-1680 unprovenanced material from Beverley (Acc No. 37); rim bottered and three quarters milled; stem bore 6/64". Milled heel. (Pcode 08116).
- 12.11 Heel type bowl dating from c1660-1700 from Cowlam (Acc No. 1997/205; SF no. CV SC Q3 52 Tr 2(3)); good burnish; rim bottered but not milled; stem bore 8/64". Marked with the initials RE on the heel. (Pcode 02082).
- 12.12 Heel type bowl dating from c1670-1680 unprovenanced material from Beverley (Acc No. 37); rim bottered and half milled; stem bore 8/64". (Pcode 08114).
- 12.13 Heel type bowl dating from c1660-1690 from Cowlam (Acc No. 1997/205; SF no. CV51 Tr7 SCRIM HALF(31)); rim bottered but not milled; stem bore 7/64". Milled heel. (Pcode 08118).
- 12.14 Heel type bowl dating from c1670-1680 from Cowlam (Acc No. 1997/205); rim bottered and one quarter milled; stem bore 6/64". Heel broken. (Pcode 08119).



**Figure 11:** Pipes from the collections of the Sewerby Hall, Bridlington. Scale 1:1.





**Figure 12:** Pipes from the collections of the Sewerby Hall, Bridlington. Scale 1:1.

**Collection Name:** Humber Archaeology Partnership  
**Collection Code:** 0137  
**Contact Name:** David H Evans  
**Address:** Kingston upon Hull, East Riding of Yorkshire

**Description:**

Collection recorded on 7<sup>th</sup>, 9<sup>th</sup> and 10<sup>th</sup> June 1999. Collection comprises a large quantity of excavated material from a number of sites in and around Hull including Beverley, Hedon and Howden. In total approximately 400 bowls and marked fragments dating from the seventeenth and eighteenth centuries were recorded in detail, no plain stems were recorded. In spite of spending three full days recording the following sites remain un-recorded HIC91, SPH98, SMM89, HIS89, HMC94, TSH96 together with the reference collection.

The collection included some later material the most notable of which is as follows:

- STK98 – Kiln waste and muffle fragments from a nineteenth-century kiln.
- HMC94 259 – Complete black Italian stub-stemmed pipe bowl.
- HMC94 – a number of nineteenth-century pipe bowls marked with local makers names including Stovin of Hull, Scott of Hull.
- HQS90 186 – Group of pipes including 3 moulded bowls one with flutes and stags head and G GOUDW.../ on the right-hand site. Also, a similar bowl with the makers name WESTERDALE.

13.01 Heel type bowl dating from c1630-1650 from Beverley Gate (Acc No. 1374.1986 HU 36); rim bottered and not milled; stem bore 6/64". (Pcode 06164).

13.02 Heel type bowl dating from c1640-1660 from Beverley Gate (Acc No. BEG88 31); rim bottered and three quarters milled. Similar to a London Type 10. (Pcode 06269).

13.03 Heel type bowl dating from c1640-1660 from Beverley Gate (Acc No. BEG88 1); rim bottered and not milled; stem bore 7/64". Highly fired. (Pcode 06169).

13.04 Heel type bowl dating from c1640-1660 from Beverley Gate (Acc No. BEG88 2); rim bottered and not milled; stem bore 7/64". Cut heel. (Pcode 06227).

13.05 Heel type bowl dating from c1640-1660 from Beverley Gate (Acc No. BEG88 216); rim bottered and not milled. (Pcode 06259).

13.06 Spur type bowl dating from c1640-1660 from Beverley Gate (Acc No. BEG88 2); rim bottered and not milled; stem bore 7/64". (Pcode 06228).

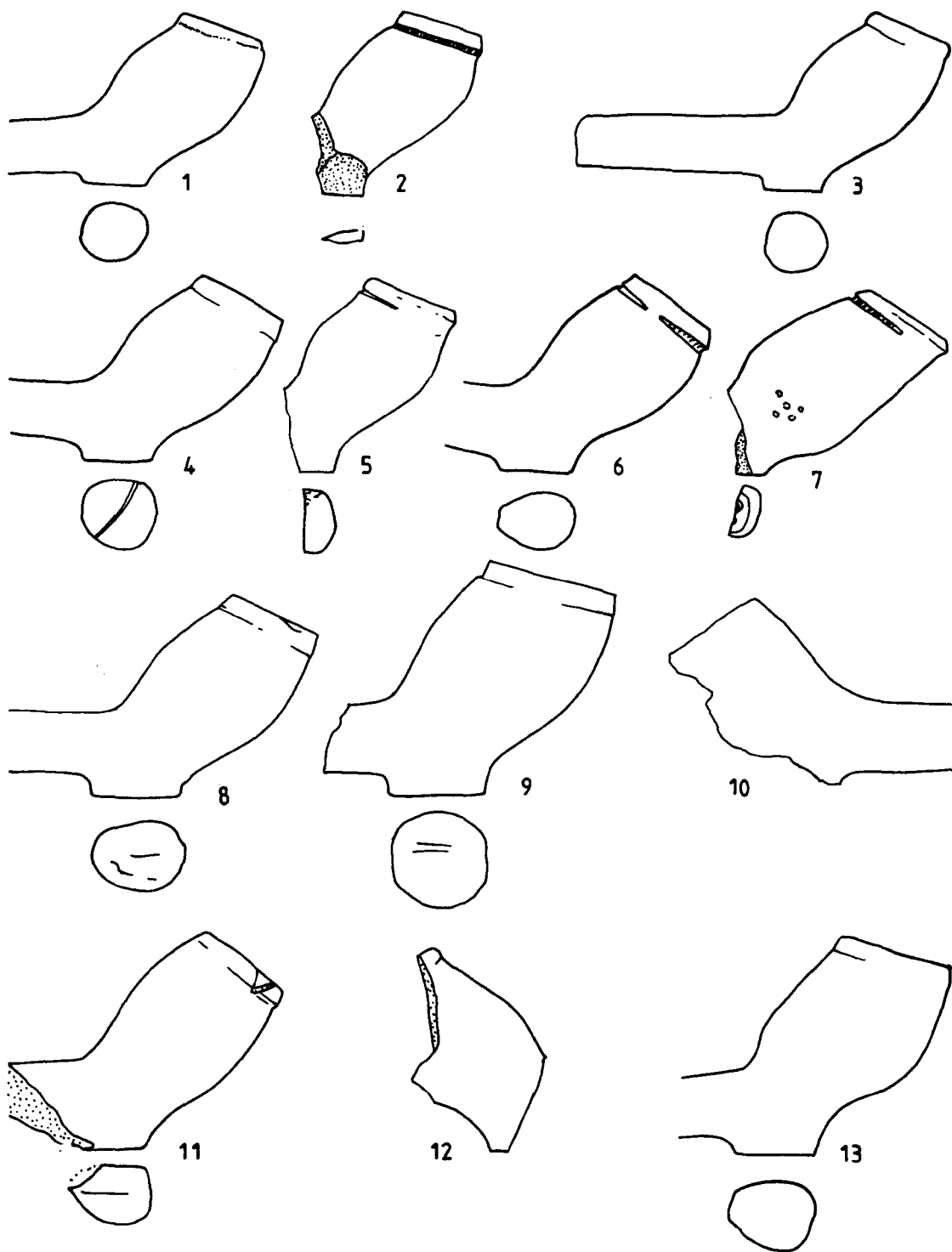
13.07 Heel type bowl dating from c1650-1680 from Beverley Gate (Acc No. BEG88 2); rim bottered and half milled. Possibly Dutch; only traces of heel stamp survive; moulded pellets on the right hand side of bowl. (Pcode 02578).

- 13.08 Heel type bowl dating from c1660-1680 from Beverley Gate (Acc No. BEG88 216); rim bottered and not milled; stem bore 7/64". (Pcode 06260).
- 13.09 Heel type bowl dating from c1660-1700 from Beverley Gate (Acc No. BEG88 216); rim bottered and not milled; stem bore 7/64". (Pcode 06261).
- 13.10 Spur type bowl dating from c1660-1690 from Beverley Gate (Acc No. BEG88 216); stem bore 8/64". (Pcode 062062).
- 13.11 Heel type bowl dating from c1660-1680 from Beverley Gate (Acc No. BEG88 1); rim bottered and not milled; stem bore 6/64". (Pcode 06172).
- 13.12 Heel type bowl dating from c1660-1680 from Beverley Gate (Acc No. BEG88 1); rim bottered and not milled. (Pcode 06173).
- 13.13 Heel type bowl dating from c1660-1680 from Beverley Gate (Acc No. BEG88 45); rim bottered and not milled; stem bore 7/64". (Pcode 06277).
- 14.01 Spur type bowl dating from c1660-1680 from Beverley Gate (Acc No. BEG88 1); rim bottered and not milled; stem bore 7/64". Spur form. (Pcode 06171).
- 14.02 Spur type bowl dating from c1660-1680 from Beverley Gate (Acc No. BEG88 1); rim bottered and not milled; stem bore 6/64". Spur form similar to London Type 15. (Pcode 06170).
- 14.03 Spur type bowl dating from c1660-1680 from Beverley Gate (Acc No. BEG88 2); rim bottered and not milled. (Pcode 06224).
- 14.04 Spur type bowl dating from c1660-1680 from Beverley Gate (Acc No. BEG88 2); rim bottered and not milled. (Pcode 06225).
- 14.05 Heel type bowl dating from c1660-1680 from Beverley Gate (Acc No. 1374.1986 HU 22); rim internally trimmed and bottered but not milled; stem bore 7/64". (Pcode 06159).
- 14.06 Spur type bowl dating from c1660-1680 from Beverley Gate (Acc No. BEG88 2); rim bottered and not milled; stem bore 7/64". (Pcode 06226).
- 14.07 Spur type bowl dating from c1740-1770 from Beverley Gate (Acc No. BEG88 116); rim cut and not milled; stem bore 4/64". (Pcode 06214).
- 14.08 Bowl dating from c1680-1710 from Beverley Gate (Acc No. 1374.1986 HU 21); rim bottered and not milled. Marked with the initials RC on the sides of the bowl. (Pcode 06156).
- 14.09 Spur type bowl dating from c1620-1650 from Bishop's Manor House (Acc No. HWN84 A 93); rim bottered and half milled; stem bore 7/64". (Pcode 06455).

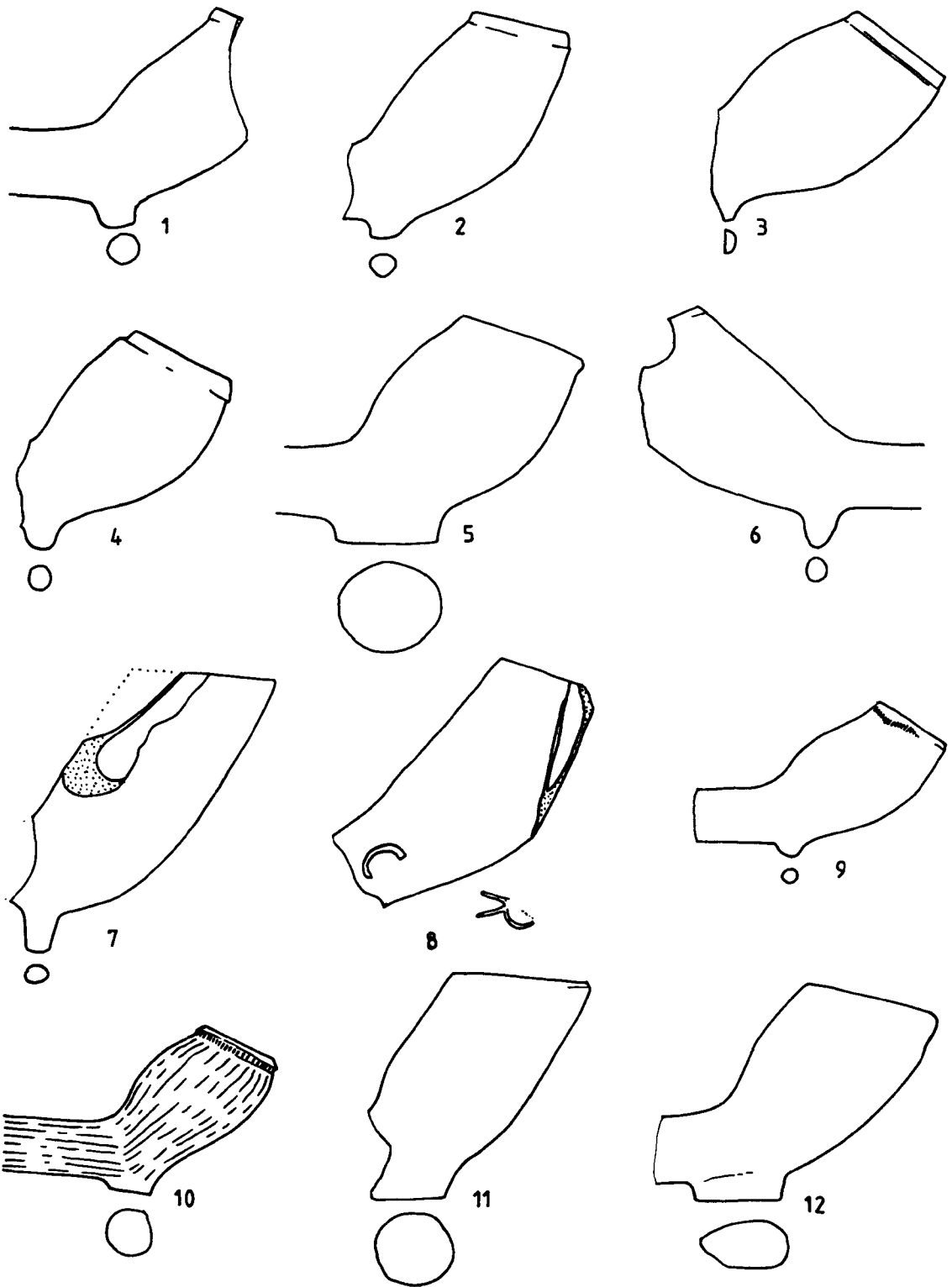
- 14.10 Heel type bowl dating from c1620-1640 from Bishop's Manor House (Acc No. HWN84 I 121); finely burnished; rim bottered and fully milled; stem bore 8/64". (Pcode 06471).
- 14.11 Heel type bowl dating from c1660-1700 from Bishop's Manor House (Acc No. HWN84); no internal bowl cross; rim bottered and one quarter milled. Smooth shiny surface. (Pcode 06453).
- 14.12 Heel type bowl dating from c1680-1710 from Bishop's Manor House (Acc No. HWN84 H 28); rim internally trimmed and bottered but not milled; stem bore 5/64". Possibly not a Yorkshire form. (Pcode 06465).
- 15.01 Heel type bowl dating from c1700-1770 from Bishop's Manor House (Acc No. HWN84 A50); rim bottered and milled around all of the surviving rim; stem bore 7/64". (Pcode 06457).
- 15.02 Spur type bowl dating from c1660-1700 from St Mary's Manor (Acc No. SMM89 60); rim bottered and not milled; stem bore 7/64". (Pcode 06482).
- 15.03 Heel type bowl dating from c1700-1770 from Iveson Close (Acc No. HIC91 U/S); rim bottered and not milled; stem bore 6/64". (Pcode 06513).
- 15.04 Heel type bowl dating from c1640-1660 from Fordyke (Acc No. FOR97 104); rim bottered and not milled; stem bore 7/64". (Pcode 06365).
- 15.05 Heel type bowl dating from c1620-1640 from High Street (Acc No. HIS99 U/S); rim bottered and fully milled; stem bore 6/64". (Pcode 06488).
- 15.06 Heel type bowl dating from c1630-1650 from High Street (Acc No. HIS99 U/S); rim bottered and fully milled; stem bore 8/64". (Pcode 06489).
- 15.07 Heel type bowl dating from c1700-1740 from High Street (Acc No. HIS99 U/S); rim bottered and not milled; stem bore 5/64". Pellets moulded on side of bowl together with part of possible moulded stem decoration. (Pcode 06487).
- 15.08 Heel type bowl dating from c1610-1640 from Kingswood (Acc No. KWH96 18); rim bottered and fully milled; stem bore 8/64". (Pcode 06388).
- 15.09 Heel type bowl dating from c1660-1700 from Kingswood (Acc No. KWH78); rim bottered and not milled; stem bore 7/64". (Pcode 06375).
- 15.10 Heel type bowl dating from c1640-1660 from Kingswood (Acc No. KWH78); rim bottered and not milled; stem bore 7/64". Cut heel. (Pcode 06378).
- 15.11 Heel type bowl dating from c1660-1700 from Kingswood (Acc No. KWH96 2); good burnish; stem bore 8/64". Marked with the initials II on the heel. 3 joining pieces; heel and part of stem only. (Pcode 02627).

- 15.12 Spur type bowl dating from c1660-1680 from North Becksde (Acc No. NBS93 U/S); rim bottered and fully milled; stem bore 6/64". (Pcode 06519).
- 15.13 Heel type bowl dating from c1630-1650 from Queen Street (Acc No. HQS90 37); finely burnished; rim bottered and fully milled; stem bore 8/64". Possibly Dutch. (Pcode 06393).
- 15.14 Heel type bowl dating from c1640-1660 from Queen Street (Acc No. HQS90 150); milled around all of the surviving rim; stem bore 6/64". Very black; rim badly damaged, heart shaped heel. (Pcode 06391).
- 16.01 Heel type bowl dating from c1640-1670 from Queen Street (Acc No. HQS90 U/S); rim bottered and not milled; stem bore 7/64". (Pcode 06435).
- 16.02 Spur type bowl dating from c1650-1670 from Queen Street (Acc No. HQS90 U/S); rim bottered and one quarter milled; stem bore 7/64". (Pcode 06437).
- 16.03 Heel type bowl dating from c1660-1700 from Queen Street (Acc No. HQS90 95); rim bottered and not milled; stem bore 7/64". Cut heel. (Pcode 06404).
- 16.04 Spur type bowl dating from c1660-1680 from Queen Street (Acc No. HQS90 98); rim bottered and three quarters milled; stem bore 6/64". (Pcode 06426).
- 16.05 Spur type bowl dating from c1660-1680 from Queen Street (Acc No. HQS90 98); rim bottered and not milled; stem bore 6/64". (Pcode 06409).
- 16.06 Heel type bowl dating from c1660-1700 from Queen Street (Acc No. HQS90 U/S); rim bottered and half milled; stem bore 7/64". Milled heel. Burnt. (Pcode 06436).
- 16.07 Spur type bowl dating from c1660-1675 from Queen Street (Acc No. HQS90 U/S); rim bottered and not milled; stem bore 7/64". (Pcode 06438).
- 16.08 Heel type bowl dating from c1660-1675 from Queen Street (Acc No. HQS90 98); rim bottered and not milled; stem bore 7/64". Hull Type 1d; two stem bores 6/64 and 7/616. (Pcode 06410).
- 16.09 Spur type bowl dating from c1640-1660 from Sammy's Point (Acc No. SPH97 68); rim bottered and fully milled; stem bore 7/64". Similar to a London Type 9. (Pcode 06318).
- 16.10 Heel type bowl dating from c1640-1660 from Sammy's Point (Acc No. SPH97 105); rim bottered and half milled; stem bore 6/64". (Pcode 06301).
- 16.11 Heel type bowl dating from c1640-1670 from Sammy's Point (Acc No. SPH99 1024); rim bottered and not milled; stem bore 7/64". Cut heel. cut mark on heel. (Pcode 06329).

- 16.12 Spur type bowl dating from c1660-1680 from Sammy's Point (Acc No. SPH97 64); rim bottered and not milled; stem bore 8/64". (Pcode 06315).
- 16.13 Heel type bowl dating from c1660-1680 from Sammy's Point (Acc No. SPH97 64); rim bottered and half milled. (Pcode 06316).
- 17.01 Heel type bowl dating from c1660-1680 from Stakis Casino, Castle Street (Acc No. STK98 176); rim bottered and half milled; stem bore 7/64". (Pcode 06494).
- 17.02 Spur type bowl dating from c1640-1660 from Stakis Casino, Castle Street (Acc No. STK98 7); average burnish; rim bottered and fully milled; stem bore 6/64". (Pcode 06505).
- 17.03 Heel type bowl dating from c1640-1660 from Stakis Casino, Castle Street (Acc No. STK98 5); rim bottered and not milled; stem bore 6/64". (Pcode 06500).
- 17.04 Heel type bowl dating from c1640-1670 from Tower Street (Acc No. TSH96 145); rim bottered and not milled; stem bore 7/64". Cut heel. (Pcode 06350).
- 17.05 Heel type bowl dating from c1660-1690 from Tower Street (Acc No. HCT95 U/S); rim bottered and not milled; stem bore 5/64". (Pcode 06343).
- 17.06 Heel type bowl dating from c1660-1700 from Tower Street (Acc No. TSH96 416); rim bottered and half milled; stem bore 7/64". (Pcode 06357).
- 17.07 Heel type bowl dating from c1650-1670 from Wylies Road (Acc No. BWR85 138); rim bottered and three quarters milled; stem bore 7/64". (Pcode 06477).
- 17.08 Spur type bowl dating from c1670-1700 from Wylies Road (Acc No. BWR85 137); good burnish; rim bottered and three quarters milled; stem bore 6/64". (Pcode 06474).

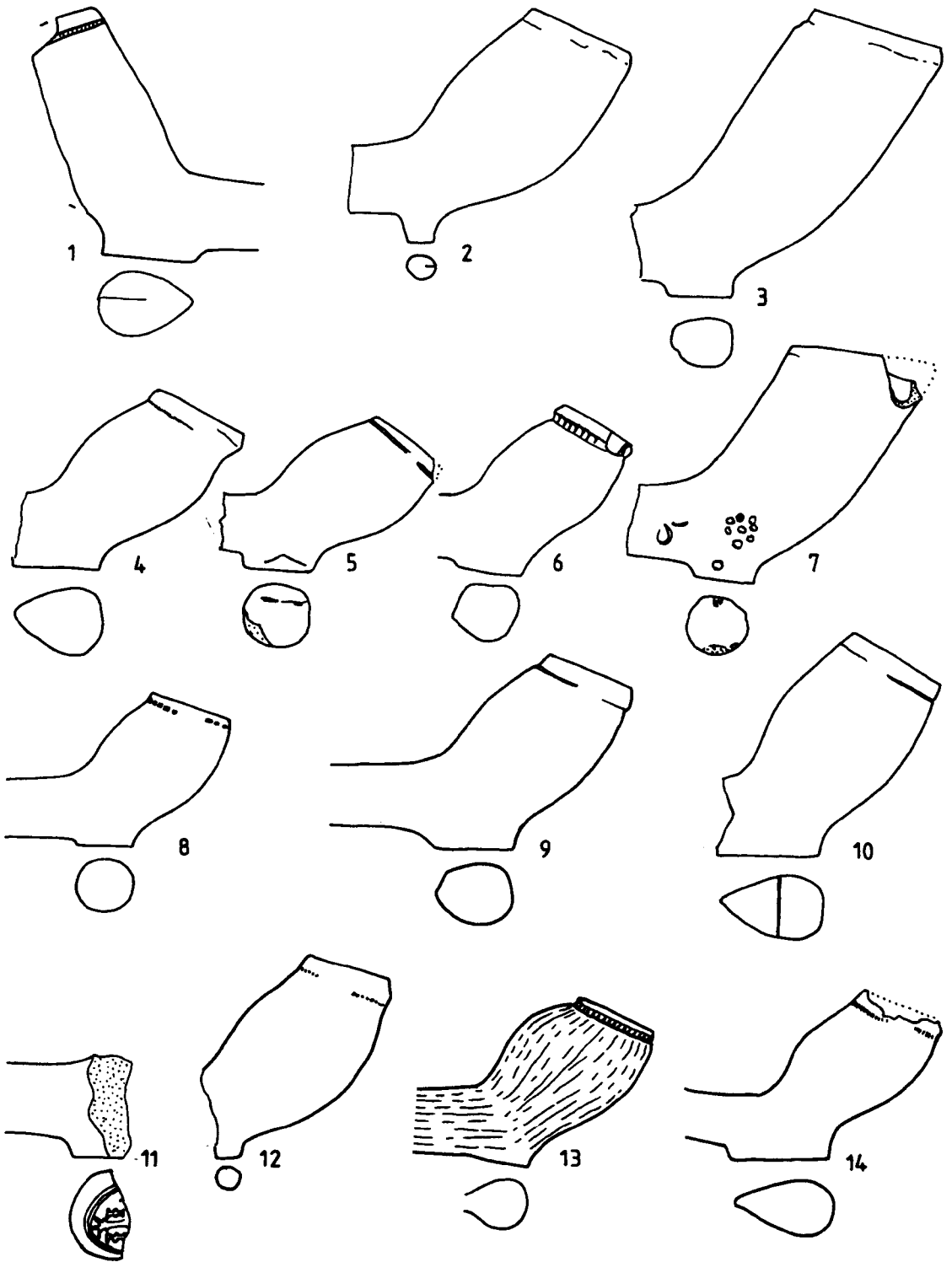


**Figure 13:** Pipes from the collections of the Humber Archaeological Partnership, Hull. Scale 1:1.

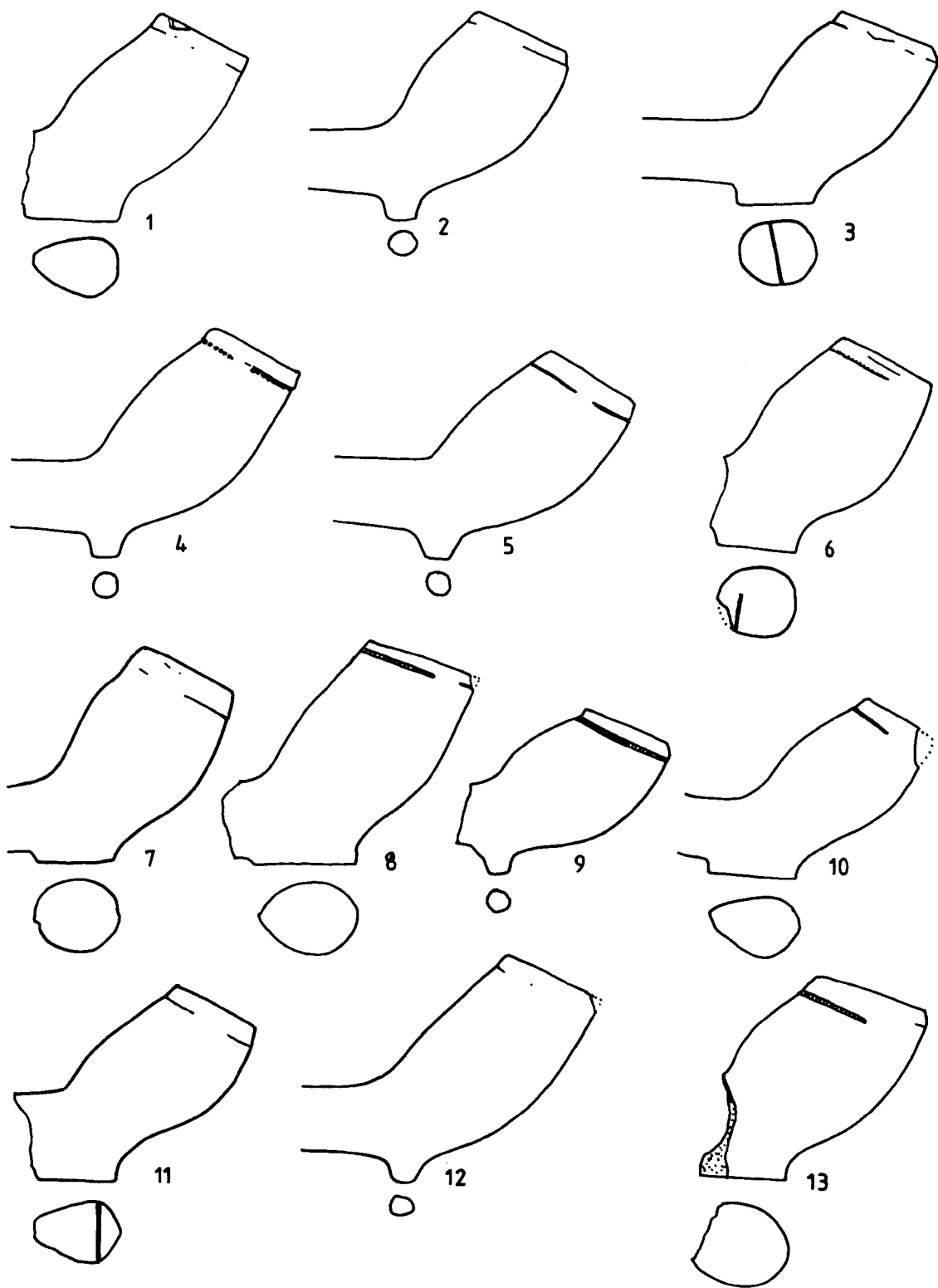


**Figure 14:** Pipes from the collections of the Humber Archaeological Partnership, Hull. Scale 1:1.

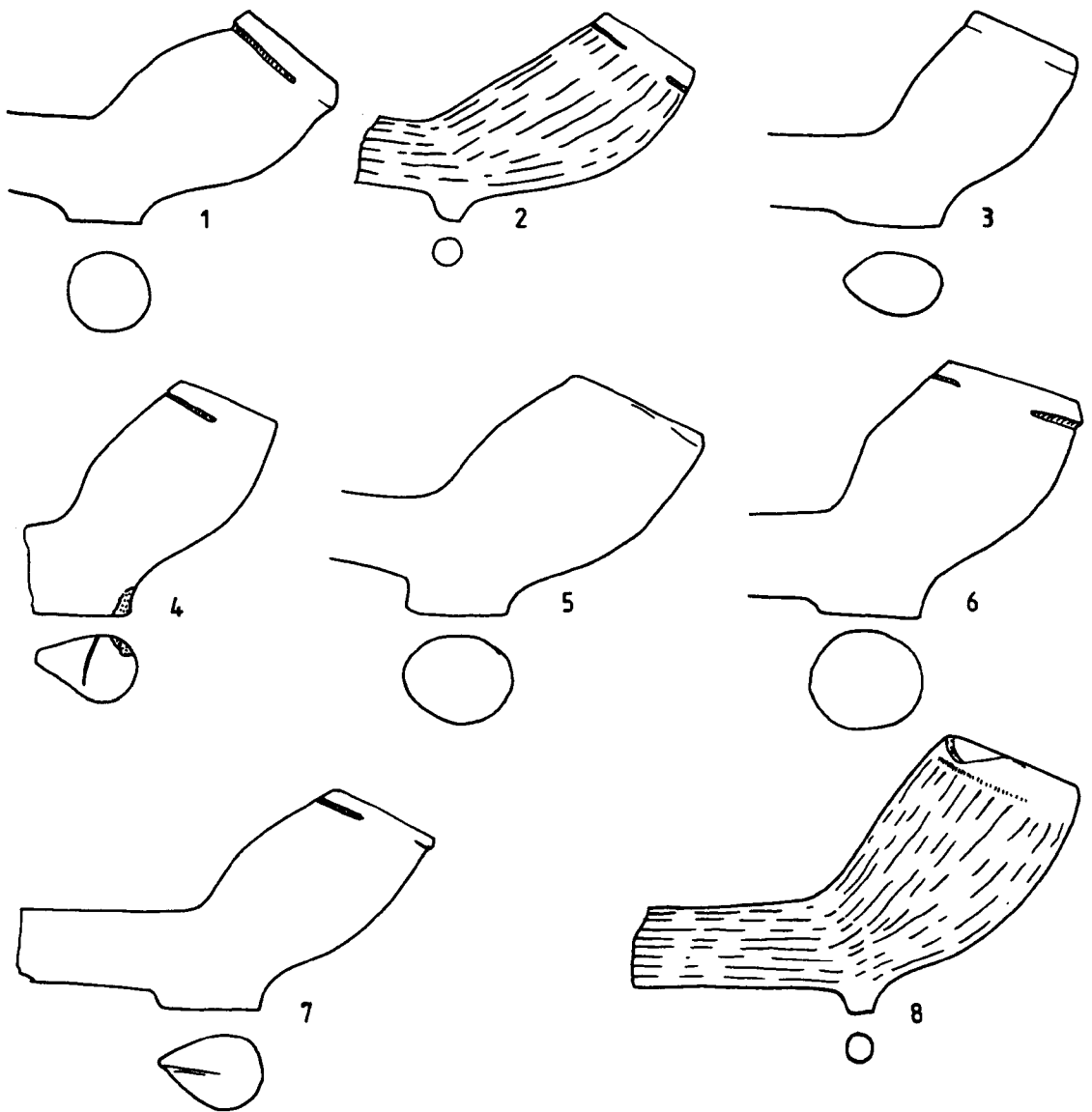




**Figure 15:** Pipes from the collections of the Humber Archaeological Partnership, Hull. Scale 1:1.



**Figure 16:** Pipes from the collections of the Humber Archaeological Partnership, Hull. Scale 1:1.



**Figure 17:** Pipes from the collections of the Humber Archaeological Partnership, Hull. Scale 1:1.

**Collection Name:** Wilberforce House Museum  
**Collection Code:** 0162  
**Contact Name:** Ms Claire Parsons  
**Address:** Kingston on Hull, East Riding of Yorkshire

**Description:**

Collection recorded 8<sup>th</sup> June 1999. The collection included a large number of clay tobacco pipes, mostly unprovenanced. A large number of the pipes in the collection were simply listed as 'Found in Store', which meant that the original documentation could not be found. It may also have meant that the objects were pre-1940's acquisitions, with information destroyed in the Blitz. The museum had a run of Hull Museum Publications, which listed a number of tobacco pipes and smoking related objects

In total approximately 118 pipe fragments dating from the seventeenth or eighteenth century were recorded in detail for the Yorkshire database.

In addition to the seventeenth- and eighteenth-century material the most notable objects are as follows:

- 1/60/10 – an extremely fine meerschaum of a woman in a rather risqué pose smoking a cigar; very fine detail.
- 1/60/17 – large meerschaum of a woman's head, very finely executed.
- 1/60/15 – meerschaum of a horse and castle dated 1812; elaborate brass fittings with mother of pearl detail.
- Oil on canvas of John Goforth Jr., who worked until 1910, titled 'The last Beverley pipemaker' by Fred Elwell RH (1870-1958).

18.01 Heel type bowl dating from c1660-1690 from New Dock Walls (Acc No. 893.1982/118); rim bottered and three quarters milled; stem bore 7/64". (Pcode 08239).

18.02 Heel type bowl dating from c1640-1660; unprovenanced but probably from Hull (Acc No. 893.1982/166); rim bottered and fully milled; stem bore 8/64". Very shiny, but no obvious burnish lines. (Pcode 08165).

18.03 Heel type bowl dating from c1640-1660; unprovenanced but probably from Hull (Acc No. 893.1982/170); rim bottered and three quarters milled; stem bore 7/64". (Pcode 08167).

18.04 Heel type bowl dating from c1640-1660; unprovenanced but probably from Hull (Acc No. 893.1982/151); rim bottered and three quarters milled; stem bore 7/64". (Pcode 08153).

18.05 Heel type bowl dating from c1640-1660; unprovenanced but probably from Hull (Acc No. 893.1982/198); rim bottered and fully milled; stem bore 7/64". (Pcode 08186).

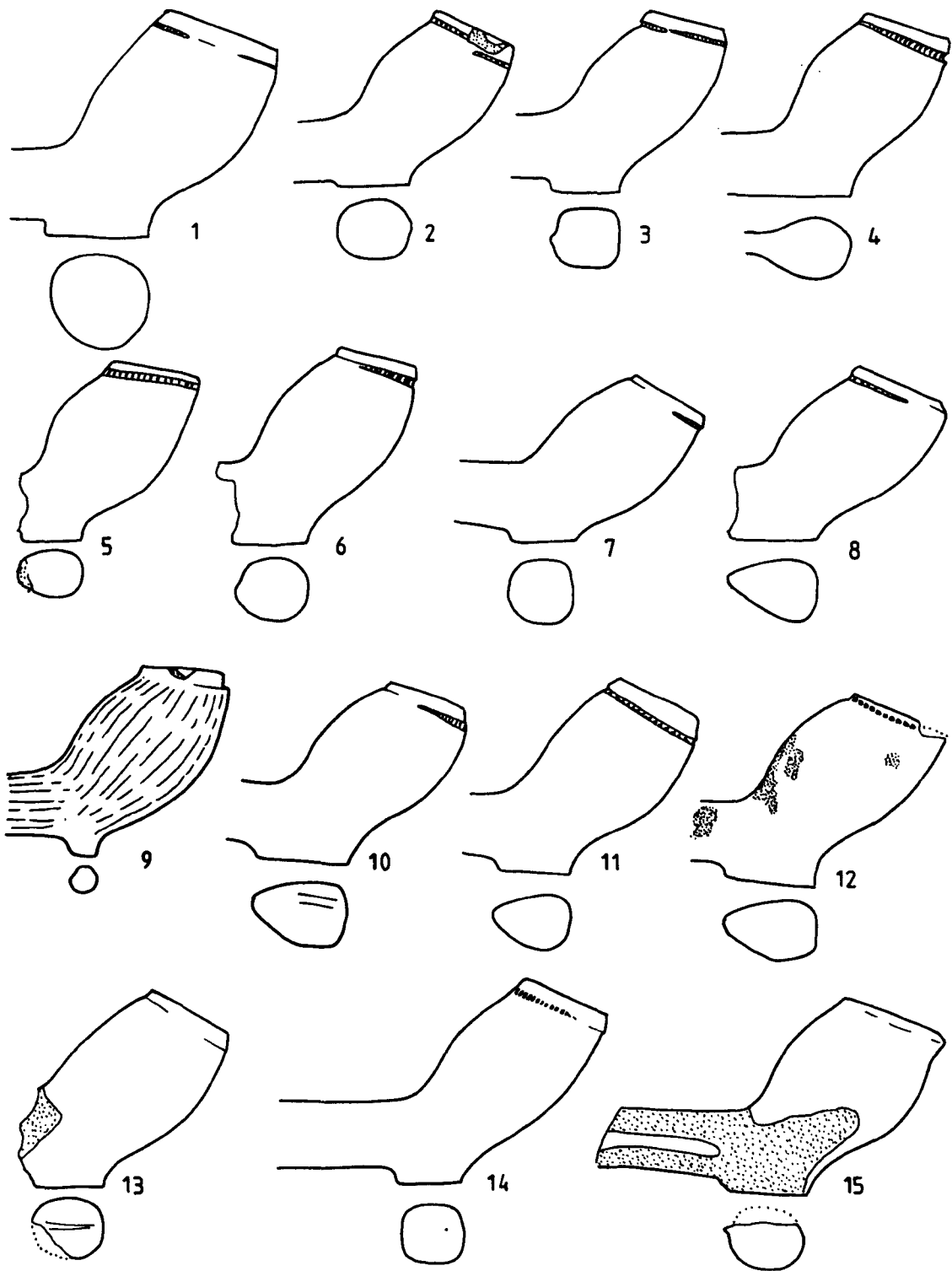
- 18.06 Heel type bowl dating from c1640-1660; unprovenanced but probably from Hull (Acc No. 893.1982/156); rim bottered and fully milled; stem bore 8/64". (Pcode 08157).
- 18.07 Heel type bowl dating from c1640-1660; unprovenanced but probably from Hull (Acc No. 893.1982/150); rim bottered and one quarter milled; stem bore 7/64". (Pcode 08152).
- 18.08 Heel type bowl dating from c1640-1660; unprovenanced but probably from Hull (Acc No. 893.1982/177); rim bottered and one quarter milled; stem bore 7/64". (Pcode 08174).
- 18.09 Spur type bowl dating from c1640-1660; unprovenanced but probably from Hull (Acc No. 893.1982/72); average burnish; rim bottered but not milled; stem bore 8/64". (Pcode 08197).
- 18.10 Heel type bowl dating from c1640-1660; unprovenanced but probably from Hull (Acc No. 893.1982/141); rim bottered and three quarters milled; stem bore 6/64". (Pcode 08148).
- 18.11 Heel type bowl dating from c1640-1660; unprovenanced but probably from Hull (Acc No. 893.1982/152); rim bottered but not milled; stem bore 6/64". (Pcode 08154).
- 18.12 Spur type bowl dating from c1640-1660; unprovenanced but probably from Hull (Acc No. 893.1982/167); rim bottered and fully milled; stem bore 7/64". (Pcode 08166).
- 18.13 Heel type bowl dating from c1640-1660; unprovenanced but probably from Hull (Acc No. 893.1982/190); rim bottered but not milled; stem bore 6/64". (Pcode 08182).
- 18.14 Heel type bowl dating from c1640-1660; unprovenanced but probably from Hull (Acc No. 893.1982/53); rim bottered and three quarters milled; stem bore 9/64". (Pcode 08192).
- 18.15 Heel type bowl dating from c1640-1660; unprovenanced but probably from Hull (Acc No. 893.1982/172); rim bottered but not milled; stem bore 7/64". (Pcode 08169).
- 19.01 Heel type bowl dating from c1640-1670; unprovenanced but probably from Hull (Acc No. 893.1982/27); rim bottered and one quarter milled; stem bore 5/64". Marked with the moulded initials HI on the sides of the stem. Dutch. (Pcode 08189).
- 19.02 Heel type bowl dating from c1660-1680; unprovenanced but probably from Hull (Acc No. 893.1982/116); rim bottered but not milled; stem bore 7/64". (Pcode 08139).

- 19.03 Heel type bowl dating from c1660-1675; unprovenanced but probably from Hull (Acc No. 893.1982/163); rim bottered but not milled; stem bore 5/64". (Pcode 08163).
- 19.04 Heel type bowl dating from c1660-1675; unprovenanced but probably from Hull (Acc No. 893.1982/114); rim bottered but not milled; stem bore 7/64". (Pcode 23507).
- 19.05 Heel type bowl dating from c1660-1675; unprovenanced but probably from Hull (Acc No. 893.1982/173); rim internally trimmed and bottered but not milled; stem bore 6/64". Milled heel. (Pcode 08170).
- 19.06 Heel type bowl dating from c1660-1675; unprovenanced but probably from Hull (Acc No. 893.1982/186); rim bottered but not milled; stem bore 7/64". (Pcode 08179).
- 19.07 Heel type bowl dating from c1660-1680; unprovenanced but probably from Hull; rim bottered and fully milled; stem bore 7/64". Heel form; stem length 19.0cm. (Pcode 08218).
- 19.08 Heel type bowl dating from c1660-1680; unprovenanced but probably from Hull (Acc No. 893.1982/86); average burnish; rim bottered and half milled; stem bore 6/64". (Pcode 08205).
- 19.09 Heel type bowl dating from c1660-1680; unprovenanced but probably from Hull (Acc No. 893.1982/85); average burnish; rim bottered but not milled; stem bore 8/64". (Pcode 08204).
- 19.10 Heel type bowl dating from c1660-1680; unprovenanced but probably from Hull (Acc No. 893.1982/90); average burnish; rim bottered and one quarter milled; stem bore 6/64". (Pcode 08209).
- 19.11 Heel type bowl dating from c1660-1690; unprovenanced but probably from Hull (Acc No. 893.1982/108); poor burnish; rim bottered and one quarter milled; stem bore 5/64". (Pcode 08138).
- 19.12 Heel type bowl dating from c1660-1690; unprovenanced but probably from Hull (Acc No. 893.1982/105); rim bottered and one quarter milled; stem bore 8/64". (Pcode 08136).
- 20.01 Spur type bowl dating from c1660-1680; unprovenanced but probably from Hull (Acc No. 893.1982/5); rim bottered but not milled; stem bore 7/64". Complete pipe, stem length 24.3cm. (Pcode 08191).
- 20.02 Spur type bowl dating from c1660-1680; unprovenanced but probably from Hull; rim bottered and half milled; stem bore 8/64". Spur form; stem length 23.7cm. (Pcode 08217).

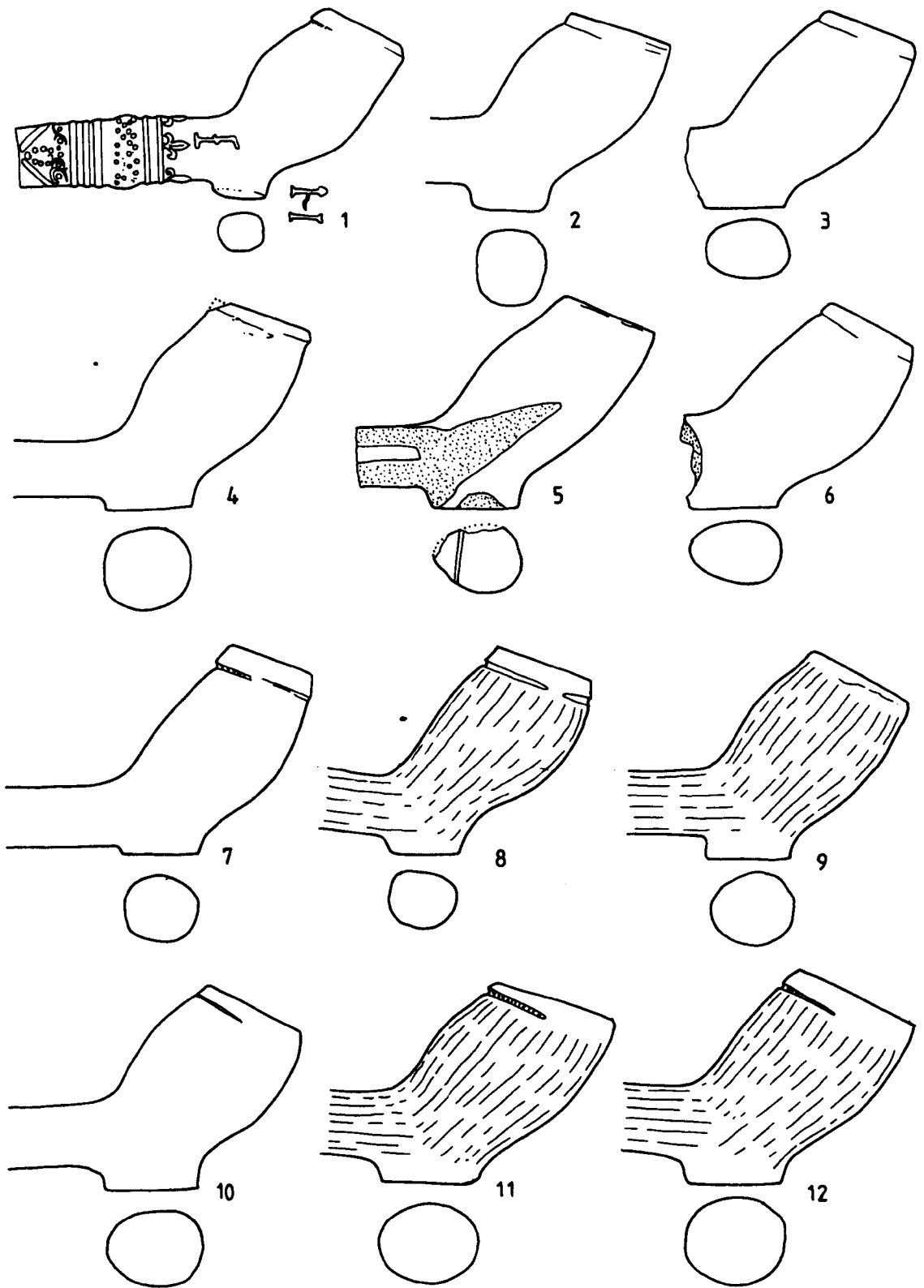
- 20.03 Spur type bowl dating from c1660-1680; unprovenanced but probably from Hull (Acc No. 893.1982/98); rim bottered and one quarter milled; stem bore 7/64". (Pcode 08214).
- 20.04 Spur type bowl dating from c1660-1680; unprovenanced but probably from Hull (Acc No. 893.1982/180); rim wiped but not milled; stem bore 5/64". (Pcode 08175).
- 20.05 Heel type bowl dating from c1660-1680; unprovenanced but probably from Hull (Acc No. 893.1982/57); average burnish; rim bottered and one quarter milled; stem bore 7/64". (Pcode 08194).
- 20.06 Spur type bowl dating from c1660-1680; unprovenanced but probably from Hull (Acc No. 893.1982/93); rim bottered and three quarters milled; stem bore 5/64". (Pcode 08211).
- 20.07 Heel type bowl dating from c1670-1700; unprovenanced but probably from Hull (Acc No. 893.1982/2); rim bottered but not milled; stem bore 5/64". (Pcode 08188).
- 20.08 Heel type bowl dating from c1660-1690; unprovenanced but probably from Hull (Acc No. 893.1982/192); stem bore 7/64". No rim surviving. (Pcode 08184).
- 20.09 Heel type bowl dating from c1660-1690; unprovenanced but probably from Hull (Acc No. 893.1982/158); average burnish; rim bottered but not milled; stem bore 8/64". (Pcode 08159).
- 20.10 Heel type bowl dating from c1700-1770; unprovenanced but probably from Hull (Acc No. 893.1982/95); average burnish; rim bottered but not milled; stem bore 5/64". (Pcode 08212).
- 21.01 Heel type bowl dating from c1680-1710; unprovenanced but probably from Hull (Acc No. 893.1982/37); average burnish; rim bottered and one quarter milled; stem bore 7/64". Marked with the initials NT on the heel. (Pcode 02074).
- 21.02 Heel type bowl dating from c1700-1770; unprovenanced but probably from Hull (Acc No. 893.1982/87); rim internally trimmed and wiped but not milled; stem bore 7/64". (Pcode 08206).
- 21.03 Heel type bowl dating from c1660-1680; unprovenanced material in Wilberforce House Museum probably from London (Acc No. 76.52/3); rim cut; rim three quarters milled; stem bore 7/64". (Pcode 08226).
- 21.04 Heel type bowl dating from c1700-1770; unprovenanced but probably from Hull; average burnish; rim bottered and one quarter milled; stem bore 6/64". (Pcode 08216).

- 21.05 Heel type bowl dating from c1700-1770; unprovenanced material in Wilberforce House Museum probably from London (Acc No. 76.52/8); average burnish; rim wiped but not milled; stem bore 7/64". (Pcode 08229).
- 21.06 Heel type bowl dating from c1700-1770; unprovenanced material in Wilberforce House Museum probably from London (Acc No. 76.52/7); average burnish; rim bottered and half milled; stem bore 6/64". (Pcode 08228).
- 21.07 Heel type bowl dating from c1660-1700; unprovenanced material in Wilberforce House Museum probably from London (Acc No. 78.48/7); rim bottered and three quarters milled; stem bore 7/64". (Pcode 08236).
- 21.08 Heel type bowl dating from c1700-1770; unprovenanced material in Wilberforce House Museum probably from London (Acc No. 21.49.2); rim bottered but not milled; stem bore 5/64". (Pcode 08220).
- 21.09 Heel type bowl dating from c1700-1770; unprovenanced material in Wilberforce House Museum probably from London (Acc No. 21.49/3); rim bottered but not milled; stem bore 6/64". (Pcode 08222).
- 21.10 Heel type bowl dating from c1700-1770; unprovenanced material in Wilberforce House Museum probably from London (Acc No. 76.52/4); average burnish; rim wiped but not milled; stem bore 5/64". (Pcode 08227).
- 21.11 Heel type bowl dating from c1700-1770; unprovenanced material in Wilberforce House Museum probably from London (Acc No. 76.52/12); rim cut; stem bore 5/64". Marked with the initials IG/C on the sides of the heel. Second initial poorly moulded, could be a G or a C. (Pcode 08225).
- 21.12 Heel type bowl dating from c1700-1770; unprovenanced material in Wilberforce House Museum probably from London (Acc No. 76.52/11); rim cut but not milled; stem bore 4/64". Very shiny, but no obvious burnish lines. (Pcode 08224).

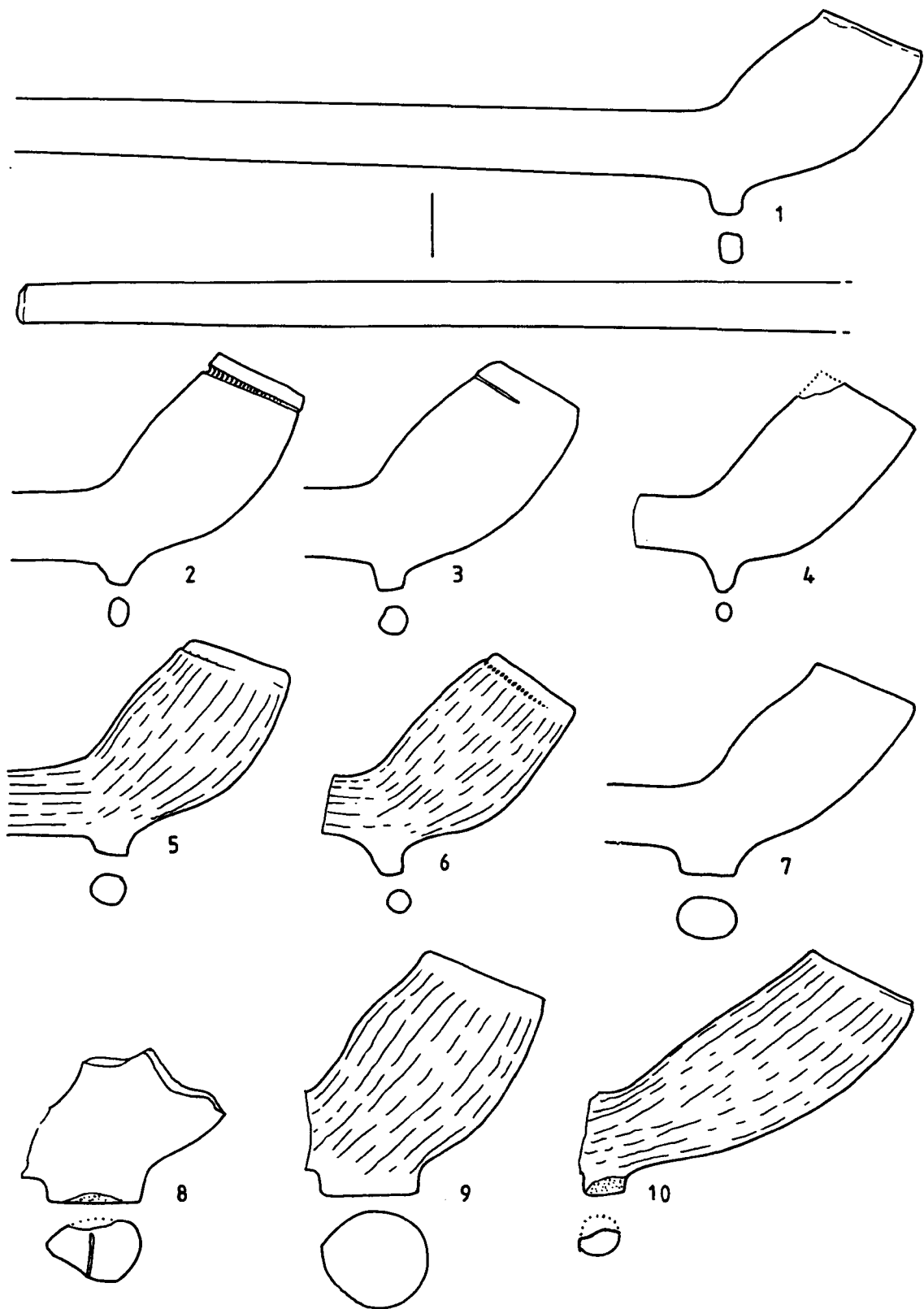




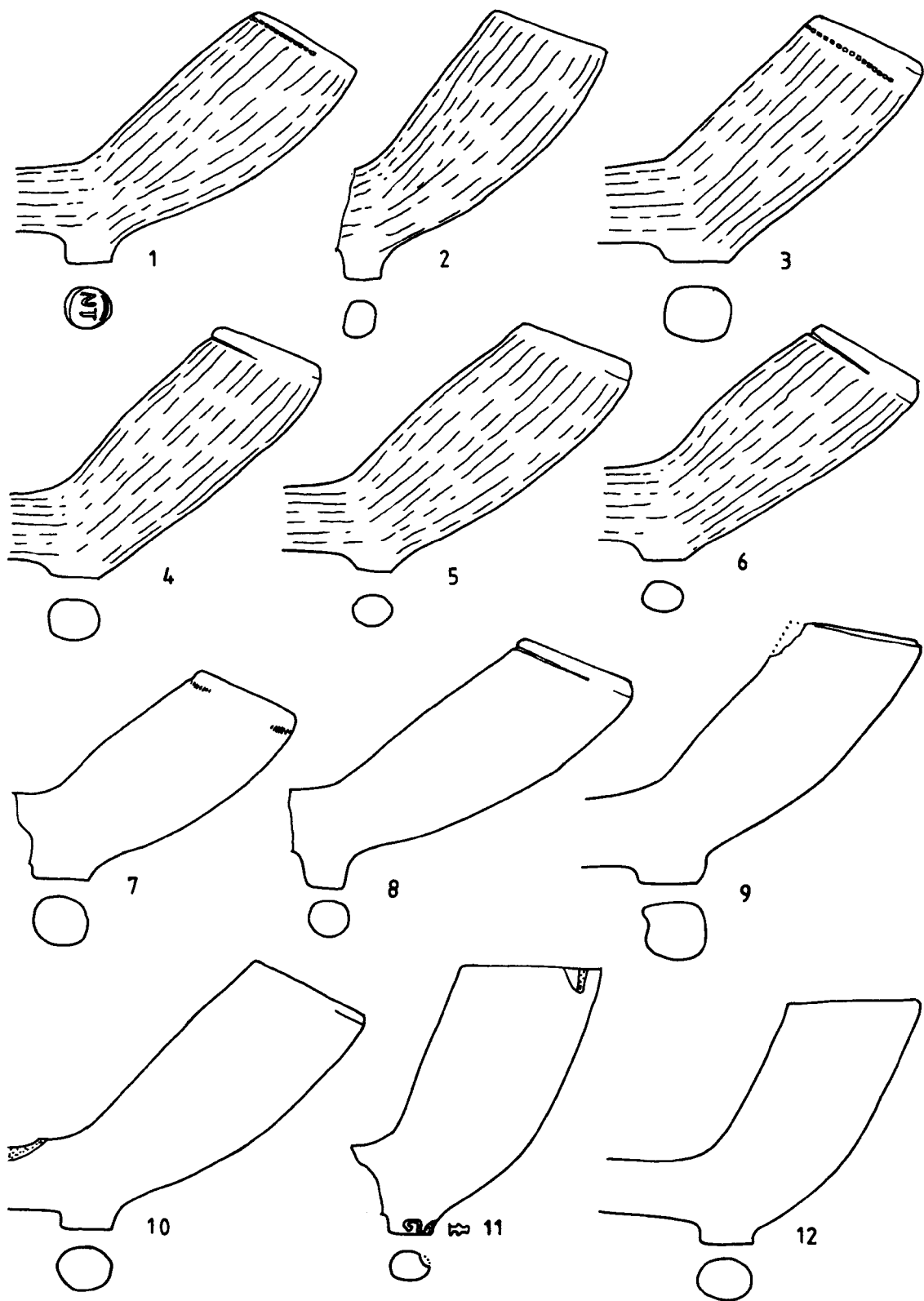
**Figure 18:** Pipes from the collections of the Wilberforce House Museum, Hull. Scale 1:1.



**Figure 19:** Pipes from the collections of the Wilberforce House Museum, Hull.  
 Scale 1:1.



**Figure 20:** Pipes from the collections of the Wilberforce House Museum, Hull. Scale 1:1.

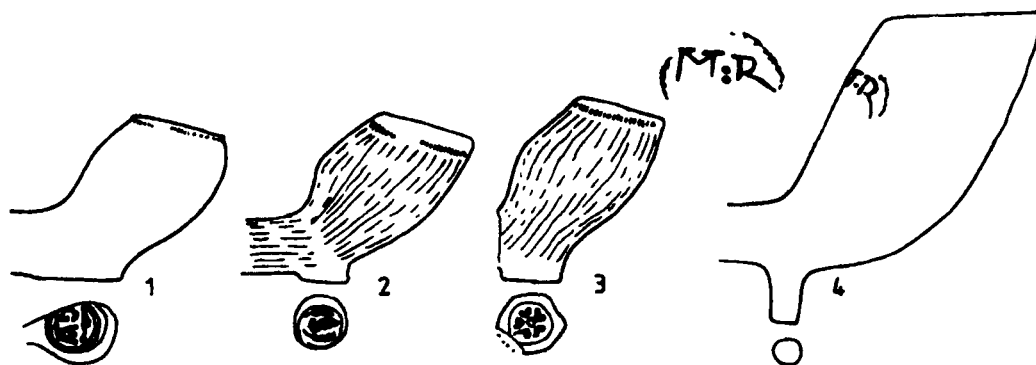


**Figure 21:** Pipes from the collections of the Wilberforce House Museum, Hull.  
Scale 1:1.

**Collection Name:** Stothard Collection  
**Collection Code:** 0146  
**Contact Name:** Martin Stothard  
**Address:** Kingston on Hull/Beverley area, East Riding of Yorkshire  
**Description:**

Private collection from the Hull/Beverley area. A total of 24 pipes dating from the seventeenth and eighteenth century were selected from inclusion in the Yorkshire database.

- 22.01 Heel type bowl dating from c1610-1640 from the Old Town, Hull; rim bottered and fully milled; stem bore 7/64". Marked with the initials GW on the heel. (Pcode 02605).
- 22.02 Heel type bowl dating from c1620-1650 from the Old Town, Hull; good burnish; rim bottered and fully milled; stem bore 7/64". Marked with the lettering ?4S on the heel. Dutch. (Pcode 02614).
- 22.03 Heel type bowl dating from c1610-1640 from the Old Town, Hull; good burnish; rim bottered and fully milled; stem bore 6/64". Marked with a wheel or stylised rose on the heel. Dutch. (Pcode 02603).
- 22.04 Spur type bowl dating from c1740-1800 from the Old Town, Hull; rim cut but not milled; stem bore 4/64". Marked with the initials MR on the bowl facing the smoker. (Pcode 02613).



**Figure 22:** Pipes from the Stothard Collection. Scale 1:1

**Collection Name:** Rayner Collection  
**Collection Code:** 0070  
**Contact Name:** Mr Peter Rayner  
**Address:** Walkington, Beverley, East Riding of Yorkshire

**Description:**

A substantial private collection recorded on a number of visits between 1998 and 2001. Part on the collection was borrowed for detailed recording back in Liverpool. Although the majority of the pipes in this collection were recovered from fields near Beverley there is also a large group from the Citadel in Hull. The collection includes some obvious wasters that are very highly fired and some of the bowls have slaggy material adhering to them. Possible kiln furniture in the form of pipe clay strips have been collected from the fields.

The collector has retained any unusual plain bowls as well as all marked bowls and stems. It is understood, however, that approximately 1,800 plain "Hull" type bowls dating from the mid seventeenth century have been sold overseas. In addition all plain stems from all periods have been discarded.

In addition to the 2,423 marked bowls and stems that were recorded in detail for the Yorkshire database the most notable finds are as follows:-

- A collection of nineteenth-century imported marks, which include Fiolet (France); Goedewagen (Holland); E Southorn (Broseley); T Penn and H Tunstall (both Leeds); Hirst (Hull) and W White (Glasgow).
- Collection of hair-curlers approximately half of which are marked. Two of these are marked HULL, which provides a rare confirmation of local manufacture.
- Fluted bowl with W BUTLER/SELBY moulded around the rim
- Indians and shield pipe dating from c1800-20 with very fine detail and the lettering D HODGSON/LEEDS moulded round the rim.
- Bowl decorated with a barrel and grapes with the lettering ERATT/BRIGG moulded round the rim.

23.01 Heel type bowl dating from c1640-1660 from The Citadel, Hull (Acc No. 2141); rim bottered but not milled. (Pcode 04783).

23.02 Heel type bowl dating from c1660-1680 from The Citadel, Hull; rim bottered but not milled. (Pcode 05041).

23.03 Heel type bowl dating from c1640-1660 from The Citadel, Hull (Acc No. 2140); rim bottered but not milled. (Pcode 04782).

23.04 Heel type bowl dating from c1640-1660 from The Citadel, Hull (Acc No. 2139); rim bottered and three quarters milled. (Pcode 04781).

23.05 Heel type bowl dating from c1640-1660 from The Citadel, Hull (Acc No. 2138); rim bottered and fully milled. (Pcode 04780).

- 23.06 Heel type bowl dating from c1640-1660 from The Citadel, Hull (Acc No. 2137); rim bottered and fully milled. (Pcode 04779).
- 23.07 Heel type bowl dating from c1640-1660 from The Citadel, Hull (Acc No. 2136); rim bottered but not milled. (Pcode 04778).
- 23.08 Heel type bowl dating from c1640-1660 from The Citadel, Hull; rim bottered and half milled. (Pcode 05046).
- 23.09 Heel type bowl dating from c1660-1675 from The Citadel, Hull; rim bottered and fully milled. (Pcode 05043).
- 23.10 Heel type bowl dating from c1660-1675 from The Citadel, Hull; rim bottered and half milled. Cut heel. (Pcode 05045).
- 23.11 Heel type bowl dating from c1640-1660 from The Citadel, Hull (Acc No. 2132); rim bottered and fully milled. (Pcode 04776).
- 23.12 Spur type bowl dating from c1640-1660 from The Citadel, Hull (Acc No. 2216); good burnish; rim bottered and fully milled; stem bore 6/64". (Pcode 04857).
- 23.13 Heel type bowl dating from c1660-1675 from The Citadel, Hull; rim bottered and three quarters milled. (Pcode 05044).
- 23.14 Heel type bowl dating from c1650-1670 from The Citadel, Hull; rim bottered and half milled. (Pcode 04918).
- 24.01 Spur type bowl dating from c1660-1680 from The Citadel, Hull (Acc No. 2186); rim bottered but not milled; stem bore 7/64". (Pcode 04827).
- 24.02 Spur type bowl dating from c1660-1680 from The Citadel, Hull (Acc No. 2229); rim bottered but not milled; stem bore 7/64". (Pcode 04870).
- 24.03 Spur type bowl dating from c1660-1680 from The Citadel, Hull (Acc No. 2175); rim bottered and half milled; stem bore 8/64". (Pcode 04816).
- 24.04 Spur type bowl dating from c1660-1680 from The Citadel, Hull (Acc No. 2180); rim bottered and half milled; stem bore 7/64". No burnishing lines visible but surface of bowl smooth and shiny. (Pcode 04821).
- 24.05 Heel type bowl dating from c1660-1700 from The Citadel, Hull (Acc No. 2145); rim bottered but not milled; stem bore 7/64". (Pcode 04787).
- 24.06 Heel type bowl dating from c1660-1700 from The Citadel, Hull (Acc No. 2224); rim bottered and three quarters milled; stem bore 7/64". (Pcode 04865).
- 24.07 Heel type bowl dating from c1660-1675 from The Citadel, Hull; rim bottered but not milled. (Pcode 05042).

- 24.08 Heel type bowl dating from c1660-1700 from The Citadel, Hull (Acc No. 2189); rim bottered but not milled; stem bore 7/64". (Pcode 04830).
- 24.09 Spur type bowl dating from c1660-1680 from The Citadel, Hull (Acc No. 2227a); rim bottered but not milled. (Pcode 04868).
- 24.10 Spur type bowl dating from c1660-1680 from The Citadel, Hull (Acc No. 2228); rim bottered but not milled; stem bore 7/64". (Pcode 04869).
- 24.11 Heel type bowl dating from c1660-1700 from The Citadel, Hull (Acc No. 2225); rim bottered but not milled; stem bore 8/64". (Pcode 04866).
- 24.12 Heel type bowl dating from c1660-1700 from The Citadel, Hull (Acc No. 2226); rim bottered but not milled; stem bore 8/64". (Pcode 04867).
- 24.13 Heel type bowl dating from c1660-1700 from The Citadel, Hull (Acc No. 2102); rim bottered but not milled; stem bore 6/64". Similar to a Hull Type 2d. (Pcode 04745).
- 25.01 Heel type bowl dating from c1660-1700 from The Citadel, Hull (Acc No. 2143); good burnish; rim internally trimmed, bottered and half milled; stem bore 6/64". (Pcode 04785).
- 25.02 Heel type bowl dating from c1660-1700 from The Citadel, Hull (Acc No. 2148); rim bottered but not milled; stem bore 7/64". (Pcode 04790).
- 25.03 Heel type bowl dating from c1660-1700 from The Citadel, Hull (Acc No. 2149); rim internally trimmed and bottered but not milled; stem bore 8/64". (Pcode 04791).
- 25.04 Heel type bowl dating from c1660-1700 from The Citadel, Hull (Acc No. 2164); rim bottered but not milled; stem bore 8/64". (Pcode 04806).
- 25.05 Heel type bowl dating from c1660-1700 from The Citadel, Hull (Acc No. 2171); rim bottered but not milled; stem bore 7/64". (Pcode 04812).
- 25.06 Heel type bowl dating from c1660-1700 from The Citadel, Hull (Acc No. 2153); rim internally trimmed and bottered but not milled. ?same mould as Pcode 4787. (Pcode 04795).
- 25.07 Heel type bowl dating from c1660-1690 from The Citadel, Hull (Acc No. 2227); rim bottered and fully milled. Stem milled. (Pcode 05040).
- 25.08 Heel type bowl dating from c1660-1700 from The Citadel, Hull (Acc No. 2142); rim bottered but not milled; stem bore 8/64". (Pcode 04784).
- 25.09 Heel type bowl dating from c1580-1610 from fieldwalking around Beverley (Acc No. 124); stem bore 8/64". No rim. (Pcode 03661).



- 25.10 Heel type bowl dating from c1580-1610 from fieldwalking around Beverley (Acc No. 338); good burnish; rim bottered and fully milled; stem bore 9/64". (Pcode 03875).
- 25.11 Heel type bowl dating from c1620-1640 from fieldwalking around Beverley (Acc No. 1303); good burnish; rim bottered and fully milled; stem bore 7/64". Marked with wheel on the heel. (Pcode 02900).
- 25.12 Heel type bowl dating from c1610-1640 from fieldwalking around Beverley (Acc No. 1); rim bottered and fully milled; stem bore 7/64". Stem milled. (Pcode 03538).
- 25.13 Spur type bowl dating from c1610-1640 from fieldwalking around Beverley (Acc No. 2); rim bottered and fully milled; stem bore 7/64". Abraded surface. (Pcode 03539).
- 26.01 Heel type bowl dating from c1610-1640 from fieldwalking around Beverley (Acc No. 104); rim bottered and fully milled; stem bore 8/64". (Pcode 03641).
- 26.02 Heel type bowl dating from c1610-1640 from fieldwalking around Beverley (Acc No. 120); rim bottered and fully milled; stem bore 8/64". (Pcode 03657).
- 26.03 Heel type bowl dating from c1610-1640 from fieldwalking around Beverley (Acc No. 122); rim bottered and fully milled. (Pcode 03659).
- 26.04 Heel type bowl dating from c1610-1640 from fieldwalking around Beverley (Acc No. 123); rim bottered and three quarters milled; stem bore 8/64". (Pcode 03660).
- 26.05 Heel type bowl dating from c1620-1650 from fieldwalking around Beverley. London heel type, probably just an accidental mark on the heel. (Pcode 02870).
- 26.06 Heel type bowl dating from c1620-1640 from King's Head, High Street, Hull (Acc No. 2456); rim bottered and fully milled; stem bore 8/64". Dutch; mark poorly preserved, possibly a Tudor rose. (Pcode 21316).
- 26.07 Heel type bowl dating from c1620-1640 from King's Head, High Street, Hull (Acc No. 2462); good burnish; rim bottered and fully milled; stem bore 7/64". Marked with the lettering ?4TS on the heel. Dutch; stamped fleur de lys visible on stem. (Pcode 21321).
- 26.08 Heel type bowl dating from c1620-1640 from King's Head, High Street, Hull (Acc No. 2458); good burnish; rim bottered and fully milled; stem bore 7/64". Marked with a Tudor rose on the heel. Dutch. (Pcode 21318).
- 26.09 Heel tType bowl dating from c1620-1640 from King's Head, High Street, Hull (Acc No. 2454); rim bottered and milled around all of the surviving

rim; stem bore 8/64". Marked with the initials GW on the heel. Gabriel Westoby of York. (Pcode 21312).

- 26.10 Heel type bowl dating from c1620-1640 from King's Head, High Street, Hull (Acc No. 2452); rim internally trimmed, bottered and half milled. (Pcode 23542).
- 26.11 Spur type bowl dating from c1620-1640 from King's Head, High Street, Hull (Acc No. 2451); rim bottered and fully milled; stem bore 7/64". (Pcode 23541).
- 26.12 Heel type bowl dating from c1620-1640 from King's Head, High Street, Hull (Acc No. 2464); good burnish; rim bottered and fully milled; stem bore 7/64". Marked with a crowned rose on the heel. Dutch. (Pcode 23125).
- 26.13 Heel type bowl dating from c1620-1640 from King's Head, High Street, Hull (Acc No. 2455); rim bottered and fully milled; stem bore 7/64". Part of a mark visible. (Pcode 21315).
- 26.14 Heel type bowl dating from c1620-1640 from King's Head, High Street, Hull (Acc No. 2463); good burnish; rim bottered and fully milled; stem bore 7/64". Marked with a crowned rose on the heel. Dutch. (Pcode 23124).
- 26.15 Heel type bowl dating from c1620-1650 from fieldwalking around Beverley (Acc No. 1997); rim bottered and milled around all of the surviving rim; stem bore 8/64". (Pcode 04672).
- 26.16 Heel type bowl dating from c1640-1660 from fieldwalking around Beverley (Acc No. 136); rim bottered and one quarter milled; stem bore 7/64". (Pcode 03673).
- 26.17 Heel type bowl dating from c1640-1660 from fieldwalking around Beverley (Acc No. 1290); rim bottered and fully milled; stem bore 6/64". Marked with a wheel on the heel. (Pcode 02897).
- 26.18 Heel type bowl dating from c1640-1660 from fieldwalking around Beverley (Acc No. 121); rim bottered and fully milled; stem bore 7/64". (Pcode 03658).
- 26.19 Heel type bowl dating from c1640-1660 from fieldwalking around Beverley (Acc No. 1289); good burnish; rim bottered and fully milled; stem bore 7/64". Marked with a wheel on the heel. (Pcode 02901).
- 27.01 Heel type bowl dating from c1640-1660 from fieldwalking around Beverley (Acc No. 117); rim bottered and three quarters milled; stem bore 8/64". Stem milled. (Pcode 03654).
- 27.02 Spur type bowl dating from c1640-1660 from fieldwalking around Beverley (Acc No. 4); rim bottered and three quarters milled; stem bore 7/64". (Pcode 03541).

- 27.03 Heel type bowl dating from c1640-1660 from fieldwalking around Beverley (Acc No. 105); finely burnished; rim bottered and fully milled; stem bore 8/64". (Pcode 03642).
- 27.04 Heel type bowl dating from c1640-1660 from fieldwalking around Beverley (Acc No. 106); poorly burnished; rim bottered and fully milled; stem bore 8/64". (Pcode 03643).
- 27.05 Heel type bowl dating from c1635-1650 from fieldwalking around Beverley (Acc No. 562); rim bottered but not milled; stem bore 7/64". Same mould as Pcode 4088-4097. (Pcode 04087).
- 27.06 Heel type bowl dating from c1640-1660 from fieldwalking around Beverley (Acc No. 159); rim bottered and fully milled; stem bore 7/64". (Pcode 03696).
- 27.07 Heel type bowl dating from c1650-1670 from fieldwalking around Beverley (Acc No. 157); rim bottered but not milled; stem bore 7/64". (Pcode 03694).
- 27.08 Heel type bowl dating from c1640-1660 from fieldwalking around Beverley (Acc No. 160); rim bottered but not milled; stem bore 7/64". (Pcode 03697).
- 27.09 Heel type bowl dating from c1620-1650 from fieldwalking around Beverley (Acc No. 1330); rim bottered and fully milled; stem bore 7/64". Marked with the initials SV across the stem. (Pcode 02915). Drawing by D A Higgins.
- 27.10 Heel type bowl dating from c1640-1660 from fieldwalking around Beverley (Acc No. 1332); rim bottered and fully milled; stem bore 7/64". Marked with the initials SV across the stem. (Pcode 02917). Drawing by D A Higgins.
- 27.11 Heel type bowl dating from c1640-1670 from fieldwalking around Beverley (Acc No. 1359); rim bottered but not milled; stem bore 7/64". Marked with the initials SV across the stem. (Pcode 02922). Drawing by D A Higgins.
- 27.12 Spur type bowl dating from c1640-1660 from fieldwalking around Beverley (Acc No. 6); rim bottered and fully milled; stem bore 7/64". (Pcode 03543).
- 27.13 Heel type bowl dating from c1640-1660 from fieldwalking around Beverley (Acc No. 158); rim bottered and fully milled; stem bore 7/64". (Pcode 03695).
- 27.14 Heel type bowl dating from c1640-1660 from fieldwalking around Beverley (Acc No. 150); rim bottered and milled around all of the surviving rim; stem bore 7/64". (Pcode 03687).
- 27.15 Heel type bowl dating from c1640-1660 from fieldwalking around Beverley (Acc No. 115); rim bottered but not milled; stem bore 7/64". (Pcode 03652).

- 27.16 Heel type bowl dating from c1640-1660 from fieldwalking around Beverley (Acc No. 1233); rim bottered but not milled; stem bore 7/64". Marked with a fleur-de-lys) on the heel in a diamond border. (Pcode 02868). Drawing by D A Higgins.
- 27.17 Heel type bowl dating from c1640-1660 from fieldwalking around Beverley (Acc No. 146); rim bottered and half milled; stem bore 7/64". (Pcode 03683).
- 28.01 Heel type bowl dating from c1640-1660 from fieldwalking around Beverley (Acc No. 107); rim bottered and fully milled; stem bore 7/64". (Pcode 03644).
- 28.02 Heel type bowl dating from c1640-1670 from fieldwalking around Beverley (Acc No. 1297); rim bottered and one quarter milled; stem bore 6/64". Marked with a wheel on the heel. (Pcode 02894).
- 28.03 Heel type bowl dating from c1640-1660 from fieldwalking around Beverley (Acc No. 1980); rim bottered and fully milled; stem bore 7/64". Heart shaped heel. (Pcode 04655).
- 28.04 Heel type bowl dating from c1660-1680 from fieldwalking around Beverley (Acc No. 108); rim bottered but not milled; stem bore 6/64". Very highly fired. (Pcode 03645).
- 28.05 Heel type bowl dating from c1640-1660 from fieldwalking around Beverley (Acc No. 137); milled around all of the surviving rim; stem bore 7/64". (Pcode 03674).
- 28.06 Heel type bowl dating from c1640-1660 from fieldwalking around Beverley (Acc No. 139); milled around all of the surviving rim; stem bore 7/64". (Pcode 03676).
- 28.07 Spur type bowl dating from c1630-1660 from fieldwalking around Beverley (Acc No. 2007); rim bottered but not milled; stem bore 7/64". 17th C mould decorated; Dutch. (Pcode 04680).
- 28.08 Heel type bowl dating from c1640-1660 from fieldwalking around Beverley (Acc No. 1229); average burnish; rim bottered and half milled; stem bore 7/64". Marked with a ram on the heel. (Pcode 02876). Drawing by D A Higgins.
- 28.09 Spur type bowl dating from c1640-1660 from fieldwalking around Beverley (Acc No. 12); rim bottered and fully milled; stem bore 7/64". Abraded surface. (Pcode 03549).
- 28.10 Spur type bowl dating from c1640-1660 from fieldwalking around Beverley (Acc No. 11); rim bottered and half milled; stem bore 7/64". Abraded surface. (Pcode 03548).

- 28.11 Spur type bowl dating from c1640-1660 from fieldwalking around Beverley (Acc No. 13); rim bottered but not milled; stem bore 7/64". Very crudely made. (Pcode 03550).
- 28.12 Spur type bowl dating from c1640-1660 from fieldwalking around Beverley (Acc No. 7); rim bottered and fully milled; stem bore 7/64". (Pcode 03544).
- 28.13 Stem fragment dating from c1630-1660 from fieldwalking around Beverley (Acc No. 2009); stem bore 7/64". 17th C mould decorated; Dutch; probably from same pipe as Pcode 4068. (Pcode 04682). Drawing by D A Higgins.
- 28.14 Stem fragment dating from c1630-1699 from fieldwalking around Beverley (Acc No. 2008); stem bore 6/64". 17th C mould decorated; Dutch. (Pcode 04681). Drawing by D A Higgins.
- 28.15 Stem fragment dating from c1620-1650 from fieldwalking around Beverley (Acc No. 1329); good burnish; stem bore 8/64". Marked with the initials SV across the stem. Stem only. (Pcode 02950). Drawing by D A Higgins.
- 29.01 Heel type bowl dating from c1640-1660 from fieldwalking around Beverley (Acc No. 1520); rim bottered but not milled; stem bore 7/64". Marked with the initials GC on the heel. Heart shaped GC mark; pelleted border with initials above a flower. (Pcode 03157).
- 29.02 Heel type bowl dating from c1640-1660 from fieldwalking around Beverley (Acc No. 1591); rim bottered but not milled; stem bore 8/64". Marked with the initials GC on the heel. Heart shaped GC mark; pelleted border with initials above a flower. (Pcode 03039).
- 29.03 Heel type bowl dating from c1640-1660 from fieldwalking around Beverley (Acc No. 1609); rim bottered but not milled; stem bore 7/64". Marked with the initials GC on the heel. Heart shaped GC mark; pelleted border with initials above a flower. (Pcode 02160).
- 29.04 Heel type bowl dating from c1640-1670 from fieldwalking around Beverley (Acc No. 1451); rim bottered but not milled; stem bore 7/64". Marked with the initials GC on the heel. Heart shaped GC mark, single line border initials above a flower; large heel. (Pcode 03123).
- 29.05 Heel type bowl dating from c1640-1660 from fieldwalking around Beverley (Acc No. 1599); rim bottered but not milled; stem bore 7/64". Marked with the initials GC on the heel. Heart shaped GC mark; pelleted border with initials above a flower. (Pcode 02151).
- 29.06 Heel type bowl dating from c1640-1670 from fieldwalking around Beverley (Acc No. 1531); rim bottered but not milled; stem bore 7/64". Marked with the initials GC on the heel. Heart shaped GC mark, single line border initials above a flower. (Pcode 03088).

- 29.07 Heel type bowl dating from c1640-1660 from fieldwalking around Beverley (Acc No. 1470); rim bottered but not milled; stem bore 7/64". Marked with the initials GC on the heel. Heart shaped GC mark; pelleted border with initials above a flower. (Pcode 03060).
- 29.08 Heel type bowl dating from c1640-1660 from fieldwalking around Beverley (Acc No. 2278); rim bottered but not milled; stem bore 8/64". Marked with the initials GC on the heel. . (Pcode 04698).
- 29.09 Heel type bowl dating from c1640-1660 from fieldwalking around Beverley (Acc No. 1659); rim bottered but not milled; stem bore 7/64". Marked with the initials GC on the heel. Heart shaped GC mark; pelleted border with initials above a flower; ?cast ref. 475.7 to 475.43. (Pcode 02210).
- 29.10 Heel type bowl dating from c1640-1660 from fieldwalking around Beverley (Acc No. 1666); rim bottered but not milled; stem bore 7/64". Marked with the initials GC on the heel. Heart shaped GC mark, double line border initials above flower. (Pcode 02224).
- 29.11 Heel type bowl dating from c1640-1660 from fieldwalking around Beverley (Acc No. 1559); rim bottered but not milled; stem bore 7/64". Marked with the initials GC on the heel. Heart shaped GC mark; pelleted border with initials above a flower. (Pcode 03068).
- 29.12 Heel type bowl dating from c1640-1660 from fieldwalking around Beverley (Acc No. 1663); good burnish; rim bottered but not milled; stem bore 8/64". Marked with the initials GC on the heel. Heart shaped GC mark, double line border initials above flower. (Pcode 02220).
- 30.01 Spur type bowl dating from c1660-1680 from fieldwalking around Beverley (Acc No. 9); rim bottered and half milled; stem bore 7/64". (Pcode 03546).
- 30.02 Heel type bowl dating from c1650-1670 from fieldwalking around Beverley; average burnish; rim bottered but not milled. Marked with the initials IG on the heel. (Pcode 02875). Drawing by D A Higgins.
- 30.03 Heel type bowl dating from c1650-1670 from fieldwalking around Beverley (Acc No. 138); rim bottered and milled around all of the surviving rim; stem bore 7/64". (Pcode 03675).
- 30.04 Spur type bowl dating from c1660-1680 from fieldwalking around Beverley (Acc No. 10); average burnish; rim bottered and three quarters milled; stem bore 7/64". (Pcode 03547).
- 30.05 Heel type bowl dating from c1660-1680 from fieldwalking around Beverley (Acc No. 541); rim bottered and fully milled; stem bore 8/64". Milled heel. Very crude; similar to a Hull Type 1a; same mould as Pcode 4067, 4068 and 4069; milled heel. (Pcode 04066).

- 30.06 Heel type bowl dating from c1660-1680 from fieldwalking around Beverley (Acc No. 543); rim bottered but not milled; stem bore 7/64". Milled heel. Similar to Pcode 3705; same mould as Pcode 4066, 4067 and 4069; milled heel. (Pcode 04068).
- 30.07 Spur type bowl dating from c1660-1680 from fieldwalking around Beverley (Acc No. 103); rim bottered and one quarter milled; stem bore 7/64". Similar to Pcode 3550; highly fired. (Pcode 03640).
- 30.08 Spur type bowl dating from c1660-1680 from fieldwalking around Beverley (Acc No. 14); rim bottered but not milled; stem bore 7/64". (Pcode 03551).
- 30.09 Heel type bowl dating from c1660-1680 from fieldwalking around Beverley (Acc No. 511); rim bottered but not milled; stem bore 7/64". Similar to Pcode 3998; cut mark on heel. (Pcode 04036).
- 30.10 Heel type bowl dating from c1640-1670 from fieldwalking around Beverley (Acc No. 163); rim bottered but not milled; stem bore 7/64". (Pcode 03700).
- 30.11 Heel type bowl dating from c1660-1680 from fieldwalking around Beverley (Acc No. 236); rim bottered but not milled; stem bore 7/64". Stem shows signs of repair. (Pcode 03773).
- 30.12 Heel type bowl dating from c1640-1670 from fieldwalking around Beverley (Acc No. 1981); rim bottered but not milled; stem bore 7/64". Heart shaped heel; no milling but groove present. (Pcode 04656).
- 30.13 Heel type bowl dating from c1660-1680 from fieldwalking around Beverley (Acc No. 1372); poorly burnished; rim bottered but not milled; stem bore 7/64". Marked with the initials SV across the stem. (Pcode 02929). Drawing by D A Higgins
- 30.14 Heel type bowl dating from c1660-1680 from fieldwalking around Beverley (Acc No. 167); rim bottered and three quarters milled; stem bore 7/64". (Pcode 03704).
- 30.15 Heel type bowl dating from c1660-1680 from fieldwalking around Beverley (Acc No. 469); rim internally trimmed and bottered but not milled; stem bore 6/64". Heart shaped heel; waster. (Pcode 03994).
- 30.16 Bowl dating from c1650-1750 from fieldwalking around Beverley (Acc No. 1910); stem bore 6/64". Milled stem. (Pcode 04588).
- 30.17 Bowl dating from c1650-1750 from fieldwalking around Beverley (Acc No. 1911); stem bore 6/64". Cut marks on the stem, possibly used to disguise a repair; stem bore 4/64" at bowl end and 6/64" at other end. (Pcode 04589).
- 31.01 Spur type bowl dating from c1660-1680 from fieldwalking around Beverley (Acc No. 547); rim bottered but not milled; stem bore 7/64". Milled decoration on the stem. (Pcode 04072).

- 31.02 Heel type bowl dating from c1660-1680 from fieldwalking around Beverley (Acc No. 237); rim bottered but not milled; stem bore 7/64". (Pcode 03774).
- 31.03 Heel type bowl dating from c1660-1680 from fieldwalking around Beverley (Acc No. 238); rim internally trimmed, bottered and milled around all of the surviving rim; stem bore 7/64". (Pcode 03775).
- 31.04 Heel type bowl dating from c1660-1680 from fieldwalking around Beverley (Acc No. 1321); rim bottered but not milled; stem bore 7/64". Marked with the initials SV across the stem. Cross cut into heel. (Pcode 02926).
- 31.05 Spur type bowl dating from c1660-1680 from fieldwalking around Beverley (Acc No. 32); rim bottered but not milled; stem bore 8/64". (Pcode 03569).
- 31.06 Bowl dating from c1660-1680 from fieldwalking around Beverley (Acc No. 64); rim bottered but not milled; stem bore 8/64". (Pcode 03601).
- 31.07 Spur type bowl dating from c1640-1660 from fieldwalking around Beverley (Acc No. 166); rim bottered but not milled; stem bore 8/64". Very unusual spur bowl with multi stamp decoration and milled bands. (Pcode 02872). Drawing by D A Higgins.
- 31.08 Spur type bowl dating from c1660-1680 from fieldwalking around Beverley (Acc No. 15); rim bottered and three quarters milled; stem bore 8/64". (Pcode 03552).
- 31.09 Spur type bowl dating from c1660-1680 from fieldwalking around Beverley (Acc No. 552); rim bottered but not milled; stem bore 7/64"; milled decoration on the bowl. (Pcode 04077).
- 31.10 Heel type bowl dating from c1660-1680 from fieldwalking around Beverley (Acc No. 235); rim bottered but not milled; stem bore 8/64". (Pcode 03772).
- 31.11 Heel type bowl dating from c1660-1680 from fieldwalking around Beverley (Acc No. 168); rim bottered but not milled; stem bore 8/64". (Pcode 03705).
- 32.01 Heel type bowl dating from c1660-1680 from fieldwalking around Beverley (Acc No. 169); rim bottered and one quarter milled; stem bore 7/64". (Pcode 03706).
- 32.02 Heel type bowl dating from c1660-1680 from fieldwalking around Beverley (Acc No. 512); rim bottered but not milled; stem bore 7/64". Cut mark on heel. (Pcode 04037).
- 32.03 Heel type bowl dating from c1660-1680 from fieldwalking around Beverley (Acc No. 1989); rim bottered but not milled; stem bore 7/64". Heart shaped heel. (Pcode 04664).



- 32.04 Heel type bowl dating from c1680-1710 from fieldwalking around Beverley (Acc No. 1341); good burnish; rim bottered but not milled; stem bore 7/64". Marked with the initials SV across the stem. Similar to a Hull Type 3a. (Pcode 02959). Drawing by D A Higgins
- 32.05 Heel type bowl dating from c1660-1680 from fieldwalking around Beverley (Acc No. 470); rim internally trimmed and bottered but not milled; stem bore 5/64". Heart shaped heel; waster. (Pcode 03995).
- 32.06 Heel type bowl dating from c1660-1680 from fieldwalking around Beverley (Acc No. 529); milled around all of the surviving rim; stem bore 6/64". Milled heel; milled on all of surviving rim. (Pcode 04054).
- 32.07 Heel type bowl dating from c1660-1680 from fieldwalking around Beverley (Acc No. 170); rim bottered but not milled; stem bore 7/64". (Pcode 03707).
- 32.08 Spur type bowl dating from c1660-1680 from fieldwalking around Beverley (Acc No. 549); rim bottered but not milled; stem bore 7/64"; milled decoration on the stem. (Pcode 04074).
- 32.09 Spur type bowl dating from c1660-1680 from fieldwalking around Beverley (Acc No. 51); rim bottered but not milled; stem bore 8/64". (Pcode 03588).
- 32.10 Spur type bowl dating from c1660-1680 from fieldwalking around Beverley (Acc No. 16); rim bottered but not milled; stem bore 8/64". (Pcode 03553).
- 32.11 Heel type bowl dating from c1660-1680 from fieldwalking around Beverley (Acc No. 473); rim internally trimmed and cut but not milled; stem bore 6/64". Narrow waisted. (Pcode 03998).
- 32.12 Heel type bowl dating from c1660-1680 from fieldwalking around Beverley (Acc No. 171); rim bottered but not milled; stem bore 8/64". (Pcode 03708).
- 33.01 Heel type bowl dating from c1660-1700 from fieldwalking around Beverley (Acc No. 1379); average burnish; rim bottered but not milled; stem bore 6/64". Marked with the initials II on the heel. Single line border with large tobacco plant flanked by initials II. (Pcode 02743). Drawing by D A Higgins
- 33.02 Heel type bowl dating from c1660-1680 from fieldwalking around Beverley (Acc No. 472); rim internally trimmed and bottered but not milled; stem bore 7/64". (Pcode 03997).
- 33.03 Heel type bowl dating from c1670-1690 from fieldwalking around Beverley (Acc No. 1259); average burnish; rim bottered but not milled; stem bore 7/64". Marked with the initials IC on the heel. Single line border with IC at centre flanking tobacco plant. (Pcode 02781). Drawing by D A Higgins
- 33.04 Spur type bowl dating from c1660-1680 from fieldwalking around Beverley (Acc No. 69); rim bottered but not milled; stem bore 7/64". (Pcode 03606).

- 33.05 Heel type bowl dating from c1660-1680 from fieldwalking around Beverley (Acc No. 1149); good burnish; rim internally trimmed and bottered but not milled; stem bore 7/64". Marked with the initials WF on the heel. (Pcode 02814). Drawing by D A Higgins
- 33.06 Heel type bowl dating from c1660-1690 from fieldwalking around Beverley (Acc No. 1387); good burnish; rim bottered and three quarters milled; stem bore 6/64". Marked with the initials RF on the heel. No obvious burnish lines but very highly polished; RF flanking tobacco plant. (Pcode 02862). Drawing by D A Higgins
- 33.07 Heel type bowl dating from c1670-1700 from fieldwalking around Beverley (Acc No. 1288); good burnish; rim bottered but not milled; stem bore 6/64". Marked with the initials HN on the heel. Hull Type 2d/2e; ?Henry Norman of Hull. (Pcode 02865). Drawing by D A Higgins
- 33.08 Heel type bowl dating from c1660-1690 from fieldwalking around Beverley (Acc No. 475); rim internally trimmed and bottered but not milled; stem bore 7/64". (Pcode 04001).
- 33.09 Heel type bowl dating from c1660-1700 from fieldwalking around Beverley (Acc No. 471); rim bottered and one quarter milled; stem bore 7/64". (Pcode 03996).
- 33.10 Heel type bowl dating from c1660-1690 from fieldwalking around Beverley (Acc No. 202); rim bottered but not milled; stem bore 7/64". (Pcode 03739).
- 33.11 Heel type bowl dating from c1660-1690 from fieldwalking around Beverley (Acc No. 556); rim bottered and half milled; stem bore 7/64". Milled decoration on the stem. (Pcode 04081).
- 33.12 Heel type bowl dating from c1660-1700 from fieldwalking around Beverley (Acc No. 172); rim internally trimmed and bottered but not milled; stem bore 7/64". (Pcode 03709).
- 34.01 Heel type bowl dating from c1660-1690 from fieldwalking around Beverley (Acc No. 232); rim bottered but not milled; stem bore 7/64". (Pcode 03769).
- 34.02 Heel type bowl dating from c1660-1690 from fieldwalking around Beverley (Acc No. 233); rim bottered but not milled; stem bore 7/64". (Pcode 03770).
- 34.03 Heel type bowl dating from c1660-1690 from fieldwalking around Beverley (Acc No. 234); rim bottered and milled around all of the surviving rim; stem bore 8/64". (Pcode 03771).
- 34.04 Heel type bowl dating from c1680-1710 from fieldwalking around Beverley (Acc No. 558); rim bottered and milled around all of the surviving rim; stem bore 7/64". Similar to a Hull Type 3a; milled decoration on the back of the bowl near the stem. (Pcode 04083).

- 34.05 Heel type bowl dating from c1680-1710 from fieldwalking around Beverley (Acc No. 1733); average burnish; rim bottered but not milled; stem bore 6/64". Marked with the initials NT on the heel. Similar to a Hull Type 3a. (Pcode 02290).
- 34.06 Heel type bowl dating from c1680-1700 from fieldwalking around Beverley (Acc No. 239); rim bottered and milled around all of the surviving rim; stem bore 8/64". Very square heel; very shiny surface but no obvious signs of burnishing. (Pcode 03776).
- 34.07 Heel type bowl dating from c1680-1710 from fieldwalking around Beverley (Acc No. 1206); average burnish; rim bottered but not milled; stem bore 7/64". Marked with the initials FW on the heel. Similar to a Hull Type 3. (Pcode 02857). Drawing by D A Higgins
- 34.08 Spur type bowl dating from c1660-1680 from fieldwalking around Beverley (Acc No. 95); rim bottered and three quarters milled; stem bore 7/64". (Pcode 03632).
- 34.09 Heel type bowl dating from c1680-1710 from fieldwalking around Beverley (Acc No. 249); rim bottered but not milled; stem bore 6/64". (Pcode 03786).
- 34.10 Spur type bowl dating from c1680-1710 from fieldwalking around Beverley (Acc No. 553); rim bottered and one quarter milled; stem bore 7/64". Similar to Pcode 3786; milled decoration on the stem. (Pcode 04078).
- 34.11 Heel type bowl dating from c1680-1710 from fieldwalking around Beverley (Acc No. 1267); good burnish; rim bottered but not milled; stem bore 5/64". Marked with the initials RB on the heel. Single line border with RB at the centre. (Pcode 03226). Drawing by D A Higgins
- 35.01 Heel type bowl dating from c1680-1720 from fieldwalking around Beverley (Acc No. 2471); rim bottered and one quarter milled; stem bore 5/64". Marked with the initials RF on the sides of the heel. Possibly same mould as Pcode 4693. (Pcode 23544).
- 35.02 Heel type bowl dating from c1680-1710 from fieldwalking around Beverley; average burnish; rim bottered but not milled; stem bore 6/64". Marked with the initials NT on the heel. Similar to a Hull Type 4; no rim. (Pcode 02300). Drawing by D A Higgins
- 35.03 Heel type bowl dating from c1680-1710 from fieldwalking around Beverley (Acc No. 852); rim wiped but not milled; stem bore 6/64". Marked with the initials WW on the sides of the heel. (Pcode 04377).
- 35.04 Heel type bowl dating from c1680-1710 from fieldwalking around Beverley (Acc No. 1838); average burnish; rim bottered but not milled. Marked with the initials ?SV on the heel. (Pcode 02446). Drawing by D A Higgins

- 35.05 Heel type bowl dating from c1680-1710 from fieldwalking around Beverley (Acc No. 1227); rim bottered but not milled; stem bore 5/64". Marked with the initials RL on the bowl facing the smoker. Examples from Kew Gardens; Southwark Bridge; and Crabtree Wharf, Fulham. (Pcode 02882). Drawing by D A Higgins
- 35.06 Heel type bowl dating from c1680-1710 from fieldwalking around Beverley (Acc No. 631); rim bottered but not milled; stem bore 7/64". Marked with the initials RC on the sides of the heel. ?Robert Chapman; Robert Carbut or Robert Cook. (Pcode 04156).
- 35.07 Heel type bowl dating from c1680-1710 from fieldwalking around Beverley (Acc No. 674); rim internally trimmed, bottered and half milled; stem bore 6/64". Marked with the initials ID on the sides of the heel. ?John Dalton (1); similar to Pcode 4200-4206. (Pcode 04199).
- 35.08 Heel type bowl dating from c1680-1710 from fieldwalking around Beverley (Acc No. 640); good burnish; rim wiped but not milled; stem bore 6/64". Marked with the initials RC on the sides of the heel. ?Robert Chapman; Robert Carbut or Robert Cook; ?same mould as Pcode 4166-4171. (Pcode 04165).
- 35.09 Heel type bowl dating from c1680-1710 from fieldwalking around Beverley (Acc No. 413); rim bottered but not milled; stem bore 6/64". (Pcode 03939).
- 35.10 Heel type bowl dating from c1680-1710 from fieldwalking around Beverley (Acc No. 661); rim bottered but not milled; stem bore 6/64". Marked with the initials TC on the sides of the heel. ?Thomas Chapman or Thomas Cooke; bowl patinated to give impression of white slip on red fabric. (Pcode 04186).
- 35.11 Heel type bowl dating from c1680-1710 from fieldwalking around Beverley (Acc No. 1874); rim bottered but not milled; stem bore 6/64". Marked with the initials GI on the heel. (Pcode 04582). Drawing by D A Higgins
- 35.12 Heel type bowl dating from c1700-1770 from fieldwalking around Beverley (Acc No. 823); rim cut but not milled; stem bore 5/64". Marked with the initials WP on the sides of the heel. ?W Palmer/W Pattinson/ W Potter (1) or (2). (Pcode 04348).
- 36.01 Heel type bowl dating from c1680-1710 from fieldwalking around Beverley (Acc No. 485); poorly burnished; rim internally trimmed, bottered and three quarters milled; stem bore 6/64". (Pcode 04010).
- 36.02 Heel type bowl dating from c1700-1770 from fieldwalking around Beverley (Acc No. 252); rim internally trimmed and bottered but not milled; stem bore 7/64". (Pcode 03789).
- 36.03 Heel type bowl dating from c1700-1770 from fieldwalking around Beverley (Acc No. 591); rim bottered but not milled; stem bore 5/64". Marked with

the initials RB on the sides of the heel. ?same mould as Pcode 4114-4116 & 4117; ? Robert Burrill 1 or 2, or Robert Bell. (Pcode 04116).

- 36.04 Heel type bowl dating from c1700-1770 from fieldwalking around Beverley (Acc No. 410); rim internally trimmed and wiped but not milled; stem bore 5/64". (Pcode 03936).
- 36.05 Heel type bowl dating from c1700-1770 from fieldwalking around Beverley (Acc No. 911); rim internally trimmed and cut but not milled; stem bore 5/64". Marked with the initials RT on the sides of the heel. ?Richard Tock (1) or (2)/Robert Tock; ?same mould as Pcode 4437-4439; internally trimmed. (Pcode 04436).
- 36.06 Heel type bowl dating from c1700-1770 from fieldwalking around Beverley (Acc No. 685); rim internally trimmed and possibly wiped but not milled; stem bore 5/64". Marked with the initials IG on the sides of the heel. ?John Goldwell (1) or (2); same mould as Pcode 4211-4220. (Pcode 04210).
- 36.07 Heel type bowl dating from c1700-1770 from fieldwalking around Beverley (Acc No. 915); rim cut but not milled; stem bore 5/64". Marked with the initials RT on the sides of the heel. ?Richard Tock (1) or (2)/Robert Tock; ?same mould as Pcode 4441-4451. (Pcode 04440).
- 36.08 Heel type bowl dating from c1700-1770 from fieldwalking around Beverley (Acc No. 962); rim cut but not milled; stem bore 5/64". Marked with the initials RT on the sides of the heel. ?Richard Tock (1) or (2)/Robert Tock; shorter bowl. (Pcode 04487).
- 36.09 Heel type bowl dating from c1700-1770 from fieldwalking around Beverley (Acc No. 583); rim internally trimmed and bottered but not milled; stem bore 6/64". Marked with the initials RB on the sides of the heel. ?same mould as Pcode 4107, 4109-4113; ? Robert Burrill 1 or 2, or Robert Bell. (Pcode 04108).
- 36.10 Heel type bowl dating from c1700-1770 from fieldwalking around Beverley (Acc No. 669); rim wiped but not milled; stem bore 5/64". Marked with the initials TC on the sides of the heel. ?Thomas Chapman, Thomas Cooke or Thomas Craven; ?same mould as Pcode 4193, 4195-4196. (Pcode 04194).
- 36.11 Heel type bowl dating from c1700-1770 from fieldwalking around Beverley (Acc No. 794); rim cut but not milled; stem bore 6/64". Marked with the initials WK on the sides of the heel. ?William Kyte of Hull; similar to a Hull Type 7e; same mould as Pcode 4320 & 4321. (Pcode 04319).
- 36.12 Heel type bowl dating from c1700-1770 from fieldwalking around Beverley (Acc No. 629); rim cut but not milled; stem bore 5/64". Marked with the initials RC on the sides of the heel. ?Robert Chapman; Robert Carbut or Robert Cook. (Pcode 04154).

- 37.01 Heel type bowl dating from c1700-1770 from fieldwalking around Beverley (Acc No. 810); rim cut but not milled; stem bore 5/64". Marked with the initials HN on the sides of the heel. ?Henry Norman (2); very crude lettering; same mould as Pcode 4336. (Pcode 04335).
- 37.02 Heel type bowl dating from c1700-1770 from fieldwalking around Beverley (Acc No. 421); rim internally trimmed and bottered but not milled; stem bore 6/64". Same mould as Pcode 3948, 3949 & 3950; mark illegible. (Pcode 03947).
- 37.03 Heel type bowl dating from c1700-1750 from fieldwalking around Beverley (Acc No. 411); rim bottered but not milled; stem bore 5/64". (Pcode 03937).
- 37.04 Heel type bowl dating from c1690-1730 from fieldwalking around Beverley (Acc No. 1266); poorly burnished; rim cut but not milled; stem bore 4/64". Marked with the initials TT on the bowl facing the smoker. Moulded dots on heel. (Pcode 02884). Drawing by D A Higgins
- 37.05 Heel type bowl dating from c1700-1770 from fieldwalking around Beverley (Acc No. 436) but not milled; stem bore 5/64". Lozenge of pellets on sides of the bowl and dot on the sides of the heel. (Pcode 03962).
- 37.06 Heel type bowl dating from c1700-1770 from fieldwalking around Beverley (Acc No. 250); rim internally trimmed and bottered but not milled; stem bore 5/64". (Pcode 03787).
- 37.07 Heel type bowl dating from c1710-1750 from fieldwalking around Beverley (Acc No. 383); rim wiped but not milled; stem bore 6/64". (Pcode 03909).
- 37.08 Heel type bowl dating from c1680-1720 from fieldwalking around Beverley (Acc No. 390); rim internally trimmed and wiped but not milled; stem bore 6/64". (Pcode 03916).
- 37.09 Heel type bowl dating from c1700-1770 from fieldwalking around Beverley (Acc No. 396); rim cut but not milled; stem bore 5/64". Large heel. (Pcode 03922).
- 37.10 Spur type bowl dating from c1780-1810 from fieldwalking around Beverley (Acc No. 765); rim cut but not milled; stem bore 4/64". Marked with the initials SG on the sides of the spur. Samuel Goldwell: inverted S; same mould as Pcode 4291-4294. (Pcode 04290).
- 37.11 Heel type bowl dating from c1700-1770 from fieldwalking around Beverley (Acc No. 412); rim cut but not milled; stem bore 6/64". (Pcode 03938).
- 37.12 Heel type bowl dating from c1700-1770 from fieldwalking around Beverley (Acc No. 404); rim cut; stem bore 5/64". (Pcode 03930).
- 38.01 Heel type bowl dating from c1700-1770 from fieldwalking around Beverley (Acc No. 667); rim possibly wiped but not milled; stem bore 5/64". Marked

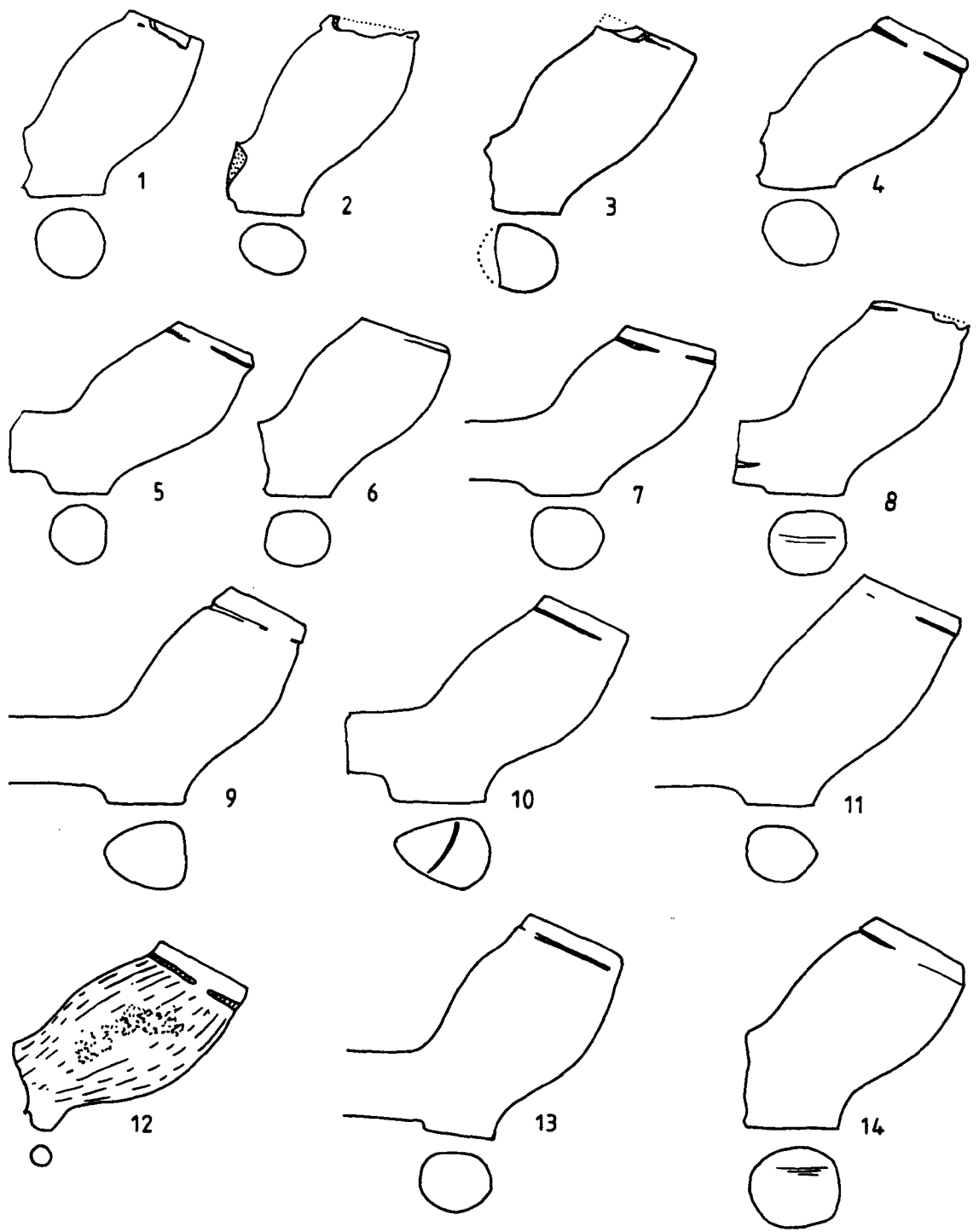
with the initials TC on the sides of the heel. ?Thomas Chapman, Thomas Cooke or Thomas Craven; ?same mould as Pcode 4191. (Pcode 04192).

- 38.02 Heel type bowl dating from c1700-1770 from fieldwalking around Beverley (Acc No. 662); rim cut but not milled; stem bore 5/64". Marked with the initials TC on the sides of the heel. ?Thomas Chapman, Thomas Cooke or Thomas Craven; ?same mould as Pcode 4188-4190. (Pcode 04187).
- 38.03 Heel type bowl dating from c1700-1770 from fieldwalking around Beverley (Acc No. 817); rim cut but not milled; stem bore 5/64". Marked with the initials WP on the sides of the heel. ?W Palmer/W Pattinson/ W Potter (1) or (2); same mould as Pcode 4341, 4343-4344. (Pcode 04342).
- 38.04 Heel type bowl dating from c1700-1770 from fieldwalking around Beverley (Acc No. 932); rim cut but not milled; stem bore 5/64". Marked with the initials RT on the sides of the heel. ?Richard Tock (1) or (2)/Robert Tock; ?same mould as Pcode 4452-4456, 4458-4468. (Pcode 04457).
- 38.05 Heel type bowl dating from c1700-1770 from fieldwalking around Beverley (Acc No. 826); rim cut but not milled; stem bore 5/64". Marked with the initials IR on the sides of the heel. ?John Read or John Robson. (Pcode 04351).
- 38.06 Bowl dating from c1700-1770 from fieldwalking around Beverley (Acc No. 428); rim internally trimmed and wiped but not milled; stem bore 4/64". (Pcode 03954).
- 38.07 Spur type bowl dating from c1700-1770 from fieldwalking around Beverley (Acc No. 253); rim wiped but not milled; stem bore 5/64". Flaring spur. (Pcode 03790).
- 38.08 Heel type bowl dating from c1690-1710 from fieldwalking around Beverley (Acc No. 500); rim bottered but not milled; stem bore 6/64". Marked with a dot on the side of the heel. Dot on both sides of heel. (Pcode 04025).
- 38.09 Heel type bowl dating from c1700-1770 from fieldwalking around Beverley (Acc No. 499); rim cut but not milled; stem bore 5/64". Marked with a dot on the side of the heel. Dot on both sides of heel. (Pcode 04024).
- 38.10 Heel type bowl dating from c1700-1770 from fieldwalking around Beverley (Acc No. 498); rim cut but not milled; stem bore 6/64". Marked with a dot on the side of the heel. Dot on smokers right. (Pcode 04023).
- 38.11 Heel type bowl dating from c1680-1720 from fieldwalking around Beverley (Acc No. 372); rim internally trimmed and cut but not milled; stem bore 6/64". (Pcode 03898).
- 38.12 Heel type bowl dating from c1680-1720 from fieldwalking around Beverley (Acc No. 374); rim internally trimmed and bottered but not milled; stem bore 6/64". (Pcode 03900).

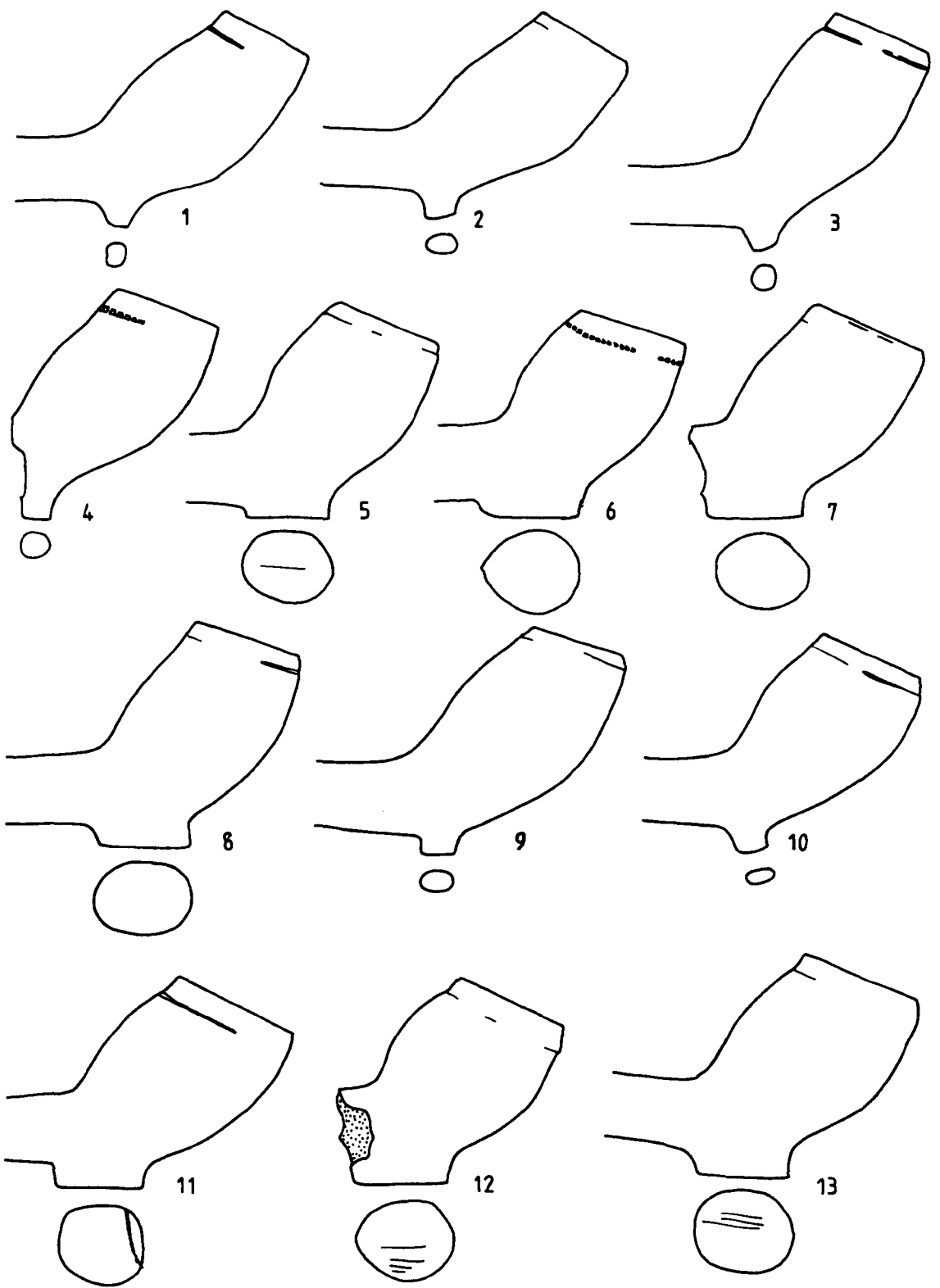
- 39.01 Heel type bowl dating from c1680-1720 from fieldwalking around Beverley (Acc No. 380); rim internally trimmed and cut but not milled; stem bore 4/64". (Pcode 03906).
- 39.02 Heel type bowl dating from c1700-1770 from fieldwalking around Beverley (Acc No. 394); rim cut but not milled; stem bore 7/64". Very white fabric. (Pcode 03920).
- 39.03 Heel type bowl dating from c1700-1770 from fieldwalking around Beverley (Acc No. 402); rim internally trimmed but not milled; stem bore 5/64". Very small heel in relation to bowl size. (Pcode 03928).
- 39.04 Heel type bowl dating from c1680-1720 from fieldwalking around Beverley (Acc No. 379); rim internally trimmed and wiped but not milled; stem bore 5/64". (Pcode 03905).
- 39.05 Heel type bowl dating from c1700-1770 from fieldwalking around Beverley (Acc No. 407); rim internally trimmed and cut but not milled; stem bore 5/64". (Pcode 03933).
- 39.06 Heel type bowl dating from c1680-1720 from fieldwalking around Beverley (Acc No. 373); stem bore 6/64". Possible moulded decoration on right side of the bowl. (Pcode 03899).
- 39.07 Heel type bowl dating from c1700-1770 from fieldwalking around Beverley (Acc No. 251); rim cut but not milled; stem bore 5/64". (Pcode 03788).
- 39.08 Spur type bowl dating from c1710-1800 from fieldwalking around Beverley (Acc No. 351); rim internally trimmed and cut but not milled; stem bore 4/64". (Pcode 03877).
- 39.09 Spur type bowl dating from c1780-1810 from fieldwalking around Beverley (Acc No. 805); stem bore 4/64". Marked with the initials WM on the sides of the spur. No rim; ?same mould as Pcode 4331. (Pcode 04330).
- 39.10 Spur type bowl dating from c1780-1810 from fieldwalking around Beverley (Acc No. 755); rim internally trimmed and cut but not milled; stem bore 4/64". Marked with the initials SG on the sides of the spur. Samuel Goldwell; same mould as Pcode 4281-4289. (Pcode 04280).
- 39.11 Spur type bowl dating from c1780-1810 from fieldwalking around Beverley (Acc No. 735); rim internally trimmed and cut but not milled; stem bore 4/64". Marked with the initials IG on the sides of the spur. ?John Goldwell (2); same mould as Pcode 4259, 4261-4264. (Pcode 04260).
- 39.12 Bowl dating from c1710-1780 from fieldwalking around Beverley (Acc No. 360); rim cut but not milled; stem bore 5/64". (Pcode 03886).



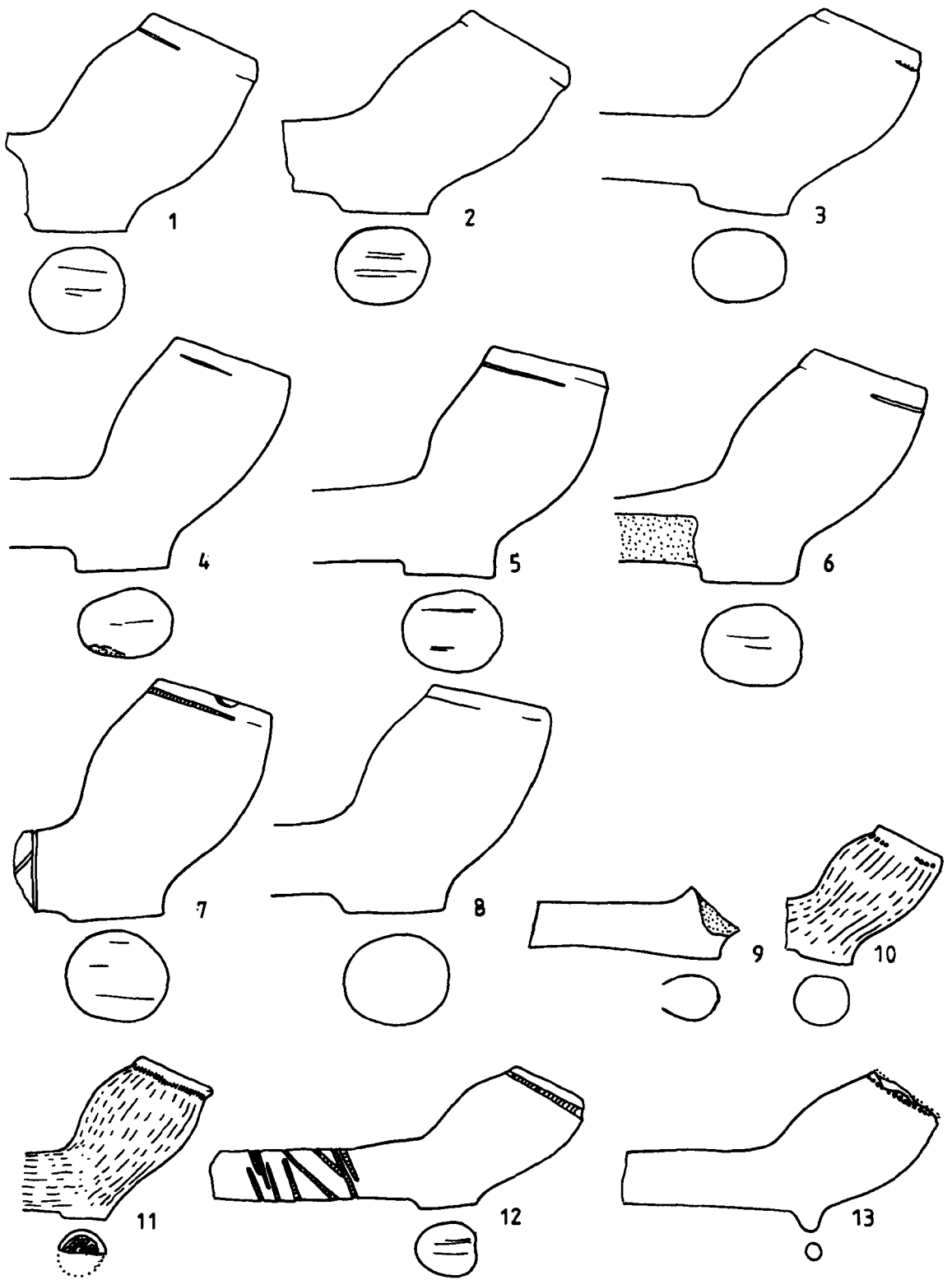
- 40.01 Spur type bowl dating from c1710-1780 from fieldwalking around Beverley (Acc No. 364); average burnish; rim wiped but not milled; stem bore 4/64". (Pcode 03890).
- 40.02 Spur type bowl dating from c1710-1780 from fieldwalking around Beverley (Acc No. 361); rim internally trimmed and cut but not milled; stem bore 3/64". (Pcode 03887).
- 40.03 Heel type bowl dating from c1660-1700 from fieldwalking around Beverley (Acc No. 1912); stem bore 6/64". Marked with cut stem. (Pcode 04590).
- 40.04 Heel type bowl dating from c1650-1750 from fieldwalking around Beverley (Acc No. 1908); stem bore 7/64". Milled stem. (Pcode 04586).
- 40.05 Spur type bowl dating from c1660-1680 from Louth, Lincolnshire; finely burnished; rim bottered and fully milled. Marked with the initials dion the sides of the spur as well as the letters SV across the stem. Drawing by D A Higgins
- 40.06 Complete hair curler, from fieldwalking around Beverley. Drawing by D A Higgins
- 40.07 Complete hair curler, from fieldwalking around Beverley, with burnished mid section. Drawing by D A Higgins
- 40.08 Complete hair curler, from fieldwalking around Beverley. Drawing by D A Higgins
- 40.09 Complete hair curler, from fieldwalking around Beverley, marked at one end with the initials WB. Drawing by D A Higgins
- 40.10 Complete hair curler, from fieldwalking around Beverley. Drawing by D A Higgins
- 40.11 Complete hair curler, from fieldwalking around Beverley, marked at one end with the initials WA. Drawing by D A Higgins
- 40.12 Complete hair curler, from fieldwalking around Beverley, marked at one end with the initials WA. Drawing by D A Higgins
- 40.13 Half a hair curler, from fieldwalking around Beverley, with striations clearly visible and stamped with the initials WA. Drawing by D A Higgins
- 40.14 Half a hair curler, from fieldwalking around Beverley, stamped with the crowned initials IB. Drawing by D A Higgins
- 40.15 Half a hair curler, from fieldwalking around Beverley, with a burnished mid section and stamped with the lettering HULL. Drawing by D A Higgins



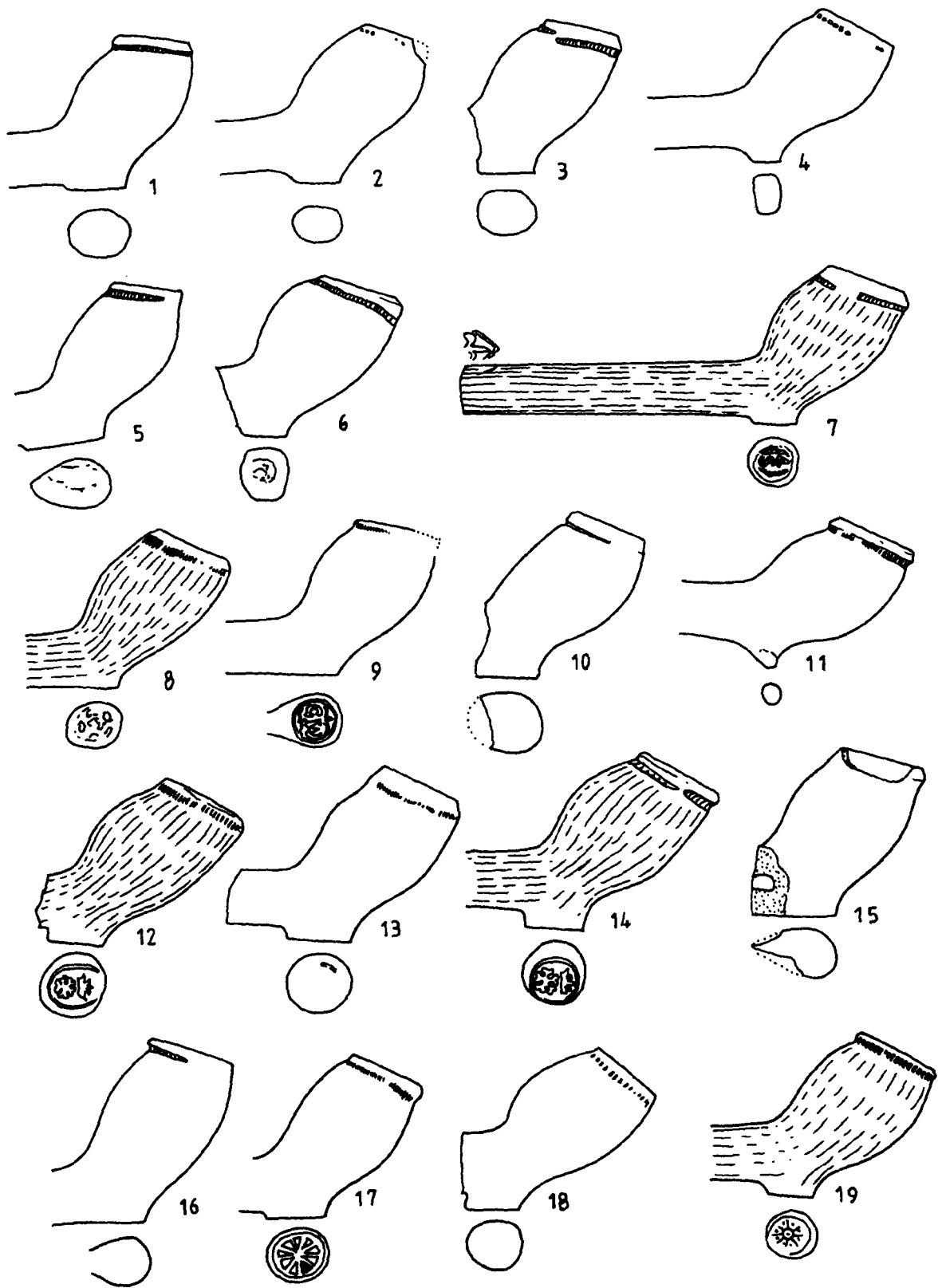
**Figure 23:** Pipes from the Rayner Collection, Beverley. Scale 1:1.



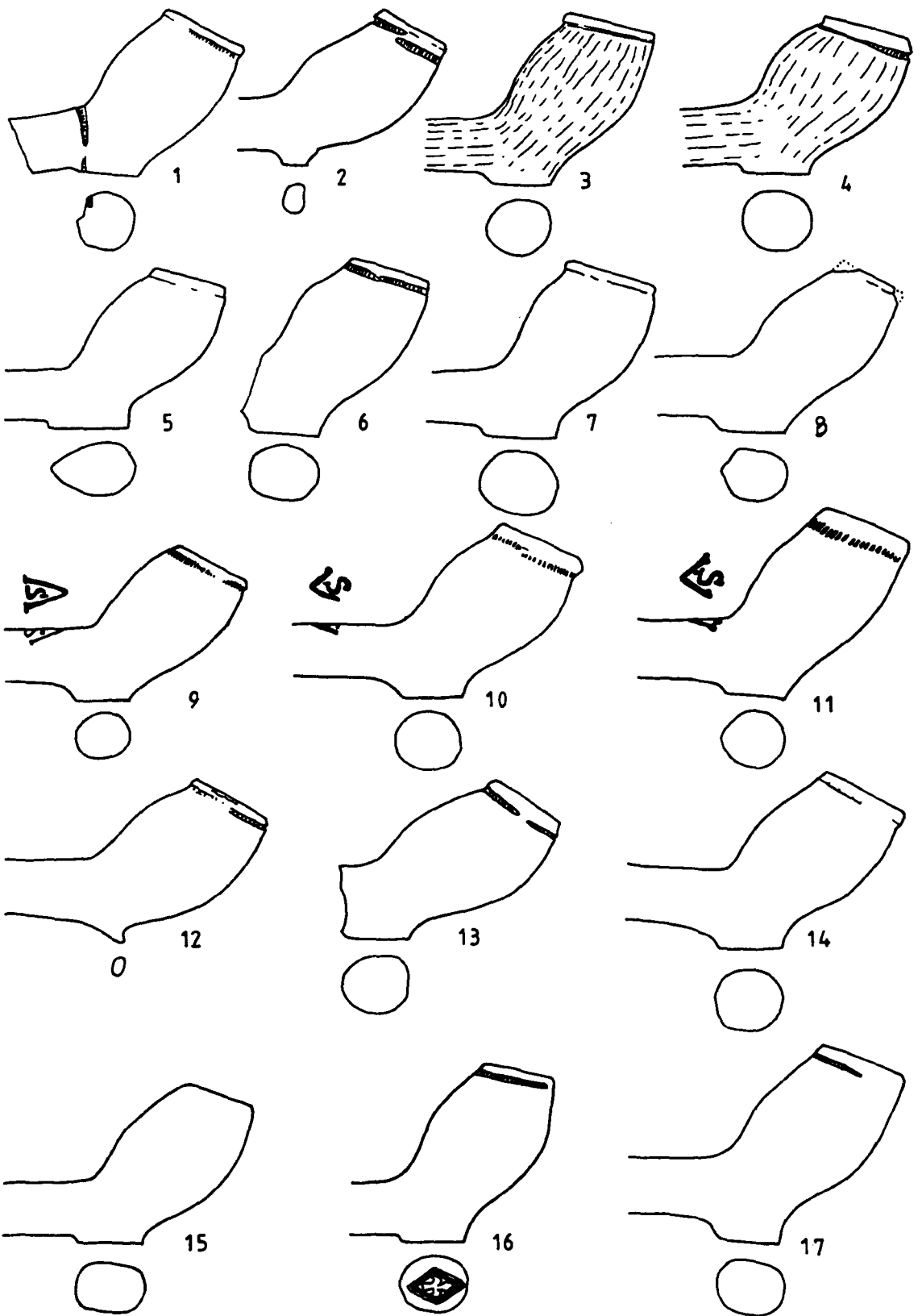
**Figure 24:** Pipes from the Rayner Collection, Beverley. Scale 1:1.



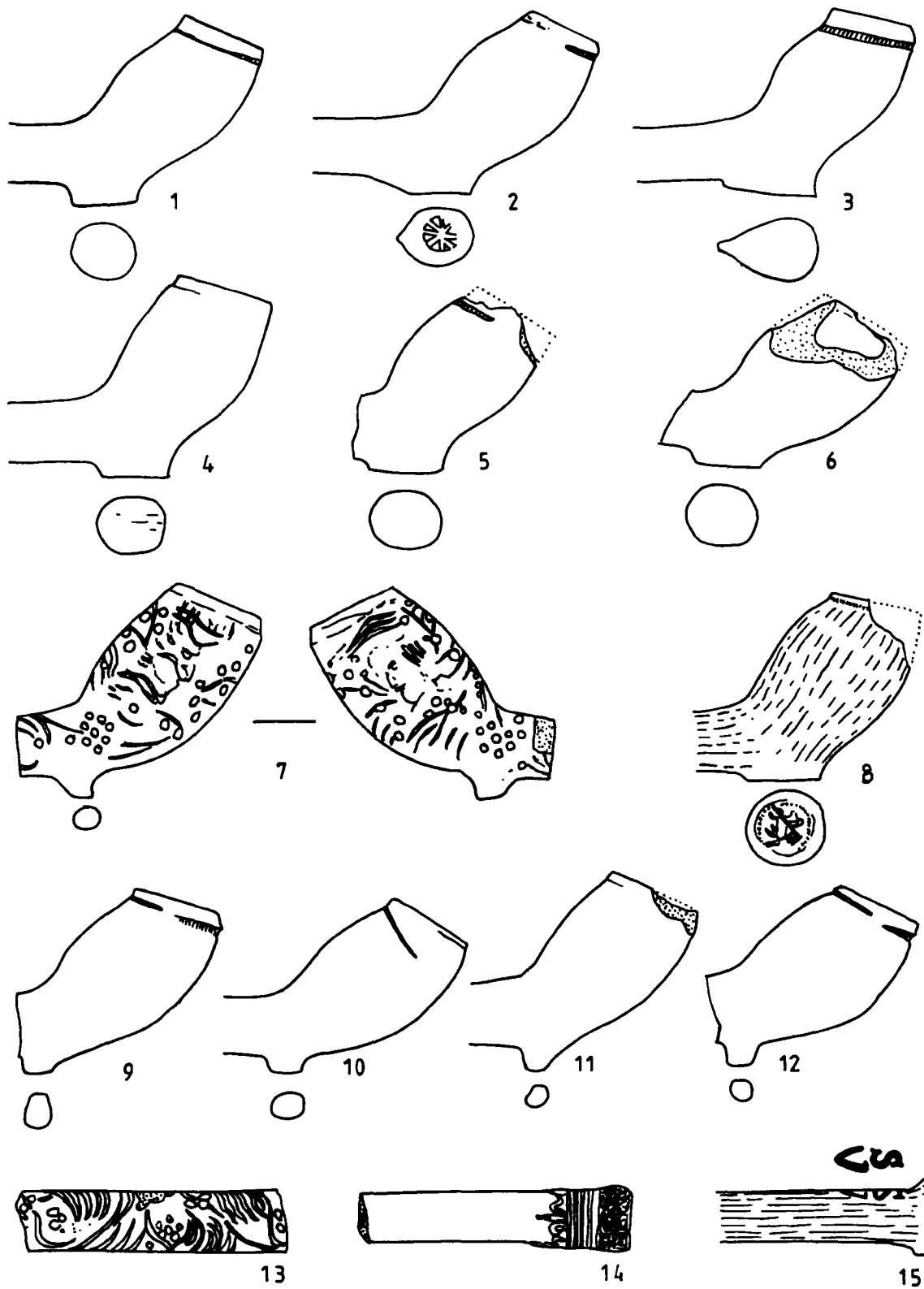
**Figure 25:** Pipes from the Rayner Collection, Beverley. Scale 1:1.



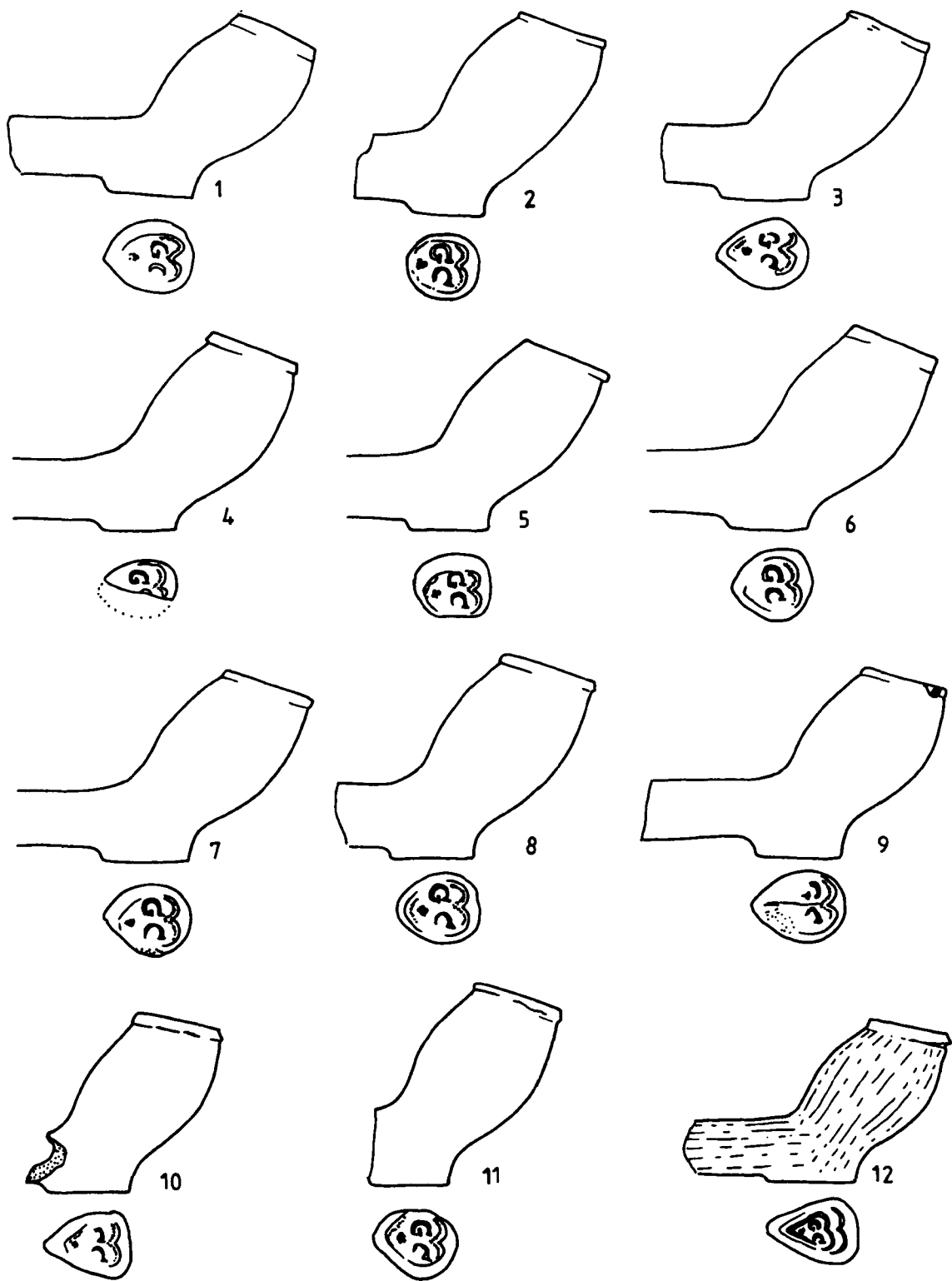
**Figure 26: Pipes from the Rayner Collection, Beverley. Scale 1:1.**



**Figure 27: Pipes from the Rayner Collection, Beverley. Scale 1:1.**

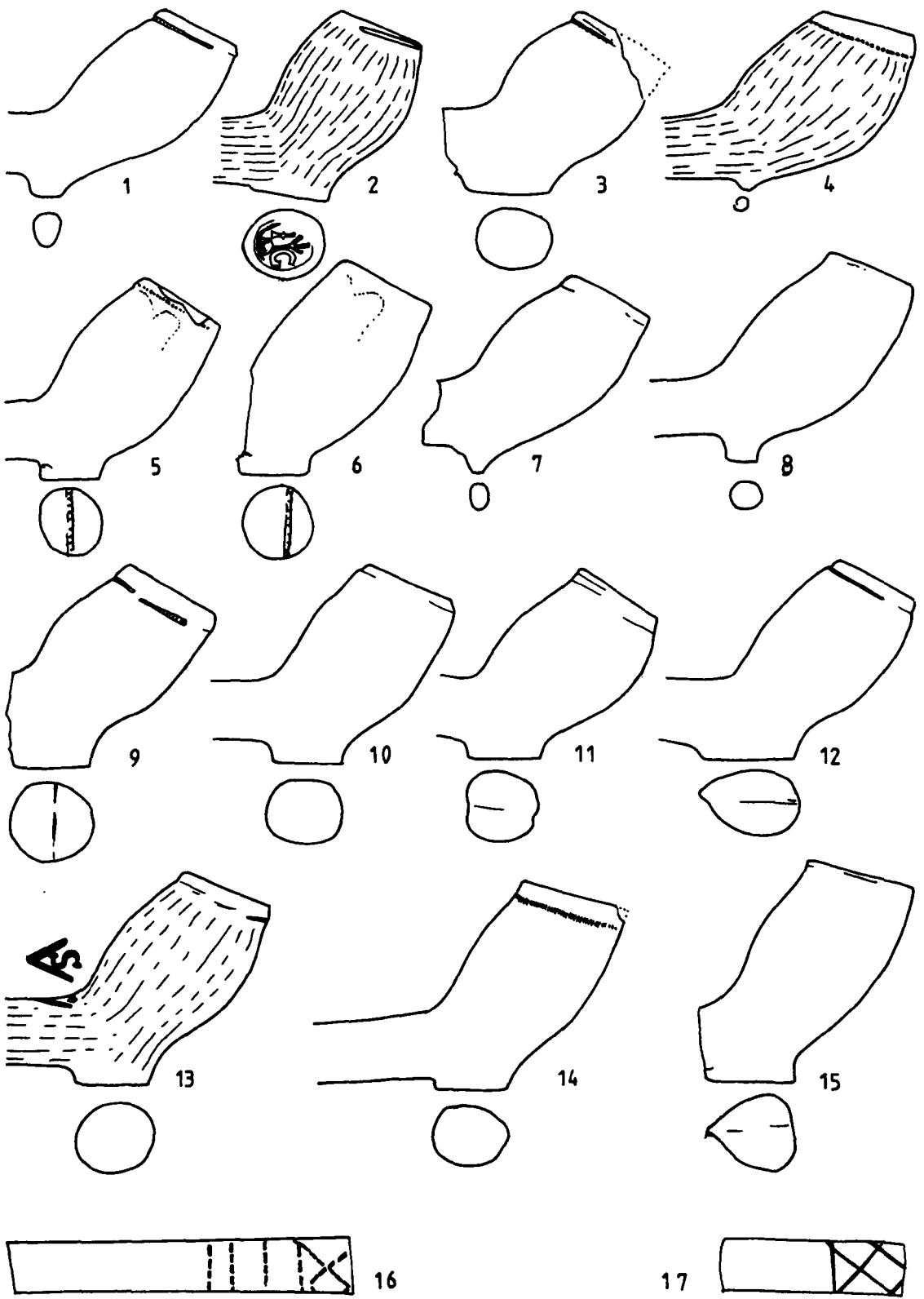


**Figure 28:** Pipes from the Rayner Collection, Beverley. Scale 1:1.

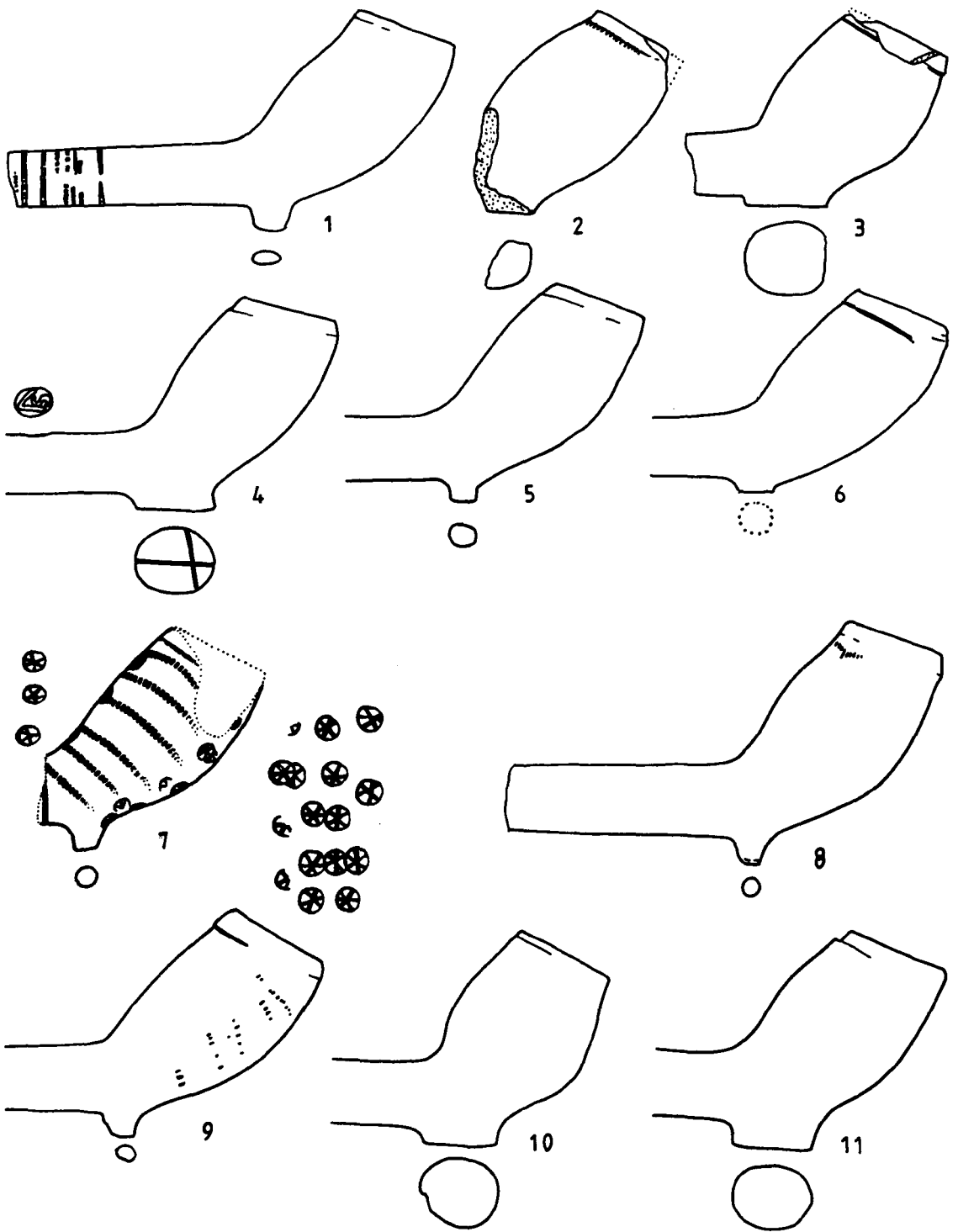


**Figure 29: Pipes from the Rayner Collection, Beverley. Scale 1:1.**

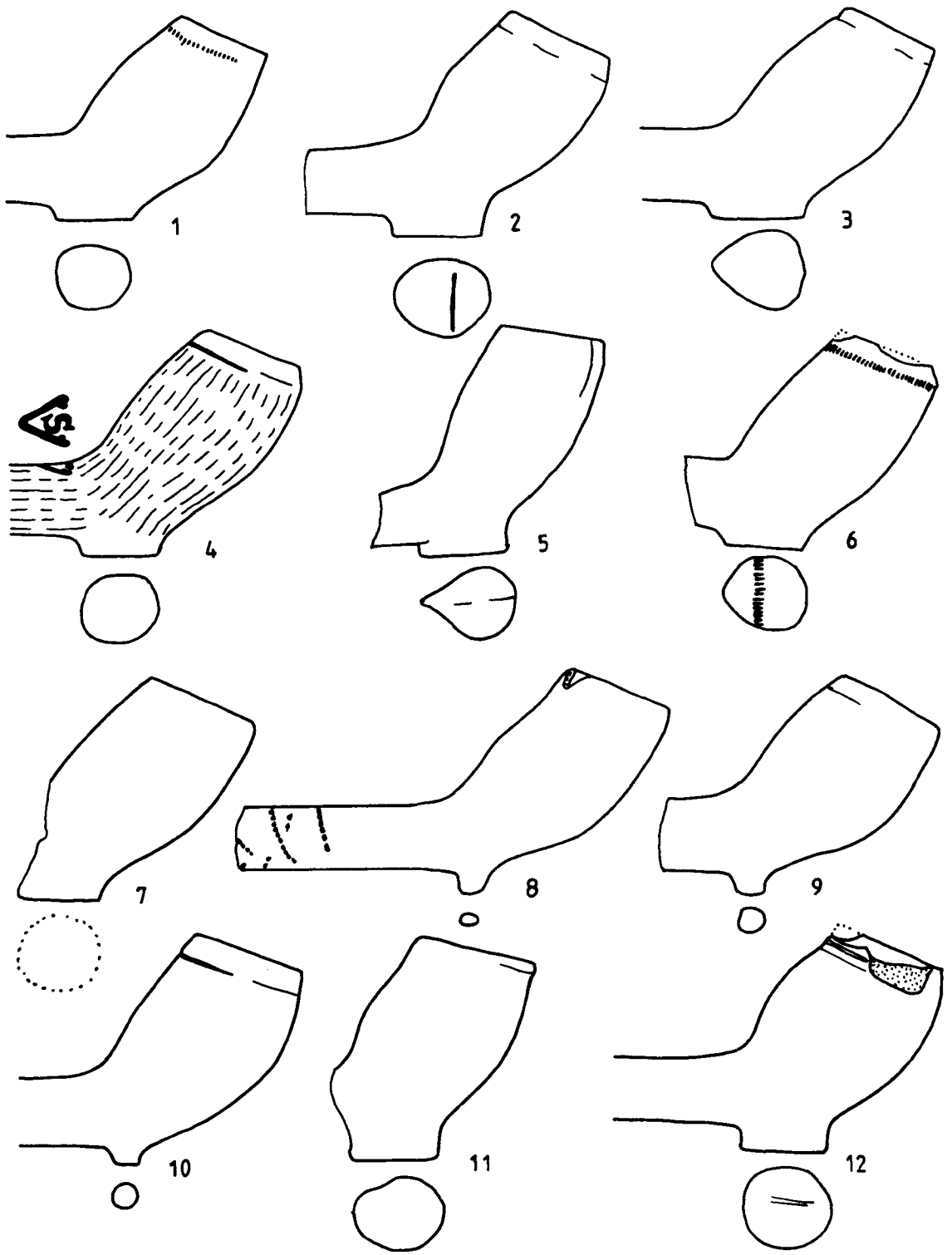




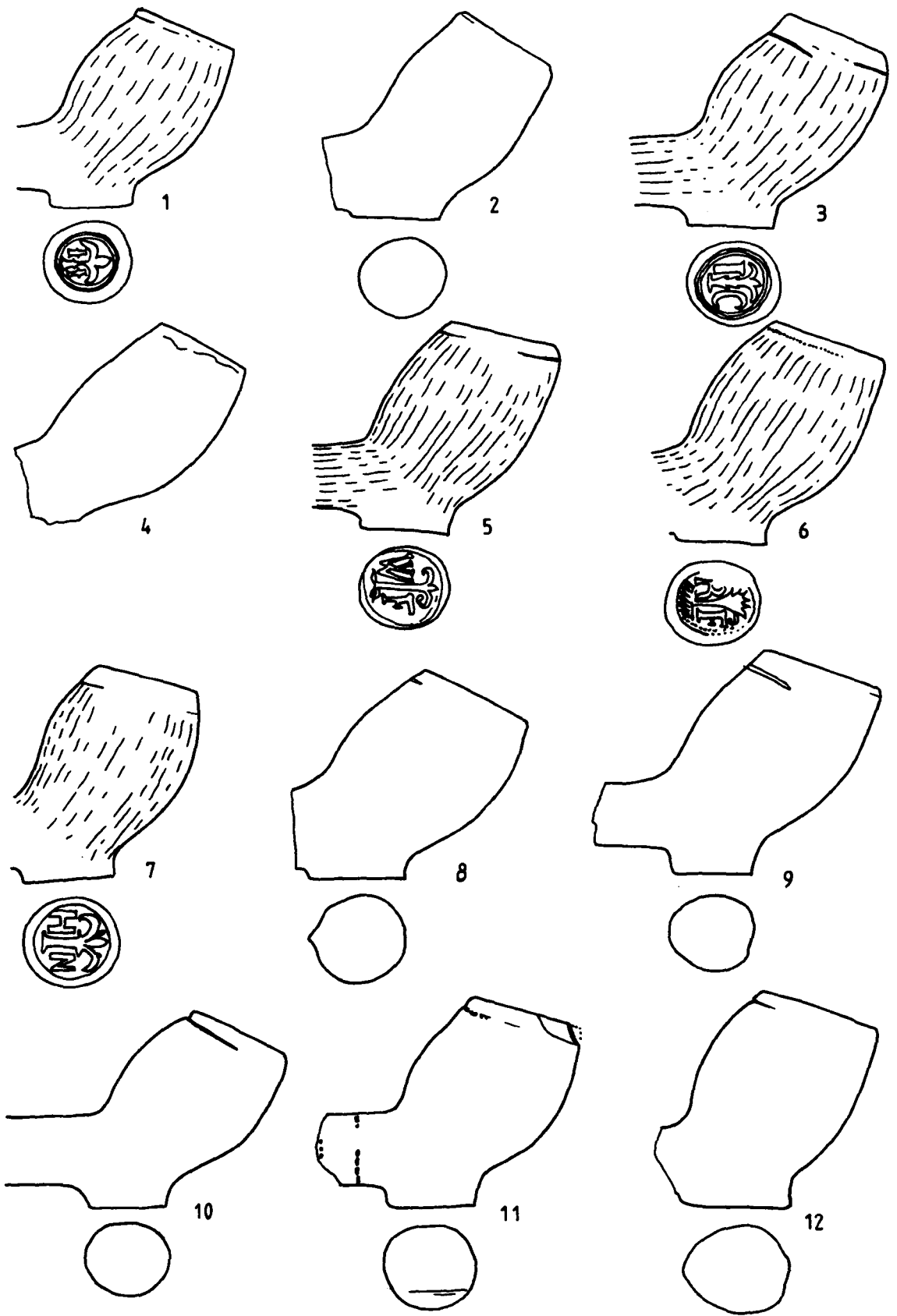
**Figure 30: Pipes from the Rayner Collection, Beverley. Scale 1:1.**



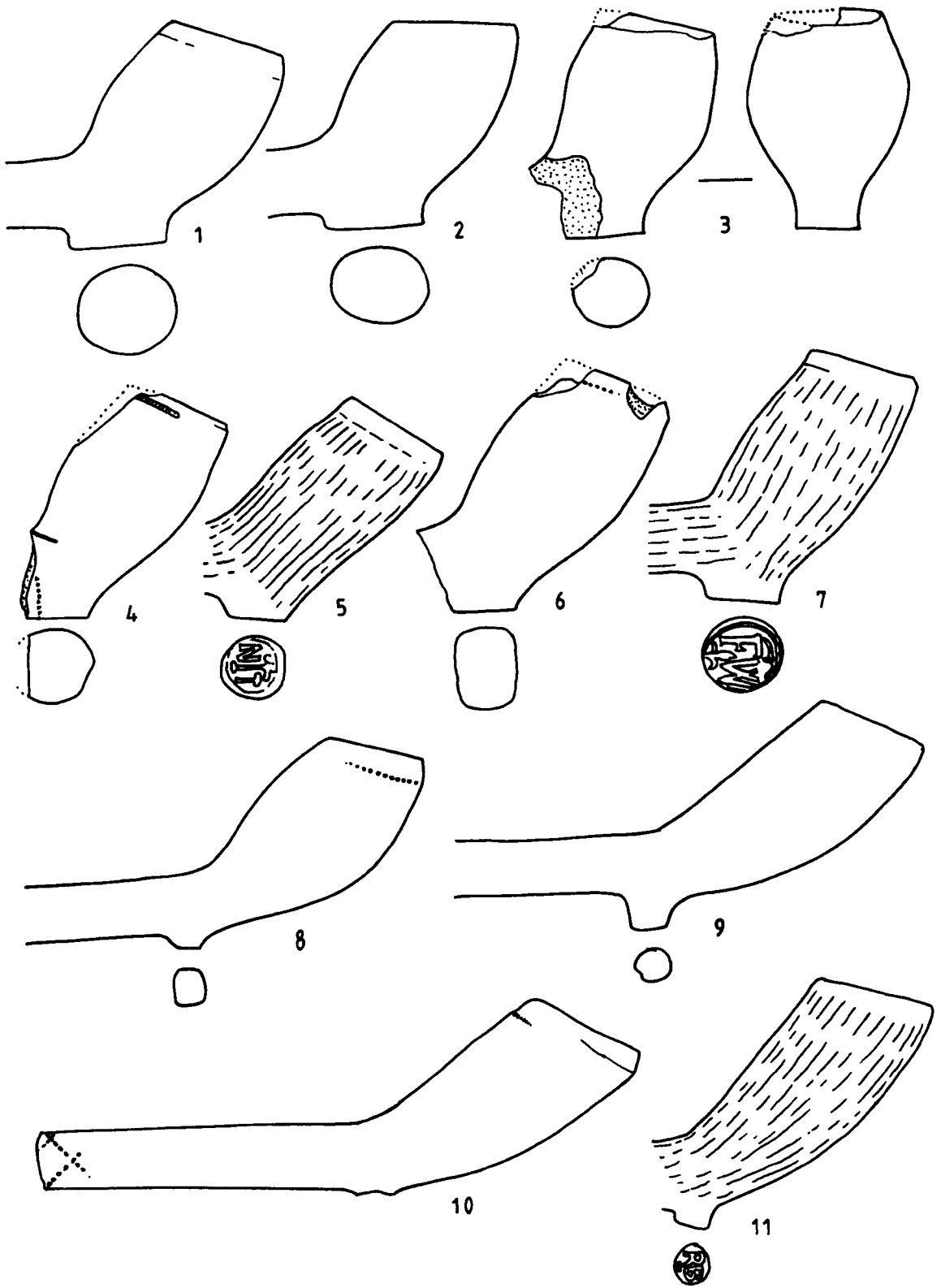
**Figure 31:** Pipes from the Rayner Collection, Beverley. Scale 1:1.



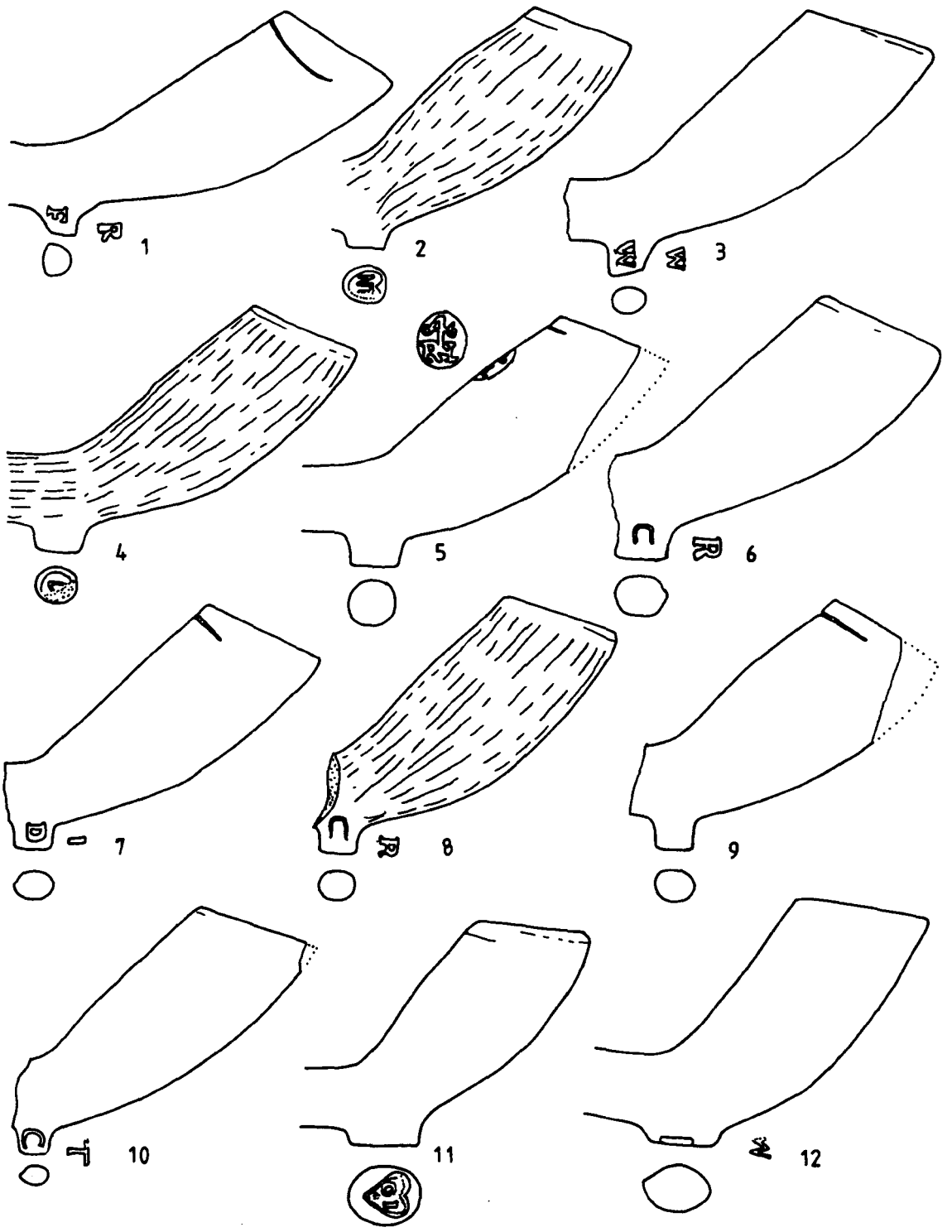
**Figure 32: Pipes from the Rayner Collection, Beverley. Scale 1:1.**



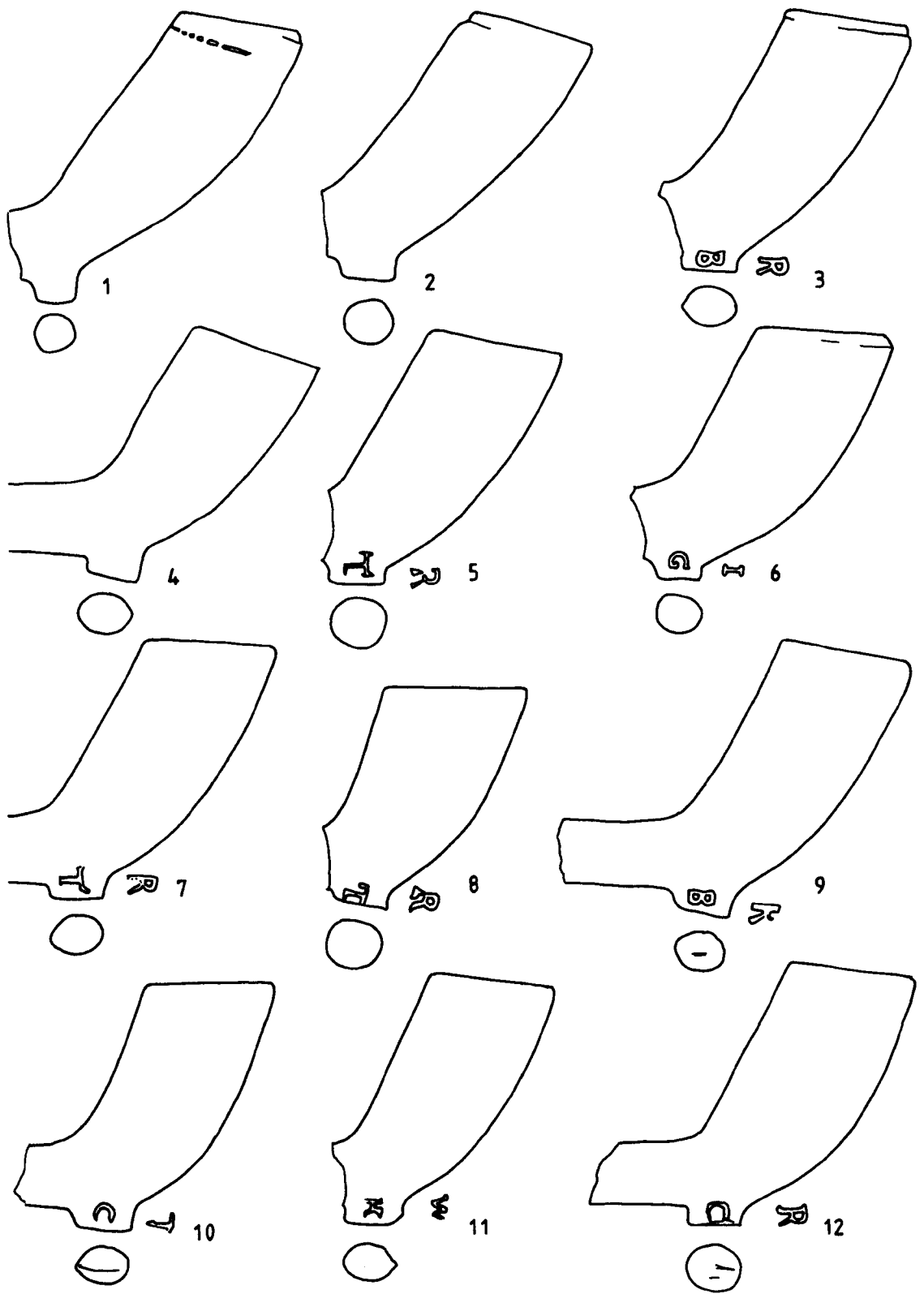
**Figure 33: Pipes from the Rayner Collection, Beverley. Scale 1:1.**



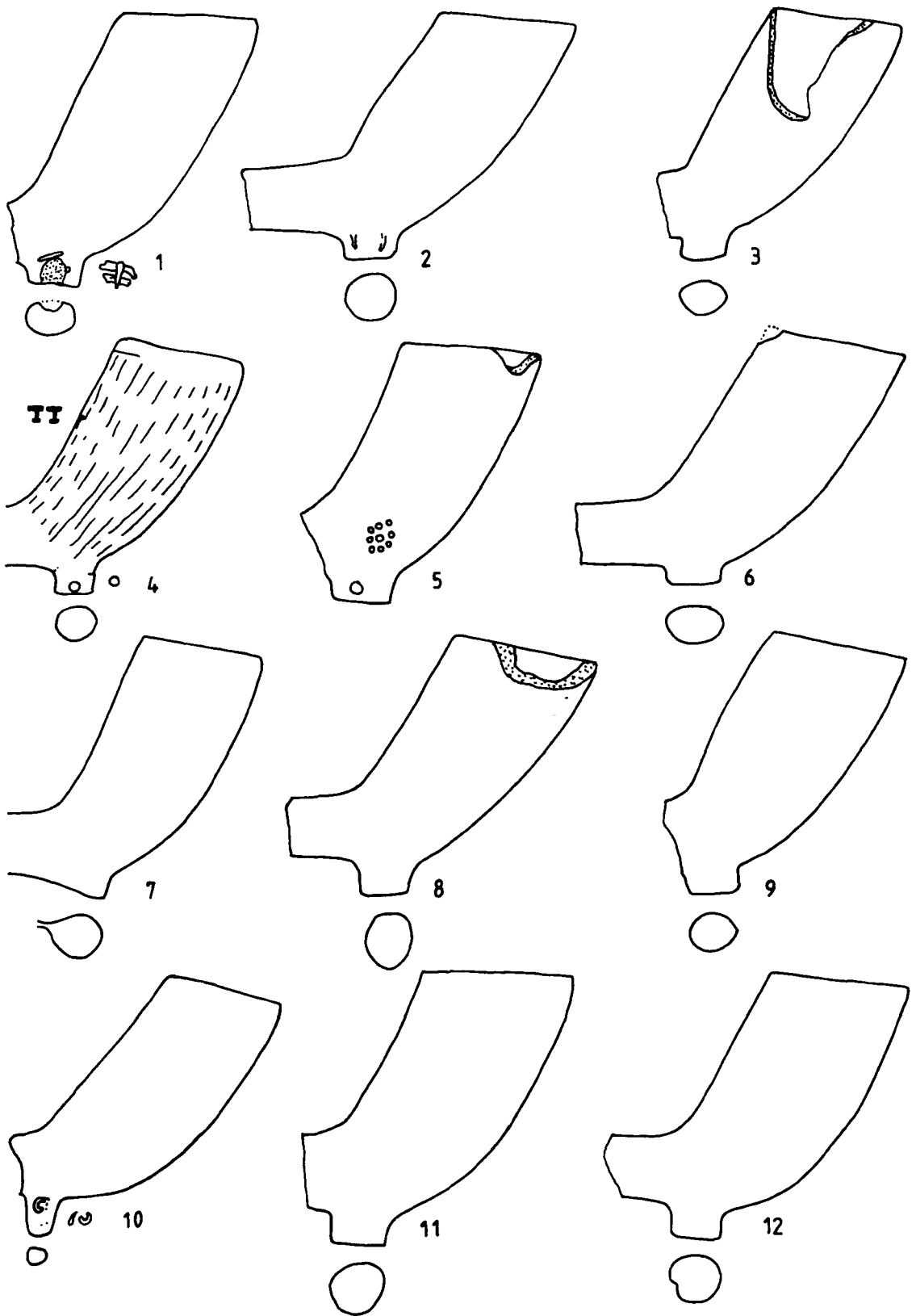
**Figure 34: Pipes from the Rayner Collection, Beverley. Scale 1:1.**



**Figure 35: Pipes from the Rayner Collection, Beverley. Scale 1:1.**

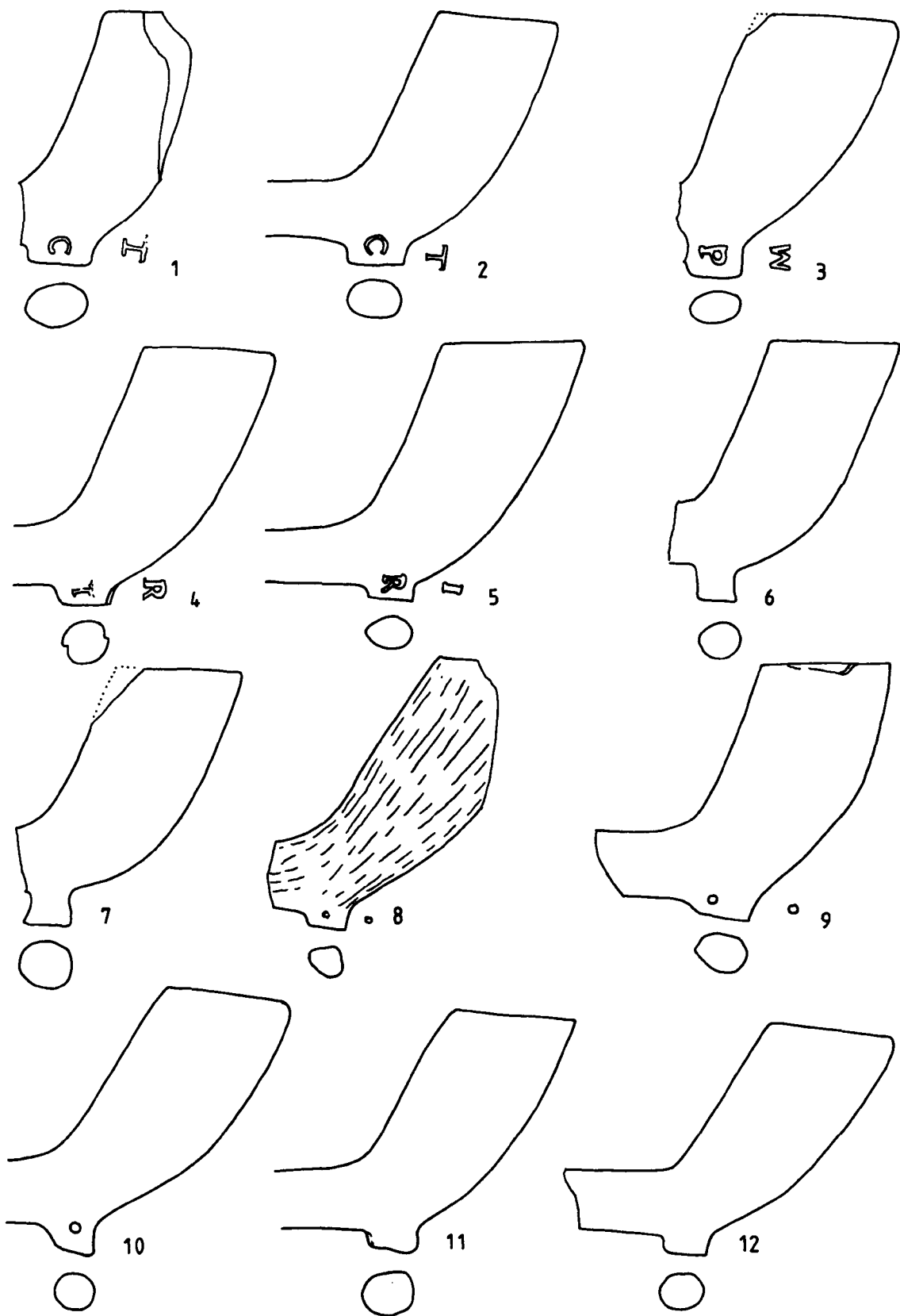


**Figure 36:** Pipes from the Rayner Collection, Beverley. Scale 1:1.

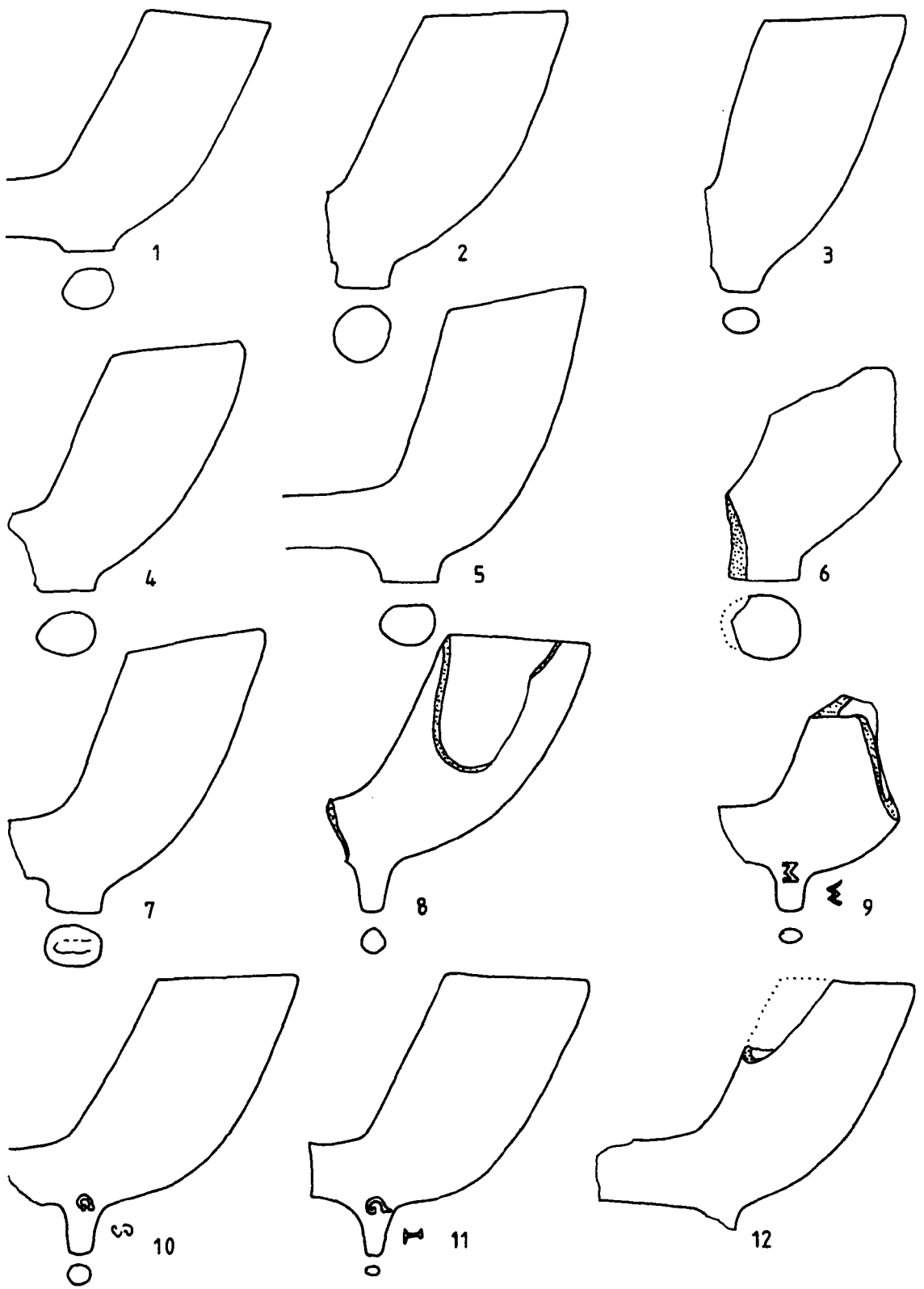


**Figure 37:** Pipes from the Rayner Collection, Beverley. Scale 1:1.

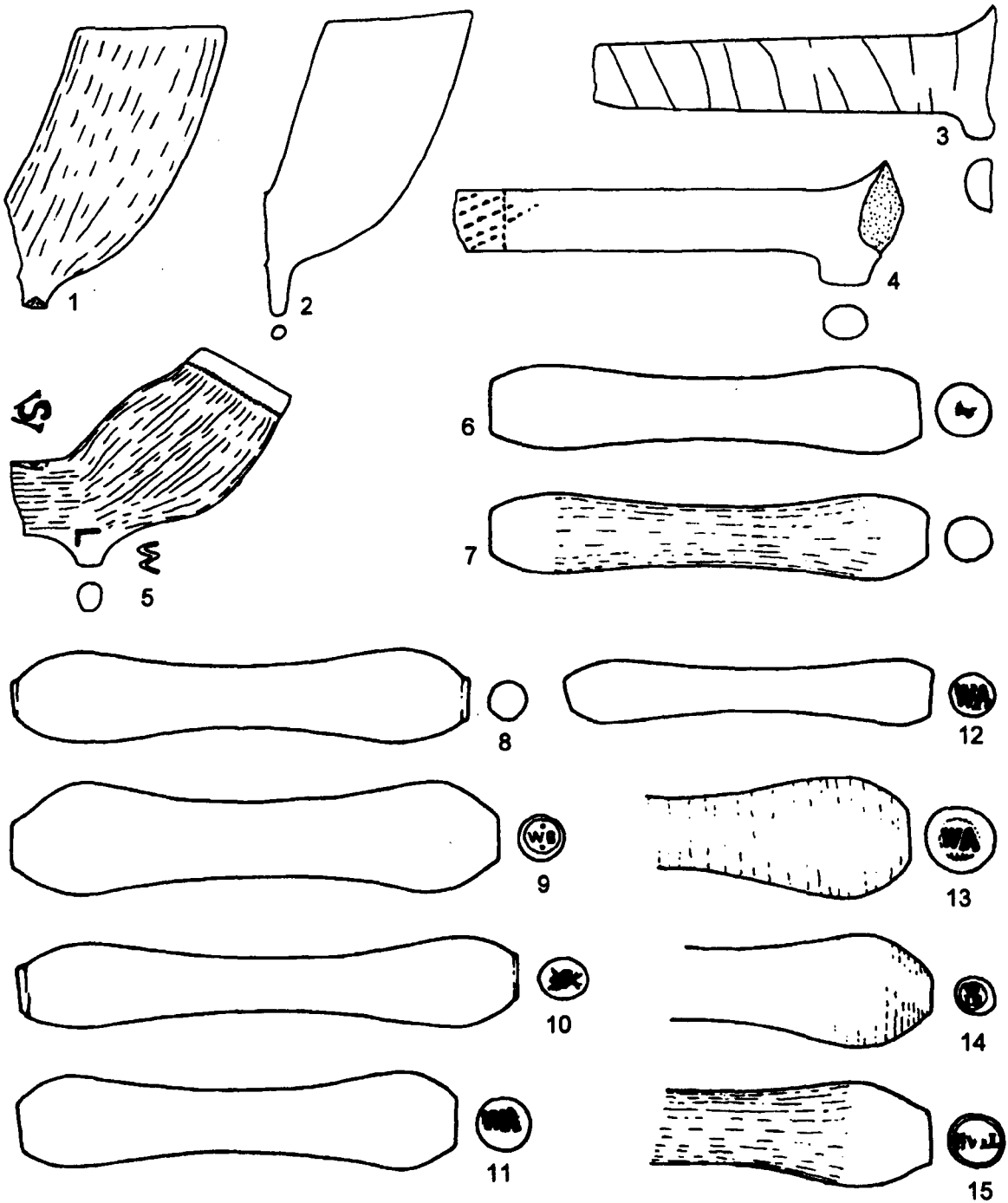




**Figure 38:** Pipes from the Rayner Collection, Beverley. Scale 1:1.



**Figure 39:** Pipes from the Rayner Collection, Beverley. Scale 1:1.



**Figure 40:** Pipes and hair curlers from the Rayner Collection, Beverley. Scale 1:1.

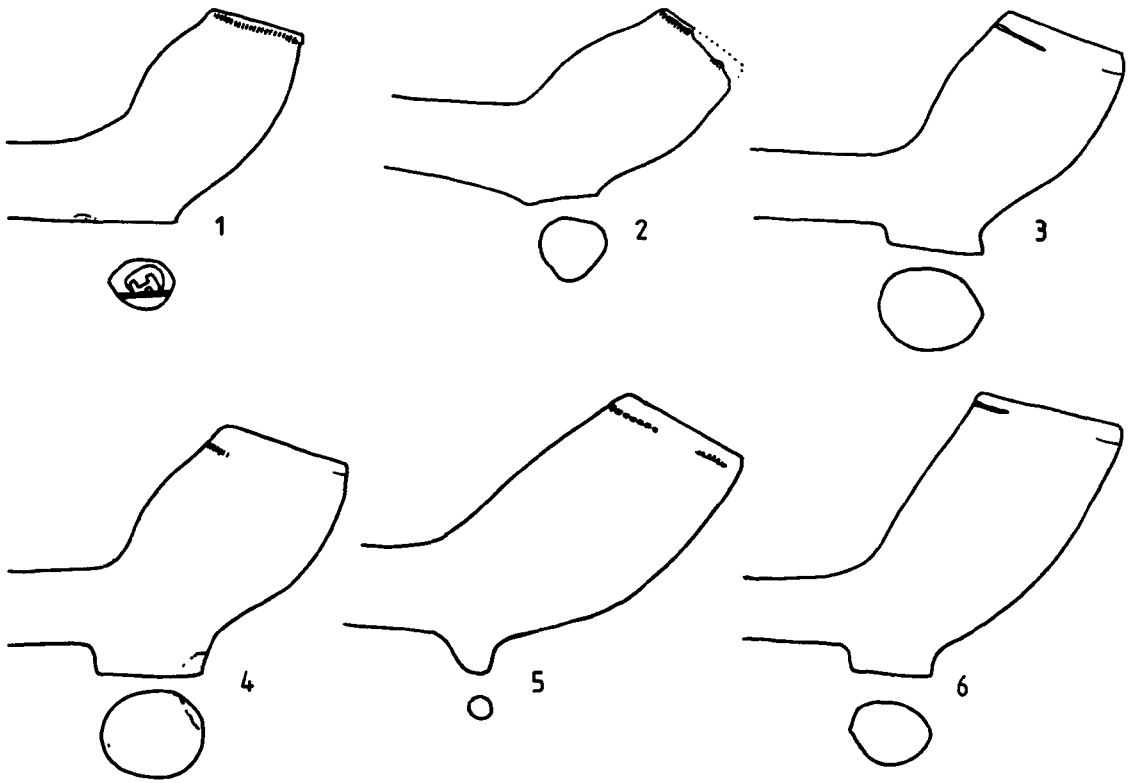
**Collection Name:** NCTPA  
**Collection Code:** 0135  
**Contact Name:** Miss S D White  
**Address:** Liverpool, Merseyside

**Description:**

Collection recorded for the National Stamp Catalogue. The NCTPA was formed in 1993 as a repository for objects and information relating to the pipe industry. Its substantial collection of clay tobacco pipes, publications and smoking related ephemera from all over the World is housed within the Department of Archaeology at the University of Liverpool.

A total of 83 pipes were selected from the NSC database for inclusion in the Yorkshire database. The majority of these were recovered from sites in North-west Yorkshire, all dating from the seventeenth or early eighteenth century.

- 41.01 Heel type bowl dating from c1640-1660 unprovenanced but probably from Darlington (Acc No. A170); rim bottered and m4 milled; stem bore 8/64". Marked with the initials H on the heel. (Pcode 02014).
- 41.02 Heel type bowl dating from c1640-1660 unprovenanced but probably from Darlington; rim bottered and m/ milled; stem bore 6/64". (Pcode 06075).
- 41.03 Heel type bowl dating from c1650-1670 unprovenanced but probably from Darlington (Acc No. A167); rim bottered and not milled; stem bore 7/64". Similar to a York Type 7. (Pcode 06071).
- 41.04 Heel type bowl dating from c1660-1680 unprovenanced but probably from Darlington (Acc No. A171); rim bottered and m1 milled; stem bore 7/64". (Pcode 06073).
- 41.05 Heel type bowl dating from c1650-1680 unprovenanced but probably from Darlington (Acc No. A168); rim bottered and fully milled; stem bore 7/64". (Pcode 06072).
- 41.06 Heel type bowl dating from c1690-1710 unprovenanced but probably from Darlington (Acc No. A288); rim



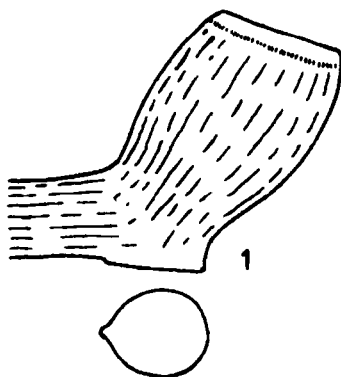
**Figure 41:** Yorkshire pipes in the collections of the NCTPA. Scale 1:1.

**Collection Name:** Higgins Collection  
**Collection Code:** 0003  
**Contact Name:** Dr David Higgins  
**Address:** Wallasey, Merseyside

**Description:**

A private collection comprising a large number of clay tobacco pipes and smoking related ephemera from all over the world. These objects range in date from early seventeenth century through to the present day. Only one bowl dating from c1660-1680 was selected for inclusion in the Yorkshire database.

42.01 Heel type bowl dating from c1660-1680, from Wakefield. Good burnish; rim bottered and fully milled; stem bore  $7/64$ ". (Pcode 08508).



*Figure 42: Pipe from Wakefield in the Higgins Collection. Scale 1:1.*

**Collection Name:** Stocks Collection  
**Collection Code:** 0221  
**Contact Name:** Mr Ernie Stocks  
**Address:** Wallasey, Merseyside

**Description:**

Private collection. Only two possible Yorkshire products were selected for inclusion in the Yorkshire database. None illustrated.

**Collection Name:** White Collection  
**Collection Code:** 0160  
**Contact Name:** Susie White  
**Address:** Wallasey, Merseyside

**Description:**

Private collection of clay tobacco pipes from Yorkshire and the Midlands ranging in date from the seventeenth century through to the early twentieth century. A total of 102 seventeenth- and eighteenth-century pipes were selected for inclusion in the Yorkshire database.

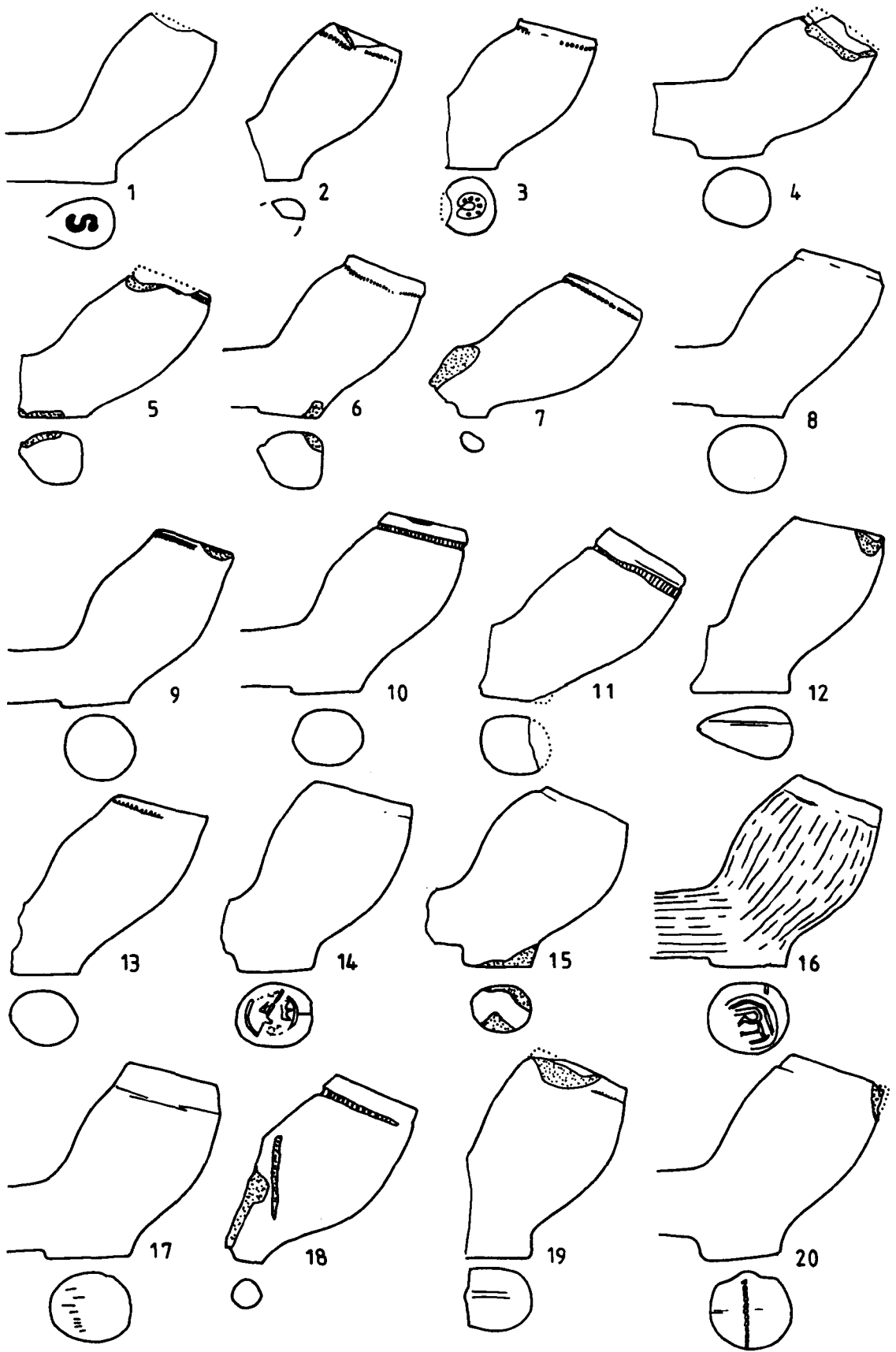
- 43.01 Heel type bowl dating from c1600-1610, from Thorne (Acc No. 160300/15); rim bottered but not milled; stem bore 7/64". Marked with the letter S on the heel. (Pcode 08417).
- 43.02 Heel type bowl dating from c1610-1640, from Thorne, (Acc No. 160300/34); rim bottered and fully milled. (Pcode 08433).
- 43.03 Heel type bowl dating from c1620-1640, from Thorne, (Acc No. 160300/11); rim bottered and fully milled; stem bore 8/64". Marked with a horseshoe on the heel. (Pcode 08414).
- 43.04 Heel type bowl dating from c1620-1640, from Thorne, (Acc No. 160300/26); rim bottered; milled around all of the surviving rim; stem bore 6/64". (Pcode 08425).
- 43.05 Heel type bowl dating from c1620-1640, from Thorne, (Acc No. 160300/37); rim bottered; milled around all of the surviving rim; stem bore 7/64". (Pcode 08435).
- 43.06 Heel type bowl dating from c1630-1650, from Thorne, (Acc No. 160300/39); rim internally trimmed and bottered and fully milled; stem bore 7/64". (Pcode 08437).
- 43.07 Spur type bowl dating from c1630-1650, from Thorne, (Acc No. 160300/36); rim bottered and fully milled; stem bore 7/64". (Pcode 08436).
- 43.08 Heel type bowl dating from c1640-1660, from Thorne, (Acc No. 160300/40); rim bottered but not milled; stem bore 7/64". (Pcode 08438).
- 43.09 Heel type bowl dating from c1640-1660, from Thorne, (Acc No. 160300/62); rim bottered and one quarter milled; stem bore 7/64". (Pcode 08461).
- 43.10 Heel type bowl dating from c1650-1670, from Thorne, (Acc No. 160300/66); rim bottered and fully milled; stem bore 7/64". (Pcode 08465).
- 43.11 Heel type bowl dating from c1640-1660, from Thorne, (Acc No. 160300/75); rim bottered and fully milled; stem bore 6/64". (Pcode 08474).

- 43.12 Heel type bowl dating from c1640-1660, from Thorne, (Acc No. 160300/64); rim internally trimmed and bottered; milled around all of the surviving rim; stem bore 8/64". Heart shaped heel. (Pcode 08463).
- 43.13 Heel type bowl dating from c1650-1670, from Thorne, (Acc No. 160300/50); rim bottered and half milled; stem bore 7/64". (Pcode 08449).
- 43.14 Heel type bowl dating from c1650-1670, from Thorne, (Acc No. 160300/14); rim bottered but not milled; stem bore 6/64". Mark damaged but appears to be crowned initials. (Pcode 08407).
- 43.15 Heel type bowl dating from c1650-1670, from Thorne, (Acc No. 160300/47); rim internally trimmed and bottered but not milled; stem bore 7/64". (Pcode 08446).
- 43.16 Heel type bowl dating from c1660-1680, from Thorne, (Acc No. 160300/13); good burnish; rim bottered but not milled; stem bore 7/64". Marked with the initials RT on the heel. Very crude mark; heel has been milled and then mark applied. (Pcode 08416).
- 43.17 Heel type bowl dating from c1660-1680, from Thorne, (Acc No. 160300/69); rim bottered but not milled; stem bore 7/64". Very deep botter. (Pcode 08468).
- 43.18 Spur type bowl dating from c1660-1680, from Thorne, (Acc No. 160300/91); rim bottered and fully milled; stem bore 7/64". (Pcode 08490).
- 43.19 Heel type bowl dating from c1660-1680, from Thorne, (Acc No. 160300/86); rim bottered but not milled; stem bore 8/64". (Pcode 08485).
- 43.20 Heel type bowl dating from c1650-1670, from Thorne, (Acc No. 160300/30); rim bottered but not milled; stem bore 6/64". Milled heel. (Pcode 08429).
- 44.01 Heel type bowl dating from c1660-1675, from Thorne, (Acc No. 160300/56); rim bottered and three quarters milled; stem bore 6/64". (Pcode 08455).
- 44.02 Spur type bowl dating from c1660-1680, from Thorne, (Acc No. 160300/59); rim internally trimmed and bottered but not milled; stem bore 7/64". (Pcode 08458).
- 44.03 Spur type bowl dating from c1660-1680, from Thorne, (Acc No. 160300/85); rim bottered; milled around all of the surviving rim; stem bore 7/64". (Pcode 08484).
- 44.04 Heel type bowl dating from c1660-1680, from Thorne, (Acc No. 160300/31); rim internally trimmed and bottered but not milled; stem bore 7/64". Milled heel. (Pcode 08430).

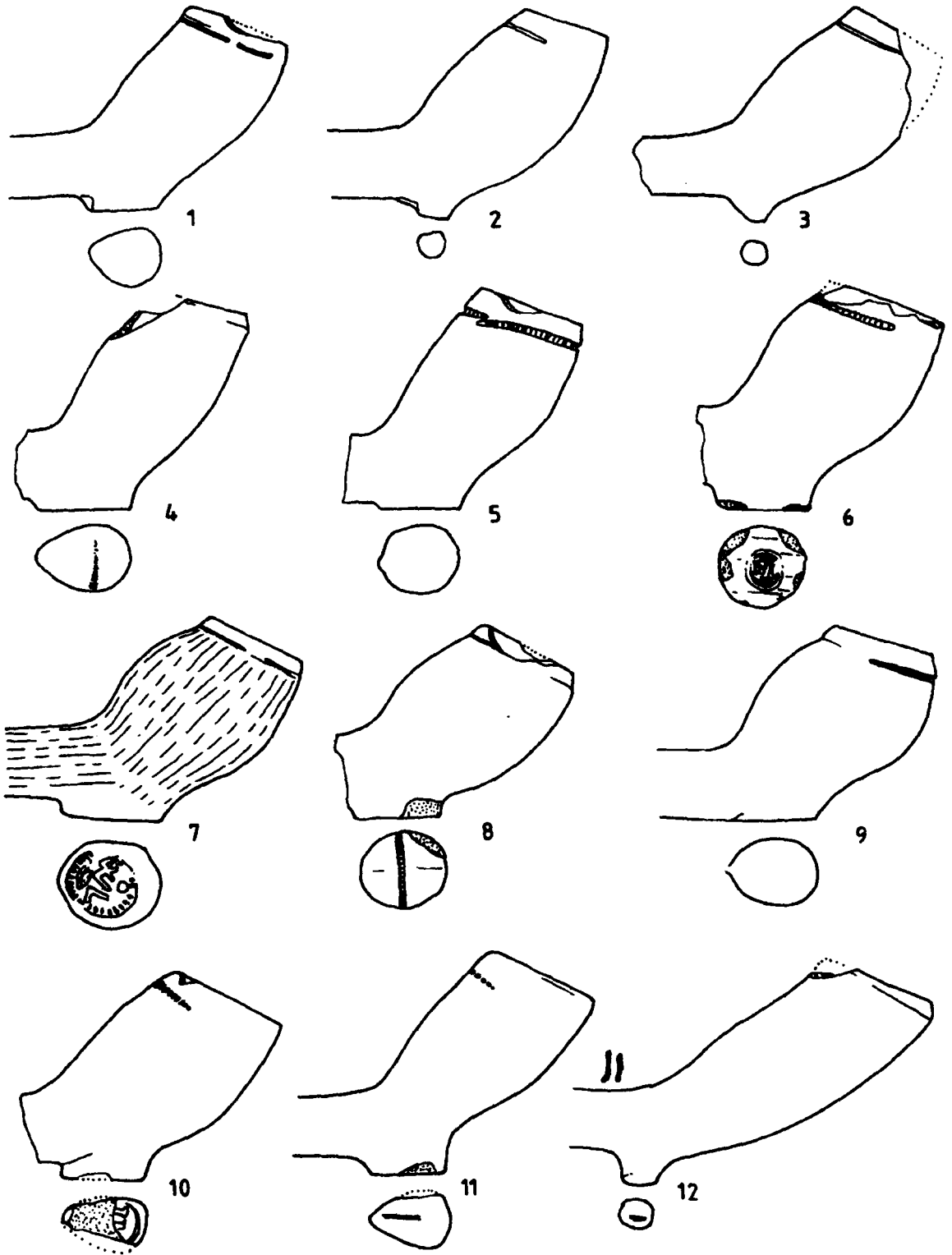


- 44.05 Heel type bowl dating from c1660-1675 , from Thorne, (Acc No. 160300/52); rim bottered and three quarters milled; stem bore 6/64". Similar to Hull Type 1. (Pcode 08451).
- 44.06 Heel type bowl dating from c1660-1680, from Thorne, (Acc No. 160300/23); rim bottered and half milled; stem bore 7/64". Marked with the initials WL on the heel. Similar to Hull Type 2; mark applied at 90 degrees. (Pcode 08405).
- 44.07 Heel type bowl dating from c1660-1680, from Thorne, (Acc No. 160300/6); good burnish; rim bottered and three quarters milled; stem bore 6/64". Marked with the initials WL on the heel. Similar to Hull Type 2; possibly same mould as Pcode 8411 and 8412. (Pcode 08410).
- 44.08 Heel type bowl dating from c1660-1680, from Thorne, (Acc No. 160300/48); rim bottered and half milled; stem bore 6/64". Milled heel . (Pcode 08447).
- 44.09 Heel type bowl dating from c1660-1690, from Thorne, (Acc No. 160300/44); rim bottered and fully milled; stem bore 6/64". Very bulbous bowl form; possibly same mould as Pcode 08444. (Pcode 08443).
- 44.10 Heel type bowl dating from c1660-1680, from Thorne, (Acc No. 160300/16); rim bottered and half milled; stem bore 6/64". Marked with the initials ?H on the heel. (Pcode 08418).
- 44.11 Heel type bowl dating from c1680-1710, from Thorne, (Acc No. 160300/78); rim bottered and one quarter milled; stem bore 6/64". Heart shaped heel. (Pcode 08477).
- 44.12 Heel type bowl dating from c1680-1710, from Thorne, (Acc No. 160300/19); rim internally trimmed and bottered but not milled; stem bore 6/64". Marked with the initials IL across the stem. (Pcode 08420).
- 45.01 Bowl dating from c1690-1710, from Thorne, (Acc No. 160300/99); rim bottered and one quarter milled; stem bore 6/64". (Pcode 08498).
- 45.02 Spur type bowl dating from c1690-1720, from Thorne, (Acc No. 160300/94); rim internally trimmed and bottered and half milled; stem bore 6/64". (Pcode 08493).
- 45.03 Heel type bowl dating from c1730-1760, from Thorne, (Acc No. 160300/97); rim internally trimmed and cut; rim not milled; stem bore 5/64". Marked with the initials I?R/B on the sides of the heel. (Pcode 08496).
- 45.04 Spur type bowl dating from c1740-1800, from Thorne, (Acc No. 160300/96); rim cut but not milled; stem bore 4/64". (Pcode 08495).

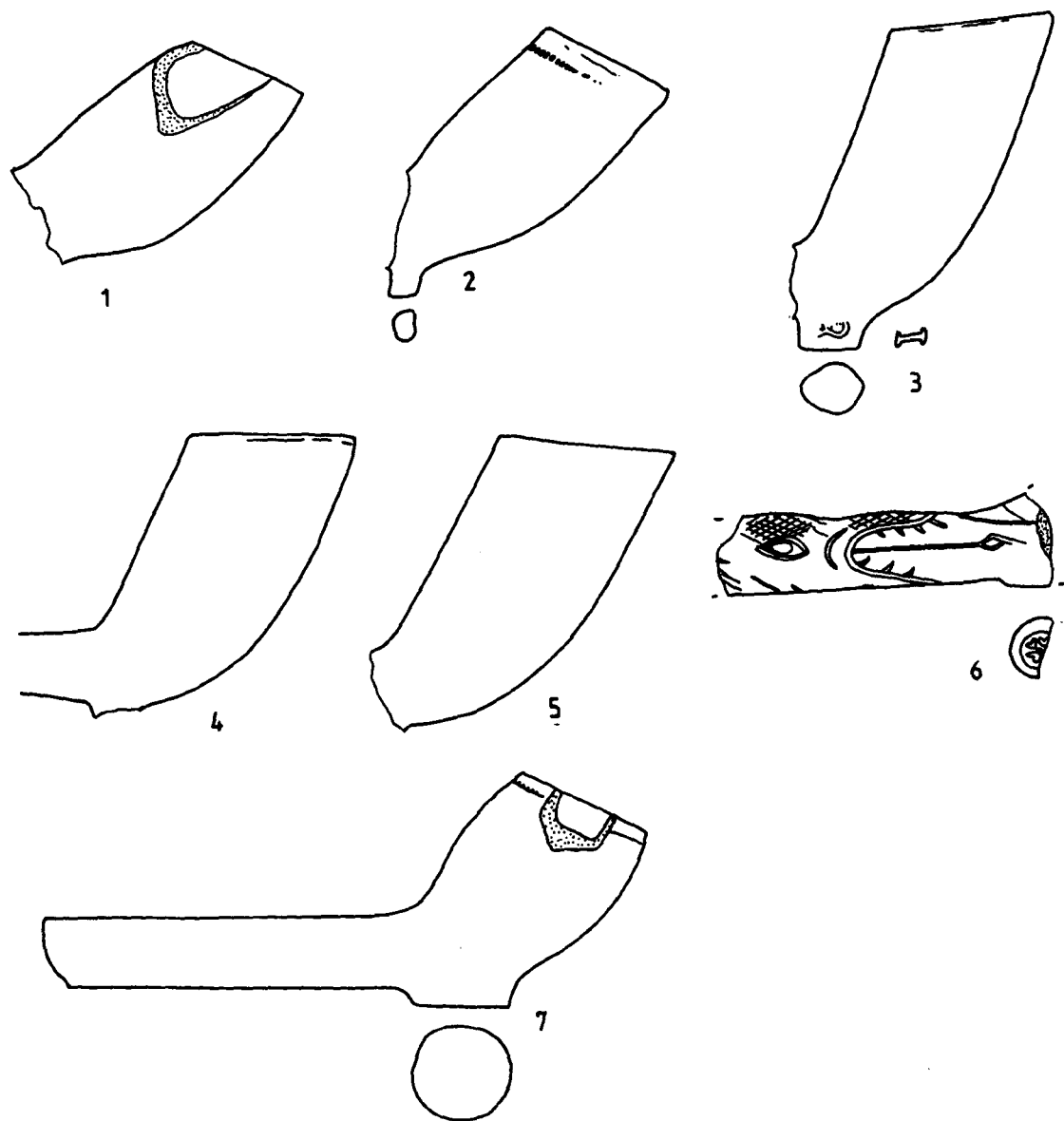
- 45.05 Spur type bowl dating from c1740-1800, from Thorne, (Acc No. 160300/95); bowl cross (+); rim cut but not milled; stem bore 5/64". (Pcode 08494).
- 45.06 Stem fragment dating from c1640-1680, from Thorne, (Acc No. 160300/105); stem bore 6/64". Part of a Dutch Jonah pipe. (Pcode 25449).
- 45.07 Heel bowl fragment dating from 1660-1680, from Scarborough (Acc No. 080699); rim bottered and half milled; stem bore 7/64". (Pcode 25360).



**Figure 43:** Yorkshire pipes from the White Collection. Scale 1:1.



**Figure 44:** Yorkshire pipes from the White Collection. Scale 1:1.



**Figure 45:** Yorkshire pipes from the White Collection. Scale 1:1.

**Collection Name:** Scunthorpe Museum & Art Gallery

**Collection Code:** 0134

**Contact Name:** Kevin Leahey

**Address:** Scunthorpe, North Lincolnshire

**Description:**

Collection recorded 10<sup>th</sup> May 1999 looking for Yorkshire products just outside the county in North Lincolnshire. This was a very substantial collection nearly all derived from field walking although there were some excavated groups including Kettleby Thorpe. At the time of the recording visit the catalogue of the collection was in the process of being computerised. The only way of finding any pipes, therefore, was to go through each box in turn. Only 40% of the boxes in the museum store were searched.

A total of 99 bowls and marked stems dating from the seventeenth and eighteenth century were recorded in detail. Due to the lack of time available no detailed record was made of any later material in the collection, however the following items were noted:

- Mill Field, Barton on Humber – Mould decorated bowl with vine leaves and grapes and the lettering HIRST HULL in relief on both sides of the bowl.
- Thornholme Priory (TP76.46) – stem with the incuse moulded lettering BURNISTON::BRIGG on the left hand side of the stem.

46.01 Heel type bowl dating from c1640-1660 from College Yard excavations (Acc No. BD1BF CV82); rim bottered and fully milled; stem bore 7/64". (Pcode 25425).

46.02 Heel type bowl dating from c1660-1680 from Habrough Manor (Acc No. HAAA); rim bottered and milled around all of the surviving rim; stem bore 7/64". (Pcode 25409).

46.03 Heel type bowl dating from c1660-1680 from Habrough Manor (Acc No. HAAA); rim bottered but not milled; stem bore 7/64". (Pcode 25410).

46.04 Heel type bowl dating from c1680-1710 from Habrough Manor (Acc No. HAAB); stem bore 7/64". Marked with the initials IK on the sides of the heel. No rim surviving. (Pcode 25408).

46.05 Heel type bowl dating from c1640-1670 from Horse Paddocks; rim bottered and milled around all of the surviving rim; stem bore 6/64". Heart shaped heel. (Pcode 25444).

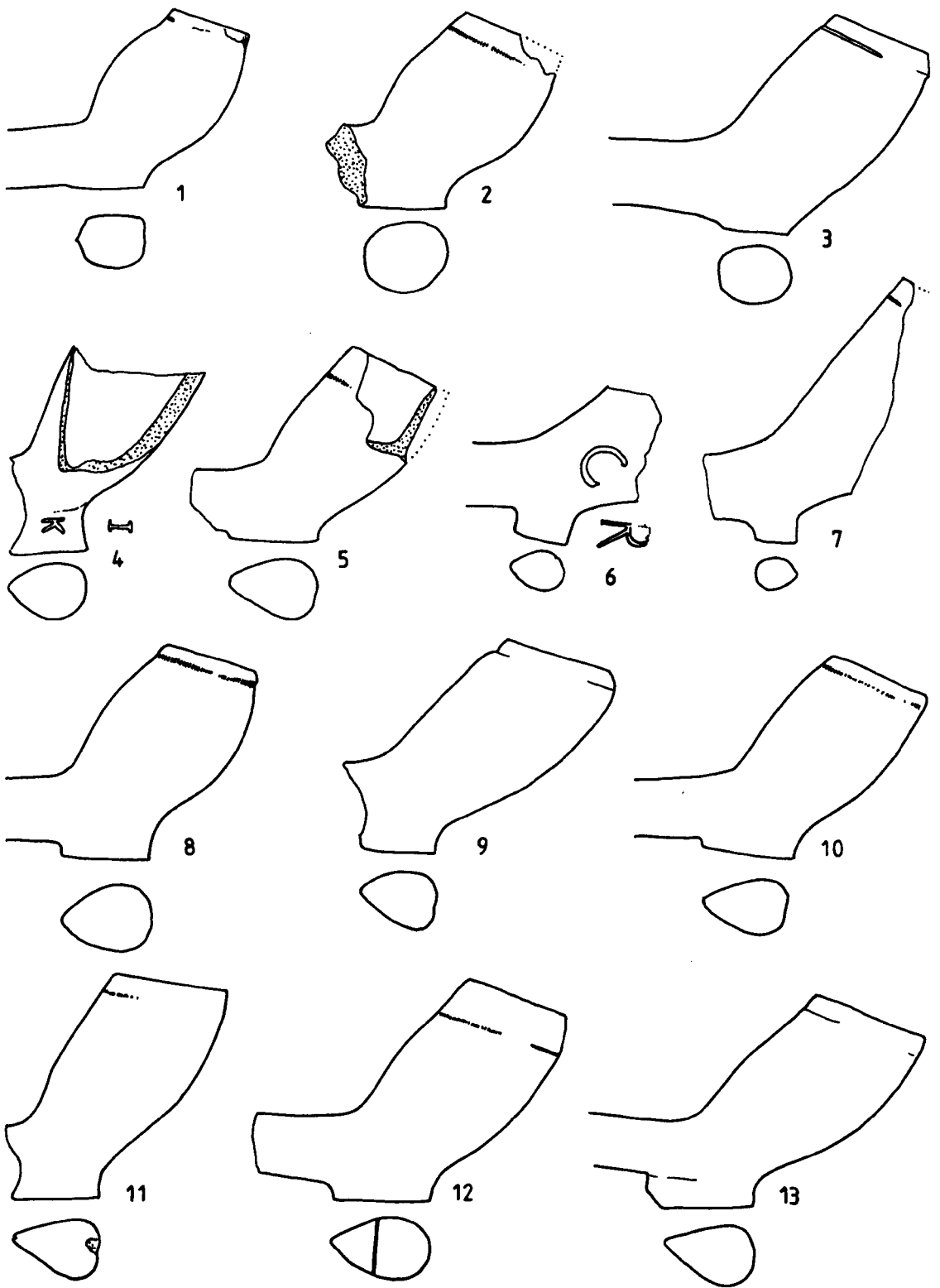
46.06 Heel type bowl dating from c1680-1710 from Morley's Yard (Acc No. BRI BE); stem bore 7/64". Marked with the initials RC on the sides of the bowl. Heel only. (Pcode 25431).

46.07 Heel type bowl dating from c1680-1710 from Poor Farm (Acc No. BNAA); rim bottered but not milled; stem bore 5/64". (Pcode 25434).

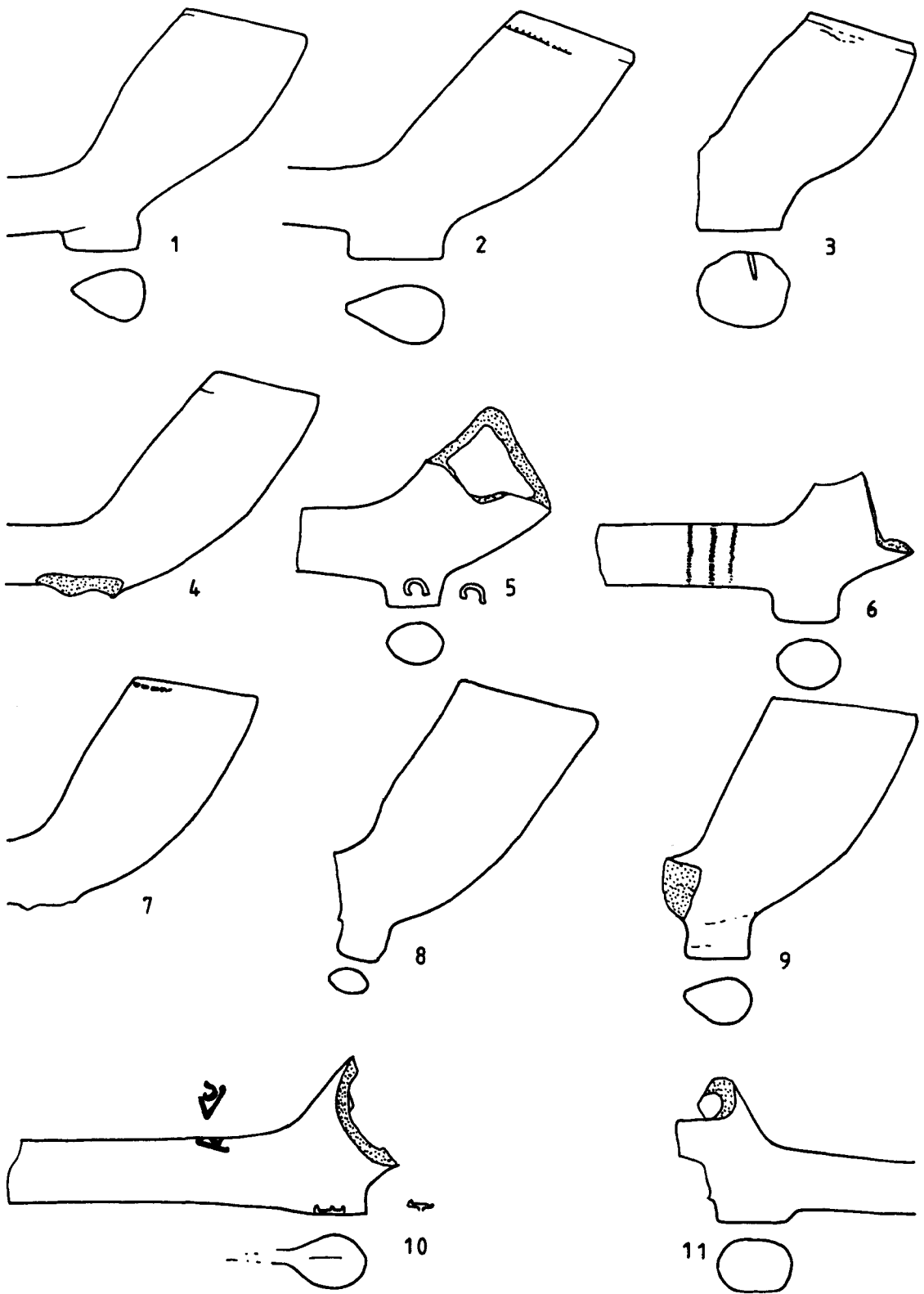
- 46.08 Heel type bowl dating from c1660-1680 from Smithfield Farm; rim bottered and fully milled; stem bore 7/64". (Pcode 25447).
- 46.09 Heel type bowl dating from c1680-1710 unprovenanced material from Brigg; rim bottered but not milled; stem bore 6/64". (Pcode 25424).
- 46.10 Heel type bowl dating from c1660-1680 from Winghale Priory (Acc No. KSWJ1); rim bottered and three quarters milled; stem bore 7/64". (Pcode 25361).
- 46.11 Heel type bowl dating from c1660-1680 from Winghale Priory (Acc No. KSWJ1); rim bottered and half milled; stem bore 7/64". (Pcode 25362).
- 46.12 Heel type bowl dating from c1660-1690 from Winghale Priory (Acc No. KSWJ1); rim bottered and fully milled; stem bore 7/64". Cut heel. (Pcode 25363).
- 46.13 Heel type bowl dating from c1680-1710 from Winghale Priory (Acc No. KSWJ1); rim bottered but not milled; stem bore 6/64". Heart shaped heel. (Pcode 25364).
- 47.01 Heel type bowl dating from c1680-1710 from Winghale Priory (Acc No. KSWJ1); rim bottered but not milled; stem bore 5/64". Heart shaped heel. (Pcode 25365).
- 47.02 Heel type bowl dating from c1680-1710 from Winghale Priory (Acc No. KSWJ1); rim bottered and half milled; stem bore 5/64". (Pcode 25366).
- 47.03 Heel type bowl dating from c1660-1680 from Hawesby cum Beesby (Acc No. HWAC 3); rim bottered but not milled. Cut heel. (Pcode 25414).
- 47.04 Heel type bowl dating from c1680-1710 from Goxhill (Acc No. GXAB); rim internally trimmed and bottered but not milled; stem bore 6/64". (Pcode 25405).
- 47.05 Heel type bowl dating from c1680-1710 from Hawesby cum Beesby (Acc No. HWAC 3); stem bore 5/64". Marked with the initials CC on the sides of the heel. No rim surviving; forward leaning transitional form. (Pcode 25417).
- 47.06 Heel type bowl dating from c1680-1710 from Hawesby cum Beesby (Acc No. HWAC 3); good burnish; stem bore 5/64". Milled stem. No rim surviving. (Pcode 25418).
- 47.07 Heel type bowl dating from c1680-1710 from Hawesby cum Beesby (Acc No. HWAC 3); rim internally trimmed, bottered and half milled; stem bore 6/64". (Pcode 25420).

- 47.08 Heel type bowl dating from c1720-1760 from Hawesby cum Beesby (Acc No. HWAC 3); rim internally trimmed and cut but not milled; stem bore 5/64". (Pcode 25415).
- 47.09 Heel type bowl dating from c1700-1770 from Hawesby cum Beesby (Acc No. HWAC 3); rim internally trimmed and bottered but not milled; stem bore 5/64". (Pcode 25416).
- 47.10 Heel type bowl dating from c1680-1700 from Winghale Priory (Acc No. KSWJ 5); stem bore 6/64". Marked with the initials SV across the stem, also has the initials HI moulded on sides of heel. (Pcode 02649).
- 47.11 Heel type bowl dating from c1640-1660 unprovenanced material in Scunthorpe Museum (Acc No. BRAB); stem bore 7/64". Heel only. (Pcode 25422).





**Figure 46:** Pipes from the collections of Scunthorpe Museum and Art Gallery.  
Scale 1:1



**Figure 47:** Pipes from the collections of Scunthorpe Museum and Art Gallery. Scale 1:1.

**Collection Name:** Raines Collection  
**Collection Code:** 0139  
**Contact Name:** Mr R A G Raines  
**Address:** Acaster Malbis, York, North Yorkshire  
**Description:**

A private collection borrowed for recording in Liverpool from March to November 2000. The collection comprises approximately 500 bowls recovered from the fields around the village of Acaster Malbis. Approximately 340 of these bowls date from the seventeenth or eighteenth century and have been recorded in detail for the Yorkshire Database. The collection included a number of mould decorated pipes including examples with Masonic motifs; flutes and swags; floral motifs including the rose and thistle; and a very fine bowl depicting the Prussian Arms with supporters.

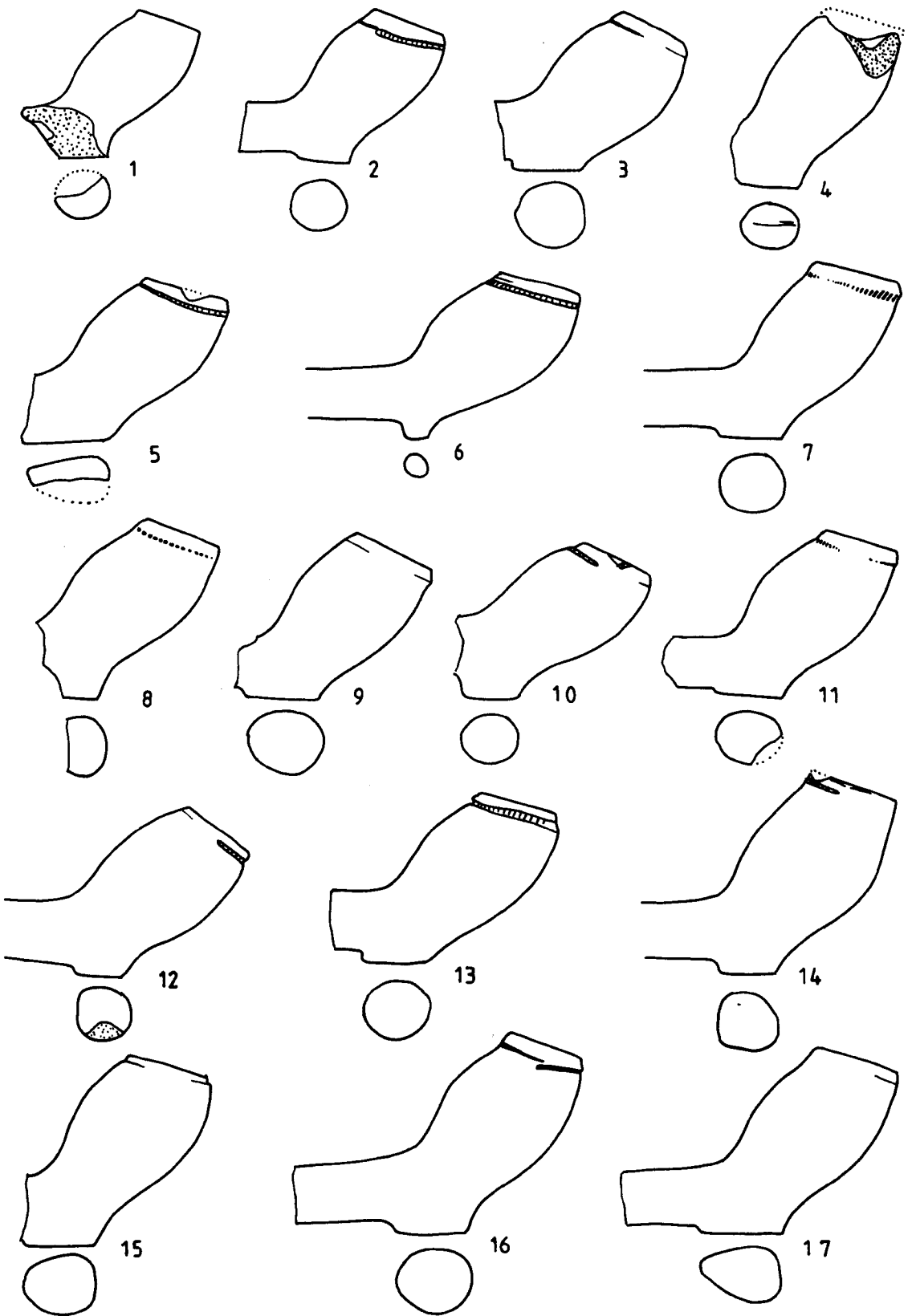
- 48.01 Heel type bowl dating from c1610-1620, (Acc No. 188); rim bottered but not milled; stem bore 7/64". (Pcode 06743).
- 48.02 Heel type bowl dating from c1610-1640, (Acc No. 13); rim bottered and fully milled; stem bore 7/64". (Pcode 06576).
- 48.03 Heel type bowl dating from c1630-1650, (Acc No. 44); rim bottered but not milled; stem bore 7/64". (Pcode 06607).
- 48.04 Heel type bowl dating from c1620-1640, (Acc No. 2); stem bore 6/64". (Pcode 06566).
- 48.05 Heel type bowl dating from c1640-1660, (Acc No. 20); rim bottered and fully milled; stem bore 6/64". (Pcode 06583).
- 48.06 Spur type bowl dating from c1640-1660, (Acc No. 35); rim bottered and fully milled; stem bore 7/64". (Pcode 06598).
- 48.07 Heel type bowl dating from c1640-1660, (Acc No. 17); rim internally trimmed and bottered and fully milled; stem bore 8/64". (Pcode 06580).
- 48.08 Heel type bowl dating from c1640-1660, (Acc No. 32); rim bottered and fully milled; stem bore 6/64". (Pcode 06595).
- 48.09 Heel type bowl dating from c1640-1660, (Acc No. 21); rim bottered but not milled; stem bore 6/64". (Pcode 06584).
- 48.10 Heel type bowl dating from c1640-1660, (Acc No. 8); rim bottered and half milled; stem bore 6/64". (Pcode 06571).
- 48.11 Heel type bowl dating from c1640-1660, (Acc No. 11); rim bottered and fully milled; stem bore 6/64". (Pcode 06574).
- 48.12 Heel type bowl dating from c1640-1660, (Acc No. 5); rim bottered and fully milled; stem bore 6/64". (Pcode 06569).

- 48.13 Heel type bowl dating from c1640-1660, (Acc No. 40); rim bottered and fully milled; stem bore 6/64". (Pcode 06603).
- 48.14 Heel type bowl dating from c1640-1660, (Acc No. 36); rim bottered and half milled; stem bore 7/64". (Pcode 06599).
- 48.15 Heel type bowl dating from c1640-1660, (Acc No. 22); rim bottered but not milled; stem bore 6/64". (Pcode 06585).
- 48.16 Heel type bowl dating from c1640-1660, (Acc No. 15); rim bottered and fully milled; stem bore 6/64". (Pcode 06578).
- 48.17 Heel type bowl dating from c1650-1670, (Acc No. 30); rim bottered but not milled; stem bore 5/64". Heart shaped heel. (Pcode 06593).
- 49.01 Heel type bowl dating from c1650-1670, (Acc No. 56); rim bottered but not milled; stem bore 8/64". (Pcode 06619).
- 49.02 Heel type bowl dating from c1650-1670, (Acc No. 66); rim bottered but not milled; stem bore 7/64". Very bulbous. (Pcode 06629).
- 49.03 Heel type bowl dating from c1660-1680, (Acc No. 94); rim bottered and three quarters milled; stem bore 7/64". (Pcode 06656).
- 49.04 Heel type bowl dating from c1660-1680, (Acc No. 390); rim bottered and fully milled; stem bore 7/64". Marked with the initials H?I/F flanking a Fleur-de-lys on the heel. (Pcode 06871).
- 49.05 Heel type bowl dating from c1660-1680, (Acc No. 90); rim internally trimmed and bottered but not milled; stem bore 7/64". (Pcode 06652).
- 49.06 Heel type bowl dating from c1660-1680, (Acc No. 154); rim bottered and one quarter milled; stem bore 7/64". (Pcode 06713).
- 49.07 Heel type bowl dating from c1660-1680, (Acc No. 74); rim bottered but not milled. (Pcode 06637).
- 49.08 Heel type bowl dating from c1660-1700, (Acc No. 107); rim bottered but not milled; stem bore 7/64". (Pcode 06667).
- 49.09 Heel type bowl dating from c1660-1680, (Acc No. 174); rim internally trimmed and bottered and three quarters milled; stem bore 6/64". (Pcode 06731).
- 49.10 Heel type bowl dating from c1660-1680, (Acc No. 400); rim bottered but not milled; stem bore 7/64". Marked with the crowned initials IT on the heel. ?Ripon mark. (Pcode 06880).
- 49.11 Heel type bowl dating from c1660-1680, (Acc No. 96); rim bottered and half milled; stem bore 6/64". Milled heel. Very bulbous. (Pcode 06658).

- 49.12 Heel type bowl dating from c1660-1680, (Acc No. 337); rim bottered and fully milled; stem bore 6/64". Marked with the initials AB on the heel. Very bulbous; Abraham Boyes of York. (Pcode 06816).
- 50.01 Heel type bowl dating from c1660-1680, (Acc No. 189); rim bottered and half milled; stem bore 6/64". Milled heel. Similar to York Type 11. (Pcode 06744).
- 50.02 Heel type bowl dating from c1660-1680, (Acc No. 106); rim bottered and half milled; stem bore 8/64". Milled heel. (Pcode 06666).
- 50.03 Spur type bowl dating from c1660-1680, (Acc No. 109); rim bottered but not milled; stem bore 7/64". (Pcode 06669).
- 50.04 Heel type bowl dating from c1660-1690, (Acc No. 402); rim bottered but not milled; stem bore 6/64". Marked with the initials AB on the heel. (Pcode 06882).
- 50.05 Heel type bowl dating from c1680-1700, (Acc No. 163); rim bottered but not milled; stem bore 7/64". Similar to 1437. (Pcode 06721).
- 50.06 Heel type bowl dating from c1660-1680, (Acc No. 68); rim bottered but not milled; stem bore 7/64". (Pcode 06631).
- 50.07 Heel type bowl dating from c1660-1700, (Acc No. 82); rim bottered but not milled; stem bore 6/64". (Pcode 06645).
- 50.08 Heel type bowl dating from c1660-1700, (Acc No. 86); rim bottered but not milled; stem bore 7/64". Milled stem. Similar to Hull Type 2f. (Pcode 06649).
- 50.09 Heel type bowl dating from c1670-1680, (Acc No. 123); rim bottered and half milled; stem bore 7/64". (Pcode 06683).
- 50.10 Heel type bowl dating from c1660-1700, (Acc No. 125); rim internally trimmed and bottered but not milled; stem bore 7/64". (Pcode 06685).
- 50.11 Heel type bowl dating from c1670-1700, (Acc No. 379); rim bottered but not milled; stem bore 6/64". Marked with the initials SH on the heel. Mark appears to have a crown above the initials, possibly Ripon maker. (Pcode 06859).
- 51.01 Heel type bowl dating from c1670-1700, (Acc No. 336); rim bottered and half milled; stem bore 7/64". Marked with the initials AB on the heel. (Pcode 06815).
- 51.02 Heel type bowl dating from c1670-1680, (Acc No. 162); rim internally trimmed and bottered and half milled; stem bore 6/64". (Pcode 06720).

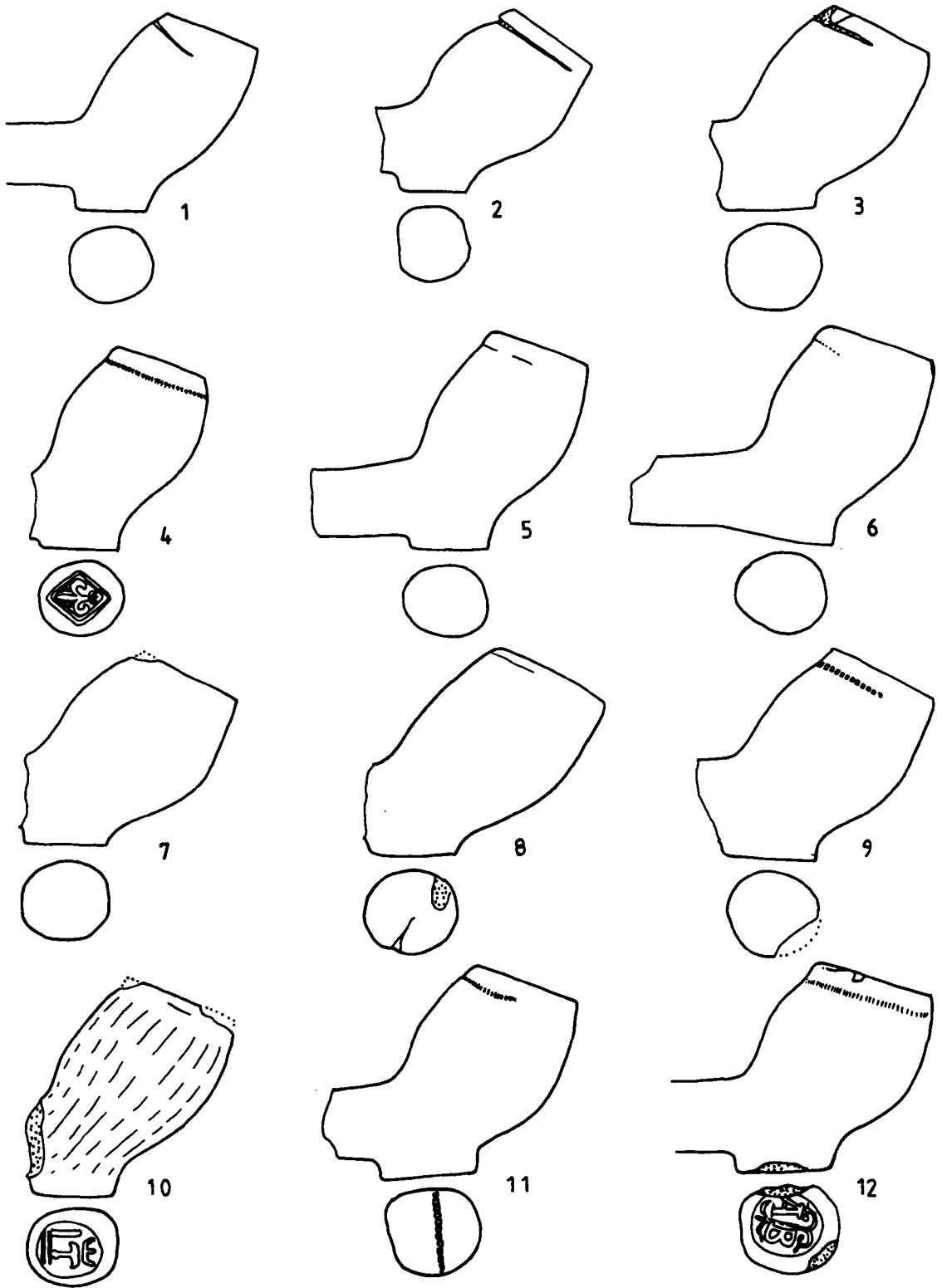
- 51.03 Heel type bowl dating from c1660-1700, (Acc No. 186); rim bottered but not milled; stem bore 6/64". (Pcode 06741).
- 51.04 Heel type bowl dating from c1670-1700, (Acc No. 73); rim internally trimmed and bottered and half milled; stem bore 6/64". (Pcode 06636).
- 51.05 Heel type bowl dating from c1670-1710, (Acc No. 373); rim bottered but not milled; stem bore 7/64". Marked with the initials IT/D/I on the heel. Surname initial poorly impressed, possibly a T, D or I. (Pcode 06852).
- 51.06 Heel type bowl dating from c1680-1710, (Acc No. 103); rim bottered and half milled; stem bore 7/64". (Pcode 06665).
- 51.07 Heel type bowl dating from c1660-1690, (Acc No. 343); rim bottered and half milled; stem bore 8/64". Marked with the initials AB on the heel. Similar to York Type 11; Abraham Boyes of York. (Pcode 06822).
- 51.08 Heel type bowl dating from c1680-1700, (Acc No. 212); rim bottered and half milled; stem bore 5/64". (Pcode 06765).
- 51.09 Heel type bowl dating from c1680-1700, (Acc No. 64); milled around all of the surviving rim; stem bore 7/64". (Pcode 06627).
- 51.10 Heel type bowl dating from c1680-1710, (Acc No. 375); rim bottered but not milled; stem bore 5/64". Marked with the initials AB on the heel. (Pcode 06854).
- 51.11 Heel type bowl dating from c1680-1710, (Acc No. 411); rim bottered and one quarter milled; stem bore 6/64". Marked with the initials A?B on the heel. Similar to York type 15; mark possibly reads AB. (Pcode 06891).
- 51.12 Heel type bowl dating from c1680-1710, (Acc No. 396); rim internally trimmed and bottered but not milled; stem bore 6/64". Marked with the initials AB on the heel. Similar to York Type 15; possibly a second Abraham Boyes of York. (Pcode 06876).
- 52.01 Heel type bowl dating from c1680-1710, (Acc No. 195); rim bottered; milled around all of the surviving rim; stem bore 5/64". (Pcode 06750).
- 52.02 Heel type bowl dating from c1680-1710, (Acc No. 380); rim bottered but not milled; stem bore 7/64". Marked with the initials RS on the heel. ?Richard Shaftoe of York. (Pcode 06860).
- 52.03 Heel type bowl dating from c1680-1710, (Acc No. 357); rim internally trimmed and bottered but not milled; stem bore 5/64". Marked with the initials AB on the heel. Possibly a second Abraham Boyes of York. (Pcode 06835).
- 52.04 Heel type bowl dating from c1690-1710, (Acc No. 359); rim bottered and one quarter milled; stem bore 5/64". Marked with the initials AB on the heel. Possibly a second Abraham Boyes of York. (Pcode 06838).

- 52.05 Heel type bowl dating from c1690-1720, (Acc No. 423); rim bottered but not milled; stem bore 5/64". Marked with the initials WS on the heel. Similar to York Type 15; ?William Spacey of York. (Pcode 06902).
- 52.06 Heel type bowl dating from c1680-1710, (Acc No. 260); rim bottered and half milled; stem bore 6/64". Marked with the initials RC on the sides of the heel. Hull Type 7b; Robert Chapman of Hull. (Pcode 06807).
- 52.07 Heel type bowl dating from c1680-1710, (Acc No. 226); rim bottered and half milled; stem bore 6/64". Marked with the initials R?E/F on the sides of the heel. Similar to Hull Type 4c; no known maker with these initials; similar examples from Beverley. (Pcode 06778).
- 52.08 Heel type bowl dating from c1690-1730, (Acc No. 205); rim internally trimmed and bottered and three quarters milled; stem bore 7/64". (Pcode 06759).
- 52.09 Heel type bowl dating from c1680-1710, (Acc No. 209); rim bottered but not milled; stem bore 5/64". Marked with the initials HB on the sides of the heel. Similar to York Type 15 but shorter; initials appear to read HB. (Pcode 06762).
- 52.10 Heel type bowl dating from c1700-1720, (Acc No. 214); stem bore 5/64". Chester bowl form, similar to a Type 82. (Pcode 06767).
- 52.11 Heel type bowl dating from c1690-1730, (Acc No. 384); rim internally trimmed and wiped; rim not milled; stem bore 5/64". Marked with the initials AB on the heel. Possibly a second Abraham Boyes of York. (Pcode 06864).
- 52.12 Heel type bowl dating from c1710-1740, (Acc No. 219); rim cut but not milled; stem bore 5/64". Marked with the initials CH on the sides of the heel. (Pcode 06771).
- 53.01 Heel type bowl dating from c1710-1740, (Acc No. 261); rim cut but not milled; stem bore 6/64". Marked with the initials on the . Similar to York Type 18. (Pcode 06808).
- 53.02 Heel type bowl dating from c1730-1760, (Acc No. 197); rim cut but not milled; stem bore 5/64". (Pcode 06752).
- 53.03 Spur type bowl dating from c1790-1820 (Acc No. 308). Armorial with initial S on smokers right and an anchor on smokers left.
- 53.04 Bowl dating from c1870-1910 (Acc No. 281). One of two bowls with this rose and thistle design; leaf decorated seams.
- 53.05 Spur type bowl dating from c1810-1860 (Acc No. 282). One of two bowls with this rose and thistle design.

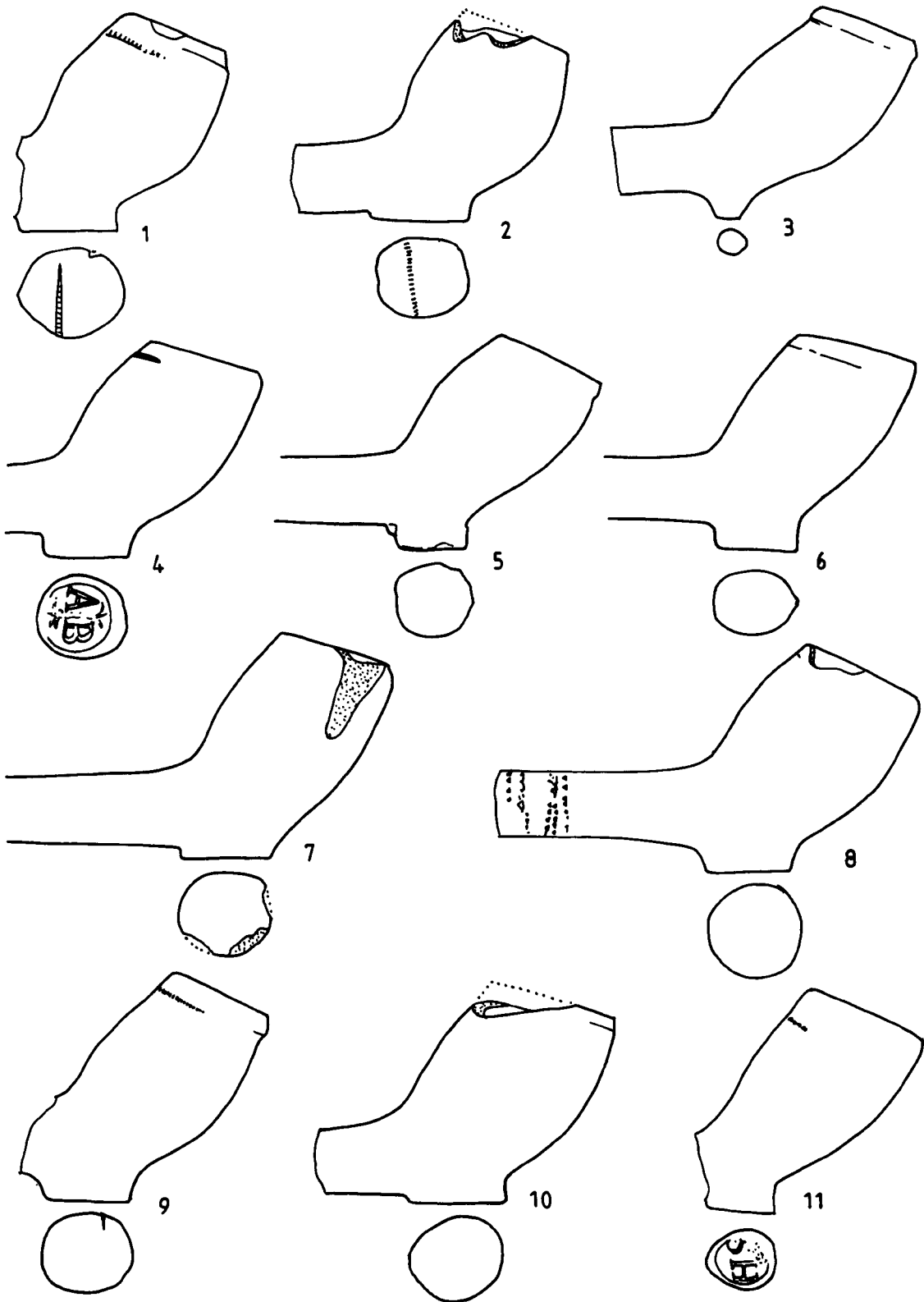


**Figure 48:** Pipes from the Raines Collection, *Acaster Malbis*. Scale 1:1

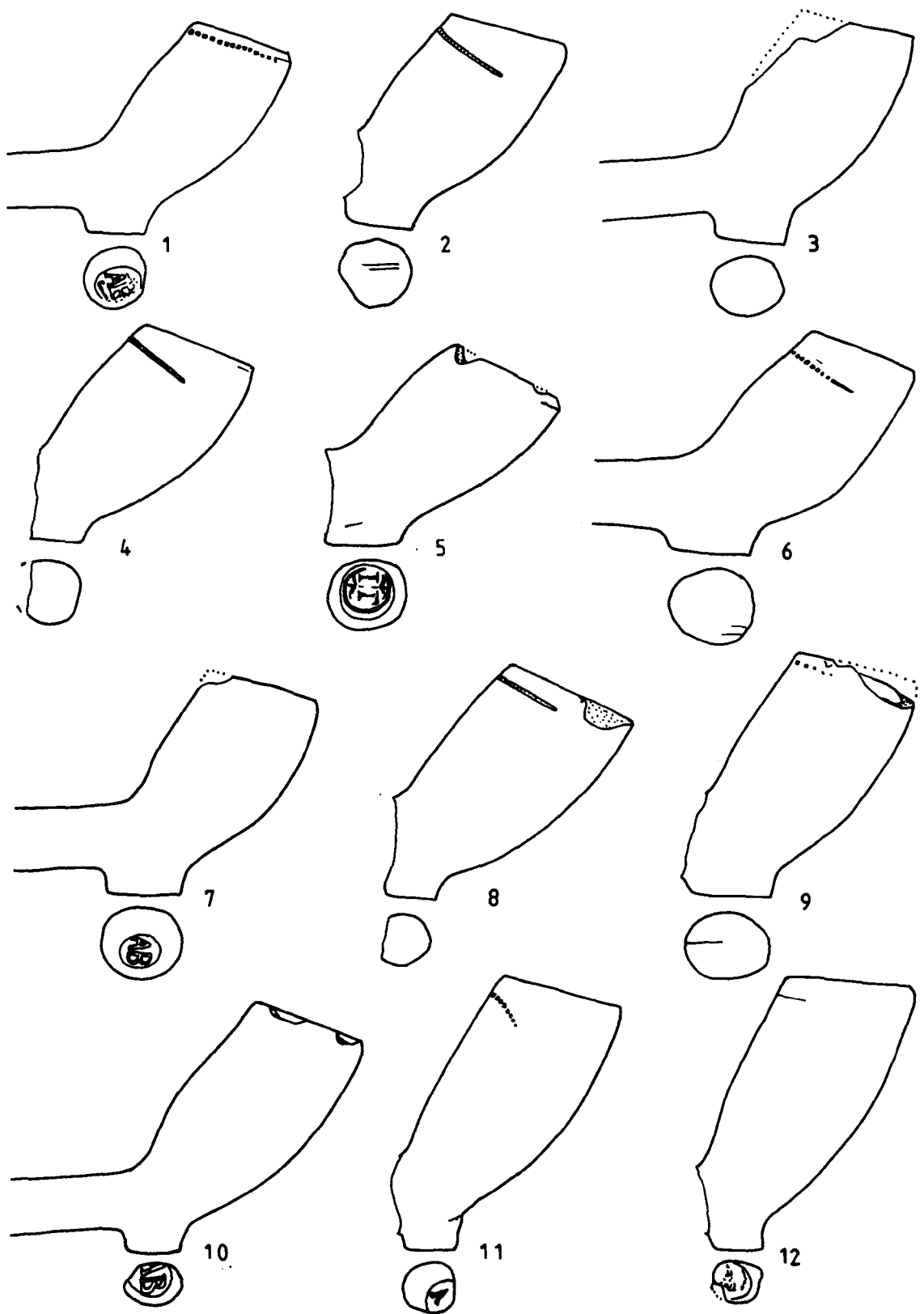




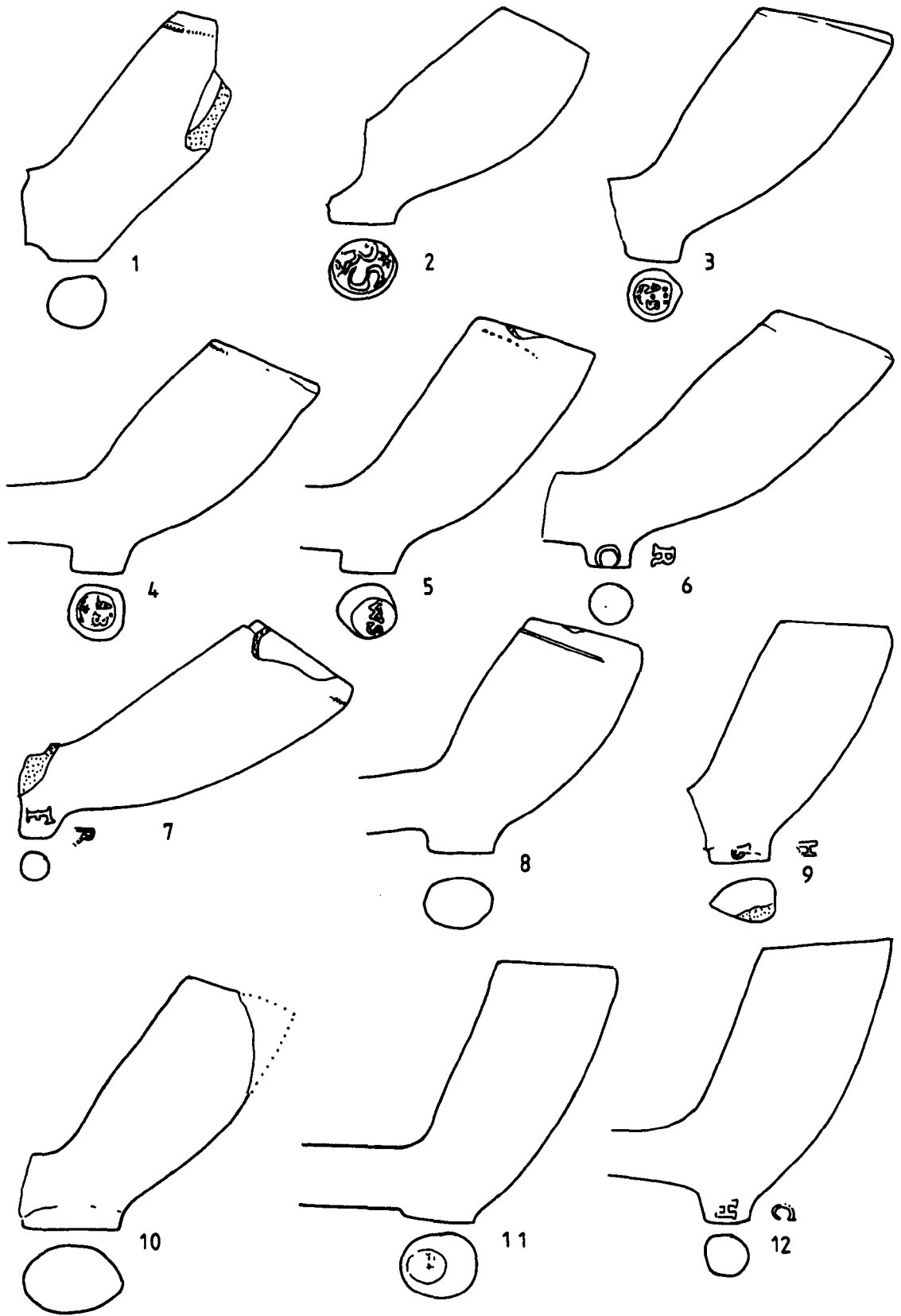
**Figure 49:** Pipes from the Raines Collection, Acaster Malbis. Scale 1:1



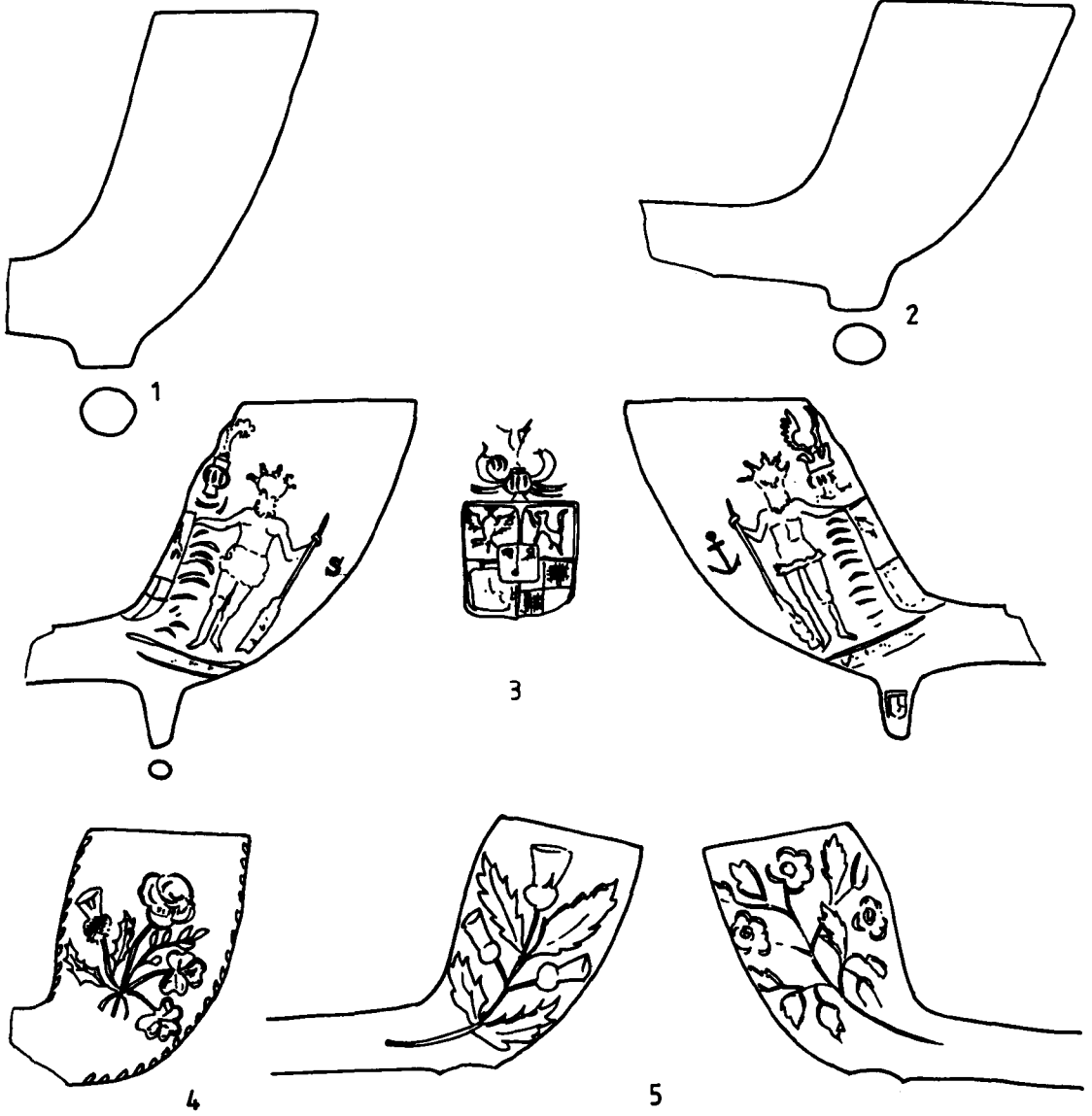
**Figure 50: Pipes from the Raines Collection, Acaster Malbis. Scale 1:1**



**Figure 51:** Pipes from the Raines Collection, Acaster Malbis. Scale 1:1



**Figure 52: Pipes from the Raines Collection, *Acaster Malbis*. Scale 1:1**



**Figure 53:** Pipes from the Raines Collection, Acaster Malbis. Scale 1:1

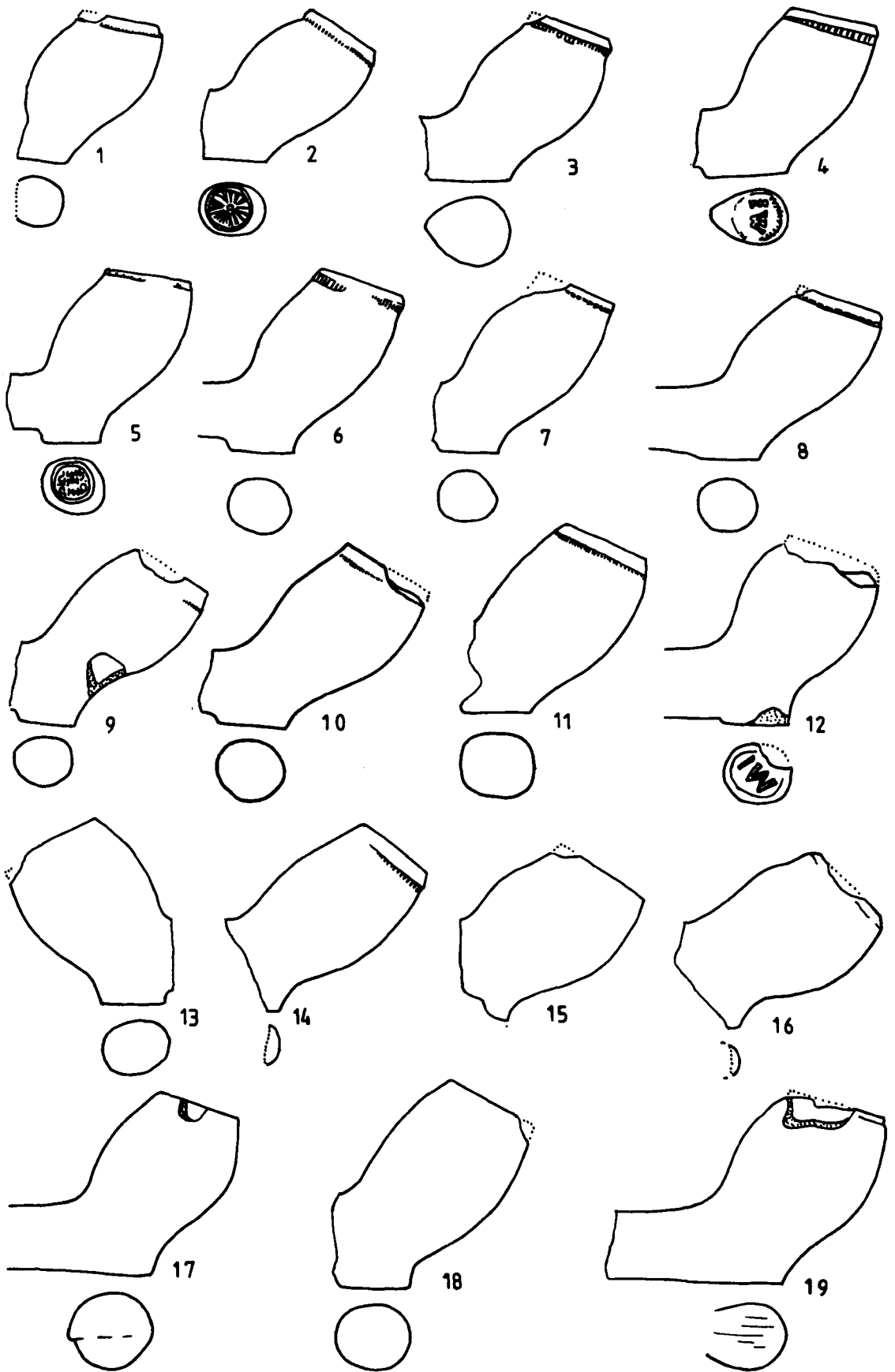
**Collection Name:** Tierney Collection  
**Collection Code:** 0234  
**Contact Name:** Mr Dan Tierney  
**Address:** Barnoldswick, North Yorkshire

**Description:**

Private collection recorded on 23<sup>rd</sup> March 2001. Collection comprises approximately 30 seventeenth- and eighteenth-century bowls.

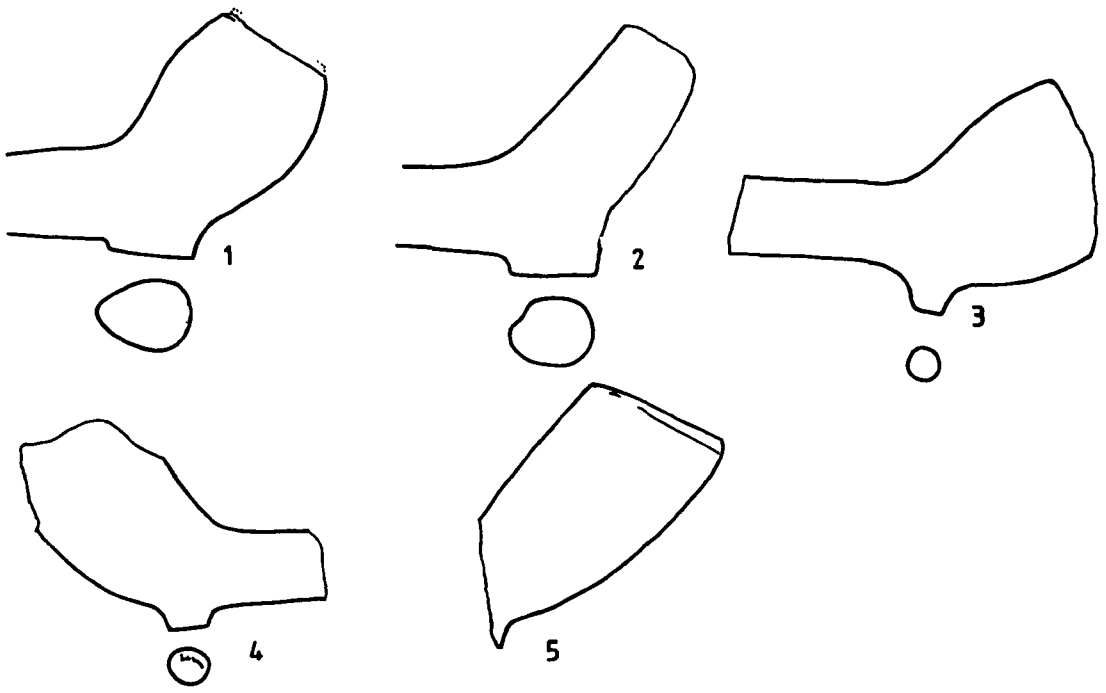
- 54.01 Heel type bowl dating from c1610-1640 from a building site on south side of the river near Skipton; rim bottered but not milled. (Pcode 21224).
- 54.02 Heel type bowl dating from c1640-1660 from a building site on south side of the river near Skipton; rim bottered and fully milled; stem bore 7/64". Marked with a Wheel on the heel. (Pcode 21218).
- 54.03 Heel type bowl dating from c1630-1650 from a building site on south side of the river near Skipton; rim bottered and fully milled; stem bore 7/64". (Pcode 21228).
- 54.04 Heel type bowl dating from c1630-1650 from a building site on south side of the river near Skipton; rim bottered and fully milled; stem bore 5/64". Marked with the initials IW on the heel. Heart shaped heel; shiny surface but does not appear to be burnished. (Pcode 21220).
- 54.05 Heel type bowl dating from c1650-1670 from a building site on south side of the river near Skipton; rim bottered and fully milled; stem bore 7/64". Marked with the initials HI on the heel. (Pcode 21217).
- 54.06 Heel type bowl dating from c1640-1660 from a building site on south side of the river near Skipton; rim bottered and fully milled; stem bore 6/64". (Pcode 21221).
- 54.07 Heel type bowl dating from c1640-1660 from a building site on south side of the river near Skipton; rim bottered and fully milled; stem bore 7/64". (Pcode 21216).
- 54.08 Heel type bowl dating from c1650-1670 from a building site on south side of the river near Skipton rim bottered and fully milled; stem bore 7/64". (Pcode 21239).
- 54.09 Heel type bowl dating from c1640-1660 from a building site on south side of the river near Skipton; rim bottered; one-quarter milled; stem bore 5/64". Abraded surface. (Pcode 21227).
- 54.10 Heel type bowl dating from c1660-1680 from a building site on south side of the river near Skipton; rim bottered and fully milled; stem bore 5/64". Abraded surface. (Pcode 21240).
- 54.11 Heel type bowl dating from c1660-1680 from a building site on south side of the river near Skipton; rim bottered and fully milled. (Pcode 21232).

- 54.12 Heel type bowl dating from c1650-1670; unprovenanced material from the Skipton area; milled; stem bore 5/64". No rim surviving. (Pcode 21242).
- 54.13 Heel type bowl dating from c1630-1650; unprovenanced material from the Skipton area rim bottered but not milled; stem bore 6/64". (Pcode 21245).
- 54.14 Heel type bowl dating from c1640-1660 from a building site on south side of the river near Skipton; rim bottered and fully milled; stem bore 7/64". (Pcode 21236).
- 54.15 Heel type bowl dating from c1640-1670 from a building site on south side of the river near Skipton; rim internally trimmed and bottered but not milled. Abraded surface; no heel. (Pcode 21238).
- 54.16 Heel type bowl dating from c1650-1670; unprovenanced material from the Skipton area; milled; stem bore 6/64". Heel broken. (Pcode 21243).
- 54.17 Heel type bowl dating from c1650-1670 from a building site on south side of the river near Skipton; rim bottered but not milled; stem bore 6/64". (Pcode 21229).
- 54.18 Heel type bowl dating from c1660-1680 from a building site on south side of the river near Skipton; rim bottered but not milled; stem bore 7/64". Abraded surface. (Pcode 21237).
- 54.19 Heel type bowl dating from c1660-1680 from a building site on south side of the river near Skipton; rim bottered but not milled; stem bore 6/64". (Pcode 21231).
- 55.01 Heel type bowl dating from c1660-1680 from a building site on south side of the river near Skipton; not milled; stem bore 5/64". Rim damaged. (Pcode 21230).
- 55.02 Heel type bowl dating from c1670-1700 from a building site on south side of the river near Skipton; stem bore 5/64". Marked with the initials IW on the heel. No rim surviving. (Pcode 21241).
- 55.03 Spur type bowl dating from c1670-1690; unprovenanced material from the Skipton area; stem bore 7/64". No rim surviving. (Pcode 21244).
- 55.04 Heel type bowl dating from c1680-1710 from a building site on south side of the river near Skipton rim bottered; stem bore 5/64". Marked with the initials? S on the heel; very abraded. (Pcode 21219).
- 55.05 Spur type bowl dating from c1690-1710; unprovenanced material from the Skipton area; rim internally trimmed and bottered but not milled. Spur broken; abraded surface. (Pcode 21246).



**Figure 54: Pipes from the Tierney Collection, Nr. Skipton. Scale 1:1**





**Figure 55: Pipes from the Tierney Collection, Nr. Skipton. Scale 1:1**

**Collection Name:** Yorkshire Dales Museum of Lead Mining

**Collection Code:** 0251

**Contact Name:** Mr Peter Hart

**Address:** Earby, Nr Skipton, North Yorkshire

**Description:**

Collection recorded 13<sup>th</sup> September 2001. The museum has a collection of around 60 relatively complete bowls with a few broken fragments and stems. The majority of these have been collected from disused mine workings. There is a small number of seventeenth-century fragments but the majority are nineteenth century with a few dating from the early twentieth century. Most of the pipes were displayed in sealed cases and could not be examined more closely these include a bowl dating from c1640-1660 which appeared to have a stamped mark. The most notable later pipes from the collection are as follows;

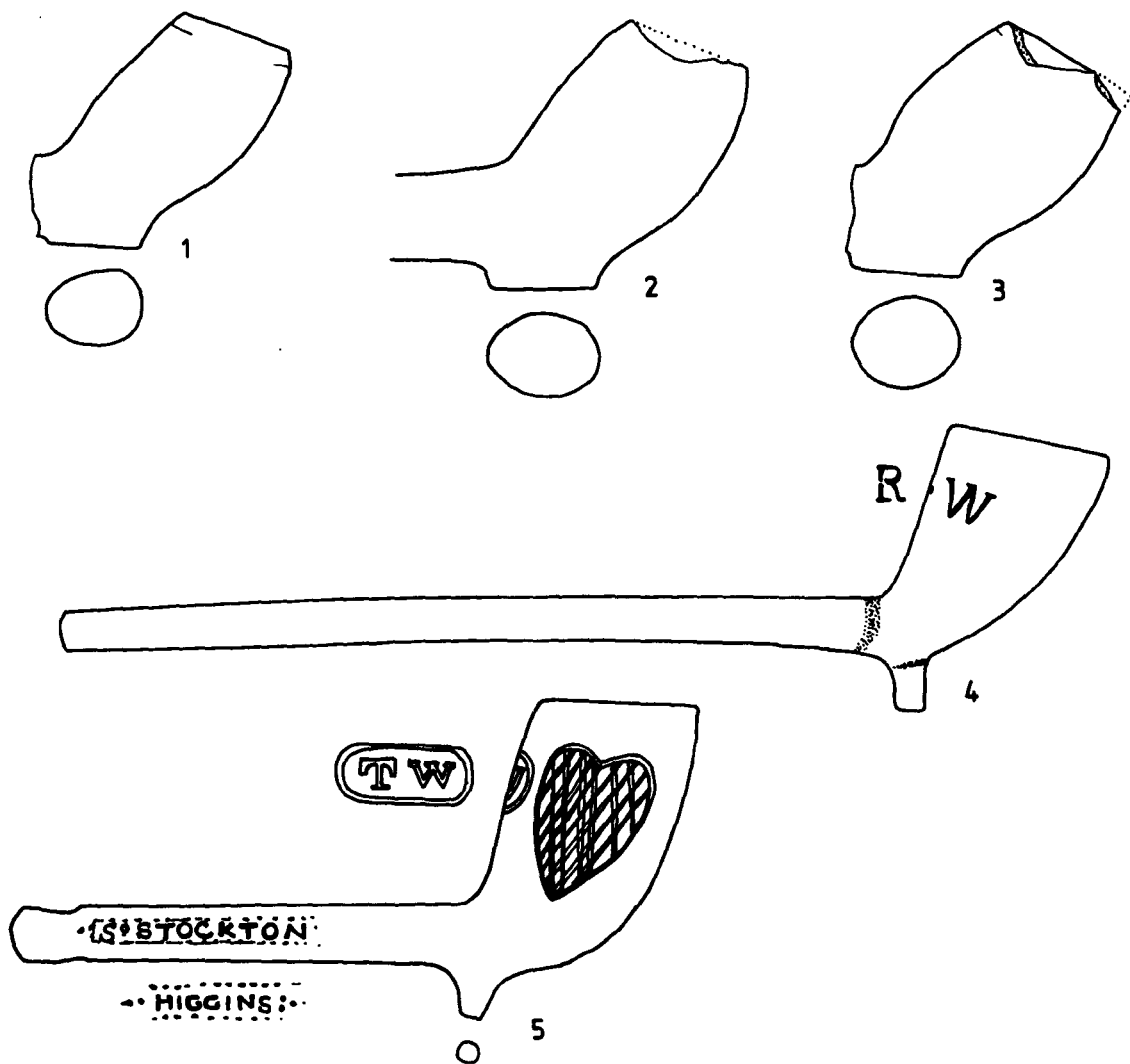
- 633 – metal pipe from the Raistrick Collection with the punched initials RW with a dot between them facing the smoker
- Boxing pipe showing the boxers Sayers and Heenan from c1860
- Flutes and swags bowl with the lettering TD either side of the bowl
- Bowl with a ship on the left-hand side and Britannia on the right-hand side
- PIRM790 – complete RAOB bowl with the lettering WM TENNANT/NEWCASTLE along the stem.
- PIRM 791 – plain bowl with the lettering WM TENNANT/NEWCASTLE along the stem.
- 796/794/774 – three TW bowls with hatched heart on one side of the bowl
- 24.55 P8 – Bowl with Masonic emblems on the left-hand side and a lion in a shield on the right-hand side.
- 697 - Irish style bowl with the lettering TENNENT & SON/BERWICK along the stem.

56.01 Heel type bowl dating from c1640-1660 from Lolly Scar Mine, Nidderdale (Acc No. 28); rim bottered but not milled; stem bore 7/64". (Pcode 25169).

56.02 Heel type bowl dating from c1660-1680 from Swaledale Mines (Acc No. 27-58-P11); rim bottered; stem bore 7/64". Badly abraded surface. (Pcode 25168).

56.03 Heel type bowl dating from c1660-1680 from Greenhow Mines (Acc No. 22/53 P6); rim bottered but not milled; stem bore 8/64". (Pcode 25167).

56.04 Spur type bowl made of metal dating from the nineteenth century, unprovenanced material in Earby Museum); stem bore 5/64". Marked with the initials RW on the bowl facing the smoker. Metal pipe with brass soldered seams.



**Figure 56:** Pipes from the collections of the Yorkshire Dales Museum of Lead Mining, Earby. Scale 1:1

**Collection Name:** Mercer Art Gallery  
**Collection Code:** 0133  
**Contact Name:** Mary Kershaw  
**Address:** Harrogate, North Yorkshire

**Description:**

Collection recorded 2<sup>nd</sup> May 1995. The collection comprised a large quantity of pipe fragments from excavations at Knaresborough Castle in 1988, 1989 and 1990. The group consisted mainly of seventeenth-century material with some from the eighteenth and nineteenth century. Approximately 57 pipe fragments dated from the seventeenth and eighteenth century were recorded in detail for the Yorkshire Database.

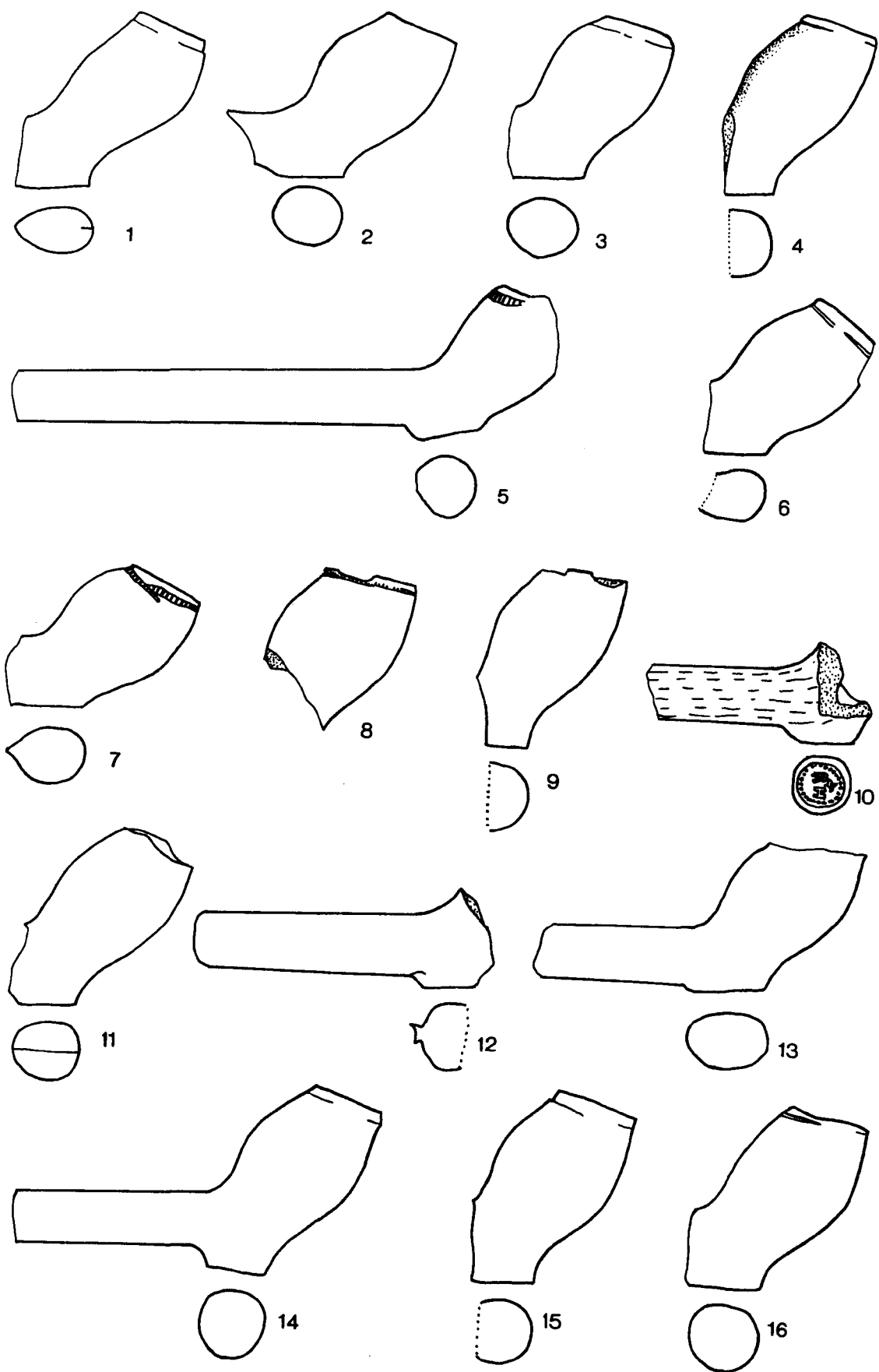
In addition to those fragments recorded in detail there were a small number of later pipe fragments the most notable of which are as follows:

- KNC/89/1156 – stem of a FOOTBALL PIPE
- KNC/89/2002 – stem of a mould decorated pipe with the pattern number 77 visible.
- KNC/88/1019 – hair curler
- KNC/90/2002 – stem with the lettering JWR W.../ IN LEEDS

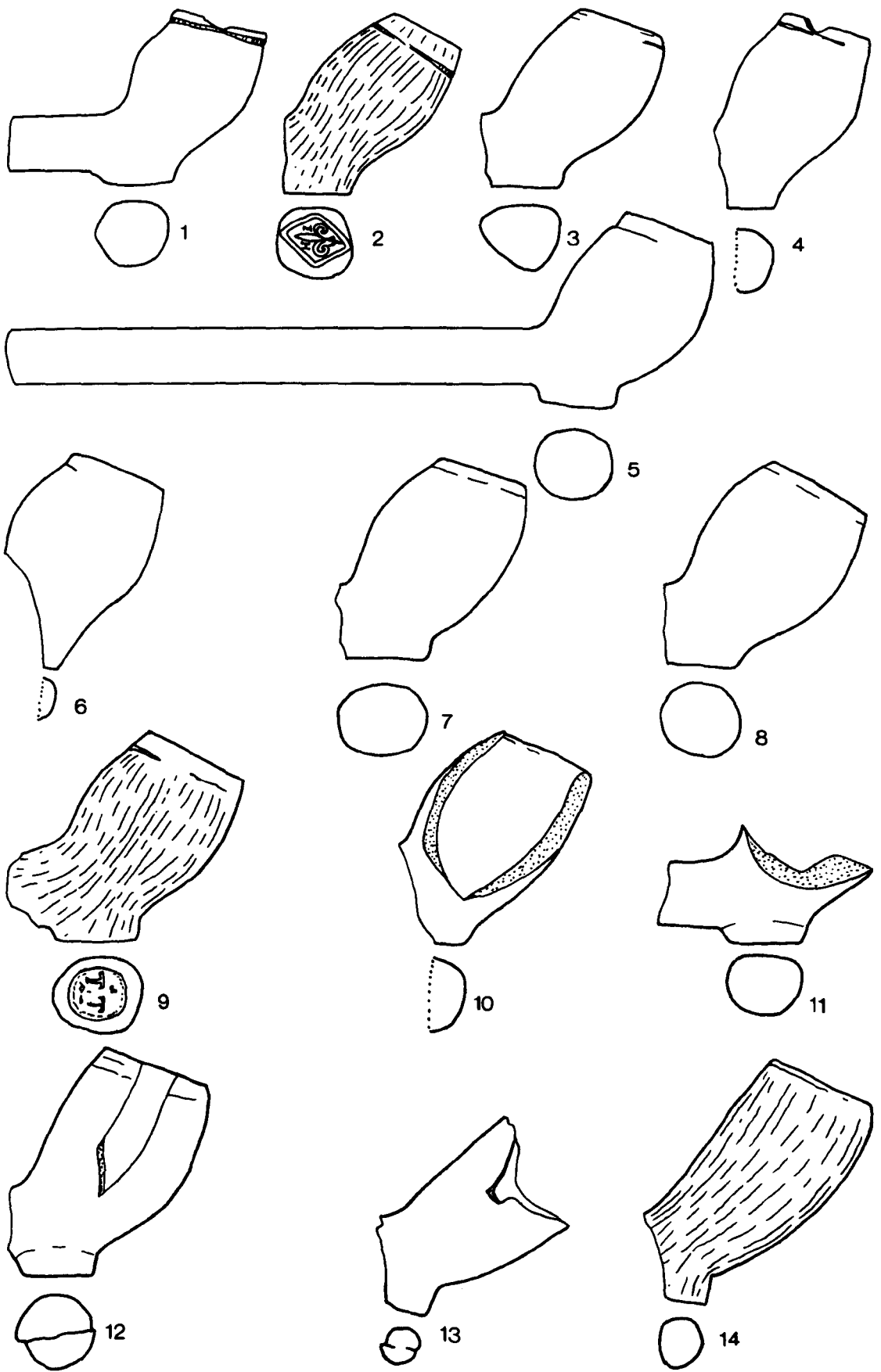
- 57.01 Heel type bowl dating from c1640-1660 (Acc No. KNC90 2144). Rim bottered but not milled. (Pcode 06065).
- 57.02 Heel type bowl dating from c1640-1660 (Acc No. KNC90 2144). Rim bottered but not milled. One of two examples from this context. (Pcode 06067).
- 57.03 Heel type bowl dating from c1640-1660 (Acc No. KNC88 1036) Rim bottered and fully milled. (Pcode 06035).
- 57.04 Heel type bowl dating from c1640-1660 (Acc No. KNC90 2144). Rim bottered but not milled. Pale yellow glaze on the bowl facing the smoker. (Pcode 06063).
- 57.05 Heel type bowl dating from c1640-1660 (Acc No. KNC). Not burnished; bottered and milled on all surviving rim. (Pcode 06031).
- 57.06 Heel type bowl dating from c1640-1660 (Acc No. KNC90 2118). Rim bottered and fully milled. Similar example from KNC90 2087. (Pcode 06061).
- 57.07 Heel type bowl dating from c1640-1660 (Acc No. KNC89 1168). Rim bottered and fully milled. One of two examples from this context. (Pcode 06044).
- 57.08 Bowl dating from c1640-1660 (Acc No. KNC90 2144). Rim bottered and fully milled; base of bowl missing. (Pcode 06064).

- 57.09 Heel type bowl dating from c1640-1660 (Acc No. KNC90 2144). Rim bottered. Similar example Acc No. KNC90 2066. (Pcode 06066).
- 57.10 Heel type bowl dating from c1630-1670 (Acc No. KNC88 1023). Poor burnish; no rim surviving; heel stamped with an RH mark. (Pcode 03371).
- 57.11 Heel type bowl dating from c1650-1670 (Acc No. KNC90 2051). Not burnished; no rim surviving. (Pcode 06054).
- 57.12 Heel type bowl dating from c1640-1680 (Acc No. KNC89 1129). Not burnished; no rim surviving; stem broken off and rounded. (Pcode 06041).
- 57.13 Heel type bowl dating from c1650-1670 (Acc No. KNC90 2152). Not burnished; no rim surviving. Similar example from KNC89 1168. (Pcode 06069).
- 57.14 Heel type bowl dating from c1650-1670 (Acc No. KNC90 2014). Rim bottered but not milled. One of three examples from this context. (Pcode 06048).
- 57.15 Heel type bowl dating from c1650-1670 (Acc No. KNC90 2144). Rim bottered and quarter milled. (Pcode 06070).
- 57.16 Heel type bowl dating from c1650-1670 (Acc No. KNC90 2050). Rim bottered and partially milled. (Pcode 06051).
- 58.01 Heel type bowl dating from c1650-1670 (Acc No. KNC). Rim bottered and fully milled. One of two examples from this context. (Pcode 06027).
- 58.02 Heel type bowl dating from c1650-1670 (Acc No. KNC88 1075). Good burnish; rim bottered and fully milled; heel stamped with the initials HF either side of a fleur-de-lys design. (Pcode 03369).
- 58.03 Heel type bowl dating from c1650-1670 (Acc No. KNC90 2050). Rim bottered but not milled. (Pcode 06052).
- 58.04 Heel type bowl dating from c1650-1670 (Acc No. KNC90 2141). Not burnished but bowl appears to have been wiped; rim bottered and half milled. (Pcode 06062).
- 58.05 Heel type bowl dating from c1660-1680 (Acc No. KNC). Rim bottered but not milled. One of two examples from this context. (Pcode 06028).
- 58.06 Heel type bowl dating from c1660-1690 (Acc No. KNC90 2113). Rim bottered but not milled. (Pcode 06060).
- 58.07 Heel type bowl dating from c1660-1690 (Acc No. KNC89 1153). Rim bottered but not milled. (Pcode 06042).

- 58.08 Heel type bowl dating from c1660-1690 (Acc No. KNC88 1075). Rim bottered but not milled. (Pcode 06037).
- 58.09 Heel type bowl dating from c1660-1700 (Acc No. KNC90 2050). Good burnish; rim bottered and quarter milled; heel stamped with a TT mark. (Pcode 03388).
- 58.10 Heel type bowl dating from c1660-1700 (Acc No. KNC90 2051). Rim bottered but not milled. (Pcode 06053).
- 58.11 Heel type bowl dating from c1660-1700 (Acc No. KNC88 1061). Not burnished; no rim surviving. (Pcode 06036).
- 58.12 Heel type bowl dating from c1670-1700 (Acc No. KNC88 1081). Rim bottered but not milled; heel flared. (Pcode 06038).
- 58.13 Heel type bowl dating from c1680-1710 (Acc No. KNC88 1003). Not burnished; no rim surviving. (Pcode 06033).
- 58.14 Heel type bowl dating from c1680-1710 (Acc No. KNC89 1153). Average burnish; rim bottered but not milled. Similar example from KNC90 2001. (Pcode 06043).
- 59.01 Bowl dating from c1680-1710 (Acc No. KNC89 1038). Average burnish; rim bottered but not milled; plug of lead in the base of the bowl. (Pcode 06040).
- 59.02 Heel type bowl dating from c1700-1720 (Acc No. KNC). Rim bottered but not milled. (Pcode 06026).
- 59.03 Heel type bowl dating from c1700-1770 (Acc No. KNC89 1247). Poor burnish; no rim surviving; stem stamped with a cross, or Roman numeral X in a circle approximately 17mm from the bowl. (Pcode 03363).
- 59.04 Heel type bowl dating from c1700-1770 (Acc No. KNC88 1003). Not burnished; cut rim; moulded initials SH on either side of the heel. Similar example from KNC89 1191, which may originate from the same mould. (Pcode 06032).
- 59.05 Part of a wig curler with the initials WS impressed in to the end;) dating from the 18<sup>th</sup> century.
- 59.06 Heel type bowl dating from c1700-1770 (Acc No. KNC90 2086). Not burnished; no rim surviving. (Pcode 06058).

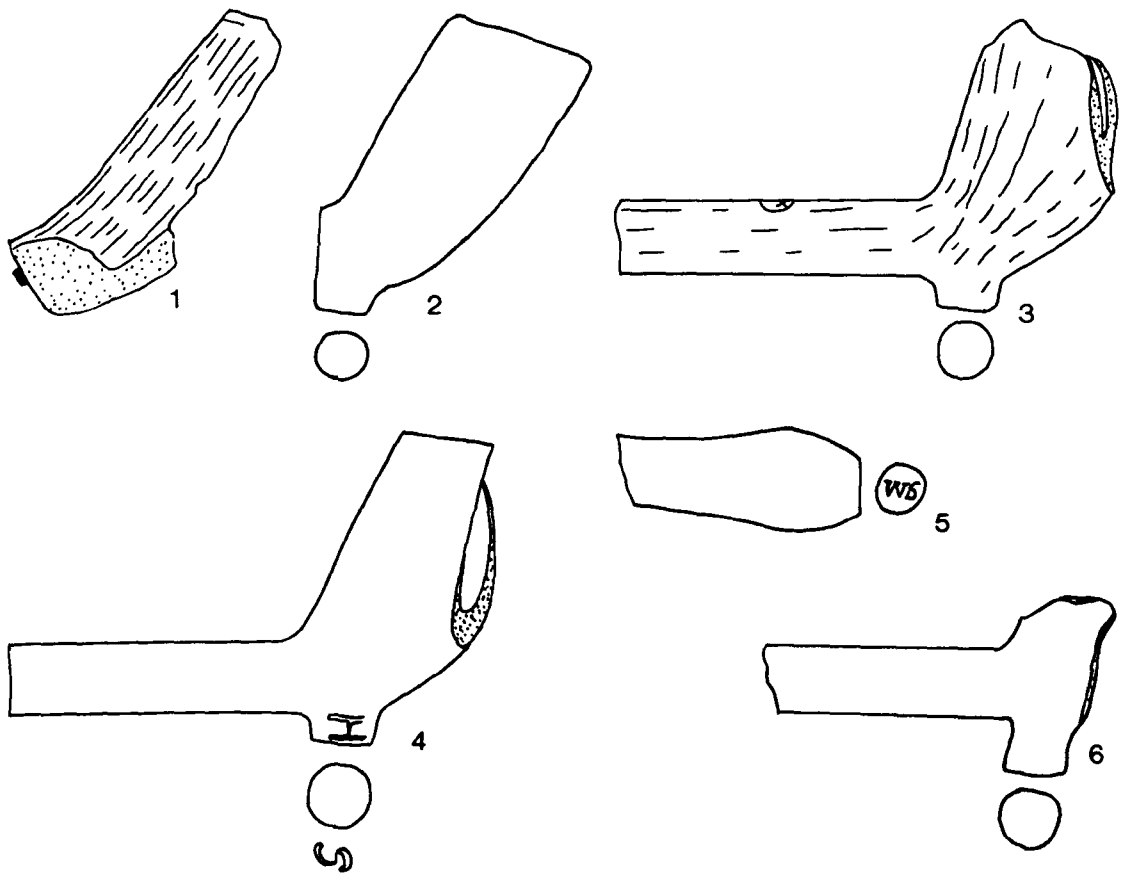


**Figure 57:** Pipes from The Mercer Art Gallery, Harrogate. Scale 1:1



**Figure 58:** Pipes from The Mercer Art Gallery, Harrogate. Scale 1:1





**Figure 59:** Pipes from The Mercer Art Gallery, Harrogate. Scale 1:1

**Collection Name:** Dales Countryside Museum  
**Collection Code:** 0131  
**Contact Name:** Mr Martin Gresswell  
**Address:** Hawes, Wensleydale, North Yorkshire  
**Description:**

A small collection of pipes recorded on 3<sup>rd</sup> May 1995. The collection comprises just three bowls of seventeenth-century date with a number of later bowls, the most notable are as follows:

- T331 – Woodstock pipe dating c1850-1920
- T335 – small pipe with the lettering T KAY MAKER/LEEDS on the bowl facing the smoker.
- 655 – A complete moulded decorated bowl with the lettering W.BREWSTER SUNDERLAND moulded along the sides of the stem within a beaded border
- HAZFM 1629 – Complete pipe with two footballers on either side of the bowl and a ball on the front seam.
- HAZFM 198 – French bowl in the form of a rooster's head.

60.01 Heel type bowl dating from c1620-1640 (Acc No. T332). Average burnish; rim bottered and fully milled; heel stamped with a wheel mark.

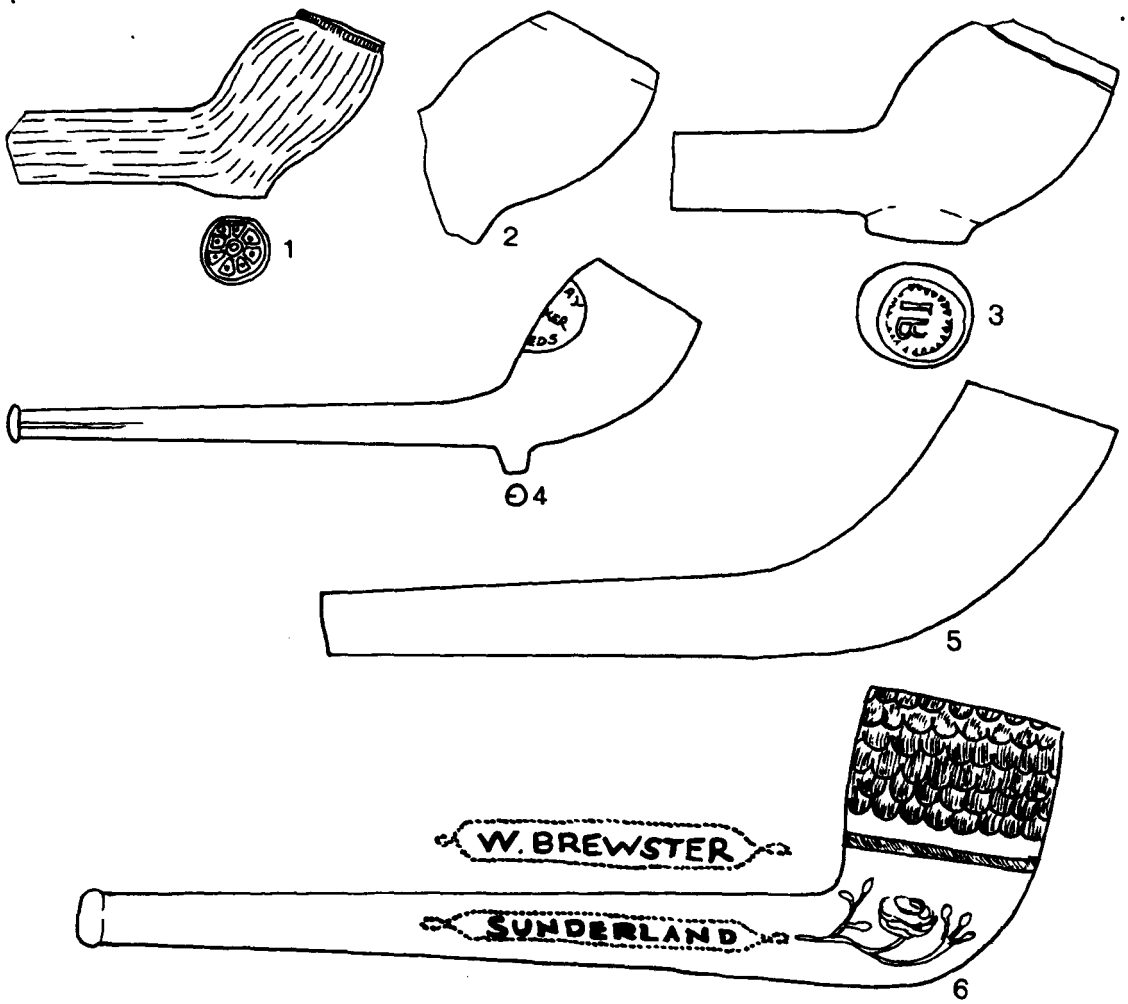
60.02 Heel type bowl dating from c1660-1640 (Acc No. T333). Rim bottered but not milled; heel missing.

60.03 Heel type bowl dating from c1660-1680 (Acc No. T334). Rim bottered and three quarters milled; heel stamped with a circular mark containing the initials IB.

60.04 Spur type bowl dating from c1850-1890 (Acc No. T335). Rim cut; stamped on the back of the bowl facing the smoker with the mark T. KAY/MAKER/LEEDS. The pipe has been well smoked.

60.05 Spurless type bowl dating from c1850-1920 (Acc No. T331). Rim cut.

60.06 Mould decorated bowl dating from c1938-1953 (Acc No. 655); bearing the makers name W.BREWSTER on the smokers left and SUNDERLAND on the smokers right all in incuse serif lettering within a beaded border in relief.



**Figure 60:** Pipes from the collections of the Dales Countryside Museum, Hawes.  
Scale 1:1

**Collection Name:** English Heritage Archaeological Store

**Collection Code:** 0231

**Contact Name:** Mr Andrew Morrison

**Address:** Helmsley, North Yorkshire

**Description:**

Large collection of pipes recorded 21<sup>st</sup> March 2001 at this time arrangements were made to borrow a group of pipes from Scarborough Castle, Mount Grace Priory, Thornton Abbey and Clifford's Tower for recording back in Liverpool. The clay tobacco pipes stored at Helmsley come from a number of sites in Yorkshire as well as some in Cumbria and North Lincolnshire. The pipes range from the early seventeenth century right through to the nineteenth and early twentieth century. In addition to those pipes from the seventeenth and eighteenth centuries recorded in detail on the Yorkshire Database and for the National Stamp Catalogue the most notable nineteenth-century pipes are as follows:

- RB97 2 – TW spur bowl
- RVA 307 (85000368) – Bowl with Masonic decoration dating from c1800-1840. The initial T moulded on the right-hand side of the design. Fairly short bowl; spur missing.
- RVA 455 (8500372) – Spur bowl of c1810-1850 with small spur and quite crude leaf decorated seams.
- 88210211 – part of a bowl moulded in the form of a tankard c1870-1920. only part of a moulded name survives but probably a Tennant product from Newcastle.
- 88210265 – stem fragment with the incuse stem mark of TENNANT/BERWICK and the mould number 11 on the side of the stem.
- MG89 550 – Complete bowl with the incuse mark TW facing the smoker with a hatched heart on the right-hand side and a small dot on each side of the spur in relief.
- Box of pipes from Goodshaw Chapel (88074789) comprising a collection of plain stems, mouthpieces and bowl fragments all dating from the late eighteenth or nineteenth century. Overall this group is almost exclusively c1810-1850 in date.
- Group of pipes from excavations at Scarborough castle comprising 110 pipe fragments 38 of which date from the seventeenth century, 19 from the eighteenth and 53 from the nineteenth. Approximately two-thirds of these fragments are plain stems and mouthpieces. There were a small number of Dutch stems and some marked seventeenth-century bowls which are thought to be Scarborough products. The nineteenth-century material includes mould decorated bowls with ship and anchor motifs, flutes and swags and heart in hand motifs. A full report on the clay tobacco pipes has been prepared (White 2001b)

61.01 Heel type bowl dating from c1640-1660 from Brougham Castle; average burnish; rim bottered and not milled; stem bore 7/64". EH Number 88212137. (Pcode 21095).

61.02 Heel type bowl dating from c1690-1720 from Baguley Hall (Acc No. BH77 2 (9)); stem bore 7/64". Heel fragment only; possibly Chester; EH number 88074714. (Pcode 21101).

- 61.03 Spur type bowl dating from c1660-1680 from Baguley Hall (Acc No. BH77 5 (6)); poorly burnished; rim bottered and one quarter milled; stem bore 7/64". EH number 88074710. (Pcode 21102).
- 61.04 Heel type bowl dating from c1610-1640 from Barnard Castle Excavations (Acc No. Gate House); good burnish; rim bottered and fully milled; stem bore 8/64". EH Number 88106980/1. (Pcode 21117).
- 61.05 Heel type bowl dating from c1630-1650 from excavations at Scarborough Castle 1977 (Acc No. Trench 1 Layer 9); rim internally trimmed, bottered and half milled; stem bore 7/64". (Pcode 24946).
- 61.06 Heel type bowl dating from c1610-1640 from Barnard Castle Excavations (Acc No. Gate House); rim bottered and fully milled; stem bore 8/64". Marked with a Tudor Rose on the heel. EH Number 88106980/1. (Pcode 21118).
- 61.07 Heel type bowl dating from c1640-1660 from excavations at Scarborough Castle 1977 (Acc No. Trench 1 Layer 8); rim bottered and not milled; stem bore 7/64". Possibly Dutch. (Pcode 24937).
- 61.08 Heel type bowl dating from c1640-1660 from excavations at Scarborough Castle 1977 (Acc No. Trench 1 Layer 3); rim internally trimmed and bottered; milled around all of the surviving rim; stem bore 7/64". (Pcode 24934).
- 61.09 Heel type bowl dating from c1650-1670 from excavations at Scarborough Castle 1977 (Acc No. Trench 1 Layer 4); average burnish; rim internally trimmed and bottered; milled around all of the surviving rim; stem bore 6/64". (Pcode 24928).
- 61.10 Heel type bowl dating from c1660-1690 from excavations at Scarborough Castle 1977 (Acc No. Trench 1 Layer 9); rim bottered; milled around all of the surviving rim; stem bore 6/64". (Pcode 24945).
- 61.11 Heel type bowl dating from c1660-1680 from excavations at Scarborough Castle 1977 (Acc No. Trench 1 Layer 8); rim bottered and half milled; stem bore 7/64". (Pcode 24942).
- 61.12 Heel type bowl dating from c1660-1690 from excavations at Scarborough Castle 1977 (Acc No. Trench 1 Layer 4); rim bottered and half milled; stem bore 6/64". (Pcode 24926).
- 61.13 Heel type bowl dating from c1660-1690 from excavations at Scarborough Castle 1977 (Acc No. Trench 1 Layer 4); good burnish; rim bottered and not milled; stem bore 7/64". Marked with the initials RE on the heel. (Pcode 24927).

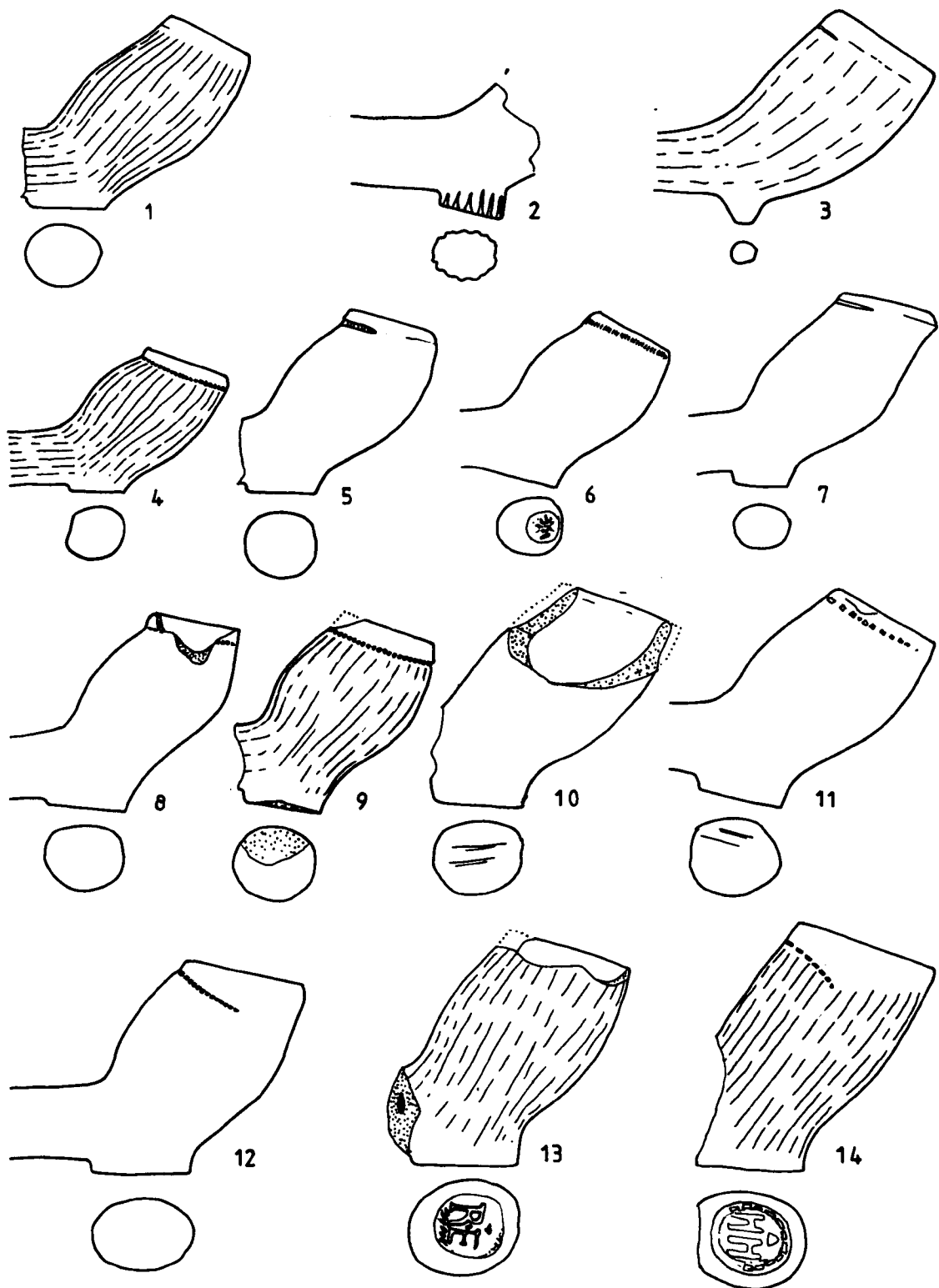
- 61.14 Heel type bowl dating from c1660-1690 from excavations at Scarborough Castle 1977 (Acc No. Trench 1 Layer 8); average burnish; rim bottered and half milled; stem bore 6/64". Marked with the initials HH on the heel. (Pcode 24943).
- 62.01 Spur type bowl dating from c1690-1720 from excavations at Scarborough Castle 1977 (Acc No. Trench 1 Layer 4); stem bore 5/64". No rim surviving. (Pcode 24929).
- 62.02 Dutch stem fragment dating from c1690-1740 from excavations at Scarborough Castle 1977 (Acc No. Trench 1 Layer 8); stem bore 6/64". Dutch with a stem twist. (Pcode 24941).
- 62.03 Heel type bowl dating from c1700-1770 from excavations at Scarborough Castle 1977 (Acc No. Trench 1 Layer 3); rim wiped and not milled; stem bore 4/64". Marked with the initials I/TH on the sides of the heel. (Pcode 24950).
- 62.04 Heel type bowl dating from c1610-1640 from Helmsley Castle; rim bottered and fully milled; stem bore 5/64". Very highly fired; heel trimmed at an angle; appears to have a cut on the heel but it has fractured along this line. (Pcode 21135).
- 62.05 Heel type bowl dating from c1640-1660 from Helmsley Castle; rim bottered and fully milled; stem bore 6/64". EH Number 81003034. (Pcode 21130).
- 62.06 Heel type bowl dating from c1640-1660 from Helmsley Castle; rim bottered and fully milled; stem bore 6/64". EH Number 81003034. (Pcode 21131).
- 62.07 Heel type bowl dating from c1640-1660 from Helmsley Castle; rim bottered; milled around all of the surviving rim; stem bore 6/64". EH Number 81003034. (Pcode 21132).
- 62.08 Spur type bowl dating from c1640-1660 from Helmsley Castle; no internal bowl cross; rim bottered and fully milled; stem bore 6/64". EH Number 81003034. (Pcode 21134).
- 62.09 Heel type bowl dating from c1640-1660 from Helmsley Castle; rim bottered and fully milled; stem bore 7/64". (Pcode 21136).
- 62.10 Heel type bowl dating from c1680-1700 from Helmsley Castle; poorly burnished; rim bottered and half milled; stem bore 7/64". Marked with the initials RS on the heel. (Pcode 21137).
- 62.11 Heel type bowl dating from c1680-1710 from Helmsley Castle; average burnish; rim bottered and not milled; stem bore 5/64". Marked with the initials WS on the heel. EH Number 81003034. (Pcode 21129).

- 62.12 Heel type bowl dating from c1690-1730 from Helmsley Castle; rim internally trimmed, bottered and not milled; stem bore 5/64". Marked with the initials IS on the heel. (Pcode 21138).
- 62.13 Heel type bowl dating from c1690-1730 from Helmsley Castle; rim internally trimmed, bottered and not milled; stem bore 5/64". Marked with the initials AB on the heel. Poorly preserved mark. (Pcode 21139).
- 63.01 Heel type bowl dating from c1700-1770 from Helmsley Castle; rim internally trimmed, bottered and not milled; stem bore 5/64". Similar to Hull Type 7e. (Pcode 21140).
- 63.02 Heel type bowl dating from c1630-1650 from Mount Grace Priory (Acc No. MG91 1304); rim bottered and one quarter milled; stem bore 7/64". (Pcode 24570).
- 63.03 Heel type bowl dating from c1640-1660 from Mount Grace Priory (Acc No. MG91 1364); good burnish; rim bottered and not milled; stem bore 7/64". Marked with the initials HF flanking a fleur-de-lys on the heel. Same die as Pcode 24560 but bowl form is different. (Pcode 24561).
- 63.04 Heel type bowl dating from c1640-1660 from Mount Grace Priory (Acc No. MG91 1312); average burnish; milled around all of the surviving rim; stem bore 7/64". Marked with the initials HF flanking a fleur-de-lys on the heel. (Pcode 24560).
- 63.05 Heel type bowl dating from c1650-1670 from Mount Grace Priory (Acc No. MG91 1364); no internal bowl cross; rim bottered and not milled; stem bore 7/64". (Pcode 24562).
- 63.06 Bowl dating from c1650-1670 from Mount Grace Priory (Acc No. MG91 1300); rim bottered; milled around all of the surviving rim. Small bowl fragment but appears to be quite early. (Pcode 24571).
- 63.07 Heel type bowl dating from c1650-1670 from Mount Grace Priory (Acc No. MG91 1300); rim bottered; milled around all of the surviving rim; stem bore 7/64". (Pcode 24572).
- 63.08 Spur type bowl dating from c1680-1720 from Ravensdown Barracks (Acc No. RB98); stem bore 6/64". Marked with the lettering LEONARDHOLMES across the stem. (Pcode 20199).
- 63.09 Spur type bowl dating from c1690-1730 from Ravensdown Barracks (Acc No. RB98); stem bore 7/64". (Pcode 21098).
- 63.10 Heel type bowl dating from c1700-1770 from Ravensdown Barracks (Acc No. RB98 107); rim bottered and not milled; stem bore 7/64". Marked with the initials ?C on the sides of the heel. (Pcode 21096).

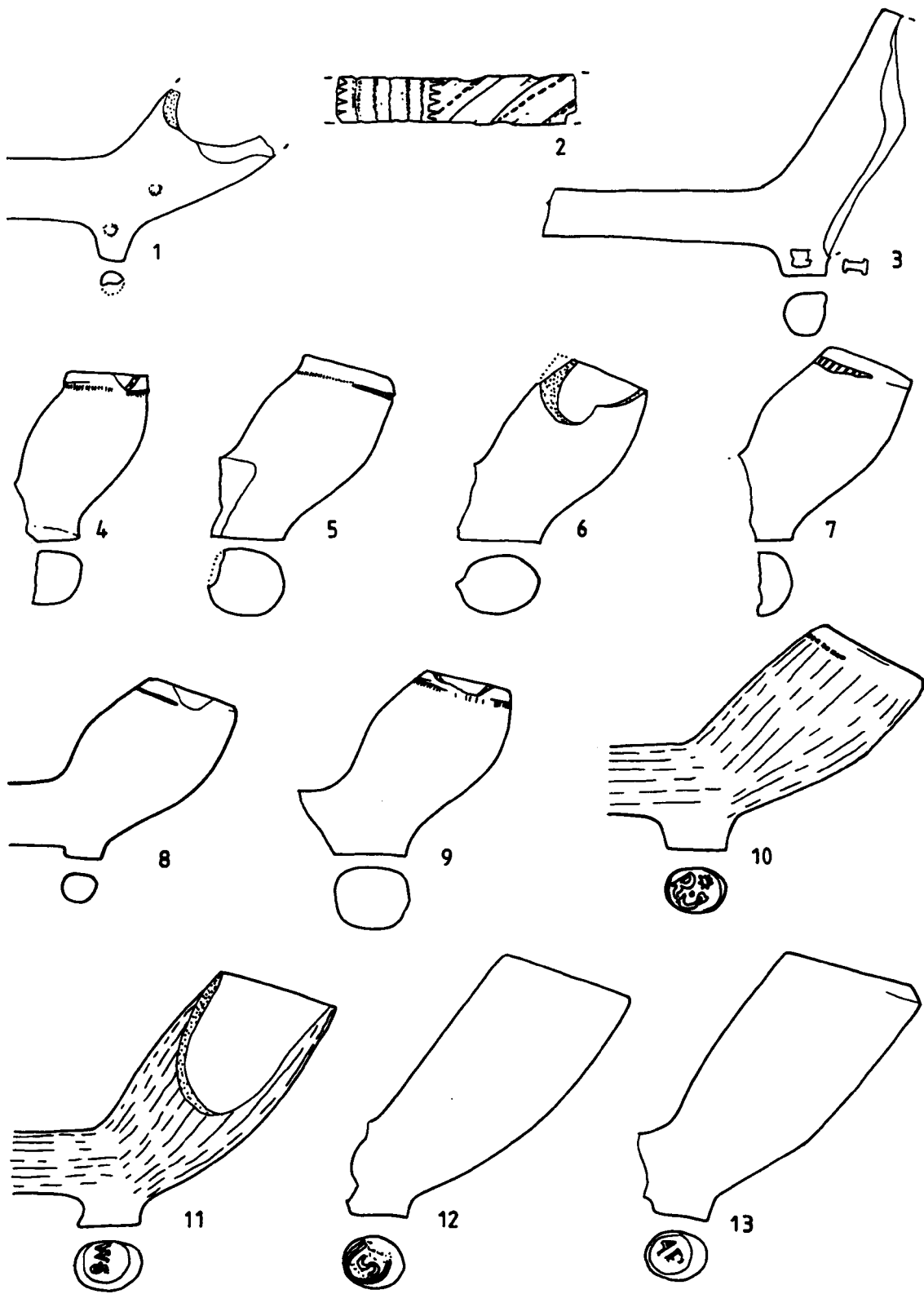
- 63.11 Heel type bowl dating from c1700-1770 from Ravensdown Barracks (Acc No. RB98); rim bottered and not milled; stem bore 7/64". Marked with a gauntlet and crown on the sides of the heel. (Pcode 21097).
- 64.01 Bowl fragment dating from c1600-1630 from Richmond Castle; rim bottered; milled around all of the surviving rim. Bowl fragment only; possibly not a Yorkshire product; very bulbous and forward leaning with a glossy surface; EH Number 81014036. (Pcode 21119).
- 64.02 Heel type bowl dating from c1620-1640 from Rievaulx Abbey (Acc No. RVA 310 (a)); rim bottered; milled around all of the surviving rim; stem bore 7/64". Heel broken; EH Number 85000367. (Pcode 21116).
- 64.03 Heel type bowl dating from c1630-1650 from Rievaulx Abbey (Acc No. RVA 311 (a)); average burnish; rim bottered and fully milled; stem bore 7/64". EH Number 85000373. (Pcode 21105).
- 64.04 Heel type bowl dating from c1660-1680 from Rievaulx Abbey (Acc No. RVA 312 (a)); no internal bowl cross; rim bottered and half milled; stem bore 7/64". Rather lumpy; shiny surface but no obvious burnish lines; EH Number 85000305. (Pcode 21111).
- 64.05 Heel type bowl dating from c1660-1690 from Rievaulx Abbey (Acc No. RVA 310 (d)); rim bottered and not milled; stem bore 6/64". EH Number 85000367. (Pcode 21113).
- 64.06 Heel type bowl dating from c1660-1680 from Rievaulx Abbey; average burnish; rim bottered and half milled; stem bore 7/64". Marked with the initials AB on the heel. Similar to York Type 10; Abraham Boyes of York; Joins Pcode 21110; stem broken but appears to be worn and re-used; EH Number 85000305. (Pcode 21109).
- 64.07 Heel type bowl dating from c1660-1690 from Rievaulx Abbey (Acc No. RVA 311 (b)); poorly burnished; rim bottered and one quarter milled; stem bore 7/64". Marked with the initials IM on the heel. EH Number 85000373. (Pcode 21104).
- 64.08 Heel type bowl dating from c1670-1700 from Rievaulx Abbey (Acc No. RVA 310 (b)); rim bottered and half milled; stem bore 5/64". Similar to York Type 14; EH Number 85000367. (Pcode 21115).
- 64.09 Heel type bowl dating from c1690-1720 from Rievaulx Abbey (Acc No. RVA 312 (c)); no internal bowl cross; rim bottered and half milled; stem bore 5/64". Marked with the initials AB on the heel. Shiny surface but no obvious burnishing lines. (Pcode 21108).
- 64.10 Heel type bowl dating from c1690-1720 from Rievaulx Abbey (Acc No. RVA 310 (c)); no internal bowl cross; rim bottered and not milled; stem bore 6/64". EH Number 85000367; very crudely made; surfaces abraded. (Pcode 21114).



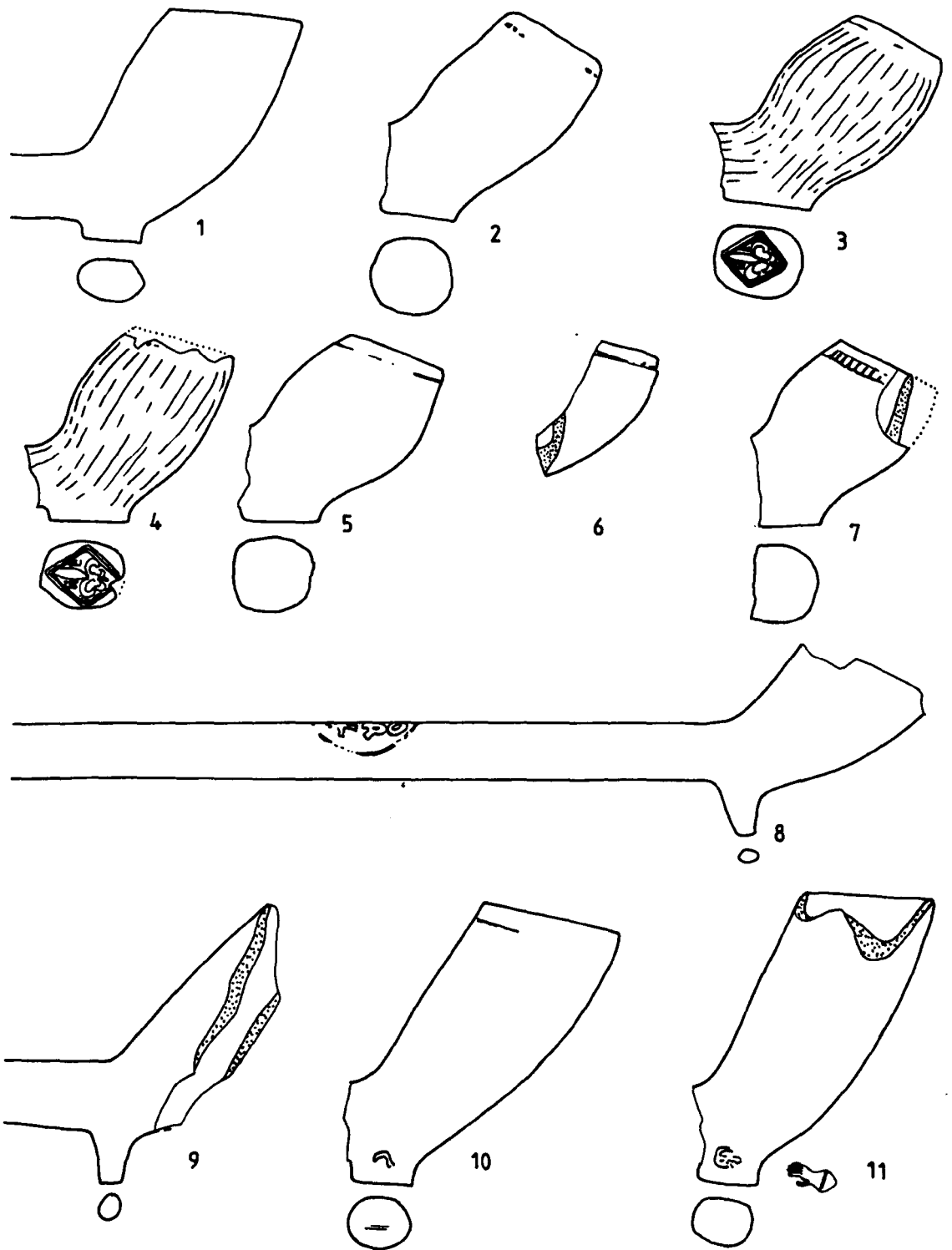
- 64.11 Heel type bowl dating from c1690-1720 from Rievaulx Abbey (Acc No. RVA 308 (b)); rim bottered and not milled; stem bore 5/64". Appears to be water-worn; EH Number 85000369. (Pcode 21107).
- 64.12 Heel type bowl dating from c1630-1650 from Whitby Abbey; no internal bowl cross; rim bottered and fully milled; stem bore 6/64". EH Number 8807355. (Pcode 21120).
- 64.13 Heel type bowl dating from c1640-1660 from Whitby Abbey; rim bottered and fully milled; stem bore 8/64". EH Number 8807355. (Pcode 21121).
- 65.01 Spur type bowl dating from c1640-1660 from Whitby Abbey; rim bottered and fully milled; stem bore 7/64". EH Number 8807355. (Pcode 21122).
- 65.02 Heel type bowl dating from c1660-1680 from Whitby Abbey; rim bottered and not milled; stem bore 7/64". Marked with the initials II on the heel. Possibly a Hull product; EH Number 8807355. (Pcode 21124).
- 65.03 Heel type bowl dating from c1660-1690 from Whitby Abbey; no internal bowl cross; rim bottered; milled around all of the surviving rim; stem bore 6/64". Marked with the initials HH on the heel. Abraded surface; EH Number 8807355. (Pcode 21125).
- 65.04 Spur type bowl dating from c1660-1680 from Whitby Abbey; rim bottered and half milled; stem bore 7/64". EH Number 8807355. (Pcode 21127).
- 65.05 Spur type bowl dating from c1680-1710 from Whitby Abbey; rim bottered and not milled; stem bore 5/64". Similar to Hull Type 4; very neatly finished; EH Number 8807355. (Pcode 21128).



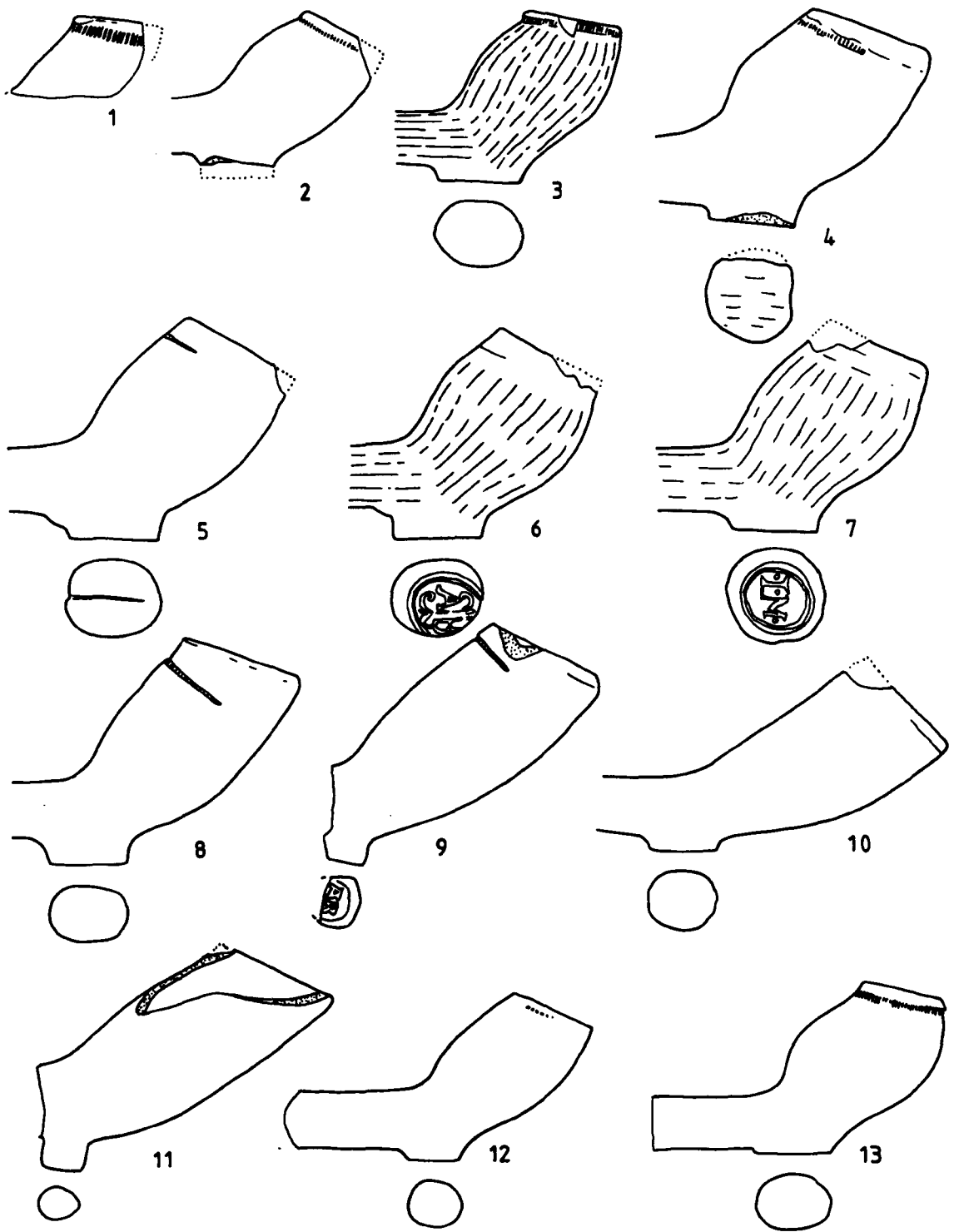
**Figure 61:** Pipes held by English Heritage at their archaeological store in Helmsley. Scale 1:1.



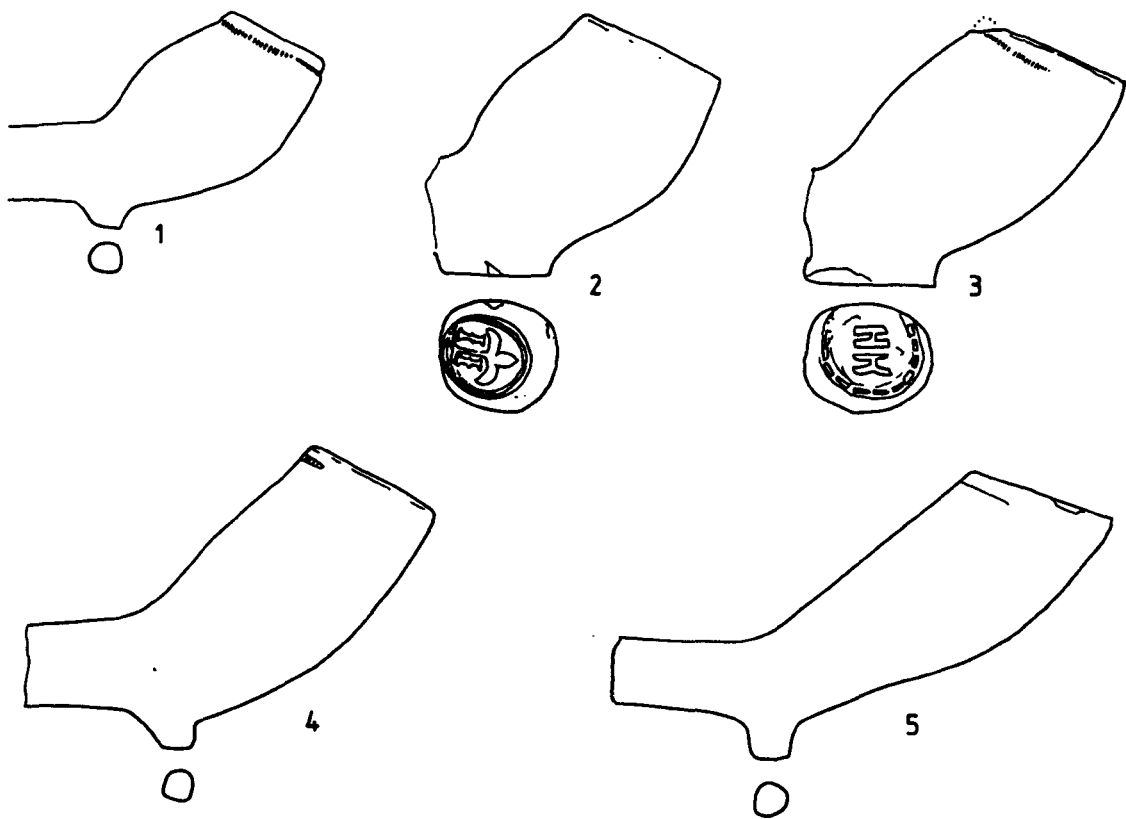
**Figure 62:** Pipes held by English Heritage at their archaeological store in Helmsley. Scale 1:1.



**Figure 63:** Pipes held by English Heritage at their archaeological store in Helmsley. Scale 1:1.



**Figure 64:** Pipes held by English Heritage at their archaeological store in Helmsley. Scale 1:1.



**Figure 65:** Pipes held by English Heritage at their archaeological store in Helmsley. Scale 1:1.

**Collection Name:** Ryedale Folk Museum  
**Collection Code:** 0233  
**Contact Name:** Mr Martin Watts  
**Address:** Hutton le Hole, North Yorkshire

**Description:**

Collection recorded 22<sup>nd</sup> March 2001. The collection consists of approximately 50 pipes in the museum's Social History collections. A total of just 8 pipes dating from the seventeenth or eighteenth century were recorded in detail for the Yorkshire database. The rest of the collection was very varied and included a South African stone pipe, a German porcelain bowl with stag transfer and metal cap, a cherry wood 'block' pipe and stem, elaborate wooden mans head/beard, Pollock pipes, a complete coloured 'Ally Sloper' pipe, a 'Merry Christmas' cadger with its tip missing and a little mid nineteenth-century pipe tied in a know and covered in yellowish brown glaze. Other pipes of note are as follows:

From the Social History Collection

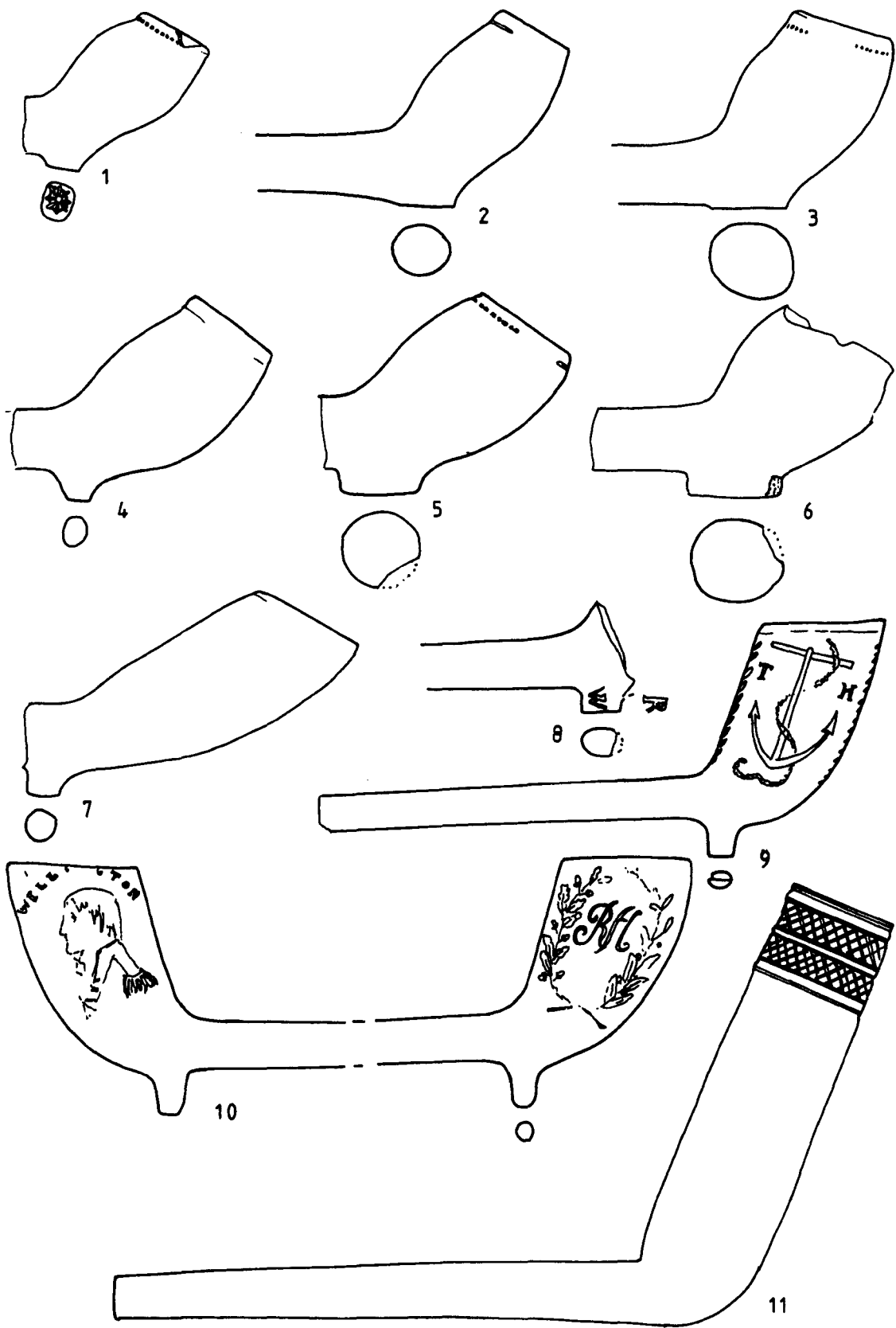
- A1427 – Complete straw with red tip; horses hoof spur and wiped rim; marked C CROP/LONDON incuse moulded in sans serif within a beaded border; stem 132mm.
- C6646 & C6639 – two examples of a spurless cutty pipe with boxers on, both unprovenanced. The lettering C HEENAN/ TOM SAYERS is moulded above the figures on both bowls.
- 81/11 – Bowl with George and the dragon on the left-hand side and Britannia on the right-hand side, c1840-1860, with alternating oak leaves and acorns along the seams. Double ring mark on the spur. Very similar example in Pickering Museum but not so finely engraved.
- C6652 – Spur bowl of c1820-1850 with bust on left-hand side with ?WELLINGTON above; leaf and acorn wreath on right-hand side surrounding the initials RA.
- C6638 – Bowl of c1820-1850 with anchor motif on both sides; simple leaf decoration on all seams and the relief-moulded initials TH flanking the anchor.
- 80/26 – Small Turks head socketed bowl with DUMERIL/LEURS moulded in relief with serifs on right-hand side of the stem; mould No. on left-hand side damaged at both ends but middle certainly '.02.' could be 1025 or 202. Head has a pronounced 'spike' or projection at the front of the turban, which is distinctive.
- C6611 – Stone pipe, possibly soapstone, from South Africa; two bands of hatched decoration at the rim; stem complete but heel missing.

From the Archaeology Collection

- Box No. 145 Possibly Raymond Hayes' Collection containing 12 decorated nineteenth-century bowls including one bearing an American eagle on both sides of the bowl, one with Masonic motifs, one with fluted bowl with a thistle and shamrocks on one side and a rose and shamrocks on the other, one with leaf vein decoration; four seventeenth-century bowls and miscellaneous stems; one eighteenth-century heel with moulded initials RW

- 66.01 Heel type bowl dating from c1610-1640 from around Skelton (Acc No. 81/3); rim bottered and fully milled; stem bore 7/64". Marked with a wheel on the heel. (Pcode 21155).
- 66.02 Heel type bowl dating from c1640-1660 unprovenanced material in Ryedale Museum (Acc No. C5790); rim bottered but not milled; stem bore 7/64". (Pcode 21156).
- 66.03 Heel type bowl dating from c1640-1670 from around Skelton (Acc No. 82/26); rim bottered and fully milled; stem bore 7/64". (Pcode 21154).
- 66.04 Spur type bowl bowl dating from c1660-1680 unprovenanced material in Ryedale Museum (Acc No. Box 149); rim bottered but not milled; stem bore 7/64". Broken in two. (Pcode 21160).
- 66.05 Heel type bowl dating from c1660-1680 unprovenanced material in Ryedale Museum (Acc No. Box 149); rim bottered and half milled; stem bore 6/64". (Pcode 21159).
- 66.06 Heel type bowl dating from c1660-1680 unprovenanced material in Ryedale Museum (Acc No. C5791); stem bore 7/64". Bulbous form but without a rim. (Pcode 21157).
- 66.07 Heel type bowl dating from c1690-1720 unprovenanced material in Ryedale Museum (Acc No. Box 149); rim bottered but not milled; stem bore 6/64". Pcode 21158).
- 66.08 Heel fragment dating from c1760-1800 unprovenanced material in Ryedale Museum (Acc No. Box 149); 5/64". Marked with the initials RW on the sides of the heel. (Pcode 21161).
- 66.09 Spur type bowl bowl dating from c1820-1850 unprovenanced material in Ryedale Museum (Acc No. C6638); Ship and anchor motif on both sides; leaf decorated seams and initials TH in relief moulded serif, flanking the anchor.
- 66.10 Spur type bowl bowl dating from c1820-1850 unprovenanced material in Ryedale Museum (Acc No. C6652); Bust of ?Wellington on left hand side with a leaf and acorn wreath on the right hand side surrounding the initials RH.
- 66.11 South African serpentine pipe bowl dating from the nineteenth century; unprovenanced material in Ryedale Museum (Acc No. C6611).





**Figure 66:** Pipes in the collection of the Ryedale Folk Museum, Hutton-le-Hole. Scale 1:1.

**Collection Name:** Manor House Museum

**Collection Code:** 0141

**Contact Name:** Mr Gavin Edwards

**Address:** Ilkley, North Yorkshire

**Description:**

Collection recorded on 4<sup>th</sup> April 2000. The collection consists of a number of seventeenth to nineteenth-century pipes. Approximately 50 seventeenth- or eighteenth-century bowls and marked fragments were recorded in detail for the Yorkshire Database the majority of which were found locally. The collection also had a small number of nineteenth-century pipes the most notable of which are as follows:

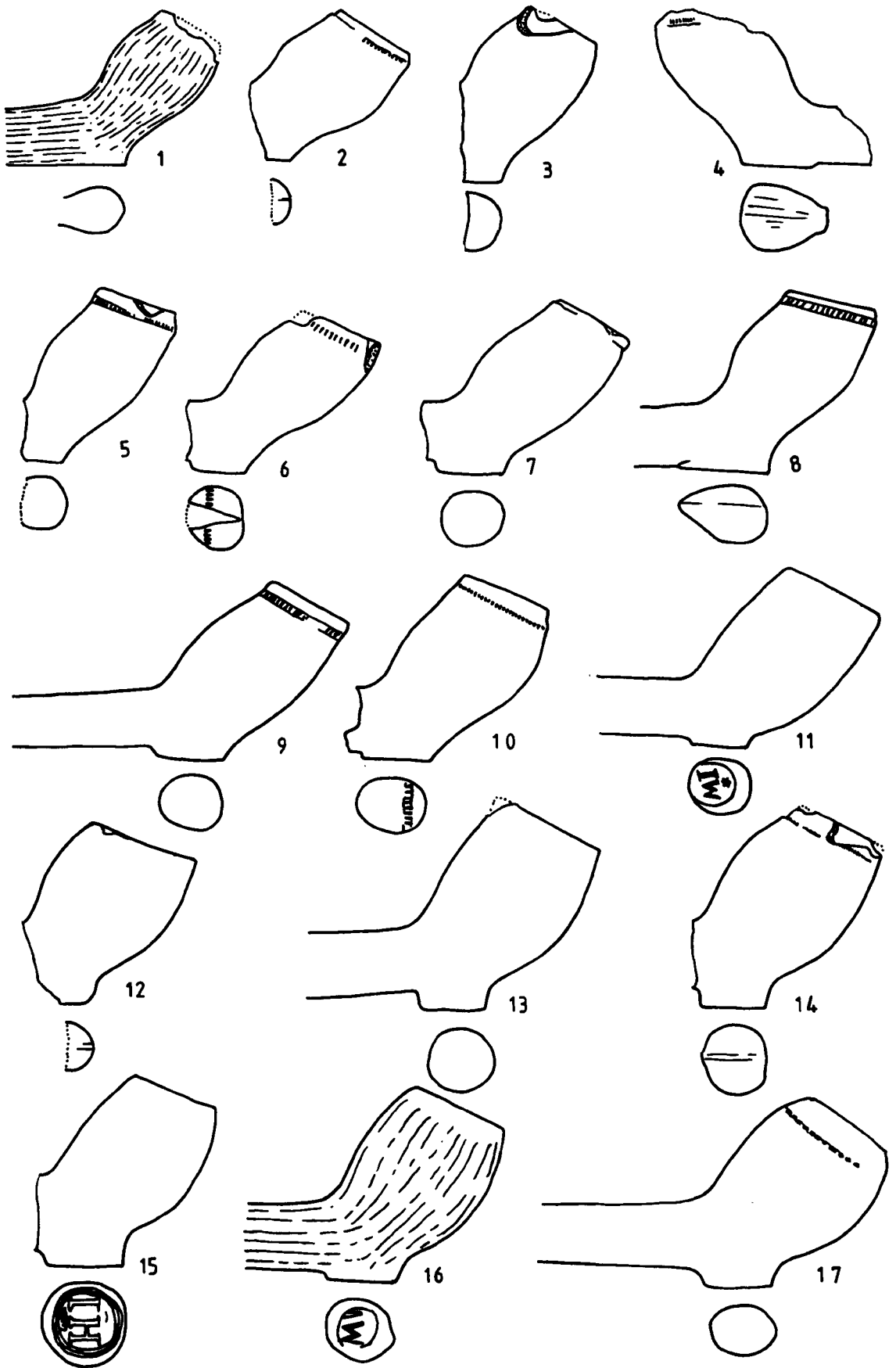
- A153.82 – part of a pipe bowl in the form of an elephant with a pannier on its back; very elaborately executed.
- 99392 – near complete bowl with leaf-decorated seams and with the lettering EC KEIGHLEY along both sides of the stem.
- A62.59 – large bowl with leaf-decorated seams with the lettering EC KEIGHLEY along both sides of the stem, very similar to the above.
- A52.65(3) – late nineteenth-century bowl with faint purplish rubber stamp on the bowl reading COMPLIMENTS OF THE SEASON
- A11.68.18 - Large burnished bowl with heel stamped with the crowned initials ES. Across the stem is stamped the lettering GOEDEWAAGEN/GOUDA
- A153.82 – Grey hound head in white pipe clay with a tapering hole of approximately 6mm diameter and 18mm deep.
- A11.68.5 – Large Irish style bowl with moulded milling stamped McLARDY'S DUBLIN facing the smoker.

- 67.01 Heel type bowl dating from c1600-1610 (Acc No. A24.59); good burnish; rim bottered but not milled; stem bore 8/64". (Pcode 07043).
- 67.02 Heel type bowl dating from c1640-1660 from Bolton Church (Acc No. A80.61); rim bottered and fully milled. Bowl marked "Bolton BFD". (Pcode 07046).
- 67.03 Heel type bowl dating from c1620-1640 from Round Hill, Blubberhouses Moor (Acc No. A5.54.2); rim bottered; milled on all surviving rim; stem bore 7/64". (Pcode 07048).
- 67.04 Heel type bowl dating from c1640-1660, unprovenanced material but probably from Ilkley (Acc No. A217.82); rim bottered; milled on all surviving rim; stem bore 7/64". Heart shaped heel. (Pcode 07053).
- 67.05 Heel type bowl dating from c1640-1660 (Acc No. A24.59); rim bottered and fully milled; stem bore 7/64". (Pcode 07044).
- 67.06 Heel type bowl dating from c1640-1660 from Round Hill, Blubberhouses Moor (Acc No. A5.54); rim bottered and fully milled. Milled heel. (Pcode 07047).

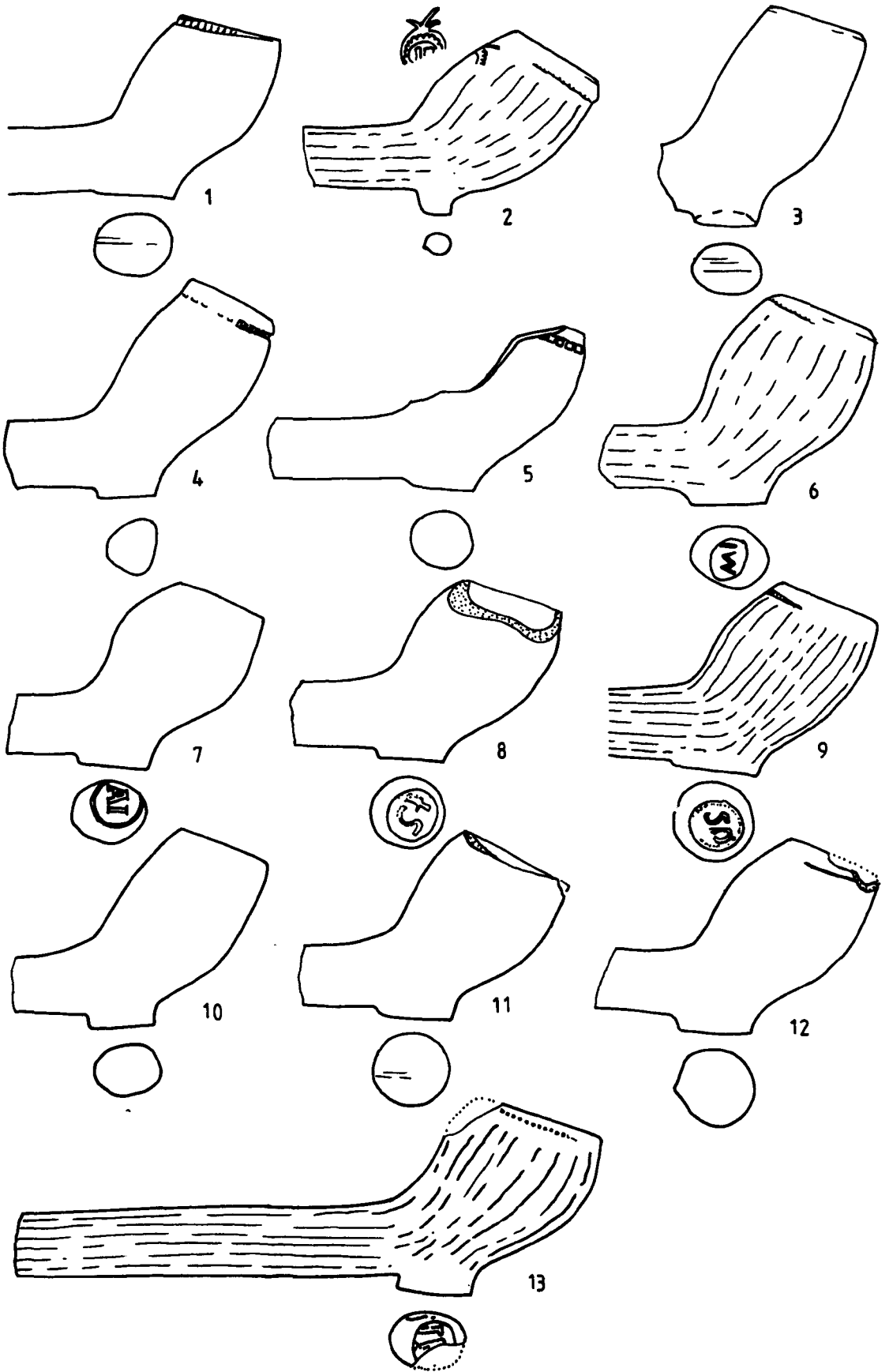
- 67.07 Heel type bowl dating from c1640-1660 from Round Hill, Blubberhouses Moor (Acc No. A5.54.3); rim bottered but not milled; stem bore 7/64". (Pcode 07049).
- 67.08 Heel type bowl dating from c1640-1660 from Blubberhouses Moor (Acc No. A9.81.2); rim bottered and fully milled; stem bore 7/64". (Pcode 07036).
- 67.09 Heel type bowl dating from c1640-1660, unprovenanced material but probably from Ilkley (Acc No. J.E.P.); rim bottered and fully milled; stem bore 8/64". No burnish lines but smooth, shiny surface. (Pcode 07055).
- 67.10 Heel type bowl dating from c1640-1660 from Blubberhouses Moor (Acc No. A9.81.4); rim bottered and fully milled; stem bore 8/64". Milled heel. (Pcode 07038).
- 67.11 Heel type bowl dating from c1660-1680, unprovenanced material but probably from Ilkley (Acc No. A11.84); rim bottered but not milled; stem bore 6/64". Marked with the initials IW on the heel. Local clay, very sandy, abrasive feel. (Pcode 07051).
- 67.12 Heel type bowl dating from c1660-1680, unprovenanced material but probably from Ilkley (Acc No. A217.82); rim bottered but not milled; stem bore 6/64". Local clay, very sandy, abrasive feel. (Pcode 07052).
- 67.13 Heel type bowl dating from c1660-1680 from Blubberhouses Moor (Acc No. A11.81.7); rim bottered but not milled; stem bore 6/64". (Pcode 07012).
- 67.14 Heel type bowl dating from c1660-1680 from Station Road (Acc No. A6.81); rim internally trimmed, bottered and fully milled; stem bore 8/64". Pipe marked "garden in Station Road, Baildon 1962". (Pcode 07050).
- 67.15 Heel type bowl dating from c1650-1670 from Blubberhouses Moor (Acc No. A11.81.4); rim bottered but not milled; stem bore 7/64". Marked with the initials IH on the heel. Rim slightly distorted, possible waster. (Pcode 07009).
- 67.16 Heel type bowl dating from c1650-1670 from Blubberhouses Moor (Acc No. A11.81.9); poorly burnished; rim bottered but not milled; stem bore 6/64". Marked with the initials IW on the heel. Joins 3 stem fragments from A15.81. (Pcode 07013).
- 67.17 Heel type bowl dating from c1660-1690 from The Old Smithy (Acc No. A17.83); rim bottered and three quarters milled; stem bore 6/64". Local clay, very sandy, abrasive feel. (Pcode 07040).
- 68.01 Heel type bowl dating from c1660-1680 from Blubberhouses Moor (Acc No. A11.81.5); rim bottered and three quarters milled; stem bore 6/64". (Pcode 07010).

- 68.02 Spur type bowl dating from c1660-1680 from Blubberhouses Moor (Acc No. A9.81.1); poorly burnished; rim bottered and fully milled; stem bore 7/64". Marked with the initials IB on the bowl facing the smoker. Rainford form. (Pcode 07039).
- 68.03 Heel type bowl dating from c1660-1680 from Blubberhouses Moor (Acc No. A12.81.1); rim bottered but not milled; stem bore 5/64". Two joining fragments. (Pcode 07014).
- 68.04 Heel type bowl dating from c1660-1680 from High Bradley (Acc No. A50.65); rim bottered and half milled; stem bore 8/64". (Pcode 07042).
- 68.05 Heel type bowl dating from c1660-1680 from Blubberhouses Moor (Acc No. A11.81.12); rim bottered; milled on all surviving rim; stem bore 7/64". (Pcode 07003).
- 68.06 Heel type bowl dating from c1660-1680 from Blubberhouses Moor (Acc No. A11.81.11); rim bottered and half milled; stem bore 7/64". Marked with the initials IW on the heel. Abraded surface but appears to have been burnished. (Pcode 07002).
- 68.07 Heel type bowl dating from c1660-1680 from Blubberhouses Moor (Acc No. A11.81.14); rim bottered but not milled; stem bore 7/64". Marked with the initials AI on the heel. Two joining fragments A11.81.14 and A13.81. (Pcode 07005).
- 68.08 Heel type bowl dating from c1660-1680 from Blubberhouses Moor (Acc No. A7.81.2); poorly burnished; rim bottered; milled on all surviving rim; stem bore 7/64". Marked with the initials IS on the heel. (Pcode 07029).
- 68.09 Heel type bowl dating from c1660-1680 from Blubberhouses Moor (Acc No. A7.81.1); poorly burnished; rim bottered and half milled; stem bore 7/64". Marked with the initials S?P/D/B on the heel. Joins stem from A13.81. (Pcode 07028).
- 68.10 Heel type bowl dating from c1660-1680 from Blubberhouses Moor (Acc No. A11.81.1); rim bottered but not milled; stem bore 6/64". (Pcode 07000).
- 68.11 Heel type bowl dating from c1660-1680 from Blubberhouses Moor (Acc No. A11.81.10); rim internally trimmed and bottered but not milled; stem bore 6/64". (Pcode 07001).
- 68.12 Heel type bowl dating from c1660-1680 from Blubberhouses Moor (Acc No. A11.81.6); rim bottered and one quarter milled; stem bore 6/64". (Pcode 07011).
- 68.13 Heel type bowl dating from c1660-1670 from Blubberhouses Moor (Acc No. A11.81.3); poorly burnished; rim bottered and fully milled; stem bore 6/64". Marked with the initials I?W on the heel. Joins bowl fragment from A13.81 and stem from A15.81. (Pcode 07008).

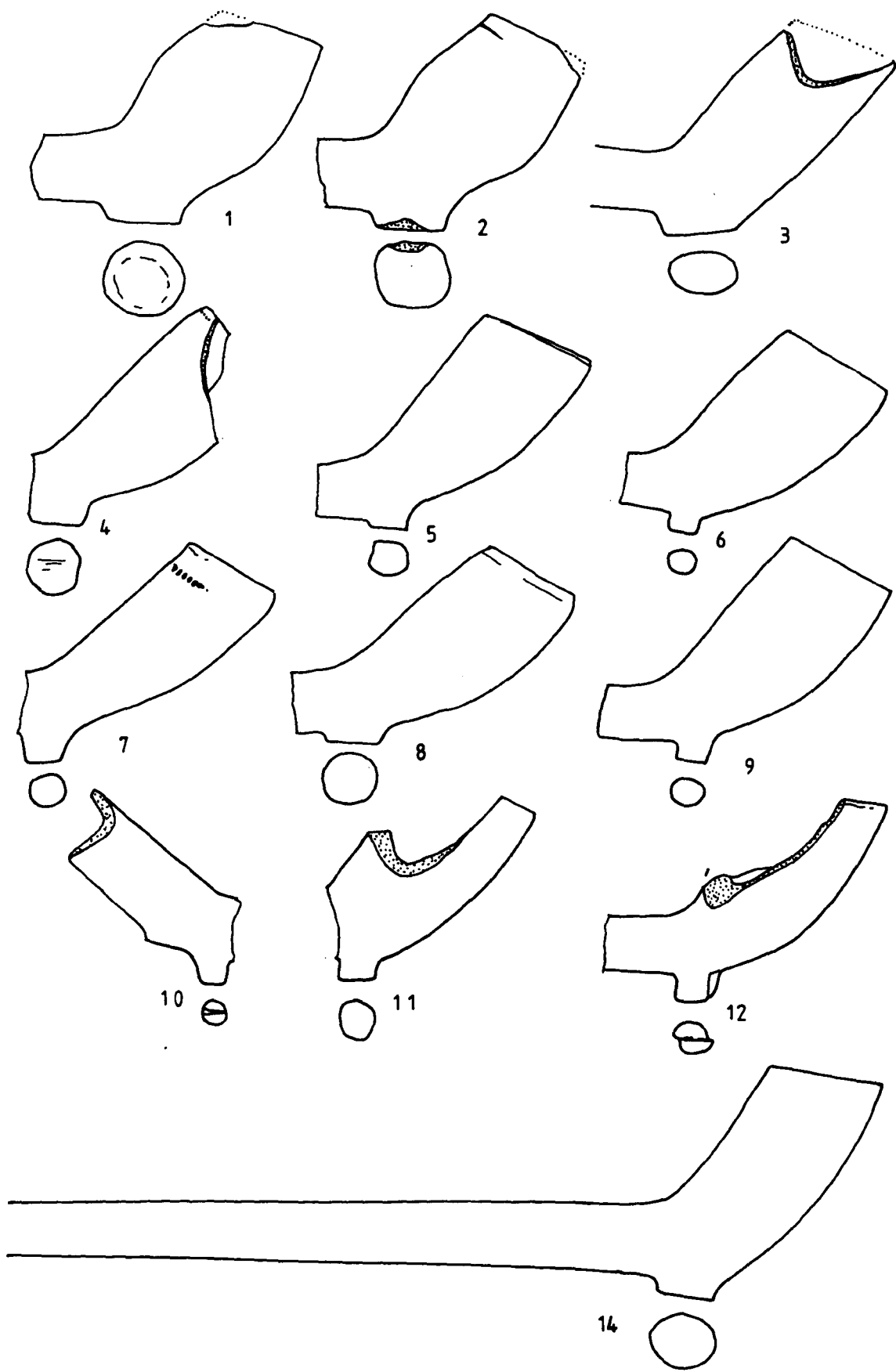
- 69.01 Heel type bowl dating from c1660-1690 from Blubberhouses Moor (Acc No. A11.81.13); rim bottered but not milled; stem bore 7/64". Abraded heel mark; possibly local clay. (Pcode 07004).
- 69.02 Heel type bowl dating from c1660-1680 from Blubberhouses Moor (Acc No. A11.81.2); rim bottered and half milled; stem bore 7/64". (Pcode 07007).
- 69.03 Heel type bowl dating from c1690-1710 from Bouldon Moor (Acc No. A161.82); stem bore 7/64". Water worn. (Pcode 07041).
- 69.04 Heel type bowl dating from c1690-1720(Acc No. A25.59); rim bottered; milled on all surviving rim; stem bore 6/64". (Pcode 07045).
- 69.05 Heel type bowl dating from c1680-1710 from Blubberhouses Moor (Acc No. A8.81.6); rim bottered but not milled; stem bore 5/64". Local clay, very sandy, abrasive feel. (Pcode 07034).
- 69.06 Spur type bowl dating from c1680-1710 from Blubberhouses Moor (Acc No. A8.81.6); rim internally trimmed and bottered but not milled; stem bore 5/64". Local clay, very sandy, abrasive feel. (Pcode 07035).
- 69.07 Heel type bowl dating from c1690-1710 from Blubberhouses Moor (Acc No. A8.81.2); rim bottered and half milled; stem bore 5/64". (Pcode 07030).
- 69.08 Heel type bowl dating from c1690-1710 from Blubberhouses Moor (Acc No. A8.81.5); rim bottered but not milled; stem bore 7/64". (Pcode 07033).
- 69.09 Spur type bowl dating from c1690-1720 from Blubberhouses Moor (Acc No. A8.81.3); rim wiped but not milled; stem bore 5/64". (Pcode 07031).
- 69.10 Spur type bowl dating from c1690-1710 from Blubberhouses Moor (Acc No. A14.81.10); stem bore 5/64". (Pcode 07026).
- 69.11 Heel type bowl dating from c1680-1710 from Blubberhouses Moor (Acc No. A10.81.4); rim bottered but not milled; stem bore 5/64". Local clay, very sandy, abrasive feel. (Pcode 06999).
- 69.12 Spur type bowl dating from c1690-1720 from Blubberhouses Moor (Acc No. A14.81.3); rim internally trimmed and bottered but not milled; stem bore 5/64". (Pcode 07027).
- 69.13 Heel type bowl dating from c1700-1770, unprovenanced material but probably from Ilkley (Acc No. J.E.P.); rim cut but not milled; stem bore 7/64". (Pcode 07056).



**Figure 67:** Pipes in the collection of the Manor House Museum, Ilkley. Scale 1:1.



**Figure 68:** Pipes in the collection of the Manor House Museum, Ilkley. Scale 1:1.



**Figure 69:** Pipes in the collection of the Manor House Museum, Ilkley. Scale 1:1.



**Collection Name:** Beck Isle Museum of Rural Life  
**Collection Code:** 0232  
**Contact Name:** Mr Gordon Clitheroe  
**Address:** Pickering, North Yorkshire  
**Description:**

Collection recorded on the 22<sup>nd</sup> March 2001. The collection had a dozen seventeenth-century and early eighteenth-century pipes including one with the moulded initials RC on the sides of the spur. This particular example can be attributed to Robert Chapman of Hull.

A number of the pipes were on display in glass-fronted cabinets but the curator was happy to take these items off display for recording. The collection included the following:

- Complete C. Crop, London pipe with varnished surface – meerschaum wash type with darker brown patches. It had a registration mark on both sides of the stem. Lettering C. CROP LONDON on the left-hand side and EXHIBITION 1862 on the right-hand side of the stem in serif letters.
- Near complete Cadger exhibition pipe with no varnish and no makers name.

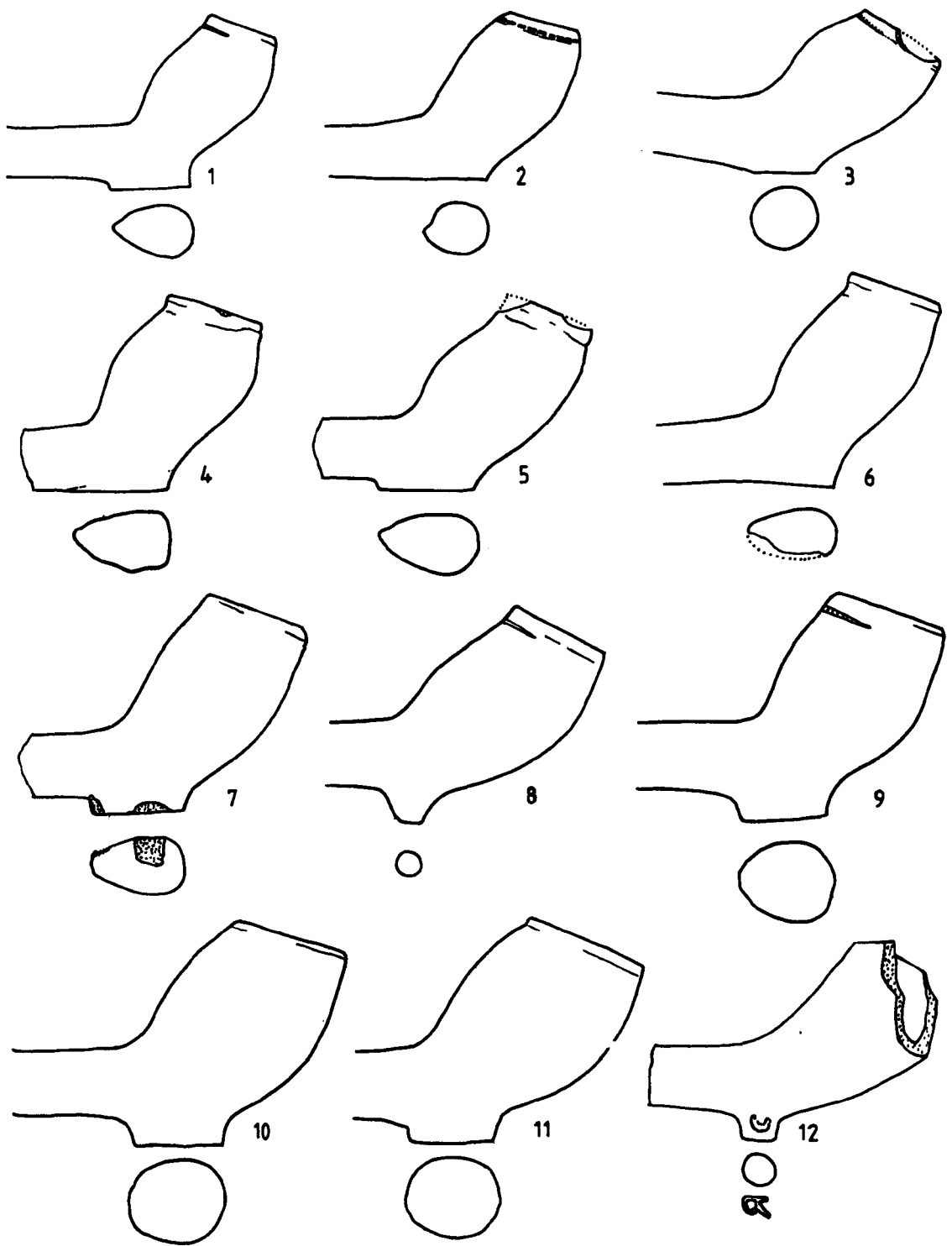
There was a large collection (approx 60-70) nineteenth-century decorated bowls all usual late nineteenth-century forms such as figurals, footballers and RAOB etc. The notable pieces include:

- PIKRL 4237 - An elaborate Masonic, seems to have WR initials; rather elongated spur
- PIKRL 4237 – Stem fragment with moulded mark T.PENN.LEEDS sans-serif lettering on one side only.
- PIKRL 4222 – Black socketed bowl, made in a 3-piece mould, crossed bones under; probably French; no mark; complete with cork mount and cane stem.
- PIKRL 4215 – Meerschaum wash THE TROOPER sans-serif lettering on both sides; stem broken but worn for reuse; moulded milling round the rim.
- PIKRL 4237 – Thorn bowl with moulded milling, small bearded head (?sailor) in place of the spur.
- PIKRL 4237 – Bowl with a rose, 3 castles and a level on the left-hand side and Masonic emblems on the right-hand side; small IB moulded on heel/spur.
- PIKRL 4237 – Masonic decorated bowl with a crude heart in hand design on the left-hand side under swags with the initials HI
- PIKRL 1989.83.3 – Paddle steamer on left-hand side with steam train on right-hand side, with blurred lettering visible on left-hand side of the stem only; very narrow, upright letters, as seen on German pipes.
- PIKRL 1989.83.3 – Flutes and swags bowl with what appears to be the initials FS on either side of the bowl.
- PIKRL 1989.83.3 – TW incuse moulded mark on bowl; hatched heart on right-hand side; plain seams; spur missing; incuse moulded sans serif mark J.W.R.W./LEEDS on stem.

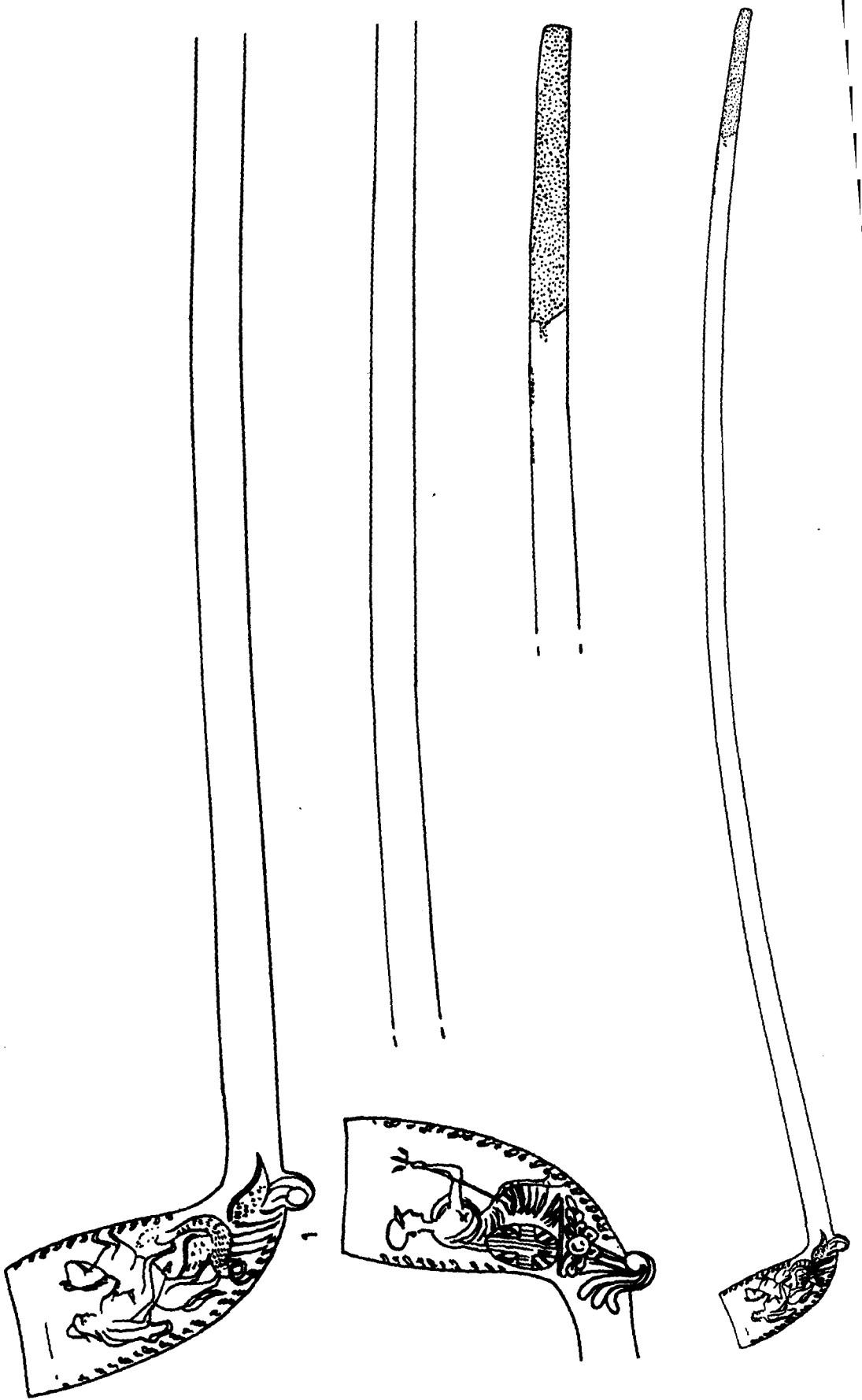
- PIKRL 8228 – For Auld Lang Syne pipe; broad leaf seams; incuse moulded NO. 48 on left-hand side of the stem.
- PIKRL 8228 – Hatched loops, dots and collar with incuse moulded lettering 157 with serifs on left-hand side of stem.
- PIKRL 8228 – Stem with wood grain effect, ending at plain collar then 179 in incuse moulded serif lettering on left-hand side.
- PIKRL 8228 – Cutty stem with incuse moulded sans serif lettering 17<sup>TH</sup> LANCERS on both sides of the stem, no border.
- PIKRL 8228 – Stem with incuse moulded sans serif lettering W GUEST/BARNSELY on stem, no border; cutty stem, opening to flattened mouthpiece.

- 70.01 Heel type bowl dating from c1610-1640, unprovenanced material in the Beck Isle Museum (Acc No. PIKRL); rim bottered and half milled; stem bore 6/64". (Pcode 21143).
- 70.02 Heel type bowl dating from c1620-1640, unprovenanced material in the Beck Isle Museum (Acc No. PIKRL 2414); rim bottered and fully milled; stem bore 8/64". (Pcode 21144).
- 70.03 Heel type bowl dating from c1630-1650, unprovenanced material in the Beck Isle Museum (Acc No. PIKRL); rim bottered and half milled; stem bore 7/64". (Pcode 21146).
- 70.04 Heel type bowl dating from c1640-1660, unprovenanced material in the Beck Isle Museum (Acc No. PIKRL 4237); rim bottered but not milled; stem bore 8/64". Very crudely made; heart shaped heel. (Pcode 21142).
- 70.05 Heel type bowl dating from c1640-1660, unprovenanced material in the Beck Isle Museum (Acc No. PIKRL 3877); rim bottered; milled on all surviving rim; stem bore 7/64". (Pcode 21148).
- 70.06 Heel type bowl dating from c1640-1660, unprovenanced material in the Beck Isle Museum (Acc No. PIKRL 2414); rim bottered but not milled; stem bore 6/64". (Pcode 21147).
- 70.07 Heel type bowl dating from c1640-1660, unprovenanced material in the Beck Isle Museum (Acc No. PIKRL 4237); rim bottered but not milled; stem bore 7/64". Heart shaped heel. (Pcode 21141).
- 70.08 Spur type bowl dating from c1660-1680, unprovenanced material in the Beck Isle Museum (Acc No. PIKRL 2414); rim internally trimmed and bottered but not milled; stem bore 8/64". (Pcode 21149).
- 70.09 Heel type bowl dating from c1660-1680, unprovenanced material in the Beck Isle Museum (Acc No. PIKRL 2414); rim bottered and half milled; stem bore 8/64". Shiny surface but no obvious burnishing lines. (Pcode 21150).

- 70.10 Heel type bowl dating from c1660-1690, unprovenanced material in the Beck Isle Museum (Acc No. PIKRL 2414); rim bottered but not milled; stem bore 8/64". Very "grubby" can not see if it is burnished. (Pcode 21151).
- 70.11 Heel type bowl dating from c1660-1690, unprovenanced material in the Beck Isle Museum (Acc No. PIKRL 2414); rim bottered but not milled; stem bore 6/64". Very "grubby" can not see if it is burnished. (Pcode 21152).
- 70.12 Spur type bowl dating from c1690-1720, unprovenanced material in the Beck Isle Museum (Acc No. PIKRL); stem bore 5/64". Marked with the initials RC on the sides of the heel. The initial R has been reversed; possibly Robert Chapman of Hull. (Pcode 21153).
- 71.01 Complete spur type bowl dating from c1820-1860, unprovenanced material in the Beck Isle Museum (ACC No. PIKRL 4237); mould decorated bowl with St George and the dragon and the smokers left and Britannia on the smokers right; acorns and oak leaves along both seams; yellow/brown glaze at tip. Reduced pipe to show curve of stem.



**Figure 70:** Pipes in the collection of the Beck Isle Museum of Rural Life, Pickering. Scale 1:1.



**Figure 71:** Complete pipe in the collection of the Beck Isle Museum of Rural Life, Pickering. Scale 1:1.

**Collection Name:** Richmondshire Museum  
**Collection Code:** 0136  
**Contact Name:** Fiona Lake  
**Address:** Richmond, North Yorkshire

**Description:**

Collection recorded 3<sup>rd</sup> May 1985. The collection included a approximately 27 pipes dating from the seventeenth or eighteenth century along with a large number of nineteenth-century pipes. The most notable of the later material is as follows:

- 195a – complete RAOB bowl with the letters RAOB on both sides of the bowl. Traces of a Christian name initial W survives on the spur.
- 2591 – TW bowl with a hatched heart on the right-hand side and a hatched hand on the left-hand side.
- 1357 – mould decorated bowl with a drum and flags design on both dies.
- 1357 – TW bowl with a hatched heart on the right-hand side only.
- 1357 – two stems one with the lettering DUBLIN in a relief beaded border on both sides of the stem; the other with the lettering TENNANT in a dotted border on one side of the stem and BERWICK, also in a border on the other side.
- 195a – Fine bowl modelled as a bulls head, part of the incuse moulded mould number survives on the left-hand side of the stem reading ?10./; almost certainly French.
- 311/4 – For Auld Land Syne pipe with a star with a dot at the centre on the spur.
- 319 – Thick bowl with a coiled rope design.
- Bowl with a spur in the form of a dog's head.
- 967 – Spurless bowl with T C DENHAM/RICHMOND stamped on the bowl facing the smoker; the mould number 140 appears on both sides of the stem in a relief-beaded border.

72.01 Heel type bowl dating from c1580-1610 (Acc No. 58). Poorly burnished; rim bottered but not milled.

72.02 Heel type bowl dating from c1620-1640 (Acc No. 58). Rim bottered but not milled; heel trimmed.

72.03 Heel type bowl dating from c1640-1660 (Acc No. 58). Rim bottered but not milled.

72.04 Heel type bowl dating from c1640-1660 (Acc No. 58). Rim bottered but not milled; heel trimmed. one of two examples.

72.05 Heel type bowl dating from c1640-1660 (Acc No. 58). Rim bottered but not milled; heel trimmed.

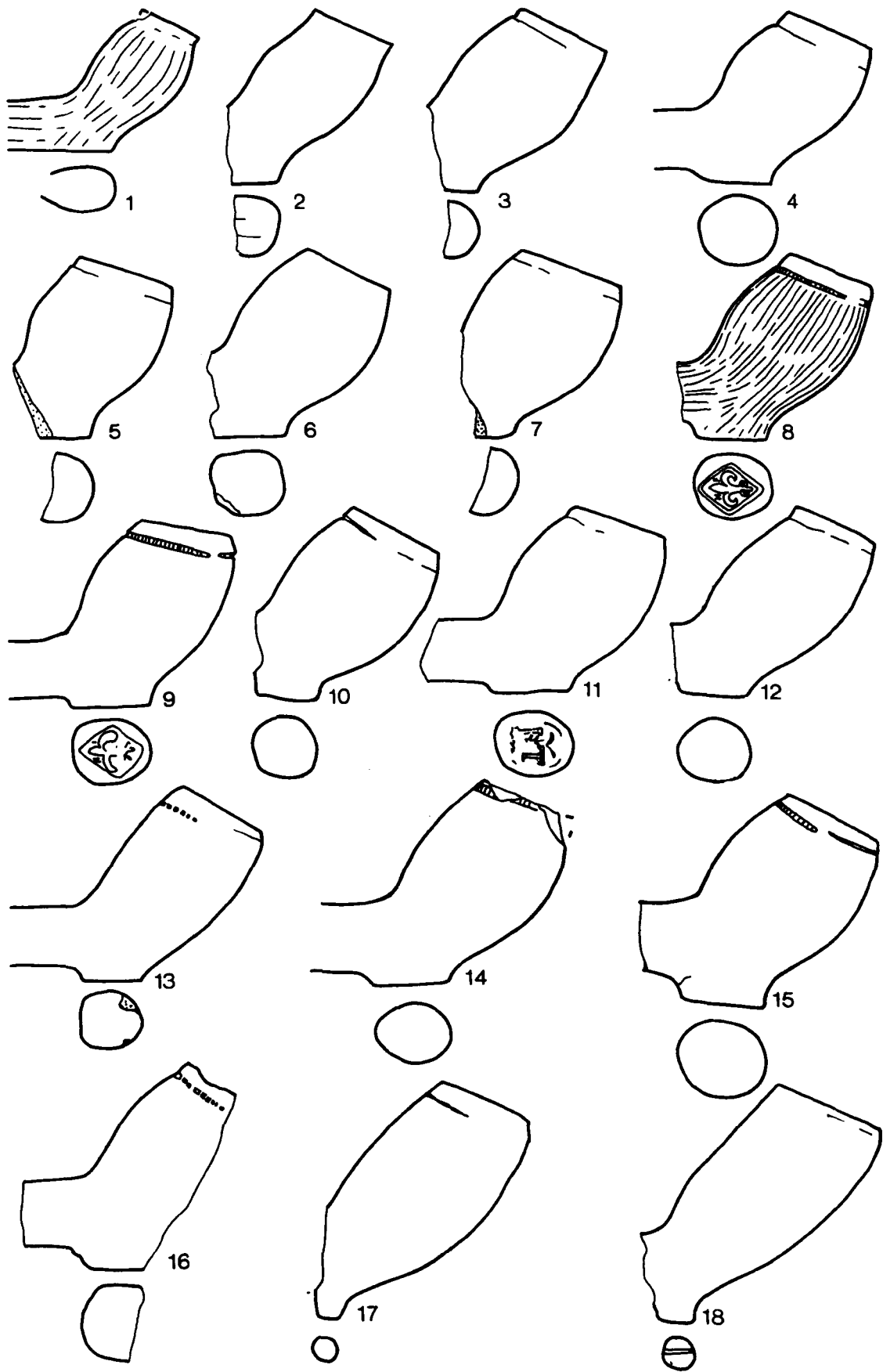
72.06 Heel type bowl dating from c1640-1660 (Acc No. 58). Rim bottered but not milled; heel trimmed.

72.07 Heel type bowl dating from c1650-1670 (Acc No. 58). Rim bottered but not milled; heel trimmed.

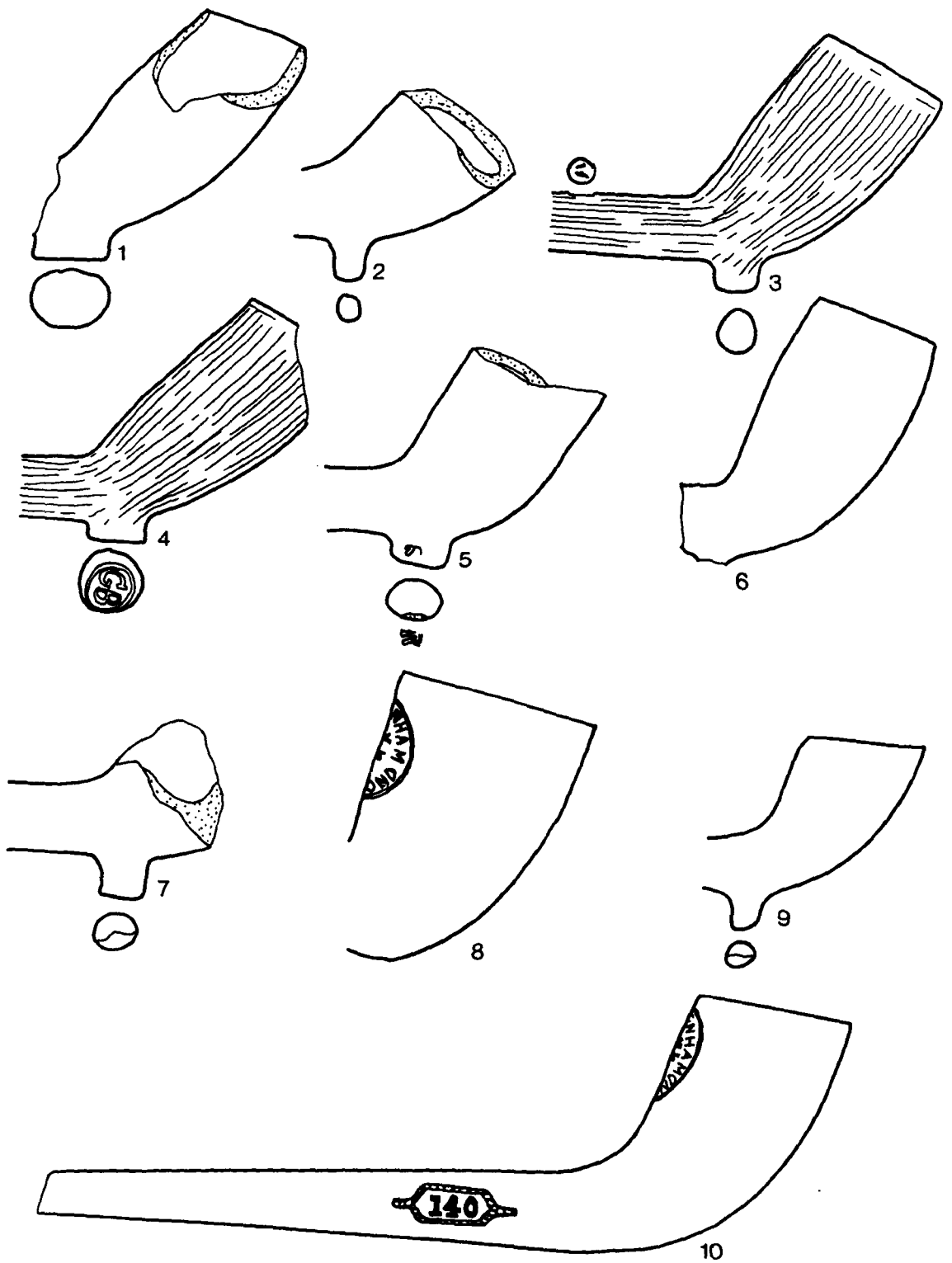
- 72.08 Heel type bowl dating from c1650-1670 (Acc No. 58). Average burnish; rim bottered and fully milled; heel stamped with the initials HF either side of a fleur-de-lys motif.
- 72.09 Heel type bowl dating from c1650-1670 (Acc No. 58). Rim bottered and three quarters milled; heel stamped with the initials HF either side of a fleur-de-lys motif.
- 72.10 Heel type bowl dating from c1650-1670 (Acc No. 58). Rim bottered but not milled; heel trimmed.
- 72.11 Heel type bowl dating from c1660-1680 (Acc No. 58). Rim bottered but not milled; heel stamped with the initials IT.
- 72.12 Heel type bowl dating from c1660-1680 (Acc No. 311/1). Rim bottered but not milled; heel trimmed.
- 72.13 Heel type bowl dating from c1660-1680 (from one of the museum's display cases). Rim bottered and half milled; heel trimmed.
- 72.14 Heel type bowl dating from c1660-1690 (Acc No. 58). Not burnished; bottered and milled around all of the surviving rim; heel trimmed.
- 72.15 Heel type bowl dating from c1660-1690. Rim bottered and three quarters milled; heel trimmed.
- 72.16 Heel type bowl dating from c1660-1690. Not burnished; bottered and milled on all surviving rim; heel trimmed.
- 72.17 Spur type bowl dating from c1660-1680. Rim bottered and three quarters milled.
- 72.18 Heel type bowl dating from c1690-1710 (No Acc No., in a bag marked "found in various places in Richmond"). Rim bottered and internally trimmed.
- 73.01 Heel type bowl dating from c1690-1710 (Acc No. 2591). Not burnished; surviving rim bottered but not milled; heel flares slightly.
- 73.02 Spur type bowl dating from c1690-1710. Not burnished; no rim surviving.
- 73.03 Heel type bowl dating from c1690-1710 (No Acc No., in a bag marked "found in various places in Richmond"). Good burnish; rim bottered but not milled; heel trimmed; stem stamped with a small circular mark approximately 17mm from the bowl.
- 73.04 Heel type bowl dating from c1690-1710 (Acc No. 1357). Good burnish; surviving rim bottered but not milled; heel stamped with the initials GB.

- 73.05 Heel type bowl dating from c1680-1710 (Acc No. 187). No rim surviving; moulded initials RR on either side of the heel.
- 73.06 Spur type bowl dating from c1690-1710 (Acc No. 58). Rim cut but not milled; spur broken off.
- 73.07 Heel type bowl dating from the 18<sup>th</sup> century (Acc No. 311/3). No rim surviving.





**Figure 72:** Pipes in the collection of Richmondshire Museum, Richmond. Scale 1:1.



**Figure 73:** Pipes in the collection of Richmondshire Museum, Richmond. Scale 1:1.

**Collection Name:** Scarborough Borough Council

**Collection Code:** 0132

**Contact Name:** Dr Jane Mee

**Address:** Scarborough, North Yorkshire

**Description:**

Collection recorded during two visits, the first 4<sup>th</sup> June 1998, the second 8<sup>th</sup> June 1999. The collection comprises a large quantity of pipes from excavations in and around Scarborough. The pipe fragments range in date from the seventeenth through to the late nineteenth century. A total of 147 bowls and marked stems from the seventeenth and eighteenth century were recorded in detail for inclusion in the Yorkshire database. The collection included a large number of Dutch pipes including a very highly decorated baroque bowl with Tudor roses and grapes.

Of the later material the following was noted:

- PDS D1 100 – Bowl dating from c1770-1820 with very faintly engraved royal arms on the bowl facing the smoker; no supporters. Crowned initials TN moulded on the sides of the spur.
- 56.71 – Complete clay pipe with a curved stem measuring 42cm and brown/yellow glazed tip. Plain ribs half way up the bowl along the seams.
- Mould decorated bowl with a shield containing three castles (?arms of Newcastle) with seahorse supporters and the lettering N'CASTLE PIPE CO in relief below. The initials EW are moulded on the sides of the spur.
- PDS E3 101 – Modified pipe stem dating from c1700-1770, with two holes cut to the bore, possibly to produce a whistle.

74.01 Spur type bowl dating from c1610-1640 from 18-22 Sepulchre Street (Acc No. SS87 107); poorly burnished; rim bottered; milled around all of the surviving rim; bore 6/64". (Pcode 05941).

74.02 Heel type bowl dating from c1640-1670 from 119 Longwestgate (Acc No. LW90 1000); rim bottered but not milled; bore 8/64". Marked with a crowned Tudor Rose on the heel; mould decorated, baroque style; Dutch. (Pcode 02056).

74.03 Heel type bowl dating from c1660-1690 from 35 Castlegate (Acc No. CG91 102); rim bottered and half milled. Marked with the initials RF on the heel. (Pcode 02053).

74.04 Heel type bowl dating from c1660-1690 from 35 Castlegate (Acc No. CG91 115); rim bottered and half milled; bore 6/64". Marked with the initials HH on the heel. (Pcode 02055).

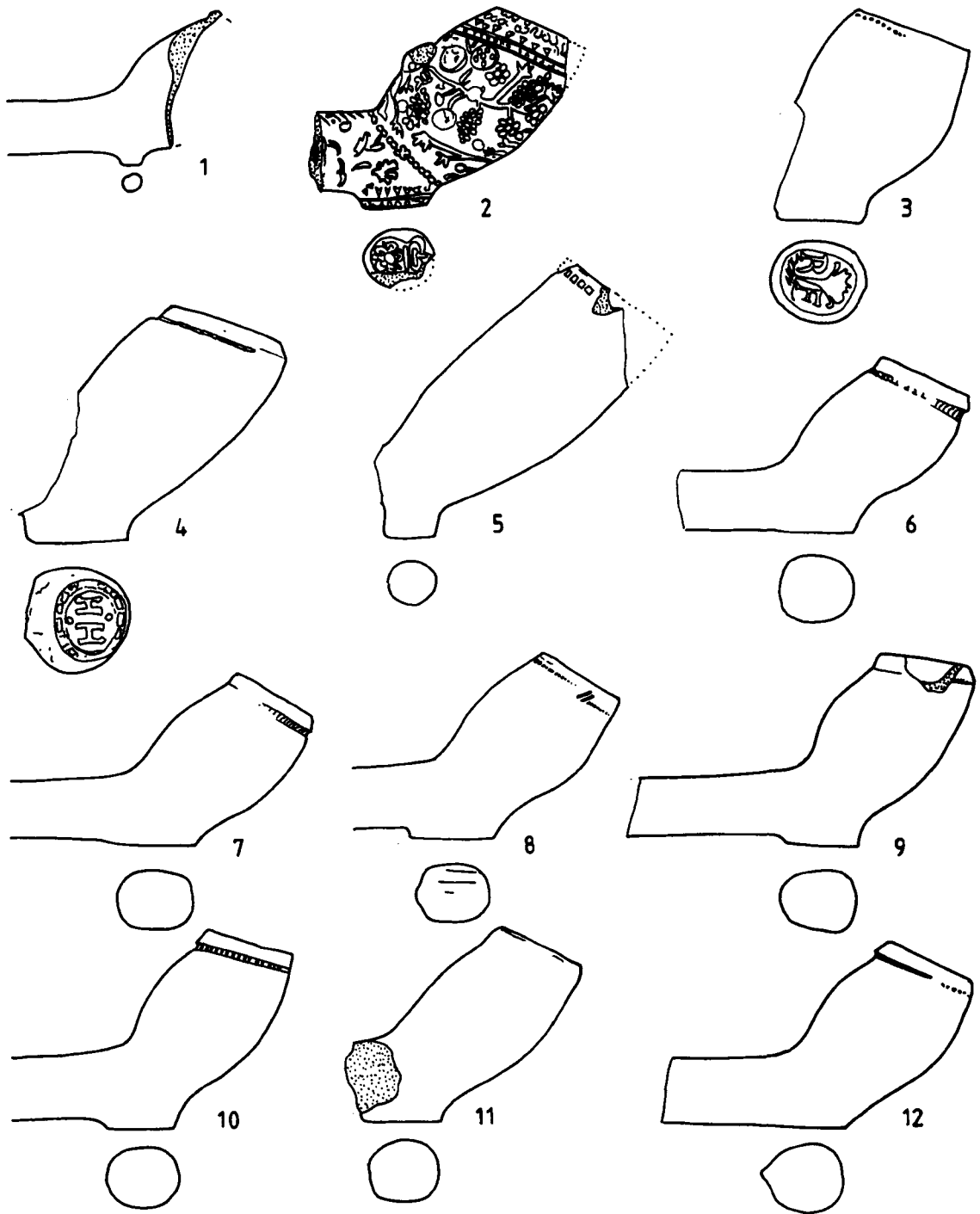
74.05 Heel type bowl dating from c1680-1710 from 35 Castlegate (Acc No. CG91 102); rim bottered; milled around all of the surviving rim; bore 6/64". (Pcode 05947).

74.06 Heel type bowl dating from c1640-1660 from Castle Hill (Acc No. 628.39); rim bottered and fully milled; bore 7/64". (Pcode 05982).

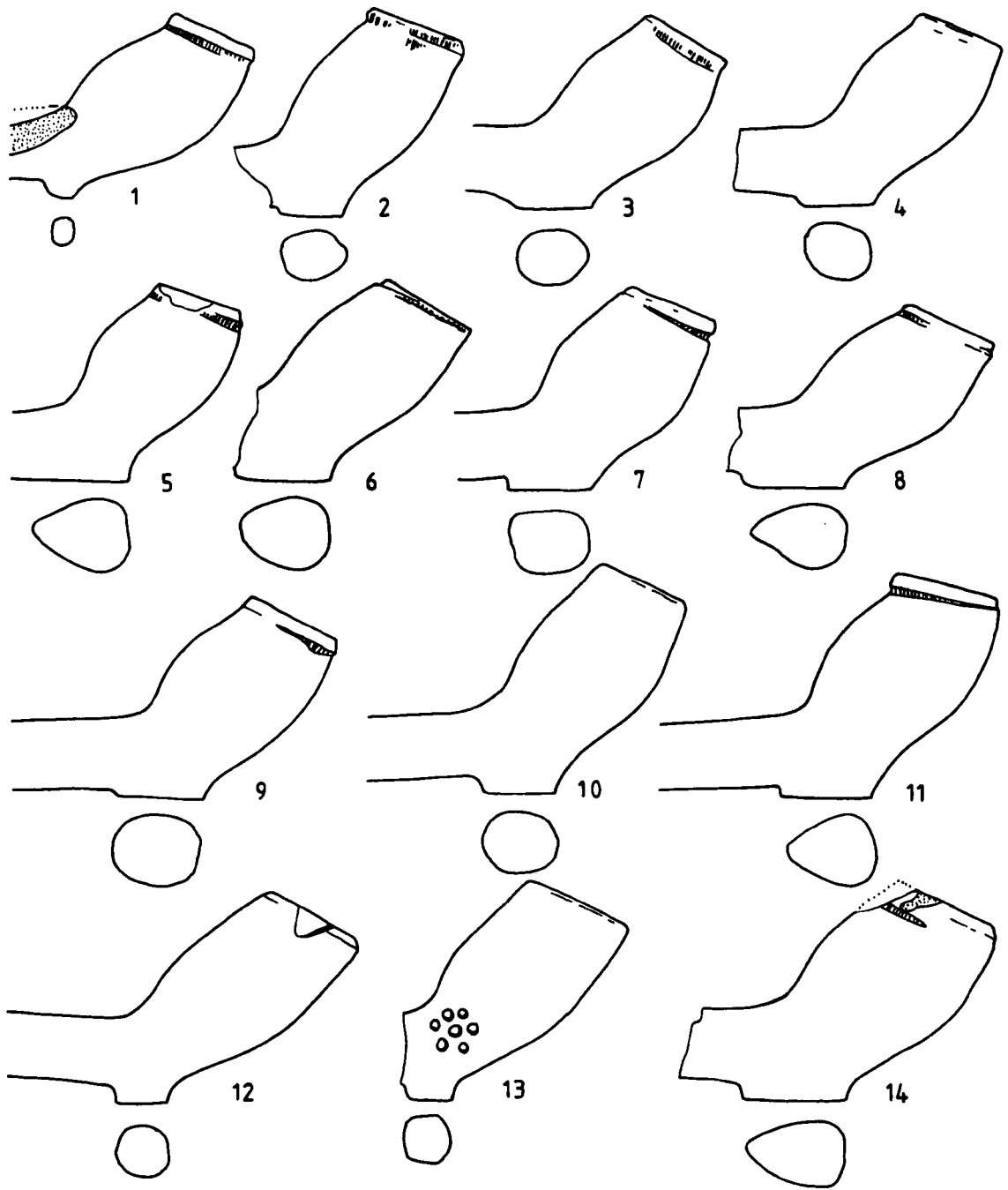
- 74.07 Heel type bowl dating from c1640-1660 from Castle Hill (Acc No. 625.39); rim bottered and fully milled; bore 7/64". (Pcode 05979).
- 74.08 Heel type bowl dating from c1640-1660 from Castle Hill (Acc No. 650.39); rim bottered and fully milled; bore 8/64". (Pcode 06002).
- 74.09 Heel type bowl dating from c1640-1660 from Castle Hill (Acc No. 604.39); rim bottered and fully milled; bore 7/64". (Pcode 05958).
- 74.10 Heel type bowl dating from c1640-1660 from Castle Hill (Acc No. 648.39); rim bottered and fully milled; bore 8/64". (Pcode 06001).
- 74.11 Heel type bowl dating from c1640-1660 from Castle Hill (Acc No. 645.39); rim bottered and half milled; bore 6/64". (Pcode 05999).
- 74.12 Heel type bowl dating from c1640-1660 from Castle Hill (Acc No. 644.39); rim bottered and three quarters milled; bore 6/64". (Pcode 05998).
- 75.01 Spur type bowl dating from c1640-1660 from Castle Hill (Acc No. 635.39); rim bottered and fully milled; bore 7/64". (Pcode 05990).
- 75.02 Heel type bowl dating from c1640-1660 from Castle Hill (Acc No. 610.39); rim bottered and three quarters milled; bore 6/64". (Pcode 05964).
- 75.03 Heel type bowl dating from c1640-1660 from Castle Hill (Acc No. 640.39); rim bottered and three quarters milled; bore 7/64". (Pcode 05994).
- 75.04 Heel type bowl dating from c1640-1660 from Castle Hill (Acc No. 611.39); rim bottered but not milled; bore 8/64". (Pcode 05965).
- 75.05 Heel type bowl dating from c1650-1670 from Castle Hill (Acc No. 661.39); rim bottered and three quarters milled; bore 6/64". Heart shaped heel. (Pcode 06011).
- 75.06 Heel type bowl dating from c1640-1660 from Castle Hill (Acc No. 630.39); rim bottered and three quarters milled; bore 6/64". (Pcode 05984).
- 75.07 Heel type bowl dating from c1640-1670 from Castle Hill (Acc No. 614.39); rim bottered but not milled; bore 7/64". (Pcode 05968).
- 75.08 Heel type bowl dating from c1650-1670 from Castle Hill (Acc No. 622.39); rim bottered and half milled; bore 7/64". Heart shaped heel. (Pcode 05977).
- 75.09 Heel type bowl dating from c1640-1670 from Castle Hill (Acc No. 613.39); rim bottered and fully milled; bore 8/64". (Pcode 05967).
- 75.10 Heel type bowl dating from c1660-1680 from Garfield Road (Acc No. 513.39); rim bottered; bore 7/64". Pipe marked "dug up in Garfield Road, Scarborough". (Pcode 06023).

- 75.11 Heel type bowl dating from c1640-1660 from Castle Hill (Acc No. 642.39); rim bottered and fully milled; bore 8/64". Heart shaped heel. (Pcode 05996).
- 75.12 Heel type bowl dating from c1640-1660 from Castle Hill (Acc No. 656.39); rim bottered but not milled; bore 6/64". Possibly Dutch. (Pcode 06008).
- 75.13 Heel type bowl dating from c1640-1660 from Castle Hill (Acc No. 606.39); rim bottered but not milled; bore 6/64". Marked with the a pelleted Tudor rose on the sides of the bowl. Possibly Dutch. (Pcode 05959).
- 75.14 Heel type bowl dating from c1640-1670 from Castle Hill (Acc No. 657.39); rim bottered and one quarter milled; bore 7/64". Heart shaped heel. (Pcode 06010).
- 76.01 Heel type bowl dating from c1645-1660 from Castle Hill (Acc No. 624.39); rim bottered and one quarter milled. Spur form. (Pcode 05978).
- 76.02 Heel type bowl dating from c1650-1670 from Castle Hill (Acc No. 634.39); rim bottered but not milled; bore 7/64". Heart shaped heel. (Pcode 05989).
- 76.03 Heel type bowl dating from c1640-1670 from Cooks Row (Acc No. 179.53); rim bottered but not milled; bore 7/64". (Pcode 06022).
- 76.04 Heel type bowl dating from c1650-1670 from Castle Hill (Acc No. 734.38); bore 6/64". No rim surviving. (Pcode 06012).
- 76.05 Heel type bowl dating from c1650-1670 from Castle Hill (Acc No. 617.39); rim bottered and three quarters milled; bore 7/64". (Pcode 05972).
- 76.06 Heel type bowl dating from c1660-1680 from Castle Hill (Acc No. 652.39); rim bottered but not milled; bore 6/64". (Pcode 06004).
- 76.07 Heel type bowl dating from c1660-1680 from Castle Hill (Acc No. 653.39); rim bottered and three quarters milled; bore 7/64". (Pcode 06005).
- 76.08 Heel type bowl dating from c1660-1680 from Castle Hill (Acc No. 668.39); rim bottered and half milled; bore 7/64". (Pcode 06014).
- 76.09 Heel type bowl dating from c1660-1680 from Cross Street (Acc No. 13.38); rim bottered and three quarters milled; bore 8/64". Pipe marked "Exc by Boro' engineers dept from Cross Street, Scarborough". (Pcode 05910).
- 76.10 Heel type bowl dating from c1660-1690 from Cross Street (Acc No. 735.38); rim cut; milled around all of the surviving rim; bore 7/64". (Pcode 05911).
- 76.11 Heel type bowl dating from c1660-1690 from Cross Street (Acc No. 32.38); average burnish; rim bottered and fully milled; bore 8/64". Marked with the initials SB on the heel. (Pcode 02052).

- 76.12 Spur type bowl dating from c1690-1710 from Paradise Street (Acc No. PDS B2 105); bore 6/64". No rim surviving. (Pcode 05929).
- 77.01 Spur type bowl dating from c1740-1800 from Paradise Street (Acc No. PDS B2 101); rim cut but not milled; bore 5/64". Marked with the initials IH on the sides of the spur. Very short bowl. (Pcode 05926).
- 77.02 Spur type bowl dating from c1740-1800 from Paradise Street (Acc No. PDS D1 100); rim cut but not milled; bore 3/64". Marked with the initials \*TN\* on the sides of the spur. Royal coat of arms - no supporters. (Pcode 05931).
- 77.03 Spur type bowl dating from c1700-1799 from Princess Street (Acc No. PS93 B106); finely burnished; bore 5/64". Possibly Dutch. (Pcode 06024).
- 77.04 Heel type bowl dating from c1650-1670 from 18-22 Sepulchre Street (Acc No. SS87 Spoil heap); rim bottered but not milled; bore 6/64". Heart shaped heel. (Pcode 05942).
- 77.05 Heel type bowl dating from c1660-1680 from Springfield, Quaker Mtg House (Acc No. SP T9 900); rim bottered and fully milled; bore 6/64". (Pcode 06015).
- 77.06 Heel type bowl dating from c1680-1710 from St Thomas' Street (Acc No. STS 408); rim bottered; milled around all of the surviving rim; bore 7/64". (Pcode 05921).
- 77.07 Heel type bowl dating from c1660-1700 from St Thomas' Street (Acc No. STS 601); rim bottered and half milled; bore 5/64". (Pcode 05922).
- 77.08 Stem fragment dating from c1640-1670 from Auborough Street (Acc No. AU205). Moulded decoration in the form of flowers and tendrils. (Pcode 02591).

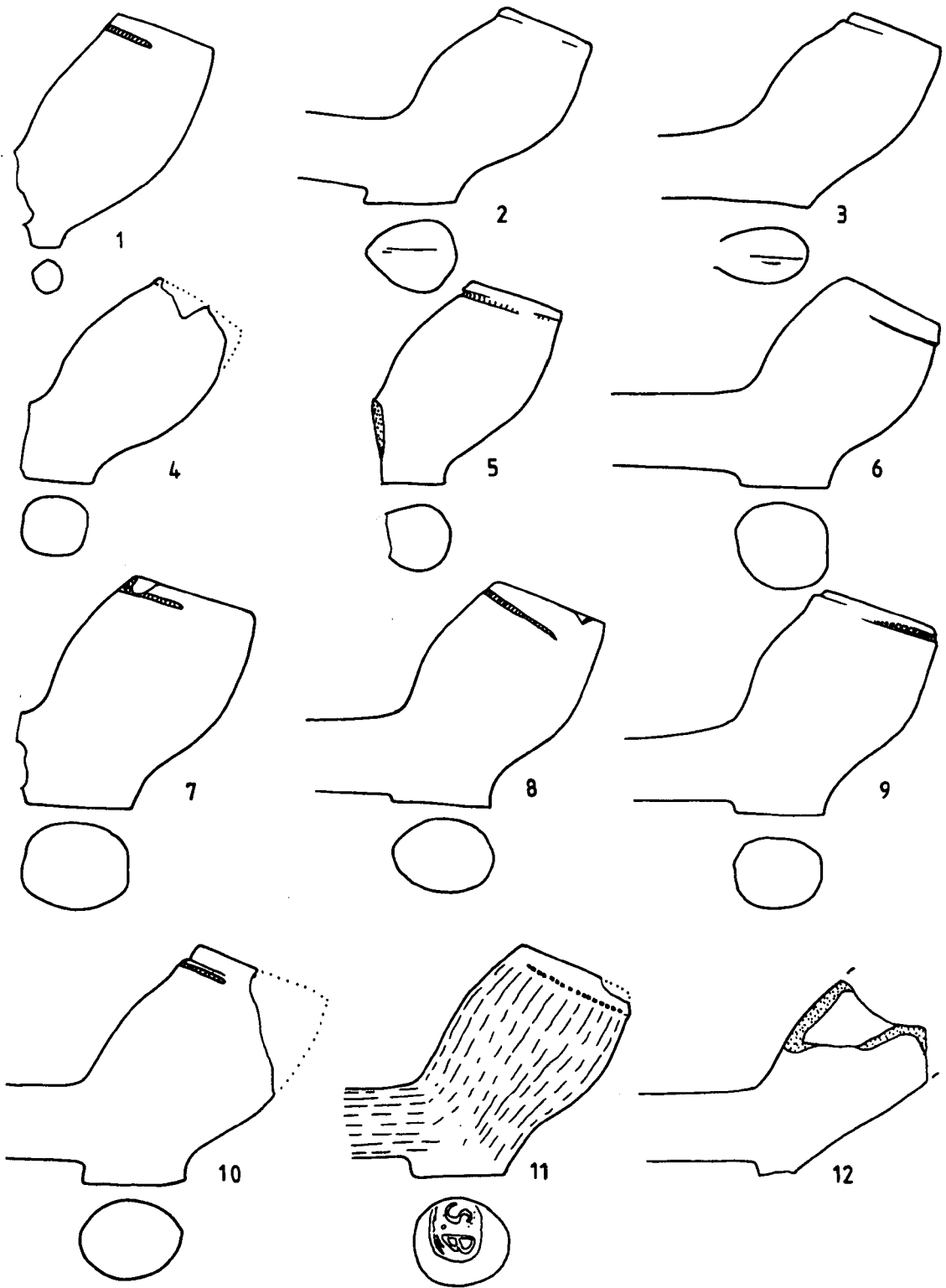


**Figure 74:** Pipes in the collections of Scarborough Borough Council, Lonsborough Lodge, Scarborough. Scale 1:1.

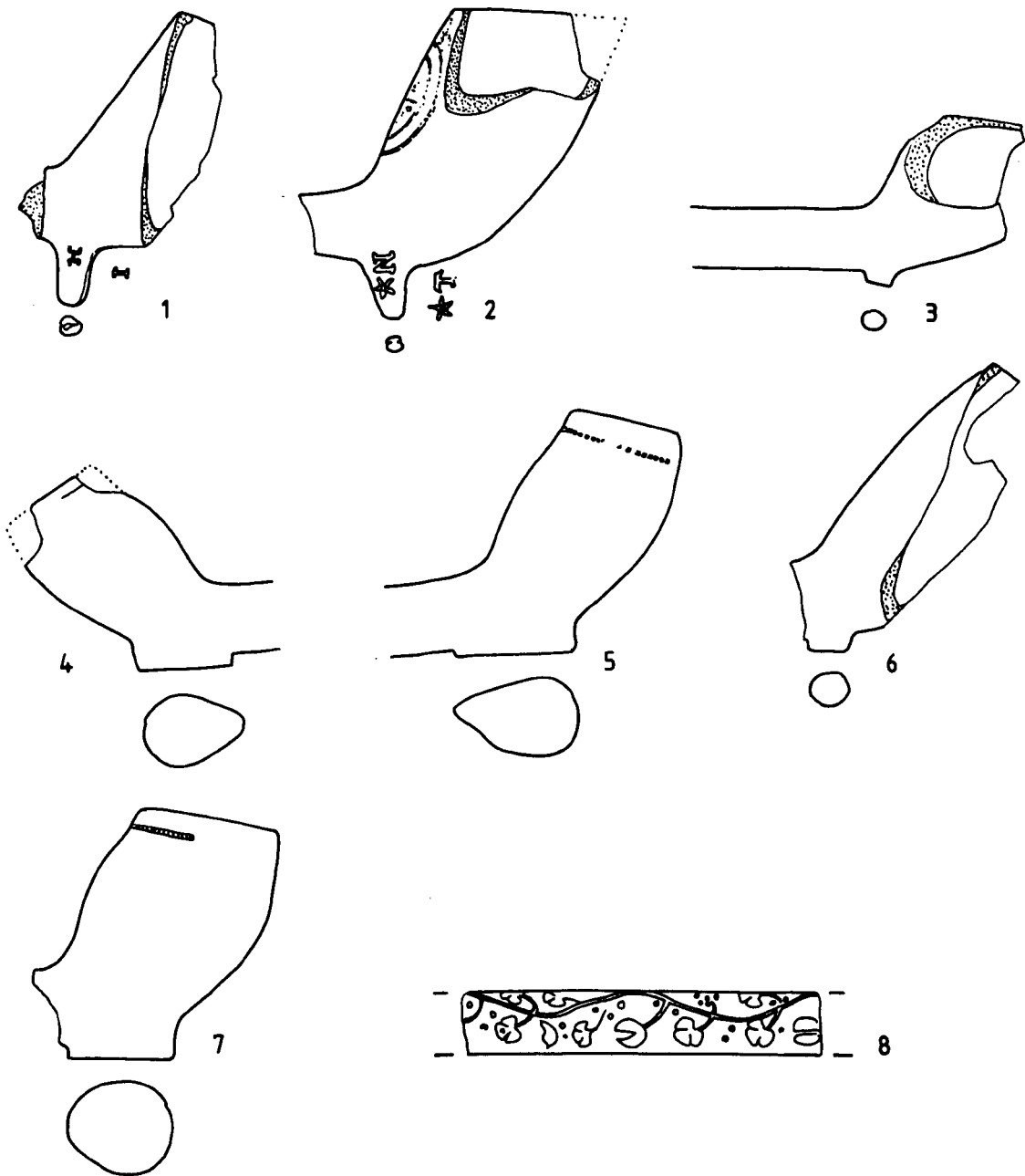


**Figure 75:** Pipes in the collections of Scarborough Borough Council, Lonsborough Lodge, Scarborough. Scale 1:1.





**Figure 76:** Pipes in the collections of Scarborough Borough Council, Lonsborough Lodge, Scarborough. Scale 1:1.



**Figure 77:** Pipes in the collections of Scarborough Borough Council, Lonsborough Lodge, Scarborough. Scale 1:1.

**Collection Name:** Butterfield Collection  
**Collection Code:** 0250  
**Contact Name:** Mr Alan Butterfield  
**Address:** Nr. Skipton, North Yorkshire

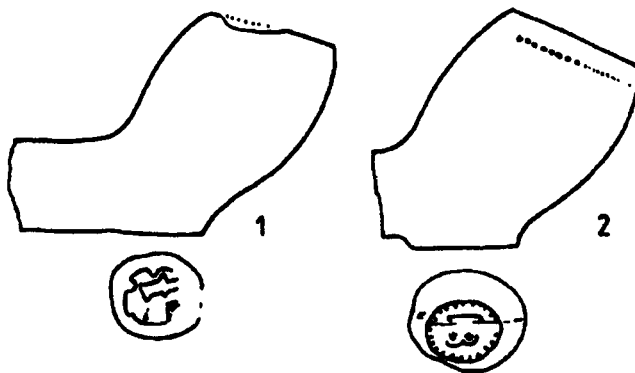
**Description:**

Collection recorded on 13<sup>th</sup> September 2001. A private collection including six seventeenth-century bowls from the Skipton area. Mr Butterfield also had a group of pipes collected from the fields near Carleton, these included 2 stamped bowls; 1 heel fragment; 3 bowl fragments; 4 fragments at the bowl/stem junction; 3 mouthpieces; 4 burnished stems possibly eighteenth century and 83 plain stems possibly seventeenth century. Notable later pipes include:

- Thorn pipe found pushed into a stone wall at Manor House, Glusburn
- Complete, spurless pipe with the lettering MINERS PIPE along the left-hand side of the stem.

78.01 Heel type bowl dating from c1650-1670 from a field in Carleton; rim bottered but not milled; bore 7/64". Marked with the initials I? on the heel. (Pcode 25165).

78.02 Heel type bowl dating from c1650-1670 from Grimwith Reservoir; rim bottered and three quarters milled; bore 7/64". Marked with the initials IB on the heel. (Pcode 25161).



**Figure 78:** Pipes from the Butterfield Collection, Nr. Skipton. Scale 1:1.

**Collection Name:** The Craven Museum  
**Collection Code:** 0249  
**Contact Name:** Kath Kershaw  
**Address:** Skipton, North Yorkshire

**Description:**

Collection recorded 13<sup>th</sup> September 2001. The collection included approximately 46 pipes dating from the seventeenth or eighteenth century. These pipes were mainly from the Skipton area and included a small number of marked pipes. Two bowls are clearly from London. The museum has two good-sized boxes full of miscellaneous finds in total, plus quite a number of pipes on display. Many decorated nineteenth-century forms. Notable pieces include:

- GAR22 – Unusual bowl in the form of a cauldron with what looks like riveted strap work on it. The stem is formed in the shape of a figure, facing down, with legs crossed under the bowl.
- Shelf 34 – Horses hoof bowl with good design and brown enamel rim for the horse's shoe. L Fiolet stamped on the stem.
- D1225 – Miners pipe with incuse moulded lettering on the left-hand side of the stem only
- D1306 – complete pipe identical to above
- D1971 – 15 miners pipes with moulded lettering as above
- D660 – W Southorn & Co churchwarden with stem twist.
- D661 – 2 complete pipes with glazed tips
- D1479 – Crystal palace cadger
- D3059 – Complete pipe with Ben Nevis on both sides of the stem in a beaded border
- A10 – Mixed group of pipes from Lea Green including some 17<sup>th</sup> and 18<sup>th</sup> century pieces.
- D1674 – Mixed group of pipes include 2 17<sup>th</sup> century bowls, one MAYO ST/DUBLIN stamp a number of plain stems and a mouthpiece.
- Large group of pipes from excavations at Canal Yard, Skipton. one context in particular (CY 3CFII) contains several hundred fragments, all mid 19<sup>th</sup> century (c1820-1860) with pale green and blotchy glazed tips. All bowls are rather battered but a limited range of forms seems to be present. Possibly a kiln group.
- On display - a boxing pipe. The bowl is damaged so that the name of the boxer cannot be read, but it is possibly Tom Sayers.

79.01 Heel type bowl dating from c1610-1640 from Settle (Acc No. 106); internal bowl cross; rim internally trimmed, bottered and fully milled; stem bore 7/64". Marked with a wheel motif on the heel. (Pcode 25134).

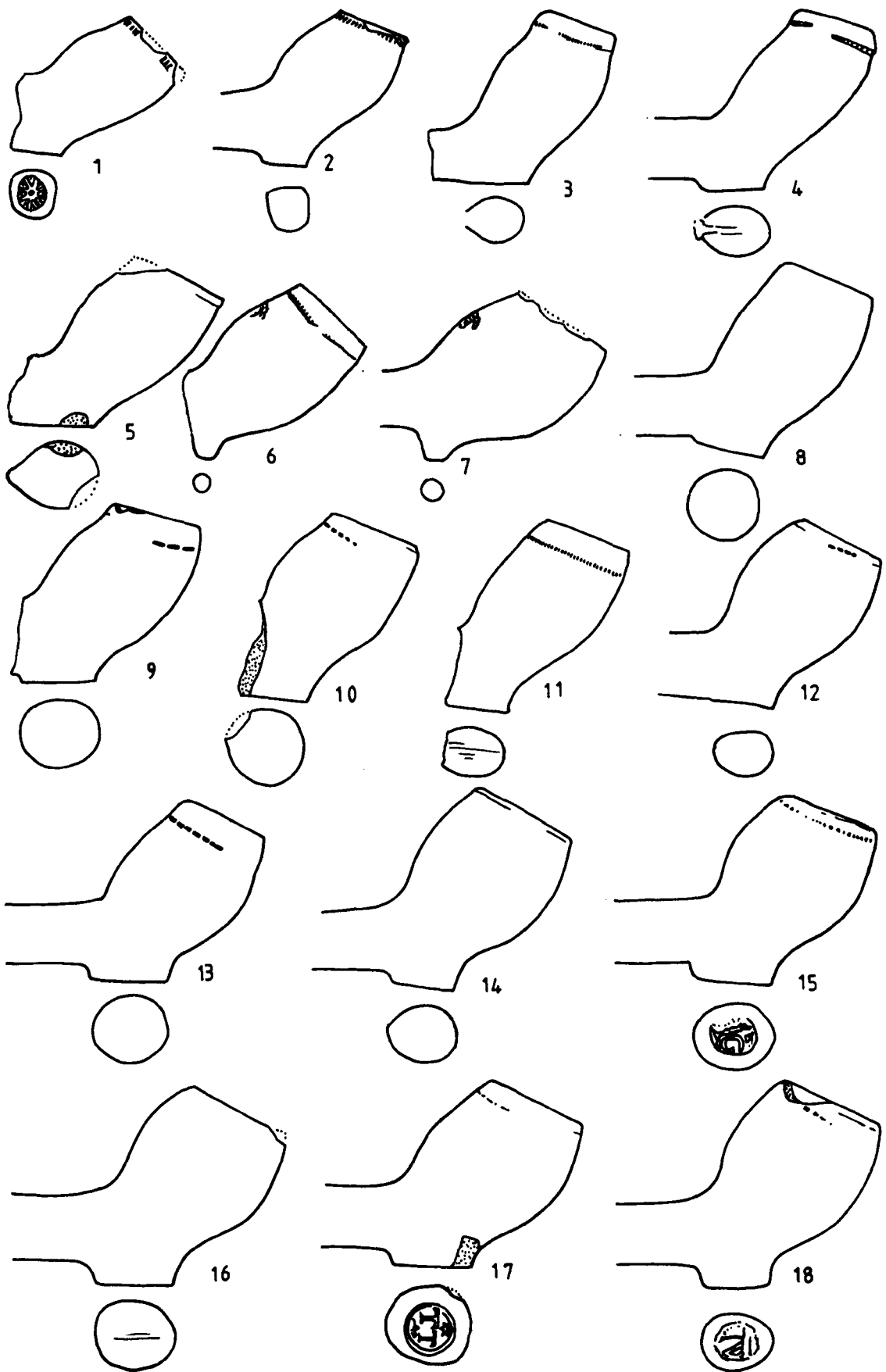
79.02 Heel type bowl dating from c1610-1640 from Grimwith Reservoir (Acc No. 551); average burnish; rim bottered and fully milled; stem bore 7/64". (Pcode 25150).

79.03 Heel type bowl dating from c1630-1650 from Calton Lodge (Acc No. 167c); rim bottered and fully milled; stem bore 7/64". (Pcode 25131).

- 79.04 Heel type bowl dating from c1640-1660 from Lea Green (Acc No. Lea Green); rim internally trimmed, bottered and fully milled; stem bore 8/64". (Pcode 25148).
- 79.05 Heel type bowl dating from c1640-1660 from Park Hill (Acc No. Parkhill); rim bottered but not milled; stem bore 7/64". Donated by Mr Harland, Four Winds, Intake Lane, Grassington, Nr Skipton. (Pcode 25118).
- 79.06 Spur type bowl dating from c1650-1670 from Settle (Acc No. 106); rim bottered and fully milled; stem bore 7/64". Marked with the initials IB on the bowl facing the smoker. S Lancs form. (Pcode 25135).
- 79.07 Spur type bowl dating from c1650-1670, unprovenanced material in Craven Museum (Acc No. Shelf 34); rim bottered but not milled; stem bore 7/64". Marked with the initials IB on the bowl facing the smoker. S Lancs form. (Pcode 25147).
- 79.08 Heel type bowl dating from c1650-1670, unprovenanced material in Craven Museum (Acc No. D940); rim bottered but not milled; stem bore 7/64". (Pcode 25125).
- 79.09 Heel type bowl dating from c1650-1670 from Grassington Moor (Acc No. 163g); rim bottered and half milled; stem bore 6/64". (Pcode 25130).
- 79.10 Heel type bowl dating from c1660-1680 from Old Grammar School (Acc No. D1665); rim bottered and half milled. Found by the Old Grammar School. (Pcode 25122).
- 79.11 Heel type bowl dating from c1650-1670 from Ockley Road (Acc No. D1674); rim bottered and fully milled; stem bore 7/64". (Pcode 25132).
- 79.12 Heel type bowl dating from c1650-1670 from Grimwith Reservoir (Acc No. 551); rim bottered and half milled; stem bore 5/64". (Pcode 25152).
- 79.13 Heel type bowl dating from c1650-1670 from Lea Green (Acc No. Lea Green); rim bottered and half milled; stem bore 6/64". (Pcode 25123).
- 79.14 Heel type bowl dating from c1660-1680 from Grimwith Reservoir (Acc No. 551); rim bottered but not milled; stem bore 7/64". Very bulbous. (Pcode 25151).
- 79.15 Heel type bowl dating from c1660-1680 from Grimwith Reservoir (Acc No. 551); rim bottered and half milled; stem bore 6/64". Marked with the initials ?G on the heel. (Pcode 25159).
- 79.16 Heel type bowl dating from c1660-1690 from Skipton Castle (Acc No. D1838); rim bottered but not milled; stem bore 6/64". Found in the bailey (presumably Skipton castle). (Pcode 25127).

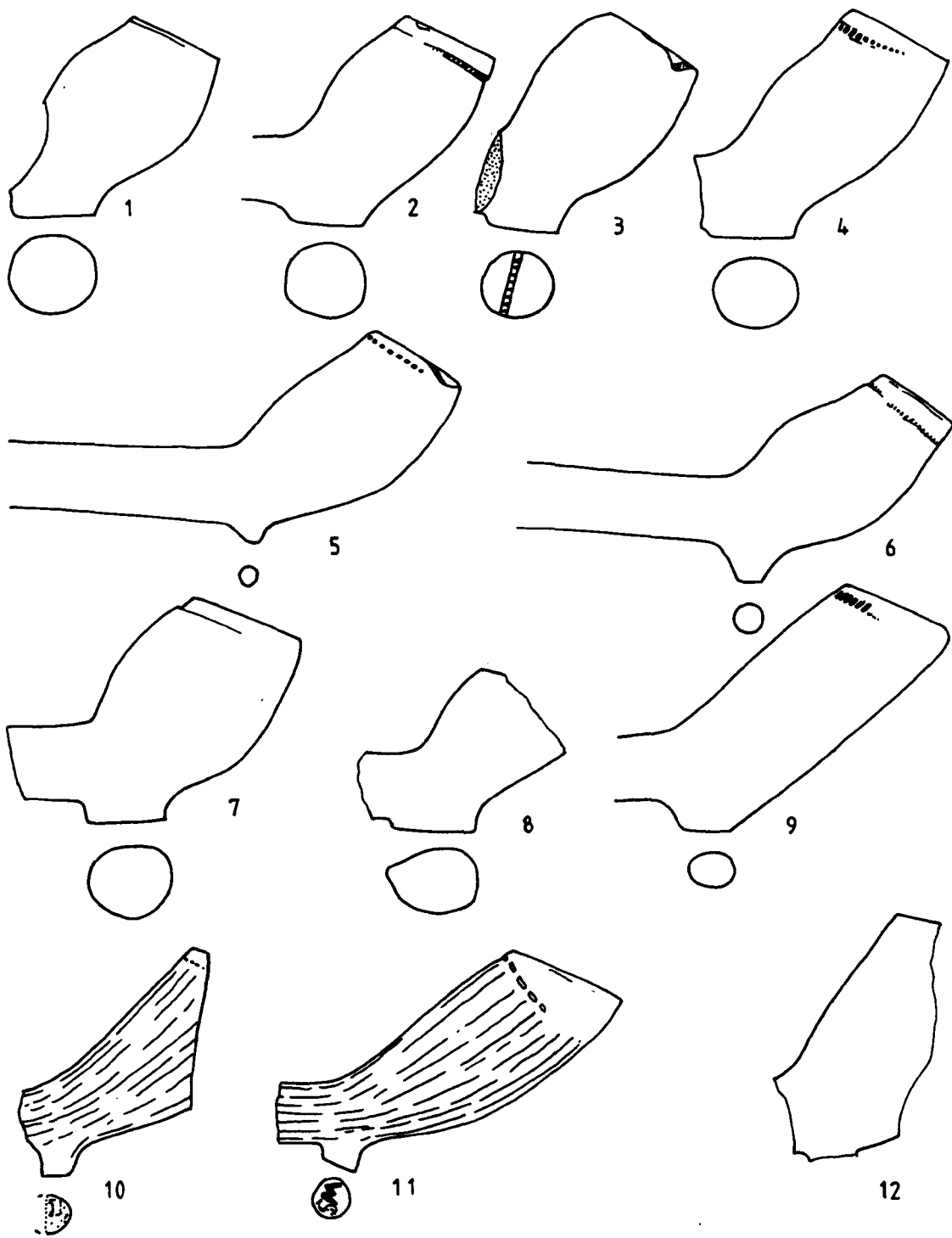
- 79.17 Heel type bowl dating from c1660-1680 from Grimwith Reservoir (Acc No. 551); rim bottered but not milled; stem bore 7/64". Marked with the initials TT on the heel. (Pcode 25157).
- 79.18 Heel type bowl dating from c1660-1680 from Grimwith Reservoir (Acc No. 551); rim bottered and one quarter milled; stem bore 7/64". Marked with the crowned initials IW on the heel. (Pcode 25158).
- 80.01 Heel type bowl dating from c1660-1680 from Carleton (Acc No. 244); rim bottered but not milled. Micaceous fabric. (Pcode 25121).
- 80.02 Heel type bowl dating from c1660-1680 from Cove Pasture (Acc No. Cove Pasture); rim internally trimmed, bottered and fully milled; stem bore 5/64". (Pcode 25149).
- 80.03 Heel type bowl dating from c1650-1670 from Rylstone (Acc No. Rylstone); rim bottered but not milled; stem bore 6/64". Milled heel. Donated by Mr Harland, Four Winds, Intake Lane, Grassington, Nr Skipton. (Pcode 25116).
- 80.04 Heel type bowl dating from c1660-1680 from Park Hill (Acc No. Parkhill); rim bottered and fully milled; stem bore 6/64". Donated by Mr Harland, Four Winds, Intake Lane, Grassington, Nr Skipton. (Pcode 25115).
- 80.05 Spur type bowl dating from c1660-1680 from Grimwith Reservoir (Acc No. 551); rim bottered and half milled; stem bore 7/64". (Pcode 25153).
- 80.06 Heel type bowl dating from c1660-1680, unprovenanced material in Craven Museum (Acc No. D1037); rim bottered and fully milled; stem bore 7/64". (Pcode 25160).
- 80.07 Heel type bowl dating from c1660-1690, unprovenanced material in Craven Museum (Acc No. B38A); rim bottered but not milled; stem bore 7/64". (Pcode 25141).
- 80.08 Heel type bowl dating from c1640-1660 from Friends Meeting House (Acc No. Friends Mtg Hse); stem bore 7/64". Donated by Mr Harland, Four Winds, Intake Lane, Grassington, Nr Skipton. (Pcode 25117).
- 80.09 Heel type bowl dating from c1680-1710, unprovenanced material in Craven Museum (Acc No. D1037); rim bottered and half milled; stem bore 6/64". Similar to London Type 22 - probably not a Yorkshire product. (Pcode 25128).
- 80.10 Spur type bowl dating from c1690-1720 from Canal Yard (Acc No. 72); average burnish; rim bottered; milled on all surviving rim; stem bore 5/64". Marked with the initials ?H on the heel. Illegible mark. (Pcode 25139).
- 80.11 Spur type bowl dating from c1690-1720 from Canal Yard (Acc No. 72); average burnish; rim internally trimmed, bottered and half milled; stem bore 6/64". Marked with the initials W?S on the heel. (Pcode 25140).

- 80.12 Bowl dating from c1710-1730 from Canal Yard (Acc No. 72); rim bottered but not milled; stem bore 5/64". (Pcode 25138).
- 81.01 Cadger Churchwarden dating from c1850-1910 (Acc No. D660); rim cut and internally trimmed; lettering WS poorly impressed on the right-hand side of the spur; stem twist and the stamped mark W SOUTHORN & CO BROSELEY.
- 81.02 Spurless bowl dating from c1860; stem bore 6/64". Moulded design of a boxer in a ring with the moulded lettering TOM (SAYERS) on the smokers right and (HEE)NAN on the smokers left. Pipe appears to commemorate a bout between Sayers and Heenan. The Museum of Yorkshire Dales Lead Mining at Earby holds a complete example from the same mould.
- 81.03 Unusual bowl in the form of a 'cauldron' dating from c1860-1910 (Acc No. GAR 22). The bowl appears to have riveted strap work on it; the stem is formed by a figure, facing down, with legs crossed under the bowl.
- 81.04 Spur type bowl dating from c1820-1860 (Acc No. FII CY6 a + b) from Canal Yard, Skipton, no internal bowl cross; stem bore 4/64". Seven examples of this bowl recovered from a possible kiln dump.

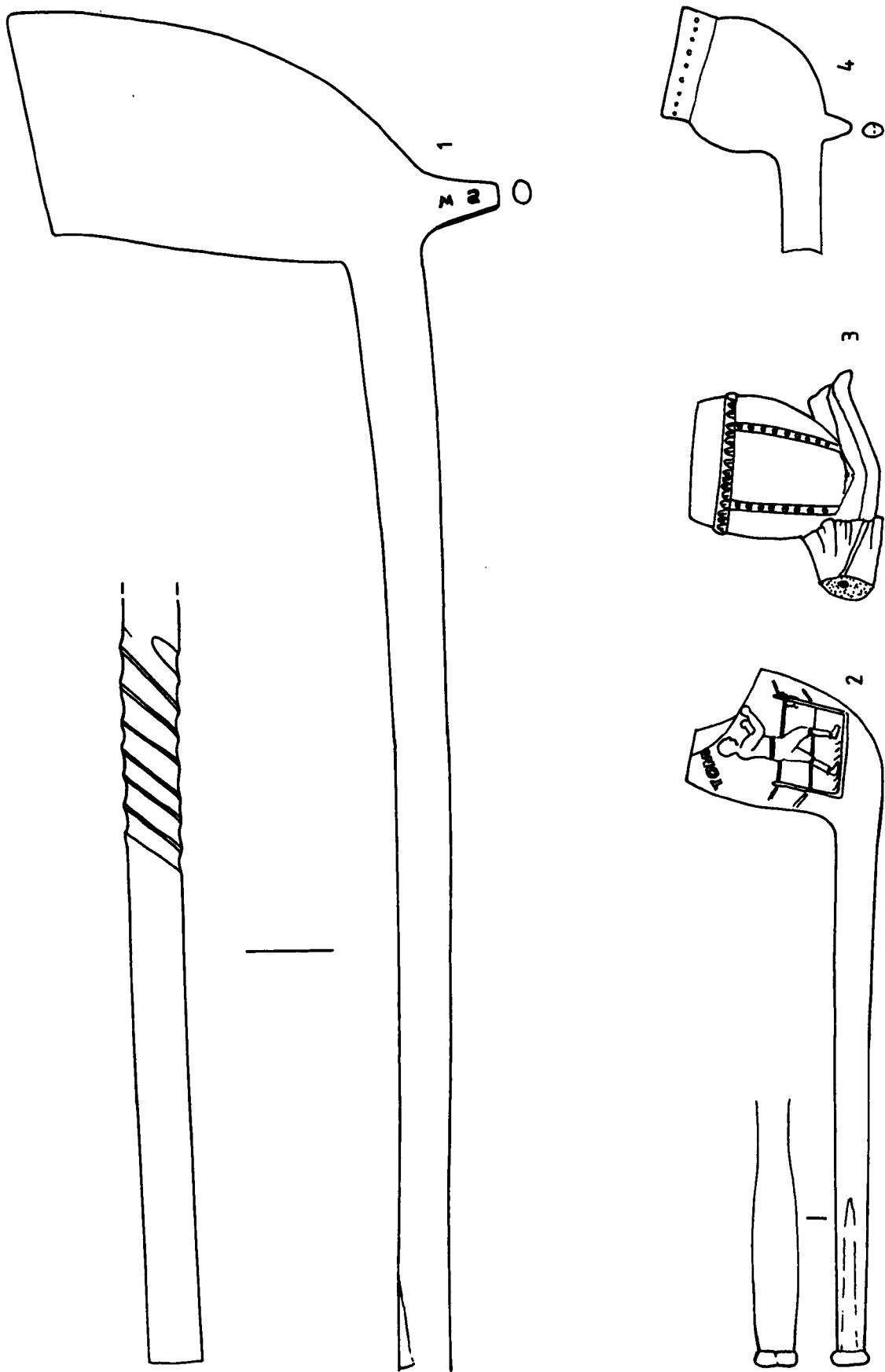


**Figure 79: Pipes from the collections of the Craven Museum, Skipton. Scale 1:1**





**Figure 80:** Pipes from the Collections of the Craven Museum, Skipton. Scale 1:1



**Figure 81:** Pipes from the collections of the Craven Museum, Skipton. Scale 1:1

**Collection Name:** Thirsk Museum  
**Collection Code:** 0154  
**Contact Name:** Mr Cooper-Harding  
**Address:** Thirsk, North Yorkshire

**Description:**

Collection recorded 2<sup>nd</sup> June 1998. The collection comprises a range of pipes from the seventeenth through to the nineteenth and early twentieth century. Only five pipes dating from the seventeenth or eighteenth century were recorded in detail for the Yorkshire Database. In addition, there was a range of nineteenth- and early twentieth-century pipes the most notable are as follows:

- 86.12 - Football and boot pipe; unusual in that it is slip cast and glazed externally.
- 65 - Complete cricketers pipe with large leaf on each seam; faint mould mark on the left-hand side of the stem, possibly No. 14.
- 277 - Complete 'bulldog' cutty
- 1059.4 - Complete spurless 'Thorn' design with Pollock type rustication added.
- 1113 - Complete miniature pipe
- Complete spurless pipe similar to a 'Miner'
- Complete Pollock's pipe; unsmoked; dark red mouthpiece.
- Complete Pollock's 'Churchwarden' with red tip in original box.
- 470 - Fluted bowl of c1790-1820 with swags above a small arrow motif. The initials JT relief moulded in serif lettering on the bowl facing the smoker.

82.01 Heel type bowl dating from c1640-1660 from 32 Topcliffe Road; rim bottered but not milled; stem bore 8/64". Very badly abraded. (Pcode 08087).

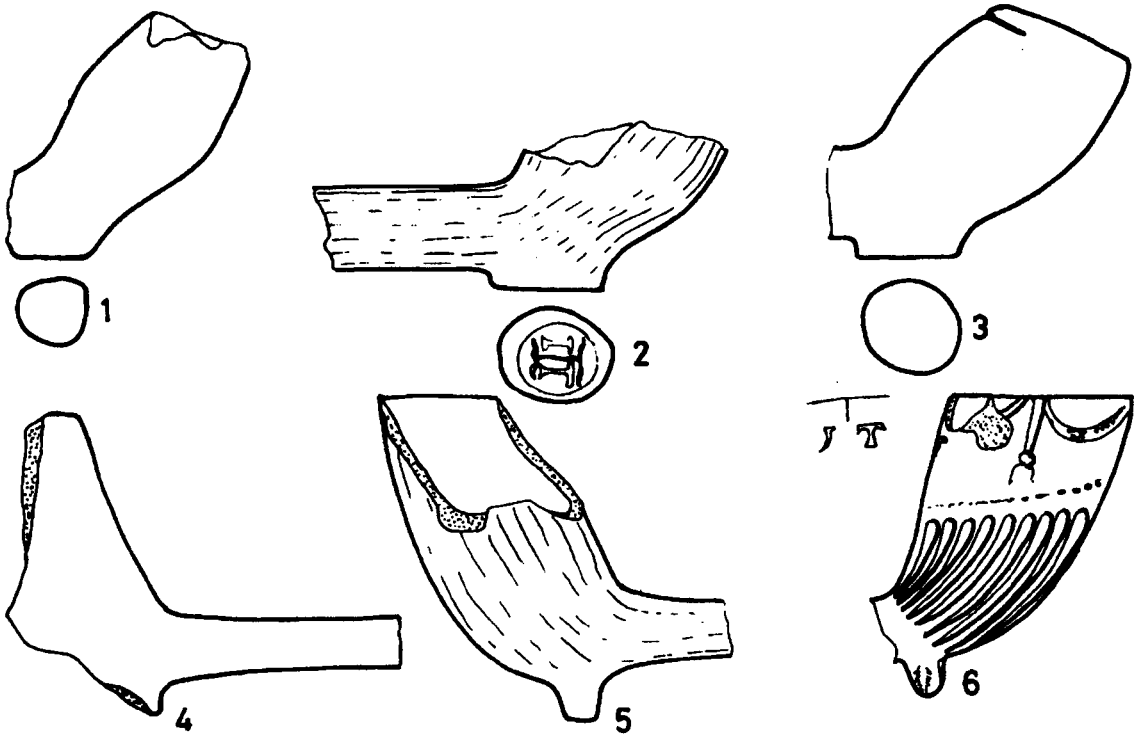
82.02 Heel type bowl dating from c1660-1680 from Unprovenanced material in Thirsk Museum (Acc No. ?305); average burnish; stem bore 7/64". Marked with the initials IT on the heel. No rim. (Pcode 2031).

82.03 Heel type bowl dating from c1660-1680 from 32 Topcliffe Road; rim bottered and one quarter milled; stem bore 7/64". (Pcode 08086).

82.04 Spur type bowl dating from c1710-1790 unprovenanced material in Thirsk Museum (Acc No. 305); rim internally trimmed, cut but not milled; stem bore 4/64". (Pcode 08085).

82.05 Heel type bowl dating from c1690-1730 unprovenanced material in Thirsk Museum; poorly burnished; rim appears to be cut. Pipe mounted inside a glass case.

82.06 Spur type bowl dating from c1790-1820 unprovenanced material in Thirsk Museum; not milled. Flutes and swags bowl marked with the moulded initials JT on the bowl facing the smoker



**Figure 82:** Pipes from the collections of Thirsk Museum, Scale 1:1

**Collection Name:** Whitby Museum  
**Collection Code:** 0155  
**Contact Name:** Mr Roger Pickles  
**Address:** Whitby, North Yorkshire  
**Description:**

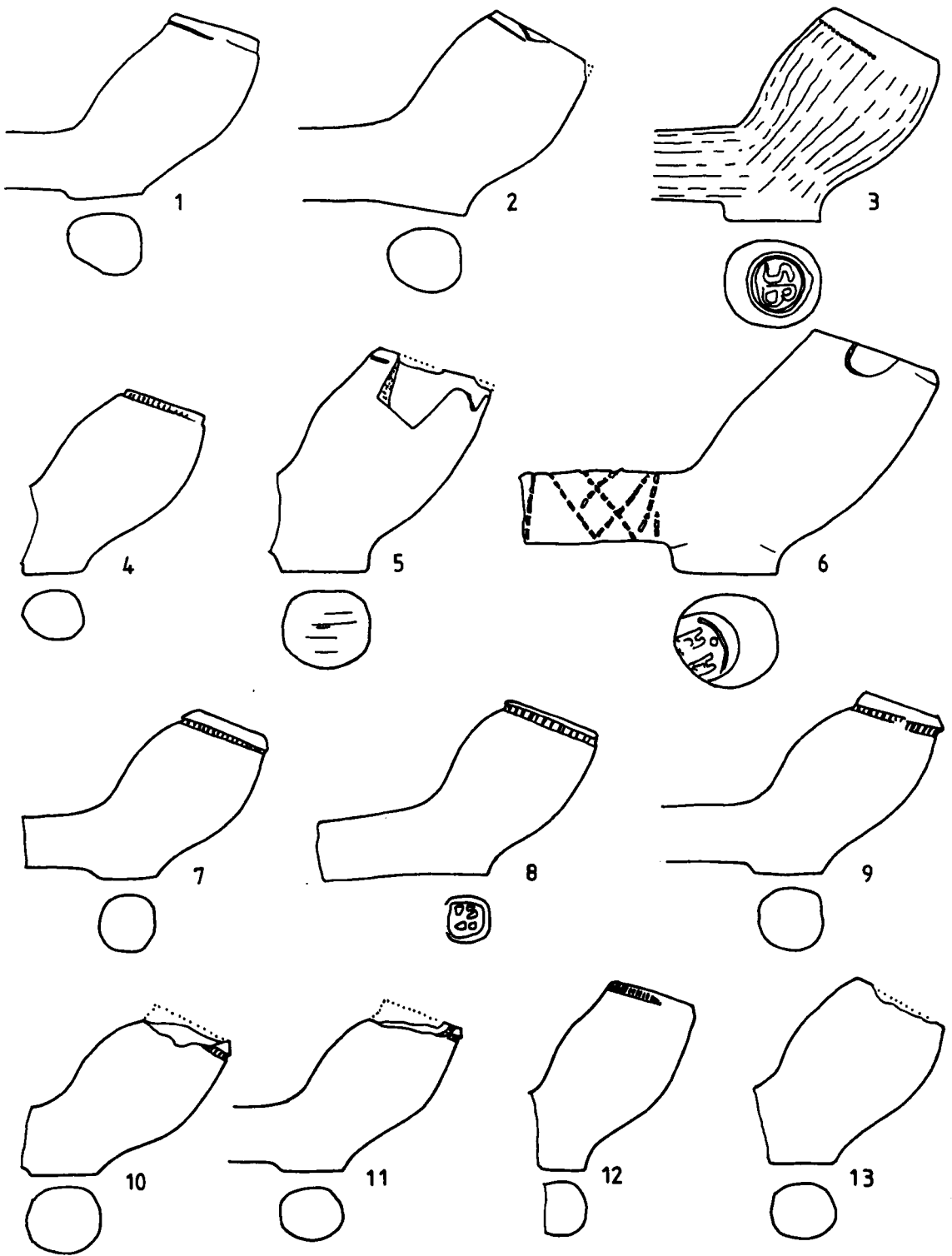
Collection recorded 4<sup>th</sup> June 1998. Very fine collection of pipes and smoking related ephemera. A total of 25 seventeenth- and eighteenth-century pipes were recorded in detail for the Yorkshire database. Most notable objects are as follows:

- SOH915 – Fluted bowl with most of stem surviving, dating from c1770-1800. The stem is marked with two roll stamp marks in the Midland style with the initials IS or SI incorporated into the design.
- Very fine collection of Ottoman style bowls
- SOH266 – Fine porcelain bowl
- SOH770 – Bowl in the form of a lady's head.

- 83.01 Heel type bowl dating from c1650-1670 from Grathdale Church (Acc No. 807 23); rim bottered but not milled; stem bore 7/64". Pipe marked "Grathdale Church 1902". (Pcode 08105).
- 83.02 Heel type bowl dating from c1650-1670 from Meadowfields (Acc No. SOH802); rim bottered but not milled; stem bore 6/64". Pipe marked "Meadowfield". (Pcode 08106).
- 83.03 Heel type bowl dating from c1660-1690 from Whitby Abbey (Acc No. SOH 801); average burnish; rim bottered and half milled; stem bore 7/64". Marked with the initials SB on the heel. Pipe marked "Whitby Abbey FKR". (Pcode 02043).
- 83.04 Heel type bowl dating from c1640-1660 from Pannett Park (Acc No. SOH 805); rim bottered but not milled; stem bore 7/64". (Pcode 08089).
- 83.05 Heel type bowl dating from c1660-1680 from Pannett Park (Acc No. SOH 805); rim bottered but not milled; stem bore 8/64". (Pcode 08088).
- 83.06 Heel type bowl dating from c1670-1680 from Pannett Park (Acc No. SOH 805); rim bottered but not milled; stem bore 6/64". Marked with the initials HH on the heel. Milled stem decoration. (Pcode 02041).
- 83.07 Heel type bowl dating from c1630-1640 unprovenanced but probably from York (Acc No. 813 52); rim bottered; milled around all of the surviving rim; stem bore 7/64". Pipe marked "York". (Pcode 08103).
- 83.08 Heel type bowl dating from c1640-1660 unprovenanced but probably from York (Acc No. 53 York); rim bottered and fully milled; stem bore 7/64". Illegible mark on the heel. Pipe marked "York". (Pcode 02040).

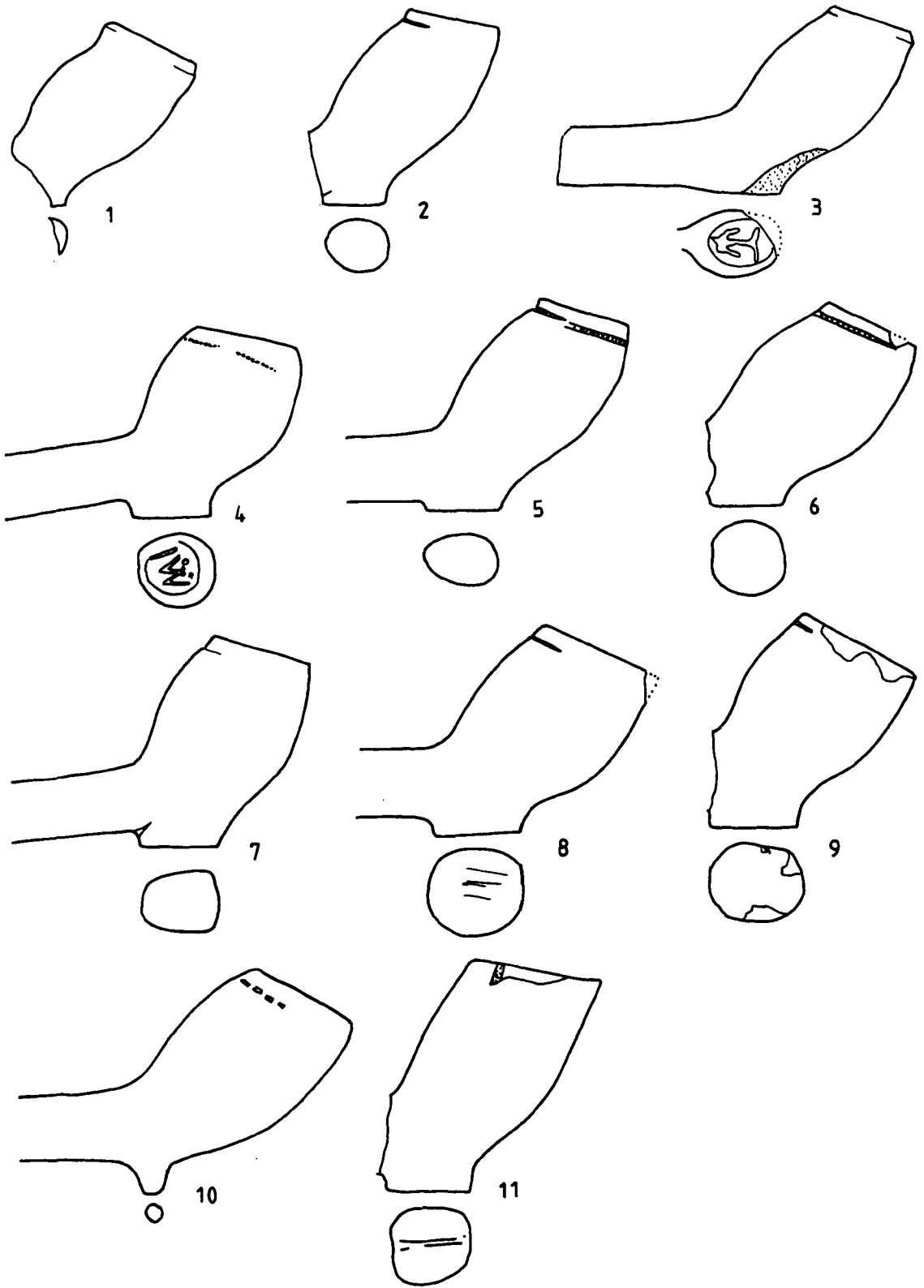
- 83.09 Heel type bowl dating from c1650-1670 unprovenanced but probably from York (Acc No. SOH249); rim bottered and fully milled; stem bore 6/64". Pipe marked "York". (Pcode 08104).
- 83.10 Heel type bowl dating from c1620-1640 unprovenanced material in Whitby Museum (Acc No. B17 (?817) 18); milled around all of the surviving rim; stem bore 7/64". Rim damaged. (Pcode 08098).
- 83.11 Heel type bowl dating from c1620-1640 unprovenanced material in Whitby Museum (Acc No. 815 18); rim bottered; milled around all of the surviving rim; stem bore 7/64". (Pcode 08093).
- 83.12 Heel type bowl dating from c1640-1660 unprovenanced material in Whitby Museum (Acc No. SOH250); rim bottered and three quarters milled; stem bore 7/64". (Pcode 08099).
- 83.13 Heel type bowl dating from c1640-1660 unprovenanced material in Whitby Museum (Acc No. 818 18); no rim surviving; rim one quarter milled; stem bore 7/64". (Pcode 08095).
- 84.01 Heel type bowl dating from c1640-1660 unprovenanced material in Whitby Museum (Acc No. 819 18); no rim surviving; rim not milled; stem bore 7/64". Rim damaged; water rolled. (Pcode 08096).
- 84.02 Heel type bowl dating from c1640-1670 unprovenanced material in Whitby Museum (Acc No. 816 18); rim bottered but not milled; stem bore 7/64". (Pcode 08094).
- 84.03 Heel type bowl dating from c1640-1670 unprovenanced material in Whitby Museum (Acc No. SOH 809); rim bottered but not milled; stem bore 7/64". Marked on the heel with a ?tobacco plant motif. (Pcode 02042).
- 84.04 Heel type bowl dating from c1650-1670 unprovenanced material in Whitby Museum (Acc No. SOH 811); rim bottered and half milled; stem bore 6/64". Marked with the initials ?IW on the heel. Surface covered with concretion; marked "Dr J E Hemingway 1936". (Pcode 02044).
- 84.05 Heel type bowl dating from c1660-1680 unprovenanced material in Whitby Museum (Acc No. SOH257); rim bottered and fully milled; stem bore 6/64". (Pcode 08100).
- 84.06 Heel type bowl dating from c1650-1670 unprovenanced material in Whitby Museum (Acc No. 1334); rim bottered but not milled; stem bore 8/64". (Pcode 08090).
- 84.07 Heel type bowl dating from c1660-1680 unprovenanced material in Whitby Museum (Acc No. 824 23); rim bottered but not milled; stem bore 7/64". (Pcode 08097).

- 84.08 Heel type bowl dating from c1660-1690 unprovenanced material in Whitby Museum; rim bottered and one quarter milled; stem bore 7/64". In an envelope marked "From Mr Wood, Paxo Cottage, Thorpe Fylingdales". (Pcode 08101).
- 84.09 Heel type bowl dating from c1650-1670 unprovenanced material in Whitby Museum (Acc No. 804 23); no rim surviving; stem bore 8/64". Rim damaged; very roughly made. (Pcode 08091).
- 84.10 Spur type bowl dating from c1670-1690 unprovenanced material in Whitby Museum (Acc No. 808 23); rim bottered and half milled; stem bore 6/64". (Pcode 08092).
- 84.11 Heel type bowl dating from c1690-1710 unprovenanced material in Whitby Museum; rim cut but not milled; stem bore 6/64". In an envelope marked "From Mr Wood, Paxo Cottage, Thorpe Fylingdales". (Pcode 08102).



**Figure 83:** Pipes from the collections of Whitby Museum, Scale 1:1.





**Figure 84:** Pipes from the collections of Whitby Museum, Scale 1:1.

**Collection Name:** York Archaeological Trust

**Collection Code:** 0129

**Contact Name:** Christine McDonnell

**Address:** York, North Yorkshire

**Description:**

Collection recorded during five visits to York between May 1995 and July 1997. In addition arrangements were made to borrow material from 13 sites in York for detailed studied in Liverpool. In total 732 pipes dating from the seventeenth or eighteenth century were recorded in detail for inclusion in the Yorkshire database. No plain stems were recorded. Very little later material was recorded however the following were noted:

- +1992.12 (3000) – Piece of hand rolled pipe clay covered in fingerprints with impressions along one side. These impressions have slight lines which could be mould seams or from a fluted bowl. This has been identified as kiln furniture.
- 1989.21 (1001) – Irish style bowl dating from c1850-1940 with a MILO/STRAND bowl stamp and real milling.
- 1990.25 – Large group of approximately 35 plain nineteenth-century bowls, which may come from the same mould. All have been smoked therefore they are not kiln waste. Very large sections of stem survive, up to 25.5cm. This group may well contain complete pipes.
- 1991.18 (3005) – part of a coronation/jubilee pipe dating from c1887-1902.
- 1973.15 – bowl dating from first half of the nineteenth century with a shield containing three fleur-de-lys on both sides of the bowl.

85.01 Heel type bowl dating from c1620-1640 from 118-126 Walmgate (Acc No. 1979.8 I 1094); very finely burnished; rim bottered and fully milled; stem bore 7/64". Marked with the initials BC on the heel. Heel fragment only. (Pcode 01943)

85.02 Heel type bowl dating from c1640-1660 from 118-126 Walmgate (Acc No. 1979.8 II 2032); very finely burnished; rim bottered and fully milled; stem bore 8/64". Marked with a Fleur-de-lys on the heel. (Pcode 01941)

85.03 Heel type bowl dating from c1620-1640 from 1-2 Tower Street (Acc No. 1981.3 I 1107); rim bottered and fully milled; stem bore 7/64". Possibly Dutch. (Pcode 05634)

85.04 Heel type bowl dating from c1640-1660 from 1-2 Tower Street (Acc No. 1981.3 I 1105); average burnish; rim bottered but not milled; stem bore 8/64". (Pcode 05630)

85.05 Heel type bowl dating from c1640-1660 from 1-2 Tower Street (Acc No. 1981.3 I 1105); good burnish; rim bottered but not milled; stem bore 7/64". (Pcode 05631)

85.06 Heel type bowl dating from c1640-1660 from 1-2 Tower Street (Acc No. 1981.3 III 3103); rim bottered and fully milled; stem bore 8/64". (Pcode 05651)

- 85.07 Heel type bowl dating from c1640-1660 from 1-2 Tower Street (Acc No. 1981.3 I 1105); rim bottered but not milled; stem bore 7/64". (Pcode 05632)
- 85.08 Heel type bowl dating from c1650-1670 from 1-2 Tower Street (Acc No. 1981.3 I 1105); rim bottered but not milled; stem bore 7/64". (Pcode 05628)
- 85.09 Heel type bowl dating from c1650-1670 from 1-2 Tower Street (Acc No. 1981.3 III 3032); rim bottered but not milled; stem bore 6/64". (Pcode 05647)
- 85.10 Heel type bowl dating from c1650-1670 from 1-2 Tower Street (Acc No. 1982.3 1405); rim bottered but not milled. (Pcode 05653)
- 85.11 Heel type bowl dating from c1650-1670 from 1-2 Tower Street (Acc No. 1981.3 I 1286); rim bottered but not milled; stem bore 8/64". (Pcode 05639)
- 85.12 Heel type bowl dating from c1650-1670 from 1-2 Tower Street (Acc No. 1981.3 I 1286); finely burnished; rim bottered but not milled; stem bore 7/64". Marked with the initials TB on the heel. (Pcode 01830)
- 85.13 Heel type bowl dating from c1650-1670 from 1-2 Tower Street (Acc No. 1981.3 I 1089); rim bottered and fully milled; stem bore 7/64". (Pcode 05627)
- 85.14 Heel type bowl dating from c1650-1670 from 1-2 Tower Street (Acc No. 1981.3 I 1087); rim bottered but not milled; stem bore 6/64". (Pcode 05626)
- 85.15 Heel type bowl dating from c1650-1670 from 1-2 Tower Street (Acc No. 1981.3 III 3197); rim internally trimmed and bottered but not milled; stem bore 8/64". (Pcode 05652)
- 85.16 Heel type bowl dating from c1650-1670 from 1-2 Tower Street (Acc No. 1981.3 I 1105); rim internally trimmed and bottered; milled around all of the surviving rim; stem bore 6/64". Milled heel. (Pcode 01836)
- 85.17 Heel type bowl dating from c1650-1670 from 1-2 Tower Street (Acc No. 1981.3 I 1105); poorly burnished; rim bottered but not milled; stem bore 6/64". (Pcode 05629)
- 85.18 Heel type bowl dating from c1650-1670 from 1-2 Tower Street (Acc No. 1981.3 I 1063); poorly burnished; rim bottered but not milled; stem bore 6/64". Marked with the initials IB on the heel. (Pcode 01818)
- 85.19 Heel type bowl dating from c1660-1680 from 1-2 Tower Street (Acc No. 1981.3 I 1107); rim bottered but not milled; stem bore 6/64". (Pcode 05636)
- 85.20 Heel type bowl dating from c1660-1680 from 1-2 Tower Street (Acc No. 1981.3 I U/S); rim bottered and one quarter milled; stem bore 8/64". Bowl wiped. (Pcode 05643)

- 86.01 Heel type bowl dating from c1650-1670 from 1-2 Tower Street (Acc No. 1981.3 I U/S); average burnish; rim internally trimmed, bottered and fully milled; stem bore 8/64". Marked with the initials AB on the heel. (Pcode 01838)
- 86.02 Heel type bowl dating from c1650-1670 from 1-2 Tower Street (Acc No. 1981.3 1007); finely burnished; rim bottered; milled around all of the surviving rim; stem bore 7/64". Marked with the initials AB on the heel. (Pcode 01826)
- 86.03 Heel type bowl dating from c1660-1680 from 1-2 Tower Street (Acc No. 1981.3 3002); poorly burnished; rim bottered and one quarter milled; stem bore 8/64". Marked with the initials AB on the heel. (Pcode 01827)
- 86.04 Heel type bowl dating from c1660-1680 from 1-2 Tower Street (Acc No. 1981.3 I 1063); poorly burnished; rim internally trimmed, bottered and one quarter milled; stem bore 6/64". Marked with the initials AB on the heel. (Pcode 01817)
- 86.05 Heel type bowl dating from c1660-1680 from 1-2 Tower Street (Acc No. 1981.3 III 3032); finely burnished; rim bottered and three quarters milled; stem bore 6/64". Marked with the initials ?WM on the heel. (Pcode 01823)
- 86.06 Heel type bowl dating from c1650-1670 from 1-2 Tower Street (Acc No. 1981.3 I 1046); poorly burnished; rim bottered but not milled; stem bore 8/64". Marked with the initials I- on the heel. (Pcode 01825)
- 86.07 Heel type bowl dating from c1660-1690 from 1-2 Tower Street (Acc No. 1981.3 III 3052); rim bottered and half milled; stem bore 7/64". (Pcode 05648)
- 86.08 Heel type bowl dating from c1660-1690 from 1-2 Tower Street (Acc No. 1981.3 III 3103); rim bottered and half milled; stem bore 7/64". Marked with the initials ID on the heel. (Pcode 01833)
- 86.09 Heel type bowl dating from c1660-1680 from 1-2 Tower Street (Acc No. 1982.3 1409); average burnish; rim bottered and half milled; stem bore 6/64". Marked with the initials RS on the heel. (Pcode 01828)
- 86.10 Heel type bowl dating from c1660-1680 from 1-2 Tower Street (Acc No. 1981.3 III 3002); rim bottered and one quarter milled; stem bore 8/64". Milled heel. (Pcode 05645)
- 86.11 Heel type bowl dating from c1660-1690 from 1-2 Tower Street (Acc No. 1981.3 I U/S); average burnish; rim bottered; milled around all of the surviving rim; stem bore 7/64". Marked with the initials RB on the heel. (Pcode 01829)

- 86.12 Heel type bowl dating from c1650-1670 from 1-2 Tower Street (Acc No. 1981.3 1003); poorly burnished; rim bottered and fully milled; stem bore 8/64". Marked with the initials WM on the heel. (Pcode 01822)
- 87.01 Heel type bowl dating from c1670-1680 from 1-2 Tower Street (Acc No. 1981.3); average burnish; rim internally trimmed, bottered and one quarter milled; stem bore 6/64". Marked with the initials RB on the heel. (Pcode 01820)
- 87.02 Heel type bowl dating from c1680-1710 from 1-2 Tower Street (Acc No. 1981.3 1007); rim internally trimmed and bottered but not milled; stem bore 5/64". (Pcode 05624)
- 87.03 Bowl dating from c1680-1710 from 1-2 Tower Street (Acc No. 1981.3 1007); rim bottered but not milled. (Pcode 05623)
- 87.04 Heel type bowl dating from c1680-1710 from 1-2 Tower Street (Acc No. 1981.3 III 3052); rim bottered and half milled; stem bore 6/64". Marked with the initials RS on the heel. (Pcode 01832)
- 87.05 Heel type bowl dating from c1680-1710 from 1-2 Tower Street (Acc No. 1981.3 I 1107); finely burnished; no rim surviving. Marked with the initials ID on the heel. No rim surviving. (Pcode 01839)
- 87.06 Heel type bowl dating from c1680-1700 from 1-2 Tower Street (Acc No. 1981.3 I 1107); finely burnished; rim internally trimmed, bottered and half milled; stem bore 6/64". Marked with the initials IS on the heel. S on stamp is reversed. (Pcode 01831)
- 87.07 Heel type bowl dating from c1690-1720 from 1-2 Tower Street (Acc No. 1981.3 I 1069); finely burnished; no rim surviving; stem bore 6/64". Marked with the initials IS on the heel. No rim surviving. (Pcode 01840)
- 87.08 Heel type bowl dating from c1680-1710 (Acc No. 1981.3 3000); rim bottered and one quarter milled; stem bore 5/64". Marked with the initials RS on the heel. (Pcode 01824)
- 87.09 Heel type bowl dating from c1680-1710 from 1-2 Tower Street (Acc No. 1981.3 III 3016); rim bottered and one quarter milled; stem bore 7/64". Marked with the initials RS on the heel. (Pcode 01819)
- 87.10 Heel type bowl dating from c1690-1720 from 1-2 Tower Street (Acc No. 1981.3 III 3041); no rim surviving; stem bore 8/64". Marked with the initials -D on the heel. Possible ID mark; No rim surviving. (Pcode 01834)
- 87.11 Spur type bowl dating from c1760-1800 from 1-2 Tower Street (Acc No. 1981.3 I U/S); rim cut and internally trimmed but not milled; stem bore 3/64". (Pcode 05642)

- 87.12 Heel type bowl dating from c1690-1710 from 1-2 Tower Street (Acc No. 1981.3 I 1286); rim bottered but not milled; stem bore 5/64". Marked with the initials IS on the heel. (Pcode 01835)
- 87.13 Heel type bowl dating from c1700-1730 from 1-2 Tower Street (Acc No. 1981.3 I 1107); rim cut but not milled; stem bore 5/64". (Pcode 05635)
- 87.14 Heel type bowl dating from c1730-1760 from 1-2 Tower Street (Acc No. 1981.3 I U/S); rim cut but not milled; stem bore 4/64". Marked with the initials RW on the sides of the heel. (Pcode 05641)
- 88.01 Heel type bowl dating from c1620-1640 from 12-18 Swinegate (Acc No. 1990.28 1000); very finely burnished; rim bottered; milled around all of the surviving rim. (Pcode 05678)
- 88.02 Heel type bowl dating from c1640-1660 from 12-18 Swinegate (Acc No. 1990.28 1127); rim bottered and fully milled. (Pcode 05681)
- 88.03 Heel type bowl dating from c1640-1660 from 12-18 Swinegate (Acc No. 1990.28 1073); rim bottered but not milled. (Pcode 05680)
- 88.04 Heel type bowl dating from c1650-1670 from 12-18 Swinegate (Acc No. 1990.28 1000); rim internally trimmed, bottered and fully milled. (Pcode 05677)
- 88.05 Heel type bowl dating from c1660-1680 from 12-18 Swinegate (Acc No. 1990.28 1000); good burnish; rim bottered but not milled. No heel. (Pcode 05679)
- 88.06 Heel type bowl dating from c1660-1670 from 13-17 Coney Street (Acc No. 1991.3 4003); average burnish; rim bottered but not milled; stem bore 8/64". (Pcode 05692)
- 88.07 Heel type bowl dating from c1650-1670 from 13-17 Coney Street (Acc No. 1991.3 4003); rim bottered but not milled. (Pcode 05691)
- 88.08 Heel type bowl dating from c1660-1680 from 13-17 Coney Street (Acc No. 1991.3 4003); rim bottered and three quarters milled; stem bore 8/64". (Pcode 05693)
- 88.09 Heel type bowl dating from c1660-1680 from 13-17 Coney Street (Acc No. 1991.3 4003); finely burnished; rim bottered and three quarters milled; stem bore 8/64". Marked with the initials AB on the heel. (Pcode 01789)
- 88.10 Heel type bowl dating from c1660-1690 from 13-17 Coney Street (Acc No. 1991.3 4003); rim bottered and three quarters milled. (Pcode 05694)
- 88.11 Heel type bowl dating from c1660-1690 from 13-17 Coney Street (Acc No. 1991.3 4003); average burnish; rim bottered and three quarters milled. Marked with the initials AB on the heel. (Pcode 05696)

- 88.12 Heel type bowl dating from c1680-1710 from 13-17 Coney Street (Acc No. 1991.3 1010); rim internally trimmed, bottered and one quarter milled; stem bore 6/64". Marked with the initials AB on the heel. (Pcode 01792)
- 88.13 Heel type bowl dating from c1680-1710 from 13-17 Coney Street (Acc No. 1991.3 1010); rim internally trimmed, bottered and half milled. Marked with the initials AB on the heel. (Pcode 01790)
- 88.14 Heel type bowl dating from c1680-1710 from 13-17 Coney Street (Acc No. 1991.3 1010); rim internally trimmed, bottered and one quarter milled; stem bore 5/64". Marked with the initials AB on the heel. (Pcode 01791)
- 88.15 Heel type bowl dating from c1680-1710 from 13-17 Coney Street (Acc No. 1991.3 1010); rim bottered and one quarter milled; stem bore 5/64". Marked with the initials AB on the heel. (Pcode 01793)
- 89.01 Heel type bowl dating from c1680-1710 from 13-17 Coney Street (Acc No. 1991.3 1010); rim internally trimmed, bottered and one quarter milled; stem bore 5/64". Marked with the initials AB on the heel. (Pcode 01794)
- 89.02 Heel type bowl dating from c1700-1730 from 13-17 Coney Street (Acc No. 1991.3 U/S); rim cut and internally trimmed but not milled; stem bore 5/64". Marked with the initials AB on the heel. (Pcode 01798)
- 89.03 Heel type bowl dating from c1710-1740 from 13-17 Coney Street (Acc No. 1991.3 4026); rim cut but not milled; stem bore 5/64". Marked with the initials WR on the sides of the heel. Very roughly made; slightly flared heel. (Pcode 05697)
- 89.04 Heel type bowl dating from c1620-1640 from 14 Little Stonegate (Acc No. 1990.1 4000); average burnish; rim bottered and fully milled. Marked with the initials SBC on the heel. (Pcode 03430)
- 89.05 Heel type bowl dating from c1640-1660 from 14 Little Stonegate (Acc No. 1990.1 4029); rim bottered; milled around all of the surviving rim. (Pcode 05707)
- 89.06 Heel type bowl dating from c1650-1670 from 4 Little Stonegate (Acc No. 1990.1 4000); rim internally trimmed and bottered but not milled. (Pcode 05706)
- 89.07 Heel type bowl dating from c1650-1670 from 14-20 Blossom Street (Acc No. 1991.11 2013); rim bottered and fully milled. Yellow coloured clay. (Pcode 05704)
- 89.08 Heel type bowl dating from c1650-1680 from 14-20 Blossom Street (Acc No. 1991.11 2007); rim bottered and three quarters milled. (Pcode 05699)

- 89.09 Heel type bowl dating from c1660-1680 from 14-20 Blossom Street (Acc No. 1991.11 2007); rim bottered but not milled. (Pcode 05700)
- 89.10 Heel type bowl dating from c1660-1680 from 14-20 Blossom Street (Acc No. 1991.11 2007); rim bottered; milled around all of the surviving rim. (Pcode 05701)
- 89.11 Heel type bowl dating from c1660-1690 from 14-20 Blossom Street (Acc No. 1991.11 2007); no rim surviving. (Pcode 05702)
- 89.12 Heel type bowl dating from c1640-1680 from 14-20 Blossom Street (Acc No. 1994.11); average burnish; no rim surviving. Marked with the initials -H on the heel. No rim surviving. (Pcode 03454)
- 89.13 Heel type bowl dating from c1660-1690 from 14-20 Blossom Street (Acc No. 1991.11 2007); no rim surviving. Marked with the initials IH on the heel. No rim surviving. (Pcode 03434)
- 89.14 Heel type bowl dating from c1660-1690 from 14-20 Blossom Street (Acc No. 1991.11 2007); rim bottered and half milled. Marked with the initials AB on the heel. (Pcode 03435)
- 89.15 Heel type bowl dating from c1710-1740 from 14-20 Blossom Street (Acc No. 1991.11 2007); no rim surviving. (Pcode 05698)
- 90.01 Heel type bowl dating from c1660-1680 from 1-9 Bridge Street (Acc No. 1985.17 1003); average burnish; rim bottered but not milled; stem bore 6/64". Marked with the crowned initials SH on the heel. (Pcode 01954)
- 90.02 Heel type bowl dating from c1640-1660 from 2 Coffee Yard (Acc No. 1991.18 8107); rim bottered but not milled. (Pcode 05817)
- 90.03 Heel type bowl dating from c1660-1680 from 2 Coffee Yard (Acc No. 1991.18 7016); rim bottered but not milled. Very highly fired ?waster. (Pcode 05816)
- 90.04 Heel type bowl dating from c1660-1680 from 2 Coffee Yard (Acc No. 1991.18 U/S); rim internally trimmed and bottered but not milled. (Pcode 05820)
- 90.05 Heel type bowl dating from c1660-1680 from 2 Coffee Yard (Acc No. 1991.18 6003); rim bottered but not milled. (Pcode 05814)
- 90.06 Heel type bowl dating from c1670-1700 from 2 Coffee Yard (Acc No. 1991.18 U/S); rim bottered but not milled. (Pcode 05821)
- 90.07 Heel type bowl dating from c1700-1730 from 2 Coffee Yard (Acc No. 1991.18 8129); rim cut but not milled. (Pcode 05818)



- 90.08 Heel type bowl dating from c1700-1730 from 2 Coffee Yard (Acc No. 1991.18 8129); rim cut but not milled. (Pcode 05819)
- 90.09 Heel type bowl dating from c1640-1660 from Coffee Yard (Acc No. 1987.1 IV 4006); rim bottered; milled around all of the surviving rim. (Pcode 05499)
- 90.10 Heel type bowl dating from c1640-1660 from Coffee Yard (Acc No. 1987.1 4006); rim bottered but not milled. (Pcode 05487)
- 90.11 Heel type bowl dating from c1640-1660 from Coffee Yard (Acc No. 1987.1 IV 4006); rim bottered; milled around all of the surviving rim. (Pcode 05500)
- 90.12 Heel type bowl dating from c1640-1660 from Coffee Yard (Acc No. 1987.1 IV 4003); rim bottered but not milled. (Pcode 05496)
- 90.13 Heel type bowl dating from c1640-1660 from Coffee Yard (Acc No. 1987.1 IV 4003); rim bottered but not milled; stem bore 8/64". (Pcode 05497)
- 91.01 Heel type bowl dating from c1640-1670 from Coffee Yard (Acc No. 1987.1 2057); rim bottered and three quarters milled; stem bore 7/64". (Pcode 05473)
- 91.02 Heel type bowl dating from c1640-1670 from Coffee Yard (Acc No. 1987.1 2051); rim bottered but not milled; stem bore 6/64". Bowl possibly wiped. (Pcode 05470)
- 91.03 Heel type bowl dating from c1650-1670 (Acc No. 1987.1 2057); rim bottered but not milled. (Pcode 05471)
- 91.04 Heel type bowl dating from c1650-1670 from Coffee Yard (Acc No. 1987.1 II 2043); rim bottered but not milled; stem bore 7/64". Bowl possibly wiped. (Pcode 05489)
- 91.05 Heel type bowl dating from c1650-1670 from Coffee Yard (Acc No. 1987.1 II 2043); rim bottered but not milled. (Pcode 05490)
- 91.06 Heel type bowl dating from c1650-1670 from Coffee Yard (Acc No. 1987.1 IV 4006); rim bottered but not milled. (Pcode 05498)
- 91.07 Heel type bowl dating from c1650-1680 from Coffee Yard (Acc No. 1987.1 4006); no rim surviving. No rim surviving. (Pcode 05486)
- 91.08 Heel type bowl dating from c1640-1670 from Coffee Yard (Acc No. 1987.1 2057); finely burnished; rim bottered but not milled; stem bore 7/64". (Pcode 05472)
- 91.09 Heel type bowl dating from c1650-1670 from Coffee Yard (Acc No. 1987.1 2057); rim bottered but not milled. (Pcode 05479)

- 91.10 Heel type bowl dating from c1640-1670 from Coffee Yard (Acc No. 1987.1 2057); rim bottered but not milled; stem bore 8/64". (Pcode 05477)
- 91.11 Heel type bowl dating from c1660-1680 from Coffee Yard (Acc No. 1987.1 2057); average burnish; rim bottered and fully milled. (Pcode 05483)
- 91.12 Heel type bowl dating from c1640-1670 from Coffee Yard (Acc No. 1987.1 2057); rim bottered but not milled; stem bore 8/64". (Pcode 05476)
- 91.13 Heel type bowl dating from c1650-1670 from Coffee Yard (Acc No. 1987.1 2057); poorly burnished; rim bottered and fully milled; stem bore 8/64". Only part of the border of a heel mark survive. (Pcode 05481)
- 91.14 Heel type bowl dating from c1650-1670 from Coffee Yard (Acc No. 1987.1 2057); very finely burnished; rim bottered and half milled; stem bore 8/64". (Pcode 05480)
- 91.15 Heel type bowl dating from c1660-1680 from Coffee Yard (Acc No. 1987.1 II 2043); finely burnished; rim bottered and half milled; stem bore 8/64". (Pcode 05491)
- 92.01 Heel type bowl dating from c1660-1680 from Coffee Yard (Acc No. 1987.1 III 3009); rim bottered but not milled. (Pcode 05494)
- 92.02 Heel type bowl dating from c1680-1710 from Coffee Yard (Acc No. 1987.1 II 2122); rim bottered but not milled. Mark on the heel covered with iron concretions - totally illegible. (Pcode 05493)
- 92.03 Heel type bowl dating from c1620-1640 from 21-33 Aldwark (Acc No. 1973.5 VI 14); finely burnished; rim bottered and fully milled; stem bore 8/64". Marked with the initials GW on the heel. (Pcode 01908)
- 92.04 Heel type bowl dating from c1640-1660 from 21-33 Aldwark (Acc No. 1973.5 VI 6); rim internally trimmed, bottered and fully milled; stem bore 6/64". Milled heel. (Pcode 05660)
- 92.05 Heel type bowl dating from c1620-1640 from 21-33 Aldwark (Acc No. 1973.5 VI 6); rim bottered; milled around all of the surviving rim; stem bore 8/64". (Pcode 05661)
- 92.06 Heel type bowl dating from c1640-1660 from 21-33 Aldwark (Acc No. 1973.5 VII 1022); finely burnished; rim bottered and fully milled; stem bore 7/64". (Pcode 05669)
- 92.07 Heel type bowl dating from c1640-1660 from 21-33 Aldwark (Acc No. 1973.5 VI 75); average burnish; rim bottered and fully milled; stem bore 7/64". (Pcode 05663)

- 92.08 Heel type bowl dating from c1640-1660 from 21-33 Aldwark (Acc No. 1973.5 VI 83); rim bottered but not milled; stem bore 8/64". (Pcode 05667)
- 92.09 Heel type bowl dating from c1640-1660 from 21-33 Aldwark (Acc No. 1973.5 VI 16); rim bottered and fully milled; stem bore 6/64". (Pcode 05656)
- 92.10 Heel type bowl dating from c1640-1660 from 21-33 Aldwark (Acc No. 1973.5 VI 11); rim bottered and three quarters milled; stem bore 9/64". (Pcode 05655)
- 92.11 Heel type bowl dating from c1640-1660 from 21-33 Aldwark (Acc No. 1973.5 VII 1171); rim bottered and half milled; stem bore 8/64". (Pcode 05670)
- 92.12 Heel type bowl dating from c1650-1670 from 21-33 Aldwark (Acc No. 1973.5 VI 72); rim bottered and fully milled; stem bore 7/64". (Pcode 05662)
- 92.13 Heel type bowl dating from c1650-1699 from 21-33 Aldwark (Acc No. 1973.5 VII 1001); no rim surviving; stem bore 5/64". Marked with the initials D on the heel. (Pcode 01888)
- 92.14 Heel type bowl dating from c1660-1680 from 21-33 Aldwark (Acc No. 1973.5 VI 107); average burnish; rim bottered and three quarters milled; stem bore 8/64". Marked with the initials AB on the heel. (Pcode 01873)
- 92.15 Heel type bowl dating from c1660-1680 from 21-33 Aldwark (Acc No. 1973.5 VI 75); average burnish; rim bottered and fully milled; stem bore 7/64". Marked with the initials IW on the heel. (Pcode 01898)
- 92.16 Heel type bowl dating from c1660-1680 from 21-33 Aldwark (Acc No. 1973.5 VI 72); average burnish; rim bottered and half milled; stem bore 6/64". Marked with the initials IB flanking a Tudor rose on the heel. (Pcode 01885)
- 92.17 Heel type bowl dating from c1660-1680 from 21-33 Aldwark (Acc No. 1973.5 VI 89); average burnish; rim bottered and fully milled; stem bore 6/64". Marked with the initials IS on the heel. (Pcode 01913)
- 93.01 Heel type bowl dating from c1660-1680 from 21-33 Aldwark (Acc No. 1973.5 VI 72); poorly burnished; rim bottered and three quarters milled; stem bore 8/64". Marked with the initials IW on the heel. (Pcode 01909)
- 93.02 Heel type bowl dating from c1660-1680 from 21-33 Aldwark (Acc No. 1973.5 VI 29); rim bottered; milled around all of the surviving rim; stem bore 7/64". Marked with the initials IW on the heel. (Pcode 01907)

- 93.03 Heel type bowl dating from c1660-1680 from 21-33 Aldwark (Acc No. 1973.5 VI 72); average burnish; rim bottered and fully milled; stem bore 7/64". Marked with the initials IW on the heel. (Pcode 01899)
- 93.04 Heel type bowl dating from c1660-1680 from 21-33 Aldwark (Acc No. 1973.5 VI 80); average burnish; rim bottered and three quarters milled; stem bore 7/64". Marked with the initials WM on the heel. (Pcode 01897)
- 93.05 Heel type bowl dating from c1660-1680 from 21-33 Aldwark (Acc No. 1974.5 VII 741); poorly burnished; rim bottered and one quarter milled; stem bore 8/64". Marked with the initials WM on the heel. (Pcode 01911)
- 93.06 Heel type bowl dating from c1660-1680 from 21-33 Aldwark (Acc No. 1973.5 VII 1001); poorly burnished; rim internally trimmed, bottered and one quarter milled; stem bore 7/64". Marked with the initials RS on the heel. (Pcode 01902)
- 93.07 Heel type bowl dating from c1660-1680 from 21-33 Aldwark (Acc No. 1973.5 VII 1193); average burnish; rim bottered and half milled; stem bore 7/64". Marked with the initials RS on the heel. (Pcode 01903)
- 93.08 Heel type bowl dating from c1660-1680 from 21-33 Aldwark (Acc No. 1973.5 VI 75); rim bottered and three quarters milled; stem bore 7/64". Milled heel. Bowl wiped. (Pcode 01916)
- 93.09 Heel type bowl dating from c1660-1690 from 21-33 Aldwark (Acc No. 1973.5 VI 75); rim bottered; milled around all of the surviving rim; stem bore 8/64". (Pcode 05664)
- 93.10 Heel type bowl dating from c1660-1690 from 21-33 Aldwark (Acc No. 1973.5 VI 75); rim bottered and fully milled; stem bore 7/64". (Pcode 05665)
- 93.11 Heel type bowl dating from c1660-1680 from 21-33 Aldwark (Acc No. 1973.5 VI 75); average burnish; rim bottered but not milled; stem bore 7/64". Marked with the initials AB on the heel. (Pcode 01869)
- 93.12 Heel type bowl dating from c1660-1680 from 21-33 Aldwark (Acc No. 1973.5 VI 14); average burnish; rim bottered and one quarter milled; stem bore 7/64". Marked with the initials AB on the heel. (Pcode 01863)
- 93.13 Heel type bowl dating from c1660-1690 from 21-33 Aldwark (Acc No. 1973.5 VII 405); average burnish; rim bottered and three quarters milled; stem bore 7/64". Marked with the initials AB on the heel. (Pcode 01866)
- 93.14 Heel type bowl dating from c1660-1680 from 21-33 Aldwark (Acc No. 1973.5 VI 14); finely burnished; rim bottered; milled around all of the surviving rim; stem bore 7/64". Marked with the initials IB on the heel. (Pcode 01879)

- 93.15 Heel type bowl dating from c1660-1680 from 21-33 Aldwark (Acc No. 1973.5 VI 83); average burnish; no rim surviving; stem bore 7/64". Marked with the initials AB on the heel. No rim surviving. (Pcode 01874)
- 94.01 Heel type bowl dating from c1660-1690 from 21-33 Aldwark (Acc No. 1973.5 VI 84); average burnish; rim bottered and three quarters milled; stem bore 9/64". Marked with the initials RF on the heel. (Pcode 01889)
- 94.02 Heel type bowl dating from c1660-1690 from 21-33 Aldwark (Acc No. 1973.5 VII 1001); average burnish; rim bottered and half milled; stem bore 7/64". Marked with the initials RF on the heel. (Pcode 01890)
- 94.03 Heel type bowl dating from c1660-1690 from 21-33 Aldwark (Acc No. 1973.5 V 2000); average burnish; rim bottered but not milled; stem bore 7/64". Marked with the initials RB on the heel. (Pcode 01881)
- 94.04 Heel type bowl dating from c1660-1690 from 21-33 Aldwark (Acc No. 1973.5 VI 75); poorly burnished; rim bottered but not milled; stem bore 7/64". Marked with the initials WM on the heel. (Pcode 01894)
- 94.05 Heel type bowl dating from c1660-1680 from 21-33 Aldwark (Acc No. 1973.5 VI 14); good burnish; rim bottered and fully milled; stem bore 6/64". Marked with the initials WM on the heel. (Pcode 01892)
- 94.06 Heel type bowl dating from c1660-1690 from 21-33 Aldwark (Acc No. 1973.5 VI 75); average burnish; rim bottered but not milled; stem bore 8/64". Marked with the initials WM on the heel. (Pcode 01906)
- 94.07 Heel type bowl dating from c1670-1680 from 21-33 Aldwark (Acc No. 1973.5 VII 1001); average burnish; rim bottered and one quarter milled. Marked with the initials RB on the heel. (Pcode 01884)
- 94.08 Heel type bowl dating from c1670-1680 from 21-33 Aldwark (Acc No. 1973.5 VI 74); average burnish; rim bottered and three quarters milled; stem bore 6/64". Marked with the initials WM on the heel. (Pcode 01895)
- 94.09 Heel type bowl dating from c1680-1710 from 21-33 Aldwark (Acc No. 1973.5 V 2000); no rim surviving; stem bore 6/64". Marked with the initials RS on the heel. No rim surviving. (Pcode 01905)
- 94.10 Heel type bowl dating from c1690-1720 from 21-33 Aldwark (Acc No. 1973.5 VII 1001); average burnish; rim wiped; one quarter milled; stem bore 5/64". Marked with the initials ID on the heel. (Pcode 01886)
- 94.11 Heel type bowl dating from c1710-1740 from 21-33 Aldwark (Acc No. 1973.5 IV 1414); good burnish; rim cut but not milled. (Pcode 05654)
- 95.01 Heel type bowl dating from c1640-1660 from 23 Clifford Street (Acc No. 1990.8 1015); rim bottered; milled around all of the surviving rim. (Pcode 05708)

- 95.02 Heel type bowl dating from c1650-1670 from 23 Clifford Street (Acc No. 1990.8 3009); rim bottered but not milled. (Pcode 05712)
- 95.03 Heel type bowl dating from c1660-1680 (Acc No. 1990.8 2029); rim bottered but not milled. (Pcode 05710)
- 95.04 Heel type bowl dating from c1660-1680 from 23 Clifford Street (Acc No. 1990.8 1004); average burnish; rim bottered; milled around all of the surviving rim. Marked with the initials IS on the heel. (Pcode 03451)
- 95.05 Heel type bowl dating from c1680-1710 from 23 Clifford Street (Acc No. 1990.8 2029); rim bottered and one quarter milled. Marked with the initials AB on the heel. (Pcode 01963)
- 95.06 Spur type bowl dating from c1760-1800 from 23 Clifford Street (Acc No. 1990.8 4006); rim cut but not milled. (Pcode 05716)
- 95.07 Heel type bowl dating from c1620-1640 from 37 Bishopshill Senior (Acc No. 1973.15 Ic 10022); rim bottered and fully milled. (Pcode 05722)
- 95.08 Heel type bowl dating from c1620-1640 from 37 Bishopshill Senior (Acc No. 1973.15 Ic 10000); rim bottered; milled around all of the surviving rim. (Pcode 05721)
- 95.09 Heel type bowl dating from c1640-1660 from 37 Bishopshill Senior (Acc No. 1973.15 Iic 10106); rim bottered but not milled. (Pcode 05726)
- 95.10 Heel type bowl dating from c1640-1660 from 37 Bishopshill Senior (Acc No. 1973.15 I 10022); rim bottered and three quarters milled. Marked with the initials WS on the heel. (Pcode 03449)
- 95.11 Heel type bowl dating from c1640-1660 from 37 Bishopshill Senior (Acc No. 1973.15 IV 10310); finely burnished; rim bottered and fully milled. (Pcode 05727)
- 95.12 Heel type bowl dating from c1650-1670 from 37 Bishopshill Senior (Acc No. 1973.15 IV 10325); rim bottered but not milled. (Pcode 05728)
- 95.13 Heel type bowl dating from c1650-1670 from 37 Bishopshill Senior (Acc No. 1973.15 Ic 10134); rim bottered but not milled. (Pcode 05723)
- 95.14 Heel type bowl dating from c1650-1670 from 37 Bishopshill Senior (Acc No. 1973.15 I 10128); rim bottered and three quarters milled. (Pcode 05720)
- 96.01 Heel type bowl dating from c1650-1670 from 37 Bishopshill Senior (Acc No. 1973.15 Ic 10134); good burnish; rim bottered but not milled. (Pcode 05724)

- 96.02 Heel type bowl dating from c1660-1680 from 37 Bishopshill Senior (Acc No. 1973.15 Ic 10134); average burnish; rim bottered but not milled. (Pcode 05725)
- 96.03 Heel type bowl dating from c1660-1680 from 37 Bishopshill Senior (Acc No. 1973.15 III 10204); average burnish; rim bottered but not milled. Marked with the initials IT on the heel. (Pcode 03450)
- 96.04 Heel type bowl dating from c1620-1640 from 5 Rougier Street (Acc No. 1981.12 U/S); rim bottered and fully milled; stem bore 7/64". (Pcode 05729)
- 96.05 Heel type bowl dating from c1660-1690 from 50 Piccadilly (Acc No. 1992.10 U/S); average burnish; no rim surviving. Marked with the initials R?B/E on the heel. No rim surviving. (Pcode 03413)
- 96.06 Heel type bowl dating from c1660-1680 from 84 Piccadilly (Acc No. 1991.16 U/S); average burnish; no rim surviving. Marked with the initials ID on the heel. No rim surviving. (Pcode 03444)
- 96.07 Heel type bowl dating from c1630-1650 from 57 Bootham (Acc No. 1992.7 1013); good burnish; rim bottered and fully milled. (Pcode 05740)
- 96.08 Heel type bowl dating from c1640-1660 from 57 Bootham (Acc No. 1992.7 1006); finely burnished; rim bottered but not milled. (Pcode 05732)
- 96.09 Heel type bowl dating from c1640-1660 from 57 Bootham (Acc No. 1992.7 1015); rim bottered; milled around all of the surviving rim. (Pcode 05742)
- 96.10 Heel type bowl dating from c1630-1650 from 57 Bootham (Acc No. 1992.7 1009); rim bottered; milled around all of the surviving rim. Marked with a wheel on the heel. (Pcode 03411)
- 96.11 Heel type bowl dating from c1650-1670 from 57 Bootham (Acc No. 1992.7 1006); rim bottered but not milled. (Pcode 05733)
- 96.12 Heel type bowl dating from c1650-1680 from 57 Bootham (Acc No. 1992.7 1007); no rim surviving. No rim surviving. (Pcode 05736)
- 96.13 Heel type bowl dating from c1660-1680 from 57 Bootham (Acc No. 1992.7 1006); rim bottered and three quarters milled. (Pcode 05735)
- 97.01 Heel type bowl dating from c1660-1680 from 57 Bootham (Acc No. 1992.7 1006); average burnish; rim internally trimmed, bottered and one quarter milled. Marked with the initials AB on the heel. (Pcode 03412)
- 97.02 Heel type bowl dating from c1660-1680 from 57 Bootham (Acc No. 1992.7 1011); rim bottered but not milled. (Pcode 05738)
- 97.03 Heel type bowl dating from c1700-1730 from 57 Bootham (Acc No. 1992.7 1009); no rim surviving. (Pcode 05737)

- 97.04 Bowl dating from c1680-1710 from 57 Bootham (Acc No. 1992.7 1013); rim bottered but not milled. No heel. (Pcode 05741)
- 97.05 Heel type bowl dating from c1620-1640 from 6-28/21-7 Union Terrace (Acc No. 1972.18 4030); poorly burnished; rim bottered and fully milled; stem bore 7/64". Marked with a wheel on the heel. (Pcode 01966)
- 97.06 Heel type bowl dating from c1620-1640 from 6-28/21-7 Union Terrace (Acc No. 1972.18 5060); average burnish; rim bottered and fully milled; stem bore 6/64". Marked with a wheel on the heel. (Pcode 01967)
- 97.07 Spur type bowl dating from c1620-1640 from 6-28/21-7 Union Terrace (Acc No. 1972.18 6060); rim possibly bottered; three quarters milled. (Pcode 05746)
- 97.08 Heel type bowl dating from c1650-1670 from 58-59 Skeldergate (Acc No. 1973.14 513); average burnish; rim bottered and three quarters milled; stem bore 6/64". Marked with the initials IM on the heel. (Pcode 01978)
- 97.09 Heel type bowl dating from c1620-1640 from 9 Blake Street (Acc No. 1975.6 U/S); rim bottered but not milled. Marked with the initials GW on the heel. Yellow coloured clay. (Pcode 03406)
- 97.10 Heel type bowl dating from c1640-1660 from 9 Blake Street (Acc No. 1975.6 U/S); poorly burnished; rim internally trimmed, bottered and fully milled. (Pcode 05824)
- 97.11 Heel type bowl dating from c1640-1660 from 9 Blake Street (Acc No. 1975.6 U/S); rim bottered but not milled. (Pcode 05826)
- 97.12 Heel type bowl dating from c1650-1670 from 9 Blake Street (Acc No. 1975.6 U/S); rim bottered but not milled. (Pcode 05823)
- 97.13 Heel type bowl dating from c1660-1680 from 9 Blake Street (Acc No. 1975.6 U/S); average burnish; rim bottered and one quarter milled. Marked with the initials ID on the heel. Very roughly made; slightly flared heel. (Pcode 03407)
- 97.14 Heel type bowl dating from c1660-1680 from 9 Blake Street (Acc No. 1975.6 U/S); rim wiped but not milled. Heel broken. (Pcode 05825)
- 97.15 Heel type bowl dating from c1660-1680 from 9 Blake Street (Acc No. 1975.6 U/S); good burnish; rim bottered and three quarters milled. Marked with the initials WM on the heel. (Pcode 03405)
- 97.16 Heel type bowl dating from c1660-1680 from 9 Blake Street (Acc No. 1975.6 U/S); good burnish; rim bottered and one quarter milled. Marked with the initials RB on the heel. (Pcode 03408)



- 97.17 Heel type bowl dating from c1680-1710 from 9 Blake Street (Acc No. 1975.6 U/S); rim internally trimmed and bottered but not milled. (Pcode 05827)
- 98.01 Heel type bowl dating from c1640-1660 from Albion Wharf (Acc No. 1989.1 2250); rim bottered but not milled; stem bore 7/64". (Pcode 05846)
- 98.02 Heel type bowl dating from c1640-1660 from Albion Wharf (Acc No. 1989.1 2250); rim bottered but not milled; stem bore 8/64". (Pcode 05850)
- 98.03 Heel type bowl dating from c1640-1660 from Albion Wharf (Acc No. 1989.1 2037); rim bottered but not milled; stem bore 8/64". (Pcode 05837)
- 98.04 Heel type bowl dating from c1640-1660 from Albion Wharf (Acc No. 1989.1 2276); rim bottered but not milled; stem bore 7/64". (Pcode 05856)
- 98.05 Heel type bowl dating from c1640-1670 from Albion Wharf (Acc No. 1989.1 2276); rim bottered but not milled; stem bore 6/64". (Pcode 05854)
- 98.06 Heel type bowl dating from c1640-1670 from Albion Wharf (Acc No. 1989.1 2276); rim bottered but not milled; stem bore 7/64". (Pcode 05855)
- 98.07 Heel type bowl dating from c1650-1670 from Albion Wharf (Acc No. 1989.1 2081); rim bottered but not milled; stem bore 7/64". (Pcode 05839)
- 98.08 Heel type bowl dating from c1650-1670 from Albion Wharf (Acc No. 1989.1 2206); rim bottered but not milled; stem bore 8/64". (Pcode 05843)
- 98.09 Bowl dating from c1660-1680 from Albion Wharf (Acc No. 1989.1 2276); finely burnished; rim bottered but not milled; stem bore 4/64". (Pcode 05853)
- 98.10 Heel type bowl dating from c1660-1680 from Albion Wharf (Acc No. 1989.1 2276); average burnish; rim bottered; milled around all of the surviving rim; stem bore 7/64". Marked with the initials ID on the heel. (Pcode 01802)
- 98.11 Heel type bowl dating from c1660-1680 from Albion Wharf (Acc No. 1989.1 2108); rim bottered but not milled; stem bore 7/64". (Pcode 05840)
- 98.12 Heel type bowl dating from c1660-1680 from Albion Wharf (Acc No. 1989.1 1023); rim bottered and one quarter milled; stem bore 6/64". Plug of clay blocking the bore hole in the base of the bowl. (Pcode 05832)
- 98.13 Heel type bowl dating from c1660-1680 from Albion Wharf (Acc No. 1989.1 2250); average burnish; rim bottered and fully milled; stem bore 8/64". Marked with the initials IW on the heel. (Pcode 01842)

- 98.14 Heel type bowl dating from c1660-1680 from Albion Wharf (Acc No. 1989.1 1091); average burnish; rim wiped but not milled; stem bore 7/64". Marked with the initials TL on the heel. (Pcode 01800)
- 99.01 Heel type bowl dating from c1670-1700 from Albion Wharf (Acc No. 1989.1 1020); rim bottered and fully milled; stem bore 7/64". (Pcode 05830)
- 99.02 Heel type bowl dating from c1670-1680 from Albion Wharf (Acc No. 1989.1 2001); rim internally trimmed and bottered but not milled; stem bore 6/64". (Pcode 05834)
- 99.03 Heel type bowl dating from c1660-1680 from Albion Wharf (Acc No. 1989.1 2276); rim bottered and half milled; stem bore 6/64". (Pcode 05860)
- 99.04 Heel type bowl dating from c1670-1680 from Albion Wharf (Acc No. 1989.1 2250); rim bottered and half milled; stem bore 6/64". (Pcode 05848)
- 99.05 Heel type bowl dating from c1670-1700 from Albion Wharf (Acc No. 1989.1 2276); rim bottered but not milled; stem bore 5/64". (Pcode 05858)
- 99.06 Heel type bowl dating from c1670-1700 from Albion Wharf (Acc No. 1989.1 2276); rim bottered but not milled; stem bore 6/64". (Pcode 05859)
- 99.07 Heel type bowl dating from c1680-1710 from Albion Wharf (Acc No. 1989.1 2276); rim internally trimmed and bottered; milled around all of the surviving rim; stem bore 7/64". Marked with the initials RS on the heel. (Pcode 01801)
- 99.08 Heel type bowl dating from c1680-1710 from Albion Wharf (Acc No. 1989.1 2001); rim internally trimmed and bottered but not milled; stem bore 6/64". Marked with the initials AB on the heel. (Pcode 01843)
- 99.09 Heel type bowl dating from c1680-1710 from Albion Wharf (Acc No. 1989.1 2258); rim bottered and one quarter milled; stem bore 6/64". Marked with the initials AB on the heel. (Pcode 01844)
- 99.10 Heel type bowl dating from c1680-1710 from Albion Wharf (Acc No. 1989.1 1020); rim cut and internally trimmed but not milled; stem bore 5/64". Marked with the oval with line through centre. (Pcode 01845)
- 99.11 Heel type bowl dating from c1680-1710 from Albion Wharf (Acc No. 1989.1 2250); no rim surviving; stem bore 6/64". (Pcode 05849)
- 99.12 Heel type bowl dating from c1700-1730 from Albion Wharf (Acc No. 1989.1 2276); rim cut and internally trimmed but not milled; stem bore 4/64". (Pcode 05857)
- 100.01 Heel type bowl dating from c1710-1740 from Albion Wharf (Acc No. 1989.1 2250); rim cut but not milled; stem bore 6/64". (Pcode 05847)

- 100.02 Bowl dating from c1730-1760 from Albion Wharf (Acc No. 1989.1 2237); no rim surviving; stem bore 5/64". (Pcode 05845)
- 100.03 Heel type bowl dating from c1730-1760 from Albion Wharf (Acc No. 1989.1 2079); rim cut but not milled; stem bore 4/64". (Pcode 05838)
- 100.04 Heel type bowl dating from c1730-1760 from Albion Wharf (Acc No. 1989.1 2206); rim cut and internally trimmed but not milled; stem bore 5/64". (Pcode 05844)
- 100.05 Heel type bowl dating from c1620-1640 from Bedern Chapel (Acc No. 1980.20 II 9000); very finely burnished; rim bottered and fully milled; stem bore 8/64". Marked with a Tudor rose on the heel. (Pcode 01949)
- 100.06 Heel type bowl dating from c1650-1670 from the Barbican car park (Acc No. 1988.27 14025); rim bottered and one quarter milled. Marked with the initials ID on the heel. (Pcode 03438)
- 100.07 Heel type bowl dating from c1650-1670 from The Crown Court, York Castle (Acc No. 1989.7 1004); rim bottered but not milled; stem bore 8/64". (Pcode 05502)
- 100.08 Heel type bowl dating from c1650-1670 from The Crown Court, York Castle (Acc No. 1989.7 T1 U/S); poorly burnished; rim bottered and fully milled; stem bore 7/64". (Pcode 05508)
- 100.09 Heel type bowl dating from c1660-1680 from The Crown Court, York Castle (Acc No. 1989.7 1004); rim bottered and fully milled; stem bore 7/64". (Pcode 05504)
- 100.10 Heel type bowl dating from c1650-1680 from The Crown Court, York Castle (Acc No. 1989.7 1004); average burnish; rim bottered and half milled; stem bore 8/64". Marked with the initials IW on the heel. (Pcode 01661)
- 100.11 Heel type bowl dating from c1660-1680 from The Crown Court, York Castle (Acc No. 1989.7 2000); rim bottered and one quarter milled; stem bore 8/64". (Pcode 05506)
- 100.12 Heel type bowl dating from c1660-1690 from The Crown Court, York Castle (Acc No. 1989.7 1004); rim bottered and one quarter milled; stem bore 7/64". (Pcode 05505)
- 100.13 Heel type bowl dating from c1660-1680 from The Crown Court, York Castle (Acc No. 1989.7 2000); finely burnished; no rim surviving; stem bore 7/64". Marked with the initials IB flanking a crowned Tudor Rose on the heel. No rim surviving. (Pcode 01663)

- 101.01 Heel type bowl dating from c1660-1680 from The Crown Court, York Castle (Acc No. 1989.7 U/S); rim bottered and three quarters milled; stem bore 8/64". (Pcode 05509)
- 101.02 Heel type bowl dating from c1660-1680 from The Crown Court, York Castle (Acc No. 1989.7 2000); rim bottered but not milled; stem bore 8/64". (Pcode 05507)
- 101.03 Heel type bowl dating from c1660-1690 from The Crown Court, York Castle (Acc No. 1989.7 2000); no rim surviving; stem bore 8/64". Milled heel. No rim surviving. (Pcode 01667)
- 101.04 Heel type bowl dating from c1660-1690 from The Crown Court, York Castle (Acc No. 1989.7 U/S); average burnish; rim bottered; milled around all of the surviving rim; stem bore 6/64". Marked with the initials AB on the heel. (Pcode 01660)
- 101.05 Heel type bowl dating from c1660-1690 from The Crown Court, York Castle (Acc No. 1989.7 1004); average burnish; rim internally trimmed, bottered and one quarter milled; stem bore 8/64". Marked with the initials ID on the heel. (Pcode 01666)
- 101.06 Heel type bowl dating from c1660-1690 from The Crown Court, York Castle (Acc No. 1989.7 2000); average burnish; rim bottered; milled around all of the surviving rim; stem bore 8/64". Marked with the initials IW on the heel. (Pcode 01662)
- 101.07 Heel type bowl dating from c1660-1690 from The Crown Court, York Castle (Acc No. 1989.7 1004); rim bottered and half milled; stem bore 7/64". Milled heel. (Pcode 01659)
- 101.08 Heel type bowl dating from c1680-1710 from The Crown Court, York Castle (Acc No. 1989.7 2000); no rim surviving; stem bore 7/64". Marked with the initials II on the heel. No rim surviving. (Pcode 01664)
- 101.09 Heel type bowl dating from c1680-1710 from The Crown Court, York Castle (Acc No. 1989.7 1004); rim bottered but not milled; stem bore 6/64". Marked with the initials IS on the heel. (Pcode 01665)
- 101.10 Heel type bowl dating from c1700-1740 from The Crown Court, York Castle (Acc No. 1989.7 1004); rim I?B but not milled; stem bore 5/64". (Pcode 05503)
- 101.11 Heel type bowl dating from c1610-1620 from Judge's Lodging, Lendal (Acc No. 1983.45 1023); rim cut but not milled; stem bore 7/64". (Pcode 05554)
- 101.12 Heel type bowl dating from c1610-1620 from Judge's Lodging, Lendal (Acc No. 1983.45 1095); average burnish; no rim surviving; stem bore 7/64". No rim surviving. (Pcode 05598)

- 101.13 Heel type bowl dating from c1620-1640 from Judge's Lodging, Lendal (Acc No. 1983.45 1030); rim bottered and fully milled. (Pcode 05566)
- 101.14 Heel type bowl dating from c1620-1640 from Judge's Lodging, Lendal (Acc No. 1983.45 1076); finely burnished; rim bottered and fully milled; stem bore 7/64". (Pcode 05588)
- 102.01 Heel type bowl dating from c1620-1640 from Judge's Lodging, Lendal (Acc No. 1983.45 1076); rim bottered but not milled; stem bore 8/64". (Pcode 05589)
- 102.02 Heel type bowl dating from c1620-1640 from Judge's Lodging, Lendal (Acc No. 1983.45 1004); rim bottered and three quarters milled; stem bore 8/64". Marked with a Wheel motif on the heel. (Pcode 01770)
- 102.03 Heel type bowl dating from c1620-1640 from Judge's Lodging, Lendal (Acc No. 1983.45 1001); rim bottered and fully milled; stem bore 8/64". Marked with a Wheel motif on the heel. (Pcode 01738)
- 102.04 Heel type bowl dating from c1620-1640 from Judge's Lodging, Lendal (Acc No. 1983.45 1069); finely burnished; rim bottered and fully milled; stem bore 7/64". Marked with the initials TSK on the heel. Possibly Dutch. (Pcode 01672)
- 102.05 Heel type bowl dating from c1620-1640 from Judge's Lodging, Lendal (Acc No. 1983.45 1071); finely burnished; rim bottered and three quarters milled; stem bore 7/64". Marked with the initials WG on the heel. Same die as Pcode 1739 (Cast ref 459.46). (Pcode 01775)
- 102.06 Heel type bowl dating from c1620-1640 from Judge's Lodging, Lendal (Acc No. 1983.45 1017); finely burnished; rim bottered and fully milled; stem bore 8/64". Marked with the initials GW on the heel. (Pcode 01765)
- 102.07 Heel type bowl dating from c1620-1640 from Judge's Lodging, Lendal (Acc No. 1983.45 1054); very finely burnished; rim bottered; milled around all of the surviving rim; stem bore 8/64". Marked with the initials GW on the heel. (Pcode 05578)
- 102.08 Heel type bowl dating from c1620-1640 from Judge's Lodging, Lendal (Acc No. 1983.45 1095); rim bottered but not milled; stem bore 8/64". Marked with the initials GW on the heel. Very crudely made, heel rough and untrimmed but has been stamped. (Pcode 01763)
- 102.09 Heel type bowl dating from c1620-1640 from Judge's Lodging, Lendal (Acc No. 1983.45 1095); rim bottered and half milled; stem bore 7/64". Marked with the initials GW on the heel. (Pcode 01669)
- 102.10 Heel type bowl dating from c1620-1640 from Judge's Lodging, Lendal (Acc No. 1983.45 1095); finely burnished; rim bottered and fully milled; stem bore 7/64". Marked with the initials GW on the heel. (Pcode 01761)

- 102.11 Heel type bowl dating from c1620-1640 from Judge's Lodging, Lendal (Acc No. 1983.45 1095); very finely burnished; rim bottered and fully milled; stem bore 8/64". Marked with the initials GW on the heel. Very crudely made, heel rough and untrimmed but has been stamped. (Pcode 01755)
- 102.12 Heel type bowl dating from c1620-1640 from Judge's Lodging, Lendal (Acc No. 1983.45 1027); finely burnished; rim bottered and fully milled; stem bore 8/64". Marked with the initials GW on the heel. (Pcode 01778)
- 102.13 Heel type bowl dating from c1620-1640 from Judge's Lodging, Lendal (Acc No. 1983.45 1053); average burnish; rim bottered and fully milled; stem bore 8/64". Marked with the initials GW on the heel. (Pcode 01777)
- 102.14 Heel type bowl dating from c1640-1660 from Judge's Lodging, Lendal (Acc No. 1983.45 1005); average burnish; rim bottered but not milled; stem bore 6/64". Only part of the heel stamp's border survives. (Pcode 05520)
- 102.15 Heel type bowl dating from c1640-1660 from Judge's Lodging, Lendal (Acc No. 1983.45 1095); milled around all of the surviving rim; stem bore 7/64". Very badly abraded; stamped heel mark very faint. (Pcode 01780)
- 102.16 Heel type bowl dating from c1620-1640 from Judge's Lodging, Lendal (Acc No. 1983.45 1076); rim bottered; milled around all of the surviving rim; stem bore 6/64". Milled stem. (Pcode 05590)
- 102.17 Heel type bowl dating from c1640-1660 from Judge's Lodging, Lendal (Acc No. 1983.45 1027); rim bottered and fully milled; stem bore 7/64". (Pcode 05558)
- 102.18 Heel type bowl dating from c1620-1640 from Judge's Lodging, Lendal (Acc No. 1983.45 1053); rim bottered and fully milled; stem bore 8/64". (Pcode 05577)
- 102.19 Heel type bowl dating from c1620-1640 from Judge's Lodging, Lendal (Acc No. 1983.45 1020); rim internally trimmed and bottered but not milled; stem bore 8/64". (Pcode 05553)
- 102.20 Heel type bowl dating from c1640-1660 from Judge's Lodging, Lendal (Acc No. 1983.45 1076); rim bottered and fully milled; stem bore 7/64". (Pcode 05587)
- 103.01 Heel type bowl dating from c1640-1660 from Judge's Lodging, Lendal (Acc No. 1983.45 1095); finely burnished; rim bottered and fully milled; stem bore 8/64". (Pcode 05596)
- 103.02 Heel type bowl dating from c1640-1660 from Judge's Lodging, Lendal (Acc No. 1983.45 1095); rim bottered and fully milled; stem bore 9/64". (Pcode 05597)

- 103.03 Heel type bowl dating from c1640-1660 from Judge's Lodging, Lendal (Acc No. 1983.45 1049); rim bottered and fully milled; stem bore 8/64". (Pcode 05570)
- 103.04 Heel type bowl dating from c1640-1660 from Judge's Lodging, Lendal (Acc No. 1983.45 1071); rim bottered but not milled; stem bore 7/64". (Pcode 05582)
- 103.05 Heel type bowl dating from c1640-1660 from Judge's Lodging, Lendal (Acc No. 1983.45 1025); rim bottered but not milled; stem bore 8/64". (Pcode 05556)
- 103.06 Heel type bowl dating from c1640-1660 from Judge's Lodging, Lendal (Acc No. 1983.45 1006); rim bottered but not milled; stem bore 6/64". (Pcode 05522)
- 103.07 Heel type bowl dating from c1640-1660 from Judge's Lodging, Lendal (Acc No. 1983.45 1006); rim bottered but not milled; stem bore 6/64". (Pcode 05523)
- 103.08 Heel type bowl dating from c1640-1660 from Judge's Lodging, Lendal (Acc No. 1983.45 1060); rim bottered but not milled; stem bore 7/64". (Pcode 05580)
- 103.09 Heel type bowl dating from c1640-1660 from Judge's Lodging, Lendal (Acc No. 1983.45 1049); rim bottered and fully milled; stem bore 8/64". (Pcode 05574)
- 103.10 Heel type bowl dating from c1640-1660 from Judge's Lodging, Lendal (Acc No. 1983.45 1027); rim bottered but not milled; stem bore 7/64". (Pcode 05560)
- 103.11 Heel type bowl dating from c1640-1660 from Judge's Lodging, Lendal (Acc No. 1983.45 1071); rim bottered and fully milled; stem bore 6/64". (Pcode 05584)
- 103.12 Heel type bowl dating from c1640-1660 from Judge's Lodging, Lendal (Acc No. 1983.45 1095); rim bottered but not milled; stem bore 7/64". (Pcode 05599)
- 103.13 Heel type bowl dating from c1640-1660 from Judge's Lodging, Lendal (Acc No. 1983.45 1071); rim bottered and fully milled; stem bore 7/64". (Pcode 05583)
- 103.14 Heel type bowl dating from c1640-1660 from Judge's Lodging, Lendal (Acc No. 1983.45 1093); rim bottered; milled around all of the surviving rim; stem bore 8/64". (Pcode 05593)

- 103.15 Heel type bowl dating from c1640-1660 from Judge's Lodging, Lendal (Acc No. 1983.45 1098); rim bottered and half milled; stem bore 8/64". (Pcode 05600)
- 103.16 Heel type bowl dating from c1650-1670 from Judge's Lodging, Lendal (Acc No. 1983.45 1027); average burnish; rim bottered and fully milled; stem bore 9/64". (Pcode 05561)
- 103.17 Heel type bowl dating from c1650-1670 from Judge's Lodging, Lendal (Acc No. 1983.45 1027); finely burnished; rim bottered and fully milled; stem bore 8/64". (Pcode 05562)
- 103.18 Heel type bowl dating from c1650-1670 from Judge's Lodging, Lendal (Acc No. 1983.45 1076); rim bottered and fully milled; stem bore 6/64". (Pcode 05586)
- 103.19 Heel type bowl dating from c1650-1670 from Judge's Lodging, Lendal (Acc No. 1983.45 1025); rim bottered but not milled; stem bore 8/64". (Pcode 05555)
- 103.01 Heel type bowl dating from c1650-1670 from Judge's Lodging, Lendal (Acc No. 1983.45 1095); rim bottered but not milled; stem bore 7/64". (Pcode 05595)
- 104.02 Heel type bowl dating from c1640-1660 from Judge's Lodging, Lendal (Acc No. 1983.45 1015); rim bottered but not milled; stem bore 7/64". (Pcode 05550)
- 104.03 Heel type bowl dating from c1650-1670 from Judge's Lodging, Lendal (Acc No. 1983.45 1026); rim internally trimmed and bottered but not milled; stem bore 7/64". (Pcode 05557)
- 104.04 Heel type bowl dating from c1650-1670 from Judge's Lodging, Lendal (Acc No. 1983.45 1095); poorly burnished; rim bottered but not milled; stem bore 7/64". (Pcode 05594)
- 104.05 Heel type bowl dating from c1650-1670 from Judge's Lodging, Lendal (Acc No. 1983.45 1027); finely burnished; no rim surviving; stem bore 8/64". No rim surviving. (Pcode 05559)
- 104.06 Heel type bowl dating from c1650-1670 from Judge's Lodging, Lendal (Acc No. 1983.45 1076); rim bottered and fully milled; stem bore 8/64". (Pcode 05585)
- 104.07 Heel type bowl dating from c1650-1670 from Judge's Lodging, Lendal (Acc No. 1983.45 1060); rim wiped; one quarter milled; stem bore 7/64". (Pcode 05579)



- 104.08 Heel type bowl dating from c1660-1680 from Judge's Lodging, Lendal (Acc No. 1983.45 1006); rim bottered and fully milled; stem bore 7/64". (Pcode 05521)
- 104.09 Heel type bowl dating from c1660-1680 from Judge's Lodging, Lendal (Acc No. 1983.45 1048); rim bottered and fully milled; stem bore 7/64". (Pcode 05568)
- 104.10 Heel type bowl dating from c1660-1680 from Judge's Lodging, Lendal (Acc No. 1983.45 1049); average burnish; milled around all of the surviving rim; stem bore 7/64". No rim surviving. (Pcode 05572)
- 104.11 Heel type bowl dating from c1660-1680 from Judge's Lodging, Lendal (Acc No. 1983.45 1049); rim bottered and fully milled; stem bore 8/64". (Pcode 05573)
- 104.12 Heel type bowl dating from c1660-1680 from Judge's Lodging, Lendal (Acc No. 1983.45 1001); rim bottered and three quarters milled; stem bore 7/64". (Pcode 05510)
- 104.13 Heel type bowl dating from c1650-1670 from Judge's Lodging, Lendal (Acc No. 1983.45 1092); rim bottered and three quarters milled; stem bore 8/64". (Pcode 05591)
- 104.14 Heel type bowl dating from c1660-1680 from Judge's Lodging, Lendal (Acc No. 1983.45 1060); poorly burnished; rim bottered but not milled; stem bore 8/64". Marked with the initials ID on the heel. (Pcode 01736)
- 105.01 Heel type bowl dating from c1650-1670 from Judge's Lodging, Lendal (Acc No. 1983.45 1095); rim bottered but not milled; stem bore 7/64". (Pcode 05595)
- 105.01 Heel type bowl dating from c1670-1680 from Judge's Lodging, Lendal (Acc No. 1983.45 1013); rim bottered but not milled; stem bore 6/64". Rough repair of damage caused by trimming wire. (Pcode 05547)
- 105.02 Heel type bowl dating from c1670-1680 from Judge's Lodging, Lendal (Acc No. 1983.45 1026); finely burnished; rim bottered but not milled; stem bore 6/64". Marked with the initials ?ID on the heel. (Pcode 01678)
- 105.03 Heel type bowl dating from c1660-1680 from Judge's Lodging, Lendal (Acc No. 1983.45 1042); average burnish; rim bottered and one quarter milled; stem bore 7/64". Marked with the initials WM on the heel. (Pcode 01722)
- 105.04 Heel type bowl dating from c1660-1690 from Judge's Lodging, Lendal (Acc No. 1983.45 1049); rim bottered but not milled; stem bore 8/64". (Pcode 05576)

- 105.05 Heel type bowl dating from c1660-1690 from Judge's Lodging, Lendal (Acc No. 1983.45 1049); rim bottered and half milled; stem bore 7/64". (Pcode 05575)
- 105.06 Heel type bowl dating from c1660-1690 from Judge's Lodging, Lendal (Acc No. 1983.45 1001); rim internally trimmed, bottered and half milled; stem bore 7/64". (Pcode 05511)
- 105.07 Heel type bowl dating from c1660-1680 from Judge's Lodging, Lendal (Acc No. 1983.45 1092); average burnish; rim bottered and half milled; stem bore 7/64". Marked with the initials AB on the heel. (Pcode 01732)
- 105.08 Heel type bowl dating from c1670-1680 from Judge's Lodging, Lendal (Acc No. 1983.45 1092); rim bottered but not milled; stem bore 7/64". (Pcode 05592)
- 105.09 Heel type bowl dating from c1670-1680 from Judge's Lodging, Lendal (Acc No. 1983.45 1046); rim internally trimmed and wiped; half milled; stem bore 6/64". (Pcode 05567)
- 105.10 Heel type bowl dating from c1680-1710 from Judge's Lodging, Lendal (Acc No. 1983.45 1013); rim internally trimmed, bottered and one quarter milled; stem bore 7/64". Marked with the initials AB on the heel. (Pcode 01771)
- 105.11 Heel type bowl dating from c1680-1710 from Judge's Lodging, Lendal (Acc No. 1983.45 1013); rim bottered but not milled; stem bore 7/64". Marked with the initials ID on the heel. (Pcode 01772)
- 105.12 Heel type bowl dating from c1680-1710 from Judge's Lodging, Lendal (Acc No. 1983.45 1002); finely burnished; rim bottered and one quarter milled; stem bore 6/64". (Pcode 05512)
- 106.01 Heel type bowl dating from c1680-1710 from Judge's Lodging, Lendal (Acc No. 1983.45 1093); average burnish; rim internally trimmed, bottered and three quarters milled; stem bore 7/64". Marked with the initials RS on the heel. (Pcode 01679)
- 106.02 Heel type bowl dating from c1680-1710 from Judge's Lodging, Lendal (Acc No. 1983.45 1085); finely burnished; rim bottered and half milled; stem bore 7/64". Marked with the initials RS on the heel. (Pcode 01721)
- 106.03 Heel type bowl dating from c1680-1710 from Judge's Lodging, Lendal (Acc No. 1983.45 1013); rim bottered but not milled; stem bore 6/64". (Pcode 05548)
- 106.04 Heel type bowl dating from c1690-1720 from Judge's Lodging, Lendal (Acc No. 1983.45 1071); finely burnished; no rim surviving; stem bore 6/64". Marked with the initials IS on the heel. (Pcode 01774)

- 106.05 Heel type bowl dating from c1710-1740 from Judge's Lodging, Lendal (Acc No. 1983.45 1049); rim cut and internally trimmed but not milled; stem bore 4/64". (Pcode 05571)
- 106.06 Heel type bowl dating from c1640-1680 from the Merchant Taylor's Hall, Aldwark (Acc No. 1991.19 1006); no rim surviving. Marked with the initials WS on the heel. No rim surviving. (Pcode 03442)
- 106.07 Heel type bowl dating from c1680-1710 from the Merchant Taylor's Hall, Aldwark (Acc No. 1991.19 2013); no rim surviving. Marked with the initials RS on the heel. (Pcode 03439)
- 106.08 Heel type bowl dating from c1680-1710 from the Merchant Taylor's Hall, Aldwark (Acc No. 1991.19 1011); rim bottered; milled around all of the surviving rim. Marked with the initials IS on the heel. (Pcode 03440)
- 106.09 Heel type bowl dating from c1680-1710 from the Merchant Taylor's Hall, Aldwark (Acc No. 1991.19 1006); rim internally trimmed and bottered but not milled. Marked with the initials AB on the heel. (Pcode 03443)
- 106.10 Heel type bowl dating from c1700-1740 from the Merchant Taylor's Hall, Aldwark (Acc No. 1991.19 1007); rim wiped but not milled. Marked with the initials ?WS on the heel. (Pcode 03441)
- 106.11 Heel type bowl dating from c1730-1760 from the Merchant Taylor's Hall, Aldwark (Acc No. 1991.19 1014); no rim surviving. No rim surviving. (Pcode 05811)
- 106.12 Heel type bowl dating from c1660-1680 from St Andrews Church (Acc No. 1988.6 6016); finely burnished; rim bottered and three quarters milled; stem bore 7/64". Marked with the initials WM on the heel. (Pcode 01950)
- 107.01 Heel type bowl dating from c1630-1660 from Museum Street (Acc No. 1974.4 4); very finely burnished; rim bottered and fully milled; stem bore 7/64". Very finely made small pipe, possibly a miniature. (Pcode 05805)
- 107.02 Heel type bowl dating from c1650-1670 from the Museum Gardens (Acc No. 1987.16); rim bottered but not milled. (Pcode 05873)
- 107.03 Heel type bowl dating from c1650-1670 from Peasholme Green (Acc No. 1990.13 2048); poorly burnished; rim bottered and fully milled; stem bore 6/64". (Pcode 05865)
- 107.04 Heel type bowl dating from c1650-1670 from Peasholme Green (Acc No. 1990.13 2048); rim bottered and fully milled. (Pcode 05866)
- 107.05 Heel type bowl dating from c1650-1670 from Peasholme Green (Acc No. 1990.13 4007); rim bottered but not milled; stem bore 7/64". (Pcode 05867)

- 107.06 Heel type bowl dating from c1650-1670 from Peasholme Green (Acc No. 1990.13 4007); rim bottered but not milled. Surface abraded, cannot tell if bowl has been burnished. (Pcode 05868)
- 107.07 Heel type bowl dating from c1660-1680 from Peasholme Green (Acc No. 1990.13 A1 U/S); rim internally trimmed, bottered and half milled; stem bore 6/64". (Pcode 05869)
- 107.08 Heel type bowl dating from c1670-1700 from Peasholme Green (Acc No. 1990.13 A1 U/S); rim internally trimmed, bottered and half milled. (Pcode 05870)
- 107.09 Heel type bowl dating from c1670-1680 from St Mary's Castlegate (Acc No. 1975.25 U/S); finely burnished; rim internally trimmed, bottered and half milled; stem bore 6/64". Marked with the initials RS on the heel. (Pcode 01948)
- 107.10 Heel type bowl dating from c1640-1660 from Skeldergate, City Mills (Acc No. 1983.2 1198); rim bottered and fully milled; stem bore 7/64". (Pcode 05784)
- 107.11 Heel type bowl dating from c1650-1670 from Skeldergate, City Mills (Acc No. 1983.2 1198); rim bottered and fully milled; stem bore 7/64". (Pcode 05783)
- 107.12 Heel type bowl dating from c1650-1670 from Skeldergate, City Mills (Acc No. 1983.2 1001); rim bottered but not milled. (Pcode 05757)
- 107.13 Heel type bowl dating from c1660-1680 from Skeldergate, City Mills (Acc No. 1983.2 1001); rim bottered but not milled. (Pcode 05758)
- 108.01 Heel type bowl dating from c1660-1680 from Skeldergate, City Mills (Acc No. 1983.2 1001); rim bottered but not milled. (Pcode 05759)
- 108.02 Heel type bowl dating from c1660-1680 from Skeldergate, City Mills (Acc No. 1983.2 1125); rim bottered and one quarter milled; stem bore 7/64". (Pcode 05782)
- 108.03 Heel type bowl dating from c1660-1680 from Skeldergate, City Mills (Acc No. 1983.2 1077); rim bottered and one quarter milled; stem bore 6/64". Marked with the initials RS on the heel. (Pcode 01934)
- 108.04 Heel type bowl dating from c1660-1680 from Skeldergate, City Mills (Acc No. 1983.2 1001); average burnish; rim internally trimmed, bottered and fully milled; stem bore 7/64". Marked with the initials IW on the heel. (Pcode 01926)
- 108.05 Heel type bowl dating from c1670-1700 from Skeldergate, City Mills (Acc No. 1983.2 1077); average burnish; rim internally trimmed and bottered but

- not milled; stem bore 6/64". Marked with the initials TL on the heel. (Pcode 01931)
- 108.06 Heel type bowl dating from c1670-1700 from Skeldergate, City Mills (Acc No. 1983.2 1077); finely burnished; rim bottered and one quarter milled; stem bore 5/64". (Pcode 05779)
- 108.07 Spur type bowl dating from c1670-1700 from Skeldergate, City Mills (Acc No. 1983.2 1015); average burnish; rim IW but not milled; stem bore 6/64". Marked with the initials SH across the stem. (Pcode 01928)
- 108.08 Heel type bowl dating from c1680-1710 from Skeldergate, City Mills (Acc No. 1983.2 1056); rim internally trimmed and bottered but not milled; stem bore 5/64". Marked with the initials WS on the heel. (Pcode 01929)
- 108.09 Heel type bowl dating from c1680-1710 from Skeldergate, City Mills (Acc No. 1983.2 1001); no rim surviving. Marked with the initials WS on the heel. No rim surviving. (Pcode 05760)
- 108.10 Heel type bowl dating from c1680-1710 from Skeldergate, City Mills (Acc No. 1983.2 1056); average burnish; rim internally trimmed and bottered but not milled; stem bore 5/64". Marked with the initials SH on the heel. (Pcode 01930)
- 108.11 Heel type bowl dating from c1680-1710 from Skeldergate, City Mills (Acc No. 1983.2 1077); finely burnished; rim bottered but not milled; stem bore 6/64". (Pcode 05780)
- 109.01 Spur type bowl dating from c1680-1710 from Skeldergate, City Mills (Acc No. 1983.2); rim bottered but not milled; stem bore 6/64". (Pcode 05752)
- 109.02 Heel type bowl dating from c1680-1700 from Skeldergate, City Mills (Acc No. 1983.2 1077); rim bottered but not milled; stem bore 7/64". Marked with the initials RS on the heel. (Pcode 01935)
- 109.03 Heel type bowl dating from c1680-1710 from Skeldergate, City Mills (Acc No. 1983.2 1001); no rim surviving. (Pcode 05761)
- 109.04 Heel type bowl dating from c1690-1720 from Skeldergate, City Mills (Acc No. 1983.2 1015); rim internally trimmed and bottered but not milled; stem bore 6/64". (Pcode 05763)
- 109.05 Heel type bowl dating from c1700-1730 from Skeldergate, City Mills (Acc No. 1983.2 1060); rim cut and internally trimmed but not milled; stem bore 6/64". (Pcode 05768)
- 109.06 Heel type bowl dating from c1700-1730 from Skeldergate, City Mills (Acc No. 1983.2 1060); average burnish; rim cut and internally trimmed but not milled; stem bore 6/64". (Pcode 05769)

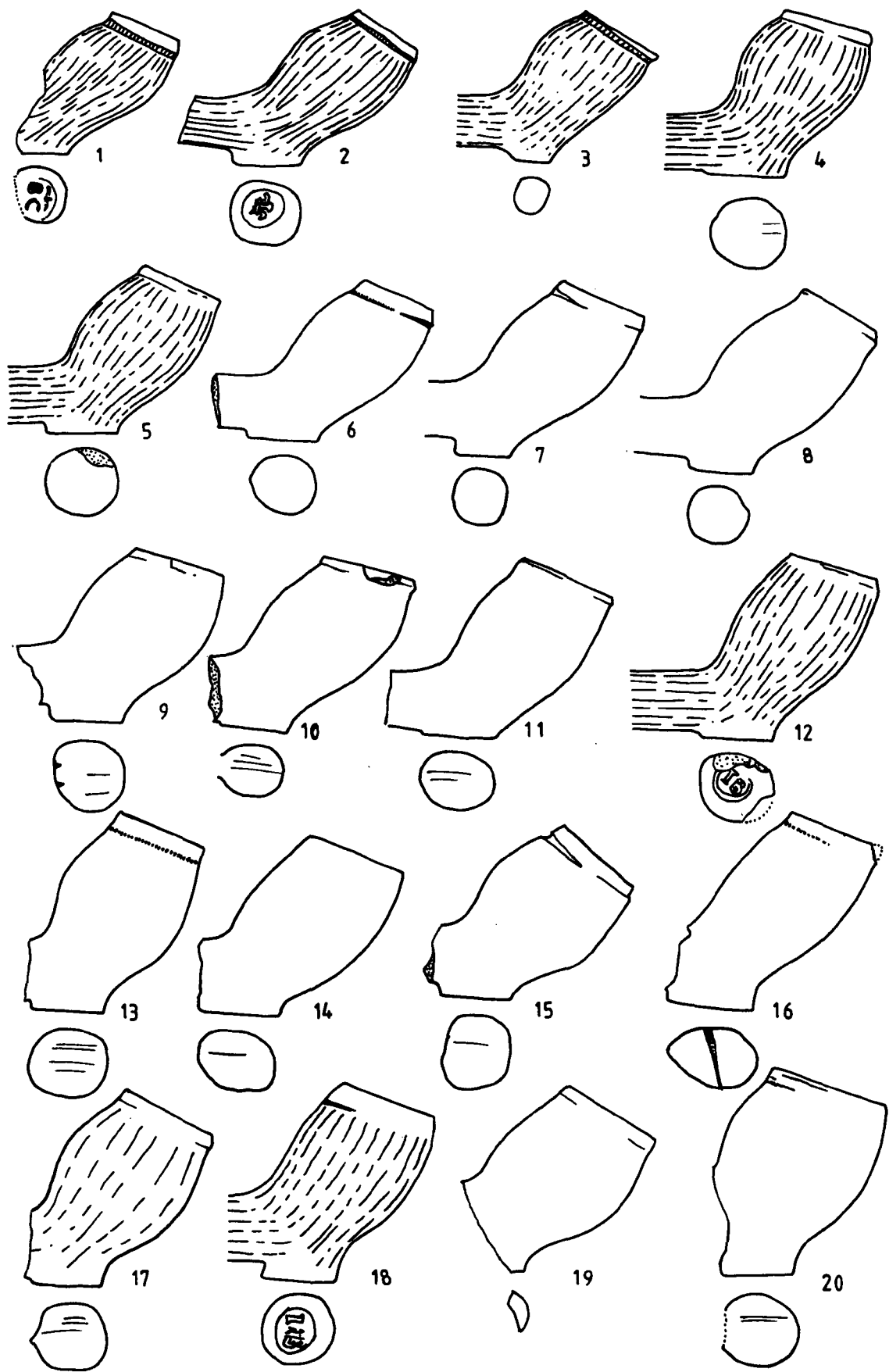
- 109.07 Heel type bowl dating from c1700-1730 from Skeldergate, City Mills (Acc No. 1983.2 1060); rim cut and internally trimmed but not milled; stem bore 5/64". (Pcode 05770)
- 109.08 Heel type bowl dating from c1700-1730 from Skeldergate, City Mills (Acc No. 1983.2 1060); rim IW but not milled; stem bore 5/64". (Pcode 05771)
- 109.09 Heel type bowl dating from c1700-1730 from Skeldergate, City Mills (Acc No. 1983.2 1060); rim wiped but not milled; stem bore 6/64". Near complete pipe. (Pcode 05772)
- 109.10 Heel type bowl dating from c1700-1730 from Skeldergate, City Mills (Acc No. 1983.2 1060); rim cut and internally trimmed but not milled; stem bore 5/64". (Pcode 05773)
- 109.11 Heel type bowl dating from c1700-1730 from Skeldergate, City Mills (Acc No. 1983.2 1060); rim cut and internally trimmed but not milled; stem bore 5/64". (Pcode 05774)
- 109.12 Heel type bowl dating from c1710-1740 from Skeldergate, City Mills (Acc No. 1983.2 1060); rim cut but not milled; stem bore 5/64". (Pcode 05776)
- 110.01 Heel type bowl dating from c1620-1640 from The Bedern (Acc No. 1976.13 X 5027); rim bottered and fully milled; stem bore 7/64". (Pcode 05615)
- 110.02 Heel type bowl dating from c1620-1640 from The Bedern (Acc No. 1974.13 IV U/S); no rim surviving; stem bore 8/64". No rim surviving. (Pcode 05611)
- 110.03 Heel type bowl dating from c1640-1660 from The Bedern (Acc No. 1976.13 X 5027); rim bottered but not milled; stem bore 8/64". (Pcode 05614)
- 110.04 Heel type bowl dating from c1640-1660 from The Bedern (Acc No. 1977.13 X 6000); poorly burnished; rim bottered and fully milled; stem bore 6/64". Marked with a Fleur-de-lys on the heel. (Pcode 01803)
- 110.05 Heel type bowl dating from c1650-1670 from The Bedern (Acc No. 1976.13 X 5027); rim bottered and three quarters milled; stem bore 7/64". (Pcode 05613)
- 110.06 Heel type bowl dating from c1640-1660 from The Bedern (Acc No. 1980.13 XV); rim bottered and fully milled; stem bore 8/64". (Pcode 05618)
- 110.07 Heel type bowl dating from c1650-1670 from The Bedern (Acc No. 1974.13 IV U/S); rim bottered and one quarter milled; stem bore 7/64". (Pcode 05609)
- 110.08 Heel type bowl dating from c1650-1670 from The Bedern (Acc No. 1974.13 IV U/S); rim bottered but not milled; stem bore 7/64". (Pcode 05608)

- 110.09 Heel type bowl dating from c1650-1670 from The Bedern (Acc No. 1974.13 IV U/S); rim bottered and half milled. (Pcode 05610)
- 110.10 Heel type bowl dating from c1660-1680 from The Bedern (Acc No. 1973.13 U/S); average burnish; rim bottered and three quarters milled; stem bore 7/64". Marked with the initials TH on the heel. (Pcode 01813)
- 110.11 Heel type bowl dating from c1660-1680 from The Bedern (Acc No. 1973.13 II 37); average burnish; rim bottered but not milled; stem bore 7/64". Marked with the initials RS on the heel. (Pcode 01811)
- 110.12 Heel type bowl dating from c1660-1680 from The Bedern (Acc No. 1974.13 III 1021); rim bottered and three quarters milled; stem bore 7/64". (Pcode 05607)
- 110.13 Heel type bowl dating from c1660-1680 from The Bedern (Acc No. 1974.13 IV U/S); rim bottered and half milled; stem bore 6/64". Marked with the initials AB on the heel. (Pcode 08260)
- 110.14 Heel type bowl dating from c1660-1680 from The Bedern (Acc No. 1977.13 X 6087); very finely burnished; rim wiped; three quarters milled; stem bore 6/64". Marked with the initials TB on the heel. Possibly not a Yorkshire form. (Pcode 01807)
- 111.01 Heel type bowl dating from c1660-1680 from The Bedern (Acc No. 1974.13 IV U/S); no rim surviving. Marked with the initials RS on the heel. No rim surviving. (Pcode 01810)
- 111.02 Heel type bowl dating from c1660-1690 from The Bedern (Acc No. 1977.13 X 6000); average burnish; no rim surviving; stem bore 6/64". Marked with the initials IS on the heel. No rim surviving. (Pcode 01805)
- 111.03 Heel type bowl dating from c1670-1680 from The Bedern (Acc No. 1976.13 X 5011); finely burnished; rim internally trimmed, bottered and half milled; stem bore 7/64". Marked with the initials RB on the heel. (Pcode 01804)
- 111.04 Heel type bowl dating from c1690-1720 from The Bedern (Acc No. 1973.13 II 1); finely burnished; rim bottered and one quarter milled; stem bore 6/64". Marked with the initials IS on the heel. (Pcode 01812)
- 111.05 Heel type bowl dating from c1620-1640 from 20-24 Swinegate (Acc No. 1990.25 2000); rim bottered; milled around all of the surviving rim. (Pcode 05881)
- 111.06 Heel type bowl dating from c1640-1660 from 20-24 Swinegate (Acc No. 1990.25 U/S); finely burnished; no rim surviving. No rim surviving. (Pcode 05882)
- 111.07 Heel type bowl dating from c1660-1680 from 20-24 Swinegate (Acc No. 1990.25 1000); rim bottered and one quarter milled. (Pcode 05879)

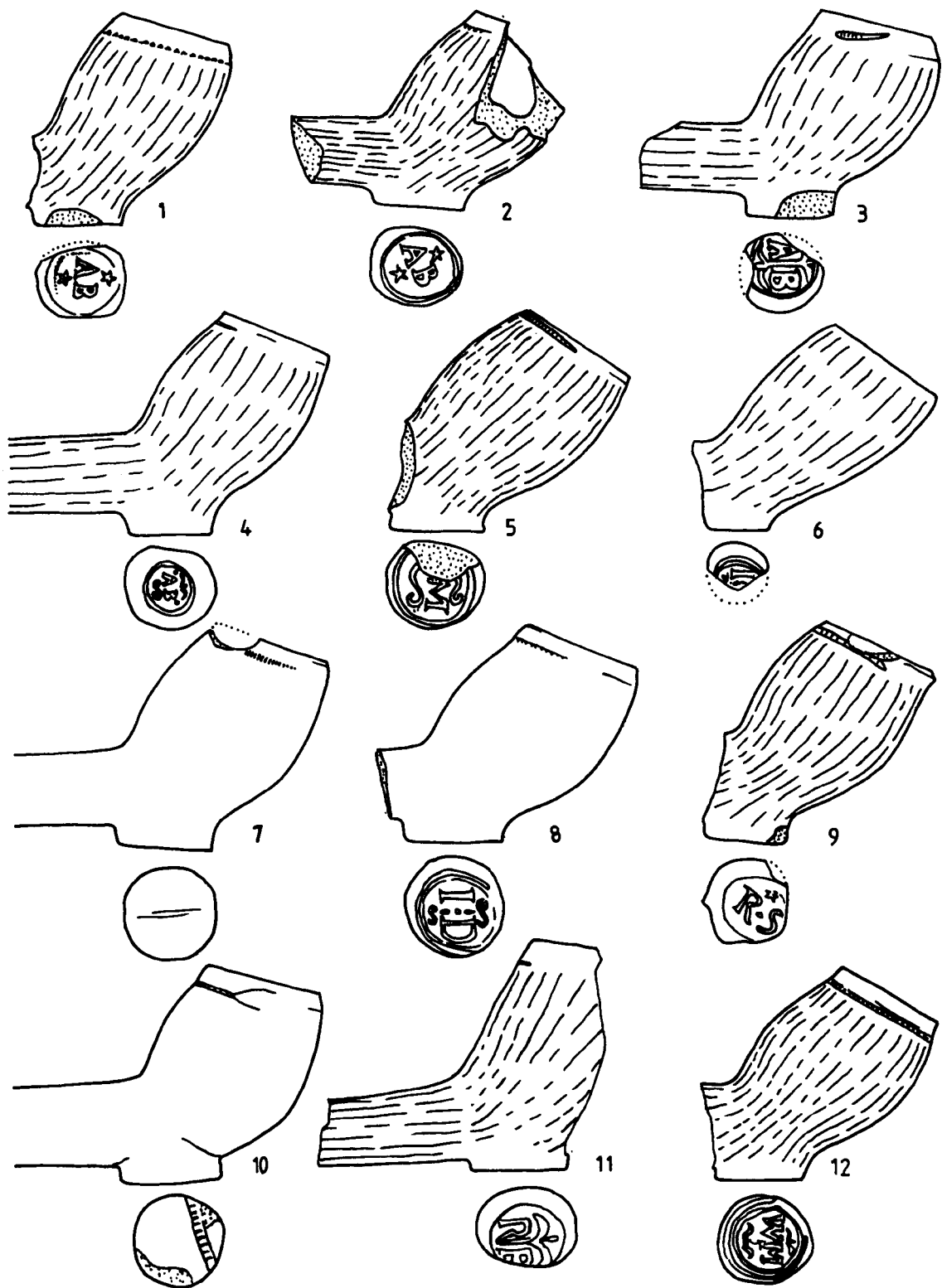
- 111.08 Heel type bowl dating from c1620-1640 from St Saviorgate (Acc No. 1983.44 1001); rim bottered and fully milled; stem bore 7/64". Marked with the initials GW on the heel. Possibly burnished, surface of bowl badly abraded. (Pcode 01940)
- 111.09 Heel type bowl dating from c1640-1660 from St Saviorgate (Acc No. 1983.44 1001); finely burnished; rim internally trimmed, bottered and fully milled; stem bore 7/64". (Pcode 05797)
- 111.10 Heel type bowl dating from c1650-1670 from St Saviorgate (Acc No. 1983.44 1001); rim internally trimmed, bottered and one quarter milled; stem bore 7/64". (Pcode 05795)
- 111.11 Heel type bowl dating from c1650-1670 from St Saviorgate (Acc No. 1983.44 1001); rim bottered but not milled; stem bore 7/64". (Pcode 05796)
- 111.12 Heel type bowl dating from c1650-1670 from the Stakis Hotel site, Leedhams (Acc No. 1988.24 7000); rim bottered but not milled; stem bore 7/64". (Pcode 05604)
- 111.13 Heel type bowl dating from c1660-1680 from the Stakis Hotel site, Leedhams (Acc No. 1988.24 7776); rim bottered but not milled; stem bore 6/64". Milled stem . (Pcode 05606)
- 112.01 Heel type bowl dating from c1660-1680 from St Leonard's Church, Church Hill, Malton (Acc No. 1991.5006 1047); rim internally trimmed, bottered and half milled. (Pcode 05793)
- 112.02 Heel type bowl dating from c1660-1690 from St Leonard's Church, Church Hill, Malton (Acc No. 1991.5006 1058); rim bottered; milled around all of the surviving rim. (Pcode 05794)
- 112.03 Heel type bowl dating from c1660-1690 from St Leonard's Church, Church Hill, Malton (Acc No. 1991.5006 2002); average burnish; rim bottered and three quarters milled. Marked with the initials AB on the heel. (Pcode 03448)
- 112.04 Heel type bowl dating from c1660-1710 from St Leonard's Church, Church Hill, Malton (Acc No. 1991.5006 1013); no rim surviving. Marked with the initials AB on the heel. No rim surviving. (Pcode 03445)
- 112.05 Heel type bowl dating from c1670-1720 from St Leonard's Church, Church Hill, Malton (Acc No. 1991.5006 1006); no rim surviving. Marked with the initials AB on the heel. Heel fragment only. (Pcode 03447)
- 112.06 Heel type bowl dating from c1660-1680 from York Castle car park (Acc No. 1992.5 2010); average burnish; rim bottered and one quarter milled; stem bore 7/64". Marked with the crowned initials SH on the heel. (Pcode 01945)



- 112.07 Heel type bowl dating from c1650-1670, unprovenanced material held by the York Archaeological Trust (Acc No. 1994.483 U/S); rim bottered but not milled. (Pcode 05466)
- 112.08 Heel type bowl dating from c1660-1680, unprovenanced material held by the York Archaeological Trust (Acc No. 1995.58 1011); average burnish; rim internally trimmed and bottered but not milled. Marked with the initials IB on the heel. (Pcode 03409)
- 112.09 Heel type bowl dating from c1670-1700, unprovenanced material held by the York Archaeological Trust (Acc No. 1994.484 U/S); rim internally trimmed and bottered but not milled. (Pcode 05468)
- 112.10 Spur type bowl dating from c1760-1800, unprovenanced material held by the York Archaeological Trust (Acc No. 1994.484 U/S); no rim surviving. (Pcode 05467)
- 112.11 Heel type bowl dating from c1760-1800 from Yarm (Acc No. OCM94 1010); rim cut but not milled; stem bore 5/64". Marked with the initials BC on the SS. (Pcode 05812)
- 113.01 Heel type bowl dating from c1620-1660 from St George's Field car park (Acc No. 1990.17 1011); no rim surviving; stem bore 7/64". No rim surviving. (Pcode 05602)
- 113.02 Heel type bowl dating from c1640-1660 from St George's Field car park (Acc No. 1990.17 1018); finely burnished; rim bottered; milled around all of the surviving rim; stem bore 8/64". Marked with the initials BC on the heel. (Pcode 01782)
- 113.03 Heel type bowl dating from c1660-1680 from St George's Field car park (Acc No. 1990.17 1061); average burnish; rim bottered; milled around all of the surviving rim; stem bore 6/64". Marked with the initials RS on the heel. (Pcode 01783)
- 113.04 Heel type bowl dating from c1660-1680 from St George's Field car park (Acc No. 1990.17 1122); rim cut but not milled; stem bore 5/64". (Pcode 05603)
- 113.05 Heel type bowl dating from c1680-1710 from St George's Field car park (Acc No. 1990.17 1011); rim cut and internally trimmed; one quarter milled; stem bore 5/64". Marked with the initials AB on the heel. (Pcode 01785)



**Figure 85:** Pipes held by the York Archaeological Trust, York. Scale 1:1.



**Figure 86:** Pipes held by the York Archaeological Trust, York. Scale 1:1.

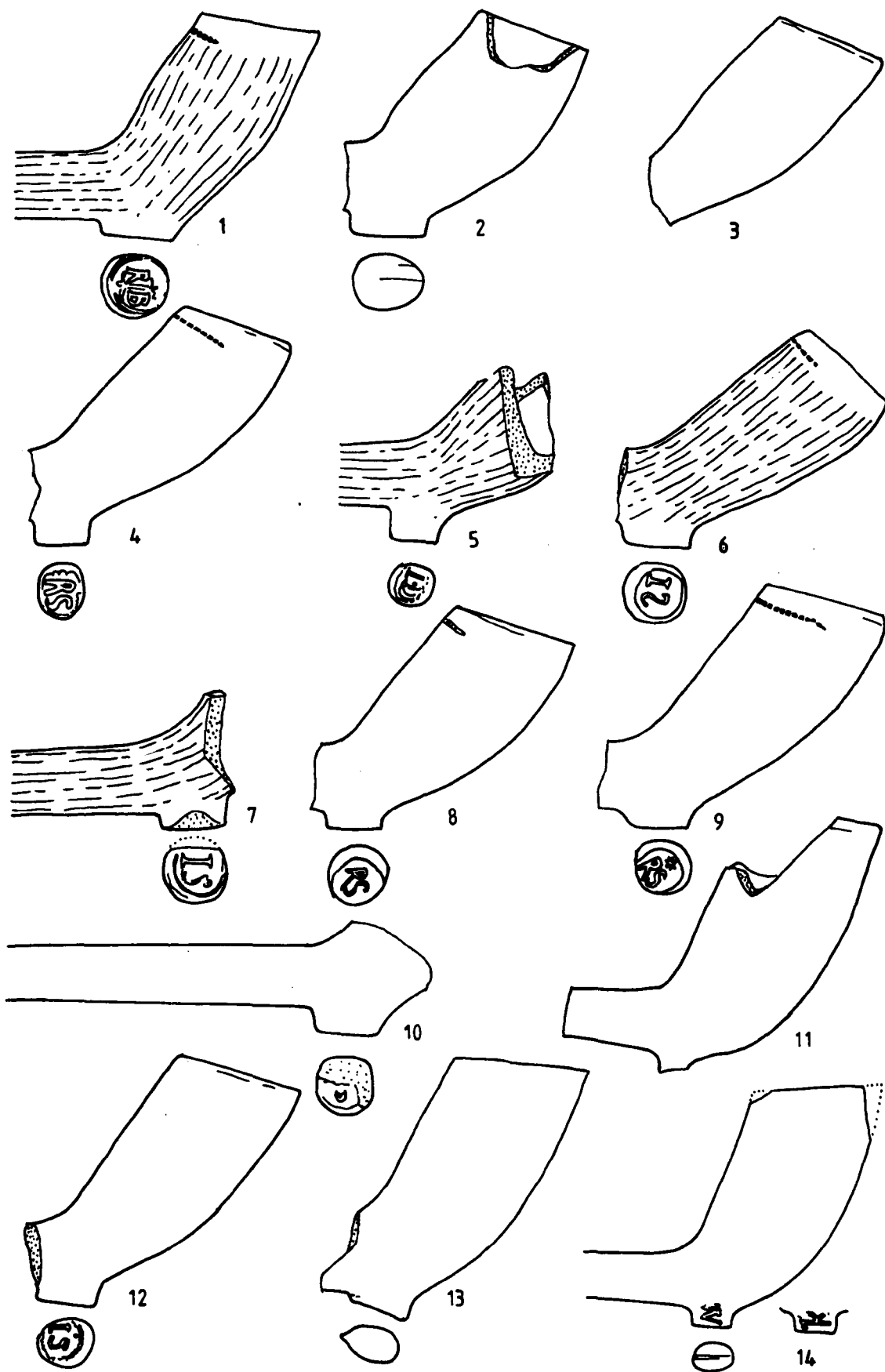
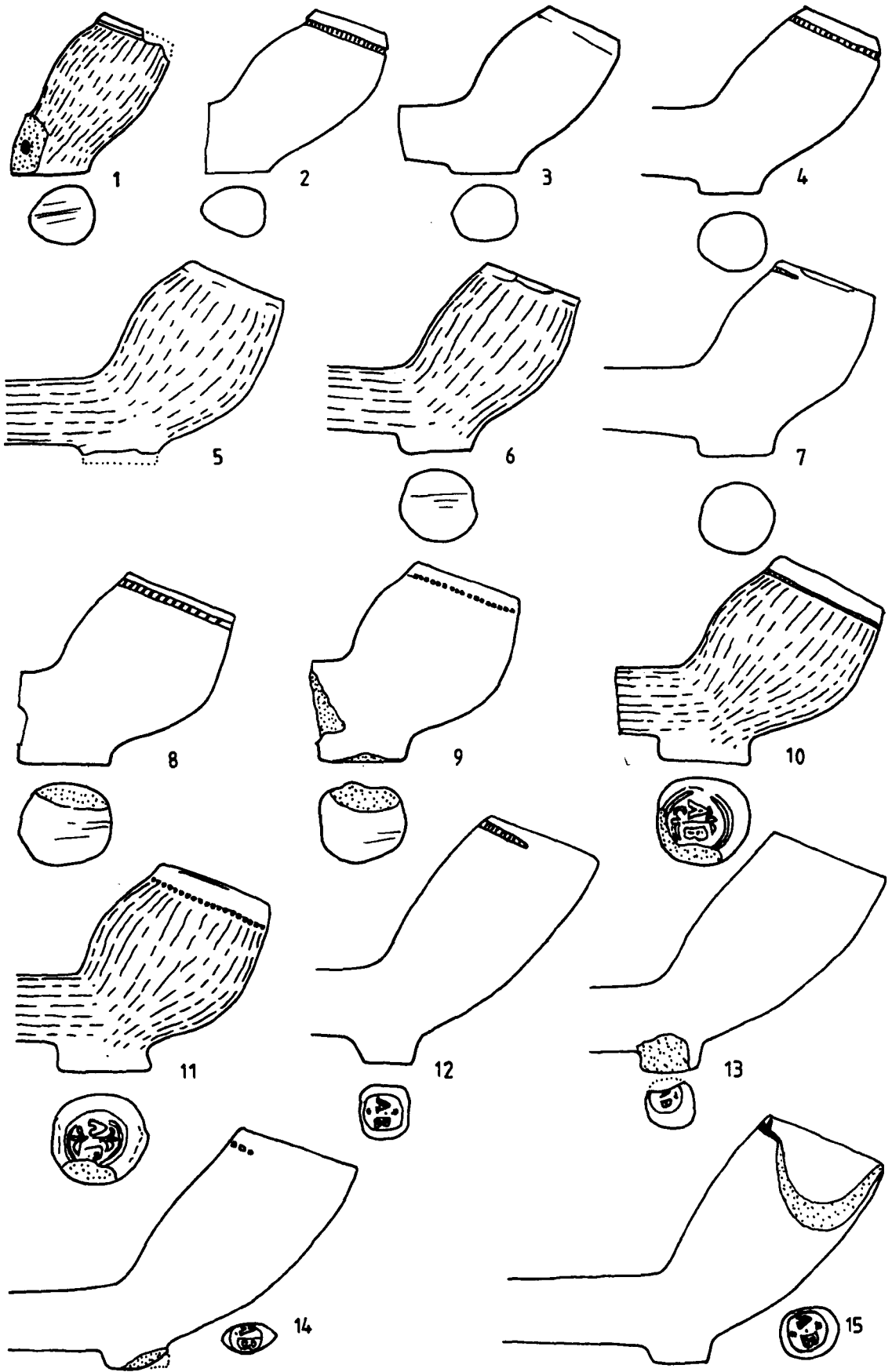
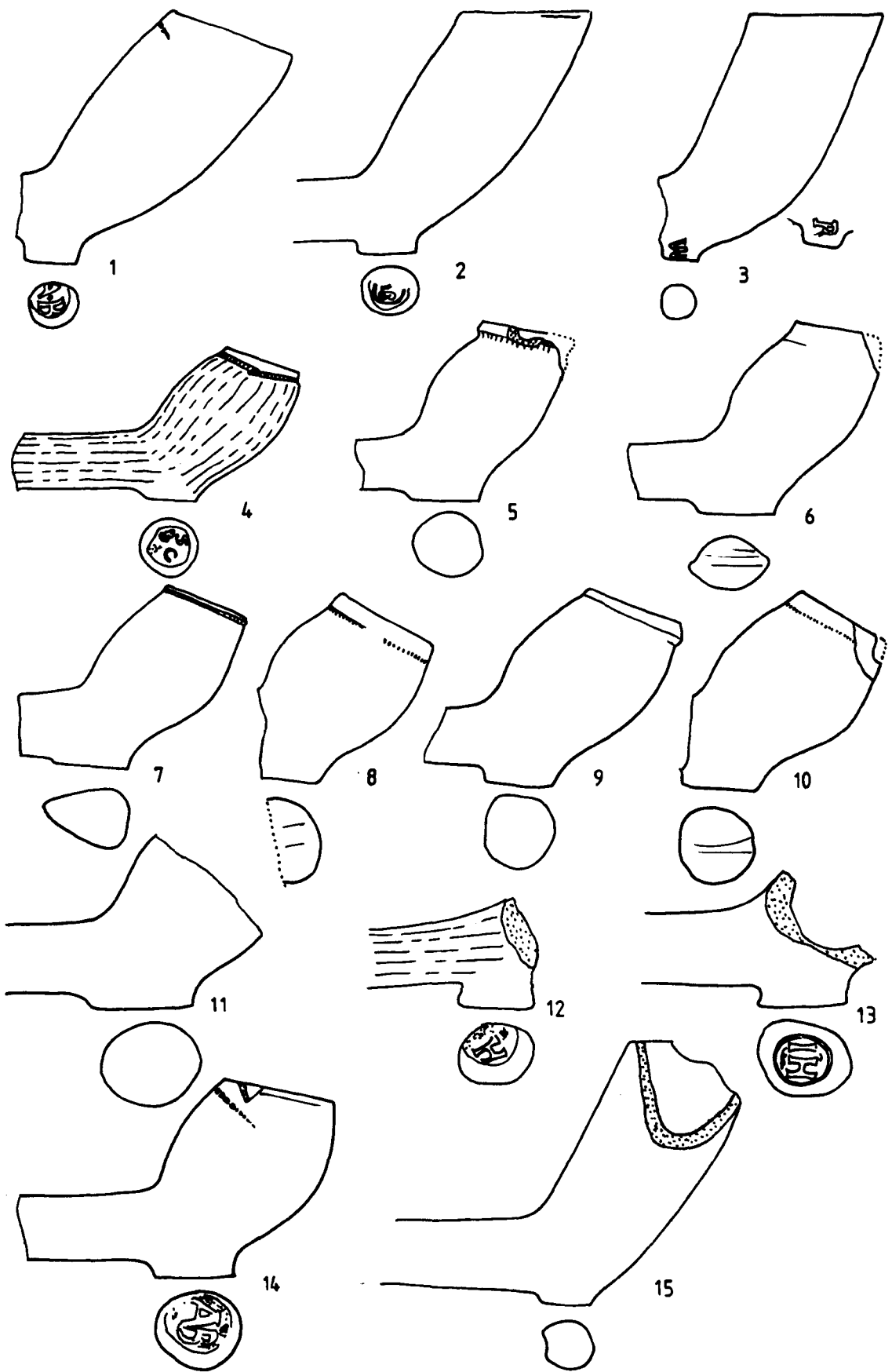


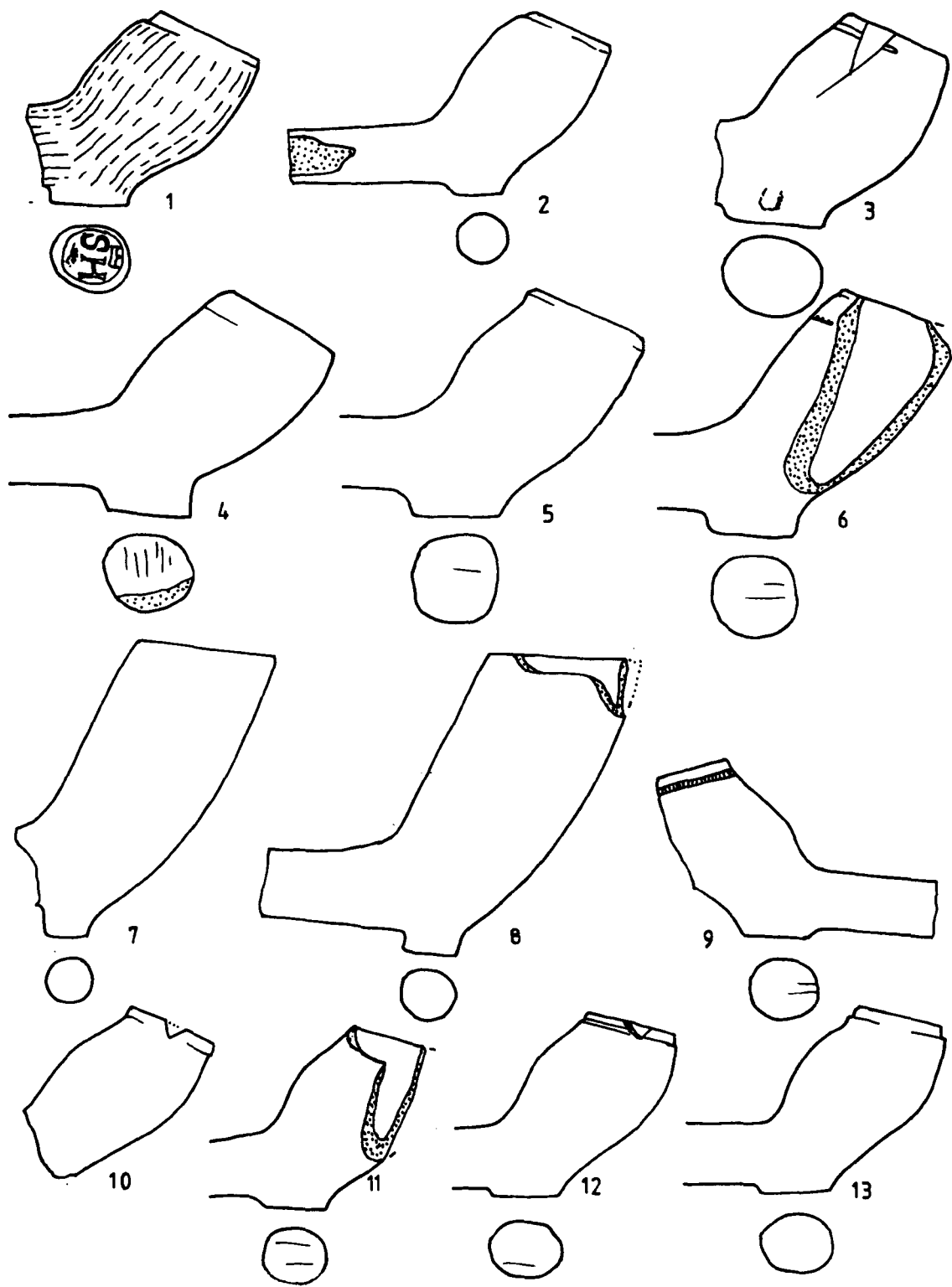
Figure 87: Pipes held by the York Archaeological Trust, York. Scale 1:1.



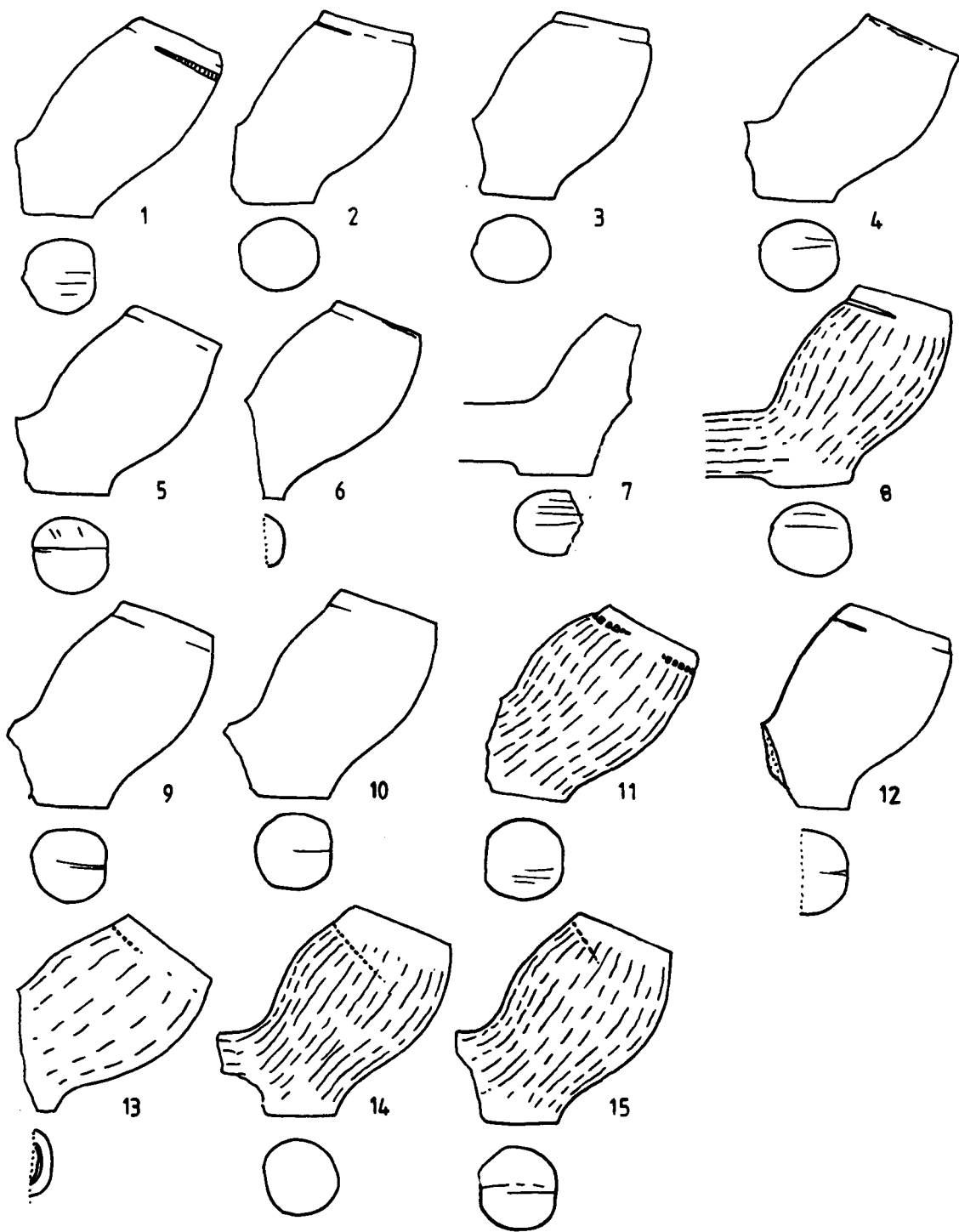
**Figure 88:** Pipes held by the York Archaeological Trust, York. Scale 1:1.



**Figure 89:** Pipes held by the York Archaeological Trust, York. Scale 1:1.

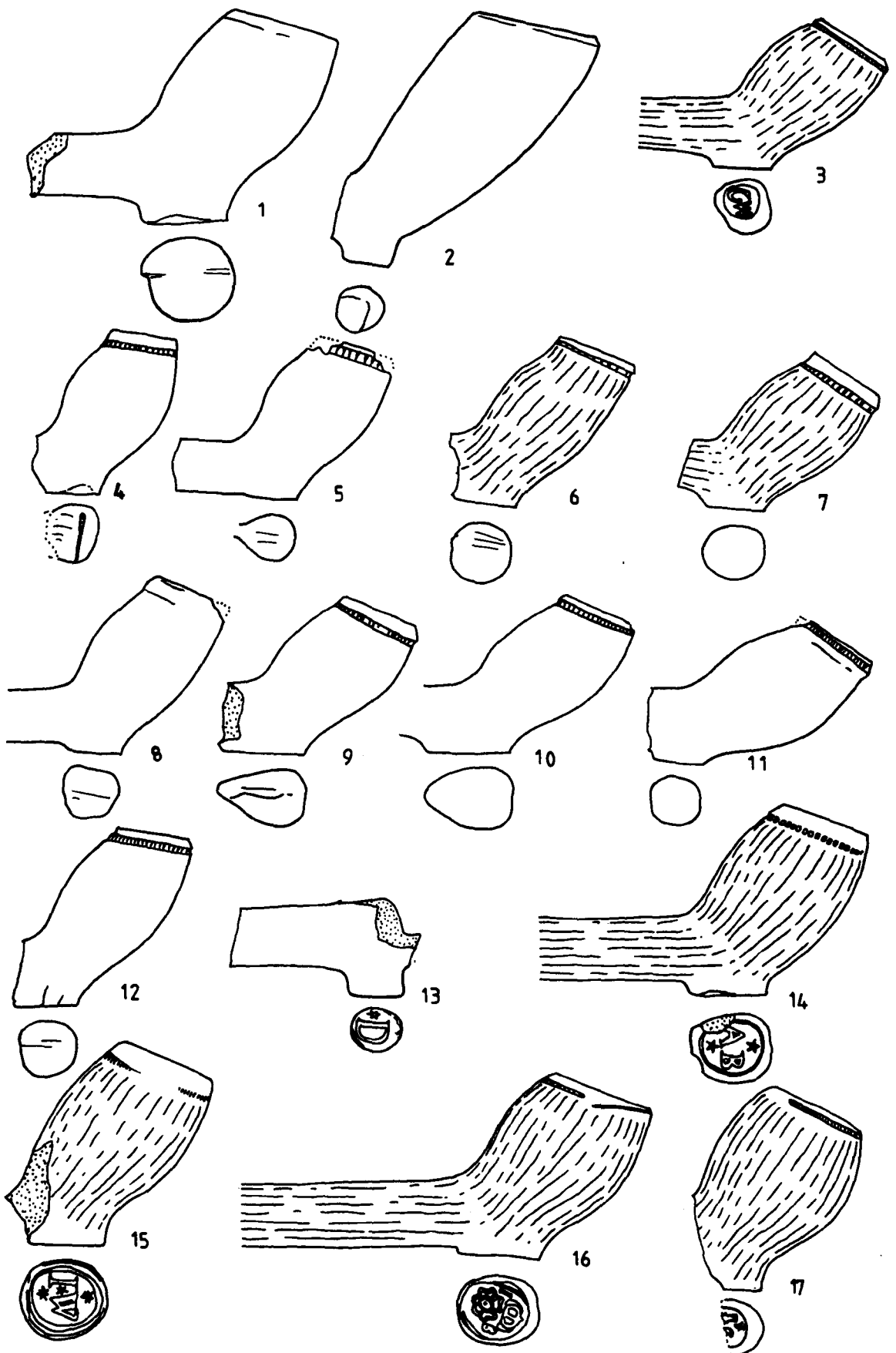


**Figure 90:** Pipes held by the York Archaeological Trust, York. Scale 1:1.

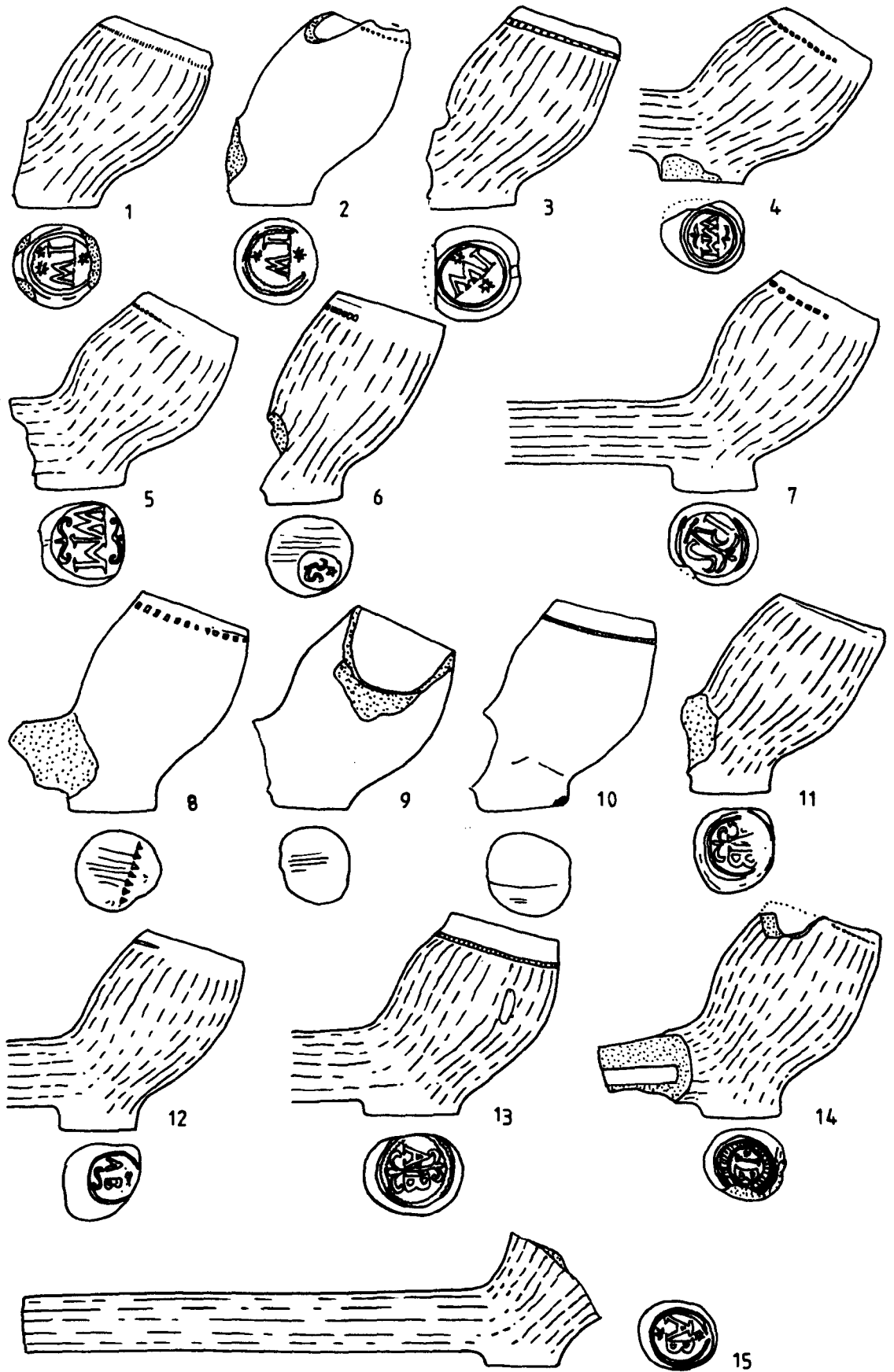


**Figure 91:** Pipes held by the York Archaeological Trust, York. Scale 1:1.

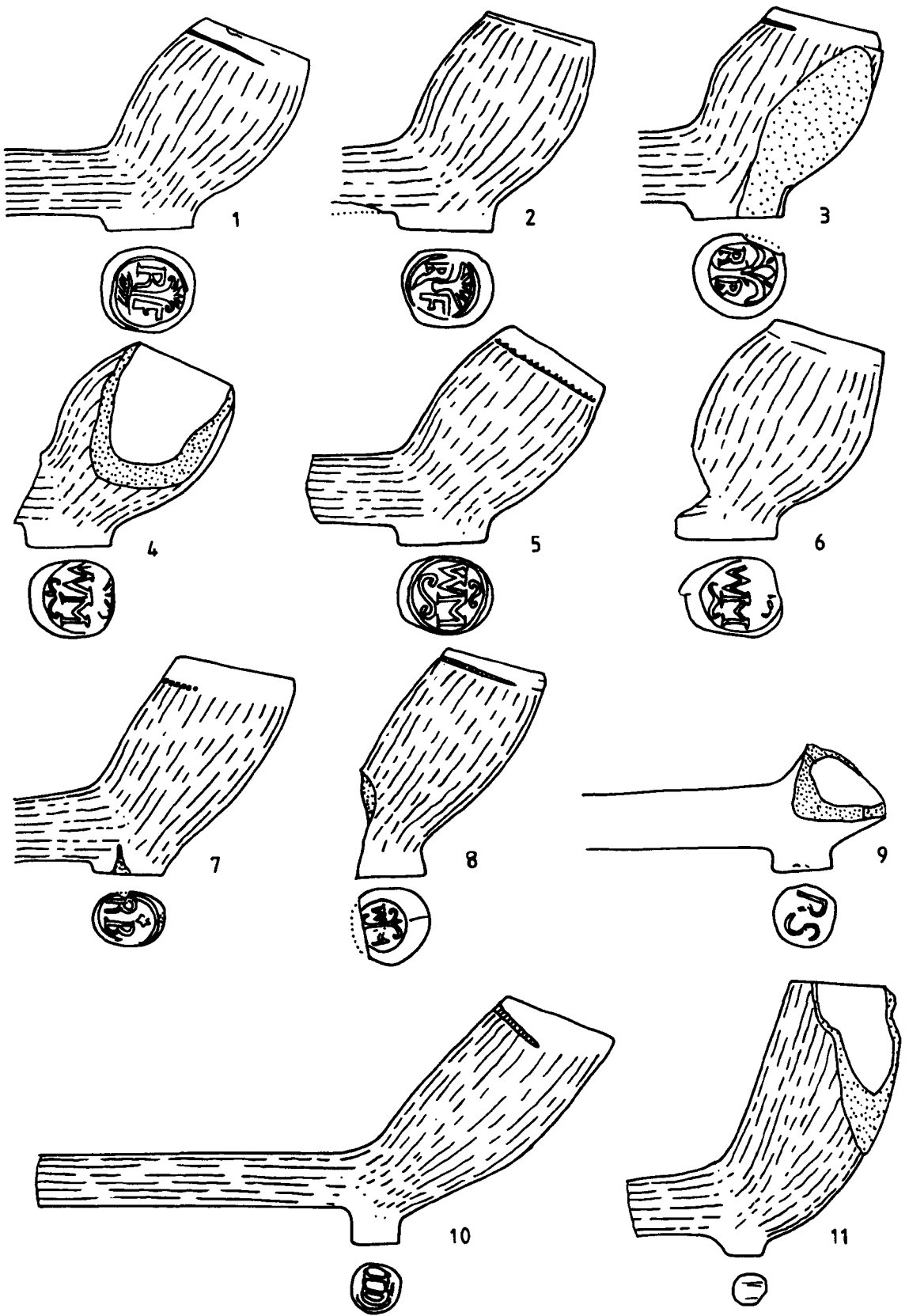




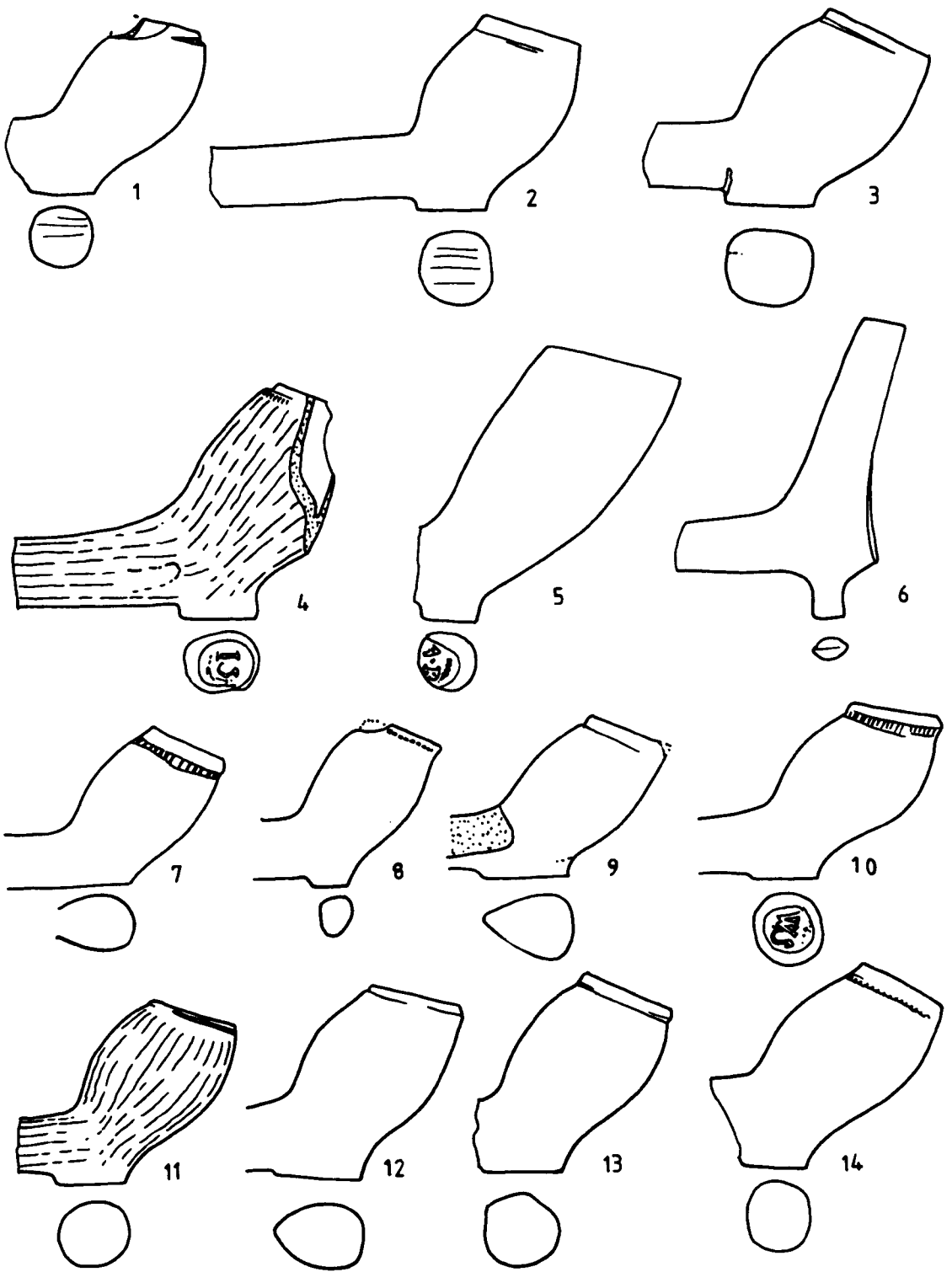
**Figure 92:** Pipes held by the York Archaeological Trust, York. Scale 1:1.



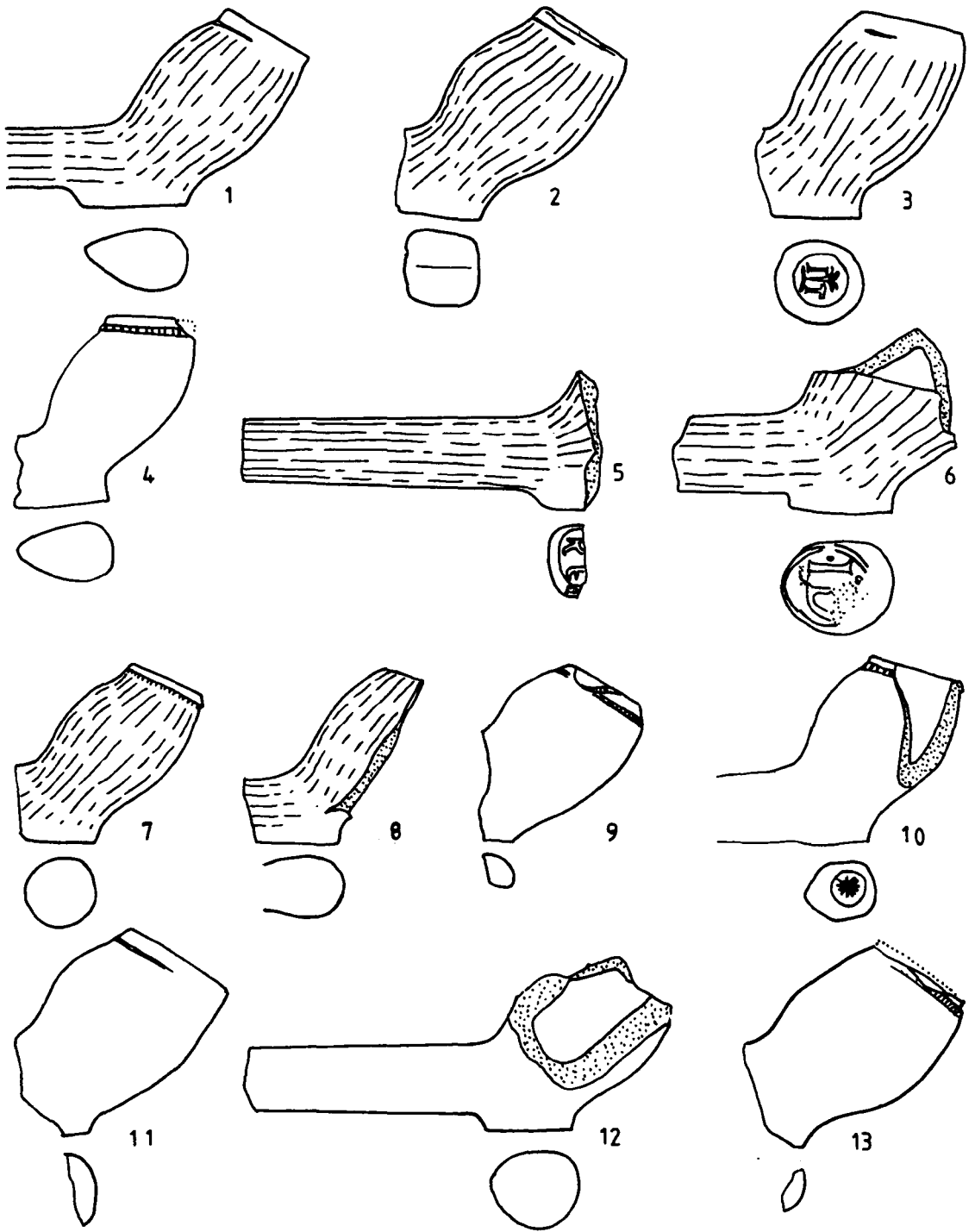
**Figure 93:** Pipes held by the York Archaeological Trust, York. Scale 1:1.



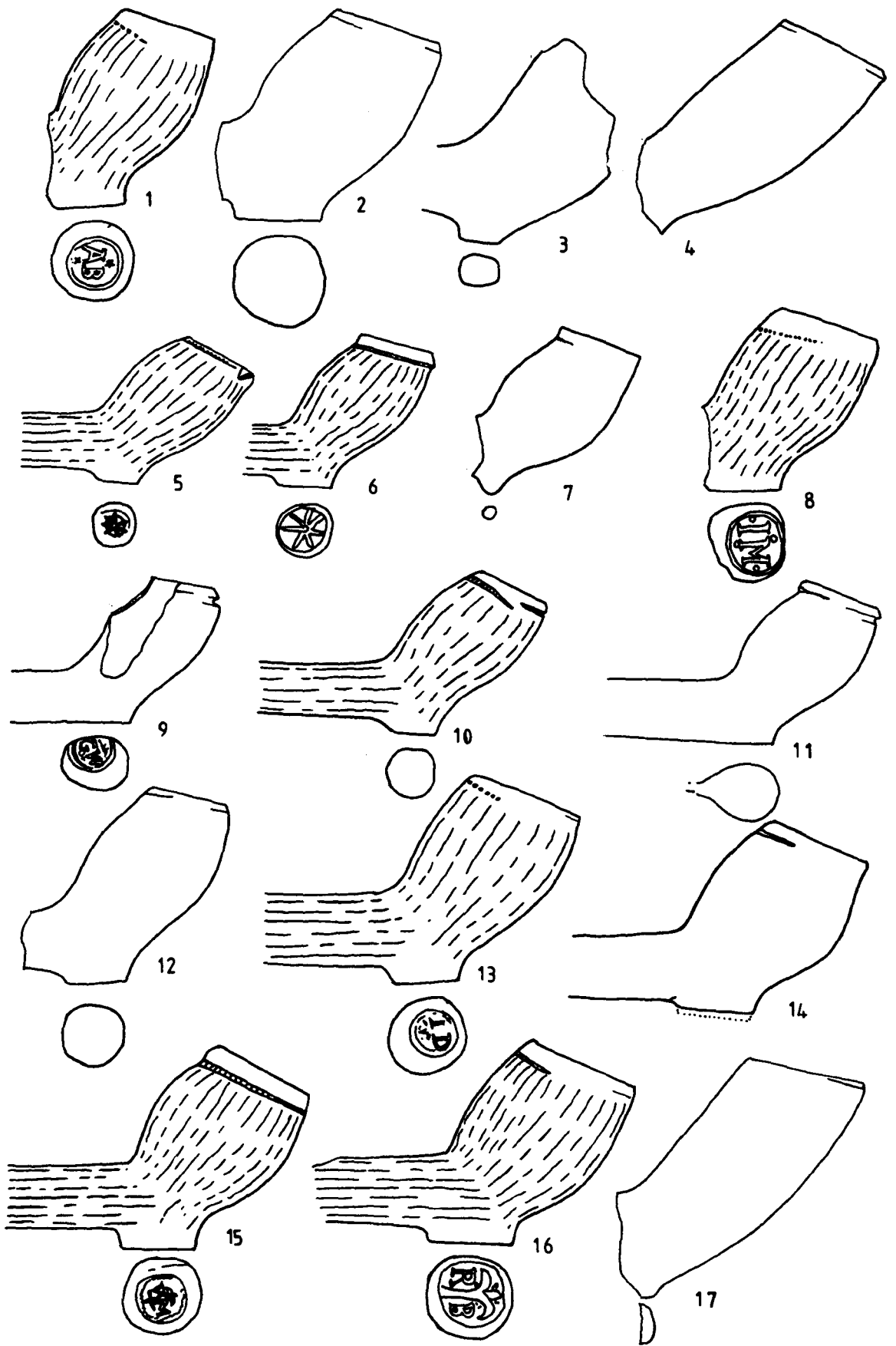
**Figure 94: Pipes held by the York Archaeological Trust, York. Scale 1:1.**



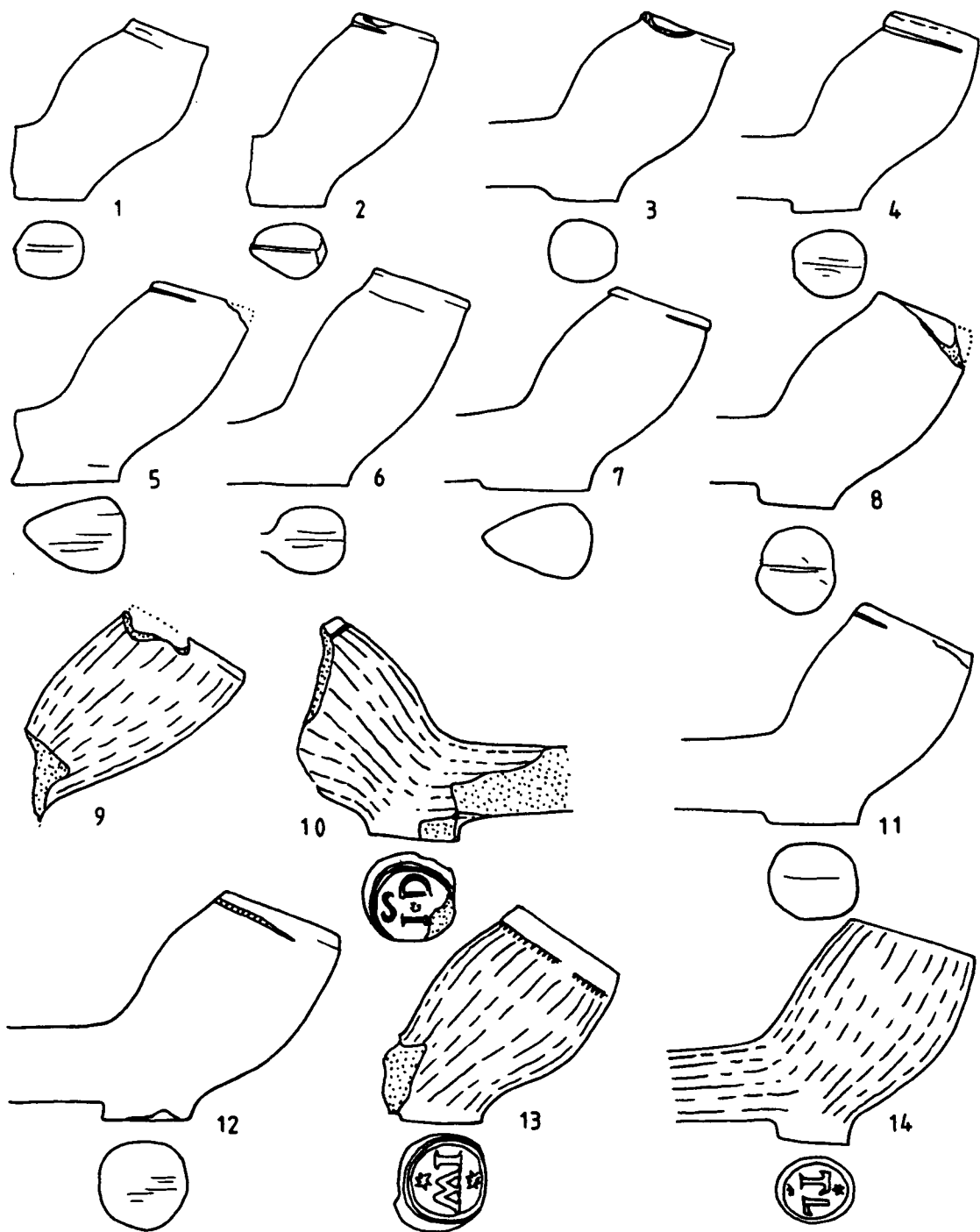
**Figure 95: Pipes held by the York Archaeological Trust, York. Scale 1:1.**



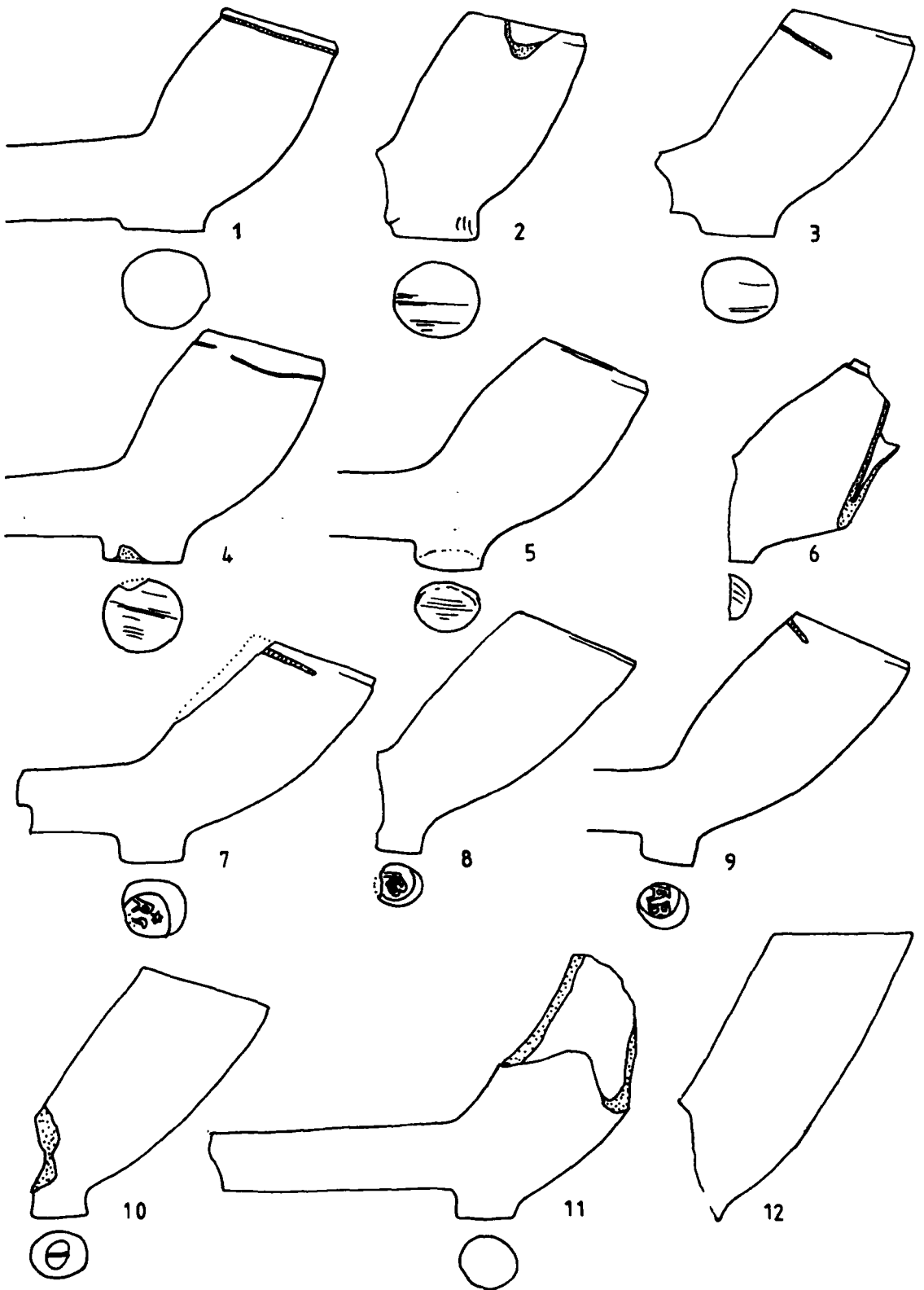
**Figure 96:** Pipes held by the York Archaeological Trust, York. Scale 1:1.



**Figure 97:** Pipes held by the York Archaeological Trust, York. Scale 1:1.

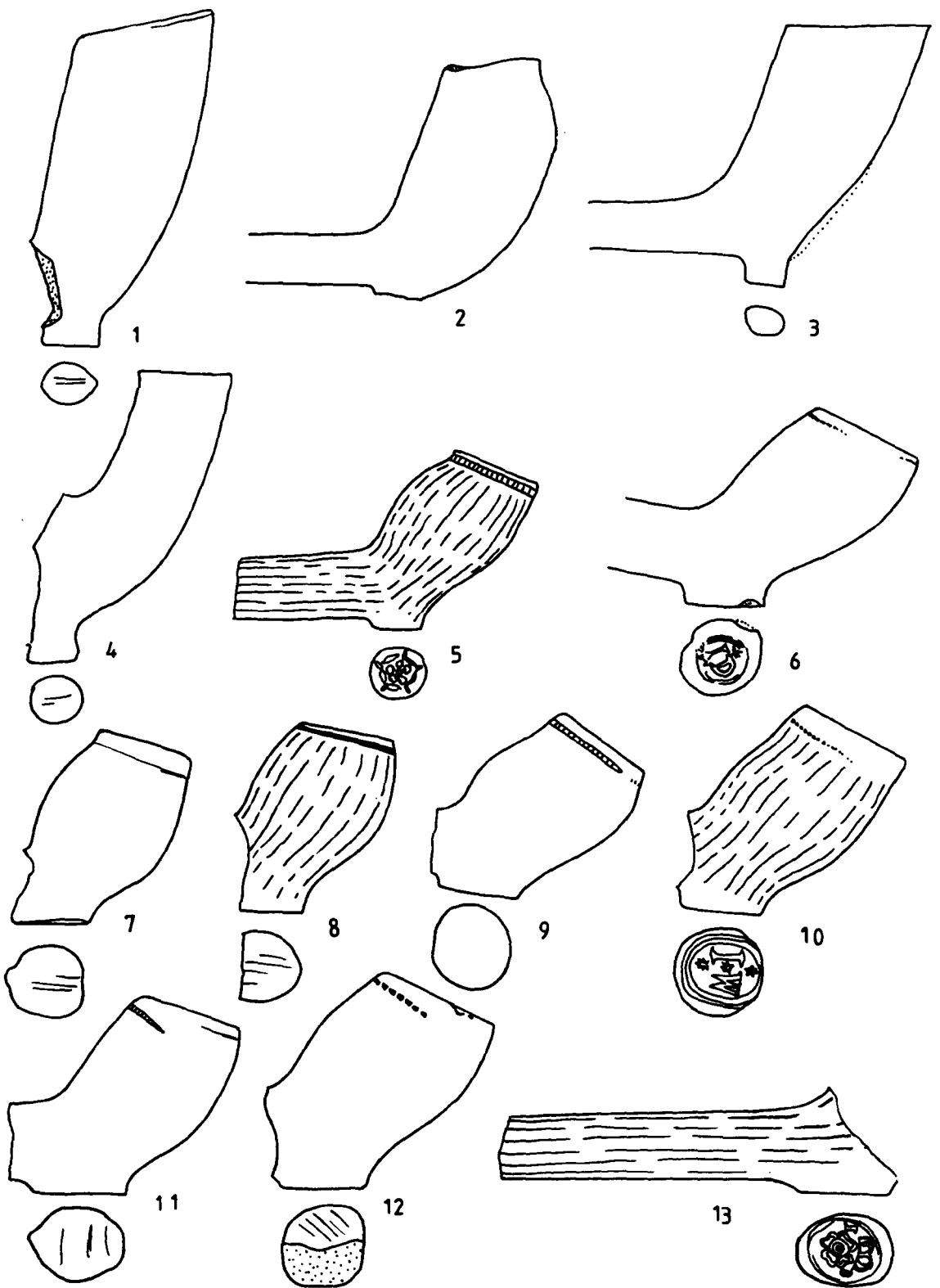


**Figure 98:** Pipes held by the York Archaeological Trust, York. Scale 1:1.

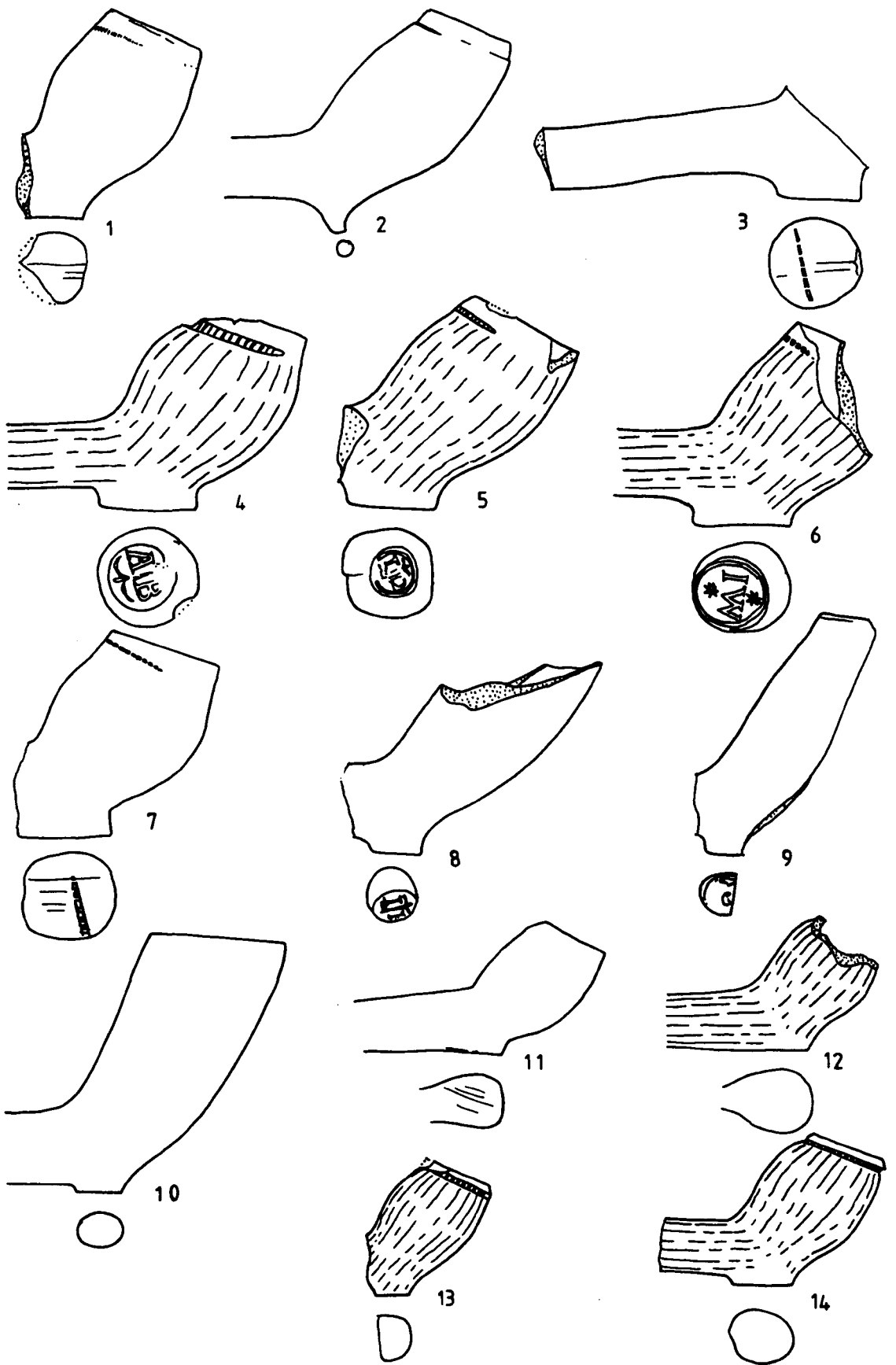


**Figure 99: Pipes held by the York Archaeological Trust, York. Scale 1:1.**

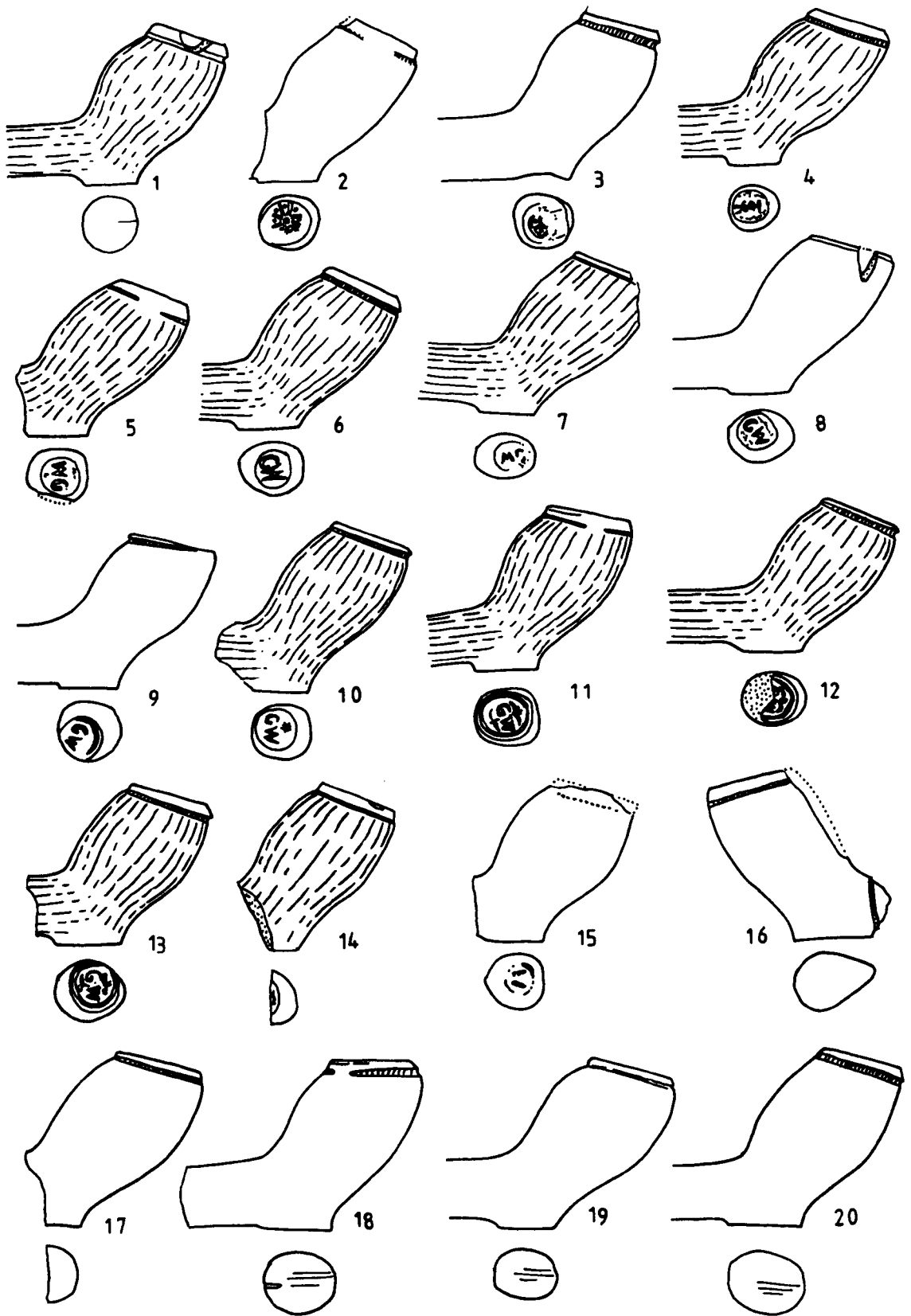




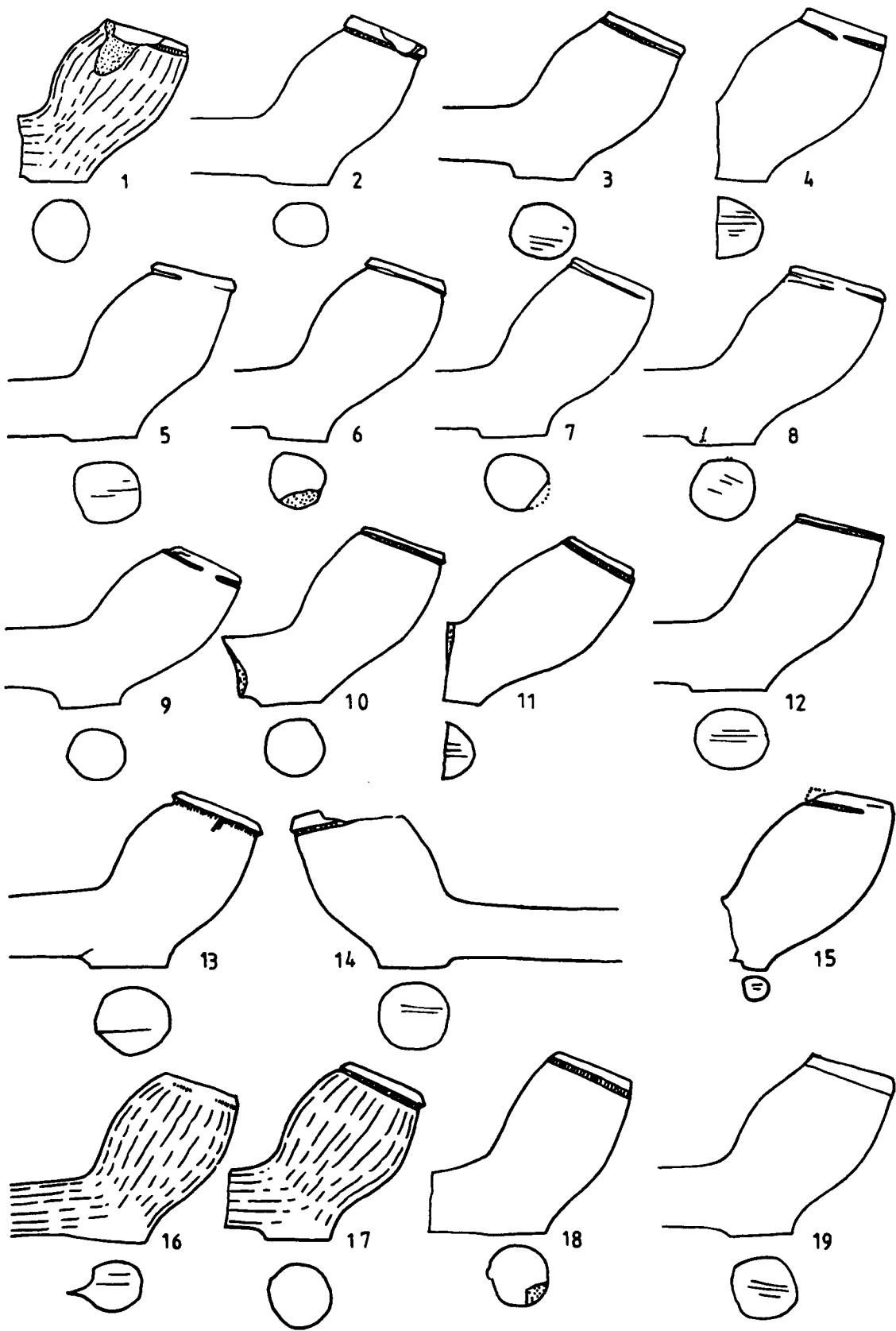
**Figure 100:** Pipes held by the York Archaeological Trust, York. Scale 1:1.



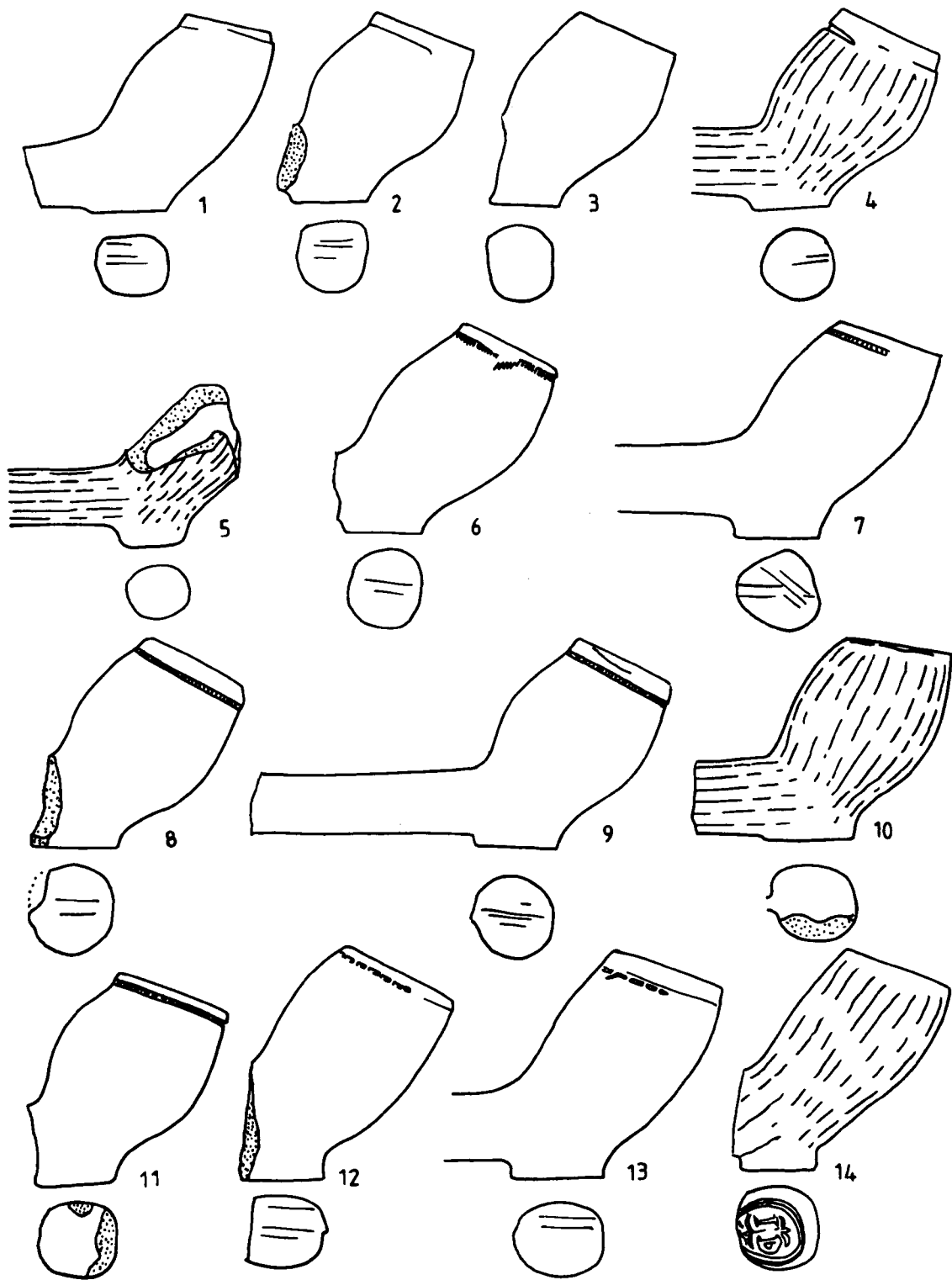
**Figure 101: Pipes held by the York Archaeological Trust, York. Scale 1:1.**



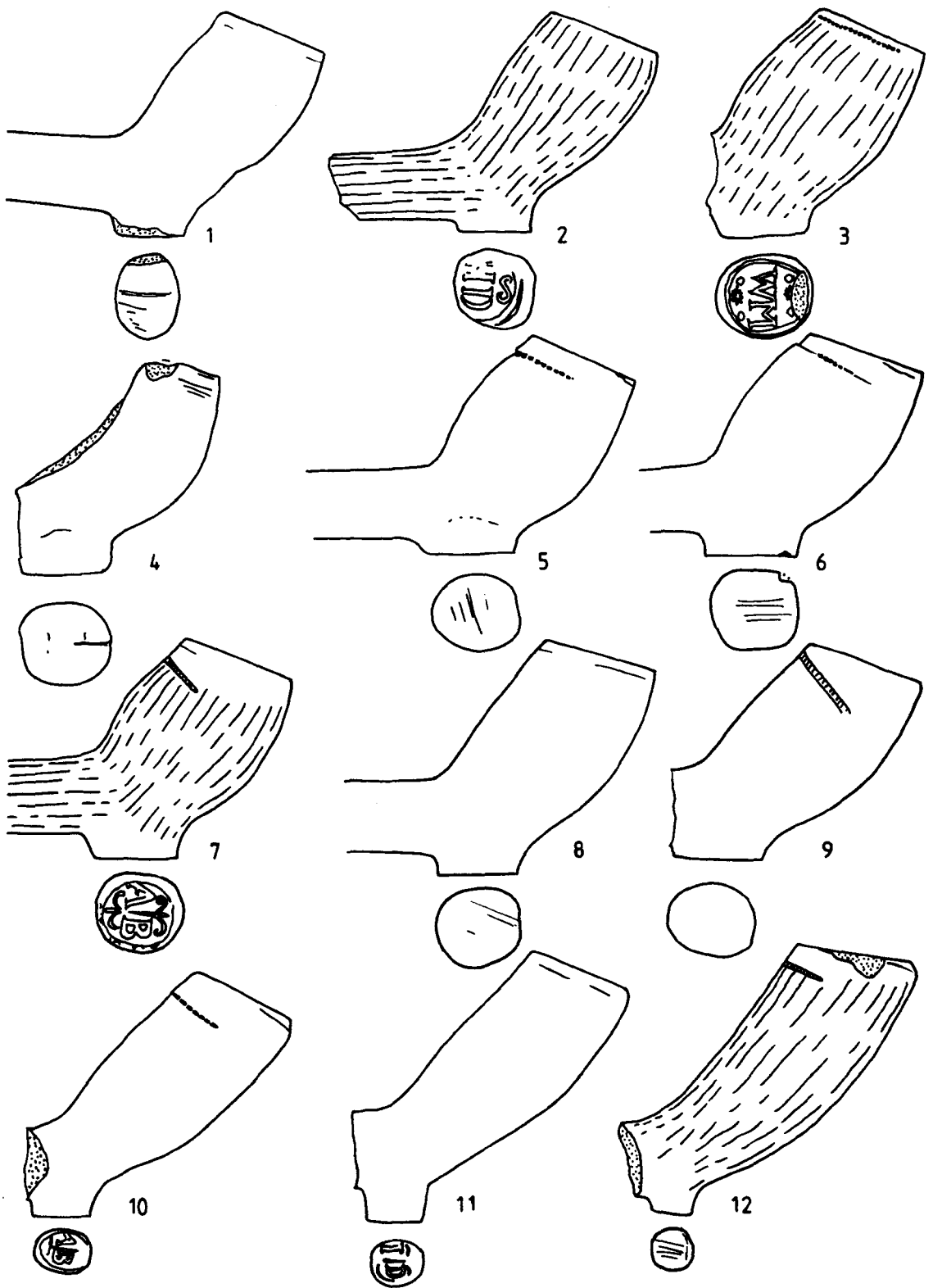
**Figure 102: Pipes held by the York Archaeological Trust, York. Scale 1:1.**



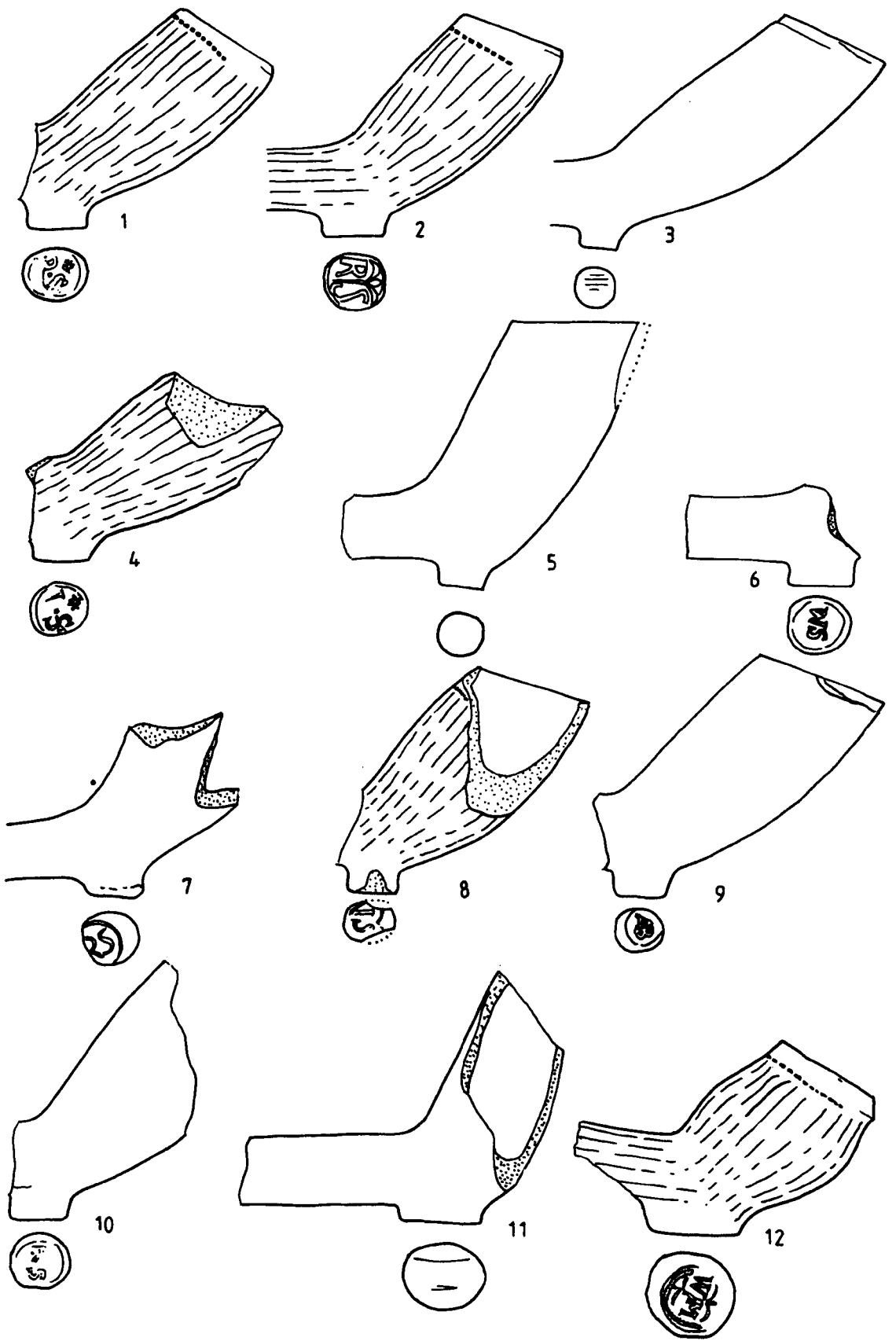
**Figure 103: Pipes held by the York Archaeological Trust, York. Scale 1:1.**



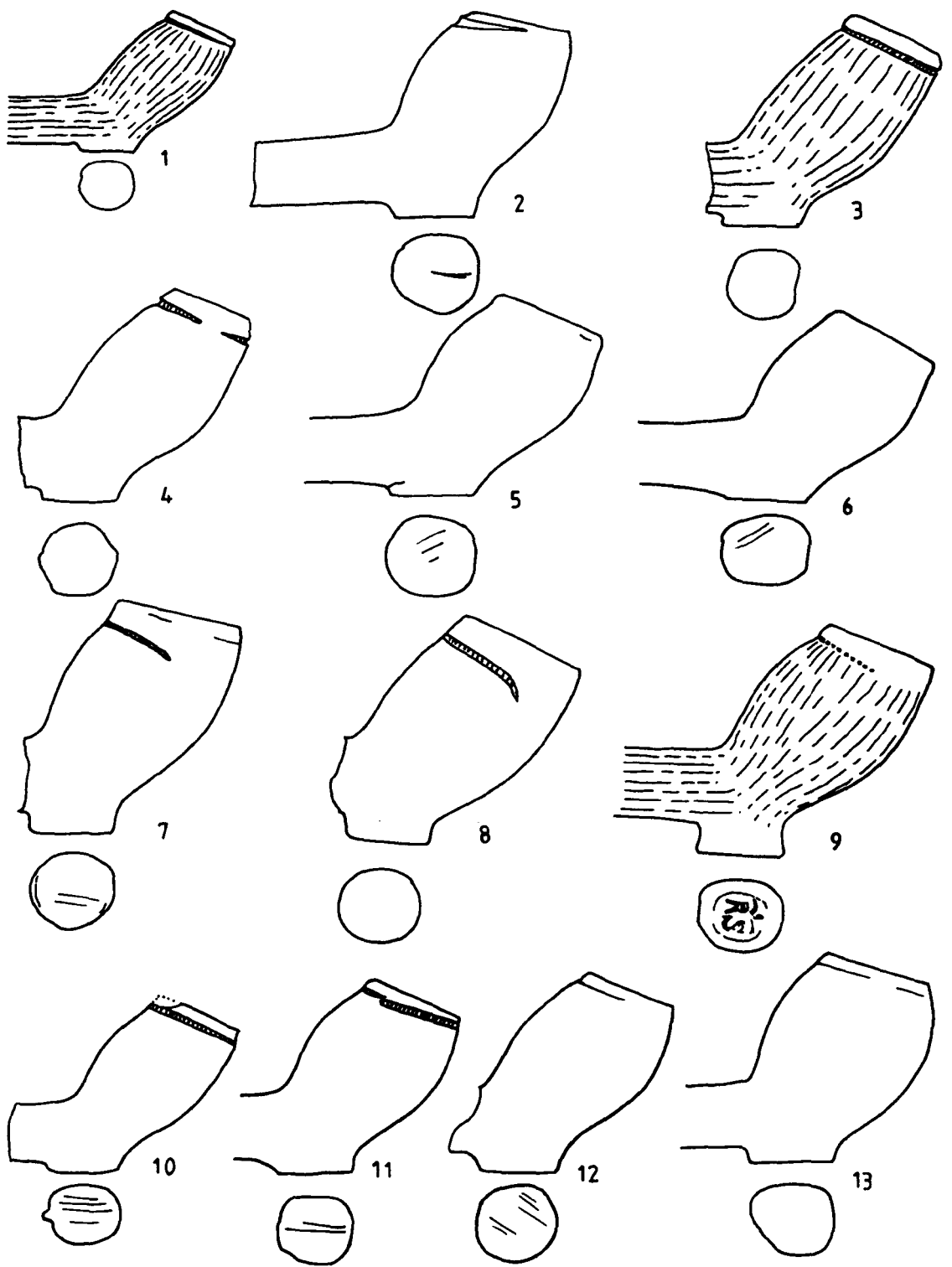
**Figure 104:** Pipes held by the York Archaeological Trust, York. Scale 1:1.



**Figure 105: Pipes held by the York Archaeological Trust, York. Scale 1:1.**

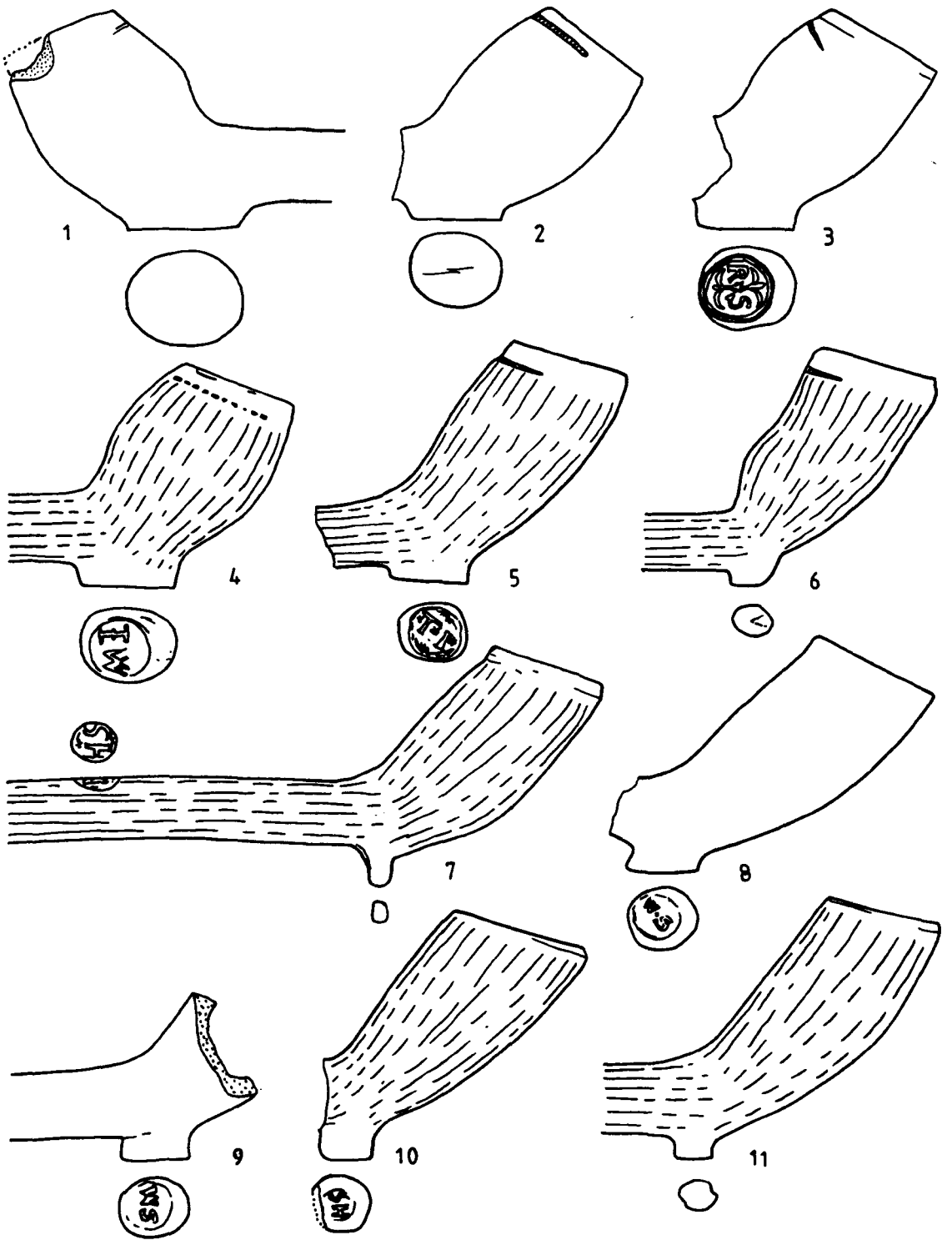


**Figure 106:** Pipes held by the York Archaeological Trust, York. Scale 1:1.

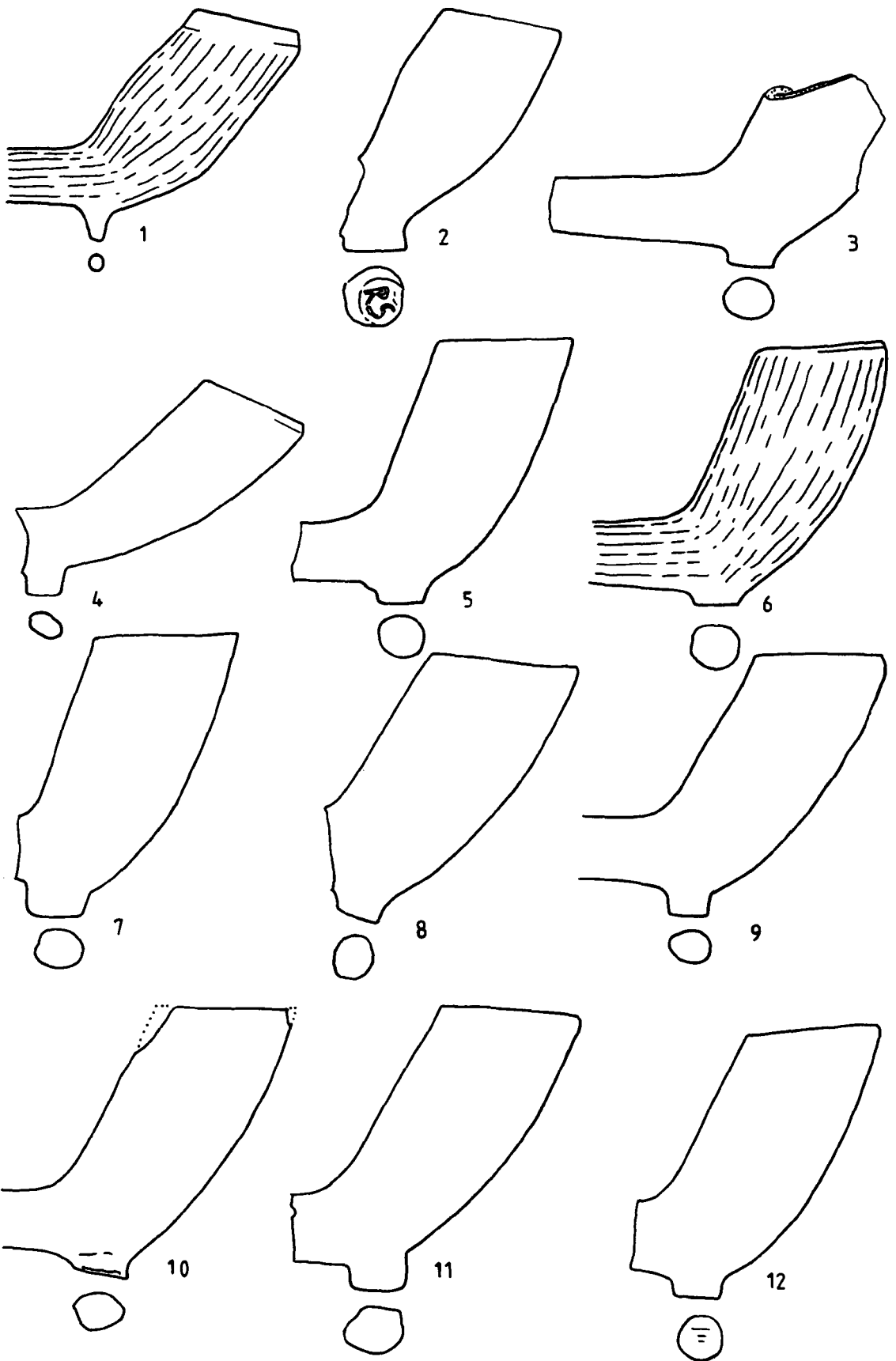


**Figure 107:** Pipes held by the York Archaeological Trust, York. Scale 1:1.

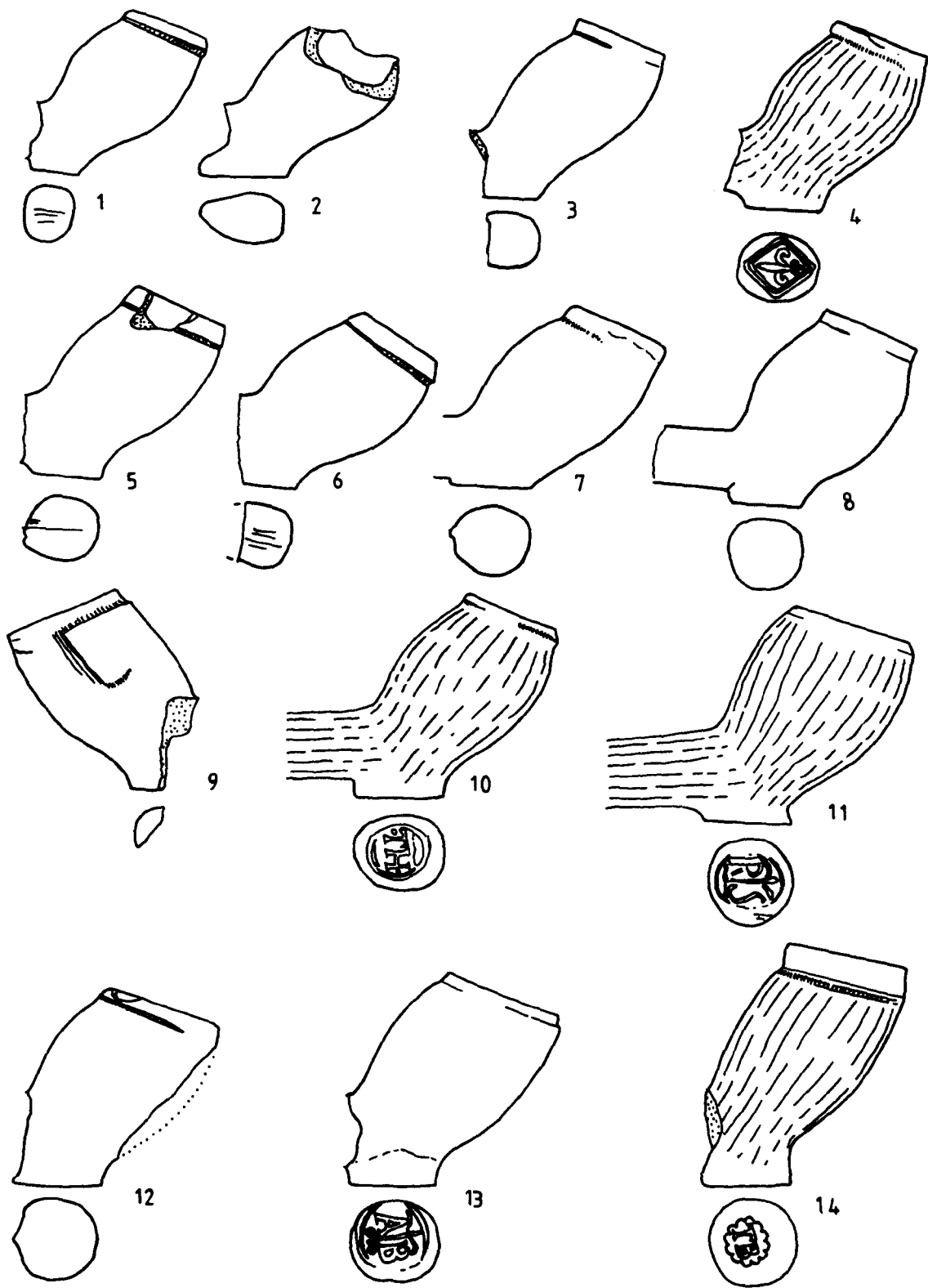




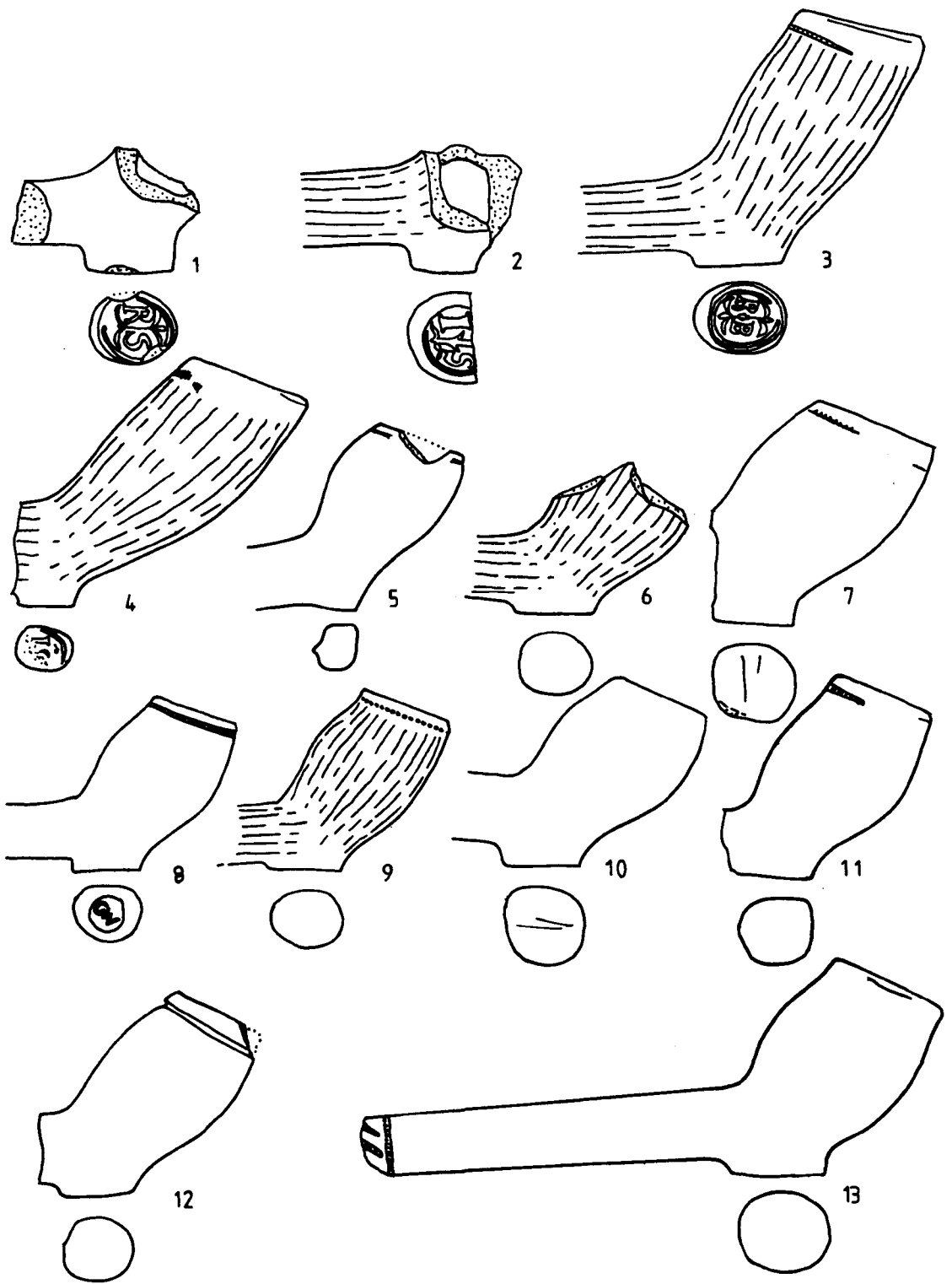
**Figure 108: Pipes held by the York Archaeological Trust, York. Scale 1:1.**



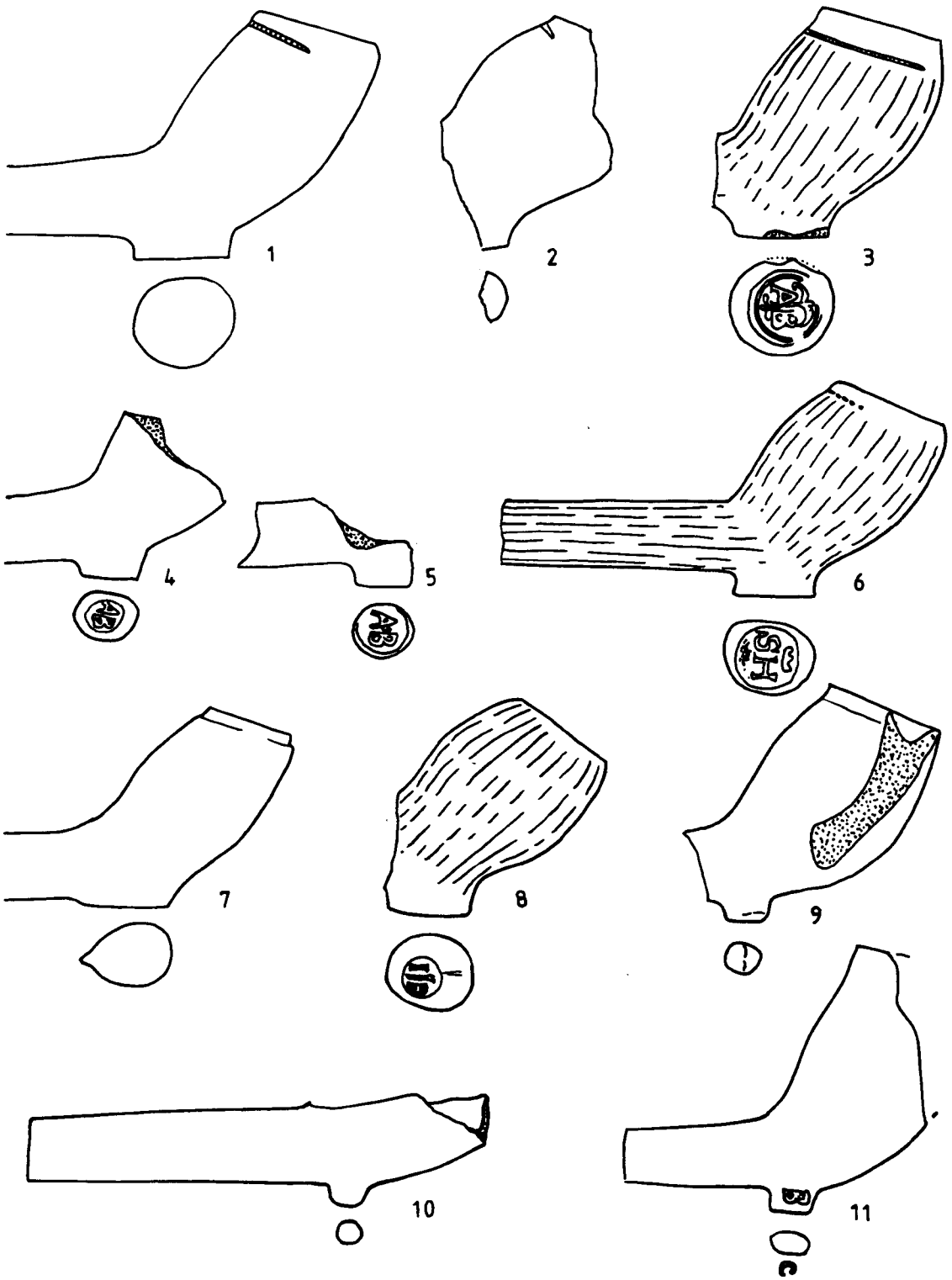
**Figure 109: Pipes held by the York Archaeological Trust, York. Scale 1:1.**



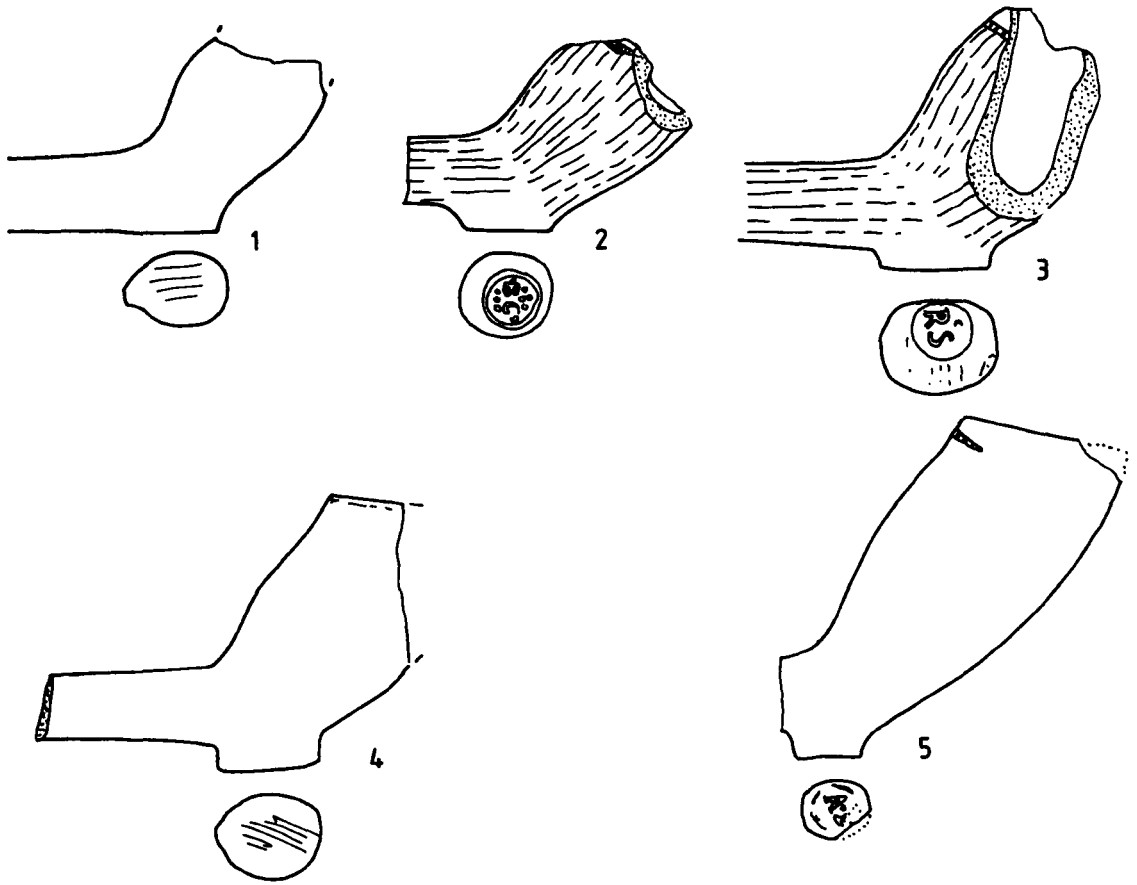
**Figure 110:** Pipes held by the York Archaeological Trust, York. Scale 1:1.



**Figure 111: Pipes held by the York Archaeological Trust, York. Scale 1:1.**



**Figure 112: Pipes held by the York Archaeological Trust, York. Scale 1:1.**



**Figure 113: Pipes held by the York Archaeological Trust, York. Scale 1:1.**

**Collection Name:** York Castle Museum  
**Collection Code:** 0150  
**Contact Name:** Sherrie Steal/Sarah Maltby  
**Address:** York, North Yorkshire

**Description:**

Collection recorded 15<sup>th</sup> September 2000. The collection comprises a large collection of clay tobacco pipes ranging in date from the seventeenth century through to the nineteenth and early twentieth century. In 1987 John Andrews prepared a detailed catalogue of the collection and included a sketch of each item.

In 2000 a total of 211 seventeenth or eighteenth century bowls from the collection were recorded in detail for inclusion in the Yorkshire database. Fifty of these bowls, previously sketched by J Andrews, were re-drawn by S D White.

The collection's most notable item is a Turkish Pipe Box containing eight complete Ottoman style bowls; a cherry wood stem measuring 5ft in length; a selection of mouthpieces in amber, ivory and ebony together with an empty glass bottle originally containing aromatic water, as well as wires and cotton for cleaning the pipes.

- 114.01 Heel type bowl dating from c1590-1610 from the Assize Court (Acc No. 148.71); rim bottered and fully milled; bore 7/64". (Pcode 07781).
- 114.02 Heel type bowl dating from c1620-1650 from the Assize Court (Acc No. 148.71); good burnish; rim bottered and fully milled; bore 7/64". Marked with a star on the heel. Marked "Cambridge". (Pcode 07780).
- 114.03 Heel type bowl dating from c1640-1660 from the Assize Court (Acc No. 147.71); rim bottered but not milled; bore 7/64". (Pcode 07766).
- 114.04 Heel type bowl dating from c1650-1670 from the Assize Court (Acc No. 147.71); good burnish; rim bottered; milled around all of the surviving rim; bore 7/64". (Pcode 07765).
- 114.05 Heel type bowl dating from c1650-1670 from the Assize Court (Acc No. 147.71); finely burnished; rim bottered and fully milled; bore 6/64". Marked with the initials WS on the heel. (Pcode 07764).
- 114.06 Heel type bowl dating from c1670-1680 from the Assize Court (Acc No. 21113.42E); rim internally trimmed and bottered; rim one quarter milled; bore 5/64". (Pcode 07782).
- 114.07 Heel type bowl dating from c1680-1700 from Blossom Street; good burnish; rim bottered but not milled; bore 7/64". Marked with the initials RS on the heel (Pcode 07888).
- 114.08 Heel type bowl dating from c1680-1710 from Falcon Street (Acc No. 1882); average burnish; rim bottered and half milled; bore 6/64". Marked with the initials TA on the heel (Pcode 07961).

- 114.09 Heel type bowl dating from c1620-1640 from Sand & gravel pit (Acc No. 212/42E); good burnish; rim bottered; milled around all of the surviving rim; bore 8/64". (Pcode 07968).
- 114.10 Heel type bowl dating from c1640-1660 from Sand & gravel pit (Acc No. 212/42I); no internal bowl cross; rim bottered but not milled; bore 6/64". (Pcode 07969).
- 114.11 Heel type bowl dating from c1620-1640 unprovenanced but probably from York (Acc No. 615.77f); finely burnished; rim bottered and fully milled; bore 7/64". (Pcode 07793).
- 114.12 Heel type bowl dating from c1640-1660 unprovenanced but probably from York; rim bottered and fully milled; bore 7/64". (Pcode 07801).
- 114.13 Heel type bowl dating from c1640-1660 unprovenanced but probably from York; rim bottered; milled around all of the surviving rim; bore 7/64". (Pcode 07798).
- 114.14 Heel type bowl dating from c1650-1670 unprovenanced but probably from York (Acc No. 147.71); rim bottered and fully milled; bore 6/64". On loan to Dorman Museum, Middlesborough. (Pcode 07784).
- 115.01 Spur type bowl dating from c1650-1670 unprovenanced but probably from York; no internal bowl cross; rim bottered and one quarter milled; bore 6/64". (Pcode 07800).
- 115.02 Spur type bowl dating from c1650-1680 unprovenanced but probably from York; no internal bowl cross; rim bottered and fully milled; bore 6/64". Marked with the initials IB on the bowl facing the smoker. Possible Rainford product. (Pcode 07802).
- 115.03 Spur type bowl dating from c1650-1670 unprovenanced but probably from York; rim bottered and fully milled; bore 7/64". (Pcode 07803).
- 115.04 Heel type bowl dating from c1660-1680 unprovenanced but probably from York; rim bottered and half milled; bore 7/64". Heart-shaped heel. (Pcode 07797).
- 115.05 Heel type bowl dating from c1660-1650 unprovenanced but probably from York; rim internally trimmed and bottered; rim one quarter milled; bore 6/64". In a box labelled "YH 1014". (Pcode 07799).
- 115.06 Heel type bowl dating from c1660-1680 unprovenanced but probably from York; average burnish; rim bottered but not milled; bore 7/64". Marked with the initials IB on the heel. Similar to Hull Type 2. (Pcode 07806).
- 115.07 Heel type bowl dating from c1660-1680 unprovenanced but probably from York; rim bottered and one quarter milled; bore 7/64". Marked with the

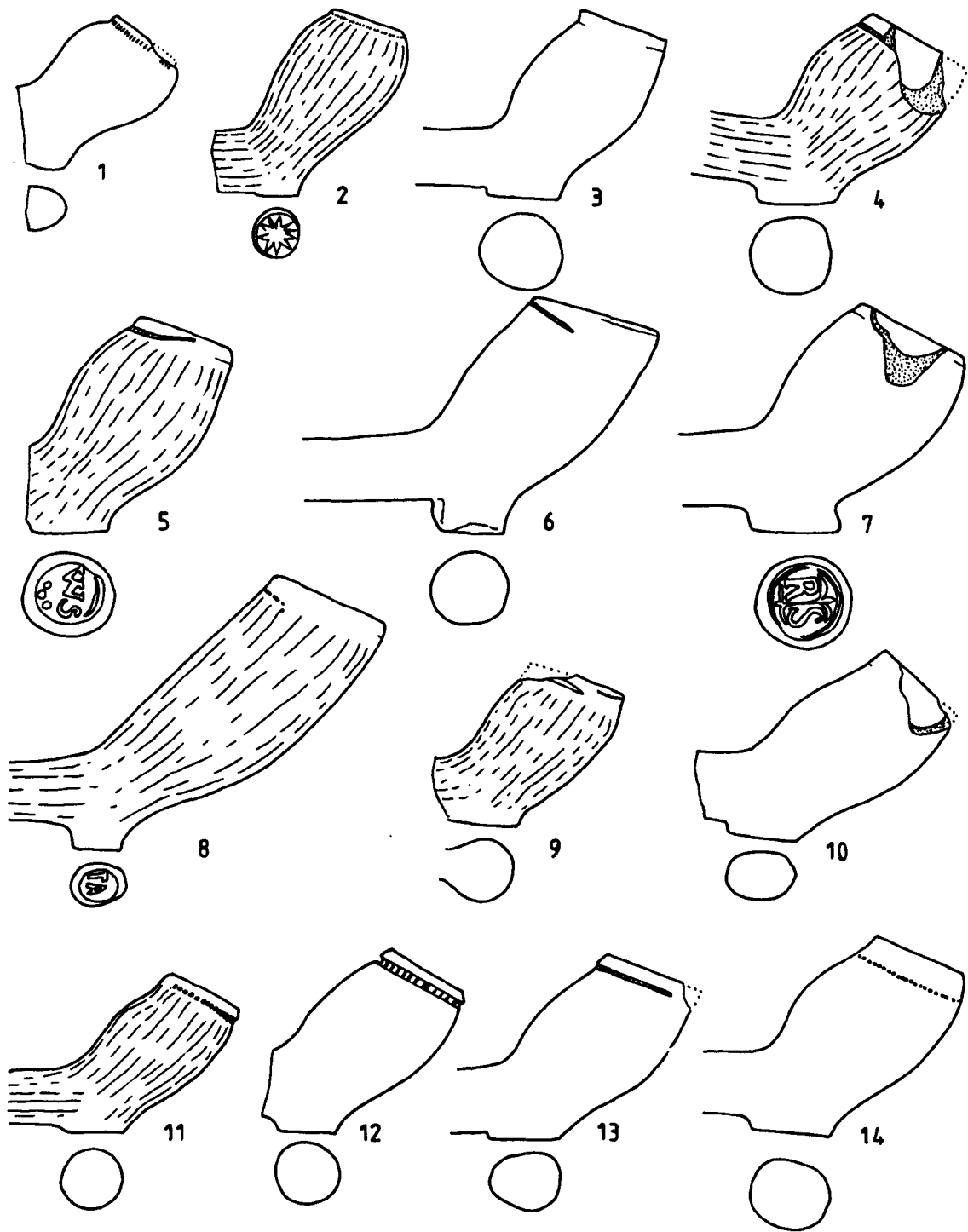


initials SI on the heel. Labelled "Pontefract maker"; shiny surface; S reversed. (Pcode 07808).

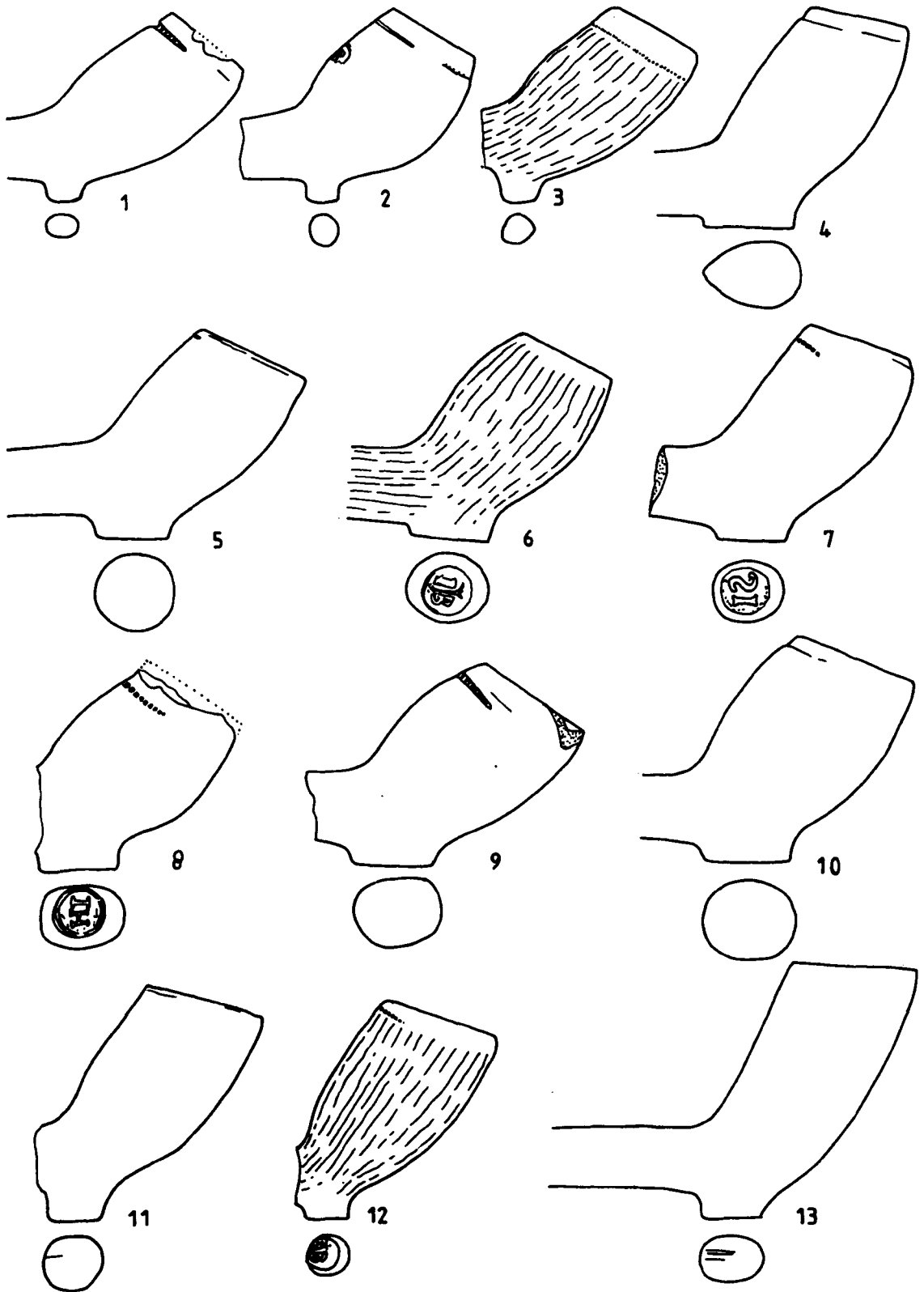
- 115.08 Heel type bowl dating from c1650-1670 unprovenanced but probably from York; no internal bowl cross; rim bottered and half milled; bore 7/64". Marked with the initials IH on the heel (Pcode 07807).
- 115.09 Heel type bowl dating from c1660-1680 unprovenanced but probably from York; rim internally trimmed and bottered; milled around all of the surviving rim; bore 7/64". (Pcode 07796).
- 115.10 Heel type bowl dating from c1660-1680 unprovenanced but probably from York (Acc No. 615.77c); rim bottered but not milled; bore 7/64". Shiny surface but no apparent burnish lines. (Pcode 07790).
- 115.11 Heel type bowl dating from c1680-1720 unprovenanced but probably from York; rim internally trimmed and bottered but not milled; bore 5/64". (Pcode 07804).
- 115.12 Heel type bowl dating from c1680-1710 unprovenanced but probably from York; finely burnished; rim bottered and one quarter milled; bore 4/64". Marked with the initials AB on the heel. Possibly Dutch. (Pcode 07805).
- 115.13 Heel type bowl dating from c1700-1770 unprovenanced but probably from York (Acc No. 26.71); rim wiped; rim not milled; bore 6/64". On loan to Dorman Museum, Middlesborough. (Pcode 07783).
- 116.01 Heel type bowl dating from c1700-1770 unprovenanced but probably from York; rim cut but not milled; bore 5/64". On loan to Dorman Museum, Middlesborough; smoked after stem broken - see groove. (Pcode 07795).
- 116.02 Spur type bowl dating from c1620-1640 unprovenanced from Yorkshire Museum, York (Acc No. 26.71); rim bottered and fully milled; bore 7/64". (Pcode 07896).
- 116.03 Heel type bowl dating from c1630-1640 unprovenanced from Yorkshire Museum, York (Acc No. 26.71); rim bottered and fully milled; bore 7/64". Milling very low. (Pcode 07895).
- 116.04 Heel type bowl dating from c1640-1660 unprovenanced from Yorkshire Museum, York (Acc No. 26.71); average burnish; rim bottered but not milled; bore 6/64". Heart-shaped heel. (Pcode 07897).
- 116.05 Heel type bowl dating from c1640-1660 unprovenanced from Yorkshire Museum, York (Acc No. 26.71); rim bottered; milled around all of the surviving rim; bore 9/64". Marked with the initials GC on the heel (Pcode 07894).

- 116.06 Heel type bowl dating from c1640-1660 unprovenanced from Yorkshire Museum, York (Acc No. YM974/4); rim bottered but not milled; bore 6/64". (Pcode 07950).
- 116.07 Heel type bowl dating from c1640-1660 unprovenanced from Yorkshire Museum, York (Acc No. 26.71); rim bottered and fully milled; bore 7/64". (Pcode 07889).
- 116.08 Heel type bowl dating from c1650-1670 unprovenanced from Yorkshire Museum, York (Acc No. 26.71); no internal bowl cross; rim bottered but not milled; bore 7/64". Marked with the initials ID on the heel (Pcode 07900).
- 116.09 Heel type bowl dating from c1640-1660 unprovenanced from Yorkshire Museum, York (Acc No. 26.71); rim bottered and fully milled; bore 7/64". Marked with the initials TD on the heel (Pcode 07893).
- 116.10 Heel type bowl dating from c1660-1680 unprovenanced from Yorkshire Museum, York (Acc No. 26.71); rim bottered and half milled; bore 6/64". (Pcode 07891).
- 116.11 Heel type bowl dating from c1650-1670 unprovenanced from Yorkshire Museum, York (Acc No. 26.71); good burnish; rim bottered and fully milled; bore 7/64". Marked with the initials HF (Fleur-de-lys) on the heel (Pcode 07901).
- 117.01 Heel type bowl dating from c1650-1670 unprovenanced from Yorkshire Museum, York (Acc No. 26.71); finely burnished; rim bottered and half milled; bore 7/64". Marked with the initials ID on the heel. Similar to York Type 8; very neat. (Pcode 07902).
- 117.02 Heel type bowl dating from c1660-1680 unprovenanced from Yorkshire Museum, York (Acc No. 26.71); good burnish; rim bottered and three quarters milled; bore 6/64". Marked with the initials IS on the heel (Pcode 07899).
- 117.03 Spur type bowl dating from c1660-1680 unprovenanced from Yorkshire Museum, York (Acc No. 26.71); rim bottered and half milled; bore 7/64". Shiny surface but no obvious burnish lines. (Pcode 07898).
- 117.04 Heel type bowl dating from c1670-1680 unprovenanced from Yorkshire Museum, York (Acc No. 26.71); no internal bowl cross; rim bottered and half milled; bore 7/64". Marked with the initials RS on the heel (Pcode 07904).
- 117.05 Heel type bowl dating from c1660-1690 unprovenanced from Yorkshire Museum, York (Acc No. 26.71); good burnish; rim bottered and one quarter milled; bore 6/64". Marked with the initials WS on the heel (Pcode 07892).

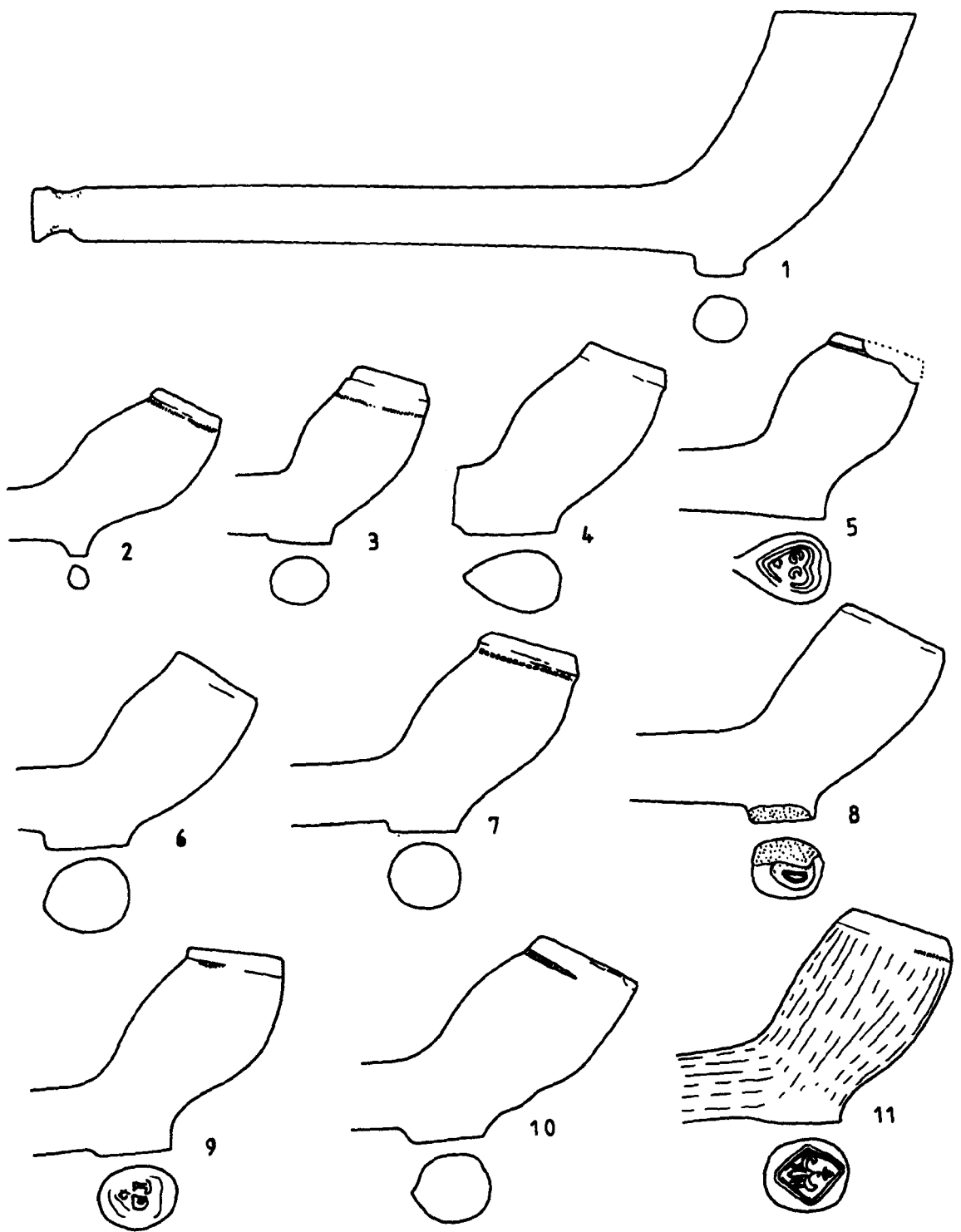
- 117.06 Heel type bowl dating from c1670-1710 unprovenanced from Yorkshire Museum, York (Acc No. 26.71); good burnish; rim bottered and half milled; bore 7/64". Marked with the initials RS on the heel (Pcode 07903).
- 117.07 Heel type bowl dating from c1680-1710 unprovenanced from Yorkshire Museum, York (Acc No. 26.71); rim internally trimmed and bottered; rim one quarter milled; bore 6/64". (Pcode 07890).
- 117.08 Heel type bowl dating from c1620-1640 from general; rim bottered and fully milled; bore 7/64". (Pcode 07964).
- 117.09 Heel type bowl dating from c1660-1675 from general (Acc No. Malton 1835); rim internally trimmed and bottered but not milled; bore 7/64". (Pcode 07963).
- 117.10 Spur type bowl dating from c1650-1680 unprovenanced material but probably from Rothwell, Leeds (Acc No. 170.49); rim bottered and fully milled; bore 7/64". Label reads "Mr Booth, 33 Willow Ave., Rothwell, Leeds". (Pcode 07958).
- 117.11 Heel type bowl dating from c1650-1670 unprovenanced material from Escrick (Acc No. 1106/6/50); rim bottered but not milled; bore 8/64". (Pcode 07885).
- 117.12 Heel type bowl dating from c1660-1680 unprovenanced material from Escrick (Acc No. 1106/5/50); rim bottered but not milled; bore 7/64". (Pcode 07884).
- 118.01 Heel type bowl dating from c1650-1670 unprovenanced material from Beverley; rim bottered but not milled; bore 7/64". (Pcode 07954).
- 118.02 Heel type bowl dating from c1660-1680 from Walmgate Bar (Acc No. X11.1938); rim bottered and half milled; bore 7/64". York Type 10. (Pcode 07971).
- 118.03 Heel type bowl dating from c1650-1680 from ?Bristol (Acc No. 148.71); rim bottered and fully milled; bore 6/64". (Pcode 07955).
- 118.04 Half of a broken hair curler dating from the seventeenth or eighteenth century.
- 118.05 Half of a broken hair curler marked with the initials WB; dating from the seventeenth or eighteenth century.



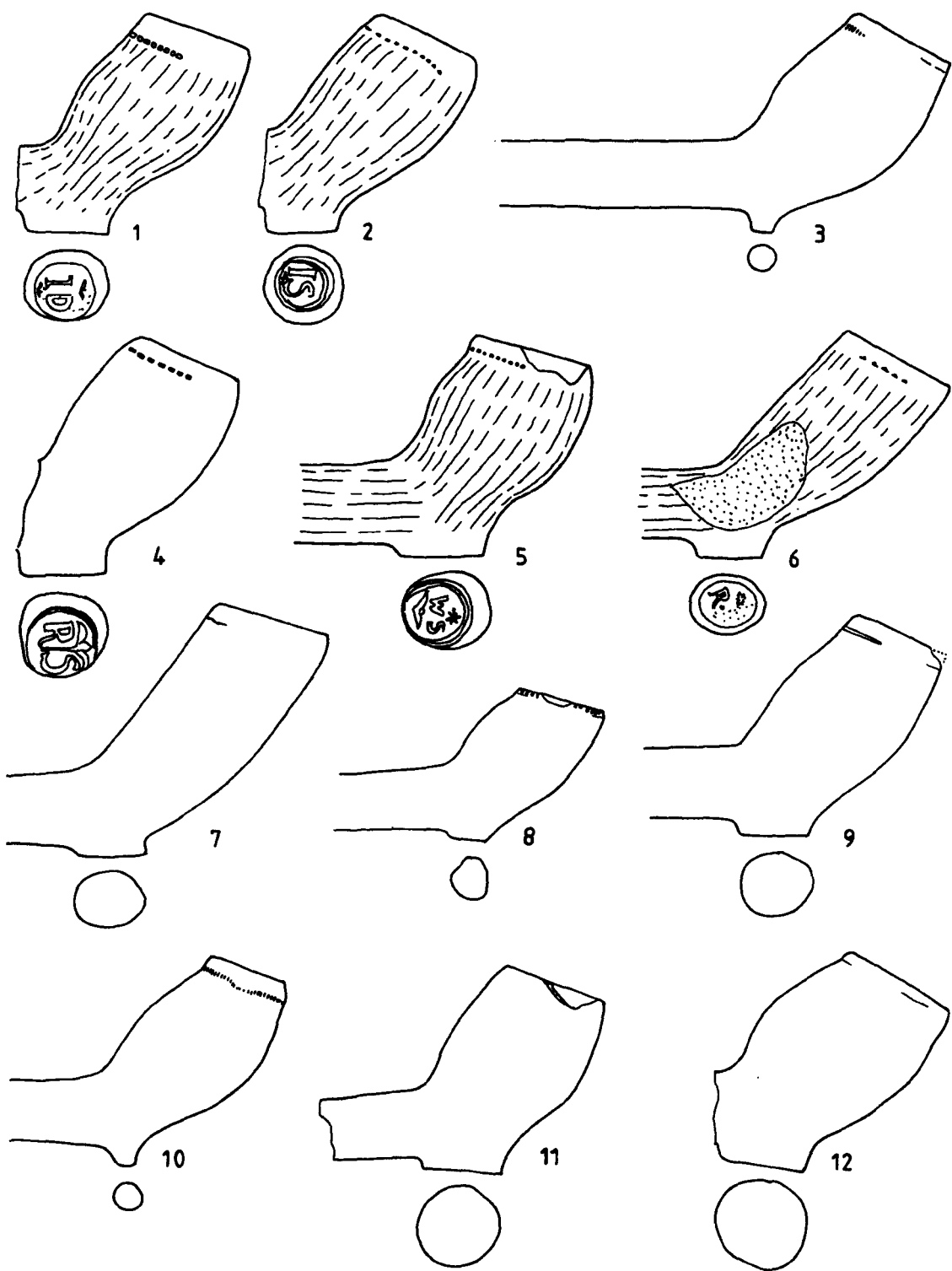
**Figure 114:** Pipes from the collections of York Castle Museum, York. Scale 1:1.



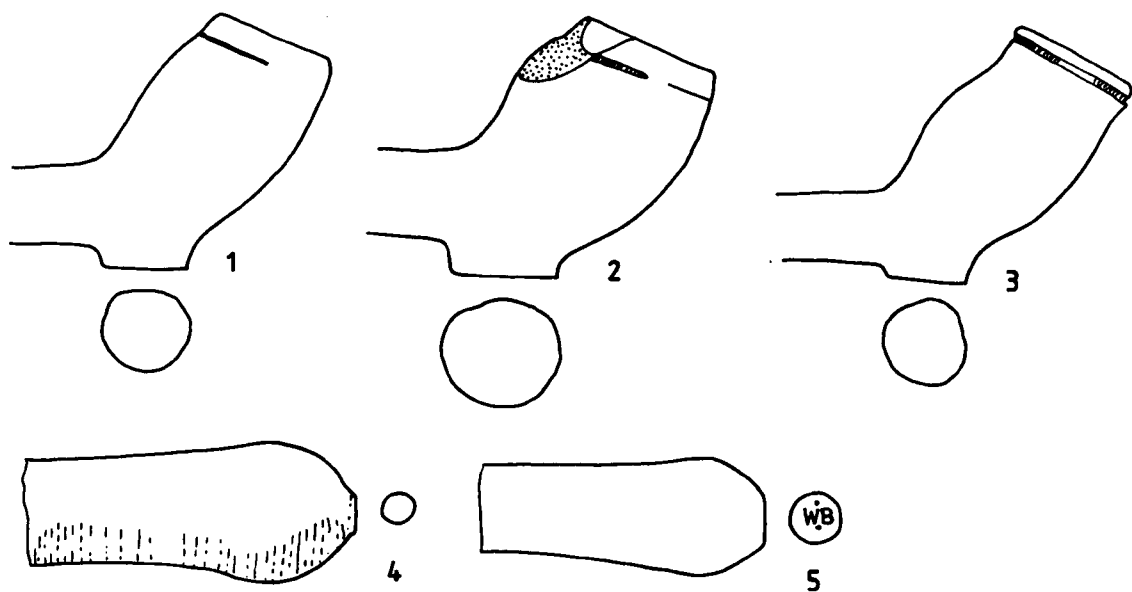
**Figure 115:** Pipes from the collections of York Castle Museum, York. Scale 1:1.



**Figure 116: Pipes from the collections of York Castle Museum, York. Scale 1:1.**



**Figure 117: Pipes from the collections of York Castle Museum, York. Scale 1:1.**



**Figure 118:** Pipes and hair curlers from the collections of York Castle Museum, York. Scale 1:1.



**Collection Name:** Abbey House Museum  
**Collection Code:** 0130  
**Contact Name:** Mrs Bridgewater  
**Address:** Kirkstall, Leeds, South Yorkshire

**Description:**

Collection recorded on 2<sup>nd</sup> May 1995. Collection included approximately 35 bowls of seventeenth- or eighteenth-century date, which include six with stamped marks. Also included a range of nineteenth-century mould decorated bowls as well as miscellaneous papers and photographs relating to the pipemaker Samson Strong and his pipeworks.

Most notable later pipes include:

- E/28/1967/4 – Complete cadger pipe with football and boot; boot is coloured black, the ball is coloured yellow
- Complete miniature pipe with spur and moulded milling
- Plain spur pipe, which appears to be unfired.
- Complete Ben Nevis cutty with red paper label reading “McDougall’s Scotch porous pipe – quality guaranteed” on stem; varnished finish
- E/84/1962-10 – two Ben Nevis cutty pipes as above
- E/83/1968 – Complete pipe with thick spur complete with silver cap; cotton binding on tip.
- Two broken fluted bowls with leaf decorated seams and rope design around the rim.
- E/83/1968 – Broken long stemmed pipe with fluted bowl and leaf decorated seams; rope design around the rim; similar to the above.
- For Auld Lang Syne cutty pipe.
- Complete acorn pipe
- Complete Hussars pipe
- E/28/1968 – Complete TW cutty with hatched star on right-hand side. Rubber stamp on the left-hand side reading HAROLD BEST/COMMERCIAL HOTEL/WHINGATE/HOME BREWED ALES
- Complete claw pipe
- 104.31.53 – Ladies head and bonnet, glazed details marked L. FIOLET
- E/30/1967/1 – Stem with number 250 stamped on left-hand side; original a figure or animal on the top of the stem behind the bowl but this has broken off.
- 189 – Meerschaum claw pipe
- 104/38/53 – Asbestos pipe with metal mount
- 104/54/53 – Sub-stemmed pipe in form of a hand holding the bowl. LF stamped below the wrist
- 104/57/53 – Dark brown stoneware pipe with fluted design, possibly American
- E/41/1967/11 – Decorated bowl with figure of justice on right-hand side; possibly father time on left-hand side and a heart in hand motif on the bowl seam facing the smoker.
- E/44/1973/3 – Elaborate French pipe possibly commemorating the revolution; stamped LF on base of bowl; lettering 23.24.25 FEVRIER on side of the stem.

- 104/56/53 – Dublin bowl
- 104/60/53 – Early nineteenth-century Masonic bowl
- 104/59/53 – For Auld Lang Syne pipe
- 104/64/53 – Bird either side of the bowl; leaf decorated seams; possibly German
- 104/64/53 – Dog either side of the bowl; possibly German
- 104/64/53 – Basket design; possibly German

Photographs in a loose folder include the following:

- Photo of Samson Strong's workshop, York Road, Leeds (outside)
- 14 photos illustrating pipe workshop at the museum/production process
- 4 photos of Samson Strong in his workshop, Jun 11 1934 from York Evening Post
- 4 photos of the kiln
- 2 exterior views of ?a pipe workshop (the chimney looks different to the York Road one)
- Cutting from Yorkshire Post, Sept 7 1951 giving details of Samson Strong
- 2 copies of Shepherds 1912 (Hull pipes)

119.01 Heel type bowl dating from c1640-1660 unprovenanced but probably from Leeds; rim bottered and fully milled. Marked with wheel on the heel. (Pcode 08262).

119.02 Heel type bowl dating from c1640-1660 unprovenanced but probably from Leeds (Acc No. 104/64/53); fully milled. (Pcode 05896).

119.03 Heel type bowl dating from c1640-1660 unprovenanced but probably from Leeds (Acc No. 104/64/53); fully milled. (Pcode 05897).

119.04 Heel type bowl dating from c1660-1680 unprovenanced but probably from Leeds; rim bottered and three quarters milled. (Pcode 05883).

119.05 Heel type bowl dating from c1660-1690 unprovenanced but probably from Leeds; rim bottered and half milled. (Pcode 05884).

119.06 Heel type bowl dating from c1660-1680 unprovenanced but probably from Leeds (Acc No. 104/64/53); rim three quarters milled. (Pcode 05899).

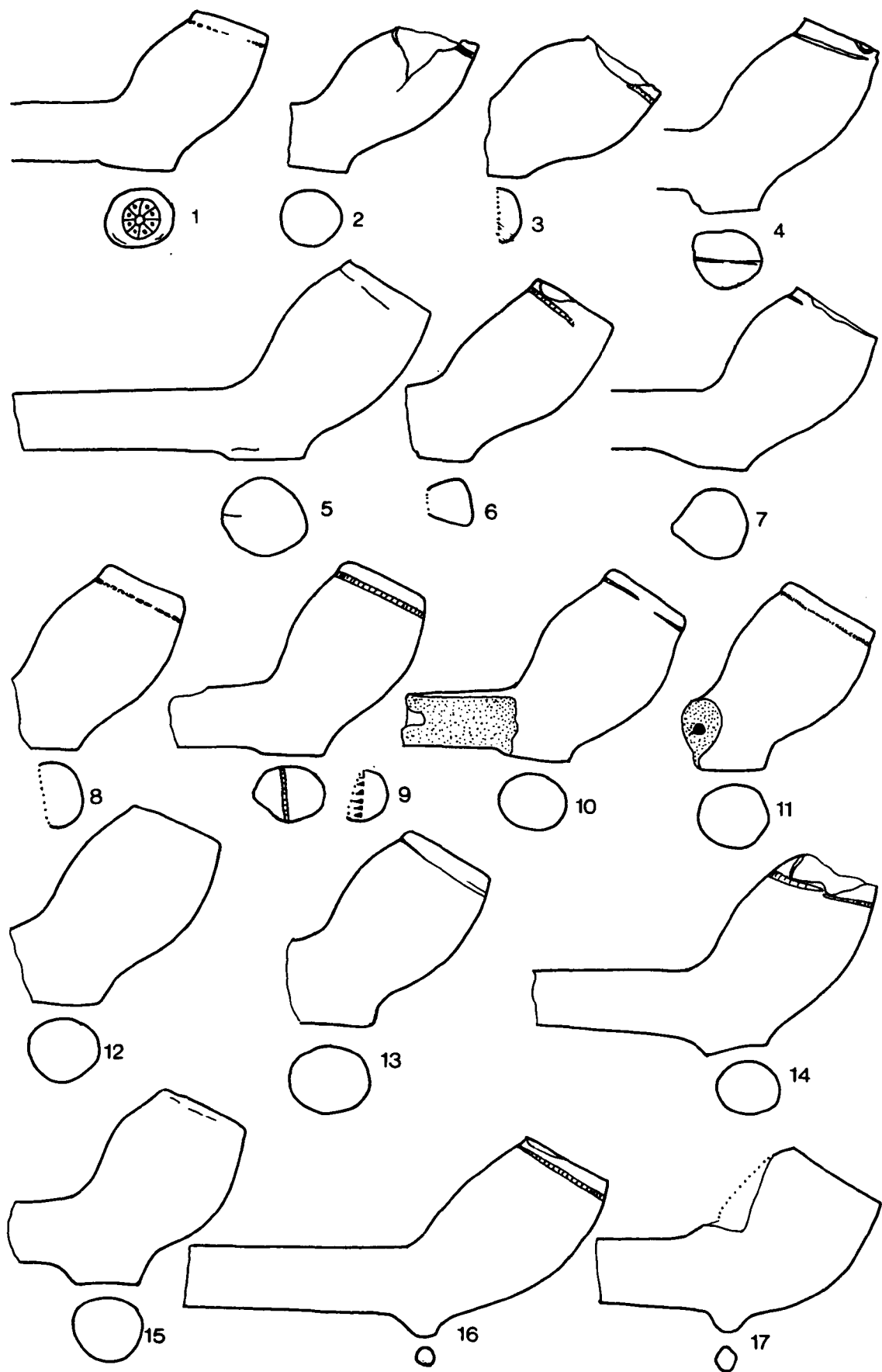
119.07 Heel type bowl dating from c1650-1670 unprovenanced but probably from Leeds (Acc No. 104/64/53); rim one quarter milled. (Pcode 05900).

119.08 Heel type bowl dating from c1650-1670 unprovenanced but probably from Leeds (Acc No. 104/64/53); fully milled. (Pcode 05901).

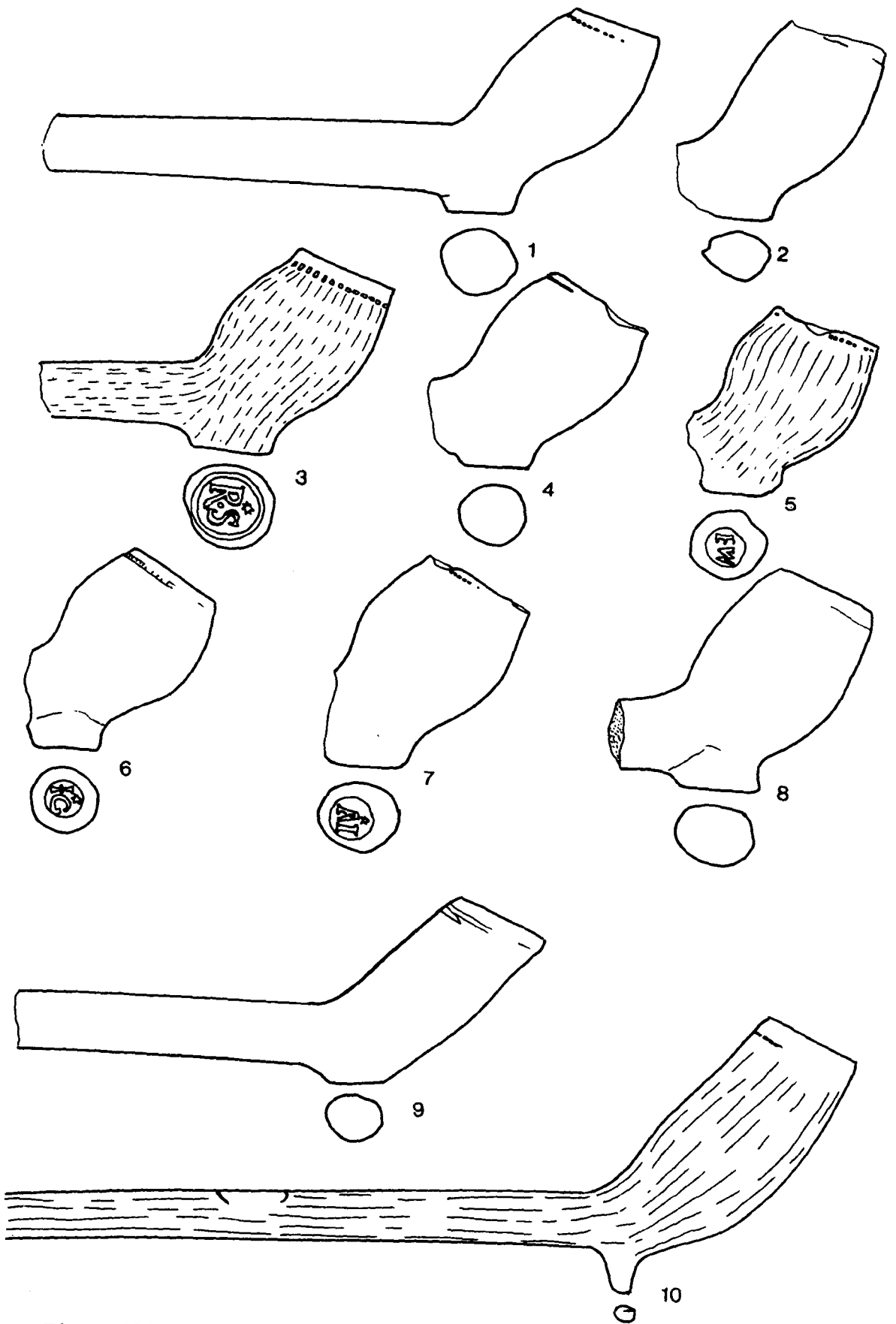
119.09 Heel type bowl dating from c1640-1660 unprovenanced but probably from Leeds (Acc No. 104/64/53); fully milled. Milled heel. (Pcode 03357). One of two pipes of this type.

- 119.10 Heel type bowl dating from c1660-1680 unprovenanced but probably from Leeds (Acc No. 104/64/53); fully milled. (Pcode 05902).
- 119.11 Heel type bowl dating from c1650-1670 unprovenanced but probably from Leeds; fully milled. (Pcode 05885).
- 119.12 Heel type bowl dating from c1660-1680 unprovenanced but probably from Leeds; rim wiped but not milled. (Pcode 05891). One of two pipes of this type, the second example is slightly taller.
- 119.13 Heel type bowl dating from c1660-1680 unprovenanced but probably from Leeds (Acc No. 104/64/53); fully milled. (Pcode 05903).
- 119.14 Heel type bowl dating from c1660-1680 unprovenanced but probably from Leeds; fully milled. (Pcode 05892).
- 119.15 Heel type bowl dating from c1660-1680 unprovenanced but probably from Leeds; rim bottered but not milled. (Pcode 05886).
- 119.16 Spur type bowl dating from c1660-1680 unprovenanced but probably from Leeds; rim three quarters milled. (Pcode 05887).
- 119.17 Spur type bowl dating from c1660-1680 unprovenanced but probably from Leeds (Acc No. 130-54); rim not milled. Pipe labelled 'found in an old mine at Castleton the Peak'. (Pcode 05908).
- 120.01 Heel type bowl dating from c1650-1680 unprovenanced but probably from Leeds; rim bottered and half milled. (Pcode 05888).
- 120.02 Heel type bowl dating from c1660-1680 unprovenanced but probably from Leeds (Acc No. 104/64/53); fully milled. (Pcode 05904).
- 120.03 Heel type bowl dating from c1660-1700 unprovenanced but probably from Leeds; average burnish; rim- and fully milled. Marked with the initials RS on the heel. (Pcode 03362).
- 120.04 Heel type bowl dating from c1660-1690 unprovenanced but probably from Leeds (Acc No. 104/64/53); rim not milled. (Pcode 05905).
- 120.05 Heel type bowl dating from c1670-1700 unprovenanced but probably from Leeds (Acc No. E/58/1967/16); rim bottered and half milled. Marked with the initials EW on the heel. (Pcode 03359).
- 120.06 Heel type bowl dating from c1670-1700 unprovenanced but probably from Leeds (Acc No. E/58/1967 16); rim bottered and half milled. Marked with the initials IG on the heel. (Pcode 03360).
- 120.07 Heel type bowl dating from c1670-1700 unprovenanced but probably from Leeds; rim half milled. Marked with the initials AI on the heel. (Pcode 03361).

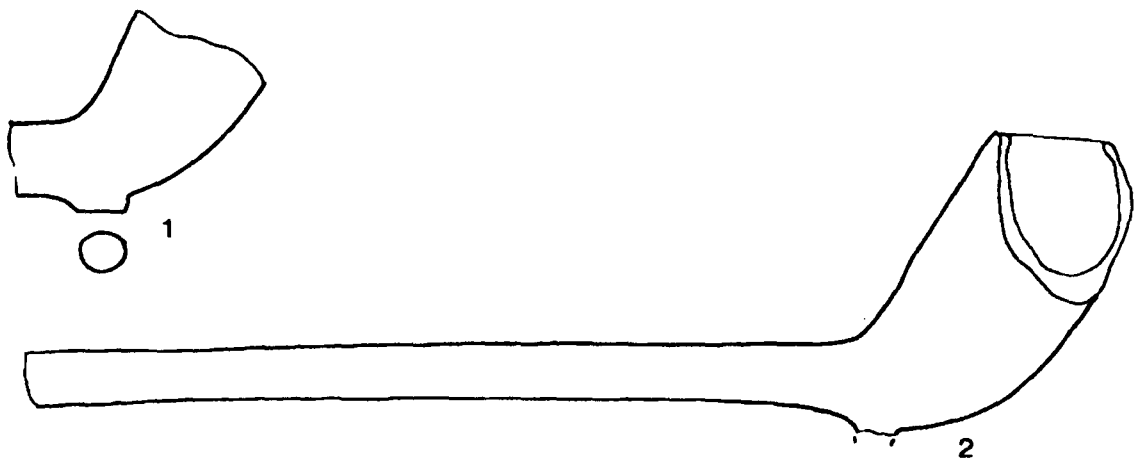
- 120.08 Heel type bowl dating from c1670-1700 unprovenanced but probably from Leeds (Acc No. 104/64/53); rim bottered but not milled. (Pcode 05895).
- 120.09 Heel type bowl dating from c1680-1710 unprovenanced but probably from Leeds; rim bottered but not milled. (Pcode 05889).
- 120.10 Spur type bowl dating from c1690-1710 unprovenanced but probably from Leeds (Acc No. E/58/1967 13); poorly burnished; rim bottered and one quarter milled. Marked with the lettering MICH PARK across the stem. Michael Parke of Gateshead. (Pcode 08261).
- 121.01 Heel type bowl dating from c1700-1750 unprovenanced but probably from Leeds (Acc No. 104/64/53). Badly burnt and discoloured. (Pcode 05898).
- 121.02 Bowl dating from c1780-1850 unprovenanced but probably from Leeds; rim cut. (Pcode 05890).



**Figure 119:** Pipes from the collections of the Abbey House Museum, Leeds. Scale 1:1.



**Figure 120:** Pipes from the collections of the Abbey House Museum, Leeds. Scale 1:1.



**Figure 121:** Pipes from the collections of the Abbey House Museum, Leeds. Scale 1:1.

**Collection Name:** Doncaster Museum & Art Gallery

**Collection Code:** 0140

**Contact Name:** Peter Robinson

**Address:** Doncaster, South Yorkshire

**Description:**

Material recorded over three visits, the first 3<sup>rd</sup> April 2000 then again on 23<sup>rd</sup> and 25<sup>th</sup> July 2001. Almost 400 pipe fragments of seventeenth- or eighteenth-century dated were recorded from this collection. The majority of these were from a kiln site in Church Street belonging to S Lumley and many of them were mould decorated bowls with roll stamped stems. In addition to the pipes themselves the museum has a number of boxes containing pipe production waste and kiln furniture associated with the eighteenth-century kiln site. Rough sketches were made of some of the kiln furniture and muffle fragments and a number of record photographs taken. Other notable nineteenth-century pipes include:

- DC/AAG – six examples of a Masonic bowl with the lettering W WATSON ROTHERHAM along the seam.
- 159.77 – bowl with George and the dragon on one side and Britannia on the other. Bears the lettering INGHAM/THORNE around the rim.
- DC/AAG – spur bowl with large moulded initials JW on the sides of the bowl

122.01 Heel type bowl dating from c1660-1680 from 25 The Grove; average burnish; rim bottered and three quarters milled; bore 7/64". Marked with the initials IH on the heel. (Pcode 06925).

122.02 Heel type bowl dating from c1680-1720 from 25 The Grove; bore 5/64". Marked with illegible initials on the bowl facing the smoker. Heel damaged; no rim surviving. (Pcode 06924).

122.03 Spur type bowl dating from c1690-1710 from Baxtergate, Site DA (Acc No. B/GATE 1966 U/S DA/GG); good burnish; rim internally trimmed and bottered; rim one quarter milled. Marked with the initials WR on the bowl facing the smoker. (Pcode 06928).

122.04 Heel type bowl dating from c1690-1710 from Baxtergate, Site DA (Acc No. B/GATE 1966 U/S DA/BC); average burnish; rim internally trimmed and bottered but not milled; bore 6/64". Marked with the initials IS on the heel. (Pcode 06927).

122.05 Heel type bowl dating from c1660-1680 from Church Street, Site DC, DY, DX and DCH (Acc No. DC/ACA); average burnish; rim bottered and fully milled; bore 6/64". Marked with the initials ?H on the heel. In a bag labelled "layer 11 under flagged floor 22.4.72". (Pcode 06986).

122.06 Heel type bowl dating from c1660-1680 from Church Street, Site DC, DY, DX and DCH (Acc No. DC/CI); average burnish; rim bottered and half milled; bore 7/64". Marked with the initials IH on the heel. (Pcode 06987).



- 122.07 Heel type bowl dating from c1660-1690 from Church Street, Site DC, DY, DX and DCH (Acc No. DX/CT (X)); good burnish; bore 6/64". Marked with the initials IB on the heel. No rim surviving. (Pcode 24717).
- 122.08 Heel type bowl dating from c1680-1700 from Church Street, Site DC, DY, DX and DCH (Acc No. DX/CT (X)); average burnish; rim bottered and three quarters milled; bore 7/64". Marked with the initials WL on the heel. (Pcode 24720).
- 122.09 Heel type bowl dating from c1720-1780 from Church Street, Site DC, DY, DX and DCH (Acc No. DCH/A); average burnish; + type bowl cross; rim wiped; rim not milled; bore 5/64". (Pcode 06988).
- 122.10 Spur type bowl dating from c1740-1800 from Church Street, Site DC, DY, DX and DCH (Acc No. DC/AAG); rim cut but not milled. Waster; Whole bowl has traces of clay on it and is most likely from the muffle. (Pcode 24807).
- 122.11 Bowl dating from c1740-1800 from Church Street, Site DC, DY, DX and DCH (Acc No. DC/AAG); rim cut but not milled. Waster, whole bowl has traces of clay on it and is most likely from the muffle. (Pcode 24810).
- 122.12 Spur type bowl dating from c1740-1780 from Church Street, Site DC, DY, DX and DCH (Acc No. DC/AAG); rim internally trimmed and cut; rim not milled; bore 4/64". Waster; encrusted spur but possibly has dot and circle motif moulded on side of the spur. Whole bowl has traces of clay on it and is most likely from the muffle. (Pcode 24809).
- 123.01 Spur type bowl dating from c1760-1800 from Church Street, Site DC, DY, DX and DCH (Acc No. DC/AAG); rim cut but not milled; bore 4/64". Waster associated with kiln waste from S Lumley kiln. (Pcode 24822).
- 123.02 Spur type bowl dating from c1760-1800 from Church Street, Site DC, DY, DX and DCH (Acc No. DC/AAG); rim internally trimmed and cut; bore 5/64". S Lumley stamped stems associated with this design. (Pcode 24814).
- 123.03 Spur type bowl dating from c1760-1800 from Church Street, Site DC, DY, DX and DCH (Acc No. DC/AGA); rim cut but not milled; bore 4/64". S Lumley stamped stems associated with bowls of this design. (Pcode 24824).
- 123.04 Spur type bowl dating from c1760-1800 from Church Street, Site DC, DY, DX and DCH (Acc No. DC/AAG); rim internally trimmed and cut; rim not milled. (Pcode 24878).
- 123.05 Heel type bowl dating from c1760-1800 from Church Street, Site DC, DY, DX and DCH (Acc No. DC/AAG); rim internally trimmed and cut; rim not milled; bore 5/64". (Pcode 24828).
- 123.06 Heel type bowl dating from c1760-1800 from Church Street, Site DC, DY, DX and DCH (Acc No. DC/AAG); rim cut but not milled; bore 4/64".

Waster, whole bowl has traces of clay on it and is most likely from the muffle. (Pcode 24811).

- 123.07 Heel type bowl dating from c1760-1800 from Church Street, Site DC, DY, DX and DCH (Acc No. DC/AAG); rim cut but not milled; bore 3/64". Marked with a dot and circle on the sides of the spur. Waster, whole bowl has traces of clay on it and is most likely from the muffle. Pedestal foot. (Pcode 24812).
- 123.08 Heel type bowl dating from c1680-1720 from East of Sepulchre Gate, Site DEH (Acc No. DEH/H); bore 7/64". Marked with the initials MP on the heel. Heel fragment only; burnt out void in heel. (Pcode 08376).
- 123.09 Heel type bowl dating from c1620-1640 from East side of St George's Gate, Site DR (Acc No. DR/AF); no internal bowl cross; rim bottered and fully milled; bore 9/64". Marked with a wheel on the heel. Cannot see individual burnishing lines but very shiny surface. (Pcode 24713).
- 123.10 Heel type bowl dating from c1650-1670 from East side of St George's Gate, Site DR (Acc No. DR/AF); rim internally trimmed and bottered; rim fully milled; bore 7/64". (Pcode 24722).
- 123.11 Heel type bowl dating from c1640-1660 from Fishergate (Acc No. F/GATE 1964 W/F1 DG/BG); rim internally trimmed and bottered; rim fully milled; bore 8/64". Not smoked. (Pcode 06942).
- 123.12 Heel type bowl dating from c1640-1660 from Fishergate (Acc No. F/GATE 1964 WF/1); rim internally trimmed and bottered; rim fully milled; bore 6/64". Not smoked. (Pcode 06966).
- 124.01 Heel type bowl dating from c1640-1660 from Fishergate (Acc No. F/GATE 1964 DG/BG); rim bottered and three quarters milled; bore 7/64". Not smoked. (Pcode 06929).
- 124.02 Heel type bowl dating from c1640-1660 from Fishergate (Acc No. F/GATE 1964 DG/BG); rim internally trimmed and bottered; rim three quarters milled; bore 6/64". Not smoked. (Pcode 06930).
- 124.03 Heel type bowl dating from c1650-1670 from Fishergate (Acc No. F/GATE 1964 W/F1 DG/BG); rim bottered and fully milled; bore 7/64". Very finely made; not smoked. (Pcode 06944).
- 124.04 Heel type bowl dating from c1640-1660 from Fishergate (Acc No. F/GATE 1964 W/F1 DG/BG); rim internally trimmed and bottered; rim fully milled; bore 6/64". Similar to 1725; not smoked. (Pcode 06943).
- 124.05 Spur type bowl dating from c1660-1680 from Fishergate (Acc No. F/GATE 1964 W/F1 DG/BG); rim internally trimmed and bottered; rim fully milled; bore 6/64". (Pcode 06945).

- 124.06 Heel type bowl dating from c1660-1680 from Hall Gate (Acc No. DHG 95 1000); average burnish; rim bottered and fully milled; bore 6/64". Heel mark badly damaged, possibly ?S. (Pcode 06967).
- 124.07 Heel type bowl dating from c1660-1680 from Hall Gate (Acc No. DHG 95 1000); rim internally trimmed and bottered; rim one quarter milled; bore 7/64". Milled heel. (Pcode 06968).
- 124.08 Possibly a spur type bowl dating from c1730-1760 from High Street, Site DJ (Acc No. DJ/EG); rim cut. Marked with the initials LUMLEY (DONR) on the bowl facing the smoker. (Pcode 06972).
- 124.09 Heel type bowl dating from c1660-1680 from Lord Street, Site DF (Acc No. DF/BG); rim bottered but not milled; bore 7/64". Milled heel (Pcode 24715).
- 124.10 Heel type bowl dating from c1680-1710 from Lord Street, Site DF (Acc No. DF/BG); rim bottered but not milled; bore 7/64". Milled heel (Pcode 24716).
- 124.11 Heel type bowl dating from c1660-1680 from Low Fishergate (Acc No. DNB 92 1023); rim bottered and three quarters milled; bore 6/64". (Pcode 06973).
- 124.12 Possibly a spur type bowl dating from c1660-1680 from Low Fishergate (Acc No. DNB 93 U/S); rim bottered and three quarters milled. (Pcode 06974).
- 124.13 Heel type bowl dating from c1660-1680 from Low Fishergate (Acc No. DNB 93 U/S); good burnish; rim bottered and half milled; bore 7/64". (Pcode 06975).
- 125.01 Heel type bowl dating from c1680-1720 from Market Place, Site DMP (Acc No. DMP/B 5); good burnish; rim bottered and three quarters milled; bore 7/64". Marked with the initials IH on the heel. (Pcode 06977).
- 125.02 Heel type bowl dating from c1660-1680 from Market Place, Site DMP (Acc No. DMP77 AREA 3); average burnish; rim bottered and half milled; bore 7/64". Marked with the initials ON flanking a castle on the heel. Very pink fabric. (Pcode 24719).
- 125.03 Heel type bowl dating from c1660-1690 from Market Place, Site DMP (Acc No. DMP77 AREA 3); good burnish; rim bottered but not milled; bore 7/64". Marked with the initials IB on the heel. Very distinct mould flaws round heel. (Pcode 24718).
- 125.04 Spur type bowl dating from c1660-1680 from New Museum Site (1961), Site DK (Acc No. DK/AM); rim bottered; milled around all of the surviving rim; bore 7/64". (Pcode 24655).

- 125.05 Heel type bowl dating from c1660-1680 from New Museum Site (1961), Site DK (Acc No. DK/AM); good burnish; rim bottered and half milled; bore 7/64". Marked with the initials IS on the heel. (Pcode 08377).
- 125.06 Heel type bowl dating from c1650-1670 from North side of Church Way (St. George's), Site DT (Acc No. DT/JA); poorly burnished; rim bottered and three quarters milled; bore 5/64". Marked with the crowned initials SH on the heel. (Pcode 06982).
- 125.07 Heel type bowl dating from c1640-1660 from North side of Church Way (St. George's), Site DT (Acc No. DT/LH); rim bottered and half milled. (Pcode 06984).
- 125.08 Heel type bowl dating from c1660-1680 from North side of Church Way (St. George's), Site DT (Acc No. DT/HN); average burnish; rim bottered but not milled; bore 7/64". Marked with the initials IH on the heel. (Pcode 06981).
- 125.09 Heel type bowl dating from c1660-1680 from North side of Church Way (St. George's), Site DT (Acc No. DT/BA); average burnish; rim bottered and half milled; bore 7/64". Milled heel (Pcode 06979).
- 125.10 Heel type bowl dating from c1680-1710 from North side of Church Way (St. George's), Site DT (Acc No. DT/KS); average burnish; rim bottered and half milled; bore 6/64". Milled heel (Pcode 06983).
- 125.11 Bowl dating from c1690-1720 from North side of Church Way, Site DV (Acc No. DV/AJ LAYER 1); average burnish; rim bottered; milled around all of the surviving rim. Marked with the initials IH on the bowl facing the smoker. (Pcode 24721).
- 125.12 Heel type bowl dating from c1660-1690 from Roman Camp; poorly burnished; rim bottered and fully milled; bore 6/64". Marked with the initials IW on the heel. (Pcode 06997).
- 126.01 Heel type bowl dating from c1660-1680 from Site DM (Acc No. DM/AN); rim bottered; milled around all of the surviving rim; bore 7/64". (Pcode 24661).
- 126.02 Heel type bowl dating from c1620-1670 from Site DM (Acc No. DM/BJ); good burnish; bore 6/64". Marked with the initials GW on the heel. (Pcode 08379).
- 126.03 Heel type bowl dating from c1680-1720 from Site DM (Acc No. DM/AP); bore 6/64". Marked with the initials MP on the heel. No rim surviving; burnt out void in heel. (Pcode 24659).
- 126.04 Spur type bowl dating from c1640-1660 from South side of Church Way, Site DQ (Acc No. DQ/AE); rim bottered and fully milled; bore 9/64". (Pcode 24657).

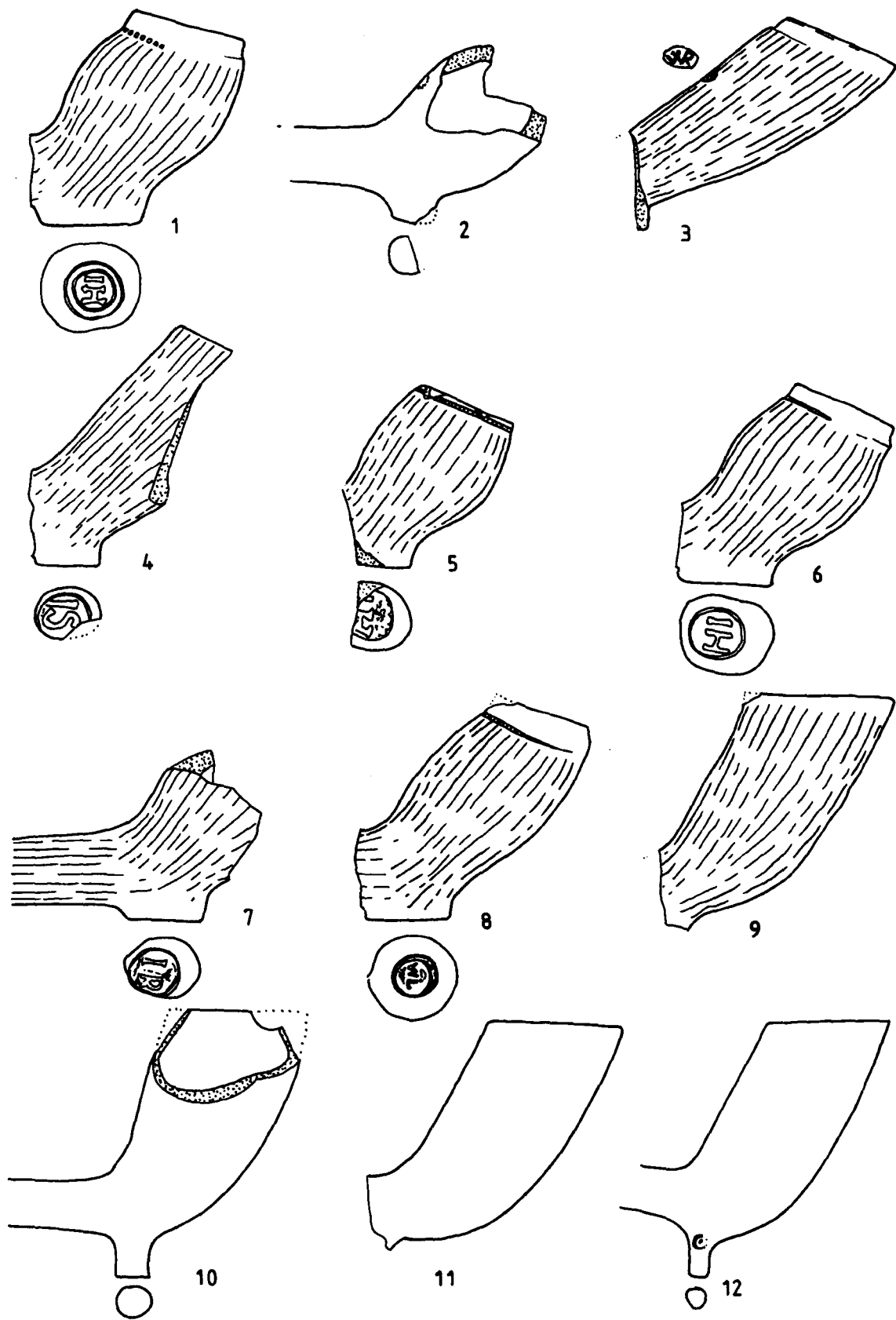
- 126.05 Heel type bowl dating from c1640-1660 from South side of Church Way, Site DQ (Acc No. DQ/EP \$); good burnish; rim bottered; milled around all of the surviving rim; bore 7/64". Marked with the initials BC on the heel. (Pcode 08378).
- 126.06 Heel type bowl dating from c1660-1680 from South side of Church Way, Site DQ (Acc No. DQ/GW); average burnish; rim bottered and three quarters milled; bore 7/64". Marked with the initials WL on the heel. (Pcode 06992).
- 126.07 Possibly a spur type bowl dating from c1700-1770 from South side of Church Way, Site DQ (Acc No. DQ/SI); rim wiped; rim not milled. (Pcode 24658).
- 126.08 Possibly a heel type bowl dating from c1620-1640 from South side of High Street, Site DSR (Acc No. DSR/BB (5)); rim bottered and fully milled. (Pcode 24641).
- 126.09 Heel type bowl dating from c1640-1660 from South side of High Street, Site DSR (Acc No. DSR/BC (5)); rim bottered and fully milled; bore 6/64". Burnt. (Pcode 24644).
- 126.10 Heel type bowl dating from c1640-1660 from South side of High Street, Site DSR (Acc No. DSR/CC (5)); rim bottered and fully milled; bore 8/64". Heel cut at an angle. (Pcode 24642).
- 126.11 Heel type bowl dating from c1650-1670 from South side of High Street, Site DSR (Acc No. DSR/BB (5)); rim bottered; milled around all of the surviving rim; bore 6/64". (Pcode 24645).
- 126.12 Spur type bowl dating from c1660-1680 from South side of High Street, Site DSR (Acc No. DSR/BP (5)); rim bottered and fully milled; bore 5/64". (Pcode 24648).
- 126.13 Heel type bowl dating from c1660-1680 from South side of High Street, Site DSR (Acc No. DSR/AL (X)); average burnish; rim bottered and three quarters milled; bore 6/64". Marked with the crowned initials SH on the heel. (Pcode 08374).
- 126.14 Heel type bowl dating from c1690-1710 from South side of High Street, Site DSR (Acc No. DSR/BA (+)); good burnish; rim bottered but not milled; bore 5/64". (Pcode 24653).
- 127.01 Heel type bowl dating from c1640-1660 from St George's Church Yard; good burnish; rim bottered and fully milled; bore 7/64". Marked with the initials IP on the heel. (Pcode 06922).
- 127.02 Heel type bowl dating from c1690-1710 from St George's Church Yard; average burnish; rim internally trimmed and bottered but not milled; bore 7/64". Marked with the initials MP on the heel. (Pcode 06923).

- 127.03 Heel type bowl dating from c1660-1680 from Thorne Peel Hill (Acc No. DTPH94 404); average burnish; rim bottered and half milled; bore 6/64". Milled heel (Pcode 24708).
- 127.04 Heel type bowl dating from c1660-1680 from Thorne Peel Hill (Acc No. DTPH94 404); average burnish; rim bottered and half milled; bore 7/64". Marked with the initials IH on the heel. (Pcode 24710).
- 127.05 Heel type bowl dating from c1660-1680 from Thorne Peel Hill (Acc No. DTPH94 404); average burnish; rim bottered but not milled. Marked with the initials IH on the heel. (Pcode 24711).
- 127.06 Heel type bowl dating from c1640-1660 unprovenanced but probably from Doncaster (Acc No. DG91 100); rim bottered and fully milled; bore 7/64". (Pcode 06912).
- 127.07 Heel type bowl dating from c1640-1660 unprovenanced but probably from Doncaster (Acc No. DG91 500); rim internally trimmed and bottered; rim fully milled; bore 7/64". (Pcode 06941).
- 127.08 Heel type bowl dating from c1640-1660 unprovenanced but probably from Doncaster (Acc No. DG91 502); milled around all of the surviving rim; bore 7/64". (Pcode 06910).
- 127.09 Heel type bowl dating from c1640-1660 unprovenanced but probably from Doncaster; rim internally trimmed and bottered; milled around all of the surviving rim; bore 8/64". (Pcode 06915).
- 127.10 Heel type bowl dating from c1660-1680 unprovenanced but probably from Doncaster (Acc No. DG91 125-1); poorly burnished; rim internally trimmed and bottered; rim three quarters milled; bore 7/64". Marked with the initials CF on the heel. Very crude mark. (Pcode 06909).
- 127.11 Heel type bowl dating from c1660-1680 unprovenanced but probably from Doncaster; no internal bowl cross; bore 6/64". (Pcode 06916).
- 127.12 Heel type bowl dating from c1660-1680 unprovenanced but probably from Doncaster (Acc No. DG91 208); poorly burnished; rim bottered but not milled; bore 7/64". Marked with the initials IH on the heel. (Pcode 06911).
- 127.13 Heel type bowl dating from c1660-1680 unprovenanced but probably from Doncaster; rim internally trimmed and bottered; rim half milled; bore 5/64". Marked with the initials IH (Fleur-de-lys) on the heel. (Pcode 06918).
- 128.01 Heel type bowl dating from c1660-1680 unprovenanced but probably from Doncaster (Acc No. DPS 92 U/S); rim internally trimmed and bottered; rim three quarters milled; bore 6/64". Milled heel (Pcode 06914).

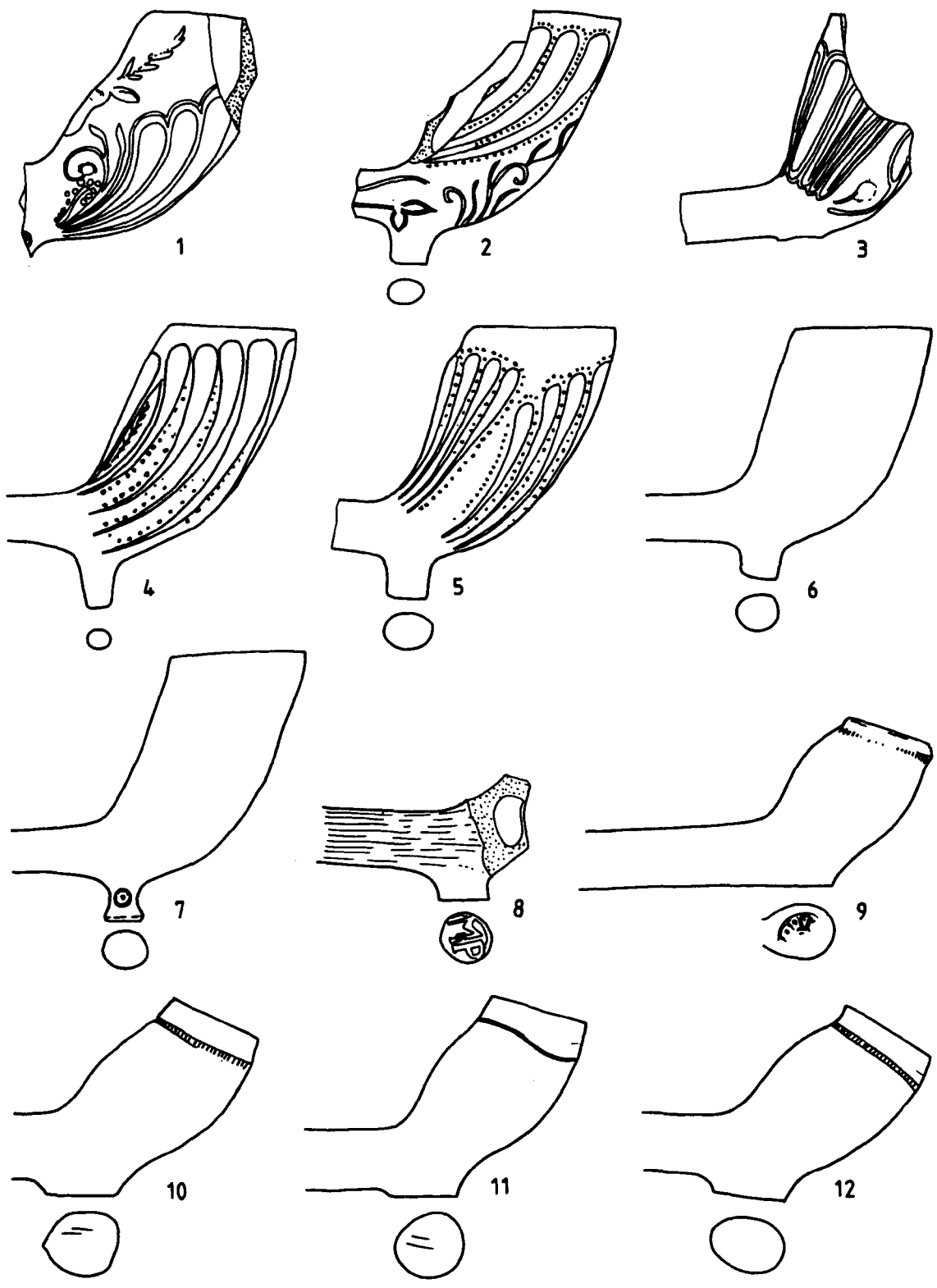
- 128.02 Heel type bowl dating from c1700-1770 unprovenanced but probably from Doncaster (Acc No. DG91 102); average burnish; bore 4/64". Marked with a dot and circle on the sides of the heel. (Pcode 06913).
- 128.03 Bowl dating from c1700-1770 unprovenanced but probably from Doncaster; average burnish; rim internally trimmed and bottered but not milled; bore 5/64". Marked with the initials IH on the bowl facing the smoker. (Pcode 06917).
- 128.04 Heel type bowl dating from c1640-1660 from West side of St George's Gate, Site DS (Acc No. DS/AS); good burnish; rim bottered and fully milled; bore 7/64". (Pcode 06994).
- 128.05 Heel type bowl dating from c1620-1640 from West side of St George's Gate, Site DS (Acc No. HK83 501); good burnish; rim bottered and fully milled; bore 7/64". Marked with a flower on the heel. (Pcode 24712).
- 128.06 Heel type bowl dating from c1640-1660 from West side of St George's Gate, Site DS (Acc No. DS/BA); poorly burnished; rim bottered and fully milled; bore 7/64". (Pcode 24626).
- 128.07 Heel type bowl dating from c1640-1660 from West side of St George's Gate, Site DS (Acc No. DS/AT); rim bottered and fully milled; bore 7/64". (Pcode 24623).
- 128.08 Heel type bowl dating from c1640-1660 from West side of St George's Gate, Site DS (Acc No. DS/AP); rim internally trimmed and bottered; rim fully milled; bore 7/64". (Pcode 24637).
- 128.09 Heel type bowl dating from c1660-1690 from West side of St George's Gate, Site DS (Acc No. DS/AS); no internal bowl cross; rim bottered and fully milled; bore 8/64". Marked with the initials GC on the heel. (Pcode 06995).
- 128.10 Heel type bowl dating from c1640-1660 from West side of St George's Gate, Site DS (Acc No. DS/AR); rim bottered and half milled; bore 6/64". Heart shaped heel. (Pcode 24638).
- 128.11 Heel type bowl dating from c1660-1680 from West side of St George's Gate, Site DS (Acc No. DS/AJ); rim bottered and three quarters milled; bore 7/64". Milled heel (Pcode 24625).
- 128.12 Heel type bowl dating from c1650-1670 from West side of St George's Gate, Site DS (Acc No. DS/AT); rim bottered and half milled; bore 7/64". (Pcode 24635).
- 128.13 Spur type bowl dating from c1650-1670 from West side of St George's Gate, Site DS (Acc No. DS/AT X\$S); rim bottered and half milled; bore 7/64". (Pcode 24621).

- 129.01 Spur type bowl dating from c1660-1680 from West side of St George's Gate, Site DS (Acc No. DS/AT); rim bottered but not milled; bore 5/64". (Pcode 24622).
- 129.02 Heel type bowl dating from c1640-1660 from West side of St George's Gate, Site DS (Acc No. DS/AO); good burnish; rim internally trimmed and bottered; rim fully milled; bore 7/64". Marked with the initials SV across the stem. (Pcode 06993).
- 129.03 Heel type bowl dating from c1660-1680 from West side of St George's Gate, Site DS (Acc No. DS/AT); rim bottered; milled around all of the surviving rim; bore 5/64". (Pcode 24633).
- 129.04 Heel type bowl dating from c1660-1680 from West side of St George's Gate, Site DS (Acc No. DS/AQ); rim bottered and three quarters milled; bore 7/64". (Pcode 24634).
- 129.05 Heel type bowl dating from c1660-1680 from West side of St George's Gate, Site DS (Acc No. DS/AR); average burnish; rim bottered and half milled; bore 7/64". (Pcode 24627).
- 129.06 Heel type bowl dating from c1690-1710 from West side of St George's Gate, Site DS (Acc No. DS/BA); poorly burnished; rim bottered and half milled; bore 6/64". Marked with the initials IG on the heel. (Pcode 06996).
- 129.07 Spur type bowl dating from c1760-1800 from Church Street, Site DC, DY, DX and DCH (Acc No. DC/ALF); rim cut but not milled; bore 5/64". Composite drawing of a fluted bowl with leaf and tendril decoration; similar moulded stem decoration associated with a diamond pattern mark as well as with the S Lumley stamps.
- 129.08 Stem fragment dating from c1760-1800 from Church Street, Site DC, DY, DX and DCH (Acc No. DY/DL); bore 5/64". Marked with the initials SLUMLEY across the stem. Stem with a similar leaf and tentril moulded design as drawing 129.07 but in association with an S Lumley stamped mark. (Pcode 08357).

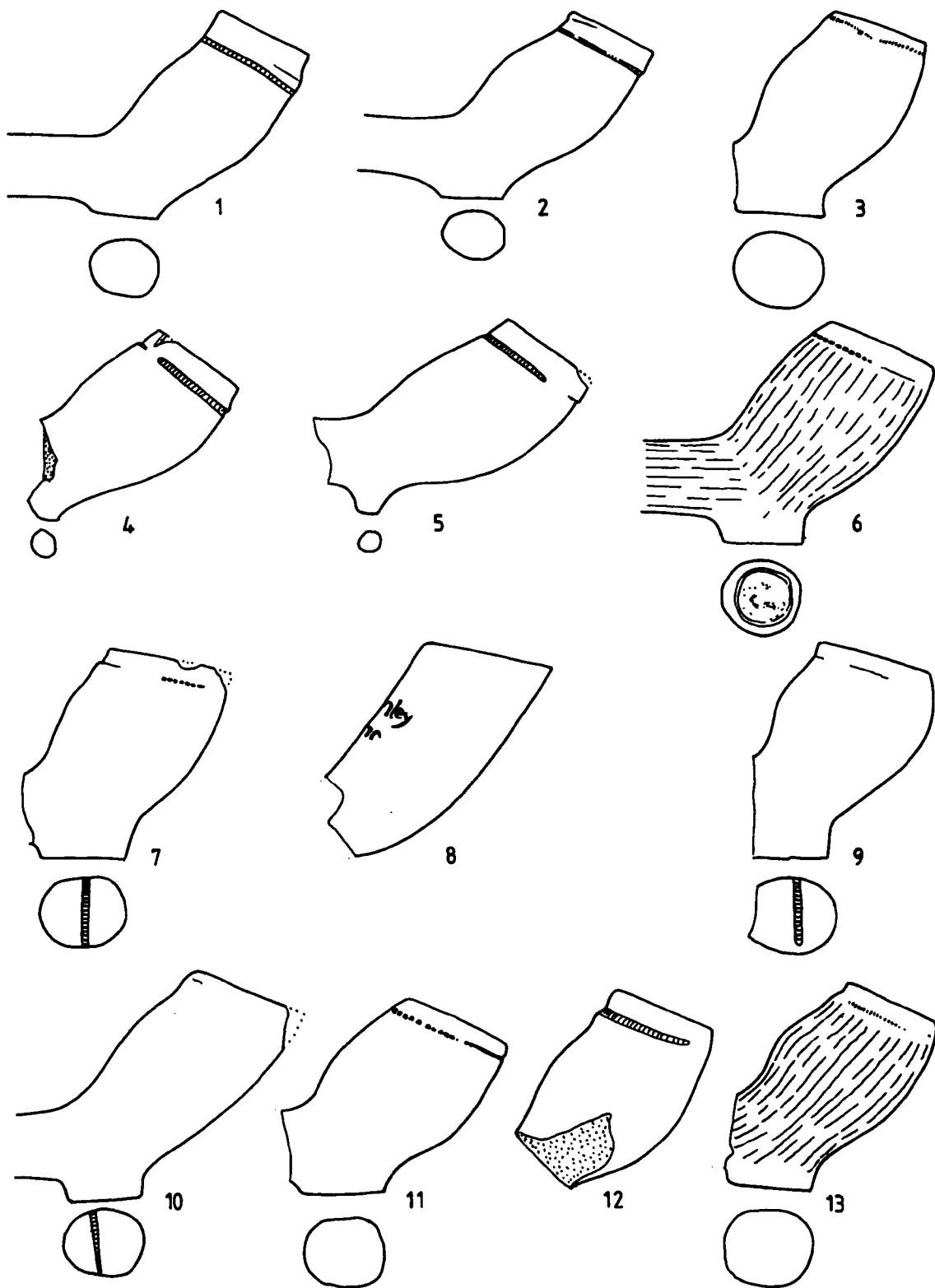




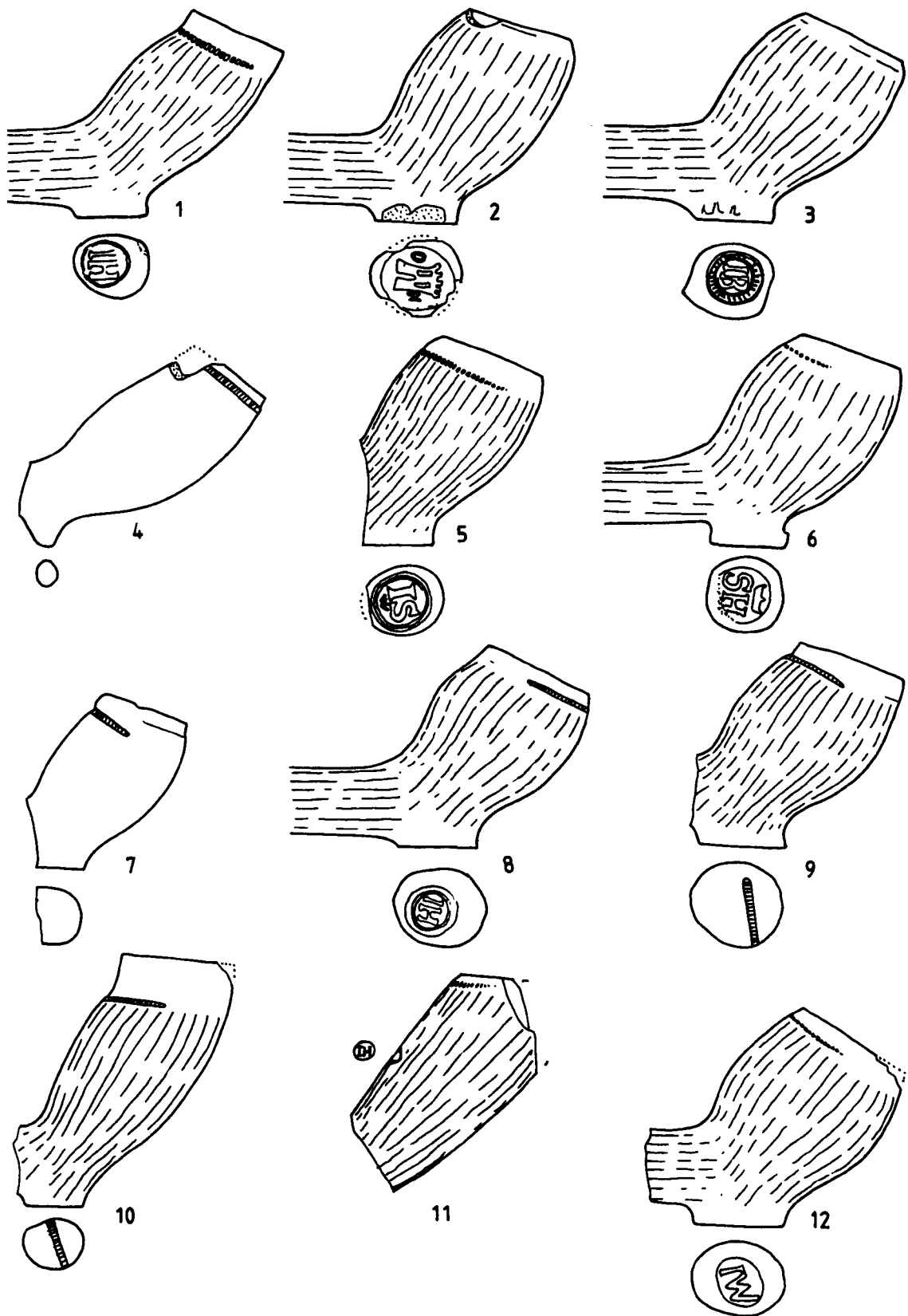
**Figure 122: Pipes from the collections of Doncaster Museum. Scale 1:1.**



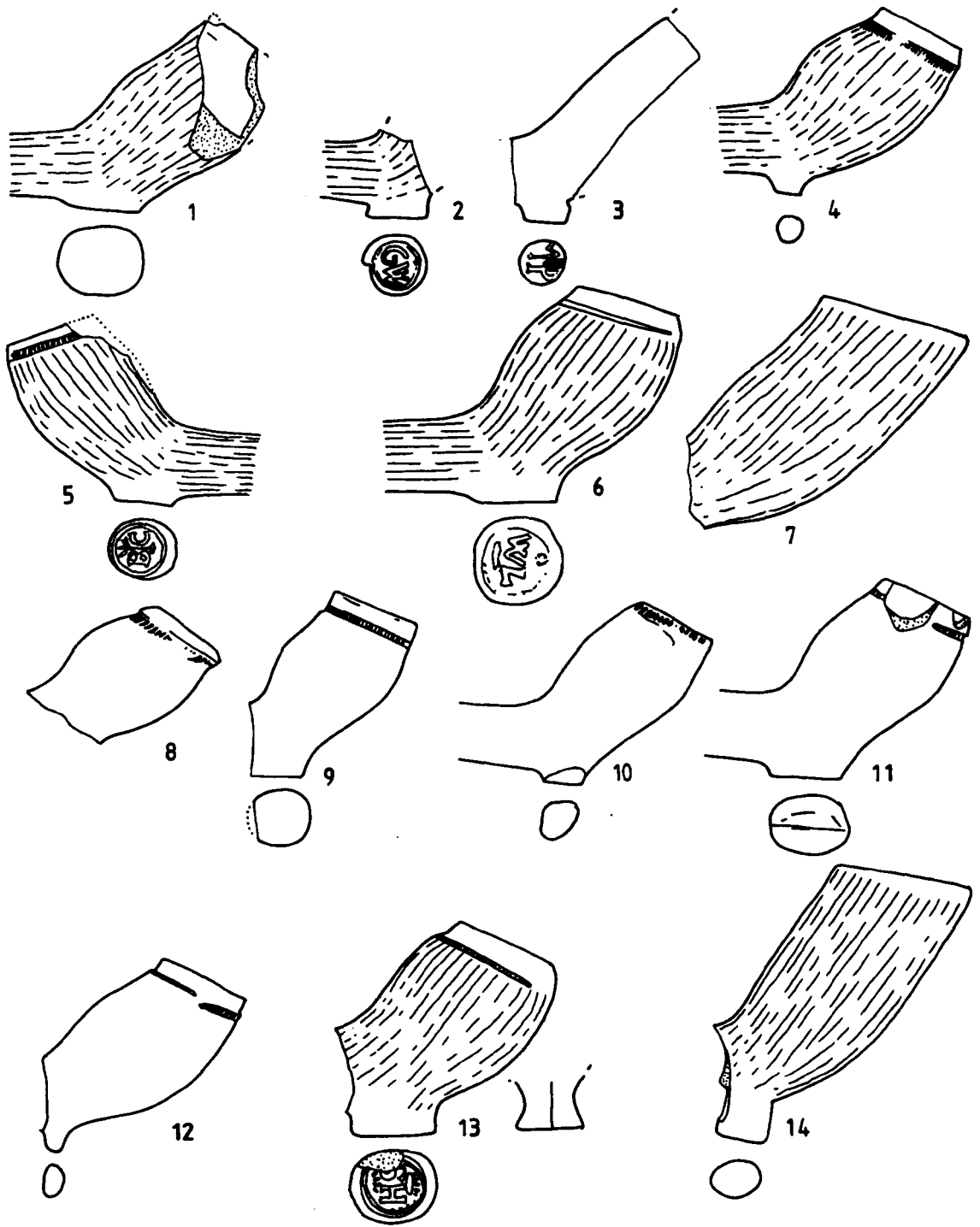
**Figure 123: Pipes from the collections of Doncaster Museum. Scale 1:1.**



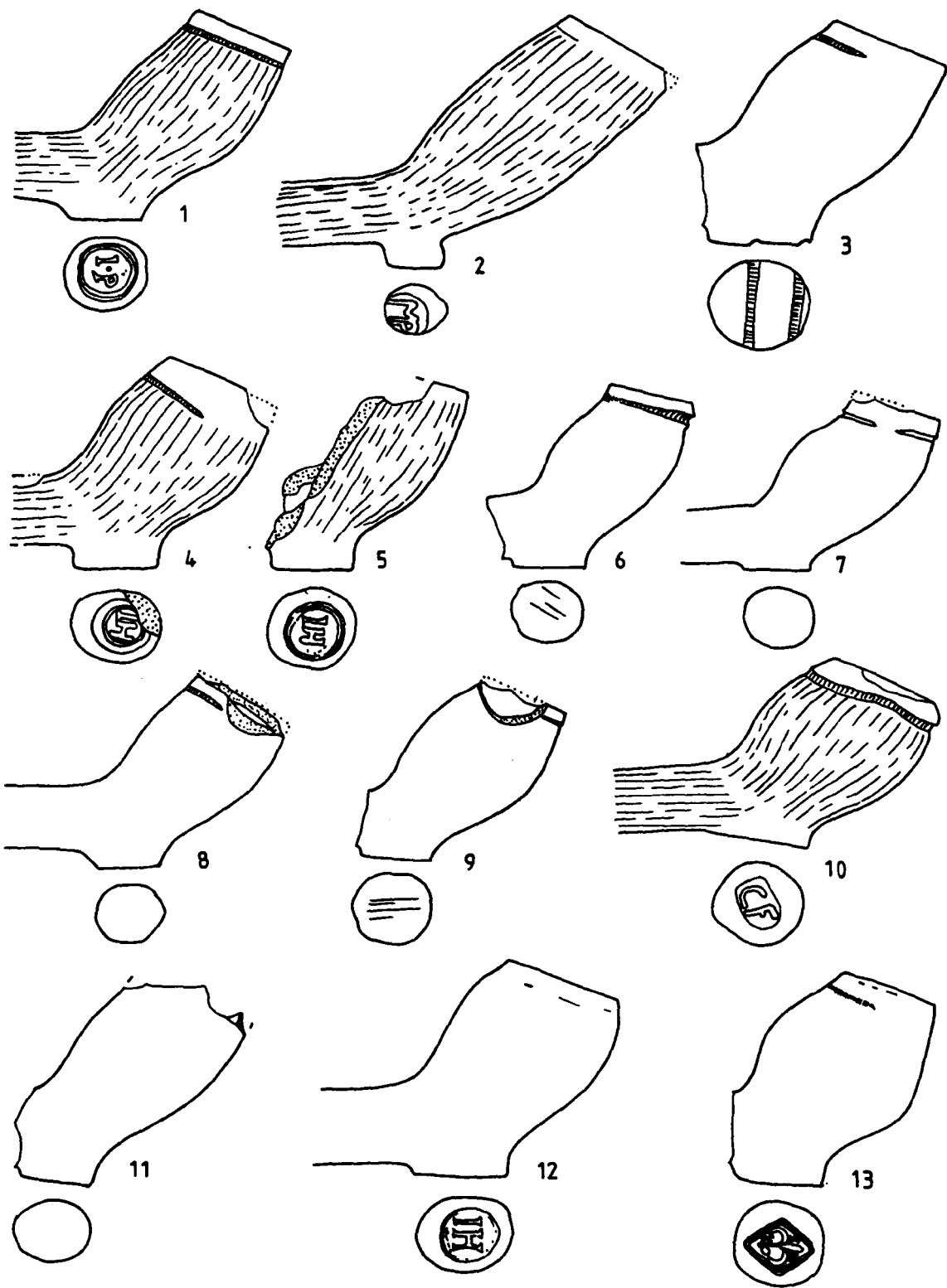
**Figure 124:** Pipes from the collections of Doncaster Museum. Scale 1:1.



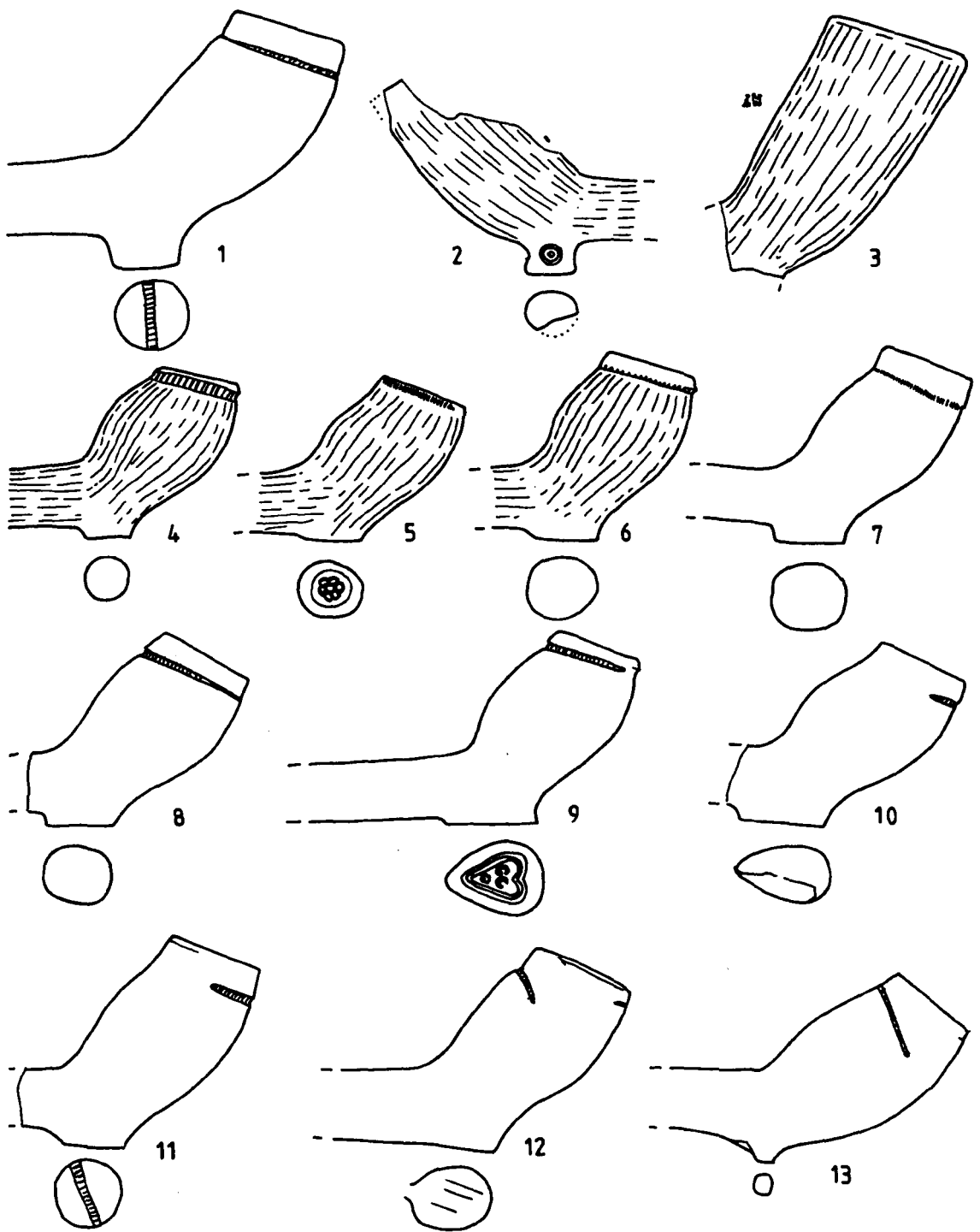
**Figure 125:** Pipes from the collections of Doncaster Museum. Scale 1:1.



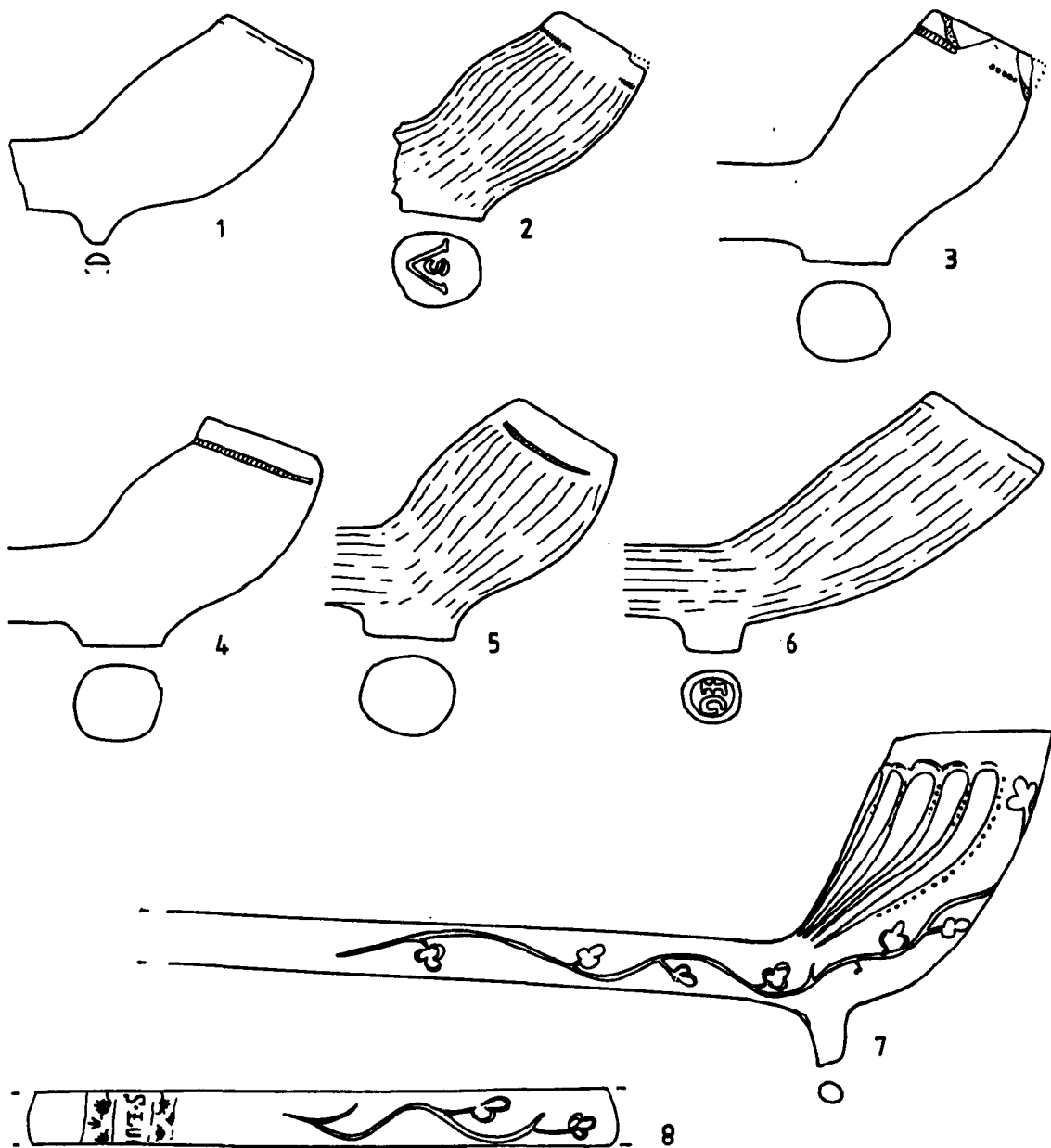
**Figure 126: Pipes from the collections of Doncaster Museum. Scale 1:1.**



**Figure 127: Pipes from the collections of Doncaster Museum. Scale 1:1.**



**Figure 128:** Pipes from the collections of Doncaster Museum. Scale 1:1.



**Figure 129:** Pipes from the collections of Doncaster Museum. Scale 1:1.



**Collection Name:** Rotherham Museum  
**Collection Code:** 0138  
**Contact Name:** Judy Ely  
**Address:** Rotherham, South Yorkshire

**Description:**

Collection recorded on 20<sup>th</sup> June 2000. The collection comprises a number of pipes ranging in date from the seventeenth century through to the early twentieth century. A catalogue exists of the pipe collection, including rough sketches of the pipes, compiled by students from Sheffield, although it is not clear when this cataloguing took place.

A total of 44 seventeenth- or eighteenth-century pipes were recorded in detail for the Yorkshire database. In addition to these 44 pipes and the material catalogued by the Sheffield students, other notable items in the collection include the following:

- SH/87/80 – Bowl with incuse sans serif moulded stem mark reading No. 49 C. WARD/DONCASTER. Typical Midlands type of lion and unicorn arms with DIEU ET MON DROIT beneath it.
- SH/67/80 – Very water-rolled London Type 25 bowl with thin walls and stem. The moulded initials ?T/F/P and H can be seen on the heel.
- SH/88-80 – Plain bowl with ink stamp mark reading JACK BANKS / TINSLEY HOTEL / TINSLEY.
- SH/148-80.9 – Bowl fragment with Prince of Wales' Feathers on the right-hand side with part of the word DONCASTER above.
- RAS/1995.75 – A pipe clay whistle in the form of a bird with very crisp detail; traces of dark brown paint survives overall; probably German.
- RAS/1995.91 – A pipe clay doll's body with relief moulded decoration and two holes pierced right through the body for the attachment of arms and legs.

130.01 Heel type bowl dating from c1630-1650 from Ickles Hall Farm (Acc No. SH/60/77); poorly burnished; rim bottered and fully milled; stem bore 8/64". Ground end. (Pcode 06539).

130.02 Heel type bowl dating from c1640-1660 from Alma Road (Acc No. RAS/1995.10); rim internally trimmed, bottered and half milled; stem bore 6/64". (Pcode 06555).

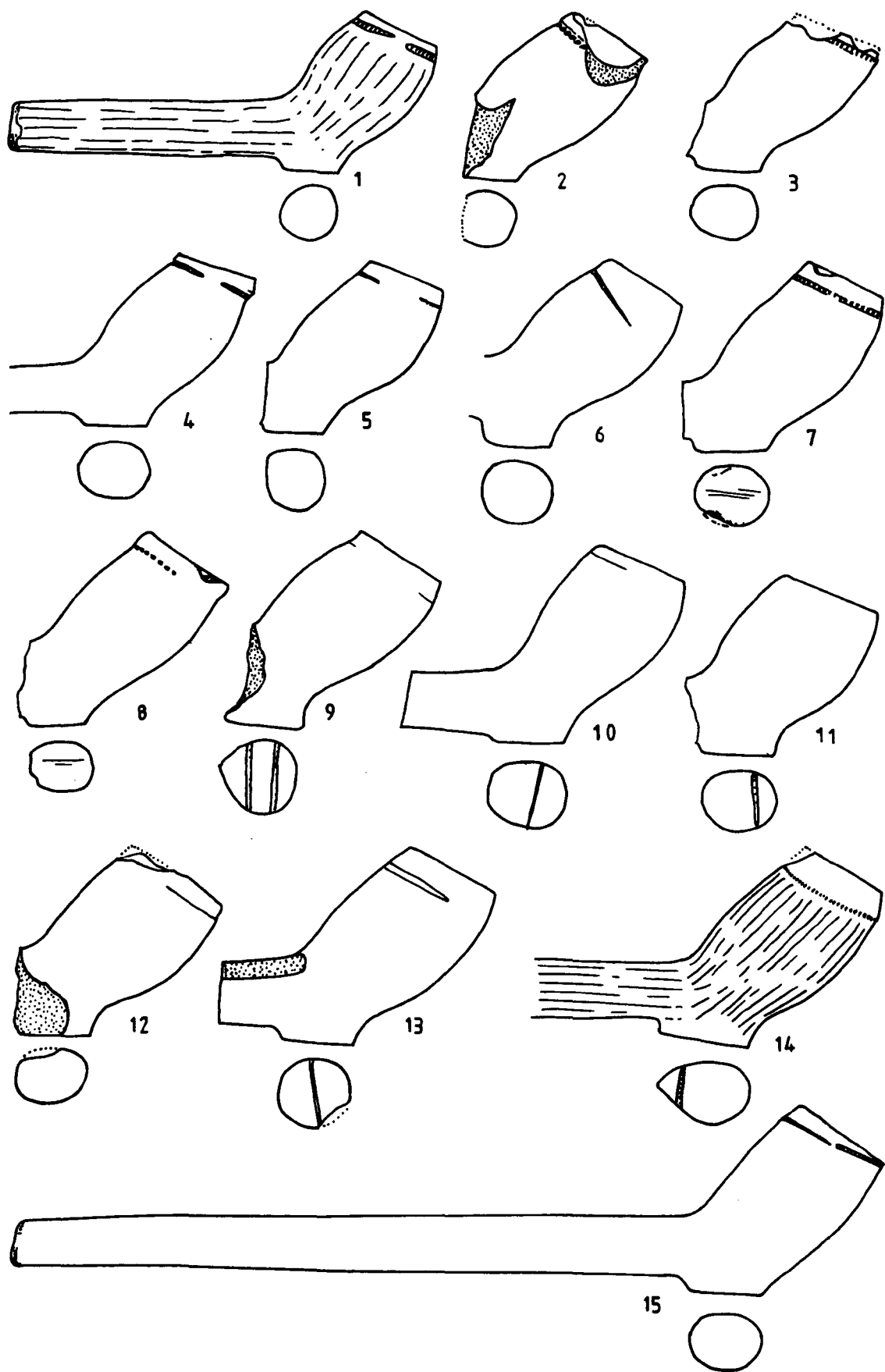
130.03 Heel type bowl dating from c1640-1660 from Alma Road (Acc No. RAS/1995.11); milled on all surviving rim; stem bore 6/64". (Pcode 06556).

130.04 Heel type bowl dating from c1640-1660, unprovenanced find from Rotherham (Acc No. SH/436/77); rim bottered and fully milled; stem bore 7/64". (Pcode 06532).

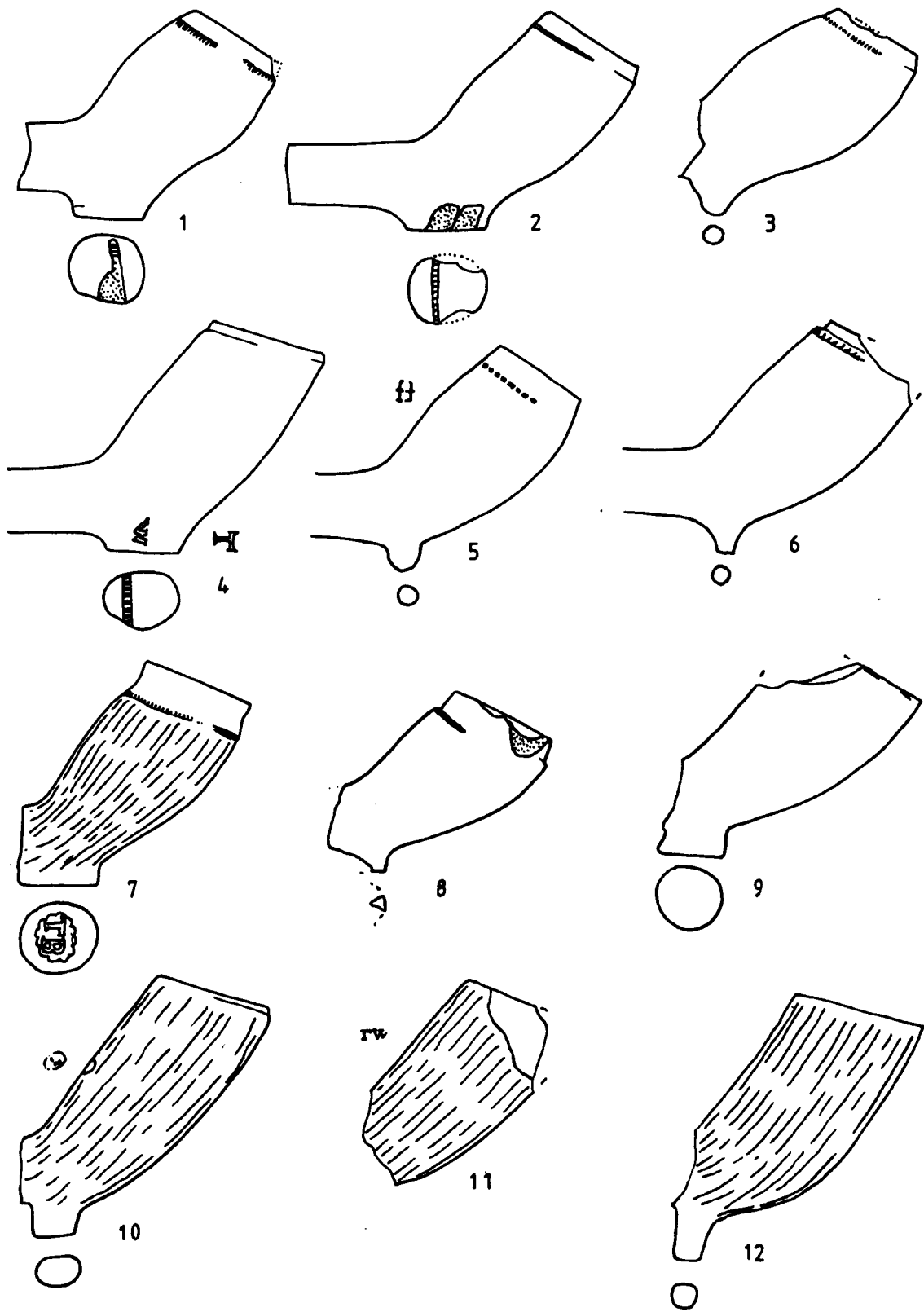
130.05 Heel type bowl dating from c1640-1660, unprovenanced find from Rotherham (Acc No. SH/147/80); rim bottered and fully milled; stem bore 6/64". Surface very rough and abraded. (Pcode 06529).

- 130.06 Heel type bowl dating from c1640-1660 from 15 Doncaster Place (Acc No. SH/113/80); rim bottered and half milled; stem bore 7/64". (Pcode 06553).
- 130.07 Heel type bowl dating from c1660-1680 from Canklow (Acc No. RAS/1995.8); rim bottered and fully milled; stem bore 5/64". (Pcode 06561).
- 130.08 Heel type bowl dating from c1660-1680 from Alma Road (Acc No. RAS/1995.9); rim internally trimmed, bottered and three quarters milled; stem bore 7/64". (Pcode 06559).
- 130.09 Heel type bowl dating from c1660-1680 from Alma Road (Acc No. RAS/1995.19); rim internally trimmed and bottered but not milled; stem bore 6/64". Double band of milling on the heel. (Pcode 06558).
- 130.10 Heel type bowl dating from c1660-1700 from Stone (Acc No. SH/372/93.2); rim internally trimmed and bottered but not milled; stem bore 6/64". Cut marked on the heel. (Pcode 06544).
- 130.11 Heel type bowl dating from c1660-1680, unprovenanced find from Rotherham (Acc No. RAS/1995.31); possible bowl cross present (X) but not milled; stem bore 6/64". Milled heel. Very worn. (Pcode 06525).
- 130.12 Heel type bowl dating from c1660-1680, unprovenanced find from Rotherham (Acc No. RAS/1995.28); rim bottered but not milled; stem bore 6/64". (Pcode 06523).
- 130.13 Heel type bowl dating from c1660-1680 from Treeton (Acc No. SH/153/74-10); rim bottered and half milled; stem bore 6/64". (Pcode 06551).
- 130.14 Heel type bowl dating from c1660-1680, unprovenanced find from Rotherham (Acc No. SH/73/80); good burnish; rim bottered and three quarters milled. Milled heel. (Pcode 06549).
- 130.15 Heel type bowl dating from c1660-1680, unprovenanced find from Rotherham (Acc No. SH/438/77); average burnish; fully milled; stem bore 7/64". Shiny surface. (Pcode 06533).
- 131.01 Heel type bowl dating from c1660-1680 from Fenton Lane, Kimberworth Park (Acc No. SH/70/75); rim bottered and fully milled; stem bore 7/64". Milled heel. Shiny surface. (Pcode 06564).
- 131.02 Heel type bowl dating from c1660-1680, unprovenanced find from Rotherham (Acc No. RAS/1995.18); rim internally trimmed, bottered and half milled; stem bore 5/64". Milled heel. (Pcode 06521).
- 131.03 Spur type bowl dating from c1660-1680 from Stone (Acc No. SH/372/93.5); rim internally trimmed, bottered and three quarters milled; stem bore 6/64". (Pcode 06547).

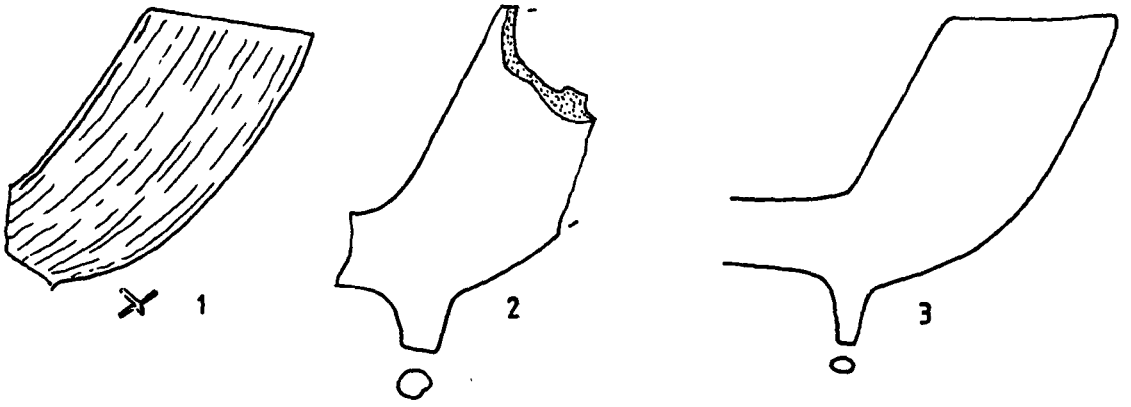
- 131.04 Heel type bowl dating from c1660-1680, unprovenanced find from Rotherham (Acc No. SH/85/80); rim internally trimmed and bottered but not milled; stem bore 6/64". Marked with the initials TW on the sides of the heel. Milled heel. (Pcode 06537).
- 131.05 Spur type bowl dating from c1660-1680, unprovenanced find from Rotherham (Acc No. SH/105/80); rim bottered and half milled. Marked with the initials II on the bowl facing the smoker. (Pcode 06542).
- 131.06 Spur type bowl dating from c1660-1680, unprovenanced find from Rotherham (Acc No. SH/434/77); rim bottered; milled on all surviving rim; stem bore 6/64". (Pcode 06530).
- 131.07 Heel type bowl dating from c1680-1710 from Stone (Acc No. SH/372/93.4); good burnish; rim internally trimmed, bottered and fully milled; stem bore 5/64". Marked with the initials TB on the heel. (Pcode 06546).
- 131.08 Heel type bowl dating from c1660-1680 from Canklow (Acc No. RAS/1995.30); rim bottered and one quarter milled; stem bore 6/64". (Pcode 06560).
- 131.09 Heel type bowl dating from c1690-1710 from Stone (Acc No. SH/372/93.1); rim internally trimmed and bottered but not milled; stem bore 5/64". (Pcode 06543).
- 131.10 Heel type bowl dating from c1690-1720, unprovenanced find from Rotherham (Acc No. SH/66/80); average burnish; rim internally trimmed and bottered but not milled. Marked on the bowl facing the smoker; mark illegible. (Pcode 06550).
- 131.11 Bowl dating from c1690-1720, unprovenanced find from Rotherham (Acc No. RAS/1995.70); good burnish; rim bottered but not milled; Marked with the initials TW on the bowl facing the smoker. (Pcode 06528).
- 131.12 Heel type bowl dating from c1690-1710 from Stone (Acc No. SH/372/93.6); good burnish; rim cut but not milled; stem bore 5/64". Milled heel. (Pcode 06548).
- 132.01 Bowl dating from c1700-1770 from Riley's Garage, Westgate Green (Acc No. RAS/1995.14); good burnish; bowl cross present (X); rim internally trimmed and bottered but not milled; stem bore 5/64". (Pcode 06540).
- 132.02 Spur type bowl dating from c1740-1800 from Riley's Garage, Westgate Green (Acc No. RAS/1995.33); rim internally trimmed and cut but not milled; stem bore 5/64". (Pcode 06541).
- 132.03 Spur type bowl dating from c1690-1720 from Catcliffe (Acc No. SH/253/74.8); rim bottered but not milled; stem bore 5/64". Similar to tall London Type 18; similar examples from Kelham Museum, Sheffield. (Pcode 06563).



**Figure 130: Pipes from the collections of Rotherham Museum, Scale 1:1.**



**Figure 131:** Pipes from the collections of Rotherham Museum, Scale 1:1.



**Figure 132:** Pipes from the collections of Rotherham Museum, Scale 1:1.

**Collection Name:** ARCUS  
**Collection Code:** 0167  
**Contact Name:** Andy Lines  
**Address:** Sheffield, South Yorkshire

**Description:**

Collection of clay tobacco pipes from excavations a Riverside Exchange in Sheffield. S D White has prepared a full report on the clay tobacco pipes from the site. The site yielded a total of 1067 pipe fragments mainly late eighteenth and nineteenth century, however 19 fragments were recorded in detail for inclusion in the Yorkshire database. The excavations produced a rather large number of roll stamp marks, 14 in all, from the eighteenth century.

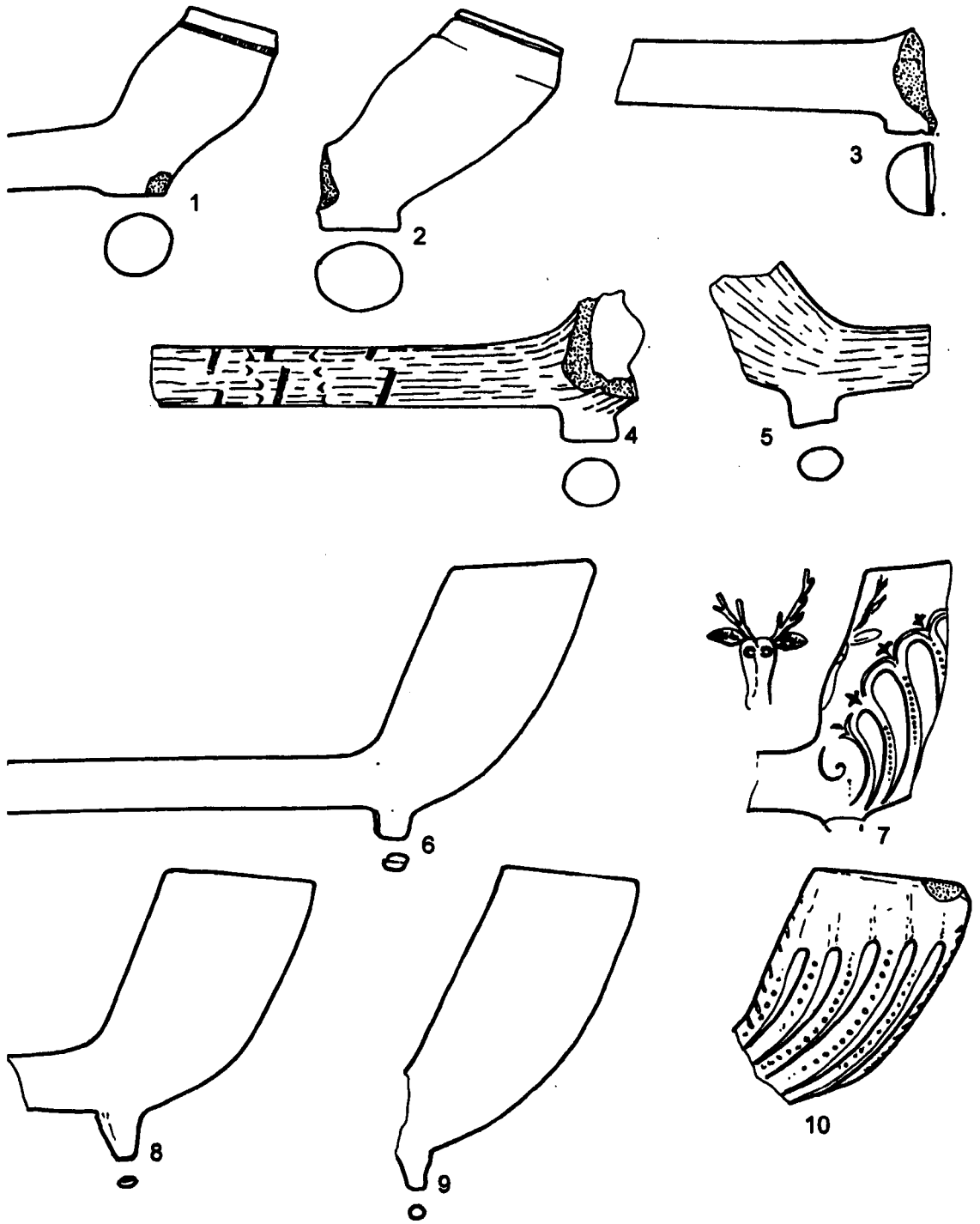
- 133.01 Heel type bowl dating from c1640-1660 (Acc No. 240H [14] (14125); rim bottered and fully milled; stem bore 6/64".
- 133.02 Heel type bowl dating from c1660-1680 (Acc No. 240F [11] (11512): SF No. 0397); rim bottered but not milled; stem bore 6/64". Grove round rim rather than milling. (Pcode 08384).
- 133.03 Heel type bowl dating from c1660-1690 (Acc No. 240D [5] (5003): SF No. 0013); stem bore 6/64". Heel fragment; cut mark across the heel. (Pcode 08385).
- 133.04 Heel type bowl dating from c1690-1740 (Acc No. 240F [11] (11179): SF No. 0307); good burnish; stem bore 5/64". Heel only; poorly preserved moulded mark either B or P, no surname initial; stem decorated with milled bands. (Pcode 08386).
- 133.05 Heel type bowl dating from c1690-1740 (Acc No. 240H [14] (14005); good burnish; stem bore 5/64".
- 133.06 Heel type bowl dating from c1750-1800 (Acc No. 240F [11] (11467): SF No. 0495); rim cut but not milled; stem bore 5/64".
- 133.07 Spur type bowl dating from c1770-1800 (Acc No. 240F [11] (11451): SF No. 0477); rim cut but not milled; stem bore 4/64".
- 133.08 Spur type bowl dating from c1820-1860 (Acc No. 240F [11] (11346): SF No. 0622); rim cut but not milled; stem bore 4/64".
- 133.09 Spur type bowl dating from c1840-1880 (Acc No. 240F [11] (11348): SF No. 0625); rim cut but not milled; stem bore 5/64". Possibly a Broseley product.
- 133.10 Bowl dating from c1800-1840 (Acc No. 240F [11] (U/S); rim wiped but not milled.
- 134.01 Spur type bowl dating from c1810-1840 (Acc No. 240F [11] (11467): SF No. 0495); rim cut but not milled; stem bore 5/64". Marked with the

lettering T PINDER (SHEFFIELD) along the stem. Thomas Pinder is known to have been working in Sheffield c1825-1829.

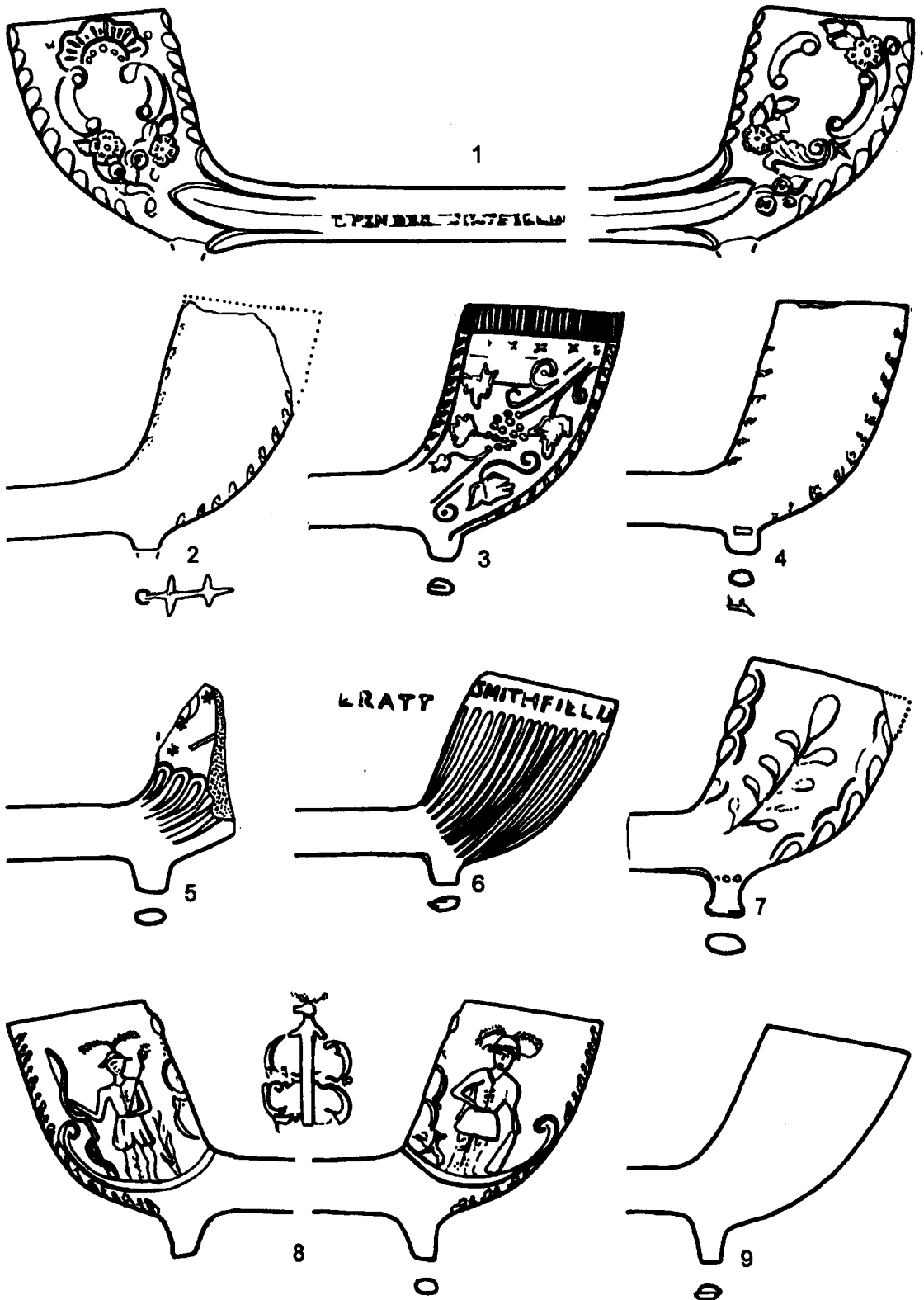
- 134.02 Spur type bowl dating from c1810-1850 (Acc No. 240H [14] (14029); stem bore 4/64". Very distinctive internal bowl cross similar to other examples from the Riverside Exchange site.
- 134.03 Spur type bowl dating from c1830-1850 (Acc No. 240F [11] (11064): SF No. 0073); rim cut with moulded milling; stem bore 5/64". Similar examples of this design recorded in the collections of Sheffield Museum with letter J DEE SHEFFIELD around the rim. Dee known to have been working c1833-1841.
- 134.04 Spur type bowl dating from c1810-1850 (Acc No. 240F [11] (11330): SF No. 0619); rim cut but not milled; stem bore 4/64". Poorly moulded lettering on the sides of the spur which appear to read FI.
- 134.05 Spur type bowl dating from c1840-1870 (Acc No. 240F [11] (11066): SF No. 0081); stem bore 4/64".
- 134.06 Spur type bowl dating from c1840-1880 (Acc No. 240F [11] (11291): SF No. 0569); rim cut but not milled; stem bore 4/64". Marked with the lettering ERRATT SMITHFIELD moulded around the rim. Although documentary evidence shows that the Erratt family were working in Sheffield during the 1850s and 1860s, the bowl form would suggest that they may have been working as early as the 1840s.
- 134.07 Bowl dating from c1810-1850 (Acc No. 240F [11] (11047): SF No. 0043); rim cut but not milled; stem bore 5/64". Unusual combination of bowl form and pedestal base.
- 134.08 Spur type bowl dating from c1840-1880 (Acc No. 240D [5] (5003): SF No. 0106); rim cut but not milled; stem bore 4/64".
- 134.09 Spur type bowl dating from c1840-1880 (Acc No. 240F [11] (11348): SF No. 0625); rim cut but not milled; stem bore 4/64".
- 135.01 Spur type bowl dating from c1840-1880 (Acc No. 240F [11] (11179): SF No. 0307); rim cut but not milled; stem bore 5/64".
- 135.02 Spur type bowl dating from c1860-1900 (Acc No. 240F [11] (11348): SF No. 0625); rim cut but not milled; stem bore 5/64".
- 135.03 Spur type bowl dating from c1860-1900; rim cut but not milled; stem bore 4/64". Found in the goit and donated by Mr Crowther, ex site electrician.
- 135.04 Bowl dating from c1840-1910 (Acc No. 240F [11] (11247): SF No. 0361); rim cut with moulded milling; stem bore 4/64". Marked with the lettering DUBLIN on the bowl facing the smoker. Irish style bowl.



- 135.05 Bowl dating from c1850-1910 (Acc No. 240F [11] (11218); SF No. 0342); rim cut but not milled; stem bore 4/64". Acorn on either side of the bowl with a large oak leaf along the front seam.
- 135.06 Bowl dating from post 1879 (Acc No. 240F [4] (4037); SF No. 0145); rim cut but not milled; stem bore 4/64". Decorated spur pipe with the pattern number 102 moulded into the side of the stem. This particular pattern was produced by John Pollock and Son of Manchester; a company found in 1879.
- 135.07 Stem fragment dating from c1830-1860 (Acc No. 240F [11] (11057); bore 4/64". Marked with the initials TUNSTALL (LEEDS) along the stem. Either George Tunstall (1840-1847) or Henry Tunstall (1836-1861), both working in Leeds.
- 135.08 Bowl dating from c1830-1880 (Acc No. 240F [11] (11290); SF No. 0565); stem bore 4/64". Part of a head bowl, the ear is clearly visible.
- 135.09 Spur type bowl dating from the mid 19<sup>th</sup> century (Acc No. 240F [11] (11085); SF No. 0173); stem bore 5/64". Dot and circle mark can be seen on the sides of the spur together with traces of a moulded design, which appears to be the bottom of the Prince of Wales feathers and may be part of the arms of Wakefield.
- 135.10 Stem fragment dating from c1820-1860 (Acc No. 240F [11] (11555); SF No. 0641); bore 5/64". Decorated with a moulded tendril design running along the sides of the stem.
- 135.11 Spur type bowl fragment dating from c1840-1860 (Acc No. 240F [11] (11179); SF No. 0307); stem bore 3/64". Marked with the initials FC on the sides of the spur. Possibly Frederick Cartwright of Sheffield, recorded working from at least 1854-1860.
- 135.12 Spur type bowl fragment dating from c1840-1910 (Acc No. 240F [11] (11555); SF No. 0641); stem bore 4/64". Marked with a shield on the sides of the spur.
- 135.13 Spur type bowl fragment dating from c1840-1910 (Acc No. 240F [4] (4035); SF No. 0065); stem bore 5/64". Marked with Shamrocks on the sides of the spur.



**Figure 133:** Pipes from the sites excavated by ARCUS, Sheffield. Scale 1:1. NB. All illustrations by the author but reproduced with the kind permission of ARCUS.



**Figure 134: Pipes from the sites excavated by ARCUS, Sheffield. Scale 1:1. NB. All illustrations by the author but reproduced with the kind permission of ARCUS.**

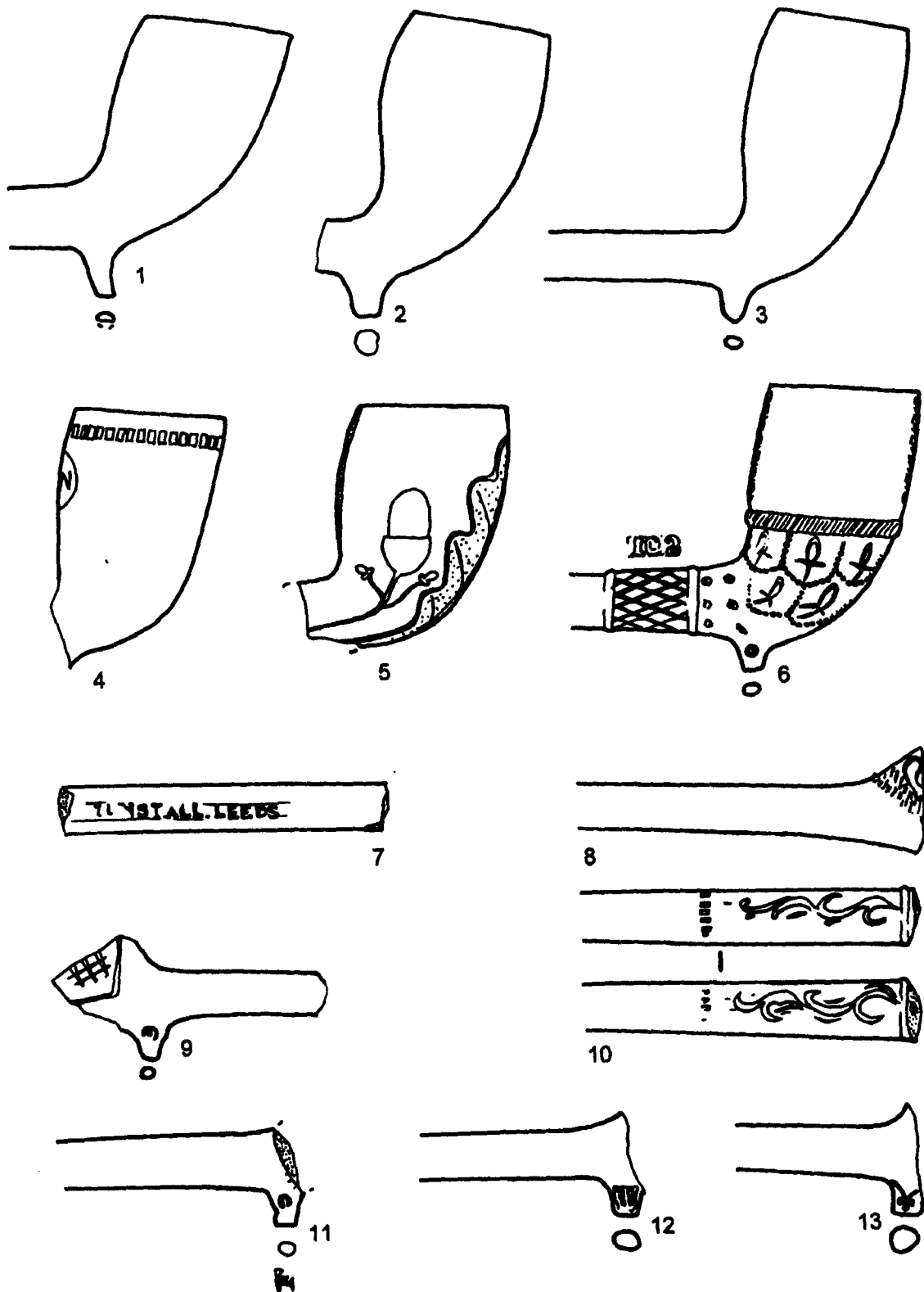


Figure 135: Pipes from the sites excavated by ARCUS, Sheffield. Scale 1:1. NB. All illustrations by the author but reproduced with the kind permission of ARCUS.

**Collection Name:** Kelham Island Industrial Museum

**Collection Code:** 0145

**Contact Name:** Kim Streets

**Address:** Sheffield, South Yorkshire

**Description:**

Collection recorded 19<sup>th</sup> June 2000. This is where Sheffield Museum's Social History Collection is housed. The collection consists of a large number of clay tobacco pipes ranging in date from the seventeenth through to the nineteenth and early twentieth century. A total of 50 pipes dating to the seventeenth and eighteenth century were recorded in detail for the Yorkshire Database. The most note worthy of the rest of the collection include the following:

- T1954.41 – an iron pipe with a 46cm stem
- An iron pipe with a curved stem approximately 14cm in length
- 1961.124 – group of bowls include 2-RAOB; 1 with a crown on one side and a head on the other; 1 armorial bearing the lettering DIEU ET MON DROIT; 1 with a skull and crossbones with the lettering DEATH OR GLORY; 1 with a grape design; and 1 plain
- X1975.443 – Bowl in the form of a cavalier's head; marked C CROP LONDON
- a box of Broseley churchwardens complete with original box and packing material.

136.01 Heel type bowl dating from c1630-1650 unprovenanced but probably from Sheffield (Acc No. J1911.3); rim bottered and fully milled; stem bore 7/64". (Pcode 07386).

136.02 Heel type bowl dating from c1660-1680 unprovenanced but probably from Sheffield (Acc No. 1960.45.B); rim bottered but not milled; stem bore 7/64". Heavily smoked. (Pcode 07376).

136.03 Heel type bowl dating from c1660-1680 unprovenanced but probably from Sheffield (Acc No. J1911.4); rim fully milled; stem bore 7/64". Marked with the initials MD on the heel. Broseley Type II. (Pcode 07387).

136.04 Heel type bowl dating from c1620-1640 unprovenanced material in Kelham Island Museum, Sheffield (Acc No. SC1952 G3 2'-6'); rim bottered; milled around all of the surviving rim. (Pcode 07390).

136.05 Heel type bowl dating from c1640-1660 unprovenanced material in Kelham Island Museum, Sheffield; rim bottered and fully milled; stem bore 7/64". (Pcode 07366).

136.06 Heel type bowl dating from c1640-1660 unprovenanced material in Kelham Island Museum, Sheffield (Acc No. 9.6.82/106); rim bottered and fully milled; stem bore 7/64". (Pcode 07380).

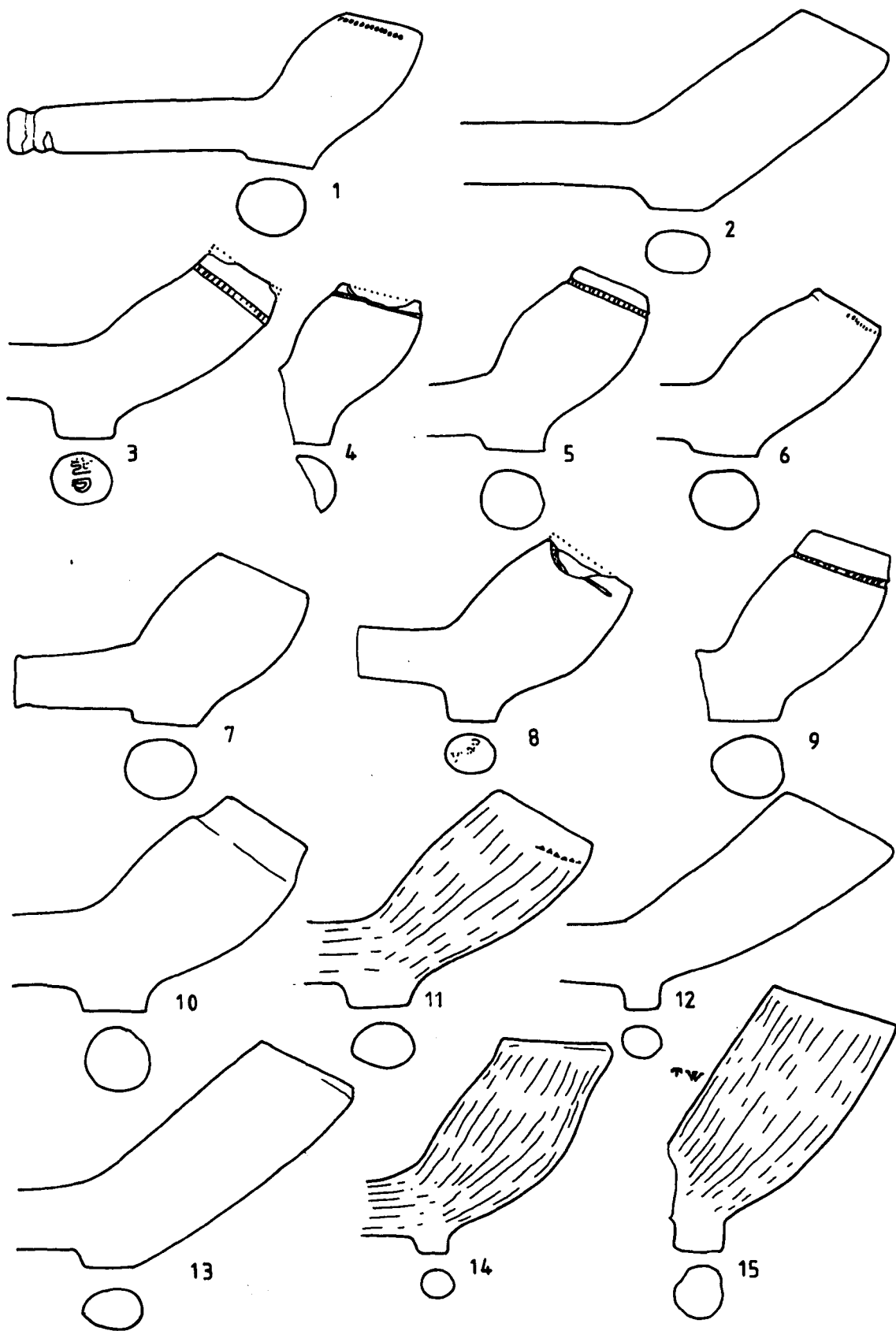
136.07 Heel type bowl dating from c1640-1660 unprovenanced material in Kelham Island Museum, Sheffield (Acc No. 9.5.82/105); rim bottered but not milled; stem bore 7/64". Label reads "AD 1830, fairy pipe". (Pcode 07379).

- 136.08 Heel type bowl dating from c1640-1660 unprovenanced material in Kelham Island Museum, Sheffield; rim bottered; milled around all of the surviving rim; stem bore 5/64". Illegible heel mark. (Pcode 07373).
- 136.09 Heel type bowl dating from c1660-1680 unprovenanced material in Kelham Island Museum, Sheffield (Acc No. J1917.8); rim bottered and fully milled; stem bore 7/64". (Pcode 07382).
- 136.10 Heel type bowl dating from c1660-1690 unprovenanced material in Kelham Island Museum, Sheffield; rim bottered but not milled; stem bore 7/64". (Pcode 07368).
- 136.11 Heel type bowl dating from c1680-1720 unprovenanced material in Kelham Island Museum, Sheffield; average burnish; rim bottered and three quarters milled; stem bore 8/64". (Pcode 07367).
- 136.12 Spur type bowl dating from c1680-1720 unprovenanced material in Kelham Island Museum, Sheffield; rim internally trimmed and bottered but not milled; stem bore 5/64". Shiny surface. (Pcode 07369).
- 136.13 Heel type bowl dating from c1680-1710 unprovenanced material in Kelham Island Museum, Sheffield (Acc No. 9.6.82/107); rim bottered but not milled; stem bore 6/64". (Pcode 07381).
- 136.14 Spur type bowl dating from c1690-1720 unprovenanced material in Kelham Island Museum, Sheffield; average burnish; rim internally trimmed and bottered but not milled. (Pcode 07370).
- 136.15 Heel type bowl dating from c1690-1720 unprovenanced material in Kelham Island Museum, Sheffield; good burnish; rim internally trimmed and bottered but not milled. Marked with the initials TW on the bowl facing the smoker. (Pcode 07372).
- 137.01 Heel type bowl dating from c1640-1660 from Totley Moor; rim bottered and fully milled. (Pcode 07406).
- 137.02 Heel type bowl dating from c1660-1680 from Dore New Road (Acc No. J1920.74); rim bottered and half milled; stem bore 5/64". (Pcode 07389).
- 137.03 Heel type bowl dating from c1660-1680 from Torside Reservoir (Acc No. 1974.623); rim bottered but not milled. Milled heel. (Pcode 07405).
- 137.04 Heel type bowl dating from c1660-1680 from Temple Borough (Acc No. X1974.620c); average burnish; rim bottered but not milled; stem bore 7/64". Milled heel. (Pcode 07404).
- 137.05 Heel type bowl dating from c1620-1640 from Sheffield Castle (Acc No. 1927.8); rim bottered and fully milled; stem bore 7/64". (Pcode 07396).

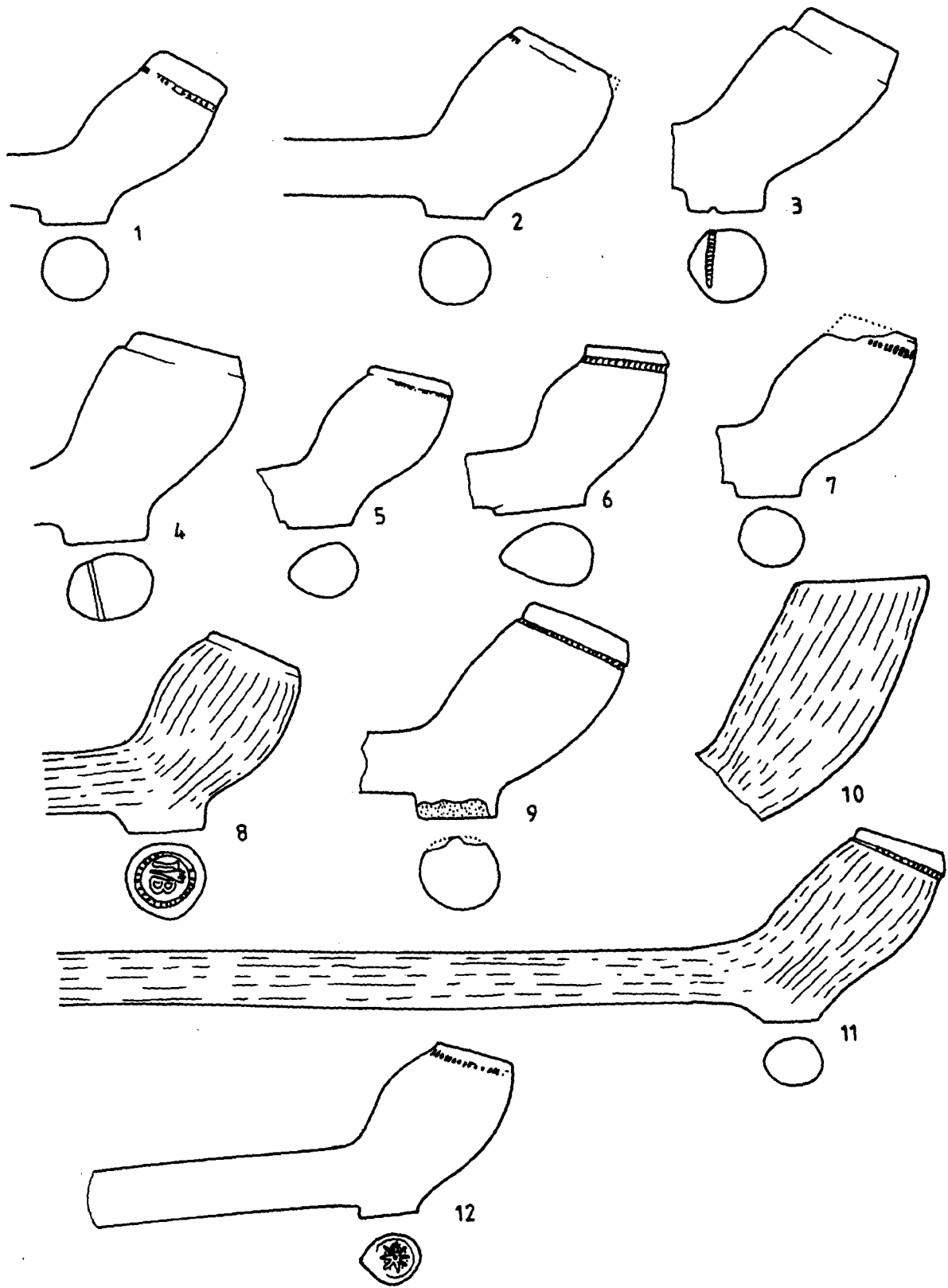
- 137.06 Heel type bowl dating from c1620-1640 from Sheffield Castle (Acc No. 1927.8); rim bottered and fully milled; stem bore 7/64". (Pcode 07400).
- 137.07 Heel type bowl dating from c1640-1660 from Sheffield Castle (Acc No. 1927.8); rim bottered; milled around all of the surviving rim; stem bore 6/64". (Pcode 07398).
- 137.08 Heel type bowl dating from c1660-1680 from Sheffield Castle (Acc No. 1927.8); average burnish; rim bottered but not milled; stem bore 6/64". Marked with the initials IB on the heel. (Pcode 07397).
- 137.09 Heel type bowl dating from c1680-1710 from Sheffield Castle (Acc No. 1927.8); rim bottered and fully milled; stem bore 6/64". (Pcode 07399).
- 137.10 Bowl dating from c1680-1720 from Sheffield Castle (Acc No. 1927.8); average burnish; rim cut but not milled. (Pcode 07401).
- 137.11 Heel type bowl dating from c1660-1680 unprovenanced but probably from Doncaster (Acc No. X1974.620a); poor burnish; rim bottered and three quarters milled; stem bore 8/64". (Pcode 07395).
- 137.12 Heel type bowl dating from c1620-1640 unprovenanced but probably from York (Acc No. J.93.1268 (L1 176)); rim bottered and three quarters milled; stem bore 8/64". Marked with a wheel mark on the heel. Bateman Collection; shiny surface. (Pcode 07383).
- 138.01 Heel type bowl dating from c1680-1730 possibly from Haddon in Cambridgeshire (Acc No. X1974.620b); good burnish; rim bottered and three quarters milled; stem bore 7/64". Marked with the initials WC on the heel. Broseley Type 5. (Pcode 07392).
- 138.02 Heel type bowl dating from c1690-1720 unprovenanced material in Kelham Island Museum, Sheffield; rim internally trimmed and bottered but not milled; stem bore 6/64". Marked with the initials HS on the heel. S reversed. (Pcode 07371).
- 138.03 Spur type bowl dating from c1680-1710 from Ewden Reservoir and district (Acc No. 1974.623); rim bottered but not milled; stem bore 6/64". ?Rainford product. (Pcode 07361).
- 138.04 Spur type bowl dating from c1650-1670 from Ewden Reservoir and district (Acc No. 1974.623); rim bottered and fully milled. Possibly a mark on the bowl facing the smoker; South Lancashire form. (Pcode 07364).
- 138.05 Heel type bowl dating from c1610-1630 from Middleton, Derbyshire (Acc No. J.93.1272); rim bottered and fully milled; stem bore 5/64". Bateman Collection; not a Yorkshire product and not found in Yorkshire, therefore not included in the Database.

- 138.06 Heel type bowl dating from c1640-1660 from Middleton, Derbyshire (Acc No. J.93.1275); rim bottered and fully milled; stem bore 6/64". Bateman Collection; not a Yorkshire product and not found in Yorkshire, therefore not included in the Database.
- 138.07 Heel type bowl dating from c1680-1710 from Middleton, Derbyshire (Acc No. J.93.1273); rim bottered and half milled; stem bore 6/64". Bateman Collection; not a Yorkshire product and not found in Yorkshire, therefore not included in the Database.
- 138.08 Heel type bowl dating from c1660-1690 (Acc No. J93.1271); average burnish; rim bottered but not milled; stem bore 7/64". Marked with the initials AB on the heel. Bateman Collection L.1.68. (Pcode 07403).

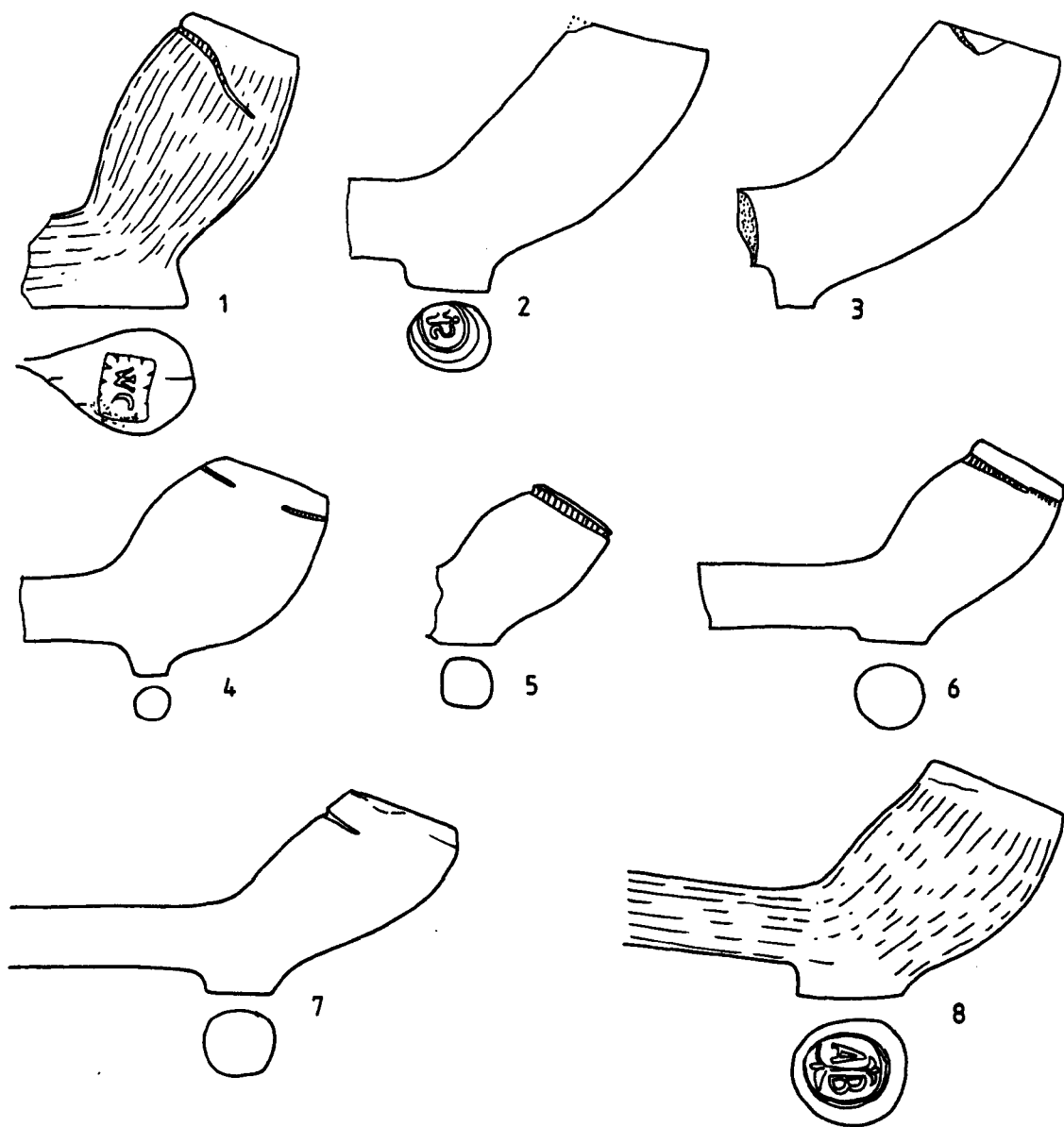




**Figure 136:** Pipes from the collections of Kelham Island Museum, Sheffield. Scale 1:1



**Figure 137:** Pipes from the collections of Kelham Island Museum, Sheffield. Scale 1:1



**Figure 138:** Pipes from the collections of Kelham Island Museum, Sheffield. Scale 1:1

**Collection Name:** Sheffield City Museum  
**Collection Code:** 0144  
**Contact Name:** Gill Woolrich  
**Address:** Sheffield, South Yorkshire

**Description:**

Collection recorded 19<sup>th</sup> June 2000. The archaeological collections are housed here and consist of a reasonable sized collection of pipes from all periods, some of which are on display. Kelham Island Museum houses the Social History Collection. A total of 24 pipes dating from the seventeenth and eighteenth century were recorded in detail for the Yorkshire Database. There were one or two notable pipes in the collection, which are as follows:

- 1995.90-15 – Finely executed mould-decorated bowl depicting a coat of arms with lion and unicorn supporters and the lettering WILLIAM WILD.
- 1997.105 – Mould decorated bowl with flutes at the base of the bowl and crossed-pipes and a tankard on the top part of the bowl.
- 1985.819 – Complete bowl with a meerschaum wash and the lettering HAHN'S PRICE PIPE SHEFFIELD on the bowl facing the smoker.
- E2940 – Mould decorated bowl with a grape and tendril design on both sides and the moulded lettering J. DEE SHEFFIELD around the rim.
- Box containing five Broseley churchwardens (2 now broken). Label in box headed 'Eyam House, Eyam, via Sheffield, Derbyshire. Telephone Eyam 219' has a hand written text stating that these are "Genuine Broseley clay pipes made by William Southern & Co, clay tobacco pipe manufacturers, King St., Broseley, Salop". The note also refers to "...getting a complete set of samples" and is signed E Walker.
- X1974.588 – presumably the sample referred to above. Large box containing a large number of pipes all with turquoise tips except an Elizabethan pattern which is plain. They all appear to be stamped 'Broseley 24'. The box contains 2 Hussars heads (one broken); 5 plain spur/heel type with milled rims; 1 RAOB; 1 Burns Cutty; 12 Thorn; 18 Churchwardens (37.5cm stem).

139.01 Heel type bowl dating from c1640-1660 from Site SMT90 (Acc No. 1996.709.5); rim bottered and fully milled; stem bore 8/64". (Pcode 07358).

139.02 Heel type bowl dating from c1640-1660 (Acc No. 1997.105); rim bottered and fully milled; stem bore 6/64". (Pcode 07337).

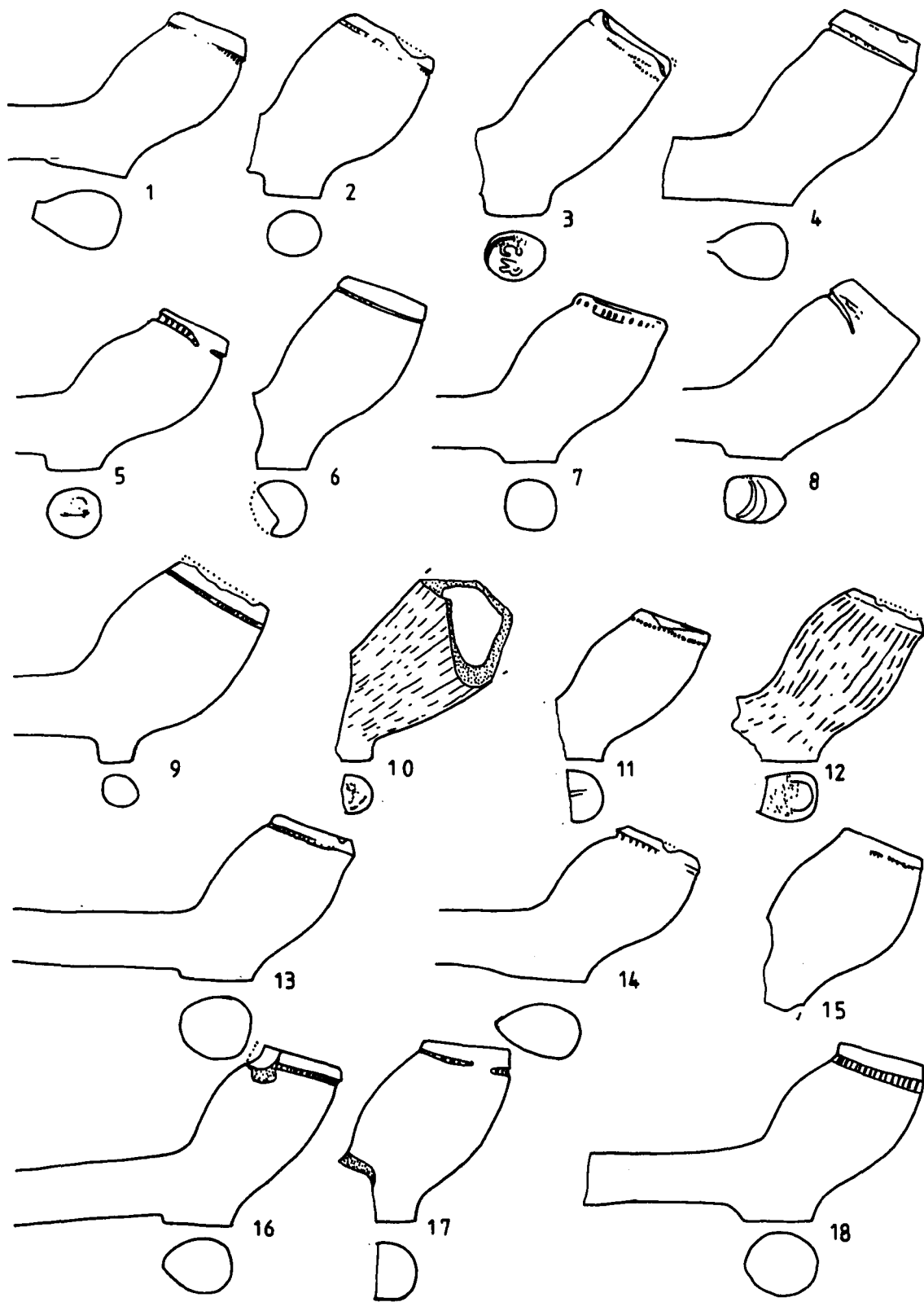
139.03 Heel type bowl dating from c1640-1660 (Acc No. 1997.105); rim bottered and fully milled; stem bore 6/64". Marked with the initials GR on the heel. (Pcode 07338).

139.04 Heel type bowl dating from c1640-1660 from Westfield (Acc No. 1977.28); rim bottered and three quarters milled; stem bore 7/64". (Pcode 07359).

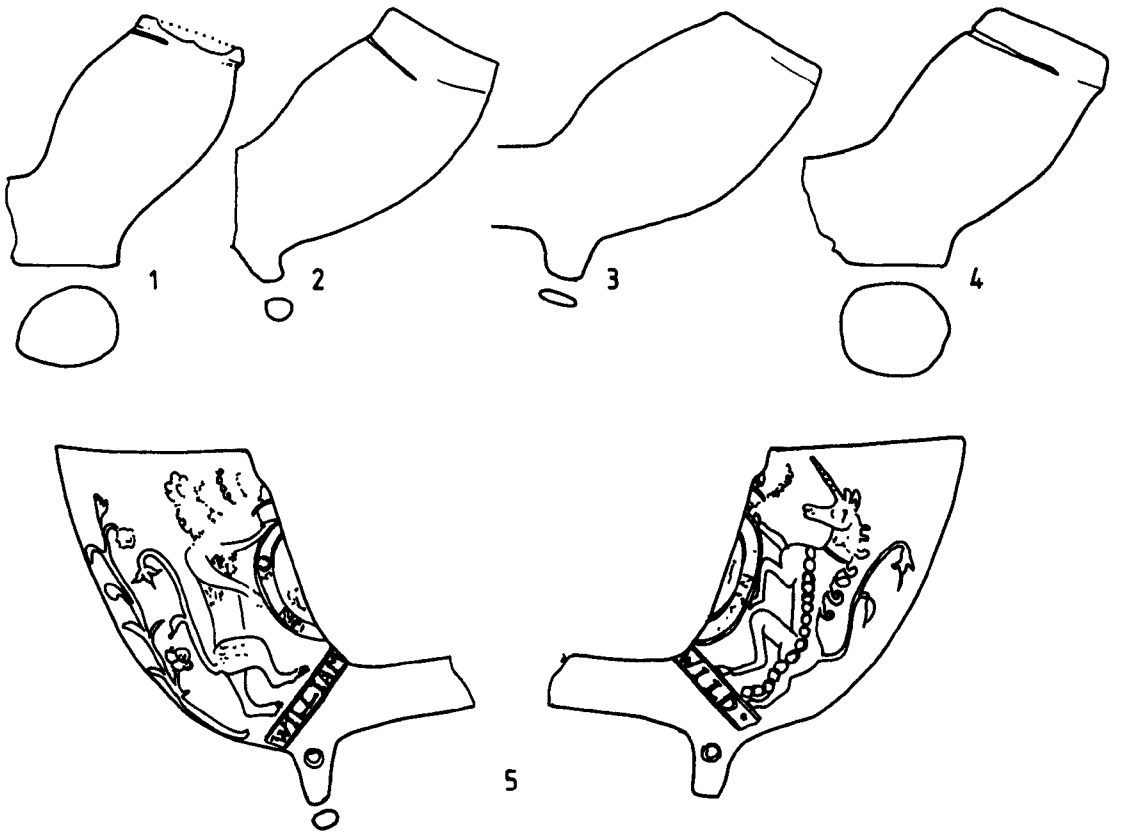
139.05 Heel type bowl dating from c1630-1650 from 7 Storth Lane (Acc No. 1985.817); rim bottered and fully milled; stem bore 6/64". Shiny surface. (Pcode 07332).

- 139.06 Heel type bowl dating from c1640-1660 from 7 Storth Lane (Acc No. 1985.817); rim bottered and fully milled; stem bore 7/64". (Pcode 07333).
- 139.07 Heel type bowl dating from c1640-1660 from Odin's Mine; rim bottered and milled around all of the surviving rim; stem bore 9/64". (Pcode 07356).
- 139.08 Heel type bowl dating from c1640-1660 from Odin's Mine; rim bottered and half milled; stem bore 5/64". Mark illegible. (Pcode 07357).
- 139.09 Spur type bowl dating from c1660-1680 from Derwent, Derbyshire (Acc No. 1997.105); rim bottered and fully milled; stem bore 7/64". (Pcode 07336).
- 139.10 Heel type bowl dating from c1680-1720 from Midhope Reservoir (Acc No. X1975.598); average burnish; stem bore 6/64". No rim surviving; illegible heel mark. (Pcode 07355).
- 139.11 Heel type bowl dating from c1610-1630 from Sheffield Castle (Acc No. 1995.90.15 (H2-4 N. Ext)); good burnish; rim bottered; milled around all of the surviving rim; stem bore 6/64". (Pcode 07352).
- 139.12 Heel type bowl dating from c1620-1650 from Sheffield Castle (Acc No. 1995.84.17); average burnish; rim bottered but not milled; stem bore 7/64". Heel mark illegible. (Pcode 07340).
- 139.13 Heel type bowl dating from c1640-1660 from Sheffield Castle (Acc No. 1995.90.15 (G23-1I)); rim bottered and fully milled; stem bore 5/64". (Pcode 07350).
- 139.14 Heel type bowl dating from c1640-1660 from Sheffield Castle (Acc No. 1995.90.15 (H23 C6)); rim bottered and fully milled; stem bore 7/64". (Pcode 07351).
- 139.15 Heel type bowl dating from c1630-1650 from Sheffield Castle (Acc No. 1995.90.15); rim bottered and fully milled. (Pcode 07344).
- 139.16 Heel type bowl dating from c1640-1660 from Sheffield Castle (Acc No. 1995.84.17); rim bottered and fully milled; stem bore 7/64". (Pcode 07341).
- 139.17 Heel type bowl dating from c1640-1660 from Sheffield Castle (Acc No. 1995.90.15); rim bottered and fully milled; stem bore 6/64". (Pcode 07345).
- 139.18 Heel type bowl dating from c1640-1660 from Sheffield Castle (Acc No. 1995.84.17); rim bottered and fully milled; stem bore 7/64". Shiny surface. (Pcode 07342).
- 140.01 Heel type bowl dating from c1650-1670 from Sheffield Castle (Acc No. 1995.84.17); rim bottered and fully milled; stem bore 7/64". (Pcode 07339).

- 140.02 Spur type bowl dating from c1660-1680 from Sheffield Castle (Acc No. 1995.90.15 (J24 P1)); rim bottered but not milled; stem bore 5/64". (Pcode 07353).
- 140.03 Spur type bowl dating from c1660-1680 from Sheffield Castle (Acc No. 1995.90.15); rim internally trimmed and bottered but not milled; stem bore 7/64". (Pcode 07346).
- 140.04 Heel type bowl dating from c1660-1680 from Sheffield Castle (Acc No. 1995.90.15); rim bottered and three quarters milled; stem bore 6/64". (Pcode 07347).
- 140.05 Spur type bowl dating from c1740-1790 from Sheffield Castle (Acc No. 1995.90.15); rim internally trimmed and cut; stem bore 4/64". Armorial with the lettering William Wild. (Pcode 07348).



**Figure 139:** Pipes from the collection of Sheffield Museum. Scale 1:1.



**Figure 140:** Pipes from the collection of Sheffield Museum. Scale 1:1.



**Collection Name:** Bradford Museum  
**Collection Code:** 0253  
**Contact Name:** Anthea Bickley  
**Address:** Bolling Hall, Bradford, West Yorkshire

**Description:**

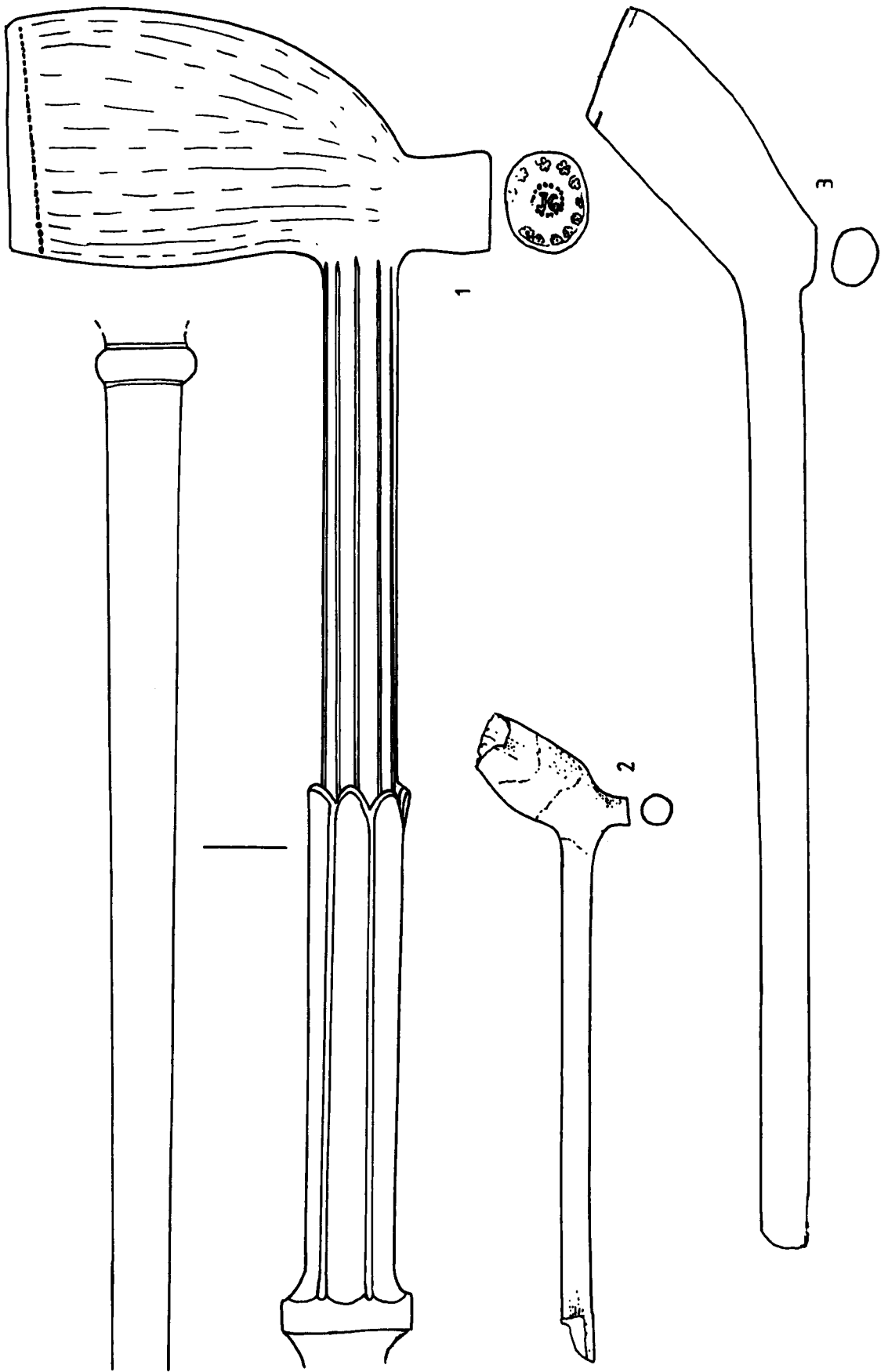
Collection recorded on 16<sup>th</sup> October 2000. Bradford Museum belongs to the same museum service as the Manor House Museum, Ilkley and a number of the pipes seen at Bradford had previously been recorded at Ilkley. There were very few seventeenth or eighteenth century pipes. There were a number of nineteenth-century pipes the most notable of which are as follows:

- 12 football pipes with meerschaum wash and bearing the pattern number 252 all have a white band near the mouthpiece and appear to originate from the same workshop.
- Miniature cherry wood pipe
- 133.46 – Flutes and swags bowl with the lettering ID moulded on either side of the bowl; stem has a knot tied in it.
- Substantial part of a French cadger with a JG stamped heel mark
- 99392 – Bowl with leaf decorated seams and moulded lettering E C KEIGHLEY
- Burns cutty with mould no 92
- H325/79 – RAOB bowl, full face, moulded milling
- RAOB bowl from same mould as above but the stem has been tampered with and is marked 45.
- 2 corrugated Pollock pipes one marked Ben Nevis on both sides of the stem and a mould number, possibly 34, on the left-hand side.
- B22/58 – Complete challenge shape with ochre tip, meerschaum wash and a blue ink mark.
- 3 Church warden pipes
- 8 pipes with distinctive patina and may also have had a rubber mouthpiece that has perished. These are the same as the football pipes. This group includes 1. a dog's head on the heel (no pattern number), 2. a dog's head with 150 on left-hand side, 3. plain spurless pipe with 248 on left-hand side, 4. & 5. two Burns Cutty pipes with 92 on left-hand side and with moulded, 6. small Irish style bowl with shamrocks on the heel and 241 on left-hand side of stem and DUBLIN on the bowl, 7. Plain spurless bowl with an illegible pattern number on the left-hand side, 8. plain heel type with 244 on the left hand side.
- Dutch looking meerschaum bowl with a thin vulcanite stem fitted.
- Plain pipe with coiled stem, fine spur type. Early nineteenth-century, tip now missing, well patinated and well smoked.

141.01 French Cadger bowl dating from c1850-1920, unprovenanced material in Bradford Museum. Good burnish; rim smoothed and fully milled; heel stamped with the initials JG within a floral border.

141.02 Miniature cherry wood pipe.

141.03 Heel type bowl dating from c1680-1710, unprovenanced material in Bradford Museum (labelled 'tobacco pipe J Wild' – possible donor); rim bottered but not milled; stem bore  $5/64$ ".



**Figure 141:** Pipes from the collection of Bolling Hall Museum, Bradford. Scale 1:1

**Collection Name:** Wood Hall Archaeological Trust  
**Collection Code:** 0147  
**Contact Name:** Vivienne Metcalf  
**Address:** Cridling Stubbs, Knottingley, West Yorkshire

**Description:**

A collection of clay tobacco pipes from the excavations at Wood Hall Moated Manor comprising 294 bowls, 1606 stems and 36 mouthpieces, totalling 1936 fragments ranging in date from the late sixteenth century through to the nineteenth century. S D White has prepared a full report on the clay tobacco pipes from the excavation.

A total of 246 of the excavated fragments have been recorded in detail for inclusion in the Yorkshire database. The excavations produced two fragments from a possible multi-bowled pipe.

- 142.01 Heel type bowl dating from c1610-1640 (Acc No. WH93 [20] (1059)); good burnish; stem bore 8/64". Marked with the initial P on the heel. (Pcode 03415).
- 142.02 Heel type bowl dating from c1610-1640 (Acc No. WH93 [20] (1059)); good burnish; rim bottered and fully milled; stem bore 8/64". (Pcode 07467).
- 142.03 Spur type bowl dating from c1610-1640 (Acc No. WH94 [20] (1599)); stem bore 7/64". (Pcode 07505).
- 142.04 Heel type bowl dating from c1610-1640 (Acc No. WH91 [20] (500)); rim bottered and fully milled; stem bore 7/64". (Pcode 07441).
- 142.05 Heel type bowl dating from c1610-1640 (Acc No. WH97 [27] (3272)); rim bottered but not milled; stem bore 7/64". (Pcode 07597).
- 142.06 Bowl dating from c1610-1640 (Acc No. WH94 [20] (736)); rim bottered and milled around all of the surviving rim. (Pcode 07519).
- 142.07 Heel type bowl dating from c1620-1640 (Acc No. WH94 [20] (736)); milled around all of the surviving rim; stem bore 8/64". Milled heel. (Pcode 07516).
- 142.08 Heel type bowl dating from c1620-1640 (Acc No. WH98 [27] (3113)); rim bottered and fully milled; stem bore 8/64". (Pcode 07620).
- 142.09 Heel type bowl dating from c1630-1650 (Acc No. WH94 [20] (1599)); rim bottered and milled around all of the surviving rim; stem bore 9/64". Marked with a Fleur-de-lys on the heel. No burnish lines visible but surface very smooth and shiny. (Pcode 02716).
- 142.10 Heel type bowl dating from c1640-1660 (Acc No. WH96 [27] (2828)); rim bottered and fully milled; stem bore 6/64". (Pcode 07576).

- 142.11 Heel type bowl dating from c1640-1660 (Acc No. WH97 [27] (3001)); rim bottered and fully milled; stem bore 7/64". (Pcode 07586).
- 142.12 Heel type bowl dating from c1640-1660 (Acc No. WH97 [27] (3272)); rim bottered and fully milled; stem bore 7/64". (Pcode 07598).
- 142.13 Heel type bowl dating from c1640-1660 (Acc No. WH97 [27] (3272)); rim bottered but not milled; stem bore 7/64". Heart shaped heel. (Pcode 07599).
- 142.14 Heel type bowl dating from c1640-1660 (Acc No. WH94 [20] (1593)); rim bottered and fully milled; stem bore 8/64". Marked with a wheel mark on the heel. (Pcode 02708).
- 142.15 Heel type bowl dating from c1640-1660 (Acc No. WH94 [20] (1593)); rim bottered and fully milled; stem bore 7/64". (Pcode 07485).
- 142.16 Heel type bowl dating from c1640-1660 (Acc No. WH94 [20] (1593)); rim bottered and fully milled; stem bore 6/64". (Pcode 07484).
- 142.17 Heel type bowl dating from c1640-1660 (Acc No. WH94 [20] (736)); rim bottered and three quarters milled; stem bore 7/64". (Pcode 07523).
- 142.18 Heel type bowl dating from c1640-1660 (Acc No. WH92 [20] (589)); rim bottered and fully milled; stem bore 6/64". (Pcode 07448).
- 142.19 Heel type bowl dating from c1640-1660 (Acc No. WH98 [27] (736)); bur-; rim bottered; stem bore 6/64". Surface of bowl very badly abraded. (Pcode 07624).
- 142.20 Heel type bowl dating from c1640-1670 (Acc No. WH97 [27] (3272)); bur-; rim bottered but not milled; stem bore 6/64". Badly abraded. (Pcode 07600).
- 143.01 Heel type bowl dating from c1640-1660 (Acc No. WH90 [15] (331)); rim bottered and fully milled; stem bore 7/64". (Pcode 07418).
- 143.02 Heel type bowl dating from c1640-1660 (Acc No. WH94 [20] (736)); rim bottered and fully milled; stem bore 7/64". (Pcode 07521).
- 143.03 Heel type bowl dating from c1650-1670 (Acc No. WH94 [20] (1597)); rim bottered but not milled; stem bore 7/64". (Pcode 07498).
- 143.04 Heel type bowl dating from c1640-1660 (Acc No. WH94 [20] (736)); rim bottered and milled around all of the surviving rim; stem bore 6/64". (Pcode 07522).
- 143.05 Heel type bowl dating from c1640-1670 (Acc No. WH96 [20] (1002)); rim bottered and fully milled; stem bore 6/64". (Pcode 07572).
- 143.06 Heel type bowl dating from c1640-1670 (Acc No. WH94 [20] (736)); rim bottered but not milled; stem bore 7/64". (Pcode 07525).

- 143.07 Heel type bowl dating from c1640-1660 (Acc No. WH94 [20] (736)); stem bore 7/64". Milled heel. (Pcode 07526).
- 143.08 Spur type bowl dating from c1640-1660 (Acc No. WH93 [20] (1041)); rim bottered and fully milled; stem bore 6/64". (Pcode 07466).
- 143.09 Heel type bowl dating from c1640-1660 (Acc No. WH94 [20] (1584)); rim bottered and fully milled; stem bore 6/64". (Pcode 07477).
- 143.10 Heel type bowl dating from c1640-1660 (Acc No. WH91 [20] (?509)); good burnish; stem bore 7/64". Marked with the initials GC on the heel. Similar examples found on Tyneside and around Beverley. (Pcode 02715).
- 143.11 Spur type bowl dating from c1640-1660 (Acc No. WH97 [27] (3272)); rim bottered and fully milled; stem bore 8/64". (Pcode 07602).
- 143.12 Heel type bowl dating from c1640-1670 (Acc No. WH93 [20] (1029)); rim bottered and fully milled; stem bore 7/64". (Pcode 07459).
- 143.13 Heel type bowl dating from c1660-1680 (Acc No. WH97 [27] (3001)); rim bottered and three quarters milled; stem bore 7/64". (Pcode 07587).
- 143.14 Heel type bowl dating from c1650-1670 (Acc No. WH97 [27] (3280)); rim bottered and fully milled; stem bore 7/64". (Pcode 07604).
- 143.15 Heel type bowl dating from c1650-1670 (Acc No. WH93 [20] (1538)); rim bottered and fully milled; stem bore 7/64". (Pcode 07469).
- 144.01 Heel type bowl dating from c1650-1670 (Acc No. WH94 [20] (1595)); rim bottered and fully milled; stem bore 7/64". (Pcode 07496).
- 144.02 Heel type bowl dating from c1650-1670 (Acc No. WH94 [20] (1597)); rim bottered and milled around all of the surviving rim; stem bore 7/64". (Pcode 07497).
- 144.03 Heel type bowl dating from c1640-1670 (Acc No. WH97 [27] (3272)); rim bottered and milled around all of the surviving rim; stem bore 6/64". Badly abraded. (Pcode 07601).
- 144.04 Heel type bowl dating from c1650-1670 (Acc No. WH94 [20] (736)); rim bottered and one quarter milled; stem bore 7/64". (Pcode 07520).
- 144.05 Heel type bowl dating from c1650-1670 (Acc No. WH94 [20] (736)); rim internally trimmed, bottered and half milled; stem bore 7/64". (Pcode 07517).
- 144.06 Heel type bowl dating from c1650-1670 (Acc No. WH94 [20] (736)); rim internally trimmed, bottered and fully milled; stem bore 7/64". (Pcode 07518).

- 144.07 Heel type bowl dating from c1650-1670 (Acc No. WH97 [27] (3001)); rim bottered but not milled; stem bore 5/64". (Pcode 07588).
- 144.08 Heel type bowl dating from c1650-1670 (Acc No. WH97 [27] (3274)); good burnish; rim bottered and milled around all of the surviving rim; stem bore 6/64". Marked with the initials SH on the heel. (Pcode 02693).
- 144.09 Heel type bowl dating from c1650-1670 (Acc No. WH97 [27] (3280)); bur-; rim bottered and fully milled; stem bore 7/64". (Pcode 07605).
- 144.10 Heel type bowl dating from c1650-1670 (Acc No. WH93 [20] (1029)); good burnish; rim bottered and half milled; stem bore 5/64". (Pcode 07456).
- 144.11 Heel type bowl dating from c1650-1670 (Acc No. WH97 [27] (3280)); rim bottered but not milled; stem bore 7/64". (Pcode 07606).
- 144.12 Heel type bowl dating from c1650-1670 (Acc No. WH94 [20] (1041)); rim internally trimmed, bottered but not milled; stem bore 7/64". (Pcode 07471).
- 144.13 Heel type bowl dating from c1650-1670 (Acc No. WH90 [15] (375)); rim bottered and half milled; stem bore 6/64". (Pcode 07426).
- 144.15 Heel type bowl dating from c1660-1680 (Acc No. WH94 [14] (1800)); rim bottered but not milled; stem bore 7/64". Similar to a York Type 9. (Pcode 07470).
- 145.01 Heel type bowl dating from c1650-1670 (Acc No. WH97 [27] (3039)); good burnish; rim bottered and one quarter milled; stem bore 7/64". Marked with the initials IG on the heel. ?one of the Gill's of Potovens. (Pcode 02688).
- 145.02 Heel type bowl dating from c1650-1670 (Acc No. WH93 [20] (1041)); average burnish; rim bottered and one quarter milled; stem bore 7/64". Marked with the initials IB on the heel. (Pcode 02718).
- 145.03 Heel type bowl dating from c1650-1680 (Acc No. WH97 [27] (3272)); good burnish; rim bottered but not milled; stem bore 5/64". Marked with the initials MP on the heel. (Pcode 02689).
- 145.04 Heel type bowl dating from c1660-1680 (Acc No. WH90 [15] (384)); rim bottered and milled around all of the surviving rim; stem bore 7/64". (Pcode 07430).
- 145.05 Heel type bowl dating from c1650-1670 (Acc No. WH92 [20] (810)); rim bottered and three quarters milled; stem bore 7/64". (Pcode 07451).
- 145.06 Heel type bowl dating from c1650-1670 (Acc No. WH94 [20] (1904)); good burnish; rim bottered and half milled; stem bore 7/64". (Pcode 07510).

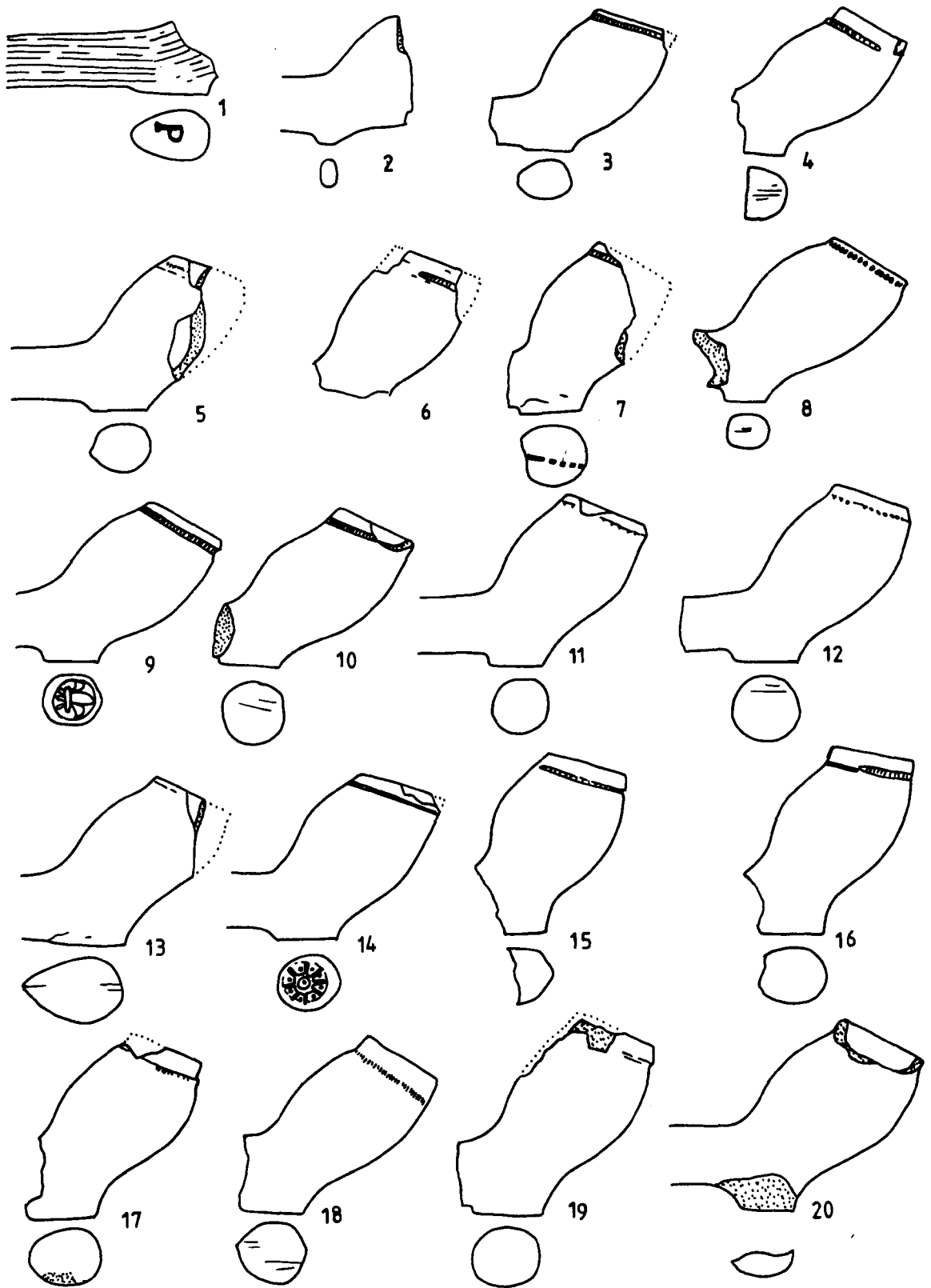
- 145.07 Heel type bowl dating from c1650-1670 (Acc No. WH92 [20] (810)); good burnish; rim bottered and half milled; stem bore 7/64". Marked with the initials IH on the heel. Very neat mark. (Pcode 02719).
- 145.08 Heel type bowl dating from c1650-1670 (Acc No. WH92 [20] (840)); good burnish; rim bottered and fully milled; stem bore 7/64". Marked with the initials ON (Castle) on the heel. Similar marks recovered from Pontefract Castle. (Pcode 02724).
- 145.09 Heel type bowl dating from c1660-1680 (Acc No. WH94 [20] (736)); good burnish. Marked with the initials IB on the heel. Heel fragment only. (Pcode 02709).
- 145.10 Heel type bowl dating from c1650-1670 (Acc No. WH98 [27] (3461)); good burnish; rim bottered but not milled; stem bore 7/64". Marked with the initials IB on the heel. Examples of marks similar to this from excavations in York. (Pcode 02694).
- 145.11 Heel type bowl dating from c1660-1680 (Acc No. WH96 [27] (3000)); rim bottered and one quarter milled; stem bore 5/64". (Pcode 07579).
- 145.12 Heel type bowl dating from c1660-1680 (Acc No. WH95 [26] (2000)); rim bottered and half milled; stem bore 6/64". Marked with the initials IH on the heel. (Pcode 02682).
- 145.13 Heel type bowl dating from c1660-1680 (Acc No. WH97 [5] (2)); average burnish; rim bottered and half milled; stem bore 6/64". Marked with the initials WL on the heel. Possibly William Lee of Rotherham. (Pcode 02684).
- 145.14 Heel type bowl dating from c1660-1680 (Acc No. WH96 [27] (3000)); good burnish; rim bottered and one quarter milled; stem bore 6/64". Very bulbous form. (Pcode 07578).
- 146.01 Heel type bowl dating from c1660-1680 (Acc No. WH97 [27] (3280)); rim bottered but not milled; stem bore 6/64". (Pcode 07603).
- 146.02 Heel type bowl dating from c1660-1680 (Acc No. WH97 [27] (736)); rim bottered but not milled; stem bore 7/64". (Pcode 07611).
- 146.03 Heel type bowl dating from c1660-1680 (Acc No. U/S); good burnish; rim bottered but not milled. Marked with the initials IH on the heel. From a bag of material from Trench 20. (Pcode 02714).
- 146.04 Heel type bowl dating from c1660-1680 (Acc No. WH97 [27] (736)); rim bottered but not milled; stem bore 7/64". (Pcode 07612).
- 146.05 Heel type bowl dating from c1660-1680 (Acc No. WH93 [20] (1041)); good burnish; rim bottered but not milled; stem bore 7/64". Marked with the initials ON (Castle) on the heel. Similar to a style of mark recovered from Pontefract Castle. (Pcode 02717).



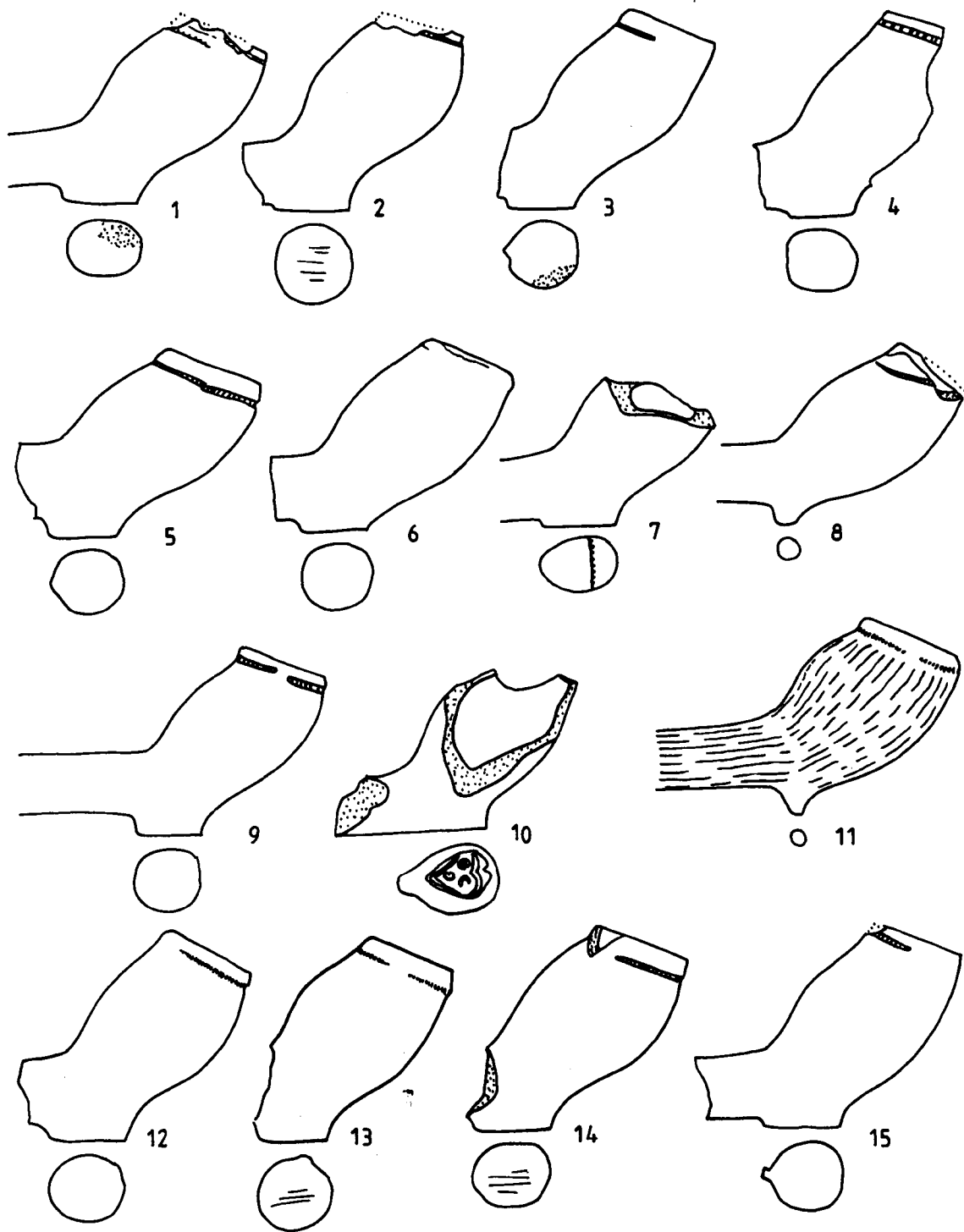
- 146.06 Heel type bowl dating from c1660-1680 (Acc No. WH92 [20] (590)); good burnish; rim bottered but not milled. Marked with the initials IH on the heel. (Pcode 02722).
- 146.07 Heel type bowl dating from c1660-1680 (Acc No. WH94 [20] (1584)); rim internally trimmed, bottered and fully milled; stem bore 7/64". (Pcode 07478).
- 146.08 Heel type bowl dating from c1660-1680 (Acc No. WH94 [20] (1584)); rim bottered and half milled; stem bore 6/64". (Pcode 07479).
- 146.09 Heel type bowl dating from c1660-1680 (Acc No. WH92 [20] (810)); rim bottered and half milled; stem bore 7/64". (Pcode 07452).
- 146.10 Heel type bowl dating from c1690-1710 (Acc No. WH92 [20] (590)); good burnish; stem bore 6/64". Marked with the initials HS across the stem. No rim. (Pcode 02723).
- 146.11 Heel type bowl dating from c1690-1710 (Acc No. WH97 [14] (1828)); good burnish; rim bottered and half milled; stem bore 6/64". Marked with the initials HS across the stem. Bag labelled WH97 [27] 3272 SF. 679. (Pcode 02692).
- 147.01 Heel type bowl dating from c1690-1710 (Acc No. WH96 [27] (3003)); good burnish; rim bottered and half milled; stem bore 5/64". Marked with the initials MH on the heel. (Pcode 02687).
- 147.02 Heel type bowl dating from c1690-1710 (Acc No. WH91 [20] (500)); rim internally trimmed, bottered but not milled; stem bore 6/64". (Pcode 07440).
- 147.03 Heel type bowl dating from c1740-1770 (Acc No. WH94 [20] (1593)); good burnish; rim wiped but not milled; stem bore 7/64". Marked with the crowned initials IG across the stem. (Pcode 02725).
- 147.04 Spur type bowl dating from c1690-1720 (Acc No. WH93 [20] (1041)); average burnish; rim wiped but not milled; stem bore 7/64". Marked with the initials IH across the stem. (Pcode 07465).
- 147.06 Heel type bowl dating from c1700-1770 (Acc No. WH90 [15] (404)); good burnish; X type bowl cross; stem bore 5/64". Marked with the initials SH on the sides of the heel. Possibly S Hillary. (Pcode 07433).
- 147.07 Heel fragment dating from c1700-1770 (Acc No. WH96 [27] (3000)); stem bore 4/64". Marked with the initials SH on the sides of the heel. (Pcode 07580).
- 147.09 Heel fragment dating from c1700-1750 (Acc No. WH90 [15] (334)); good burnish; stem bore 4/64". Marked with a crowned rose on the sides of the heel. (Pcode 07419).

- 148.01 Stem fragment dating from c1750-1770 (Acc No. WH92 [20] (590)); good burnish; stem bore 5/64". Marked with the initials (T)HOWIL(D) around the stem. Thomas Wild. (Pcode 02731).
- 148.02 Stem fragment dating from c1650-1750 (Acc No. WH96 [27] (3200)); stem bore 6/64". Marked with the initials SV across the stem. (Pcode 02691).
- 148.03 Spur fragment dating from the late 18th century (Acc No. WH91 [20] (500)); stem bore 5/64". Marked with a diamond pattern around the stem.
- 148.04 Spur type bowl dating from c1800-1820 (Acc No. WH91 [20] U/S); stem bore 4/64". Britannia design, same as the 1797 issue coinage, design changed in 1821.
- 148.05 Spur bowl dating from c1830-1860 (Acc No. WH92 [21] (921)); rim cut but not milled; stem bore 4/64". Rose and thistle design, from the same mould as an example from Pontefract Castle (PC82 [080] sf829).
- 148.06 Spur type bowl dating from c1790-1820 (Acc No. WH90 [15] (384)); rim cut but not milled; stem bore 4/64". Marked with the initials TT on the smoker's right. Design comprising a cup and a coat of arms.
- 148.07 Spur type bowl dating from c1780-1850 (Acc No. WH97 [20] (2416)); rim cut but not milled; stem bore 5/64". Masonic design.
- 148.08 Spur type bowl dating from c1780-1850 (Acc No. WH90 [15] (1)); rim cut but not milled; stem bore 4/64". Masonic design.
- 148.09 Spur type bowl dating from c1830-1860 (Acc No. WH90 [15] (331)); rim cut but not milled; stem bore 3/64". Masonic design.
- 148.10 Spur type bowl dating from c1820-1840 (Acc No. U/S); rim cut but not milled; stem bore 5/64". From a bag of material from Trench 20. Masonic design.
- 148.11 Spur type bowl dating from c1820-1870 (Acc No. WH90 [15] (1)); rim cut but not milled; stem bore 5/64". Masonic design.
- 149.01 Spur type bowl dating from c1780-1850 (Acc No. WH90 [15] (331)); rim cut but not milled; stem bore 5/64". Masonic design very similar to Figure 147.08
- 149.02 Spur type bowl dating from c1796-1818 (Acc No. WH90 [15] (399)); stem bore 5/64". Marked with the lettering THOMASWESTERDELL on the sides of the bowl. Thomas Westerdell working in Alfred Gelder Street, Hull between 1796 and 1806.

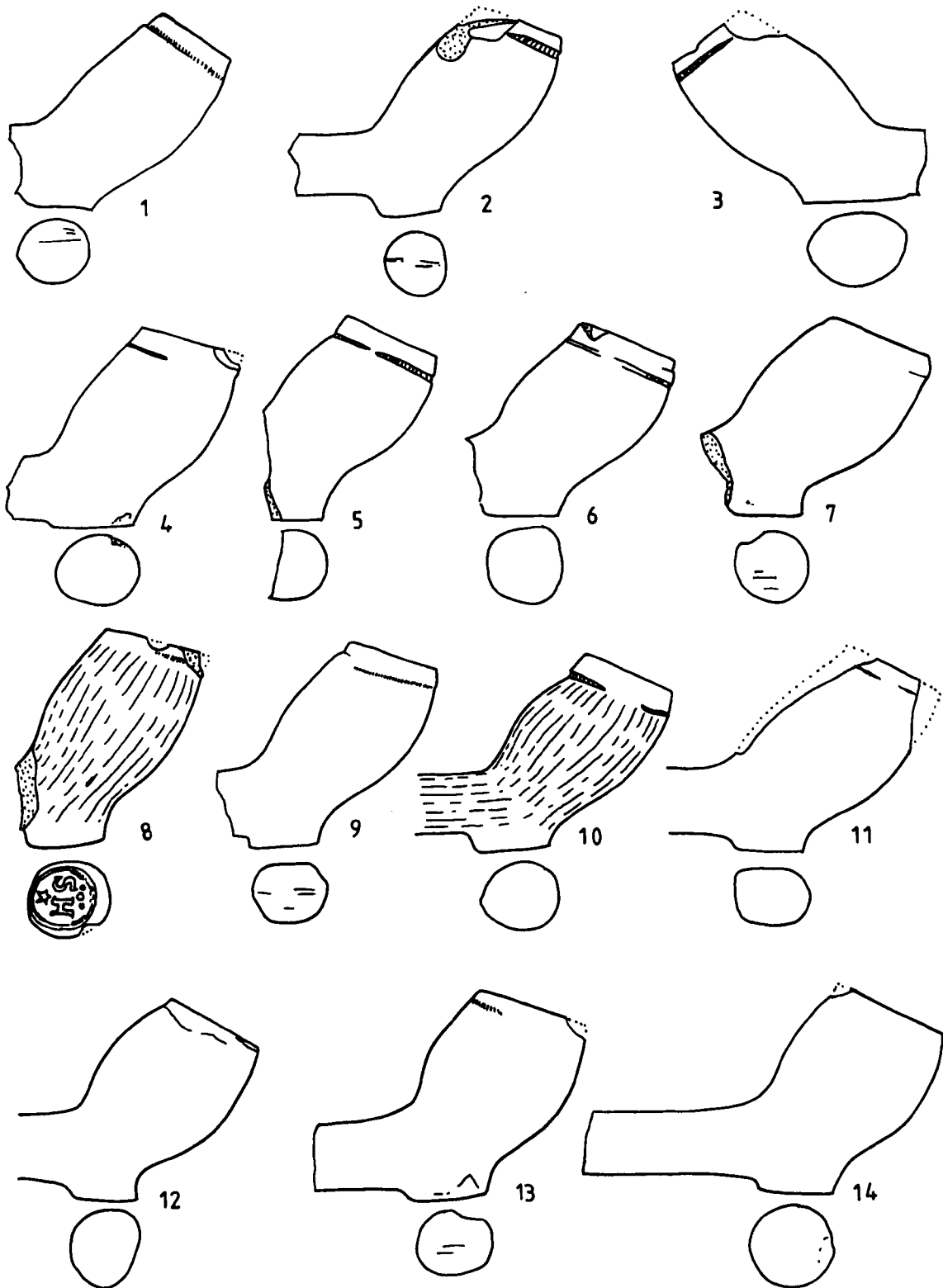
- 149.03 Spur type bowl dating from c1830-1860 (Acc No. WH91 [20] (514)); rim cut but not milled; stem bore  $5/64$ ". Ship and sailor design, similar examples found at Pontefract Castle.
- 149.04 Spur type bowl dating from c1770-1800 (Acc No. WH90 [15] (375)); rim cut but not milled; stem bore  $4/64$ ". Enclosed flutes with a stags head facing the smoker. Traces of a dot and circle mark on the left hand side of the bowl.
- 149.05 Spur type bowl dating from c1770-1800 (Acc No. WH91 [20] (741)); rim wiped but not milled; stem bore  $5/64$ ". Enclosed flutes with a stags head facing the smoker.
- 149.06 Spur type bowl dating from 1815+ (Acc No. WH90 [15] (373)); rim cut but not milled; stem bore  $3/64$ ". Marked with the initials THOM. on the smokers left. Similar design illustrated by Watkins 1979, 101 fig 46; most probably Thomas Westerdell(dale).
- 149.07 Spur type bowl dating from c1740-1800 (Acc No. WH93 [20] (1281)); rim cut but not milled; stem bore  $5/64$ ". Design comprising a standing supporter.
- 149.08 Stem fragment dating from the 17th century (Acc No. WH94 [20] (1593)); stem bore  $6/64$ ". Possibly part of a multi-bowled pipe.
- 149.09 Stem fragment dating from the 17th century (Acc No. WH94 [20] (1582)); stem bore  $7/64$ ". Possibly part of a multi-bowled pipe.
- 149.10 Hypothetical reconstruction of a multi-bowled pipe. The hatched areas give an indication of the possible location of the Wood Hall fragments.



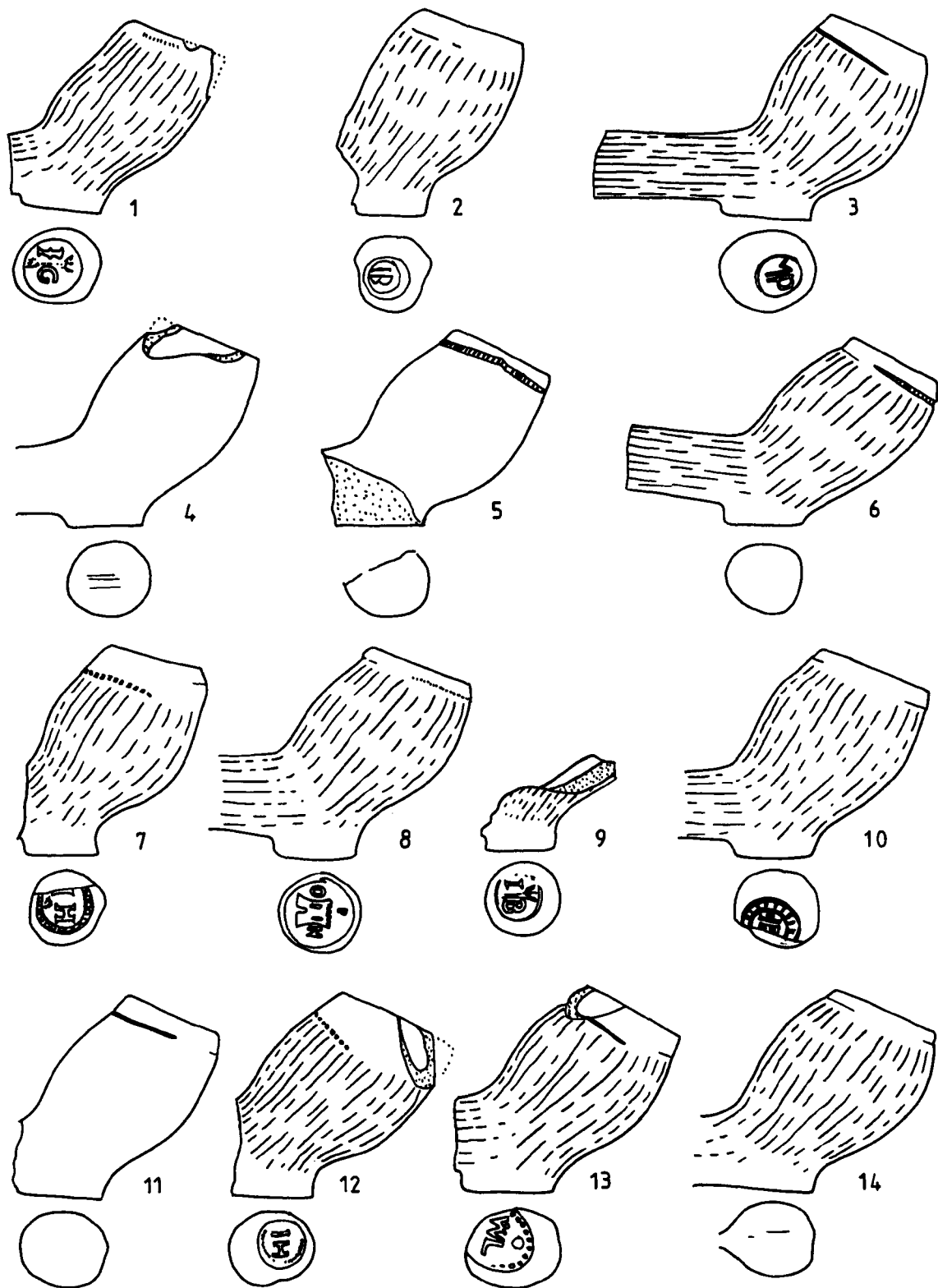
**Figure 142:** Pipes recovered from excavations at Wood Hall Moated Manor. Scale 1:1. NB. All illustrations by the author but reproduced by kind permission of the Wood Hall Moated Manor Trust.



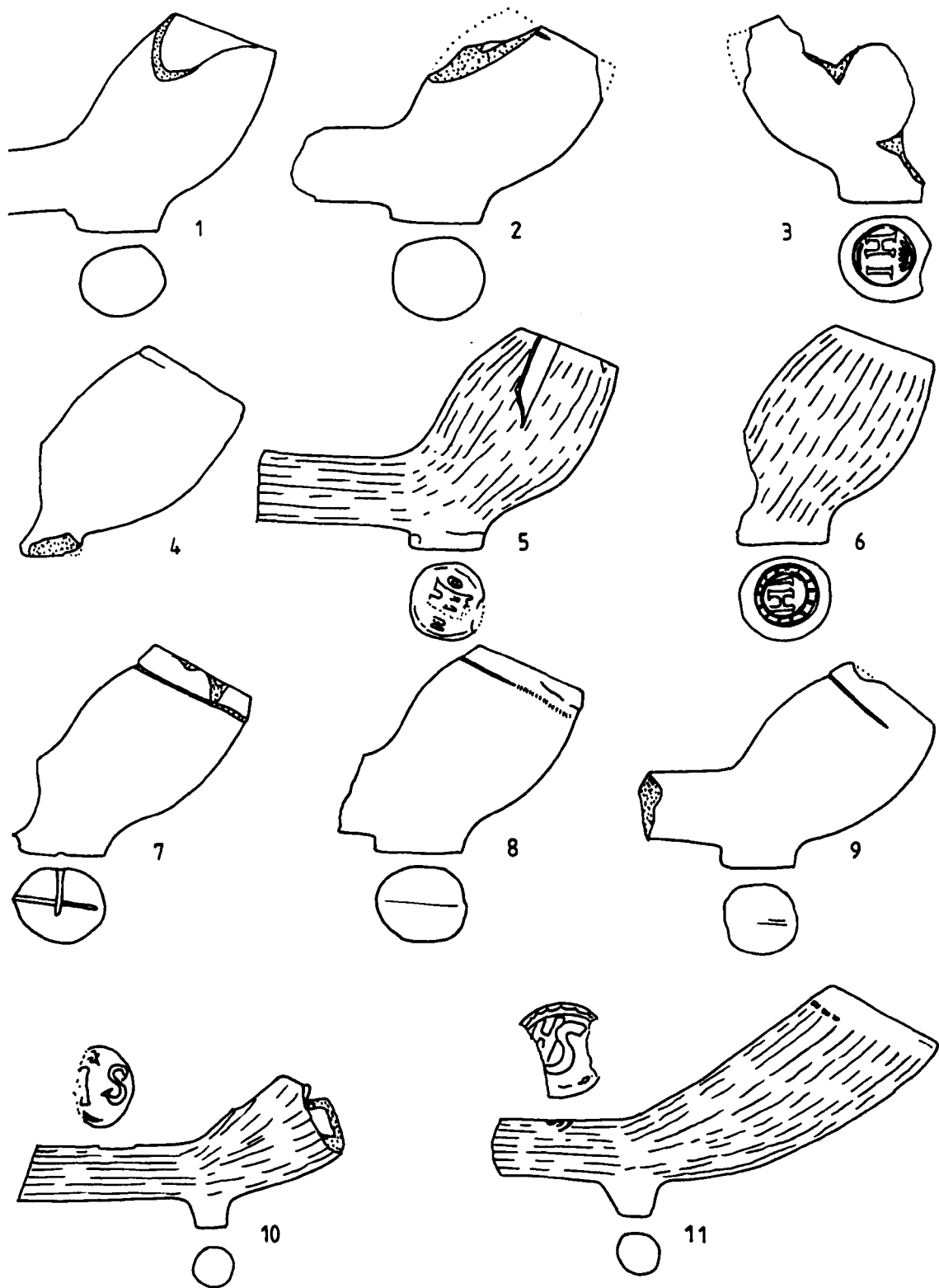
**Figure 143:** Pipes recovered from excavations at Wood Hall Moated Manor. Scale 1:1. NB. All illustrations by the author but reproduced by kind permission of the Wood Hall Moated Manor Trust.



**Figure 144:** Pipes recovered from excavations at Wood Hall Moated Manor. Scale 1:1. NB. All illustrations by the author but reproduced by kind permission of the Wood Hall Moated Manor Trust.

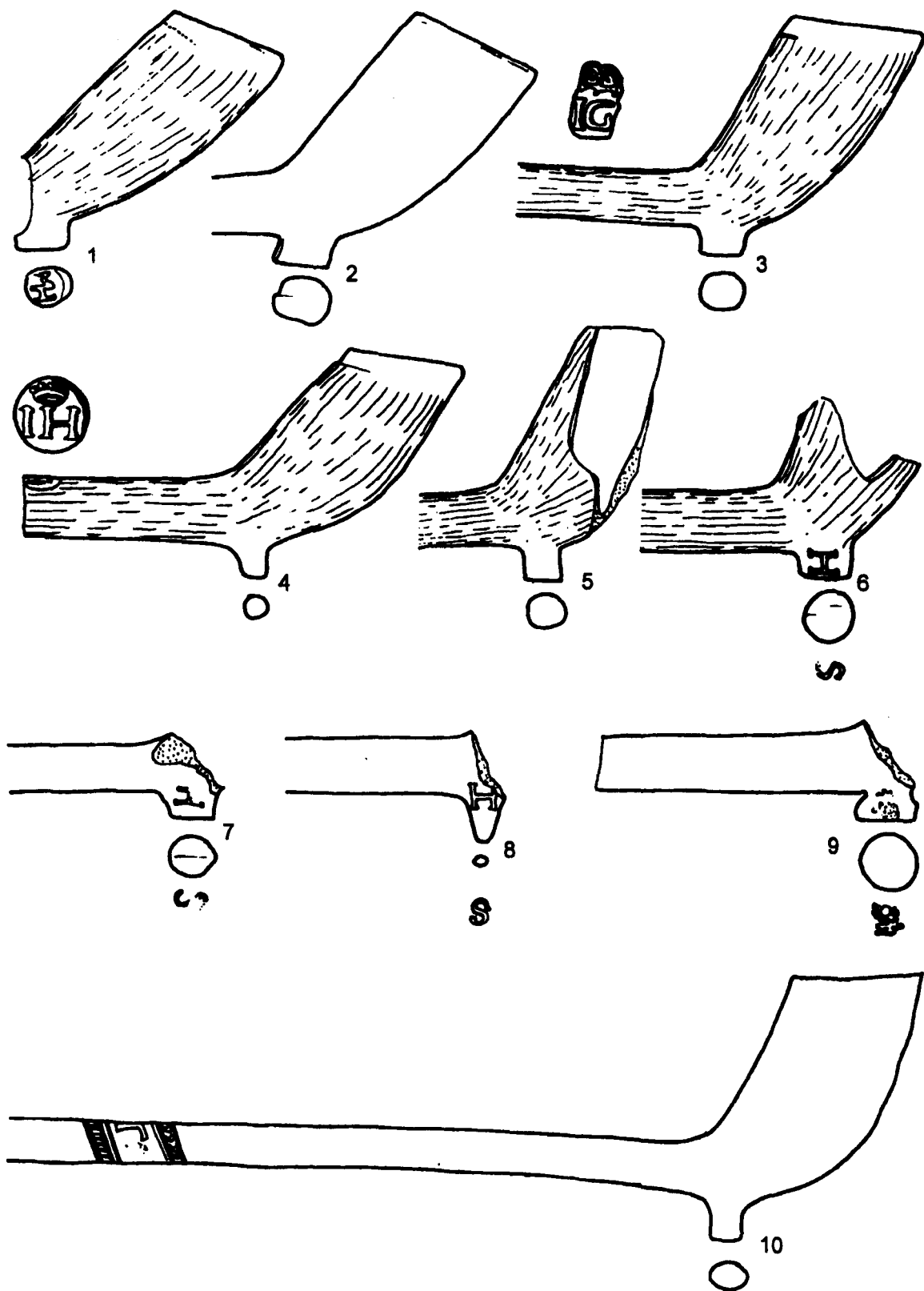


**Figure 145:** Pipes recovered from excavations at Wood Hall Moated Manor. Scale 1:1. NB. All illustrations by the author but reproduced by kind permission of the Wood Hall Moated Manor Trust.

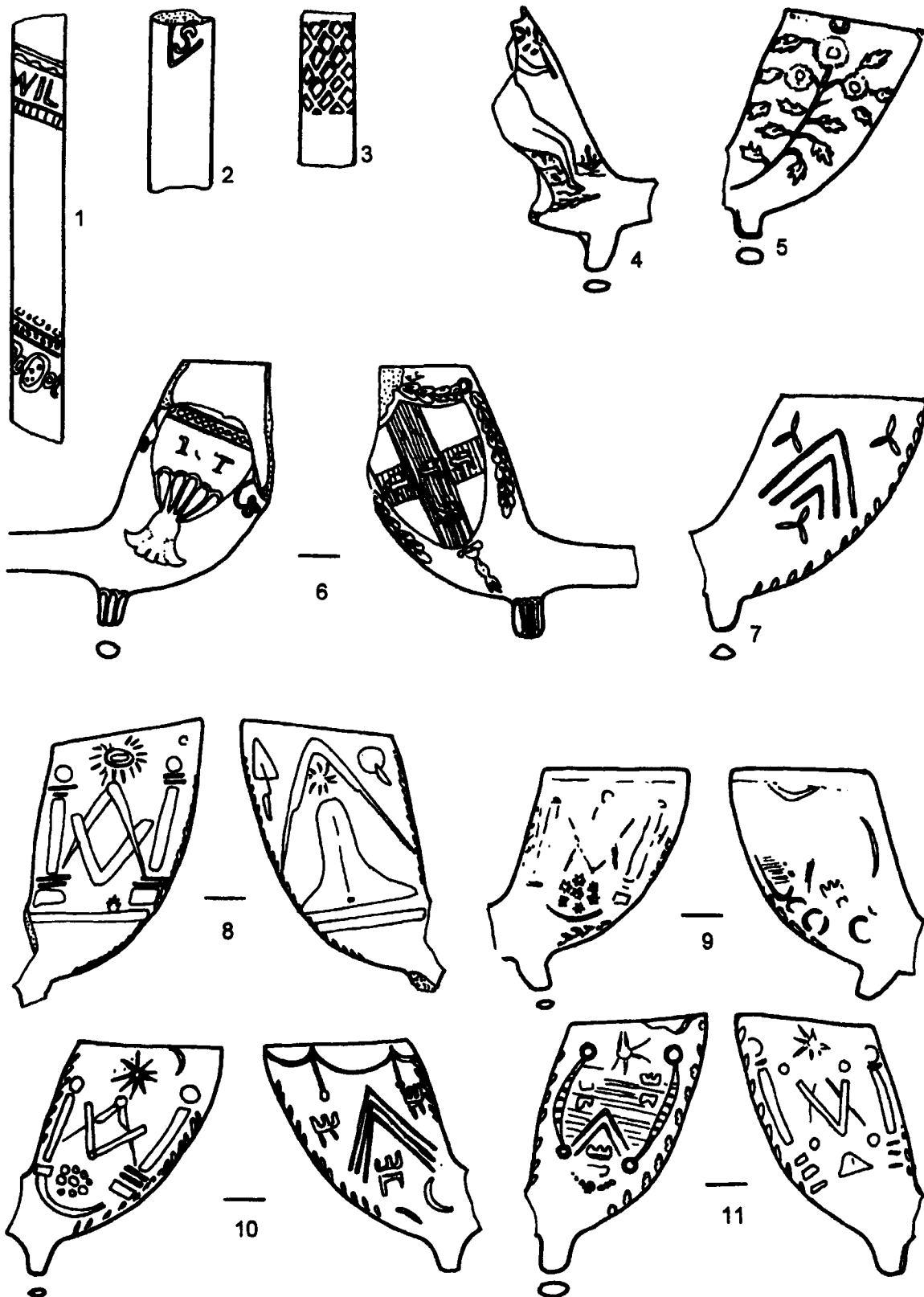


**Figure 146:** Pipes recovered from excavations at Wood Hall Moated Manor. Scale: Pipes at 1:1, stamp details at 2:1. NB. All illustrations by the author but reproduced by kind permission of the Wood Hall Moated Manor Trust.

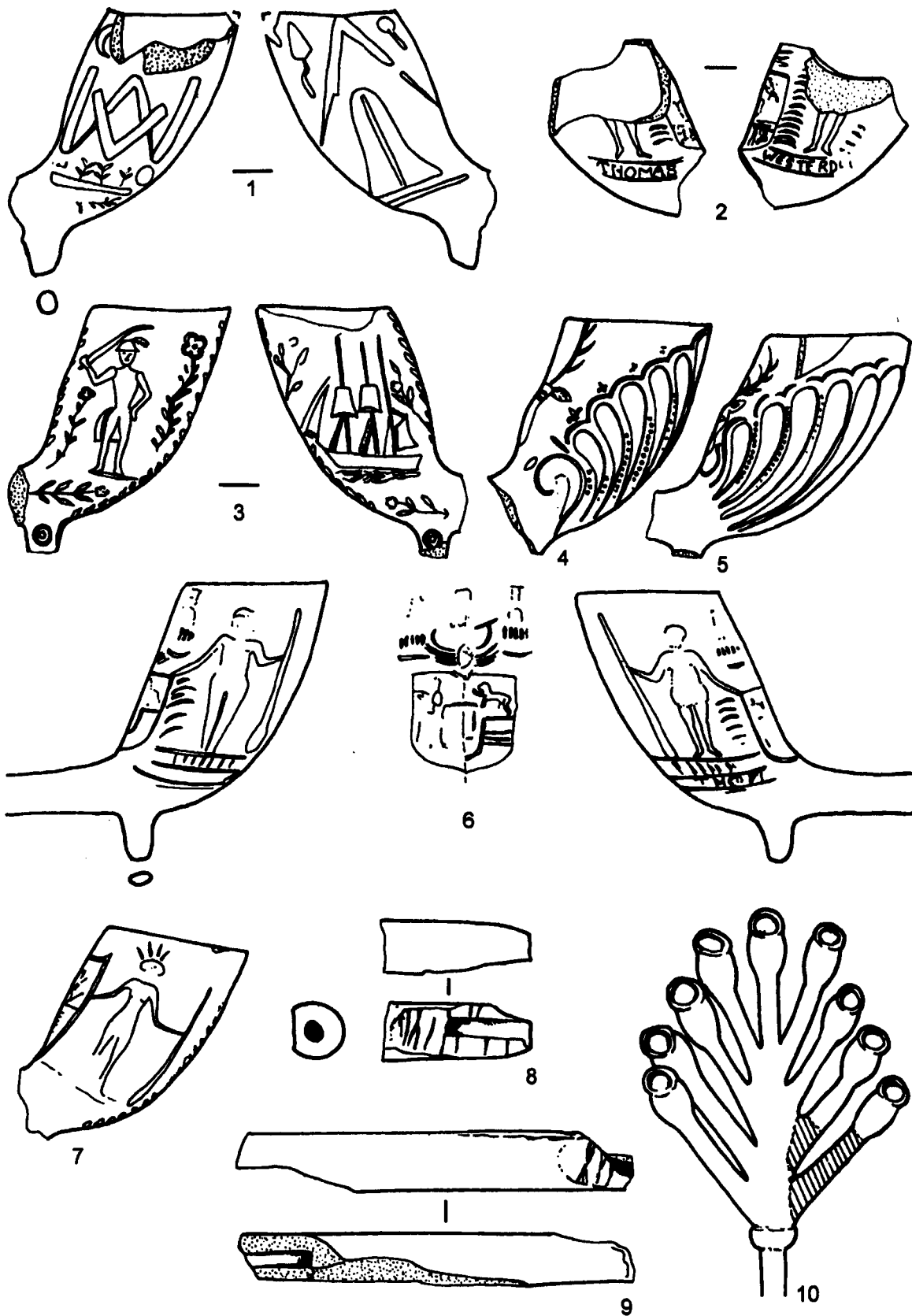




**Figure 147:** Pipes recovered from excavations at Wood Hall Moated Manor. Scale: Pipes at 1:; stamp detail at 2:1. NB. All illustrations by the author but reproduced by kind permission of the Wood Hall Moated Manor Trust.



**Figure 148:** Pipes recovered from excavations at Wood Hall Moated Manor. Scale 1:1. NB. All illustrations by the author but reproduced by kind permission of the Wood Hall Moated Manor Trust.



**Figure 149:** Pipes recovered from excavations at Wood Hall Moated Manor. Scale 1:1. NB. All illustrations by the author but reproduced by kind permission of the Wood Hall Moated Manor Trust.

**Collection Name:** Tolson Memorial Museum  
**Collection Code:** 0149  
**Contact Name:** John Rumsby/Katrina Bill  
**Address:** Huddersfield, West Yorkshire

**Description:**

Collection recorded 18<sup>th</sup> September 2000. A very large collection consisting of seventeenth and eighteenth century pipes as well as a large number of late nineteenth century pipes in a substantially complete and fresh condition. Although now mixed and boxed/bagged in various places, these must all have come from a common source. Some paper labels survive, as well as meerschaum washes pipes. Ranges from McLardys to Goedewaagen, Dumeril and Fiolet; mainly plain bowls, but lots with nice enamel decoration on the stem. A total of 88 pipes dating from the seventeenth or eighteenth century were recorded in detail for inclusion in the Yorkshire Database. Amongst the later material the following were the most noteworthy:

- A large number of complete French pipes with enamel stem decoration.
- Two complete meerschaum wash McLardy pipes (one plain Irish style, the other football/boot pipe)
- Three red Posner of London pipes.
- Meerschaum bowl in the form of a lady's head
- Wooden pipe case containing a Gambier pipe with white enamel decoration and milled rim; mould no. 241.

150.01 Heel type bowl dating from c1660-1680 from Bills o Jacks (Acc No. Box 3464); rim bottered; milled around all of the surviving rim; stem bore 7/64". Label reads "pipe bowls excavated at Bills of Jacks, Saddleworth by Mr F Buckley pres 1945". (Pcode 07710).

150.02 Heel type bowl dating from c1660-1680 from Bills o Jacks (Acc No. Box 3464); rim bottered; milled around all of the surviving rim; stem bore 7/64". Label reads "pipe bowls excavated at Bills of Jacks, Saddleworth by Mr F Buckley pres 1945". (Pcode 07709).

150.03 Heel type bowl dating from c1660-1690; labelled "found at Lepton" (Acc No. 12/76); good burnish; rim bottered and three quarters milled; stem bore 6/64". Marked with the initials IG on the heel. Similar to 1449; mark upside down. (Pcode 07741).

150.04 Spur type bowl dating from c1660-1690 from Brushes Moor (Acc No. Box 3464); good burnish; rim bottered and one quarter milled; stem bore 6/64". Marked with the initials IB on the bowl facing the smoker. Found on Brushes Moor by Mr John Rhodes; possible Rainford type. (Pcode 07712).

150.05 Heel type bowl dating from c1660-1680 from Dog Hill, Rishworth Moor (Acc No. Box 3464); good burnish; rim bottered but not milled; stem bore 7/64". (Pcode 07734).

150.06 Heel type bowl dating from c1650-1670 from Holdsworth House (Acc No. HH69J3(2)); rim bottered but not milled; stem bore 6/64". (Pcode 07740).

- 150.07 Heel type bowl dating from c1650-1680 from Holdsworth House (Acc No. HH68Aii(10)); average burnish; rim bottered and half milled; stem bore 5/64". Marked with the initials IG on the heel. (Pcode 07739).
- 150.08 Heel type bowl dating from c1660-1680 from Moors (Acc No. Box 3464); rim bottered and half milled; stem bore 7/64". Label reads "found on moors N of Slaithwaite G Fryer Malmsbridge 1960". (Pcode 07747).
- 150.09 Heel type bowl dating from c1650-1670 from Longcroft (Acc No. Box 3417); rim bottered and fully milled; stem bore 6/64". Marked with the initials IW on the heel. (Pcode 07708).
- 150.10 Heel type bowl dating from c1650-1670 from Oakwell Hall (Acc No. Box 11083); good burnish; rim bottered and fully milled; stem bore 5/64". Marked with the initials W on the heel. Labelled Trench G (88) base of (1). (Pcode 07750).
- 150.11 Heel type bowl dating from c1690-1710 from Oakwell Hall (Acc No. Box 11083); average burnish; rim bottered but not milled; stem bore 7/64". Marked with the crowned initials IW on the heel. Labelled Trench G (88) base of (1). (Pcode 07749).
- 150.12 Heel type bowl dating from c1690-1710 from Oakwell Hall (Acc No. Box 11083); good burnish; rim bottered but not milled; stem bore 5/64". Excavated 1977-78 TG (184) OH78. (Pcode 07748).
- 150.13 Heel type bowl dating from c1670-1700 from Picte Hill (Acc No. Box 3464); good burnish; stem bore 6/64". No rim surviving. (Pcode 07751).
- 151.01 Heel type bowl dating from c1650-1670 from Pike Farm Fields (Acc No. 83.108.59); rim bottered and half milled; stem bore 5/64". (Pcode 076076).
- 151.02 Heel type bowl dating from c1650-1670 from Pike Farm Fields (Acc No. 83.112.59); good burnish; rim bottered and fully milled; stem bore 6/64". (Pcode 07753).
- 151.03 Heel type bowl dating from c1660-1670 from Pike Farm Fields (Acc No. 83.110.59); rim bottered; stem bore 6/64". (Pcode 07677).
- 151.04 Heel type bowl dating from c1660-1680 from Pike Farm Fields (Acc No. 83.111.59); rim bottered but not milled; stem bore 6/64". Possibly burnished. (Pcode 07678).
- 151.05 Heel type bowl dating from c1640-1660 from Saddleworth Moor (Acc No. Box 3464); good burnish; rim bottered and fully milled; stem bore 7/64". Marked with the initials PT on the heel. (Pcode 07756).

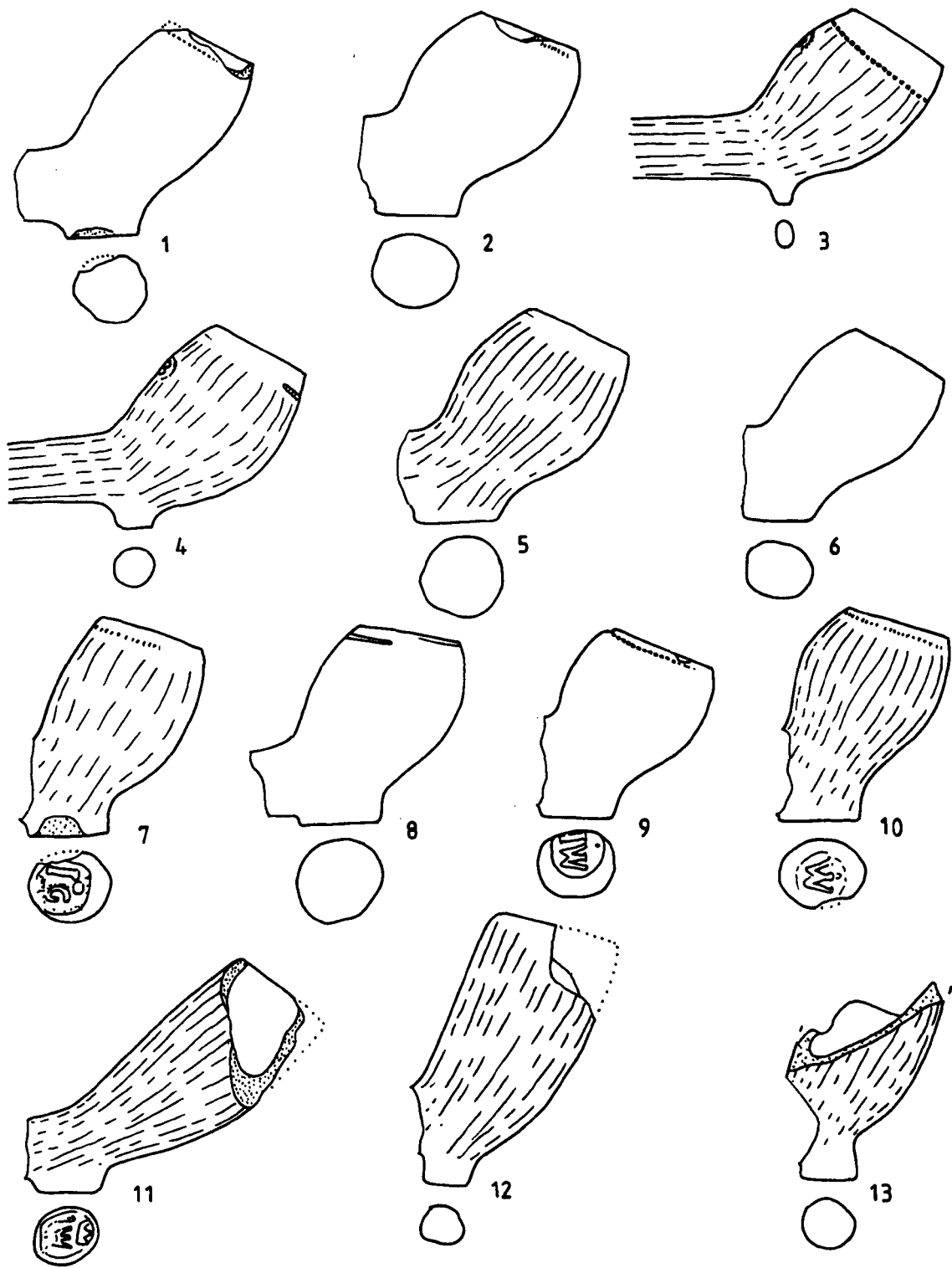
- 151.06 Heel type bowl dating from c1660-1680 from Rishworth Moor (Acc No. Box 3464); rim bottered but not milled; stem bore 7/64". Marked with the initials IG on the heel. (Pcode 07755).
- 151.07 Heel type bowl dating from c1650-1670 from Sowerby Castle (Acc No. Box 3464); rim bottered but not milled; stem bore 7/64". Labelled "Sowerby Castle 20.7.1965". (Pcode 07702).
- 151.08 Heel type bowl dating from c1650-1670 from Stoney Bank (Acc No. 60.16.47); rim bottered and half milled; stem bore 5/64". Labelled "Stoney Bank, New Mill". (Pcode 07757).
- 151.09 Heel type bowl dating from c1640-1660 from Wrenthorpe (Acc No. 14.16.69); rim bottered and fully milled; stem bore 5/64". (Pcode 07705).
- 151.10 Heel type bowl dating from c1640-1660 from Wrenthorpe (Acc No. 14.16.69); rim bottered and fully milled; stem bore 6/64". (Pcode 07704).
- 151.11 Heel type bowl dating from c1640-1660 (Acc No. Box 3464); rim bottered and fully milled; stem bore 6/64". (Pcode 07735).
- 151.12 Heel type bowl dating from c1660-1680 from Wrenthorpe (Acc No. 14.16.69); rim bottered and three quarters milled; stem bore 6/64". (Pcode 07703).
- 151.13 Heel type bowl dating from c1660-1680 from Thornhill Hall (Acc No. Box 3443); rim bottered but not milled; stem bore 7/64". (Pcode 07759).
- 151.14 Heel type bowl dating from c1690-1710 from Woodkirk, near Batley (Acc No. WK50); finely burnished; rim bottered but not milled; stem bore 5/64". (Pcode 07763).
- 151.15 Spur type bowl dating from c1690-1720 from Warlow Pike (Acc No. Box 3464); rim bottered but not milled; stem bore 5/64". (Pcode 07762).
- 152.01 Heel type bowl dating from c1660-1680 unprovenanced but probably from Huddersfield area (Acc No. Box 3464); rim bottered but not milled; stem bore 6/64". Marked with the initials HP on the heel. Possibly Staffordshire product. (Pcode 07683).
- 152.02 Spur type bowl dating from c1660-1680 from Brushes Moor (Acc No. A.6.57); good burnish; rim bottered and fully milled; stem bore 7/64". Marked with the initials IB on the bowl facing the smoker. Possibly Lancashire product. (Pcode 07711).
- 152.03 Heel type bowl dating from c1660-1690 from Emley (Acc No. Box 3464); good burnish; rim bottered but not milled; stem bore 7/64". Marked with the initials IG on the heel. Label reads "presented by Rev Eric W Bartlam, Elmley Loveth Rectory, Droitwich MCL1942". (Pcode 07688).

- 152.04 Heel type bowl dating from c1620-1640 unprovenanced but probably from Huddersfield area (Acc No. Box 3464); rim internally trimmed and bottered and fully milled; stem bore 7/64". (Pcode 07682).
- 152.05 Heel type bowl dating from c1640-1660 unprovenanced but probably from Huddersfield area (Acc No. A.9.57); rim bottered and fully milled; stem bore 6/64". Labelled "from Brierley Collection". (Pcode 07680).
- 152.06 Spur type bowl dating from c1640-1660 unprovenanced but probably from Huddersfield area (Acc No. Box 3464); good burnish; rim bottered; milled around all of the surviving rim; stem bore 8/64". (Pcode 07681).
- 152.07 Heel type bowl dating from c1640-1660 unprovenanced but probably from Huddersfield area (Acc No. Box 3464); rim bottered and fully milled; stem bore 5/64". Shiny surface. (Pcode 07689).
- 152.08 Heel type bowl dating from c1640-1660 unprovenanced but probably from Huddersfield area (Acc No. A.7.57); rim bottered and fully milled; stem bore 5/64". Marked with the initials RL on the heel. Labelled "Warlow Pike, Greenfield". (Pcode 07679).
- 152.09 Spur type bowl dating from c1640-1660 unprovenanced but probably from Huddersfield area (Acc No. Box 3464); rim bottered and fully milled; stem bore 7/64". (Pcode 07693).
- 152.10 Heel type bowl dating from c1650-1670 unprovenanced but probably from Huddersfield area (Acc No. Box 3464); rim bottered and half milled; stem bore 6/64". Marked with the initials IW on the heel. Labelled "dug up in Storthes Hall grounds". (Pcode 07684).
- 152.11 Heel type bowl dating from c1660-1680 unprovenanced but probably from Huddersfield area (Acc No. Box 3464); rim bottered and fully milled; stem bore 7/64". no provenance. (Pcode 07687).
- 152.12 Spur type bowl dating from c1680-1700 unprovenanced but probably from Huddersfield area (Acc No. Box 3464); rim bottered but not milled; stem bore 6/64". Possible waster. (Pcode 07691).
- 152.13 Spur type bowl dating from c1680-1700 unprovenanced but probably from Huddersfield area (Acc No. Box 3464); good burnish; rim bottered but not milled; stem bore 7/64". (Pcode 07690).
- 152.14 Heel type bowl dating from c1690-1710 unprovenanced but probably from Huddersfield area (Acc No. Box 3464); good burnish; rim bottered and one quarter milled; stem bore 7/64". (Pcode 07686).
- 153.01 Heel type bowl dating from c1690-1720 unprovenanced but probably from Huddersfield area (Acc No. Box 3464); good burnish; rim possibly wiped; rim one quarter milled; stem bore 6/64". Marked with the initials IG across the stem. no provenance. (Pcode 07685).

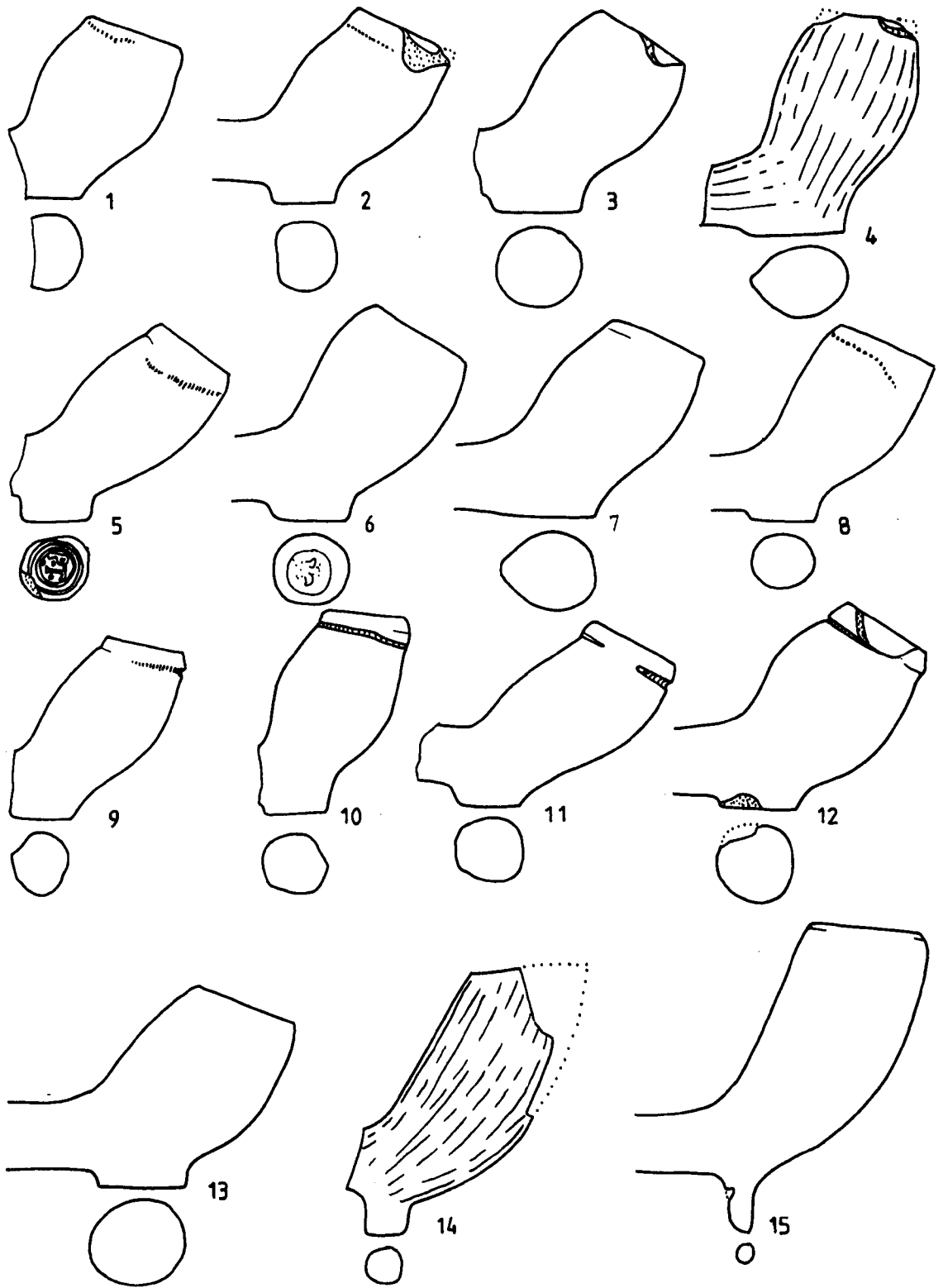
- 153.02 Heel type bowl dating from c1690-1720 unprovenanced but probably from Huddersfield area (Acc No. Box 3464); rim bottered but not milled; stem bore 7/64". (Pcode 07692).
- 153.03 Heel type bowl dating from c1630-1650 from Lower George Yard (Acc No. Box 11401); rim bottered and fully milled; stem bore 7/64". (Pcode 07721).
- 153.04 Heel type bowl dating from c1640-1660 from Lower George Yard (Acc No. Box 11401); rim bottered; milled around all of the surviving rim. Labelled HX73 B2b (1). (Pcode 07720).
- 153.05 Heel type bowl dating from c1640-1670 from Lower George Yard (Acc No. Box 11143); rim bottered and fully milled; stem bore 6/64". Well HX73A1(2). (Pcode 07713).
- 153.06 Heel type bowl dating from c1660-1680 from Lower George Yard (Acc No. Box 11401); rim bottered and fully milled; stem bore 6/64". Labelled HX73 E4d (15). (Pcode 07719).
- 153.07 Heel type bowl dating from c1660-1680 from Lower George Yard (Acc No. Box 11401); good burnish; rim bottered; milled around all of the surviving rim; stem bore 6/64". Marked with the initials ?W on the heel. Mark poorly impressed; labelled HX73a1(1). (Pcode 07722).
- 153.08 Heel type bowl dating from c1660-1680 from Lower George Yard (Acc No. Box 11401); rim bottered and half milled; stem bore 6/64". Marked with the initials ?? on the heel. Shiny surface; labelled HX73d6f(10). (Pcode 07724).
- 153.09 Heel type bowl dating from c1660-1680 from Lower George Yard (Acc No. Box 11401); good burnish; rim bottered; milled around all of the surviving rim; stem bore 7/64". Marked with the initials IW on the heel. Labelled HX73c10k(1). (Pcode 07725).
- 153.10 Heel type bowl dating from c1660-1680 from Lower George Yard (Acc No. Box 11143); good burnish; rim bottered and half milled; stem bore 6/64". Marked with the initials IG on the heel. Well HX73a2d(2). (Pcode 07714).
- 153.11 Heel type bowl dating from c1690-1720 from Lower George Yard (Acc No. Box 11143); good burnish; rim bottered and one quarter milled; stem bore 6/64". No heel; HX73 well A2a(2). (Pcode 07715).
- 153.12 Heel type bowl dating from c1690-1710 from Lower George Yard (Acc No. Box 11401); good burnish; rim bottered and three quarters milled; stem bore 5/64". Marked with the initials IW on the heel. Labelled HX73c7g(10). (Pcode 07723).
- 153.13 Spur type bowl dating from c1730-1780 from Lower George Yard (Acc No. Box 11143); good burnish; rim bottered but not milled; stem bore 5/64". No spur; well HX73 A1a(2). (Pcode 07716).



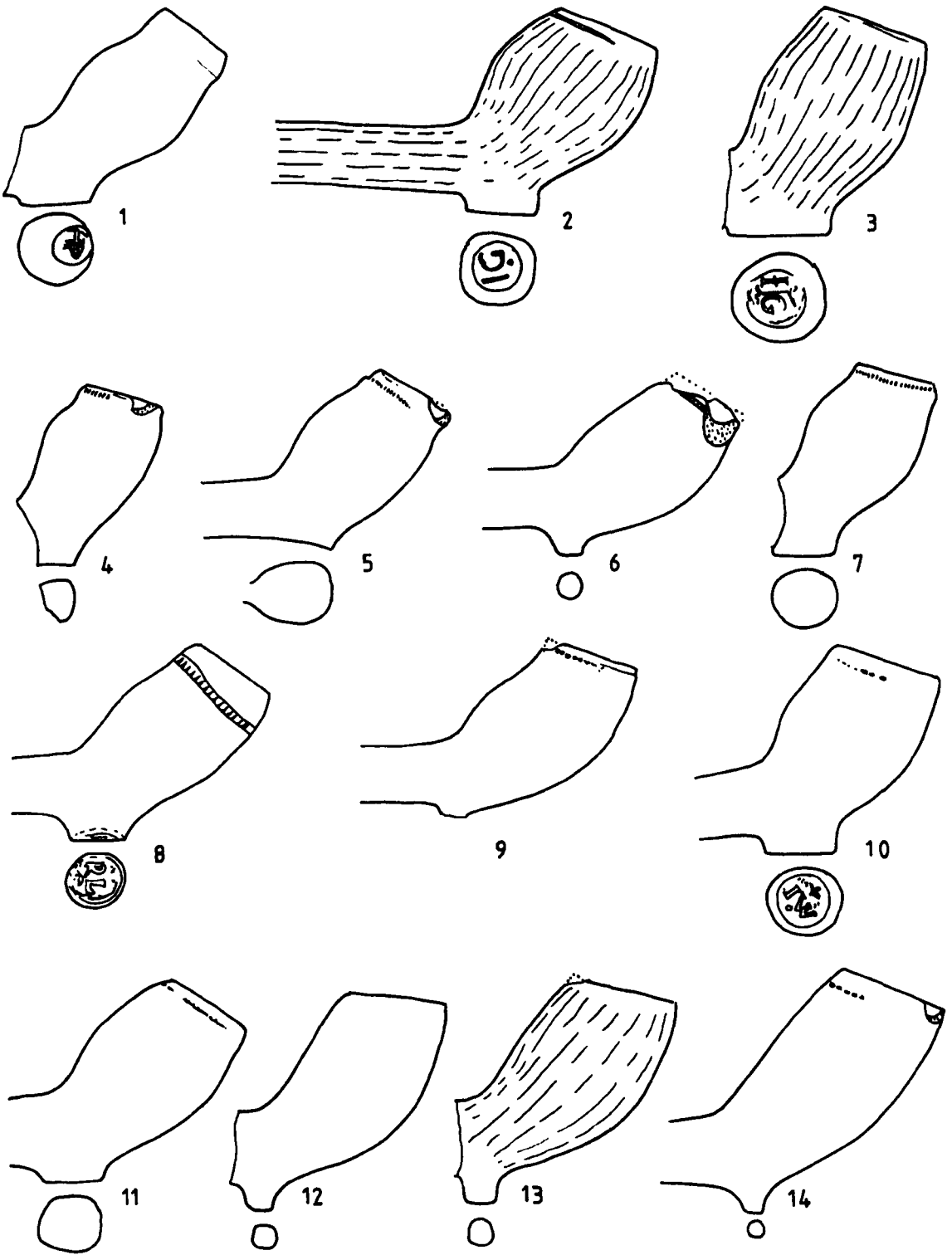
- 153.14 Heel type bowl dating from c1640-1660 unprovenanced material from Bankfield Museum, Halifax (Acc No. Box 3398); good burnish; rim bottered; milled around all of the surviving rim; stem bore  $7/64$ ". (Pcode 07732).
- 153.15 Heel type bowl dating from c1640-1660 unprovenanced material from Bankfield Museum, Halifax (Acc No. Box 3398); rim bottered and fully milled; stem bore  $6/64$ ". (Pcode 07730).
- 153.16 Heel type bowl dating from c1650-1670 unprovenanced material from Bankfield Museum, Halifax (Acc No. Box 3398); rim bottered and fully milled; stem bore  $5/64$ ". (Pcode 07731).



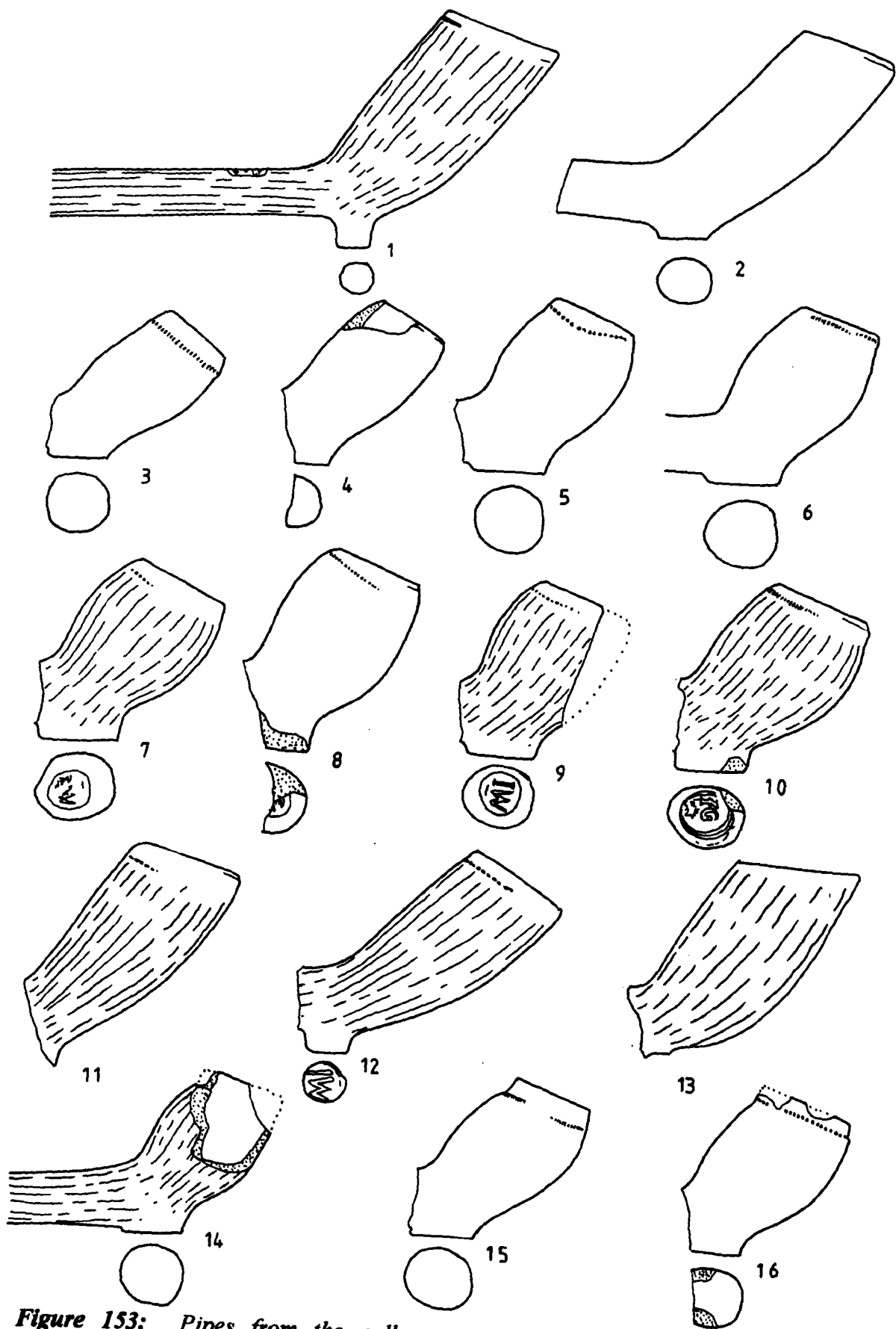
**Figure 150:** Pipes from the collection of the Tolson Memorial Museum, Huddersfield. Scale 1:1.



**Figure 151:** Pipes from the collection of the Tolson Memorial Museum, Huddersfield. Scale 1:1.



**Figure 152:** Pipes from the collection of the Tolson Memorial Museum, Huddersfield. Scale 1:1.



**Figure 153:** Pipes from the collection of the Tolson Memorial Museum, Huddersfield. Scale 1:1.

**Collection Name:** Pontefract Museum  
**Collection Code:** 0151  
**Contact Name:** Richard Van Riel  
**Address:** Pontefract, West Yorkshire

**Description:**

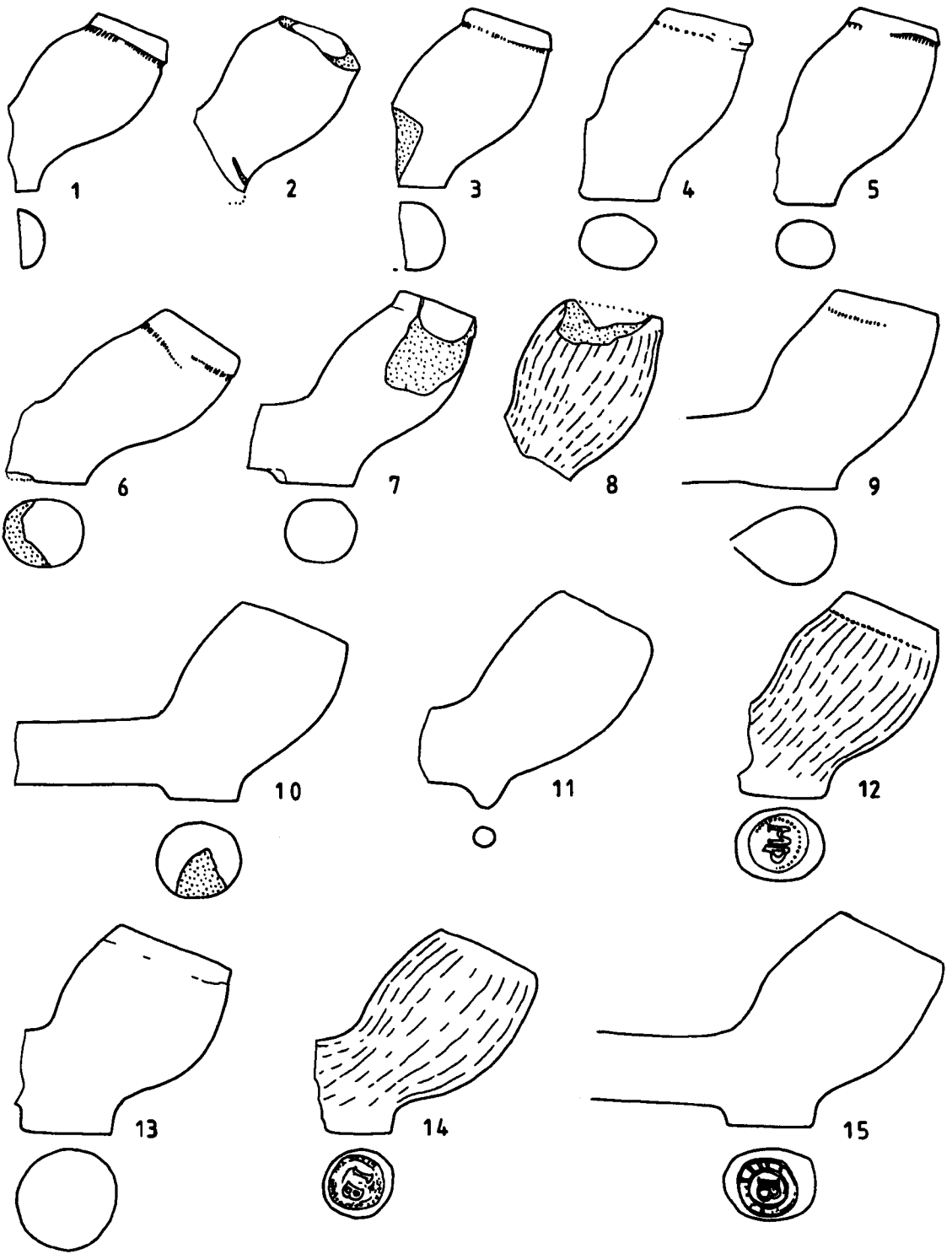
Collection recorded on 14<sup>th</sup> September 2000. A total of 101 seventeenth- and eighteenth-century pipes were recorded in detail for the Yorkshire database. Only one of the pipes had a provenance – Horsefair – all other fragments recorded came from the Pontefract area.

- 154.01 Heel type bowl dating from c1620-1640 unprovenanced material from Pontefract (Acc No. P2000); rim bottered and fully milled. (Pcode 07976).
- 154.02 Heel type bowl dating from c1630-1650 unprovenanced material from Pontefract. Milled on the front of the bowl away from the smoker. Ground rim. (Pcode 07996).
- 154.03 Heel type bowl dating from c1640-1660 unprovenanced material from Pontefract; rim bottered and fully milled; stem bore 7/64". (Pcode 07991).
- 154.04 Heel type bowl dating from c1640-1660 unprovenanced material from Pontefract; rim bottered and fully milled; stem bore 7/64". (Pcode 07989).
- 154.05 Heel type bowl dating from c1640-1660 unprovenanced material from Pontefract; rim bottered and fully milled; stem bore 7/64". (Pcode 07990).
- 154.06 Heel type bowl dating from c1640-1660 unprovenanced material from Pontefract (Acc No. P2000); rim bottered and fully milled; stem bore 5/64". (Pcode 07977).
- 154.07 Heel type bowl dating from c1640-1660 unprovenanced material from Pontefract; rim bottered; milled around all of the surviving rim; stem bore 6/64". (Pcode 07994).
- 154.08 Heel type bowl dating from c1660-1680 unprovenanced material from Pontefract (Acc No. P2000); good burnish; rim bottered but not milled. Label reads "from market gardener's shed, Valley Gardens Pontefract"; no heel. (Pcode 07974).
- 154.09 Heel type bowl dating from c1660-1680 unprovenanced material from Pontefract; rim bottered and half milled; stem bore 7/64". (Pcode 07992).
- 154.10 Heel type bowl dating from c1660-1680 unprovenanced material from Pontefract; rim bottered but not milled; stem bore 7/64". (Pcode 07993).
- 154.11 Spur type bowl dating from c1660-1680 unprovenanced material from Pontefract; stem bore 7/64". (Pcode 07997).

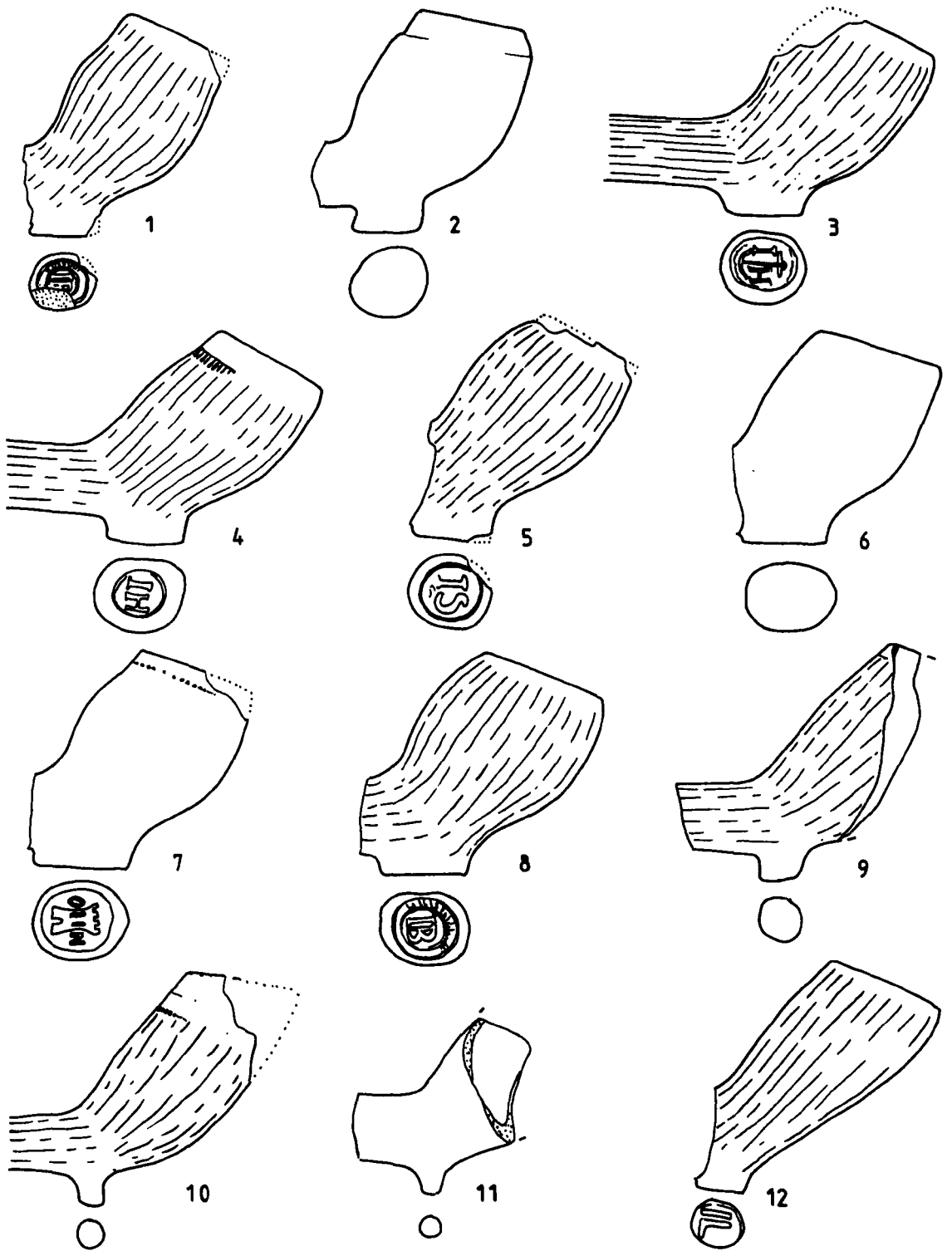
- 154.12 Heel type bowl dating from c1660-1680 unprovenanced material from Pontefract; average burnish; rim bottered and fully milled; stem bore 5/64". Marked with the initials MP on the heel. (Pcode 08008).
- 154.13 Heel type bowl dating from c1660-1690 unprovenanced material from Pontefract (Acc No. P2000); rim bottered but not milled; stem bore 5/64". Label reads "from market gardener's shed, Valley Gardens Pontefract". (Pcode 07973).
- 154.14 Heel type bowl dating from c1660-1680 unprovenanced material from Pontefract (Acc No. P2000); good burnish; rim bottered but not milled; stem bore 7/64". Marked with the initials IB on the heel. (Pcode 07978).
- 154.15 Heel type bowl dating from c1660-1680 unprovenanced material from Pontefract (Acc No. P2000); rim internally trimmed and bottered but not milled; stem bore 6/64". Marked with the initials IB on the heel. (Pcode 07979).
- 155.01 Heel type bowl dating from c1650-1690 unprovenanced material from Pontefract; good burnish; rim bottered but not milled; stem bore 7/64". Marked with the initials IB on the heel. (Pcode 08003).
- 155.02 Heel type bowl dating from c1660-1680 unprovenanced material from Pontefract; rim bottered but not milled; stem bore 6/64". (Pcode 07986).
- 155.03 Heel type bowl dating from c1660-1680 unprovenanced material from Pontefract; average burnish; rim bottered but not milled; stem bore 7/64". Marked with the initials IH flanking an anchor on the heel. (Pcode 08006).
- 155.04 Heel type bowl dating from c1660-1680 unprovenanced material from Pontefract; average burnish; rim bottered and half milled; stem bore 7/64". Marked with the initials IH on the heel. (Pcode 08005).
- 155.05 Heel type bowl dating from c1660-1680 unprovenanced material from Pontefract; good burnish; rim bottered but not milled; stem bore 7/64". Marked with the initials IS on the heel. (Pcode 08007).
- 155.06 Heel type bowl dating from c1660-1690 unprovenanced material from Pontefract (Acc No. P2000); rim bottered but not milled. (Pcode 07975).
- 155.07 Heel type bowl dating from c1660-1690 unprovenanced material from Pontefract; rim bottered; milled around all of the surviving rim; stem bore 5/64". Marked with the initials ON flanking a castle on the heel. (Pcode 08010).
- 155.08 Heel type bowl dating from c1650-1690 unprovenanced material from Pontefract; average burnish; rim bottered but not milled; stem bore 7/64". Marked with the initials IB on the heel. (Pcode 08004).

- 155.09 Heel type bowl dating from c1680-1710 unprovenanced material from Pontefract; average burnish; rim bottered but not milled; stem bore 7/64". Similar examples from Low Mill, Dewsbury. (Pcode 07995).
- 155.10 Spur type bowl dating from c1680-1710 unprovenanced material from Pontefract; average burnish; rim bottered; milled around all of the surviving rim; stem bore 6/64". (Pcode 07988).
- 155.11 Spur type bowl dating from c1680-1710 unprovenanced material from Pontefract; stem bore 7/64". No rim surviving. (Pcode 07998).
- 155.12 Heel type bowl dating from c1680-1710 unprovenanced material from Pontefract; average burnish; rim bottered but not milled; stem bore 7/64". Marked with the initials IL on the heel. (Pcode 08009).
- 156.01 Heel type bowl dating from c1700-1730 unprovenanced material from Pontefract; rim internally trimmed and wiped but not milled; stem bore 5/64". (Pcode 07987).
- 156.02 Heel type bowl dating from c1700-1750 unprovenanced material from Pontefract; rim cut but not milled; stem bore 6/64". Marked with the initials SH on the SH. Possibly waster. (Pcode 07999).
- 156.03 Heel type bowl dating from c1700-1750 unprovenanced material from Pontefract; rim cut but not milled; stem bore 5/64". Marked with the initials SHILLARY around the stem. (Pcode 08002).
- 156.04 Heel type bowl dating from c1700-1750 unprovenanced material from Pontefract; stem bore 5/64". No rim surviving. Stem marked with S HILLARY and a heart and fleur-de-lys, S reversed (RS/I/S). (Pcode 08000).
- 156.05 Heel type bowl dating from c1700-1750 from Horsefair; rim cut but not milled; stem bore 5/64". Marked with the lettering S HILLARY around the stem. (Pcode 08001).

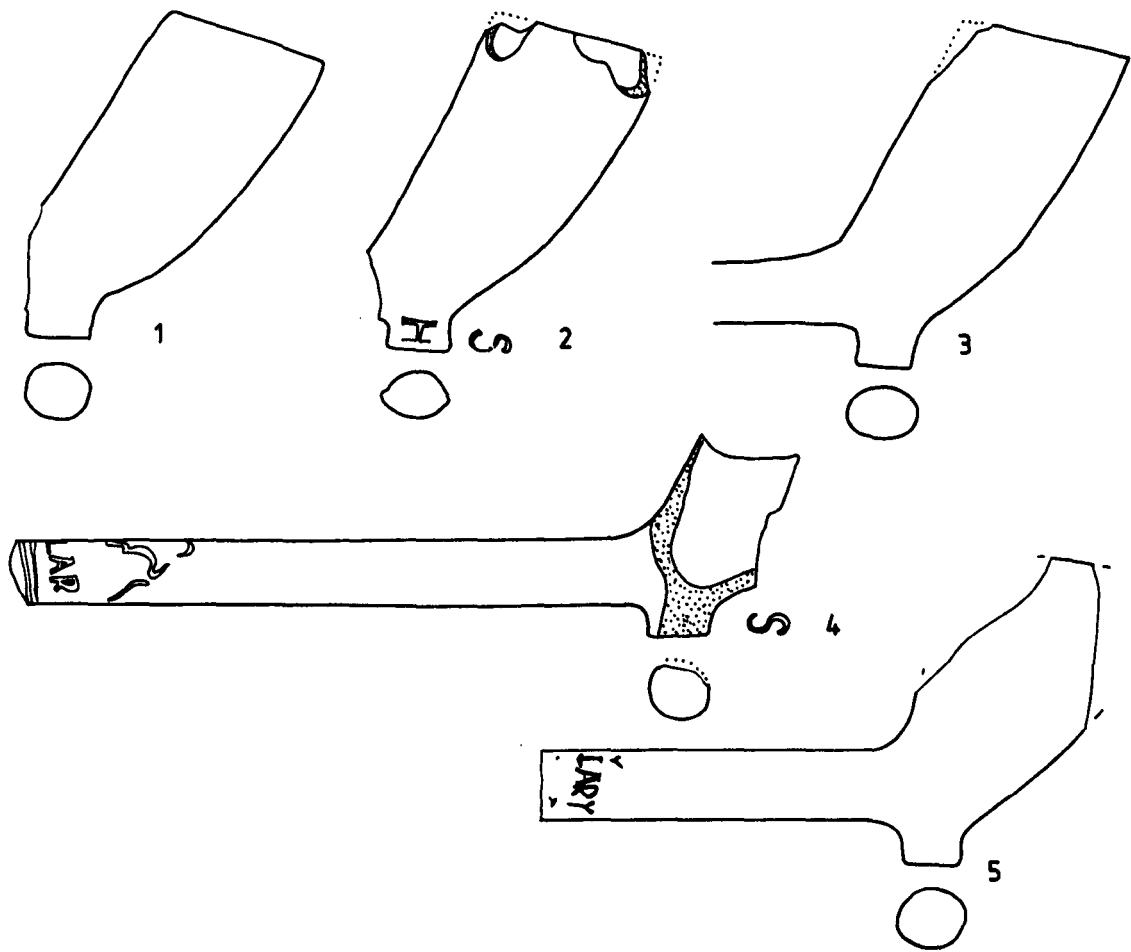




**Figure 154:** Pipes from the collections of Pontefract Museum. Scale 1:1.



**Figure 155: Pipes from the collections of Pontefract Museum. Scale 1:1.**



**Figure 156:** Pipes from the collections of Pontefract Museum. Scale 1:1.

**Collection Name:** Denham Collection  
**Collection Code:** 0236  
**Contact Name:** Mrs Denham  
**Address:** Wakefield, West Yorkshire

**Description:**

Private collection sent in to Wakefield Museum and Art Gallery for identification. only one bowl dating from c1660-1680 was recorded in detail for inclusion in the Yorkshire Database. There were a further 7 bowl fragments and 10 plain stems. With the exception of the 1660-1680 bowl fragment all the other pipes would fit within a date range of c1800-1840. The most notable of the later bowls are as follows:

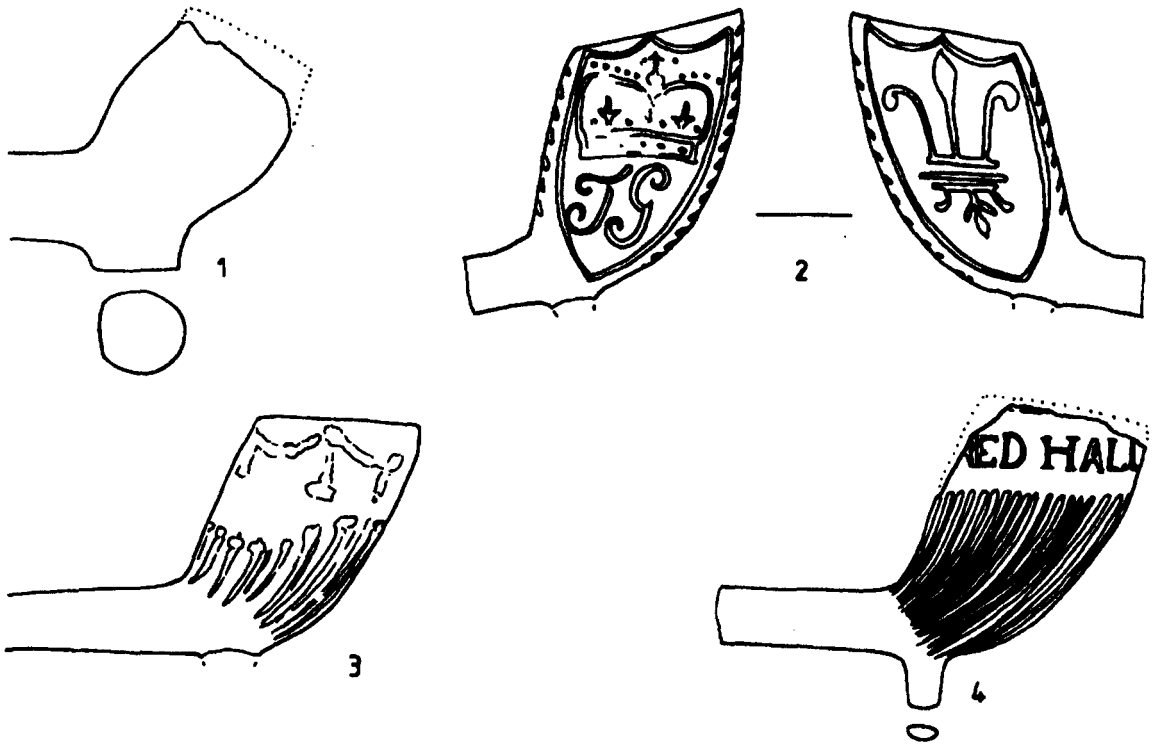
- 3 bowls of c1800-1840 with bold fleur-de-lys in shield on the left-hand side, crowned initials JG in a shield on the right-hand side. Two bowls not smoker and one with cracks and holes suggesting it may be a kiln waster.
- Bowl with fine, even flutes and large, rather crude letters above on the right-hand side reading RED HALL. Left-hand side of the bowl is missing.
- Similar bowl to above but clearly from a different mould.

157.01 Heel type bowl dating from c1660-1680, from Kirkhamgate; rim damaged; stem bore 6/64”.

157.02 Bowl dating from c1800-1840, from Kirkhamgate, no internal bowl cross; rim cut; fleur-de-lys within a shield on the smokers left and the crowned initials JG on the smokers right; simple leaf decorated seams; stem bore 4/64”. One of three examples of this design.

157.03 Bowl dating from c1820-1880, from Kirkhamgate; rim cut; stem bore 4/64”. Very crudely moulded flutes and swags design.

157.04 Spur bowl dating from c1820-1850, from Kirkhamgate; rim missing; stem bore 4/64”. Traces of a relief line at the rim; 20 flutes moulded on the right-hand side and 21 moulded on to the left-hand side; moulded lettering RED HALL around the rim.



**Figure 157:** Pipes from the Denham Collection, Wakefield. Scale 1:1.

**Collection Name:** Wakefield Museum & Art Gallery

**Collection Code:** 0148

**Contact Name:** Pam Judkins

**Address:** Wakefield, West Yorkshire

**Description:**

Collection recorded during a number of visits between October 2000 and July 2001. In addition, the clay tobacco pipes from the excavations at Sandal Castle were borrowed for detailed recording in Liverpool.

The collection comprises a substantial collection of curated and excavated pipes ranging in date from the seventeenth right through to the nineteenth and early twentieth centuries. In total 452 pipes dating from the seventeenth and eighteenth century were recorded in detail for inclusion in the Yorkshire Database. Of this 452, 312 were from the excavations at Sandal Castle.

Amongst the later material the following were the most noteworthy:

**Social History Collection**

- Two complete Dutch pipes with moulded initials ES and a crown on the sides of the heel. The stems of both pipes are approximately 13 inches long. One has a green glaze over the bowl and most of the stem ending approximately 5 inches from the tip. The other has a clear glaze over 'delft-blue' decoration ending approximately 3½ inches from the end.
- 70/41/2 – Midlands type arms displayed between a lion and unicorn with the lettering NO. 77 C.WARD/DONCASTER incuse moulded in sans serif on the sides of the stem.
- Flutes and swags bowl with the lettering JG moulded either side of the seam facing the smoker. An almost identical pipe, but without the initials, from Red Hall.
- 3 stems with J.W.R. WILSON LEEDS incuse moulded in sans serif on both sides of the stem, no border.
- 2 stems with J.A.R. WILSON LEEDS incuse moulded in sans serif lettering on the side of the stem, no border.
- 1 stem with J.THORNES 66 WEST/ / .ORD CIGAR & TOBACCO STORES incuse moulded in sans serif, no border.
- 2 stems with J.GILL – MAKER/WAKEFIELD in sans serif lettering.
- 1 stem with J.THORNES 66 & 68WE./ /.& CIGAR MANUFACTURER incuse moulded in sans serif, no border.
- 1 stem with J.THORNES/65 & 67 LEEDS RD BRADFORD incuse moulded in sans serif within a dotted border.
- Flutes and swags bowl with the lettering WR on either side of the seam facing the smoker.
- Flutes and swags bowl with the lettering IS below the swags on both sides of the bowl; possibly J Shaw, Bradford.
- Flutes and swags bowl with the lettering ID below the swags on both sides of the bowl; possibly Joseph Dodson, Birstall.
- Bowl with a flower design on each side and the lettering WS either side of the seam facing the smoker.

- Bowl with a stylised floral motif on both sides of the bowl and leaf decorated seams.

#### Museum Collection

- Bowl with Masonic motifs on both sides of the bowl and the lettering C. WINDLE IN LEEDS moulded on either side of the mould seam away from the smoker.
- 1999.15 – finds from various WARG excavations during the 1960s comprising approximately 14 bowls and 20-25 stems. The bowls include two bowls from the same mould dating c1800-1840 with a very faint armorial – lion and unicorn supporters; a fluted bowl; a bowl with a large shield.
- Museum Enquiry 592 – Flutes and swags bowl with the initials ID below the swags on both sides of the bowl.
- Flutes and swags bowl with the initials CA below the swags on both sides of the bowl – Charles Allan of Pontefract.
- Complete footballer cutty.
- Fluted bowl with the lettering HUL./ ...NBY on the sides.
- Flute and swags bowl fragment with the lettering JG either side of the mould seam facing the smoker.
- Part of a meerschaum wash cutty with very neat incuse letters, serif, in a relief moulded beaded border GARIBA.../...LLIARD.
- Bowl with as very well modelled greyhound on the stem behind the bowl. Fiolet stamp.
- 19<sup>th</sup> century bowl with panels above five flutes; leaf decorated seams.
- CAS77-8 (018) – ship and sailor bowl (similar examples recovered from Pontefract castle).
- CAS77-8 (018) – Flutes and swags bow with the initials JA below the swags on both sides of the bowl – John Allan of Pontefract.
- CAS82 S13 301 – Fluted bowl with the lettering W.BO.ER/SELBY in large letters around the rim.

158.01 Heel type bowl dating from c1650-1670 from the Bowling Alley Site, Wakefield; rim bottered but not milled; stem bore 8/64". Abraded surface. (Pcode 21174).

158.02 Stem fragment dating from c1690-1740 from John Bunny's House (Acc No. JB68); average burnish; stem bore 5/64". Marked with the initials IG across the stem. (Pcode 21176).

158.03 Heel type bowl dating from c1660-1680 from Haselden Hall (Acc No. HH67); good burnish; stem bore 7/64". Marked with the initials IW on the heel. Heel fragment only. (Pcode 21175).

158.04 Heel type bowl dating from c1690-1730 from John Bunny's House (Acc No. JB68); poorly burnished; rim bottered but not milled; stem bore 5/64". (Pcode 21177).

- 158.05 Heel type bowl dating from c1640-1670 from Kiln 1 (Acc No. 82.1.22); rim bottered but not milled; stem bore 6/64". (Pcode 21178).
- 158.06 Heel type bowl dating from c1650-1670 from Kiln 1 (Acc No. 82.1.22); rim internally trimmed, bottered and one quarter milled; stem bore 7/64". (Pcode 21179).
- 158.07 Heel type bowl dating from c1650-1670 from Kiln 1 (Acc No. 82.1.22); rim internally trimmed and bottered but not milled; stem bore 7/64". (Pcode 21180).
- 158.08 Heel type bowl dating from c1650-1670 material from the Social History Collection; good burnish; rim bottered and fully milled; stem bore 6/64". Marked with the crowned initials IW on the heel. (Pcode 08331).
- 158.09 Heel type bowl dating from c1630-1640 from Potovens; rim bottered and fully milled; stem bore 7/64". (Pcode 24667).
- 158.10 Heel type bowl dating from c1640-1660 from Potovens; rim bottered and fully milled; stem bore 5/64". Very roughly trimmed heel. (Pcode 24693).
- 158.11 Heel type bowl dating from c1650-1670 from Potovens (Acc No. 82.1.22); rim bottered and milled around all of the surviving rim; stem bore 7/64". Possibly from Kiln 1. (Pcode 07671).
- 158.12 Heel type bowl dating from c1650-1670 from Potovens (Acc No. BDSMN KIV); rim bottered and partially milled; stem bore 6/64". (Pcode 24704).
- 158.13 Heel type bowl dating from c1660-1680 from Potovens; rim bottered and three-quarters milled; stem bore 5/64". Marked with the initials MP on the heel. (Pcode 08313).
- 158.14 Heel type bowl dating from c1660-1680 from Potovens; rim bottered but not milled; stem bore 5/64". Marked with the initials MP on the heel. (Pcode 08312).
- 158.15 Heel type bowl dating from c1650-1670 from Potovens; good burnish; rim bottered and fully milled; stem bore 6/64". Marked with the initials MP on the heel. (Pcode 08310).
- 159.01 Heel type bowl dating from c1660-1680 from Potovens; rim bottered and fully milled; stem bore 5/64". (Pcode 24682).
- 159.02 Heel type bowl dating from c1660-1680 from Potovens; rim bottered; stem bore 7/64". Quite roughly finished. (Pcode 24707).
- 159.03 Heel type bowl dating from c1660-1690 from Potovens; stem bore 7/64". (Pcode 24706).



- 159.04 Heel type bowl dating from c1660-1680 from Potovens; average burnish; rim bottered; stem bore 7/64". (Pcode 24705).
- 159.05 Heel type bowl dating from c1680-1680 from Potovens (Acc No. 1982.1); rim bottered but not milled; stem bore 6/64". From Kiln 10. (Pcode 07670).
- 159.06 Heel type bowl dating from c1680-1710 from Potovens; good burnish; rim bottered and half milled; stem bore 6/64". Marked with the initials WS on the heel. (Pcode 08311).
- 159.07 Heel type bowl dating from c1610-1640 from Rodger Lane (Acc No. RL1); rim bottered and fully milled; stem bore 8/64". Heart shaped heel; Published by Bartlett 1971. (Pcode 21164).
- 159.08 Heel type bowl dating from c1640-1660 from Rodger Lane (Acc No. RL3); rim bottered and fully milled; stem bore 7/64". Published by Bartlett 1971. (Pcode 21162).
- 159.09 Heel type bowl dating from c1610-1640 from Rodger Lane (Acc No. RL7); stem bore 7/64". Marked with the initials IR on the heel. Heel fragment only; Published by Bartlett 1971. (Pcode 21168).
- 159.10 Spur type bowl dating from c1640-1660 from Rodger Lane (Acc No. RL4); rim bottered and one quarter milled; stem bore 6/64". Published by Bartlett 1971. (Pcode 21163).
- 159.11 Heel type bowl dating from c1660-1680 from Rodger Lane (Acc No. RL2); rim bottered but not milled; stem bore 5/64". Published by Bartlett 1971. (Pcode 21165).
- 159.12 Heel type bowl dating from c1660-1680 from Rodger Lane (Acc No. RL5); average burnish; rim bottered but not milled; stem bore 6/64". Marked with the initials EC on the heel. Published by Bartlett 1971. (Pcode 21166).
- 159.13 Heel type bowl dating from c1660-1680 from Rodger Lane (Acc No. RL6); stem bore 6/64". Marked with the initials IW on the heel. No rim surviving; Published by Bartlett 1971. (Pcode 21167).
- 160.01 Heel type bowl dating from c1610-1640 unprovenanced but probably from Wakefield (Acc No. SH2013); rim bottered but not milled; stem bore 6/64". (Pcode 08264).
- 160.02 Heel type bowl dating from c1620-1640 unprovenanced but probably from Wakefield (Acc No. SH2010); rim bottered and milled around all of the surviving rim; stem bore 7/64". (Pcode 08267).
- 160.03 Heel type bowl dating from c1620-1640 unprovenanced but probably from Wakefield (Acc No. SH2016); stem bore 7/64". Milled heel. No rim surviving; piece of stem wedged in bowl. (Pcode 08268).

- 160.04 Heel type bowl dating from c1620-1640 unprovenanced but probably from Wakefield (Acc No. SH2053); rim bottered and fully milled; stem bore 7/64". Heart shaped heel. (Pcode 08270).
- 160.05 Heel type bowl dating from c1620-1640 unprovenanced but probably from Wakefield (Acc No. SH2057); good burnish; rim bottered and fully milled; stem bore 7/64". (Pcode 08290).
- 160.06 Heel type bowl dating from c1620-1640 unprovenanced but probably from Wakefield (Acc No. SH2057); rim bottered and fully milled; stem bore 8/64". Heart shaped heel. (Pcode 08295).
- 160.07 Spur type bowl dating from c1620-1640 unprovenanced but probably from Wakefield; rim internally trimmed, bottered and three-quarters milled; stem bore 7/64". Labelled "172 1926 J Butterworth". (Pcode 08307).
- 160.08 Heel type bowl dating from c1630-1650 unprovenanced but probably from Wakefield; rim bottered and fully milled; stem bore 6/64". (Pcode 08323).
- 160.09 Heel type bowl dating from c1640-1660 unprovenanced but probably from Wakefield (Acc No. SH2011); rim bottered and fully milled; stem bore 7/64". (Pcode 08265).
- 160.10 Heel type bowl dating from c1640-1660 unprovenanced but probably from Wakefield (Acc No. SH2053); average burnish; rim bottered and milled around all of the surviving rim; stem bore 7/64". (Pcode 08274).
- 160.11 Heel type bowl dating from c1640-1660 unprovenanced but probably from Wakefield (Acc No. SH2057); rim internally trimmed, bottered and fully milled; stem bore 7/64". (Pcode 08298).
- 160.12 Heel type bowl dating from c1650-1670 unprovenanced but probably from Wakefield (Acc No. SH2053); rim bottered but not milled; stem bore 7/64". (Pcode 08277).
- 160.13 Heel type bowl dating from c1650-1670 unprovenanced but probably from Wakefield (Acc No. SH2057); good burnish; rim bottered and fully milled; stem bore 7/64". Very neat. (Pcode 08287).
- 160.14 Heel type bowl dating from c1650-1670 unprovenanced but probably from Wakefield (Acc No. SH2057); good burnish; rim bottered but not milled; stem bore 7/64". Marked with the initials IG on the heel. (Pcode 08302).
- 160.15 Heel type bowl dating from c1650-1670 unprovenanced but probably from Wakefield; good burnish; rim bottered and fully milled; stem bore 6/64". (Pcode 08321).
- 161.01 Heel type bowl dating from c1650-1670 unprovenanced but probably from Wakefield; rim internally trimmed and bottered but not milled; stem bore 7/64". Very crudely made. (Pcode 08322).

- 161.02 Heel type bowl dating from c1650-1670 unprovenanced but probably from Wakefield; rim bottered and fully milled; stem bore 6/64". Appears to be burnished. (Pcode 08327).
- 161.04 Heel type bowl dating from c1660-1680 unprovenanced but probably from Wakefield (Acc No. SH2062); rim bottered but not milled; stem bore 7/64". (Pcode 08263).
- 161.05 Heel type bowl dating from c1660-1680 unprovenanced but probably from Wakefield (Acc No. SH2053); stem bore 7/64". No rim surviving. (Pcode 08278).
- 161.05 Heel type bowl dating from c1650-1670 unprovenanced but probably from Wakefield; rim internally trimmed and bottered but not milled; stem bore 6/64". (Pcode 08329).
- 161.06 Heel type bowl dating from c1660-1680 unprovenanced but probably from Wakefield (Acc No. SH2053); rim bottered but not milled; stem bore 6/64". ?illegible mark. (Pcode 08285).
- 161.07 Spur type bowl dating from c1650-1670 unprovenanced but probably from Wakefield; rim bottered and milled around all of the surviving rim; stem bore 8/64". Labelled "May 1909". (Pcode 08330).
- 161.08 Heel type bowl dating from c1660-1680 unprovenanced but probably from Wakefield (Acc No. SH2057); average burnish; rim bottered and milled around all of the surviving rim; stem bore 7/64". Marked with the initials IS on the heel. (Pcode 08304).
- 161.09 Spur type bowl dating from c1660-1680 unprovenanced but probably from Wakefield (Acc No. SH2057); rim internally trimmed, bottered and milled around all of the surviving rim; stem bore 7/64". (Pcode 08299).
- 161.10 Heel type bowl dating from c1660-1680 unprovenanced but probably from Wakefield (Acc No. SH2057); good burnish; rim bottered and milled around all of the surviving rim; stem bore 7/64". Marked with the initials MP on the heel. Labelled "No. 172 1926 J Butterworth". (Pcode 08301).
- 161.11 Heel type bowl dating from c1660-1680 unprovenanced but probably from Wakefield (Acc No. SH2053); rim bottered but not milled; stem bore 5/64". Very bulbous. (Pcode 08284).
- 161.12 Heel type bowl dating from c1660-1680 unprovenanced but probably from Wakefield (Acc No. 1999.15); rim bottered and three-quarters milled; stem bore 5/64". (Pcode 21170).
- 161.13 Heel type bowl dating from c1660-1680 unprovenanced but probably from Wakefield; rim bottered and fully milled; stem bore 8/64". (Pcode 08315).

- 162.01 Heel type bowl dating from c1660-1690 unprovenanced but probably from Wakefield (Acc No. 1999.15); rim internally trimmed and bottered but not milled; stem bore 7/64". (Pcode 21172).
- 162.02 Heel type bowl dating from c1690-1720 unprovenanced but probably from Wakefield (Acc No. 1999.15); average burnish; rim internally trimmed and bottered but not milled; stem bore 5/64". (Pcode 21169).
- 162.03 Spur type bowl dating from c1700-1750 unprovenanced but probably from Wakefield (Acc No. 1962.49); good burnish; rim bottered but not milled; stem bore 5/64". (Pcode 08305).
- 162.04 Spur type bowl dating from c1720-1780 unprovenanced but probably from Wakefield (Acc No. 1962.49); good burnish; rim internally trimmed and bottered but not milled; stem bore 4/64". (Pcode 08306).
- 162.05 Heel type bowl dating from c1650-1670 from; good burnish; rim bottered and three-quarters milled; stem bore 6/64". Marked with the initials IW on the heel. (Pcode 08309).
- 162.06 Spurless bowl dating from c1850-1910 unprovenanced but probably from Wakefield (Acc No. SH2064); rim cut and not milled. Marked with the lettering T. KAY MAKER LEEDS on the bowl facing the smoker. (Pcode 21351).
- 162.07 Spur type bowl dating from c1780-1800 from Possibly Castleford. Marked with the lettering C.WINDLE IN LEEDS on the bowl away from the smoker.
- 162.08 Spur type bowl dating from c1760-1800 unprovenanced but probably from Wakefield (Acc No. SH2060); rim wiped and not milled; stem bore 5/64".
- 162.09 Spur type bowl dating from c1780-1820 Castleford (Acc No. CAS82 S13 301); rim cut. Marked with the lettering W. BU.ER SELBY around the rim.
- 162.10 Spur type bowl dating from c1810-1850 from Calder Grove; rim cut. Marked with the initials JG on the bowl facing the smoker.
- 163.01 Heel type bowl dating from c1640-1660 from Sandal Castle (Acc No. 1983.10.126); rim bottered and fully milled; stem bore 7/64". Milled at bowl/stem junction behind the heel; bowl height: 29.7cm; bowl width: 19.7cm; Mould Group 1 (Same as Pontefract Mould Group 1). (Pcode 23476).
- 163.02 Heel type bowl dating from c1640-1660 from Sandal Castle (Acc No. 1983.10.115); rim bottered and fully milled; stem bore 7/64". Bowl height: 30.3cm; bowl width: 18.5cm; Mould Group 2. (Pcode 23473).

- 163.03 Heel type bowl dating from c1640-1660 from Sandal Castle (Acc No. 1983.10.92); rim bottered and fully milled; stem bore 7/64". Bowl height: 28.9cm; bowl width: 18.2cm; Mould Group 3. (Pcode 07657).
- 163.04 Heel type bowl dating from c1640-1660 from Sandal Castle (Acc No. 1983.10.49); rim bottered and milled around all of the surviving rim; stem bore 7/64". Bowl height: 27.7cm; bowl width: 17.7cm; Mould Group 4. (Pcode 23365).
- 163.05 Heel type bowl dating from c1640-1660 from Sandal Castle (Acc No. 1983.10.18); rim bottered and milled around all of the surviving rim; stem bore 7/64". Does not appear to have been smoked; bowl height: 29.1cm; bowl width: 18.2cm; Mould Group 5. (Pcode 23294).
- 163.06 Heel type bowl dating from c1640-1660 from Sandal Castle (Acc No. 1983.10.98); rim bottered and fully milled. Milled heel. Bowl height: 30.8cm; bowl width: 18.5cm; Mould Group 6. (Pcode 07666).
- 163.07 Heel type bowl dating from c1640-1660 from Sandal Castle (Acc No. 1983.10.92); rim bottered and fully milled; stem bore 6/64". Milled heel. Very distinctive mould flaws on the right hand side of stem; bowl height: 30.2cm; bowl width: 17.5cm; Mould Group 7. (Pcode 23429).
- 163.08 Heel type bowl dating from c1640-1660 from Sandal Castle (Acc No. 1983.10.14); rim internally trimmed, bottered and fully milled; stem bore 7/64". Bowl height: 29.9cm; bowl width: 19.2cm; Mould Group 8. (Pcode 23278).
- 163.09 Heel type bowl dating from c1640-1660 from Sandal Castle (Acc No. 1983.10.32); rim bottered and fully milled; stem bore 7/64". (Pcode 23337).
- 163.10 Heel type bowl dating from c1640-1660 from Sandal Castle (Acc No. 1983.10.48); rim bottered and fully milled; stem bore 7/64". Bowl height: 26.7cm; bowl width: 17.4cm; Mould Group 10. (Pcode 23362).
- 163.11 Heel type bowl dating from c1640-1660 from Sandal Castle (Acc No. 1983.10.33); rim bottered and fully milled; stem bore 7/64". Heart shaped heel; bowl height: 29.9cm; bowl width: 18.7cm; Mould Group 11. (Pcode 23339).
- 163.12 Heel type bowl dating from c1640-1660 from Sandal Castle (Acc No. 1983.10.12); rim bottered and fully milled; stem bore 6/64". Very small heel; bowl height: 29.4cm; bowl width: 19.1cm; Mould Group 12. (Pcode 23272).
- 163.13 Heel type bowl dating from c1630-1660 from Sandal Castle (Acc No. 1983.10.94); good burnish; rim bottered and fully milled; stem bore 7/64". Marked with the initials .RW on the heel. Mould Group 13; Dutch. (Pcode 07664).

- 164.01 Heel type bowl dating from c1630-1660 from Sandal Castle (Acc No. 1983.10.9); good burnish; rim bottered and fully milled. Marked with the initials .RW on the heel. Dutch; Mould Group 13. (Pcode 07656).
- 164.02 Heel type bowl dating from c1630-1660 from Sandal Castle (Acc No. 1983.10.3); good burnish; rim bottered and fully milled; stem bore 7/64". Marked with the initials BC on the heel. (Pcode 07649).
- 164.03 Heel type bowl dating from c1620-1640 from Sandal Castle (Acc No. 1983.10.7); good burnish; rim bottered and fully milled; stem bore 7/64". Marked with the initials GW on the heel. Gabriel Westoby of York. (Pcode 07654).
- 164.04 Heel type bowl dating from c1630-1650 from Sandal Castle (Acc No. 1983.10.11); rim internally trimmed, bottered and fully milled; stem bore 6/64". Bowl height:25.7cm; bowl width:17.1cm. (Pcode 23265).
- 164.05 Heel type bowl dating from c1640-1660 from Sandal Castle (Acc No. 1983.10.98); good burnish; rim internally trimmed, bottered and fully milled; stem bore 8/64". Bowl height: 24.1cm; bowl width: 17.6cm. (Pcode 07667).
- 164.06 Heel type bowl dating from c1640-1660 from Sandal Castle (Acc No. 1983.10.123); rim bottered and fully milled; stem bore 7/64". Bowl height: 28.1cm; bowl width: 18.2cm. (Pcode 07631).
- 164.06 Heel type bowl dating from c1640-1660 from Sandal Castle (Acc No. 1983.10.21); average burnish; rim bottered and fully milled. Part of a heel mark visible. Traces of first initial only, possibly F or E. (Pcode 07652).
- 164.07 Heel type bowl dating from c1640-1660 from Sandal Castle (Acc No. 1983.10.27); rim internally trimmed, bottered and fully milled; stem bore 7/64". Bowl height: 27.6cm; bowl width: 17.7cm. (Pcode 07635).
- 164.08 Heel type bowl dating from c1640-1660 from Sandal Castle (Acc No. 1983.10.27); rim internally trimmed, bottered and fully milled; stem bore 7/64". Bowl height: 24.8cm; bowl width: 17.8. (Pcode 07636).
- 164.09 Heel type bowl dating from c1640-1660 from Sandal Castle (Acc No. 1983.10.98); rim bottered and fully milled; stem bore 7/64". Bowl height: 28.8cm; bowl width: 17.1; Same mould as Pontefract Mould Group 11. (Pcode 07665).
- 164.10 Heel type bowl dating from c1640-1660 from Sandal Castle (Acc No. 1983.10.92); rim bottered and fully milled. Bowl height: 29.1cm; bowl width: 18.7cm. (Pcode 07658).
- 164.11 Heel type bowl dating from c1640-1660 from Sandal Castle (Acc No. 1983.10.12); rim bottered and milled around all of the surviving rim; stem bore 7/64". Milled at bowl/stem junction behind the heel; bowl height:

28.1cm; bowl width: 19.3cm; Mould Group 1 (Same as Pontefract Mould Group 1). (Pcode 23271).

- 164.12 Heel type bowl dating from c1640-1660 from Sandal Castle (Acc No. 1983.10.12); rim bottered and fully milled; stem bore 7/64". Milled heel. Bowl height:27.7cm; bowl width:18.2cm. (Pcode 23270).
- 164.13 Heel type bowl dating from c1640-1660 from Sandal Castle (Acc No. 1983.10.39); rim internally trimmed, bottered and fully milled; stem bore 7/64". Bowl height: 25.8cm; bowl width: 17.3cm. (Pcode 23341).
- 164.14 Heel type bowl dating from c1640-1660 from Sandal Castle (Acc No. 1983.10.33); rim bottered and fully milled; stem bore 7/64". (Pcode 23338).
- 164.15 Heel type bowl dating from c1640-1660 from Sandal Castle (Acc No. 1983.10.20); rim bottered and fully milled; stem bore 7/64". Bowl height: 29.3cm; bowl width: 18.5; shiny surface but no obvious burnishing lines visible. (Pcode 23298).
- 164.17 Heel type bowl dating from c1640-1660 from Sandal Castle (Acc No. 1983.10.16); rim bottered and fully milled. Bowl height: 28.5cm; bowl width: 18.5cm. (Pcode 23290).
- 164.18 Heel type bowl dating from c1640-1660 from Sandal Castle (Acc No. 1983.10.30); stem bore 6/64". Heel fragment only; stem ground for reuse. (Pcode 23330).
- 164.19 Heel type bowl dating from c1640-1660 from Sandal Castle (Acc No. 1983.10.24); rim internally trimmed, bottered and fully milled; stem bore 7/64". Stem ground for reuse; bowl height: 27.1cm; bowl width: 17.9cm. (Pcode 23305).
- 165.01 Heel type bowl dating from c1640-1660 from Sandal Castle (Acc No. 1983.10.13); rim bottered and milled around all of the surviving rim; stem bore 7/64". Bowl height: 30.5cm; bowl width: 18.2cm. (Pcode 23276).
- 165.02 Heel type bowl dating from c1640-1660 from Sandal Castle (Acc No. 1983.10.24); rim bottered and fully milled; stem bore 6/64". Does not appear to have been smoked; bowl height: 27.1cm; bowl width: 18.4cm. (Pcode 23306).
- 165.03 Heel type bowl dating from c1640-1660 from Sandal Castle (Acc No. 1983.10.15); rim bottered and fully milled; stem bore 7/64". Quite forward leaning; bowl height: 28.2cm; bowl width: 18.1cm. (Pcode 23282).
- 165.04 Heel type bowl dating from c1640-1660 from Sandal Castle (Acc No. 1983.10.26); rim internally trimmed, bottered and fully milled; stem bore 7/64". Bowl height: 28.7cm; bowl width:18.7cm. (Pcode 23313).

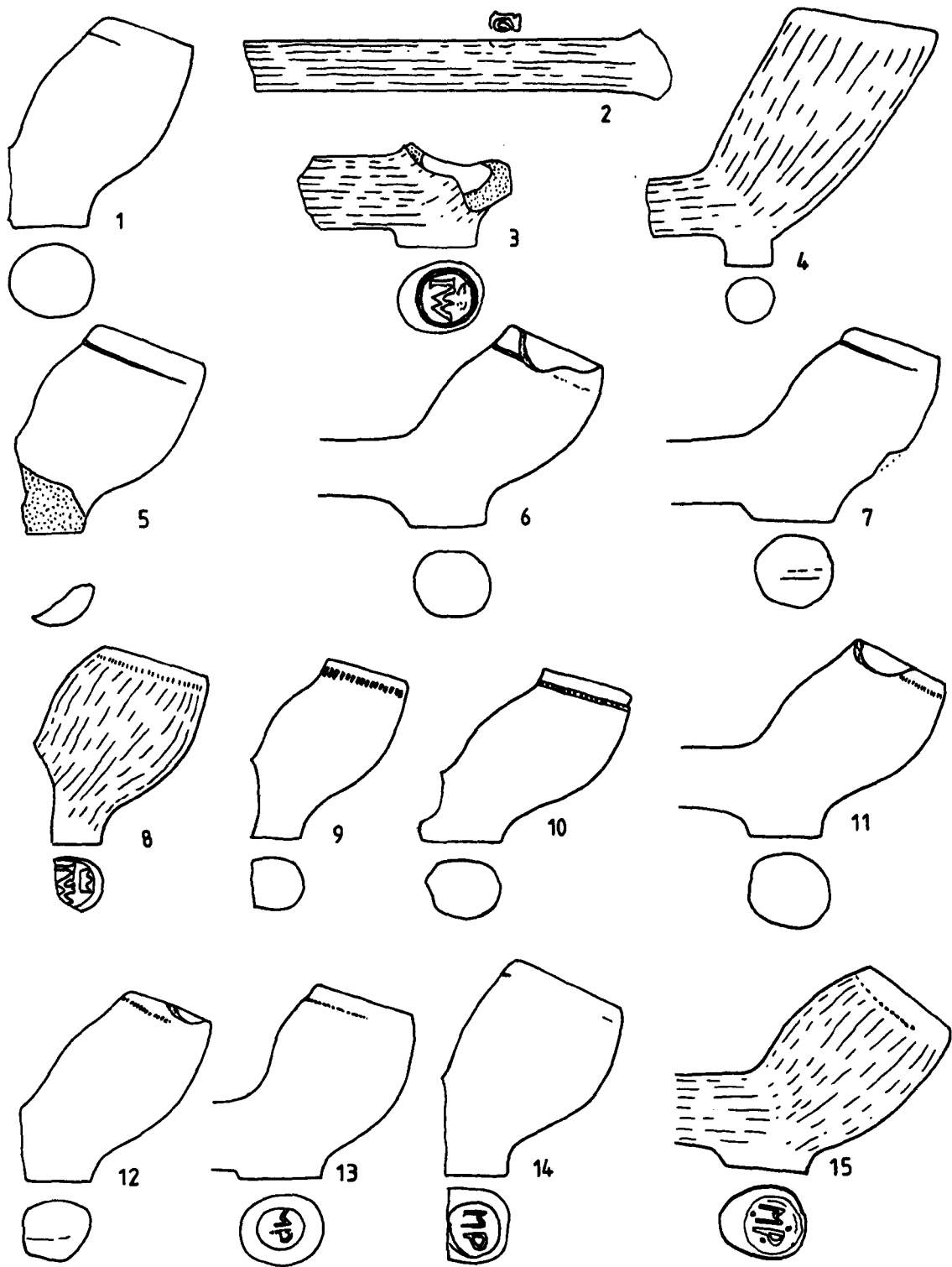
- 165.05 Heel type bowl dating from c1640-1660 from Sandal Castle (Acc No. 1983.10.30); rim bottered and fully milled; stem bore 6/64". Bowl height: 28.7cm; bowl width: 19.4cm; Mould Group 1 (Same as Pontefract Mould Group 1). (Pcode 23333).
- 165.06 Heel type bowl dating from c1640-1660 from Sandal Castle (Acc No. 1983.10.11); rim internally trimmed, bottered and fully milled; stem bore 7/64". Bowl height:29.9cm; bowl width:19.5cm. (Pcode 23263).
- 165.07 Heel type bowl dating from c1640-1660 from Sandal Castle (Acc No. 1983.10.11); rim internally trimmed, bottered and fully milled; stem bore 7/64". Bowl height:29.2cm; bowl width:18.3cm; Mould Group 3. (Pcode 23264).
- 165.08 Heel type bowl dating from c1640-1660 from Sandal Castle (Acc No. 1983.10.48); rim bottered and fully milled; stem bore 7/64". Bowl height: 27.9cm; bowl width: 18.8; Same mould a Pontefract Mould Group 4. (Pcode 23363).
- 165.09 Heel type bowl dating from c1640-1660 from Sandal Castle (Acc No. 1983.10.54); rim bottered and one quarter milled; stem bore 7/64". Bowl height: 28.8cm; bowl width: 18.8cm. (Pcode 23373).
- 165.10 Heel type bowl dating from c1640-1660 from Sandal Castle (Acc No. 1983.10.54); rim bottered and fully milled; stem bore 6/64". Milled heel. Bowl height: 30.1cm; bowl width: 18.5cm. (Pcode 23374).
- 165.11 Heel type bowl dating from c1640-1660 from Sandal Castle (Acc No. 1983.10.56); rim internally trimmed, bottered and fully milled; stem bore 7/64". Bowl height: 27.2cm; bowl width: 18.3cm. (Pcode 23381).
- 165.12 Heel type bowl dating from c1640-1660 from Sandal Castle (Acc No. 1983.10.55); rim bottered and fully milled; stem bore 7/64". Milled at bowl/stem junction behind the heel; bowl height: 31.3cm; bowl width: 18.9cm. (Pcode 23377).
- 165.13 Heel type bowl dating from c1640-1660 from Sandal Castle (Acc No. 1983.10.63); rim bottered and fully milled; stem bore 7/64". Bowl height: 25.7cm; bowl width: 17.9cm. (Pcode 23389).
- 165.14 Heel type bowl dating from c1640-1660 from Sandal Castle (Acc No. 1983.10.58); rim bottered and milled around all of the surviving rim; stem bore 7/64". Bowl height: 26.9cm; bowl width: 17.5cm. (Pcode 23383).
- 165.15 Heel type bowl dating from c1640-1660 from Sandal Castle (Acc No. 1983.10.66); stem bore 6/64". Milled heel. Rim missing; bowl height unmeasurable; bowl width: 18.8cm. (Pcode 23395).
- 165.16 Heel type bowl dating from c1640-1660 from Sandal Castle (Acc No. 1983.10.67); rim bottered and fully milled; stem bore 7/64". Milled on the



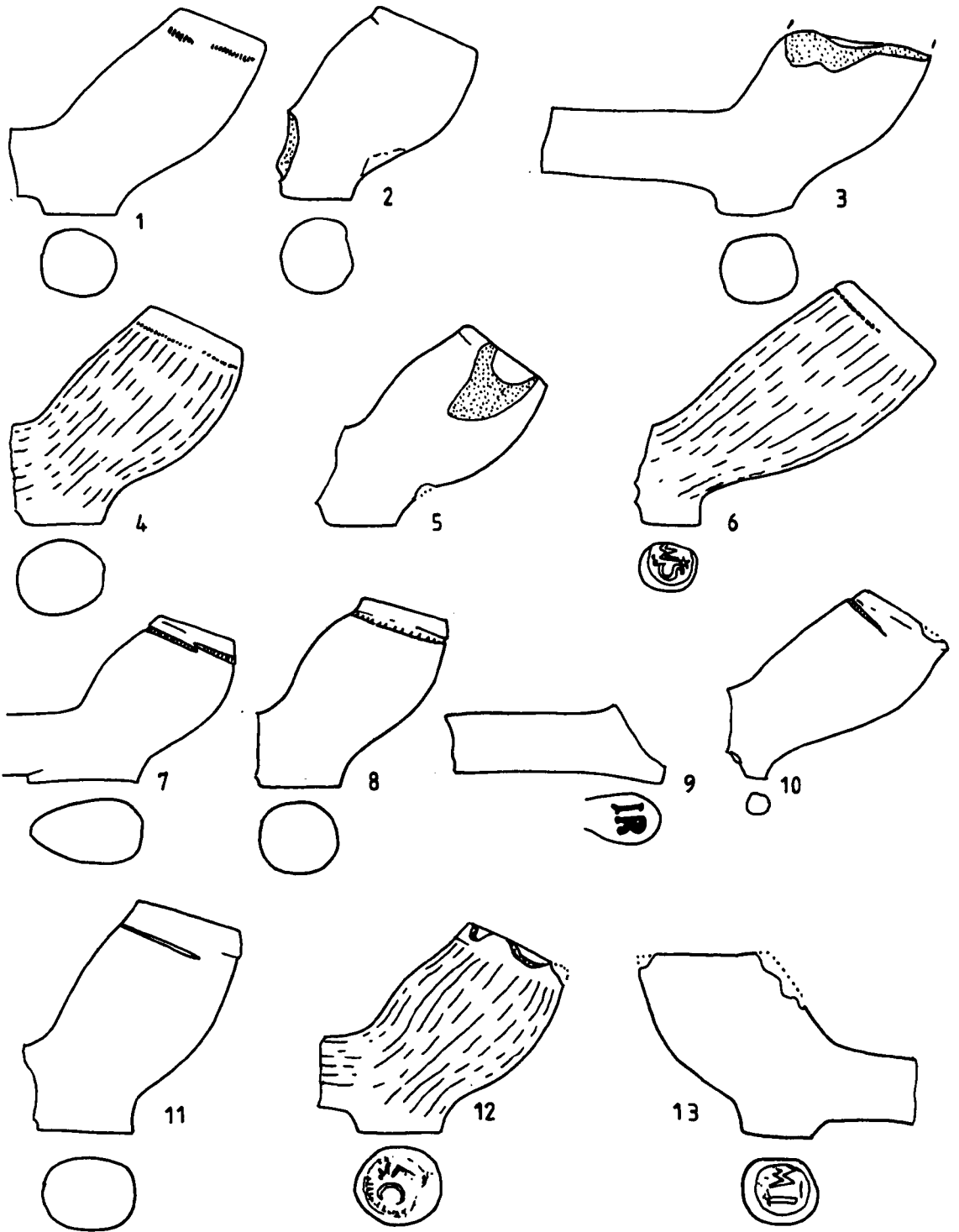
bowl away from the smoker. Bowl height: 29.6cm; bowl width: 19.6cm; Mould Group 1 (Same as Pontefract Mould Group 1). (Pcode 23396).

- 165.17 Heel type bowl dating from c1640-1660 from Sandal Castle (Acc No. 1983.10.67); rim bottered and fully milled; stem bore 6/64". Bowl height: 28.7cm; bowl width: 18.8; Same mould as Pontefract Mould Group 12. (Pcode 23397).
- 165.18 Heel type bowl dating from c1640-1660 from Sandal Castle (Acc No. 1983.10.76); rim bottered and fully milled; stem bore 7/64". Bowl height: 29.6cm; bowl width: 18.7cm. (Pcode 23413).
- 165.19 Heel type bowl dating from c1640-1660 from Sandal Castle (Acc No. 1983.10.75); rim bottered and fully milled. Bowl height: 28.8cm; bowl width: 18.7cm. (Pcode 23412).
- 165.20 Heel type bowl dating from c1640-1660 from Sandal Castle (Acc No. 1983.10.95); rim bottered and fully milled; stem bore 8/64". Milled heel. Bowl height: 30.4cm; bowl width: 18.7cm. (Pcode 23446).
- 166.01 Heel type bowl dating from c1690-1710 from Sandal Castle (Acc No. 1983.10.6); good burnish; stem bore 5/64". Marked with the initials IG across the stem. Heel only. (Pcode 07653).
- 166.01 Heel type bowl dating from c1640-1660 from Sandal Castle (Acc No. 1983.10.92); rim bottered and fully milled; stem bore 7/64". Bowl height: 24.1cm; bowl width: 16.8cm. (Pcode 23432).
- 166.02 Heel type bowl dating from c1640-1660 from Sandal Castle (Acc No. 1983.10.109); rim bottered and fully milled; stem bore 6/64". Bowl height: 27.3cm; bowl width: 17.9cm. (Pcode 23465).
- 166.03 Heel type bowl dating from c1640-1660 from Sandal Castle (Acc No. 1983.10.36); rim bottered and half milled; stem bore 7/64". Broken stem ground for reuse: bowl height: 27.8cm; bowl width: 18.3cm. (Pcode 23482).
- 166.04 Heel type bowl dating from c1640-1660 from Sandal Castle (Acc No. 1983.10.111); rim bottered and fully milled; stem bore 6/64". Bowl height: 26.5cm; bowl width: 17.9; deeply incised V shape scratched on heel. (Pcode 23469).
- 166.05 Heel type bowl dating from c1640-1660 from Sandal Castle (Acc No. 1983.10.101); rim bottered and fully milled; stem bore 5/64". Very shiny surface but no obvious burnishing lines visible; bowl height: 29.7cm; bowl width: 19.1cm. (Pcode 23462).
- 166.06 Heel type bowl dating from c1630-1650 from Sandal Castle (Acc No. 1983.10.14); rim bottered and milled around all of the surviving rim; stem bore 7/64". Bowl height unmeasurable; bowl width: 18.7cm. (Pcode 23280).

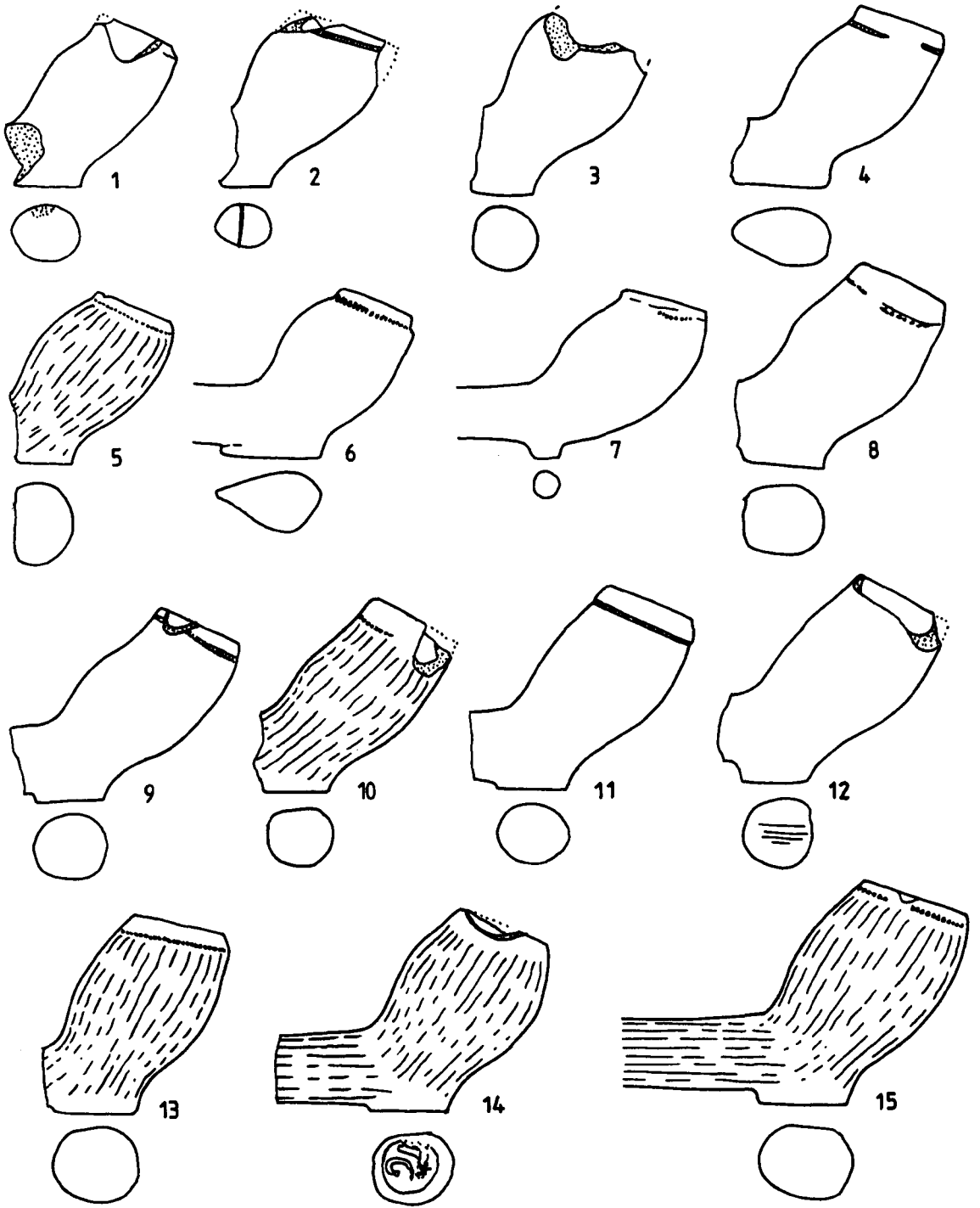
- 166.07 Heel type bowl dating from c1640-1660 from Sandal Castle (Acc No. 1983.10.126); rim internally trimmed, bottered and fully milled; stem bore 7/64". Bowl height: 28.6cm; bowl width: 18.6cm. (Pcode 23477).
- 166.08 Heel type bowl dating from c1660-1680 from Sandal Castle (Acc No. 1983.10.13); rim bottered and fully milled; stem bore 6/64". (Pcode 23277).
- 166.09 Heel type bowl dating from c1660-1680 from Sandal Castle (Acc No. 1983.10.46); rim bottered and three-quarters milled; stem bore 7/64". (Pcode 23355).
- 166.10 Heel type bowl dating from c1660-1680 from Sandal Castle (Acc No. 1983.10.60); rim bottered and fully milled; stem bore 7/64". Does not appear to be a Yorkshire form. (Pcode 23386).
- 166.12 Stem fragment dating from c1690-1720 from Sandal Castle (Acc No. 1983.10.5); good burnish; stem bore 5/64". Marked with the initials IG across the stem. Stem. (Pcode 07651).
- 166.13 Heel type bowl dating from c1660-1690 from Sandal Castle (Acc No. 1983.10.1); good burnish; rim bottered and fully milled; stem bore 6/64". Marked with the initials IG on the heel. (Pcode 07629).
- 167.01 Spur type bowl dating from c1770-1790 from St John's Square, Wakefield; rim cut and not milled. Marked with the lettering THOS GILL REDHALL on the bowl away from the smoker. Found under the floorboards of the house, which was built c1791/2; stem length 18 1/2 " (47cm). Reduced drawing shows curve of the stem. (Pcode 25458).



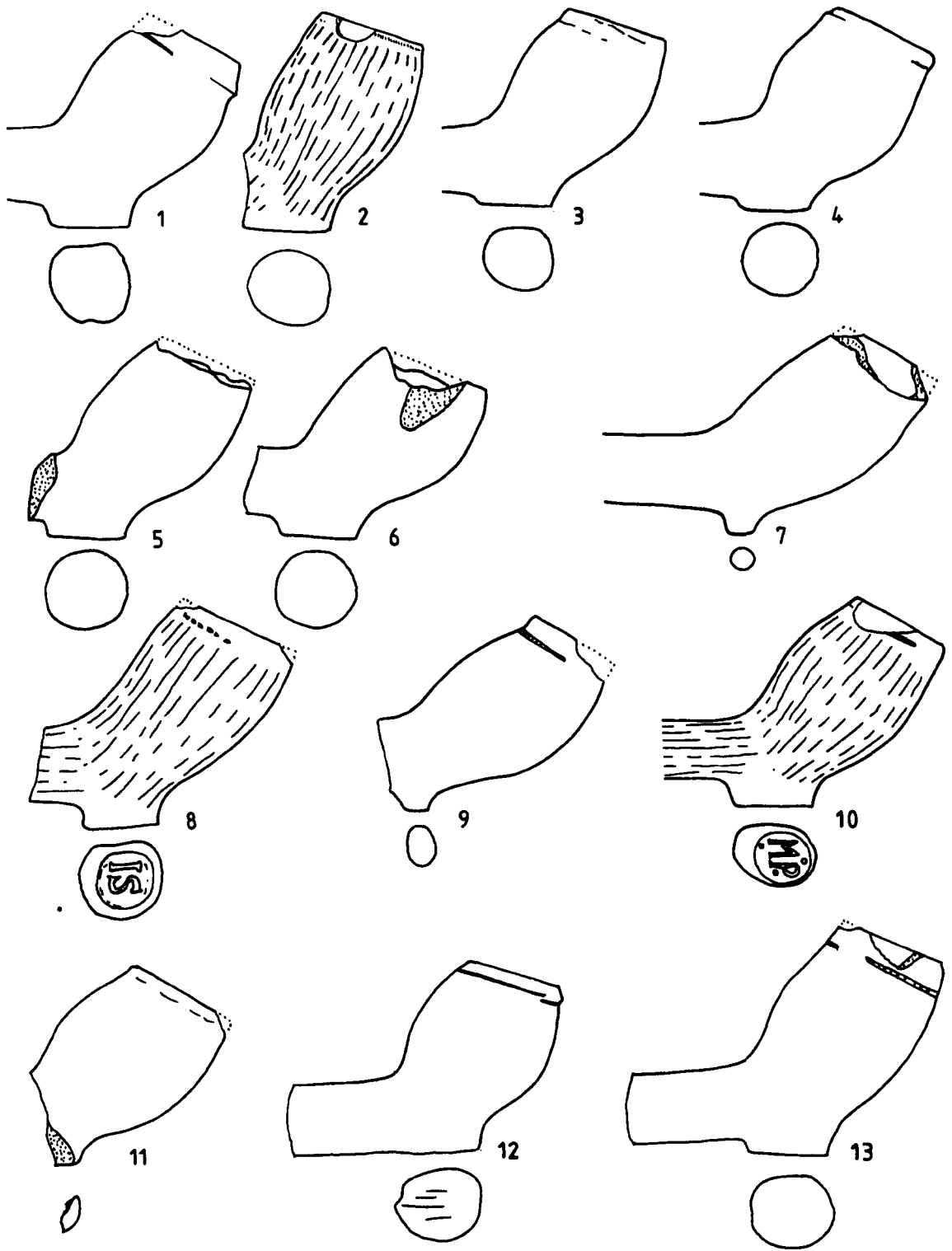
**Figure 158:** Pipes from the collections of Wakefield Museum and Art Gallery.  
Scale 1:1.



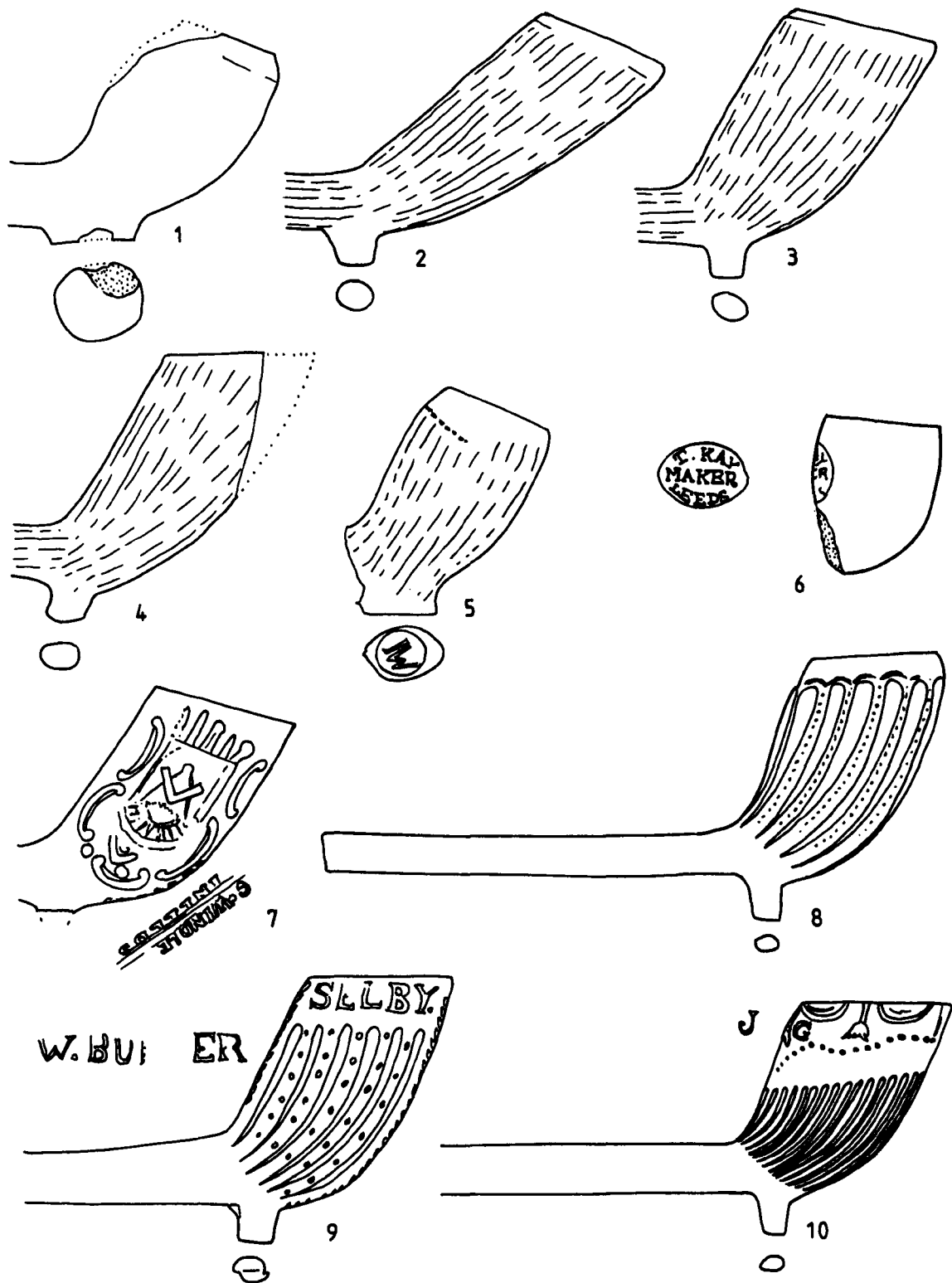
**Figure 159:** Pipes from the collections of Wakefield Museum and Art Gallery. Scale 1:1.



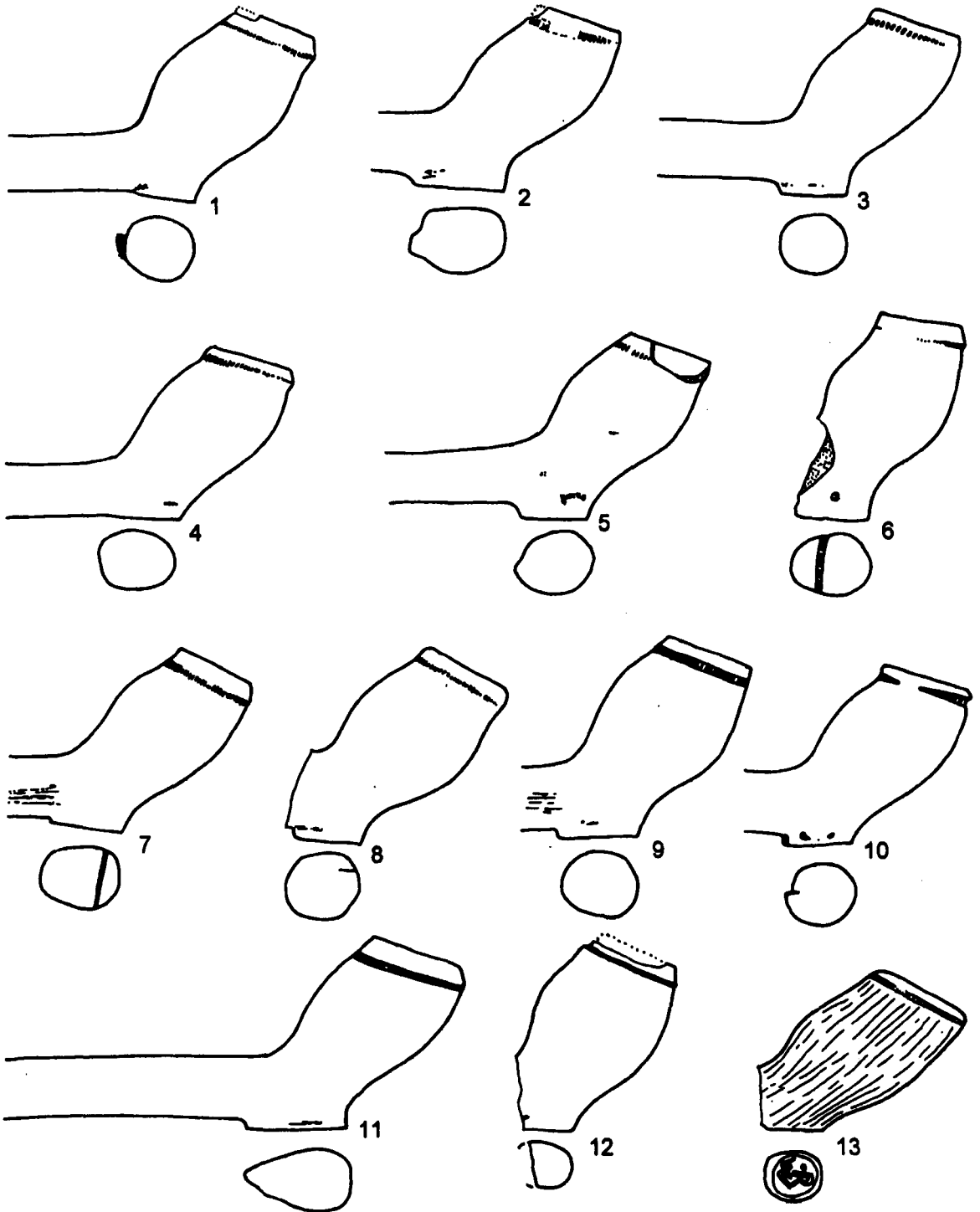
**Figure 160:** Pipes from the collections of Wakefield Museum and Art Gallery. Scale 1:1.



**Figure 161:** Pipes from the collections of Wakefield Museum and Art Gallery. Scale 1:1.

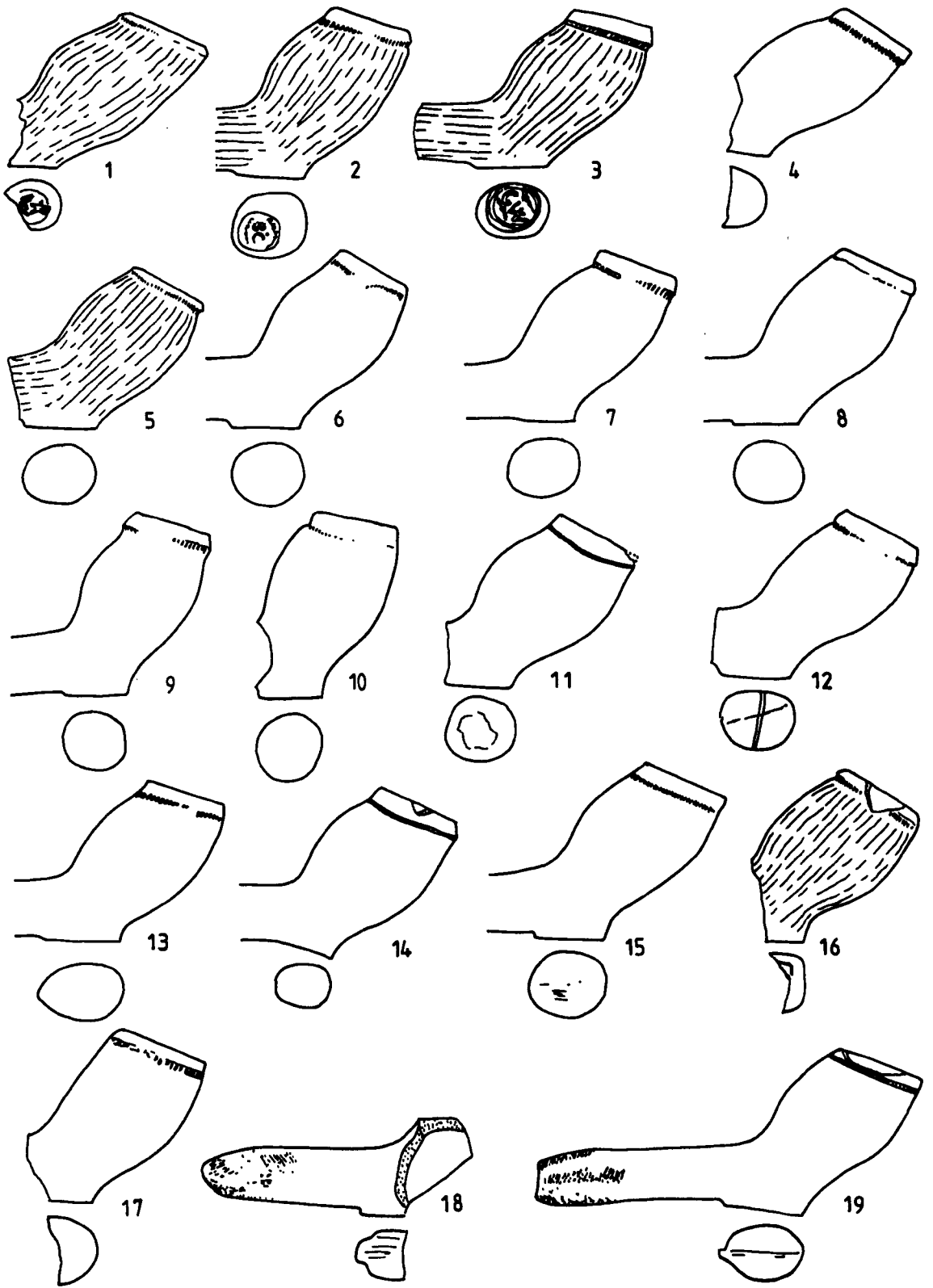


**Figure 162:** Pipes from the collections of Wakefield Museum and Art Gallery. Scale 1:1.

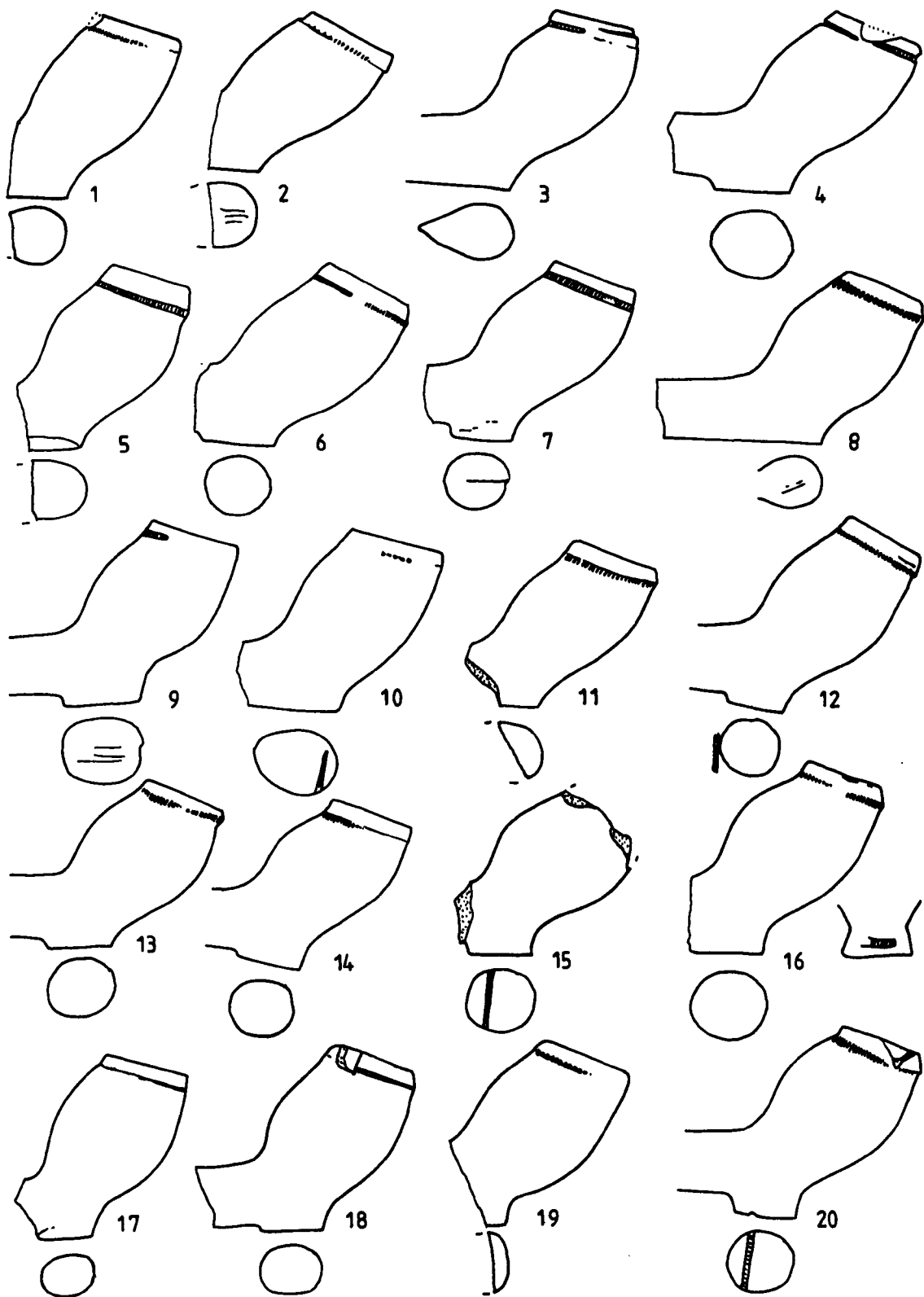


**Figure 163:** Pipes from the collections of Wakefield Museum and Art Gallery. Scale 1:1.

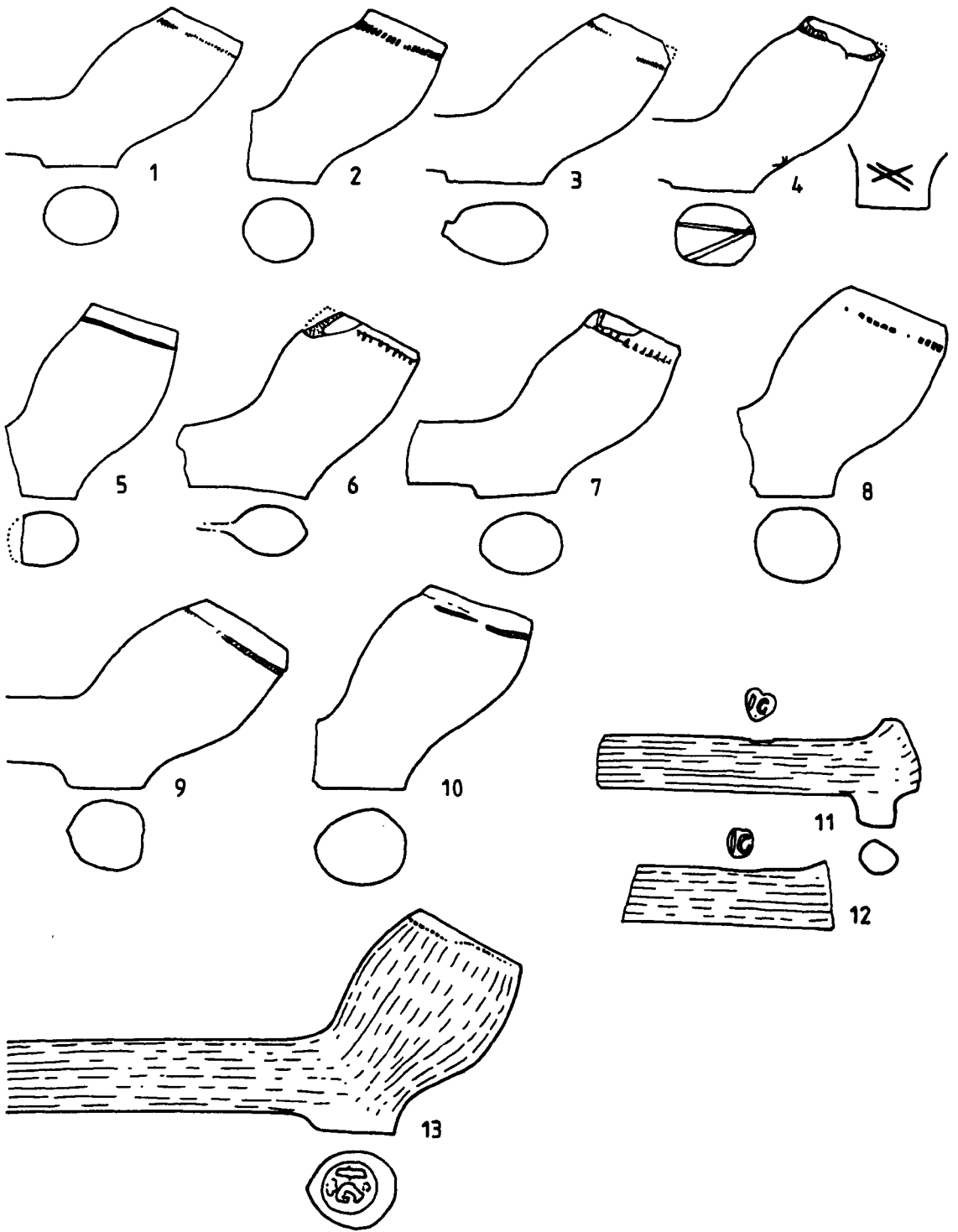




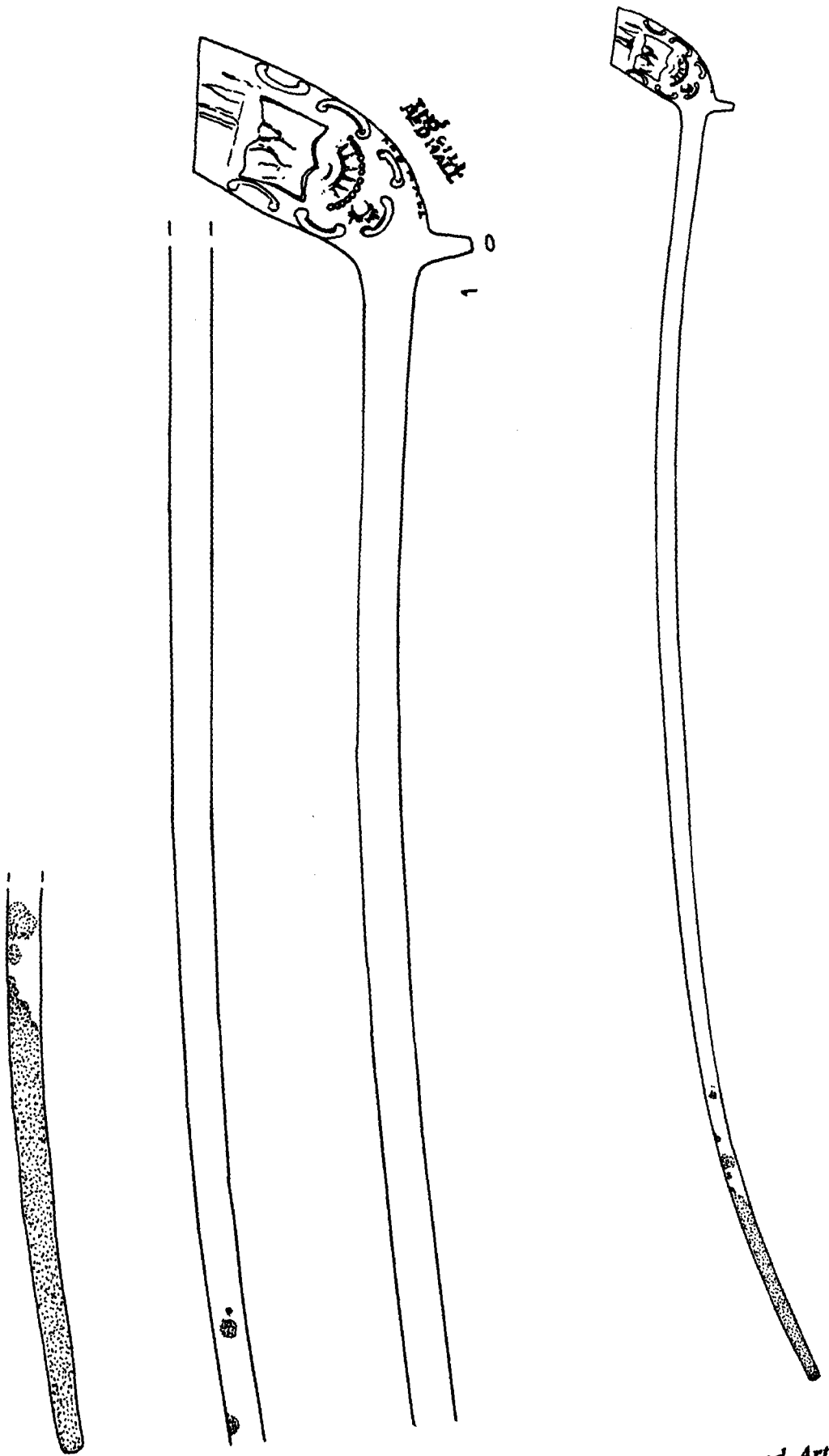
**Figure 164:** Pipes from the collections of Wakefield Museum and Art Gallery. Scale 1:1.



**Figure 165:** Pipes from the collections of Wakefield Museum and Art Gallery. Scale 1:1.



**Figure 166:** Pipes from the collections of Wakefield Museum and Art Gallery. Scale 1:1.



**Figure 167:** Pipes from the collections of Wakefield Museum and Art Gallery.  
Scale 1:1.

**Collection Name:** West Yorkshire Archaeological Services (WYAS)

**Collection Code:** 0123

**Contact Name:**

**Address:** Wakefield, West Yorkshire

**Description:**

Collection comprising a pipes from a number of excavated sites in West Yorkshire the most substantial of which is Pontefract castle (Davey and White 2002; White and Davey forthcoming). In addition S D White has prepared reports on the pipes from the WYAS excavations at Bingley; Sovereign Street, Leeds (*ibid* 1999); Radcliffe Place, Wakefield; Malton (*ibid* 2001c); Old Hall Farm, Pontefract (White 2001a); Spink Lane, Pontefract (*ibid* 2002b) and Knaresborough Bus Station (*ibid*

A total of 680 seventeenth- and eighteenth-century pipes held in the WYAS collection have been recorded in detail for inclusion in the Yorkshire database.

168.01 Heel type bowl dating from c1610-1640 from Pontefract Castle (Acc No. PC82 246c: SF No. 1632); rim bottered but not milled; stem bore 6/64". Bowl No. 245. (Pcode 05416).

168.02 Heel type bowl dating from c1610-1640 from Pontefract Castle (Acc No. PC82 209: SF No. 1404); rim bottered and fully milled; stem bore 7/64". (Pcode 05397).

168.03 Heel type bowl dating from c1620-1640 from Pontefract Castle (Acc No. PC82 116: SF No. 1220); rim bottered and fully milled; stem bore 7/64". Bowl No. 202. (Pcode 05307).

168.04 Heel type bowl dating from c1620-1640 from Pontefract Castle (Acc No. PC82 083: SF No. 687); rim bottered and fully milled; stem bore 6/64". (Pcode 05082).

168.05 Heel type bowl dating from c1625-1650 from Pontefract Castle (Acc No. PC82 116: SF No. 1297); good burnish; stem bore 7/64". Marked with a star on the heel. Bowl No. 242. (Pcode 02114).

168.06 Heel type bowl dating from c1625-1650 from Pontefract Castle (Acc No. PC82 116: SF No. 1297); rim bottered and three quarters milled; stem bore 7/64". Bowl No. 239. (Pcode 05314).

168.07 Heel type bowl dating from c1625-1650 from Pontefract Castle (Acc No. PC82 116: SF No. 1220); rim bottered and fully milled; stem bore 7/64". Bowl No. 188. (Pcode 05311).

168.08 Heel type bowl dating from c1625-1650 from Pontefract Castle (Acc No. PC84 4435: SF No. 2697); rim bottered and milled on all of the surviving rim; stem bore 7/64". (Pcode 05453).

168.09 Heel type bowl dating from c1625-1650 from Pontefract Castle (Acc No. PC82 3061: SF No. 305); rim bottered and fully milled; stem bore 6/64". (Pcode 05426).

- 168.10 Heel type bowl dating from c1625-1650 from Pontefract Castle (Acc No. PC82 3064: SF No. 378); rim bottered and milled on all of the surviving rim; stem bore 6/64". (Pcode 05427).
- 168.11 Heel type bowl dating from c1625-1650 from Pontefract Castle (Acc No. PC82 4001: SF No. 1834); stem bore 6/64". No rim. (Pcode 05428).
- 168.12 Heel type bowl dating from c1625-1650 from Pontefract Castle (Acc No. PC83 4236: SF No. 2271); rim bottered and fully milled; stem bore 7/64". (Pcode 25217).
- 168.13 Heel type bowl dating from c1625-1650 from Pontefract Castle (Acc No. PC83 U/S: SF No. 1909); milled on all of the surviving rim; stem bore 7/64". Milled heel. (Pcode 05450).
- 168.14 Heel type bowl dating from c1625-1650 from Pontefract Castle (Acc No. PC82 097: SF No. 1016); rim bottered and fully milled; stem bore 7/64". Very highly fired, ?waster. (Pcode 05134).
- 168.15 Heel type bowl dating from c1625-1650 from Pontefract Castle (Acc No. PC82 090: SF No. 670); rim bottered and fully milled; stem bore 6/64". (Pcode 05104).
- 168.16 Bowl dating from c1625-1650 from Pontefract Castle (Acc No. PC82 098: SF No. 1086); rim bottered and milled on all of the surviving rim; stem bore 7/64". Bowl No. 25; all surviving rim milled. (Pcode 05166).
- 168.17 Heel type bowl dating from c1630-1650 from Pontefract Castle (Acc No. PC82 109: SF No. 1222); rim bottered and three quarters milled; stem bore 7/64". Bowl No. 143. (Pcode 05270).
- 168.18 Heel type bowl dating from c1625-1650 from Pontefract Castle (Acc No. PC82 098: SF No. 1086); rim bottered and fully milled; stem bore 6/64". Bowl No. 24. (Pcode 05144).
- 168.19 Heel type bowl dating from c1630-1650 from Pontefract Castle (Acc No. PC82 150: SF No. 1314); good burnish; rim bottered and fully milled; stem bore 7/64". (Pcode 05394).
- 168.20 Heel type bowl dating from c1640-1660 from Pontefract Castle (Acc No. PC82 103: SF No. 1110); rim bottered; stem bore 7/64". Bowl No. 116; burnt; no rim. (Pcode 05236).
- 169.01 Heel type bowl dating from c1625-1650 from Pontefract Castle (Acc No. PC82 133: SF No. 1225); rim bottered and fully milled; stem bore 7/64". (Pcode 05383).

- 169.02 Heel type bowl dating from c1640-1660 from Pontefract Castle (Acc No. PC82 099; SF No. 1014); rim bottered and fully milled; stem bore 7/64". Marked with a fleur-de-lys on the heel. Bowl No. 71; burnt. (Pcode 02108).
- 169.03 Heel type bowl dating from c1640-1660 from Pontefract Castle (Acc No. PC82 099; SF No. 1014); rim bottered and fully milled; stem bore 6/64". Bowl No. 52. (Pcode 05198).
- 169.04 Heel type bowl dating from c1640-1660 from Pontefract Castle (Acc No. PC82 099; SF No. 1014); rim bottered but not milled; stem bore 7/64". Bowl No. 54; very crudely made. (Pcode 05197).
- 169.05 Heel type bowl dating from c1640-1660 from Pontefract Castle (Acc No. PC82 103; SF No. 1110); rim bottered and fully milled; stem bore 7/64". Marked with the initials IH on the heel. Bowl No. 119. (Pcode 02111).
- 169.06 Heel type bowl dating from c1640-1660 from Pontefract Castle (Acc No. PC82 103; SF No. 1110); rim bottered and fully milled; stem bore 7/64". Marked with a wheel (type 7) on the heel. Bowl No. 117; very smooth shiny surface. (Pcode 02109).
- 169.07 Heel type bowl dating from c1640-1660 from Pontefract Castle (Acc No. PC82 103; SF No. 1110); rim bottered and milled on all of the surviving rim; stem bore 7/64". Marked with a wheel (type 16) on the heel. Bowl No. 118. (Pcode 02110).
- 169.08 Heel type bowl dating from c1640-1660 from Pontefract Castle (Acc No. PC82 109; SF No. 1222); rim bottered and fully milled; stem bore 7/64". Bowl No. 135. (Pcode 05272).
- 169.09 Heel type bowl dating from c1640-1660 from Pontefract Castle (Acc No. PC82 116; SF No. 1297); rim bottered and fully milled; stem bore 7/64". Marked with the initials IW on the heel. Bowl No. 237. (Pcode 02113).
- 169.10 Heel type bowl dating from c1640-1660 from Pontefract Castle (Acc No. PC82 115; SF No. 1118); rim bottered and fully milled; stem bore 7/64". Bowl No. 162. (Pcode 05305).
- 169.11 Heel type bowl dating from c1640-1660 from Pontefract Castle (Acc No. PC82 116; SF No. 1087); rim bottered and milled on all of the surviving rim; stem bore 6/64". Marked with the initials RB on the heel. Bowl No. 179; polished surface. (Pcode 02112).
- 169.12 Heel type bowl dating from c1640-1660 from Pontefract Castle (Acc No. PC82 116; SF No. 1297); rim bottered and three quarters milled; stem bore 7/64". Bowl No. 216; same mould as bowl No. 120. (Pcode 05308).

- 169.13 Heel type bowl dating from c1640-1660 from Pontefract Castle (Acc No. PC82 116: SF No. 1220); rim bottered and fully milled; stem bore 7/64". Bowl No. 185; same mould as bowl No. 81. (Pcode 05310).
- 169.14 Heel type bowl dating from c1640-1660 from Pontefract Castle (Acc No. PC82 116: SF No. 1297); rim bottered and fully milled; stem bore 7/64". Bowl No. 214; same mould as bowl No. 165. (Pcode 05313).
- 169.15 Heel type bowl dating from c1640-1660 from Pontefract Castle (Acc No. PC82 116: SF No. 1087); rim bottered and fully milled; stem bore 7/64". Bowl No. 168; same mould as bowl No. 141. (Pcode 05312).
- 169.16 Heel type bowl dating from c1640-1660 from Pontefract Castle (Acc No. PC82 116: SF No. 1297); rim bottered and fully milled; stem bore 8/64". Bowl No. 213; same mould as bowl No. 8; ground stem. (Pcode 05309).
- 169.17 Heel type bowl dating from c1640-1660 from Pontefract Castle (Acc No. PC84 4435: SF No. 2697); rim bottered and milled on all of the surviving rim; stem bore 7/64". (Pcode 05455).
- 169.18 Heel type bowl dating from c1640-1660 from Pontefract Castle (Acc No. PC82 036: SF No. 350); rim bottered and fully milled; stem bore 7/64". (Pcode 05069).
- 169.19 Heel type bowl dating from c1640-1660 from Pontefract Castle (Acc No. PC82 083: SF No. 687); rim bottered and fully milled; stem bore 7/64". Shiny surface. (Pcode 05084).
- 169.20 Heel type bowl dating from c1640-1660 from Pontefract Castle (Acc No. PC83 4001: SF No. 1883); rim bottered and fully milled; stem bore 7/64". Milled behind the heel. (Pcode 05446).
- 170.01 Heel type bowl dating from c1640-1660 from Pontefract Castle (Acc No. PC82 109: SF No. 1222); rim bottered and fully milled; stem bore 7/64". Milled heel. Bowl No. 133; same mould as bowl No. 46. (Pcode 05271).
- 170.02 Heel type bowl dating from c1640-1660 from Pontefract Castle (Acc No. PC82 098: SF No. 1086); rim bottered and fully milled; stem bore 6/64". Bowl No. 18; same mould as bowl nos. 16, 17, 43 and 47. (Pcode 05141).
- 170.03 Heel type bowl dating from c1640-1660 from Pontefract Castle (Acc No. PC82 3001: SF No. 215); rim bottered and milled on all of the surviving rim; stem bore 5/64". (Pcode 05421).
- 170.04 Heel type bowl dating from c1640-1660 from Pontefract Castle (Acc No. PC82 114: SF No. 1111); rim bottered and fully milled; stem bore 7/64". Milled behind the heel. Bowl No. 159; same mould as bowl No. 9. (Pcode 05301).



- 170.05 Heel type bowl dating from c1640-1660 from Pontefract Castle (Acc No. PC82 012: SF No. 216); rim bottered and fully milled; stem bore 7/64". (Pcode 05061).
- 170.06 Heel type bowl dating from c1640-1660 from Pontefract Castle (Acc No. PC83 269: SF No. 1763); rim bottered and fully milled; stem bore 7/64". (Pcode 05433).
- 170.07 Heel type bowl dating from c1640-1660 from Pontefract Castle (Acc No. PC83 271: SF No. 1772); rim bottered and fully milled; stem bore 6/64". Milled behind the heel. (Pcode 05435).
- 170.08 Heel type bowl dating from c1640-1660 from Pontefract Castle (Acc No. PC83 271: SF No. 1772); rim bottered and fully milled; stem bore 7/64". (Pcode 05436).
- 170.09 Heel type bowl dating from c1640-1660 from Pontefract Castle (Acc No. PC84 4435: SF No. 2697); rim bottered and fully milled; stem bore 6/64". (Pcode 05454).
- 170.10 Heel type bowl dating from c1640-1660 from Pontefract Castle (Acc No. PC83 4001: SF No. 1880); rim bottered and three quarters milled; stem bore 7/64". (Pcode 05445).
- 170.11 Heel type bowl dating from c1640-1660 from Pontefract Castle (Acc No. PC82 133: SF No. 1411); rim bottered and fully milled; stem bore 7/64". (Pcode 05385).
- 170.12 Heel type bowl dating from c1640-1660 from Pontefract Castle (Acc No. PC82 133: SF No. 1411); rim bottered and fully milled; stem bore 7/64". Milled heel. (Pcode 05386).
- 170.13 Heel type bowl dating from c1640-1660 from Pontefract Castle (Acc No. PC82 082: SF No. 604); rim bottered and fully milled; stem bore 7/64". (Pcode 05079).
- 170.14 Heel type bowl dating from c1640-1660 from Pontefract Castle (Acc No. PC82 082: SF No. 604); rim bottered but not milled; stem bore 7/64". Shiny surface; very highly fired. (Pcode 05078).
- 170.15 Heel type bowl dating from c1640-1660 from Pontefract Castle (Acc No. PC82 082: SF No. 604); rim bottered and fully milled; stem bore 6/64". Very neatly finished. (Pcode 05076).
- 170.16 Heel type bowl dating from c1640-1660 from Pontefract Castle (Acc No. PC83 271: SF No. 1772); stem bore 8/64". No rim. (Pcode 05437).
- 170.17 Heel type bowl dating from c1640-1660 from Pontefract Castle (Acc No. PC82 083: SF No. 687); rim bottered and fully milled; stem bore 7/64". Shiny surface. (Pcode 05086).

- 170.18 Heel type bowl dating from c1640-1660 from Pontefract Castle (Acc No. PC82 083; SF No. 687); rim bottered and fully milled; stem bore 7/64". Shiny surface. (Pcode 05085).
- 170.19 Bowl dating from c1640-1660 from Pontefract Castle (Acc No. PC84 U/S; SF No. 2541); rim internally trimmed and bottered and fully milled; stem bore -/64". Bowl speckled with slaggy material. (Pcode 05460).
- 170.20 Heel type bowl dating from c1640-1660 from Pontefract Castle (Acc No. PC82 083; SF No. 687); rim bottered and fully milled; stem bore 7/64". (Pcode 05083).
- 171.01 Heel type bowl dating from c1640-1660 from Pontefract Castle (Acc No. PC82 209; SF No. 1404); rim bottered and fully milled; stem bore 6/64". Cut mark on heel. (Pcode 05404).
- 171.02 Heel type bowl dating from c1640-1660 from Pontefract Castle (Acc No. PC82 209; SF No. 1404); rim bottered and fully milled; stem bore 7/64". (Pcode 05400).
- 171.03 Heel type bowl dating from c1640-1660 from Pontefract Castle (Acc No. PC82 209; SF No. 1404); rim bottered but not milled; stem bore 8/64". (Pcode 05398).
- 171.04 Heel type bowl dating from c1640-1660 from Pontefract Castle (Acc No. PC82 209; SF No. 1404); rim bottered and fully milled; stem bore 7/64". (Pcode 05403).
- 171.05 Heel type bowl dating from c1640-1660 from Pontefract Castle (Acc No. PC82 090; SF No. 670); rim bottered and fully milled; stem bore 6/64". (Pcode 05112).
- 171.06 Heel type bowl dating from c1640-1660 from Pontefract Castle (Acc No. PC82 090; SF No. 670); rim bottered and fully milled; stem bore 7/64". (Pcode 05113).
- 171.07 Heel type bowl dating from c1640-1660 from Pontefract Castle (Acc No. PC82 090; SF No. 670); good burnish; rim bottered and three quarters milled; stem bore 6/64". Bowl No. 253; similar to 1249; very smooth and shiny surface. (Pcode 05110).
- 171.08 Heel type bowl dating from c1640-1660 from Pontefract Castle (Acc No. PC82 097; SF No. 838); rim bottered and fully milled; stem bore 7/64". (Pcode 05132).
- 171.09 Heel type bowl dating from c1640-1660 from Pontefract Castle (Acc No. PC82 090; SF No. 670); rim bottered and one quarter milled; stem bore 7/64". Ground on front and sides of bowl. (Pcode 05114).

- 171.10 Heel type bowl dating from c1640-1660 from Pontefract Castle (Acc No. PC82 090: SF No. 670); rim bottered and fully milled; stem bore 7/64". Appears to have been burnt. (Pcode 05109).
- 171.11 Heel type bowl dating from c1640-1660 from Pontefract Castle (Acc No. PC82 090: SF No. 670); rim bottered and fully milled; stem bore 6/64". Milled behind the heel. (Pcode 05105).
- 171.12 Heel type bowl dating from c1640-1660 from Pontefract Castle (Acc No. PC82 090: SF No. 670); rim bottered and fully milled; stem bore 6/64". Milled heel. (Pcode 05106).
- 171.13 Heel type bowl dating from c1640-1660 from Pontefract Castle (Acc No. PC82 090: SF No. 670); rim bottered and three quarters milled; stem bore 7/64". (Pcode 05108).
- 171.14 Heel type bowl dating from c1640-1660 from Pontefract Castle (Acc No. PC82 090: SF No. 670); rim bottered and fully milled; stem bore 7/64". Appears to have been burnt. (Pcode 05107).
- 171.15 Heel type bowl dating from c1640-1660 from Pontefract Castle (Acc No. PC82 098: SF No. 1086); rim bottered and fully milled; stem bore 7/64". Bowl No. 32. (Pcode 05143).
- 171.16 Heel type bowl dating from c1640-1660 from Pontefract Castle (Acc No. PC82 209: SF No. 1404); rim bottered and fully milled; stem bore 7/64". Shiny surface. (Pcode 05401).
- 171.17 Heel type bowl dating from c1640-1660 from Pontefract Castle (Acc No. PC82 090: SF No. 670); milled on all of the surviving rim; stem bore 7/64". Rim broken and ground down. (Pcode 05111).
- 171.18 Heel type bowl dating from c1640-1660 from Pontefract Castle (Acc No. PC82 098: SF No. 1086); rim bottered and fully milled; stem bore 7/64". Bowl No. 28; same mould as bowl No. 193. (Pcode 05142).
- 172.01 Heel type bowl dating from c1640-1660 from Pontefract Castle (Acc No. PC82 110: SF No. 1112); rim bottered and fully milled; stem bore 6/64". Bowl No. 153. (Pcode 05297).
- 172.02 Heel type bowl dating from c1640-1660 from Pontefract Castle (Acc No. PC82 103: SF No. 1110); rim bottered and fully milled; stem bore 7/64". Bowl No. 96. (Pcode 05237).
- 172.03 Heel type bowl dating from c1640-1660 from Pontefract Castle (Acc No. PC82 090: SF No. 670); rim bottered and fully milled; stem bore 7/64". Milled behind the heel. (Pcode 05100).

- 172.04 Heel type bowl dating from c1640-1660 from Pontefract Castle (Acc No. PC82 090: SF No. 670); rim bottered and fully milled; stem bore 6/64". Milled heel. Bowl No. 252; same mould as 1257. (Pcode 05101).
- 172.05 Heel type bowl dating from c1640-1660 from Pontefract Castle (Acc No. PC82 029: SF No. 341); rim bottered but not milled; stem bore 7/64". (Pcode 05065).
- 172.06 Heel type bowl dating from c1640-1660 from Pontefract Castle (Acc No. PC82 209: SF No. 1412); rim bottered and fully milled; stem bore 7/64". (Pcode 05396).
- 172.07 Heel type bowl dating from c1640-1670 from Pontefract Castle (Acc No. PC82 090: SF No. 670); stem bore 6/64". Milled heel. No rim. (Pcode 05102).
- 172.08 Heel type bowl dating from c1640-1660 from Pontefract Castle (Acc No. PC82 097: SF No. 838); good burnish; rim bottered and fully milled; stem bore 7/64". Milled heel. (Pcode 05131).
- 172.09 Heel type bowl dating from c1640-1660 from Pontefract Castle (Acc No. PC82 090: SF No. 827); rim bottered and milled on all of the surviving rim; stem bore 8/64". Not burnished but very smooth and shiny; end of stem ground. (Pcode 25234).
- 172.10 Heel type bowl dating from c1640-1660 from Pontefract Castle (Acc No. PC82 133: SF No. 1411); stem bore 7/64". Milled heel. Two bands of milling. (Pcode 05388).
- 172.11 Heel type bowl dating from c1640-1660 from Pontefract Castle (Acc No. PC82 133: SF No. 1411); rim bottered and milled on all of the surviving rim; stem bore 7/64". Milled behind the heel. Same mould as 1227; two marks in the mould that appear on this pipe but not on 1227 suggest relative chronology. (Pcode 05387).
- 172.12 Heel type bowl dating from c1640-1660 from Pontefract Castle (Acc No. PC82 133: SF No. 1225); rim bottered and fully milled; stem bore 7/64". Milled heel, along line of bowl from front to back; same mould as 1230. (Pcode 05384).
- 172.13 Heel type bowl dating from c1640-1660 from Pontefract Castle (Acc No. PC82 209: SF No. 1404); rim bottered and fully milled; stem bore 7/64". Same mould as Pcode 05412. (Pcode 05402).
- 172.14 Bowl dating from c1640-1660 from Pontefract Castle (Acc No. PC85 6001: SF No. 2858); good burnish; rim bottered and milled on all of the surviving rim; stem bore 6/64". Milled on all surviving rim. (Pcode 05461).

- 172.15 Heel type bowl dating from c1640-1660 from Pontefract Castle (Acc No. PC82 083: SF No. 687); rim bottered and fully milled; stem bore 6/64". Shiny surface. (Pcode 05087).
- 172.16 Heel type bowl dating from c1640-1660 from Pontefract Castle (Acc No. PC82 099: SF No. 1121); rim bottered and fully milled; stem bore 7/64". Milled heel. Bowl No. 74. (Pcode 05196).
- 172.17 Heel type bowl dating from c1640-1660 from Pontefract Castle (Acc No. PC82 039: SF No. 2094); rim bottered and fully milled; stem bore 7/64". (Pcode 05071).
- 172.18 Heel type bowl dating from c1640-1660 from Pontefract Castle (Acc No. PC82 209: SF No. 1404); finely burnished; rim bottered and milled on all of the surviving rim; stem bore 7/64". (Pcode 05399).
- 172.19 Heel type bowl dating from c1640-1660 from Pontefract Castle (Acc No. PC83 501: SF No. 1740); stem bore 6/64". Heel fragment only. (Pcode 05449).
- 172.20 Heel type bowl dating from c1640-1660 from Pontefract Castle (Acc No. PC82 097: SF No. 1016); rim bottered and fully milled; stem bore 8/64". (Pcode 05133).
- 173.01 Heel type bowl dating from c1640-1660 from Pontefract Castle (Acc No. PC82 098: SF No. 1051); rim bottered and milled on all of the surviving rim; stem bore 7/64". Bowl No. 7; very crudely made. (Pcode 05140).
- 173.02 Heel type bowl dating from c1640-1660 from Pontefract Castle (Acc No. PC82 099: SF No. 1121); good burnish; rim bottered and fully milled; stem bore 7/64". Bowl No. 82. (Pcode 05199).
- 173.03 Heel type bowl dating from c1640-1660 from Pontefract Castle (Acc No. PC82 114: SF No. 1111); rim bottered and fully milled; stem bore 6/64". Milled heel. Bowl No. 158; milled heel. (Pcode 05302).
- 173.04 Heel type bowl dating from c1640-1660 from Pontefract Castle (Acc No. PC82 098: SF No. 1051); rim bottered and fully milled; stem bore 7/64". Bowl No. 5. (Pcode 05175).
- 173.05 Heel type bowl dating from c1645-1660 from Pontefract Castle (Acc No. PC82 086: SF No. 829); rim bottered and fully milled; stem bore -/64". (Pcode 05091).
- 173.06 Heel type bowl dating from c1640-1660 from Pontefract Castle (Acc No. PC82 098: SF No. 1086); stem bore 7/64". Bowl No. 33; rim ground. (Pcode 05145).

- 173.07 Heel type bowl dating from c1640-1660 from Pontefract Castle (Acc No. PC82 116: SF No. 1297); rim bottered and fully milled; stem bore 7/64". Bowl No. 221; polished surface; hollow ground in to heel. (Pcode 05368).
- 173.08 Heel type bowl dating from c1640-1660 from Pontefract Castle (Acc No. PC82 103: SF No. 1110); rim bottered and fully milled; stem bore 8/64". Bowl No. 95; end of stem ground. (Pcode 05262).
- 173.09 Heel type bowl dating from c1645-1660 from Pontefract Castle (Acc No. PC82 087: SF No. 674); rim bottered and fully milled; stem bore 6/64". (Pcode 05097).
- 173.10 Heel type bowl dating from c1640-1660 from Pontefract Castle (Acc No. PC82 116: SF No. 1297); rim bottered and fully milled; stem bore 7/64". Bowl No. 224; heart shaped heel. (Pcode 05371).
- 173.11 Heel type bowl dating from c1650-1670 from Pontefract Castle (Acc No. PC82 039: SF No. 351); rim bottered and three quarters milled; stem bore 6/64". (Pcode 05072).
- 173.12 Heel type bowl dating from c1640-1660 from Pontefract Castle (Acc No. PC82 098: SF No. 1086); rim bottered and fully milled; stem bore 7/64". Milled behind the heel. Bowl No. 42; milled at bowl/stem junction behind the heel. (Pcode 051051).
- 173.13 Heel type bowl dating from c1650-1670 from Pontefract Castle (Acc No. PC83 271: SF No. 1772); rim bottered and fully milled; stem bore 6/64". Milled heel. (Pcode 05434).
- 173.14 Heel type bowl dating from c1650-1670 from Pontefract Castle (Acc No. PC82 087: SF No. 674); rim bottered and half milled; stem bore 6/64". (Pcode 05096).
- 173.15 Heel type bowl dating from c1650-1670 from Pontefract Castle (Acc No. PC82i 083); good burnish; rim bottered and fully milled; stem bore 7/64". Marked with the initials TH on the heel. . (Pcode 02116).
- 173.16 Heel type bowl dating from c1650-1670 from Pontefract Castle (Acc No. PC88 U/S: SF No. 3757); good burnish; rim bottered and fully milled; stem bore 6/64". Marked with the initials IB on the heel. Bowl fragment. (Pcode 02117).
- 173.17 Heel type bowl dating from c1650-1670 from Pontefract Castle (Acc No. PC82 150: SF No. 1314); good burnish; rim bottered and half milled; stem bore 7/64". Milling is very fine. (Pcode 05393).
- 173.18 Heel type bowl dating from c1650-1670 from Pontefract Castle (Acc No. PC82 086: SF No. 829); rim bottered and three quarters milled; stem bore 7/64". (Pcode 05090).

- 173.19 Heel type bowl dating from c1650-1670 from Pontefract Castle (Acc No. PC83 240: SF No. 1602); good burnish; rim bottered and milled on all of the surviving rim; stem bore 6/64". Marked with the initials TL on the heel. . (Pcode 02099).
- 173.20 Heel type bowl dating from c1650-1670 from Pontefract Castle (Acc No. PC83 271: SF No. 1772); rim bottered and fully milled; stem bore -/64". (Pcode 05438).
- 174.01 Heel type bowl dating from c1650-1670 from Pontefract Castle (Acc No. PC82 028: SF No. 337); rim bottered and one quarter milled; stem bore 6/64". (Pcode 05063).
- 174.02 Heel type bowl dating from c1650-1680 from Pontefract Castle (Acc No. PC82 086: SF No. 829); rim bottered and milled on all of the surviving rim; stem bore 7/64". Quite crudely made. (Pcode 05093).
- 174.03 Heel type bowl dating from c1650-1670 from Pontefract Castle (Acc No. PC84 4435: SF No. 2654); good burnish; rim bottered and three quarters milled; stem bore 7/64". Marked with the initials IB on the heel. . (Pcode 02102).
- 174.04 Heel type bowl dating from c1650-1670 from Pontefract Castle (Acc No. PC82 029: SF No. 341); rim bottered and one quarter milled; stem bore 6/64". Marked with the initials IB on the heel. . (Pcode 05064).
- 174.05 Heel type bowl dating from c1650-1670 from Pontefract Castle (Acc No. PC84 4351: SF No. 2521); good burnish; stem bore 6/64". Marked with the initials IB on the heel. No rim. (Pcode 02100).
- 174.06 Heel type bowl dating from c1650-1670 from Pontefract Castle (Acc No. PC84 4435: SF No. 2654); rim bottered and milled on all of the surviving rim; stem bore 5/64". (Pcode 05456).
- 174.07 Heel type bowl dating from c1650-1670 from Pontefract Castle (Acc No. PC82 086: SF No. 829); rim bottered but not milled; stem bore 6/64". (Pcode 05088).
- 174.08 Heel type bowl dating from c1660-1690 from Pontefract Castle (Acc No. PC82 150: SF No. 1314); good burnish; rim bottered and one quarter milled; stem bore 6/64". Marked with the initials IH either side of a fleur-de-lys in a lozenge. Similar marks with HF from Knaresborough castle. (Pcode 05392).
- 174.09 Heel type bowl dating from c1660-1680 from Pontefract Castle (Acc No. PC82 086: SF No. 829); rim bottered but not milled; stem bore 6/64". (Pcode 05092).
- 174.10 Heel type bowl dating from c1660-1680 from Pontefract Castle (Acc No. PC82 086); average burnish; stem bore 6/64". Marked with the initials IMH on the heel. 3-letter mark. (Pcode 02091).

- 174.11 Heel type bowl dating from c1660-1680 from Pontefract Castle (Acc No. PC82 087); average burnish; rim bottered but not milled; stem bore 5/64". Marked with the initials IH (Castle) on the heel. . (Pcode 02094).
- 174.12 Heel type bowl dating from c1660-1680 from Pontefract Castle (Acc No. PC82 087); average burnish; rim bottered and one quarter milled; stem bore 6/64". Marked with the initials IG on the heel. . (Pcode 02095).
- 174.13 Heel type bowl dating from c1660-1690 from Pontefract Castle (Acc No. PC88 U/S: SF No. 3755); average burnish; rim bottered but not milled; stem bore 6/64". Marked with the initials IG on the heel. Bowl fragment. (Pcode 02118).
- 174.14 Heel type bowl dating from c1660-1680 from Pontefract Castle (Acc No. PC83 240: SF No. 1602); good burnish; stem bore 7/64". Marked with the initials IT on the heel. . (Pcode 02098).
- 174.15 Heel type bowl dating from c1660-1680 from Pontefract Castle (Acc No. PC82 036: SF No. 350); rim bottered and fully milled; stem bore 7/64". (Pcode 05070).
- 174.16 Heel type bowl dating from c1660-1680 from Pontefract Castle (Acc No. PC82 098: SF No. 605); rim bottered and fully milled; stem bore 7/64". Marked with the initials WH on the heel. Possibly William Hodgson (Oswald 1975, 200). (Pcode 02106).
- 174.17 Stem fragment dating from c1660-1680 from Pontefract Castle (Acc No. PC83 240: SF No. 1602); average burnish; stem bore 6/64". Marked with the crowned initials IH across the stem. (Pcode 02097).
- 174.18 Stem fragment dating from c1650-1799 from Pontefract Castle (Acc No. PC82 3002: SF No. 608); stem bore 7/64". Milled decoration (Pcode 25324).
- 174.19 Stem fragment dating from c1700-1770 from Pontefract Castle (Acc No. PC83 279: SF No. 2099); good burnish; stem bore 4/64". Stamped with bands round the stem. (Pcode 02115).
- 175.01 Heel type bowl dating from c1660-1680 from Pontefract Castle (Acc No. PC82 028: SF No. 337); good burnish; rim bottered but not milled; stem bore 7/64". (Pcode 05062).
- 175.02 Heel type bowl dating from c1660-1690 from Pontefract Castle (Acc No. PC82 079: SF No. 610); rim bottered but not milled; stem bore 7/64". (Pcode 05075).
- 175.03 Heel type bowl dating from c1670-1690 from Pontefract Castle (Acc No. PC82 001: SF No. 1325); good burnish; rim bottered and three quarters milled; stem bore 7/64". Marked with the crowned initials IH on the heel. . (Pcode 02105).



- 175.04 Heel type bowl dating from c1680-1700 from Pontefract Castle (Acc No. PC82 001: SF No. 1325); rim bottered but not milled; stem bore 6/64". (Pcode 05058).
- 175.05 Heel type bowl dating from c1690-1710 from Pontefract Castle (Acc No. PC82 001: SF No. 1325); rim internally trimmed and bottered but not milled; stem bore 5/64". (Pcode 05057).
- 175.06 Heel type bowl dating from c1690-1730 from Pontefract Castle (Acc No. PC82 086: SF No. 829); stem bore 6/64". (Pcode 05094).
- 175.07 Heel type bowl dating from c1690-1720 from Pontefract Castle (Acc No. PC82 087: SF No. 830); average burnish; rim bottered but not milled; stem bore 6/64". (Pcode 05099).
- 175.08 Heel type bowl dating from c1690-1720 from Pontefract Castle (Acc No. PC82 029: SF No. 341); rim internally trimmed and cut but not milled; stem bore 6/64". (Pcode 05066).
- 175.09 Spur type bowl dating from c1700-1780 from Pontefract Castle (Acc No. PC82 3001: SF No. 215); rim cut and milled on all of the surviving rim; stem bore 5/64". (Pcode 05422).
- 175.10 Bowl dating from c1840-1860 from Pontefract Castle (Acc No. 278: SF No. 2133); rim cut; stem bore 5/64". Composite drawing of a mould decorated bowl with an acorn design on both sides; large oak leaf on the back and an acorn spur. Fragments of 20 examples of this design, all from the same mould, were recovered from the same context.
- 175.11 Bowl dating from c1830-1860 from Pontefract Castle (Acc No. U/S: SF No. 1800); rim cut; stem bore 4/64". Mould decorated bowl with Britannian on the right and a ship on the left; leaf decorated seams.
- 175.12 Bowl dating from c1830-1860 from Pontefract Castle (Acc No. 086: SF No. 829); rim cut; stem bore 4/64". Mould decorated bowl with flowers, possibly roses, on both sides. Traces of moulded milling visible.
- 176.01 Bowl dating from c1840-1880 from Pontefract Castle (Acc No. 278: SF No. 2123); rim cut; stem bore 4/64". Composite drawing of a mould decorated bowl tih a rose design on both sides; leaf decorated seams.
- 176.02 Bowl dating from c1790-1840 from Pontefract Castle (Acc No. 086: SF No. 829); rim cut; stem bore 5/64". Mould decorated bowl with a series of narrow flutes on both sides.
- 176.03 Bowl dating from c1847-1884 from Pontefract Castle (Acc No. 086: SF No. 631); rim wiped; stem bore -/64". Mould decorated bowl fragment with flutes and swags on both sides; the moulded initials CA can clearly be seen.

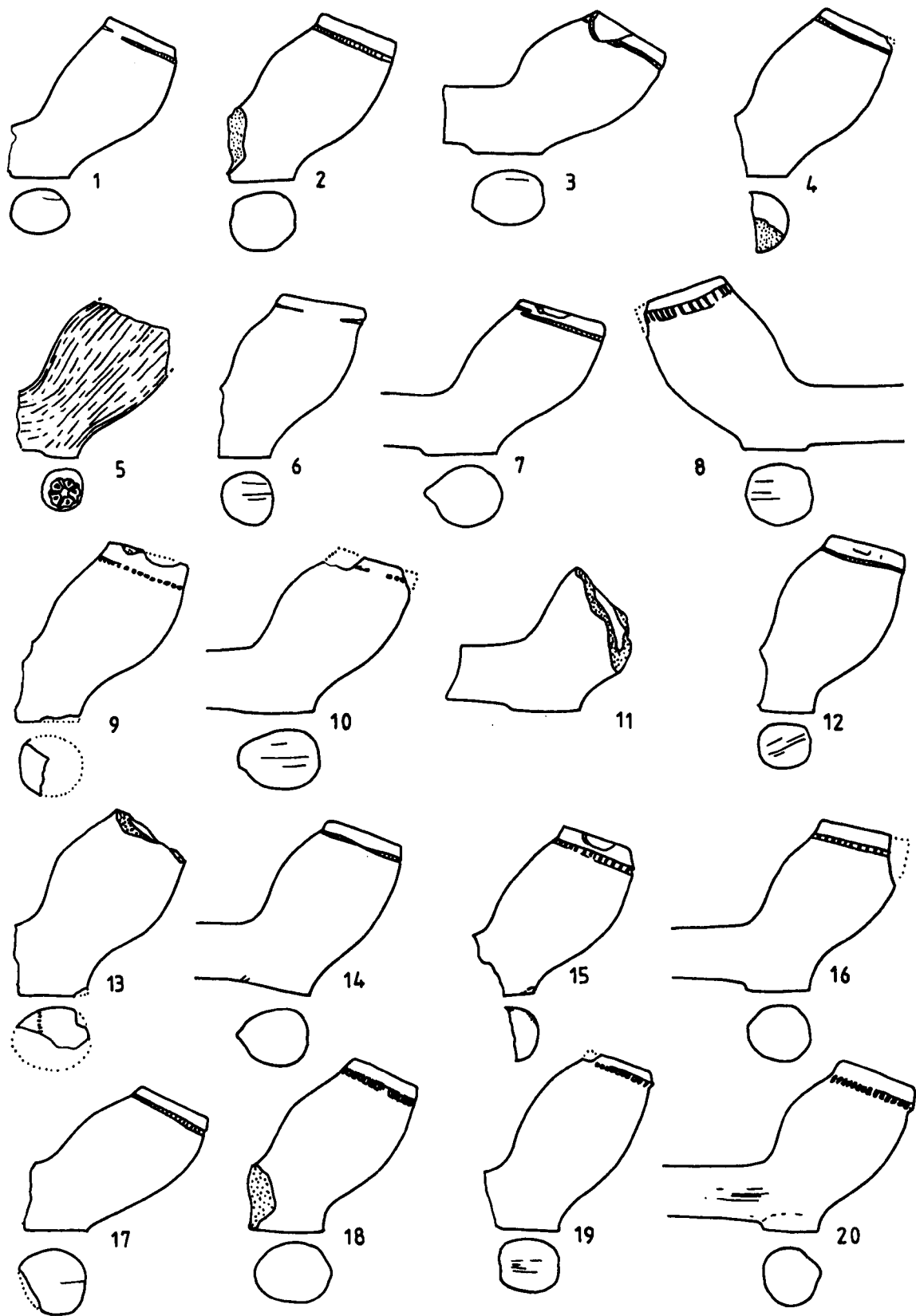
This is most probably Charles Allen who was working in the Castle Garth at Pontefract between 1847 and 1884.

- 176.04 Bowl dating from c1830-1860 from Pontefract Castle (Acc No. 4001: SF No. 2111); rim wiped. Mould decorated bowl fragment with traces of a person smoking a pipe on both sides of the bowl; leaf decorated seams.
- 176.05 Bowl dating from c1850-1900 from Pontefract Castle (Acc No. 001: SF No. 603); rim cut; stem bore 5/64". Mould decorated bowl with a rose and thistle design on both sides; leaf decorated border with shamorcks along the seam facing the smoker.
- 176.06 Bowl dating from c1847-1884 from Pontefract Castle (Acc No. 277: SF No. 2111); rim cut; stem bore 5/64". Mould decorated bowl with flutes and swags on both sides; the moulded initials JA can be seen on both sides of the bowl. This is most probably James Allen who was also working in the Castle Garth at Pontefract between 1847 and 1884.
- 176.07 Bowl dating from c1840-1860 from Pontefract Castle (Acc No. 278: SF No. 2123); rim cut; stem bore 5/64". Composite drawing of a mould decorated bowl with a footballer on either side; stylised leaf decorated seams. Fragments of 21 examples of this design, all from the same mould, were recovered from this context.
- 176.08 Bowl dating from c1820-1850 from Pontefract Castle (Acc No. 086: SF No. 829); rim cut; stem bore 5/64". Mould decorated bowl with Masonic motifs on both sides; the moulded initials IH can be seen near the rim. This is most probably John Haynes of Pontefract who is recorded as working between 1822 and 1844 (Oswald 1975, 200).
- 176.09 Bowl dating from c1830-1860 from Pontefract Castle (Acc No. 240: SF No. 1602); rim cut; stem bore 5/64". Mould decorated bowl with Masonic motifs on both sides. The bowl is slightly distorted and appears to have 'sagged' during firing.
- 176.10 Bowl dating from c1830-1860 from Pontefract Castle (Acc No. 001: SF No. 1325); rim cut. Mould decorated bowl with Masonic motifs on both sides; the moulded initials IH can be seen near the rim. This is most probably John Haynes of Pontefract who is recorded as working between 1822 and 1844 (Oswald 1975, 200).
- 177.01 Bowl dating from c1810-1850 from Pontefract Castle (Acc No. 086: SF No. 829); rim cut; stem bore 5/64". Mould decorated bowl with Masonic motifs on both sides of the bowl.
- 177.02 Bowl dating from c1830-1860 from Pontefract Castle (Acc No. 240: SF No. 1602); rim cut; stem bore 4/64". Mould decorated bowl with Masonic motifs on both sides of the bowl.

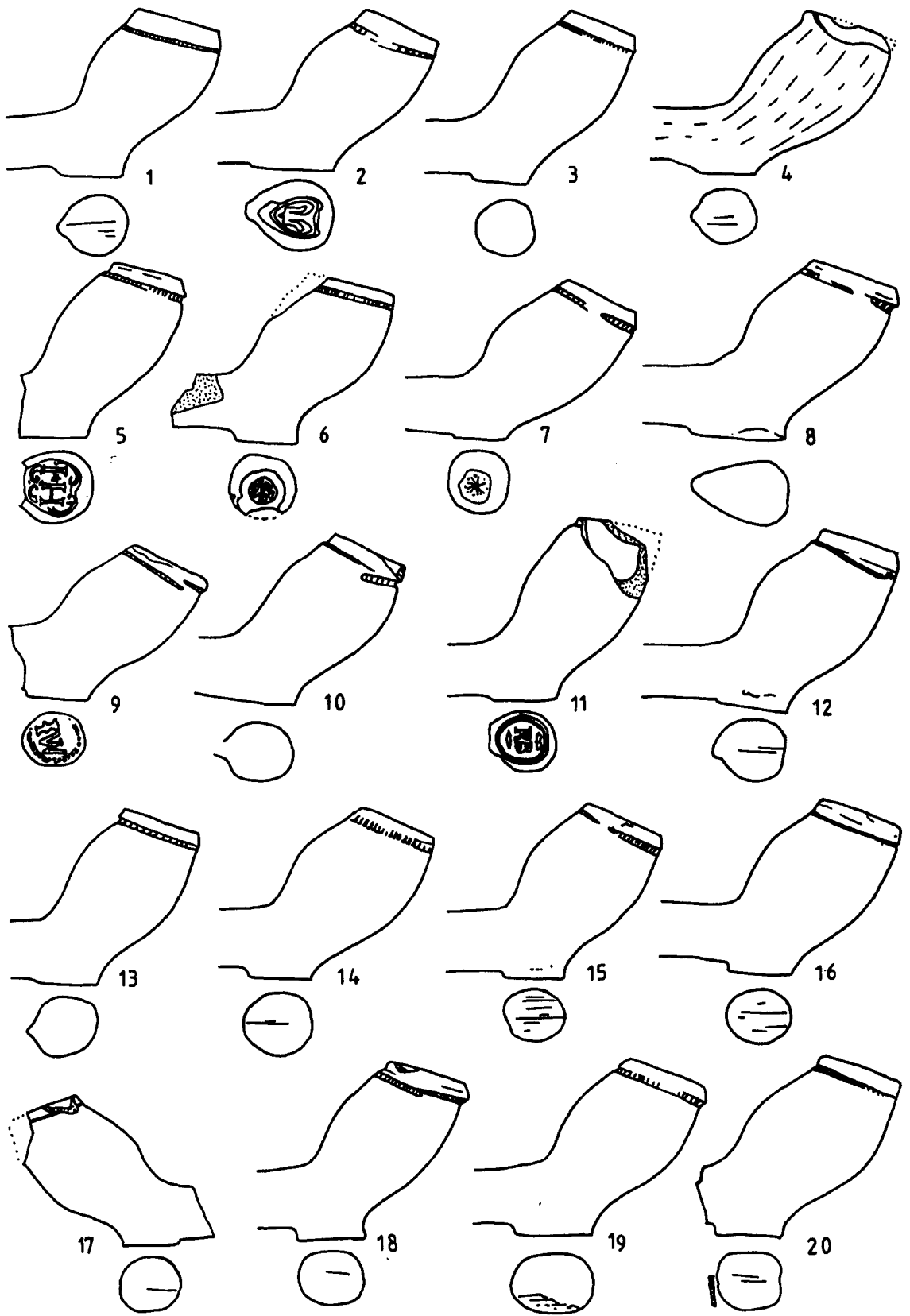
- 177.03 Bowl dating from c1830-1860 from Pontefract Castle (Acc No. 087: SF No. 830); rim cut; stem bore 5/64". Mould decorated bowl with Masonic motifs on both sides of the bowl.
- 177.04 Bowl dating from c1840-1860 from Pontefract Castle (Acc No. 278: SF No. 2123); rim cut; stem bore 5/64". Composite drawing of a plain, spurless bowl with moulded milling and stylised leaf decorated seams. Fragments of 8 examples of this design, all from the same mould, were recovered from this context.
- 177.05 Bowl dating from post 1840 from Pontefract Castle (Acc No. 001: SF No. 192); rim cut; stem bore 5/64". Mould decorated bowl with simplified Prince of Wales Feathers on both sides within a border; leaf decorated seams.
- 177.06 Bowl dating from the late 19th century from Pontefract Castle (Acc No. 086: SF No. 829); rim cut. Mould decorated bowl with a ship on the left and a ?sailor and flag on the right; seams decorated with acorns and oak leaves.
- 177.07 Bowl dating from c1810-1850 from Pontefract Castle (Acc No. 029: SF No. 341); stem bore 4/64". Mould decorated bowl with a standing figure holding a floral wreath; no surviving rim.
- 177.08 Bowl dating from c1847-1884 from Pontefract Castle (Acc No. 001: SF No. 1325); stem bore 5/64". Mould decorated bowl with a sailor on the right and a ship on the left; leaf decorated seams and moulded milling. The initials CA can be seen in either side of the sailor's head. This is most probably Charles Allen who was working in the Castle Garth at Pontefract between 1847 and 1884. One of four examples recovered from the site, all from the same mould.
- 177.09 Bowl dating from c1830-1860 from Pontefract Castle (Acc No. 086: SF No. 631); rim cut; stem bore 5/64". Mould decorated bowl with a sailor on the left and a ship on the right; seams decorated with pellets. There is a mould band running around the bowl just under the rim.
- 177.10 Bowl dating from c1830-1860 from Pontefract Castle (Acc No. 087: SF No. 830); rim cut; stem bore 5/64". Mould decorated bowl with a sailor on the left and a ship on the right; leaf decorated seams. A rosset appears around the sailor and the ship and there is a moulded dot in a circle on the sides of the spur.
- 177.11 Bowl dating from c1830-1860 from Pontefract Castle (Acc No. 087: SF No. 830); stem bore 4/64". Mould decorated bowl with a sailor on the left and a ship on the right; very poorly moulded design. The seams are decorated with leaves and pellets.
- 178.01 Heel type bowl dating from c1640-1660 from Sovereign Street, Leeds (Acc No. SOV98 1293); rim bottered and not milled; stem bore 7/64". Very crudely made. (Pcode 05465).

- 178.02 Heel type bowl dating from c1660-1680 from Sovereign Street, Leeds (Acc No. SOV98 1206); good burnish; rim bottered and three quarters milled; stem bore 6/64". Marked with the initials IW on the heel. (Pcode 02141).
- 178.03 Heel type bowl dating from c1660-1680 from Sovereign Street, Leeds (Acc No. SOV98 1204); good burnish; rim internally trimmed and bottered but not milled; stem bore 7/64". (Pcode 05463).
- 178.04 Heel type bowl dating from c1680-1710 from Sovereign Street, Leeds (Acc No. SOV98 1008); good burnish; rim bottered and milled around all of the surviving rim; stem bore 6/64". (Pcode 25450).
- 178.05 Stem fragment dating from c1680-1720 from Sovereign Street, Leeds (Acc No. SOV98 1000); good burnish; stem bore 7/64". Marked with the initials WH across the stem c26mm from bowl. (Pcode 02142).
- 178.06 Stem fragment dating from c1650-1699 from Sovereign Street, Leeds (Acc No. SOV98 1008); stem bore 5/64". Marked with the initials WH within a heart shaped border across the stem. (Pcode 02143).
- 178.07 Heel type bowl dating from c1700-1770 from Sovereign Street, Leeds (Acc No. SOV98 1159); stem bore 3/64". (Pcode 25451).
- 178.08 Spur type bowl dating from c1820-1860 from Sovereign Street, Leeds (Acc No. SOV98 1061); rim cut and not milled; stem bore 4/64". Very poorly moulded design but appears to depict a female figure holding a banner, on the smokers left, and a ?male figure on the smokers right.
- 178.09 Heel type bowl dating from c1660-1680 from Old Hall Farm (Acc No. OHF96 2004); average burnish; rim bottered and not milled; stem bore 7/64". Marked with the initials IH on the heel. Similar mark and bowl form in Pontefract Museum collections and from the site of Wood Hall Moated Manor. (Pcode 21361).
- 178.10 Heel type bowl dating from c1660-1680 from Old Hall Farm (Acc No. OHF96 4083); average burnish; rim bottered and milled around all of the surviving rim; stem bore 7/64". Marked with the initials IS on the heel. Similar mark and bowl form in Pontefract Museum collections and from the site of Wood Hall Moated Manor. (Pcode 21362).
- 179.01 Heel type bowl dating from c1640-1660 from Radcliffe Place, Wakefield (Acc No. RPW01 U/S); rim bottered and not milled; stem bore 5/64". (Pcode 25325).
- 179.02 Heel type bowl dating from c1640-1660 from Radcliffe Place, Wakefield (Acc No. RPW01 U/S); rim bottered and fully milled; stem bore 6/64". (Pcode 25332).

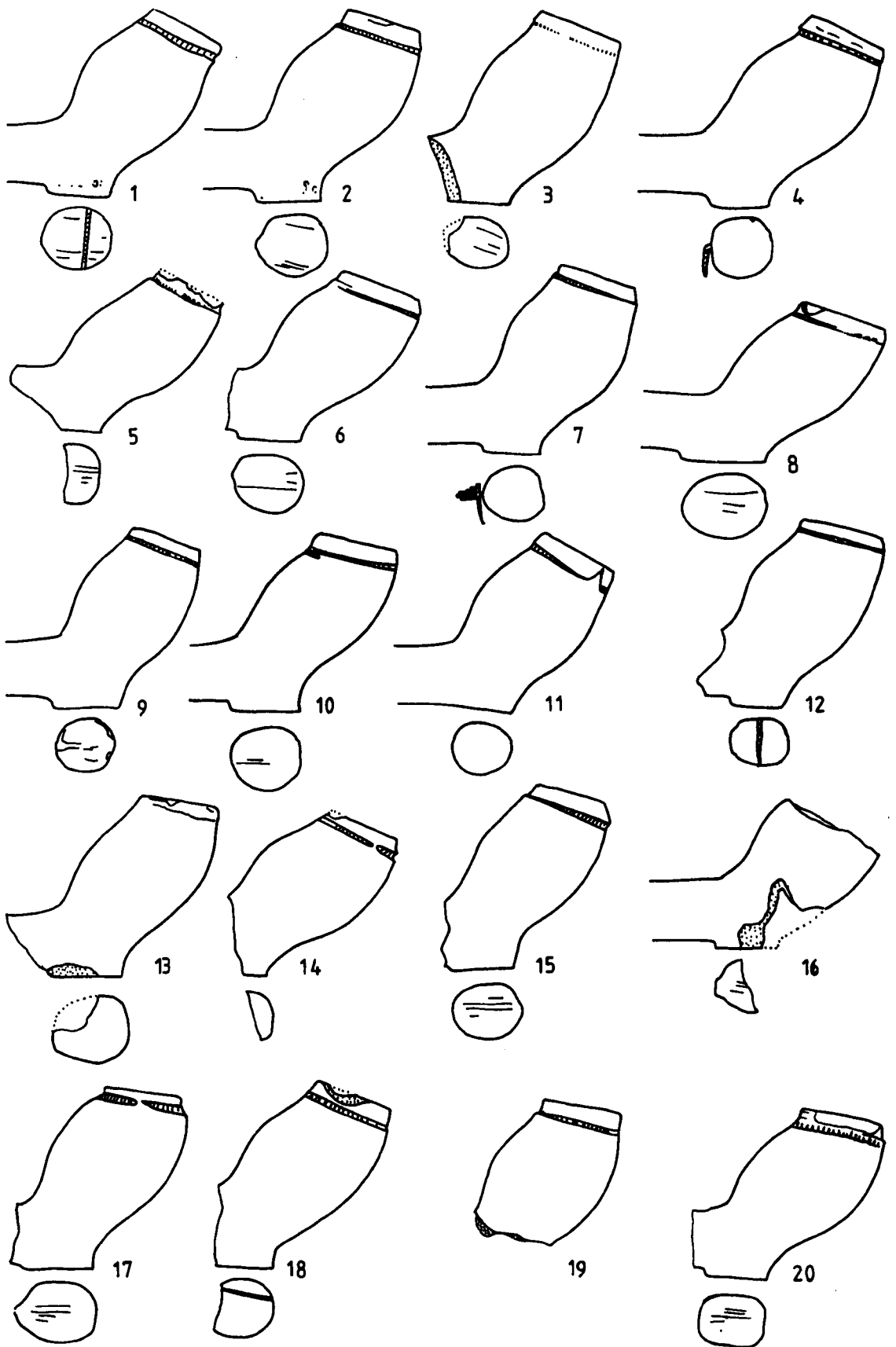
- 179.03 Heel type bowl dating from c1640-1660 from Radcliffe Place, Wakefield (Acc No. RPW01 U/S); rim internally trimmed, bottered and half milled; stem bore 6/64". (Pcode 25329).
- 179.04 Heel type bowl dating from c1640-1660 from Radcliffe Place, Wakefield (Acc No. RPW01 U/S); rim internally trimmed, bottered and half milled; stem bore 6/64". (Pcode 25342).
- 179.05 Spur type bowl dating from c1640-1660 from Radcliffe Place, Wakefield (Acc No. RPW01 U/S); rim internally trimmed, bottered and half milled; stem bore 7/64". Two joining fragments. (Pcode 25343).
- 179.06 Heel type bowl dating from c1640-1660 from Radcliffe Place, Wakefield (Acc No. RPW01 U/S); rim internally trimmed, bottered and three quarters milled; stem bore 7/64". Burnt. (Pcode 25344).
- 179.07 Heel type bowl dating from c1640-1660 from Radcliffe Place, Wakefield (Acc No. RPW01 U/S); good burnish; rim bottered and milled around all of the surviving rim; stem bore 7/64". Possibly Dutch. (Pcode 25345).
- 179.08 Stem fragment bowl dating from c1680-1720 from Radcliffe Place, Wakefield (Acc No. RPW01 U/S); finely burnished; stem bore 5/64". Marked with the initials IG across the stem. Possibly one of the Gill family. (Pcode 25346).
- 179.09 Heel type bowl dating from c1690-1720 from Radcliffe Place, Wakefield (Acc No. RPW01 U/S); rim wiped but not milled; stem bore 5/64". (Pcode 25341).
- 179.10 Heel type bowl dating from c1640-1670 from Site 52, Bingley (Acc No. BIN99 Site 52); rim bottered and milled around all of the surviving rim; stem bore 6/64". Very micaceous fabric. (Pcode 24965).
- 179.11 Spur type bowl dating from c1700-1720 from Site 38, Bingley (Acc No. BIN99 Site 38); rim wiped but not milled; stem bore 5/64". Wiped rim that may also have been bottered; very micaceous fabric. (Pcode 24964).



**Figure 168:** Pipes recovered from excavations by the West Yorkshire Archaeological Services. Scale 1:1. All illustrations by the author but reproduced by kind permission of WYAS.

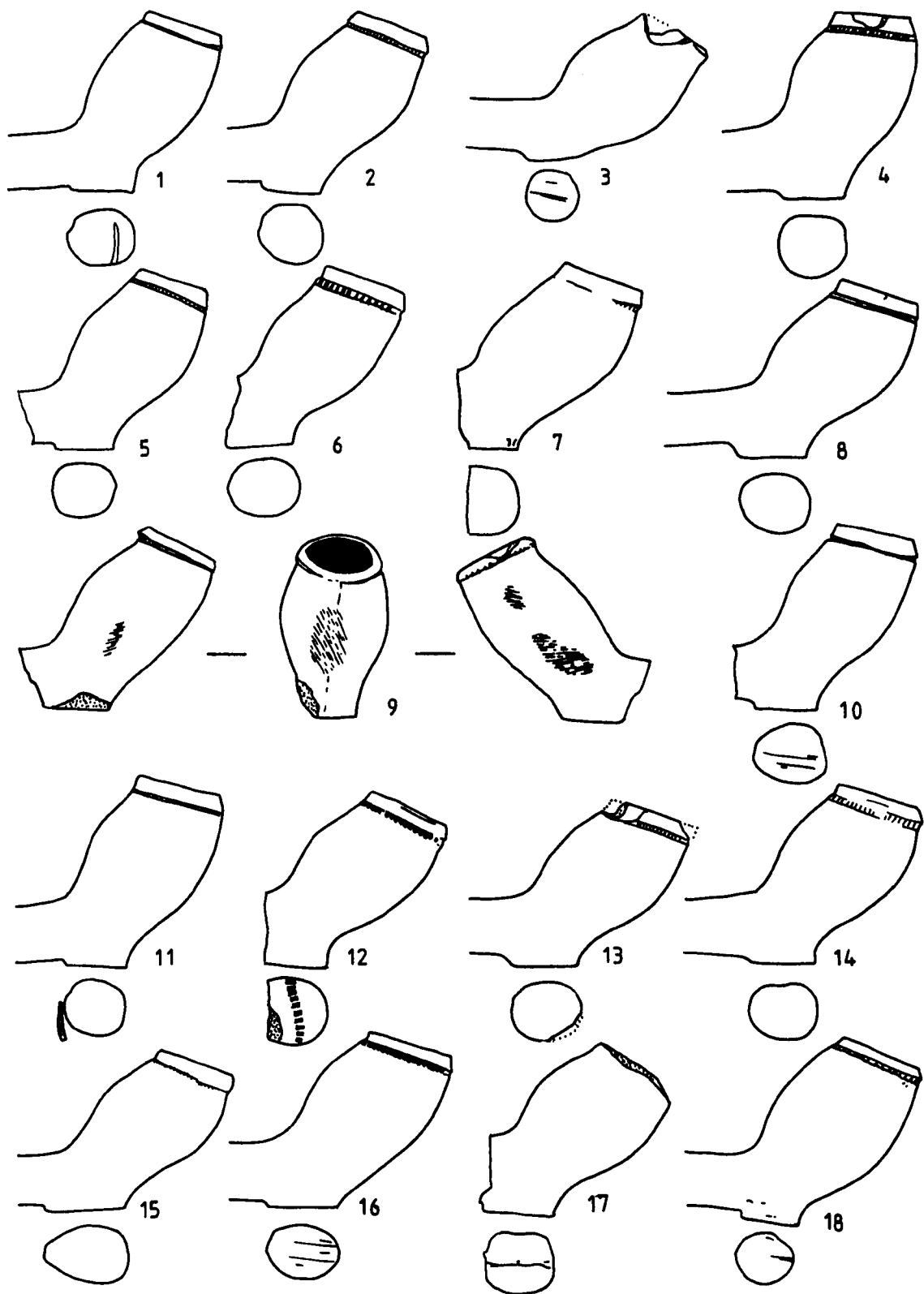


**Figure 169:** Pipes recovered from excavations by the West Yorkshire Archaeological Services. Scale 1:1. All illustrations by the author but reproduced by kind permission of WYAS.

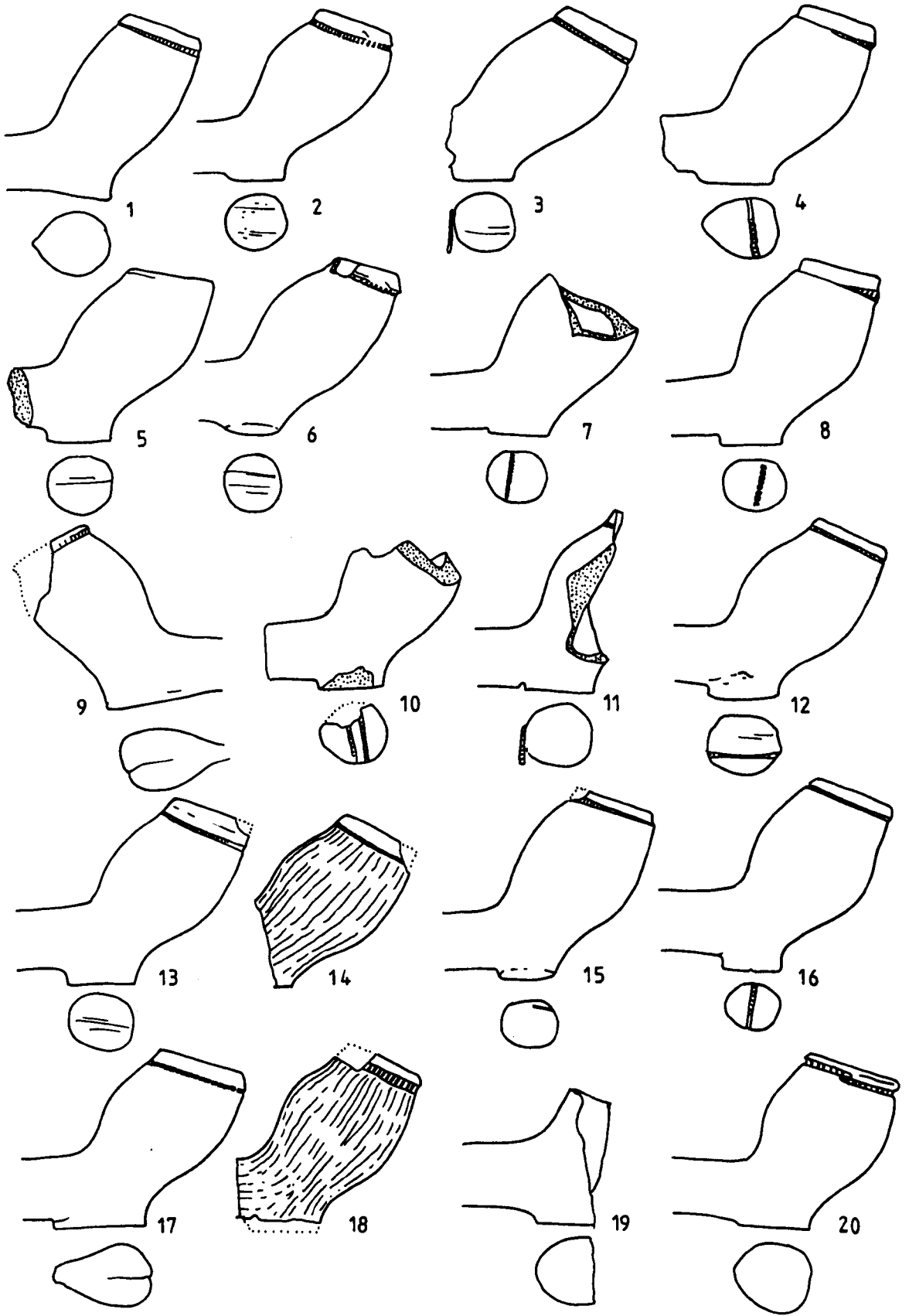


**Figure 170:** Pipes recovered from excavations by the West Yorkshire Archaeological Services. Scale 1:1. All illustrations by the author but reproduced by kind permission of WYAS.

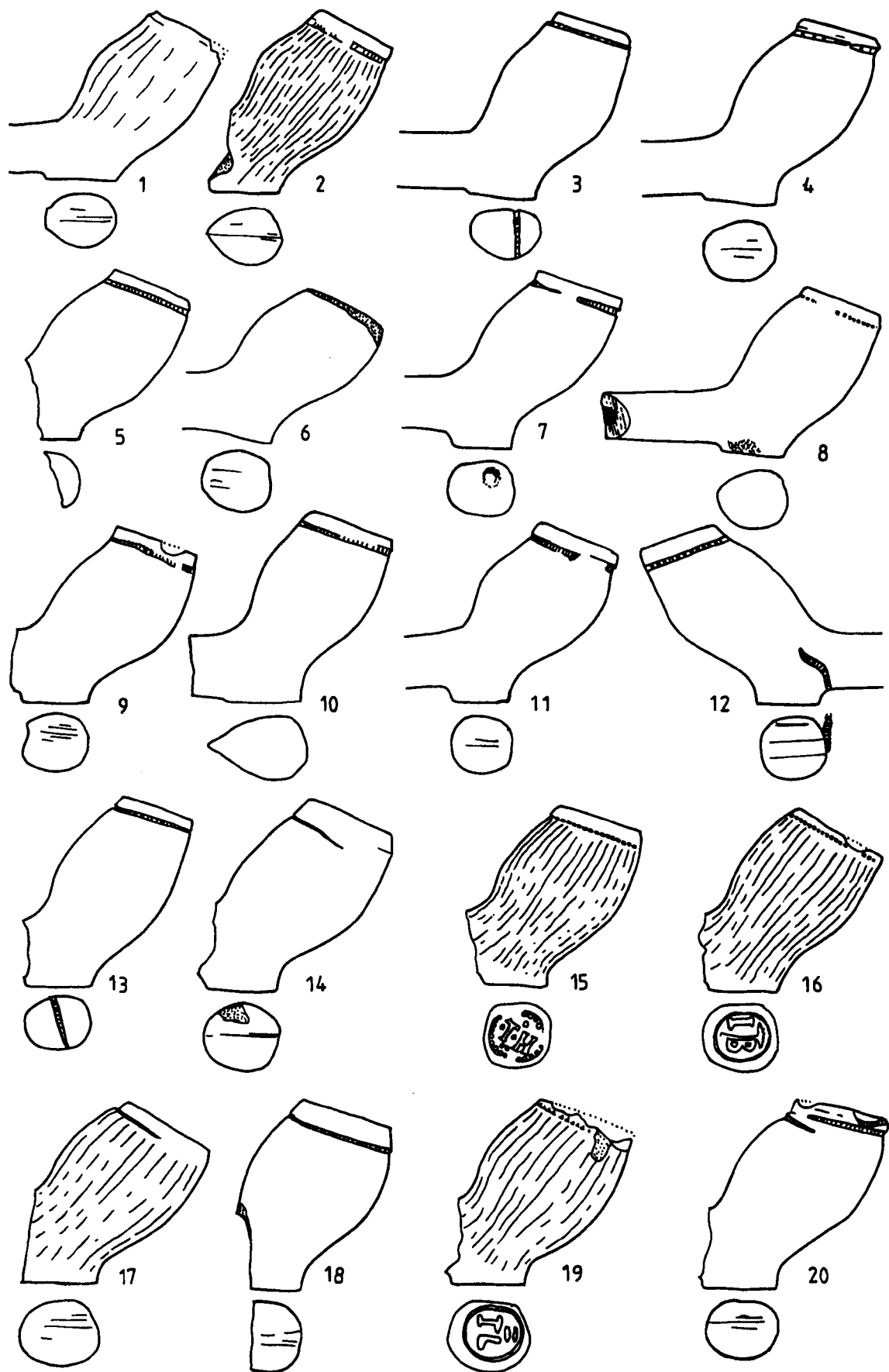




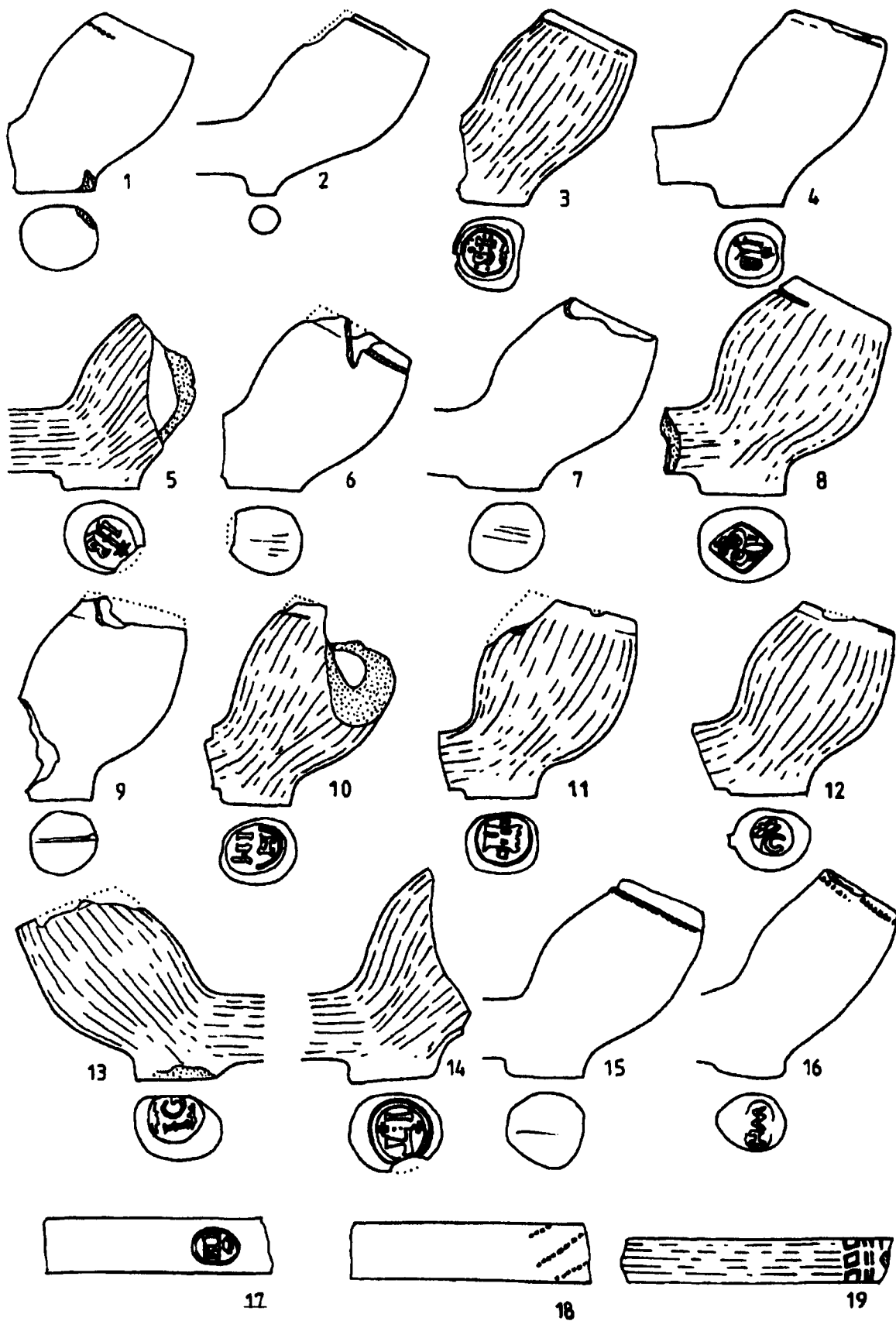
**Figure 171:** Pipes recovered from excavations by the West Yorkshire Archaeological Services. Scale 1:1. All illustrations by the author but reproduced by kind permission of WYAS.



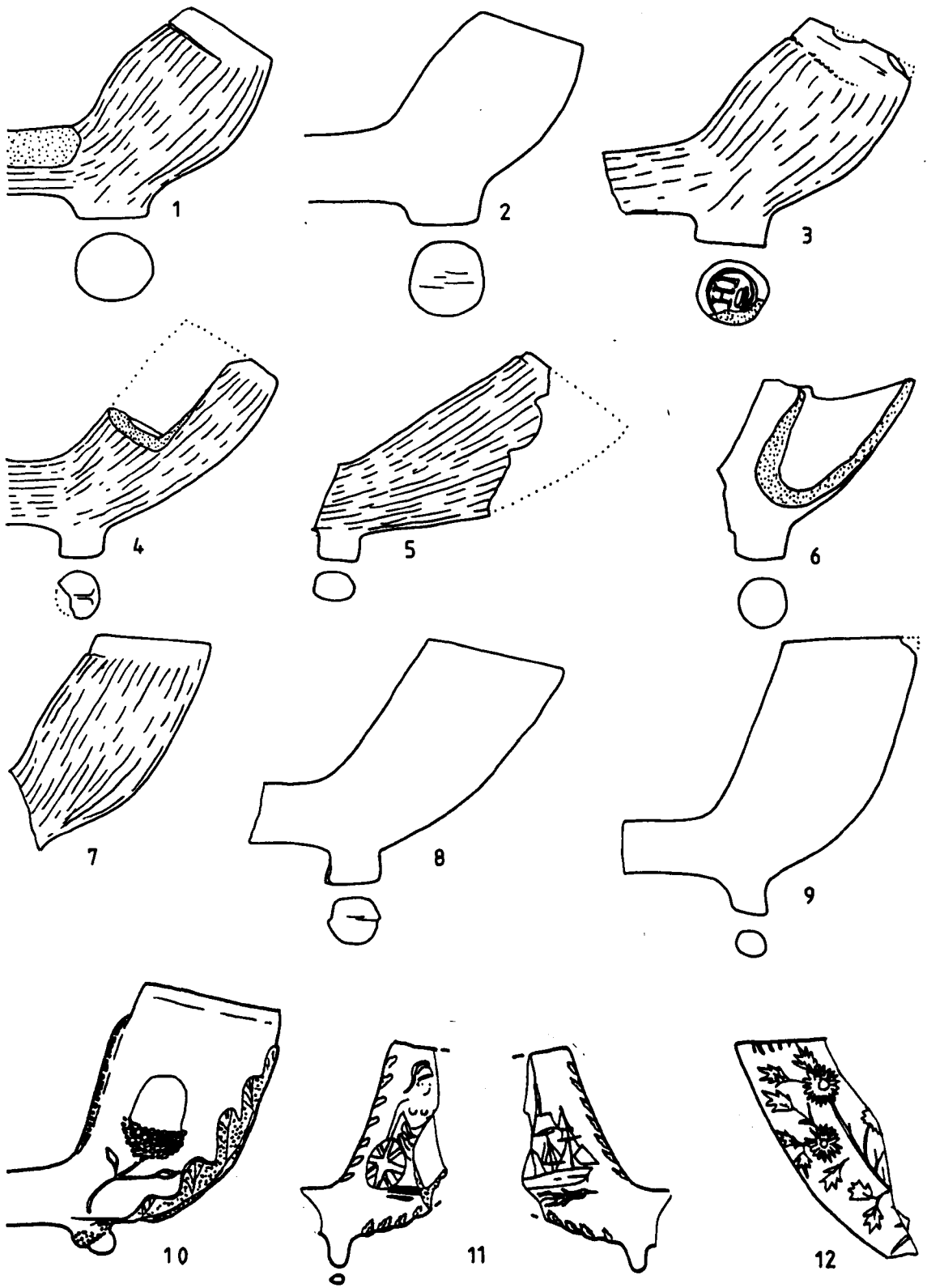
**Figure 172:** Pipes recovered from excavations by the West Yorkshire Archaeological Services. Scale 1:1. All illustrations by the author but reproduced by kind permission of WYAS.



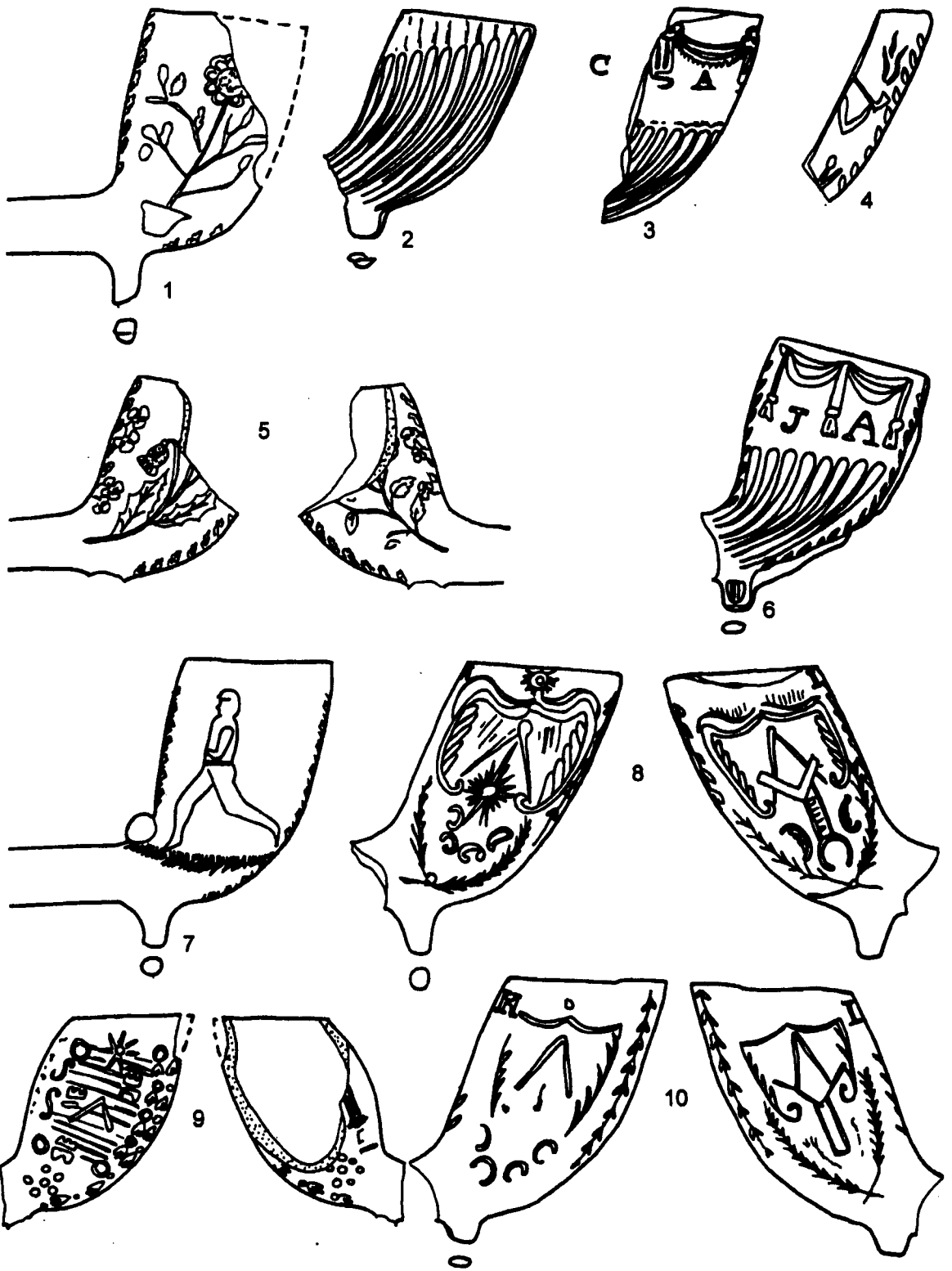
**Figure 173:** Pipes recovered from excavations by the West Yorkshire Archaeological Services. Scale 1:1. All illustrations by the author but reproduced by kind permission of WYAS.



**Figure 174:** Pipes recovered from excavations by the West Yorkshire Archaeological Services. Scale 1:1. All illustrations by the author but reproduced by kind permission of WYAS.



**Figure 175:** Pipes recovered from excavations by the West Yorkshire Archaeological Services. Scale 1:1. All illustrations by the author but reproduced by kind permission of WYAS.



**Figure 176:** Pipes recovered from excavations by the West Yorkshire Archaeological Services. Scale 1:1. All illustrations by the author but reproduced by kind permission of WYAS.

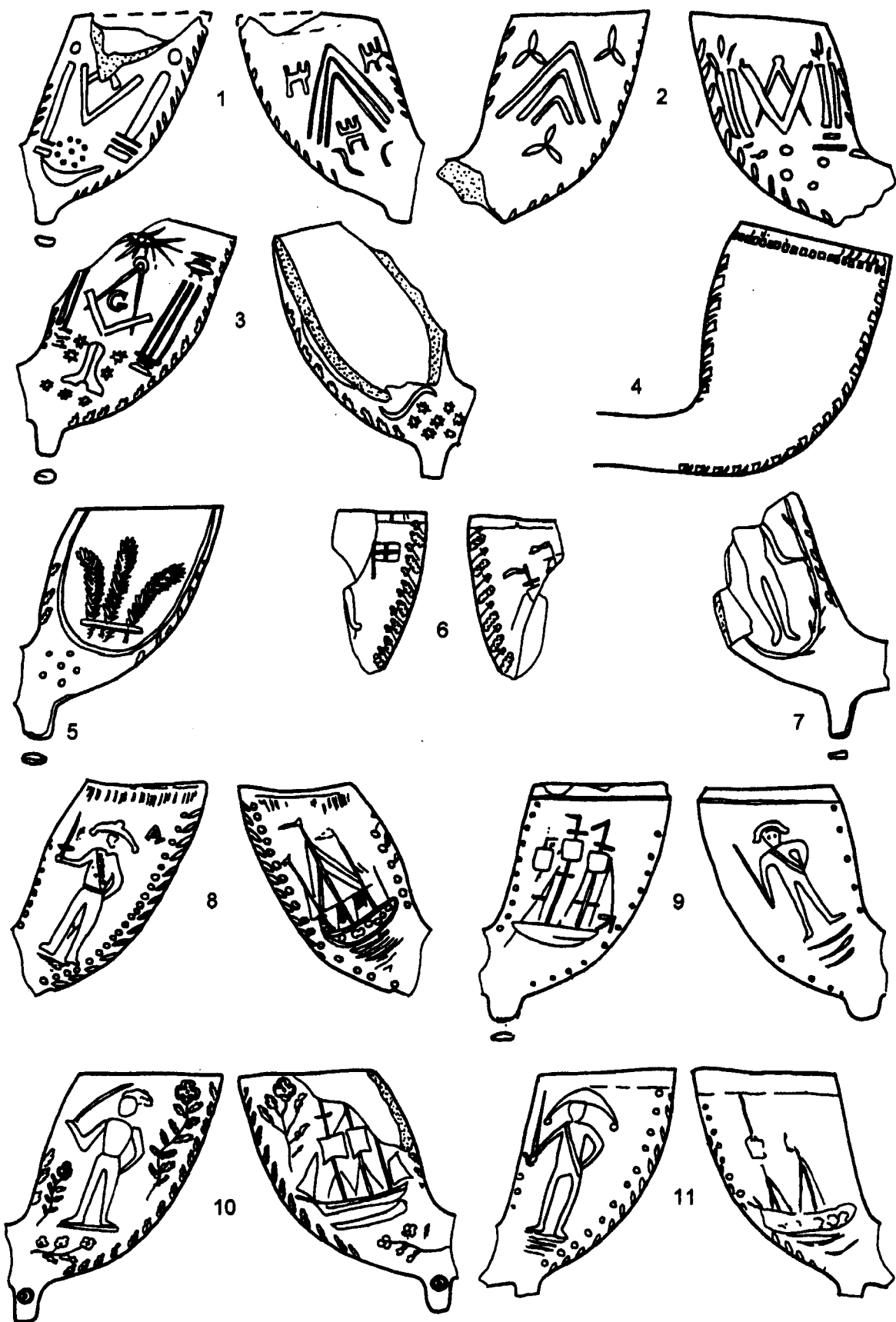
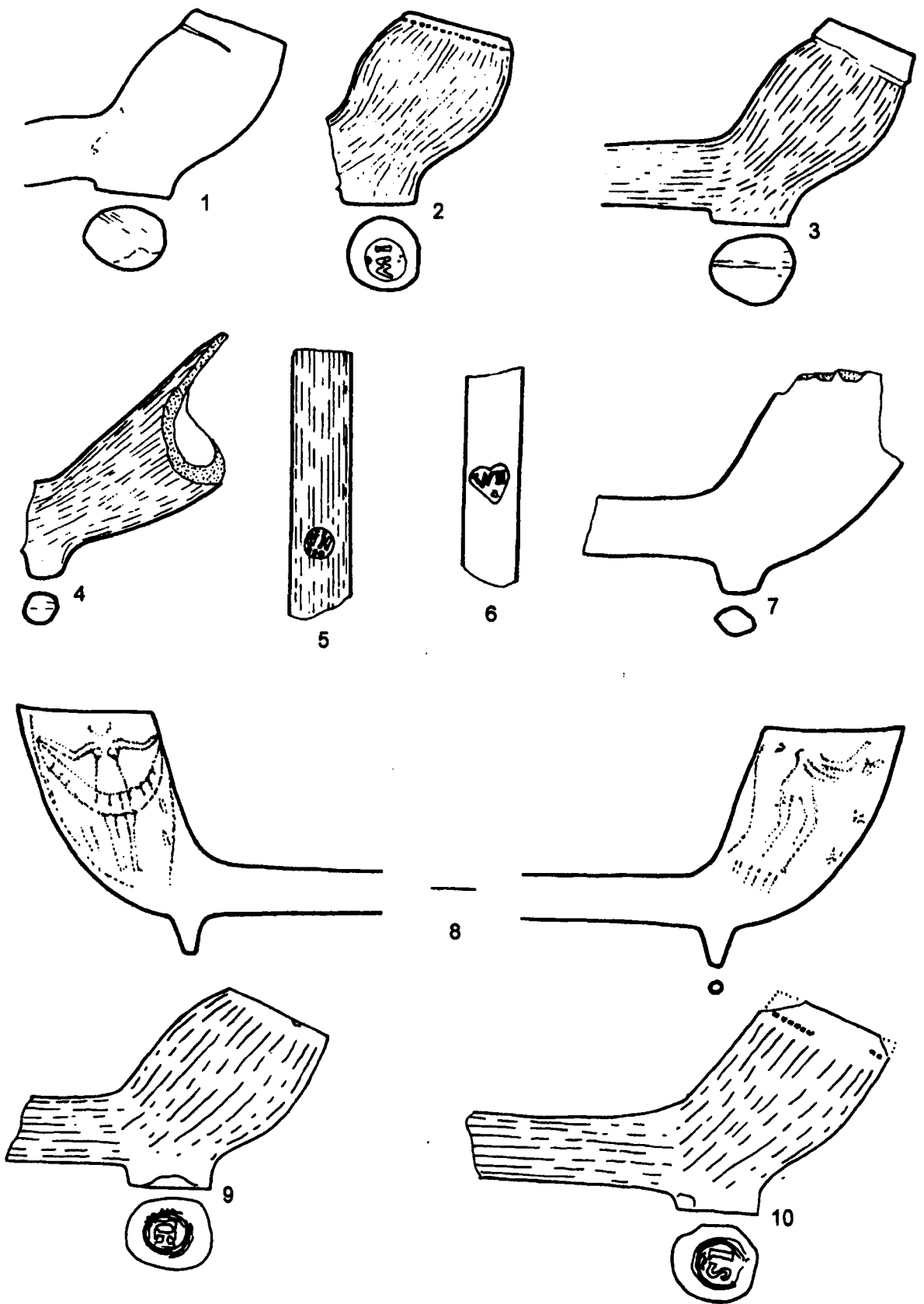
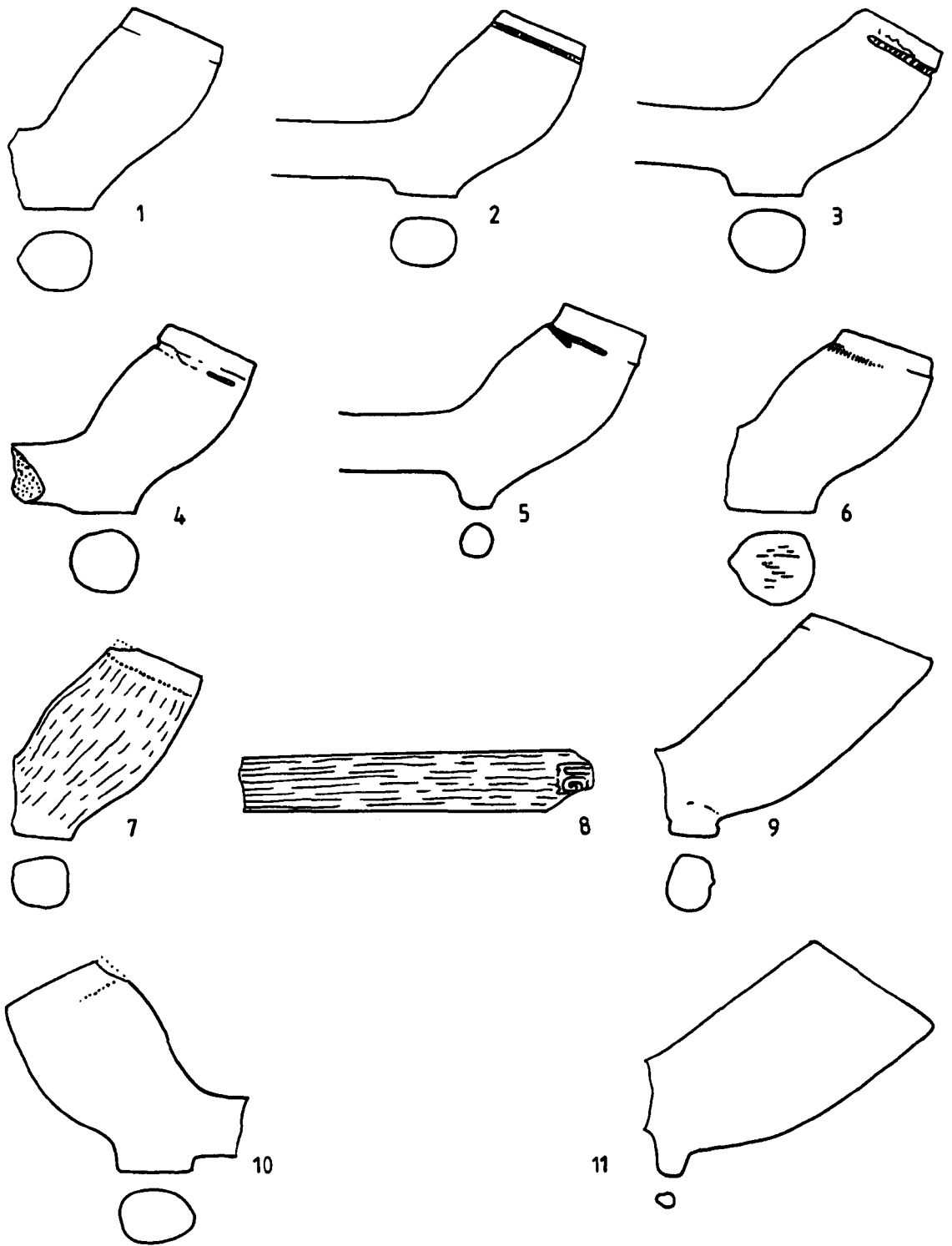


Figure 177: Pipes recovered from excavations by the West Yorkshire Archaeological Services. Scale 1:1. All illustrations by the author but reproduced by kind permission of WYAS.



**Figure 178:** Pipes recovered from excavations by the West Yorkshire Archaeological Services. Scale 1:1. All illustrations by the author but reproduced by kind permission of WYAS.





**Figure 179:** Pipes recovered from excavations by the West Yorkshire Archaeological Services. Scale 1:1. All illustrations by the author but reproduced by kind permission of WYAS.

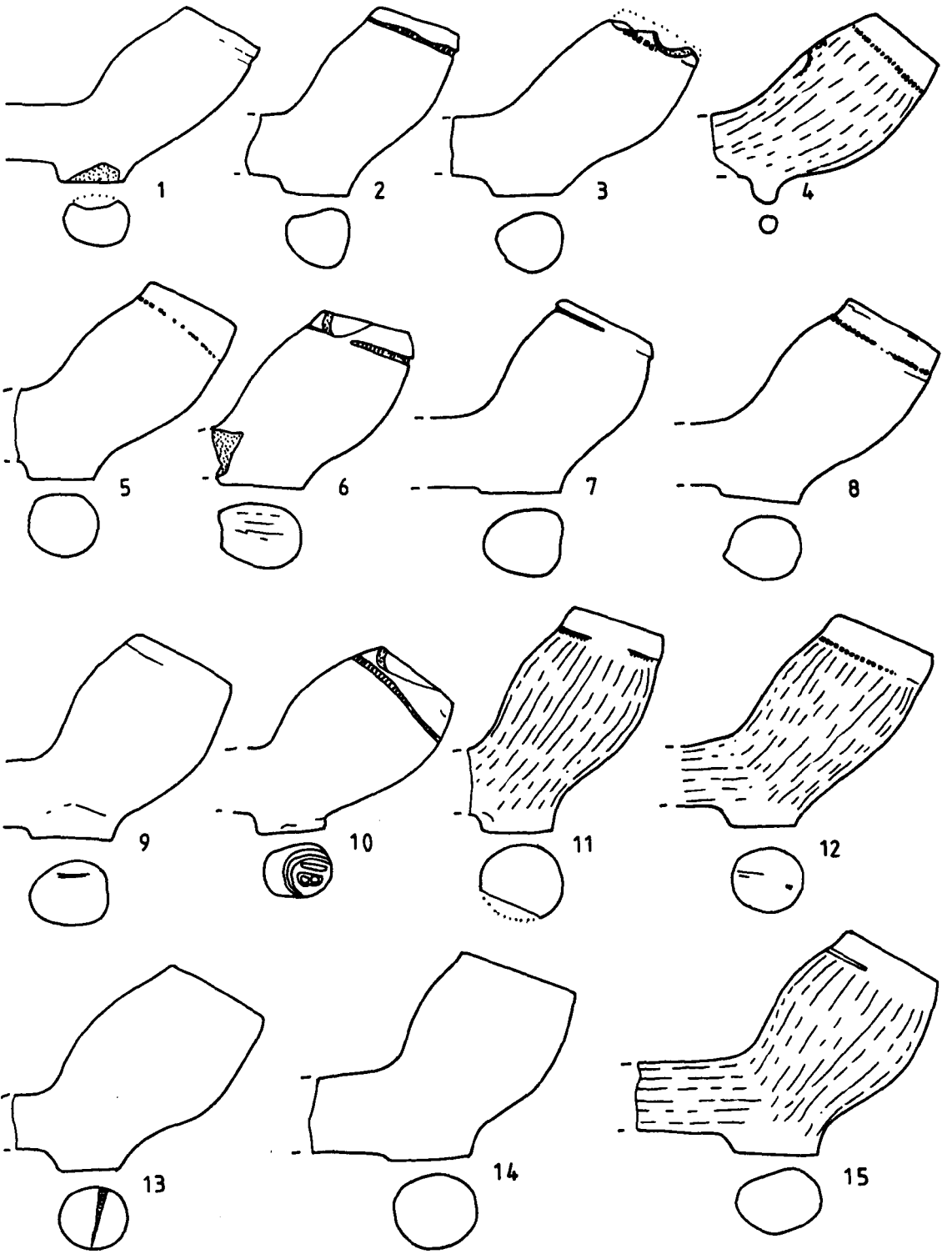
**Collection Name:** Mayfield Collection  
**Collection Code:** 0235  
**Contact Name:** Mr H Mayfield  
**Address:** Wrenthorpe, West Yorkshire

**Description:**

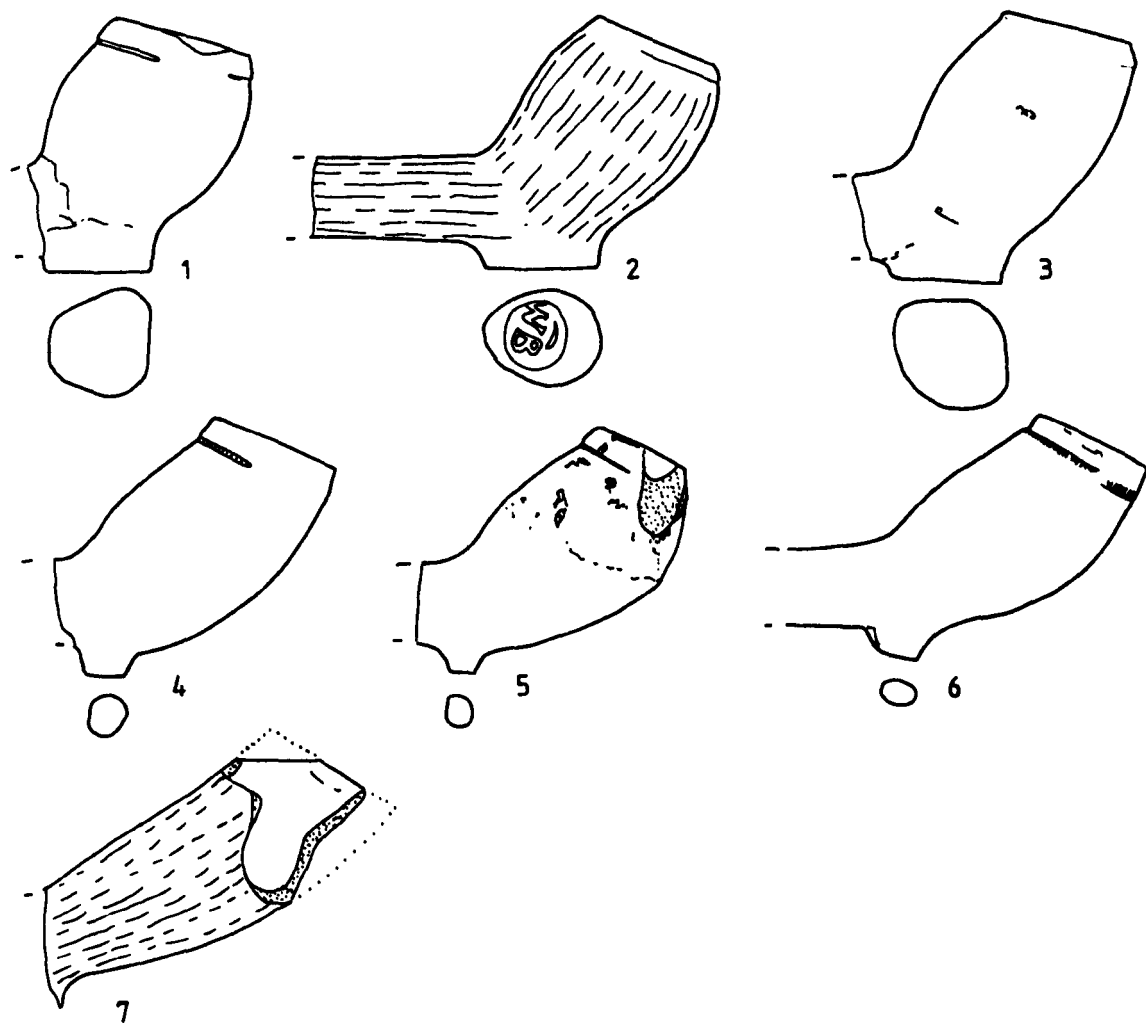
A private collection of seventeenth-century clay tobacco pipes discovered in Mr Mayfield's garden when digging a foundation trench for an extension to his house. A total of 33 mid to late seventeenth-century bowls were recorded in detail for inclusion in the Yorkshire Database. Almost all the bowls range from c1640-1670 and reportedly came from a discrete layer, interpreted as kiln waste although no obvious wasters or kiln debris was collected. The group included a nineteenth-century stem and bowl fragments.

- 180.01 Heel type bowl dating from c1640-1660; rim bottered; stem bore 5/64". Very highly fired; heavily encrusted. (Pcode 21190).
- 180.02 Heel type bowl dating from c1640-1660; rim bottered and fully milled; stem bore 6/64". (Pcode 21182).
- 180.03 Heel type bowl dating from c1640-1660; stem bore 5/64". (Pcode 21191).
- 180.04 Spur type bowl dating from c1640-1660; average burnish; rim internally trimmed and bottered and half milled; stem bore 6/64". Marked with the initials PL on the bowl facing the smoker. Rainford type. (Pcode 21192).
- 180.05 Heel type bowl dating from c1640-1660; rim internally trimmed and bottered and fully milled; stem bore 5/64". (Pcode 21184).
- 180.06 Heel type bowl dating from c1640-1660; rim bottered and fully milled; stem bore 8/64". (Pcode 21185).
- 180.07 Heel type bowl dating from c1650-1670; rim bottered but not milled; stem bore 5/64". (Pcode 21209).
- 180.08 Heel type bowl dating from c1660-1680; rim internally trimmed and bottered and fully milled; stem bore 7/64". (Pcode 21198).
- 180.09 Heel type bowl dating from c1650-1670; rim bottered but not milled; stem bore 6/64". (Pcode 21208).
- 180.10 Heel type bowl dating from c1640-1660; rim bottered and half milled; stem bore 6/64". Marked with the initials IB on the heel. Possible Rainford type. (Pcode 21193).
- 180.11 Heel type bowl dating from c1640-1660; good burnish; rim internally trimmed and bottered and fully milled; stem bore 7/64". Same mould as Pcode 21187. (Pcode 21186).

- 180.12 Heel type bowl dating from c1640-1660; good burnish; rim bottered and fully milled; stem bore 7/64". (Pcode 21188).
- 180.13 Heel type bowl dating from c1660-1680; rim bottered; stem bore 7/64". Milled heel Bowl encrusted so cannot tell if it is burnished. (Pcode 21213).
- 180.14 Heel type bowl dating from c1660-1680; rim internally trimmed and bottered but not milled; stem bore 6/64". (Pcode 21211).
- 180.15 Heel type bowl dating from c1660-1680; average burnish; rim bottered but not milled; stem bore 7/64". Pink fabric. (Pcode 21197).
- 181.01 Heel type bowl dating from c1660-1680; rim internally trimmed and bottered but not milled; stem bore 5/64". Very bulbous and very crudely made. (Pcode 21199).
- 181.02 Heel type bowl dating from c1660-1680; good burnish; rim internally trimmed and bottered but not milled; stem bore 5/64". Marked with the initials WB on the heel. (Pcode 21194).
- 181.03 Heel type bowl dating from c1660-1680; rim internally trimmed and bottered but not milled; stem bore 7/64". Quite poorly made. (Pcode 21210).
- 181.04 Spur type bowl dating from c1660-1680; rim bottered and fully milled; stem bore 7/64". Pink fabric. (Pcode 21201).
- 181.05 Spur type bowl dating from c1660-1680; stem bore 7/64". Waster very highly fired and distorted. (Pcode 21202).
- 181.05 Spur type bowl dating from c1660-1680; rim bottered and half milled; stem bore 7/64". (Pcode 21203).
- 181.07 Spur type bowl dating from c1690-1720; good burnish; rim internally trimmed and bottered; milled around all of the surviving rim stem bore 6/64". (Pcode 21214).



**Figure 180:** Pipes held by the Mayfield Collection, Wrenthorpe. Scale 1:1.



**Figure 181:** Pipes held by the Mayfield Collection, Wrenthorpe. Scale 1:1.

**Collection Name:** Richardson Collection  
**Collection Code:** 0252  
**Contact Name:** Mr Sam Richardson  
**Address:** Wrenthorpe, West Yorkshire

**Description:**

Private collection recorded by J M Clay and published as *Clay pipes from Wrenthorpe* in an un-named journal/newsletter. Two pipes were chosen for inclusion in the Yorkshire database, both stamped with the initials MP on the heel.

None illustrated.

**Collection Name:** Unknown  
**Collection Code:** 0001  
**Contact Name:** N/A  
**Address:** N/A

**Description:**

The details of a total of 265 pipes are included in the Yorkshire Database from an unknown or unspecified collections. The details for the majority of these pipes have been drawn from published sources or from photographs and sketches. All details, however slight, relating to either the collection or the provenance is given in the comments section for each individual pipe fragment.

None illustrated.

### **Appendix 3: Collection Summaries – Part II**

Part II of this appendix contains details those collections that have been recorded as part of the National Clay Tobacco Pipe Stamp Catalogue that contain Yorkshire material, which has then been extracted for inclusion in the Yorkshire database. For each collection the name, collection code, contact name and address has been given and, where known, a brief summary of the nature of each collection is also given. A limited selection of illustrations of any seventeenth- or eighteenth-century pipes is provided where they exist. The collections are arranged alphabetically by place, i.e. county then town, with all United Kingdom collections given first.

**Collection Name:** Oswald Collection  
**Collection Code:** 0066  
**Contact Name:** Mr Adrian Oswald  
**Address:** Cottenham, Cambridgeshire

**Description:**

A substantial private collection recorded for the National Stamp Catalogue. As of in November 2001 the collection is believed to be in the care of Richard Le Cheminant in London.

Only one pipe was selected from the NSC database for inclusion in the Yorkshire database. A further 28 Yorkshire pipes found outside the county of Yorkshire are recorded in Oswald's Pipe Stamp Index.

**Collection Name:** Grosvenor Museum

**Collection Code:** 0107

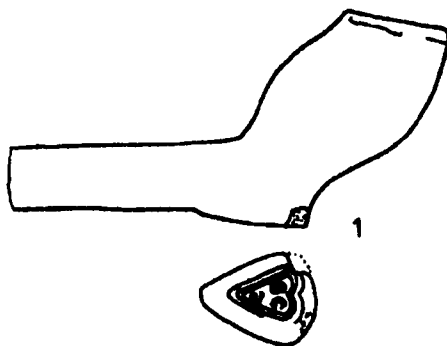
**Contact Name:** Julie Edwards

**Address:** Chester, Cheshire

**Description:**

Collection recorded for the National Stamp Catalogue. A single stamped bowl dating from c1640-1660 was selected for inclusion in the Yorkshire Database.

182.01 Heel type bowl dating from c1640-1660 from Hamilton Place (Acc No. CHE/12HP92 1119); rim bottered but not milled; stem bore 8/64". Marked with the initials GC on the heel. (Pcode 08514).



*Figure 182: Pipe from the collections of the Grosvenor Museum, Chester. Scale 1:1.*

**Collection Name:** Cleveland County Archaeology Unit

**Collection Code:** 0039

**Contact Name:** Blaise Vyner

**Address:** Middlesborough, Cleveland

**Description:**

Collection recorded for the National Stamp Catalogue. A total of 5 pipes were selected for inclusion in the Yorkshire database

**Collection Name:** Carlisle Archaeological Unit

**Collection Code:** 0104

**Contact Name:** Mr Michael McCarthy

**Address:** Carlisle, Cumbria

**Description:**

Collection recorded for the National Stamp Catalogue. NSC database searched for Yorkshire material and five pipes were selected for inclusion in the Yorkshire database.



**Collection Name:** Carlisle Museum & Art Gallery

**Collection Code:** 0103

**Contact Name:**

**Address:** Carlisle, Cumbria

**Description:**

Collection recorded for the National Stamp Catalogue. NSC database searched for Yorkshire material and two pipes were selected for inclusion in the Yorkshire database.

**Collection Name:** Abbot Hall Art Gallery & Museum

**Collection Code:** 0097

**Contact Name:** Miss V A J Slowe

**Address:** Kendal, Cumbria

**Description:**

A total of 11 stamped pipes were selected all unprovenanced but thought to be from the Kendal area.

**Collection Name:** Royal Albert Memorial Museum

**Collection Code:** 0060

**Contact Name:** Mr John Allan

**Address:** Exeter, Devon

**Description:**

Collection recorded for the National Stamp Catalogue. Only three pipes selected for inclusion in the Yorkshire database all believed to originate from Hull.

**Collection Name:** Austin Collection

**Collection Code:** 0152

**Contact Name:** Professor D. Austin

**Address:** Lampeter, Dyfed

**Description:**

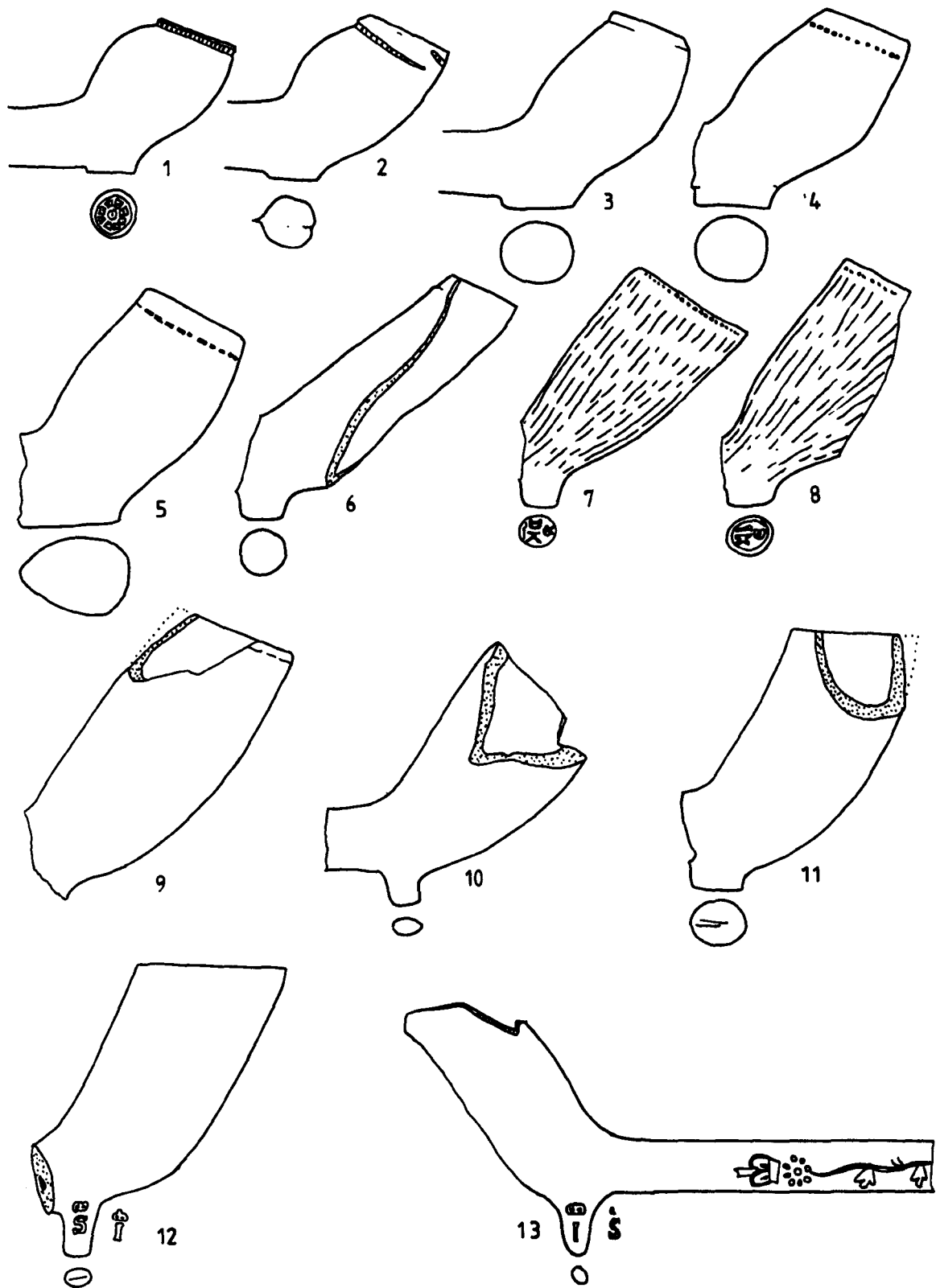
Collection recorded for the National Stamp Catalogue. Group of excavation clay tobacco pipes from Hartlepool Southgate were selected for inclusion in the Yorkshire Database.

183.01 Heel type bowl dating from c1610-1640 from Hartlepool Southgate (Acc No. HLS73 SG 133); rim bottered and fully milled. Marked with a wheel on the heel. (Pcode 03417).

183.02 Heel type bowl dating from c1640-1660 from Hartlepool Southgate (Acc No. HLS73 SG 1); rim bottered and fully milled. (Pcode 08542).

183.03 Heel type bowl dating from c1640-1680 from Hartlepool Southgate (Acc No. HLS73 SG 165); rim bottered but not milled; stem bore 5/64". (Pcode 08080).

- 183.04 Heel type bowl dating from c1640-1670 from Hartlepool Southgate (Acc No. HLS73 SG 1); rim bottered and fully milled. (Pcode 08075).
- 183.05 Heel type bowl dating from c1640-1670 from Hartlepool Southgate (Acc No. HLS73 SG 1); rim bottered and three quarters milled. (Pcode 08074).
- 183.06 Heel type bowl dating from c1690-1710 from Hartlepool Southgate (Acc No. HLS73 SG 1); rim bottered but not milled. (Pcode 08544).
- 183.07 Heel type bowl dating from c1700-1740 from Hartlepool Southgate (Acc No. HLS73 SG); finely burnished; rim bottered and fully milled. Marked with the crowned initials DK on the heel. Dutch. (Pcode 03416).
- 183.08 Heel type bowl dating from c1690-1740 from Hartlepool Southgate (Acc No. HSL73 SG 156); average burnish; rim bottered and half milled. Marked with the initials DIK on the heel. (Pcode 03420).
- 183.09 Spur type bowl dating from c1690-1720 from Hartlepool Southgate (Acc No. HLS73 SG 220); rim bottered but not milled. Spur broken. (Pcode 08543).
- 183.10 Spur type bowl dating from c1690-1710 from Hartlepool Southgate (Acc No. HLS73 SG 1); stem bore 6/64". (Pcode 08541).
- 183.11 Heel type bowl dating from c1710-1740 from Hartlepool Southgate (Acc No. HLS73 SG 144); rim cut but not milled. (Pcode 08079).
- 183.12 Spur type bowl dating from c1740-1800 from Hartlepool Southgate (Acc No. HLS73 SG 80); rim cut but not milled; stem bore 5/64". Marked with the crowned initials IS on the sides of the spur. (Pcode 08082).
- 183.13 Spur type bowl dating from c1740-1800 from Hartlepool Southgate (Acc No. HLS73 SG US); stem bore 6/64". Marked with the crowned initials IS. Mould decorated stem. (Pcode 08083).



**Figure 183:** Pipes from the Austin Collections recovered from excavations in Hartlepool. Scale 1:1.

**Collection Name:** Lampeter Arch Unit  
**Collection Code:** 0035  
**Contact Name:** David Austin  
**Address:** Lampeter, Dyfed

**Description:**

Collection recorded for the National Stamp Catalogue. A total of four stamped pipes were selected for inclusion in the Yorkshire Database.

**Collection Name:** Brackenridge Collection  
**Collection Code:** 0248  
**Contact Name:** Professor Celia Brackenridge  
**Address:** Gloucester

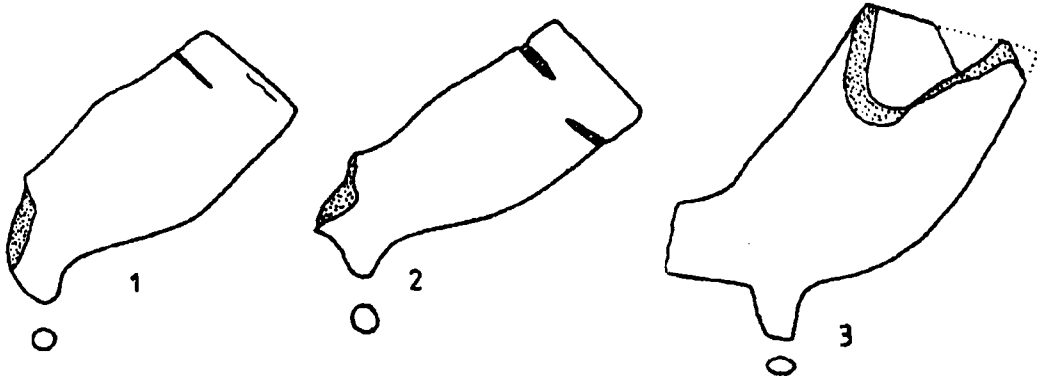
**Description:**

Collection recorded for the National Stamp Catalogue. NSC database searched for Yorkshire material and three pipes were selected for inclusion in the Yorkshire database.

184.01 Spur type bowl dating from c1650-1680 from Cherry Tree House, Cherry Tree Road, Nether Edge; rim bottered and fully milled; stem bore  $7/64''$ . Does not appear to be a Yorkshire form. (Pcode 25112).

184.02 Spur type bowl dating from c1650-1680 from Cherry Tree House, Cherry Tree Road, Nether Edge; rim bottered and three quarters milled; stem bore  $7/64''$ . Does not appear to be a Yorkshire form. (Pcode 25111).

184.03 Spur type bowl dating from c1690-1720 from Cherry Tree House, Cherry Tree Road, Nether Edge; rim cut but not milled; stem bore  $4/64''$ . Does not appear to be a Yorkshire form. (Pcode 25113).



*Figure 184: Pipes from the Brackenridge Collection. Scale 1:1*

**Collection Name:** Salford Museum & Art Gallery  
**Collection Code:** 0093  
**Contact Name:** Miss E Vigeon  
**Address:** Salford, Greater Manchester

**Description:**

Collection recorded for the National Stamp Catalogue. Four possible Yorkshire pipes were selected from the NSC database for inclusion in the Yorkshire database.

**Collection Name:** Central Excavation Unit (HMBC)

**Collection Code:** 0111

**Contact Name:** Mr Jon Humble (Finds Officer)

**Address:** Portsmouth, Hampshire

**Description:**

Collection recorded for the National Stamp Catalogue. NSC database searched for Yorkshire material and 29 pipes were selected for inclusion in the Yorkshire database.

**Collection Name:** Davey Collection

**Collection Code:** 0069

**Contact Name:** Dr P J Davey

**Address:** Ballaugh, Isle of Man

**Description:**

Collection recorded for the National Stamp Catalogue. A single stamped bowl dating from c1640-1660 was selected for inclusion in the Yorkshire Database.

**Collection Name:** Fox Collection

**Collection Code:** 0119

**Contact Name:** Mr Fox

**Address:** Walton, Nr. Lutterworth, Leicestershire

**Description:**

Collection recorded for the National Stamp Catalogue. A single stamped bowl dating from c1660-1690 was selected for inclusion in the Yorkshire Database.

**Collection Name:** English Heritage

**Collection Code:** 0198

**Contact Name:**

**Address:** London

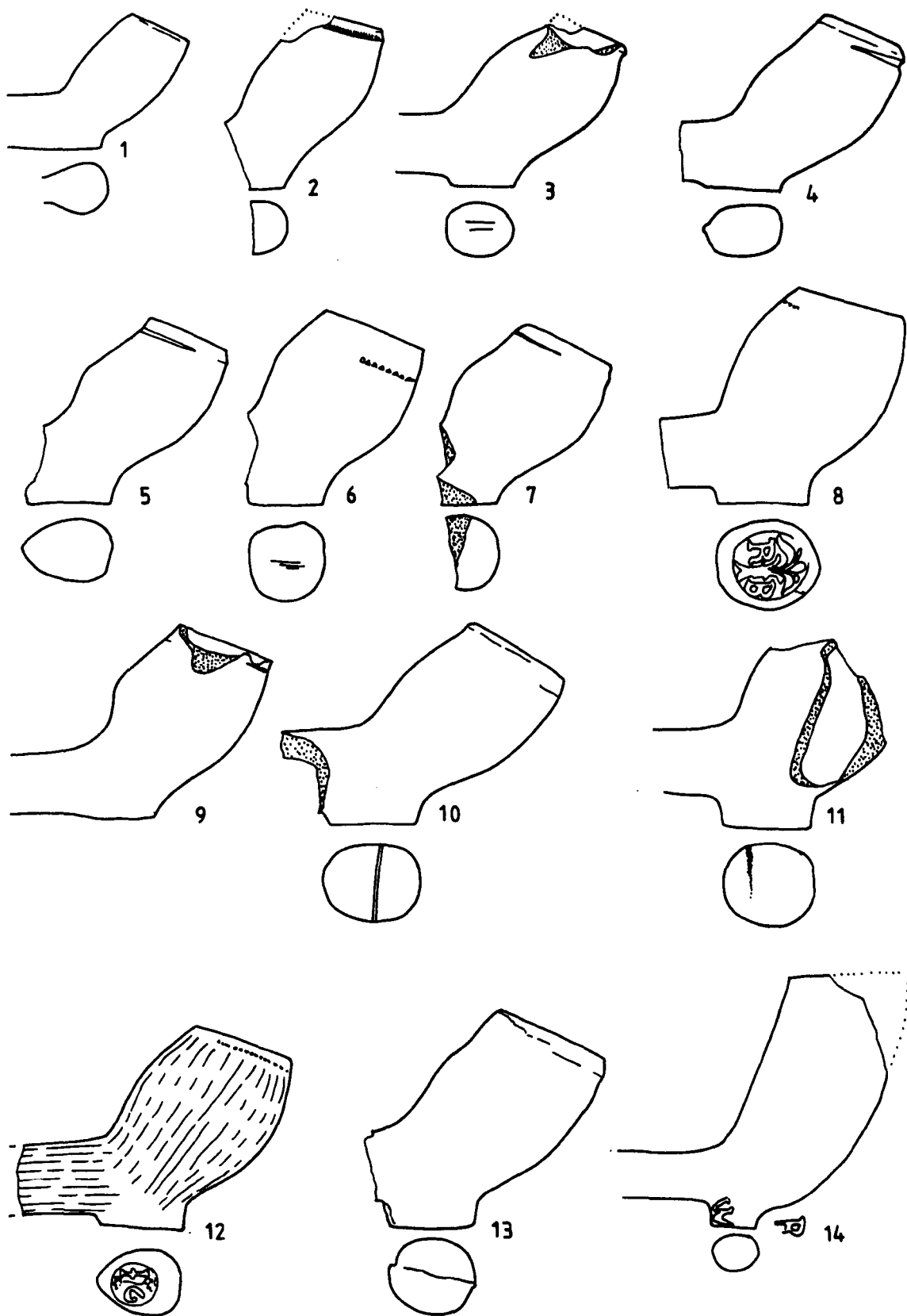
**Description:**

Collection recorded for the National Stamp Catalogue. A total of 38 pipes, the majority of which were recovered from Wharram Percy, were selected for inclusion in the Yorkshire database

185.01 Heel type bowl dating from c1580-1610 from Wharram Percy (Acc No. WP83/54/17); rim bottered and not milled; stem bore 7/64". (Pcode 23539).

185.02 Heel type bowl dating from c1630-1650 from Wharram Percy (Acc No. WP88/74/106); rim bottered; milled around all of the surviving rim; stem bore 7/64". (Pcode 23528).

- 185.03 Heel type bowl dating from c1640-1660 from Wharram Percy (Acc No. WP88/74/284); rim bottered and not milled; stem bore 7/64". (Pcode 23519).
- 185.04 Heel type bowl dating from c1640-1660 from Wharram Percy (Acc No. WP89/74/299); rim bottered; stem bore 7/64". Groove round rim rather than milling. (Pcode 23522).
- 185.05 Heel type bowl dating from c1640-1660 from Wharram Percy (Acc No. WP88/74/287); rim bottered; stem bore 7/64". Groove rather than milling;. (Pcode 23532).
- 185.06 Heel type bowl dating from c1650-1670 from Wharram Percy (Acc No. WP89/74/349); rim bottered and one quarter milled; stem bore 7/64". (Pcode 23516).
- 185.07 Heel type bowl dating from c1650-1670 from Wharram Percy (Acc No. WP88/74/286); rim bottered and not milled; stem bore 7/64". (Pcode 23520).
- 185.08 Heel type bowl dating from c1660-1690 from Wharram Percy (Acc No. WP87/77/304); good burnish; rim bottered and one quarter milled; stem bore 7/64". Marked with the initials RB on the heel. (Pcode 23512).
- 185.09 Heel type bowl dating from c1660-1680 from Wharram Percy (Acc No. WP88/74/106); rim bottered; milled around all of the surviving rim; stem bore 7/64". Very crudely made; indent in bowl facing the smoker caused by very rough trimming. (Pcode 23529).
- 185.10 Heel type bowl dating from c1660-1690 from Wharram Percy (Acc No. WP76/30/25); rim bottered and not milled; stem bore 7/64". Cut mark on the heel. Very shiny surface but no obvious burnishing lines; cut mark on heel; very heavy and chunky feel to the pipe. (Pcode 23513).
- 185.11 Heel type bowl dating from c1660-1690 from Wharram Percy (Acc No. WP89/74/321); stem bore 6/64". Milled heel. Very bulbous bowl; no rim surviving. (Pcode 23521).
- 185.12 Heel type bowl dating from c1660-1680 from Wharram Percy (Acc No. WP89/74/275); average burnish; rim bottered and half milled; stem bore 7/64". Marked with the initials IG on the heel. Possibly one of the Gills of Wakefield. (Pcode 23534).
- 185.13 Heel type bowl dating from c1660-1680 from Wharram Percy (Acc No. WP81/54/202); rim bottered and not milled; stem bore 7/64". (Pcode 23538).
- 185.14 Heel type bowl dating from c1750-1780 from Wharram Percy (Acc No. WP80/54/5); rim cut and not milled; stem bore 4/64". Marked with the initials RW on the sides of the heel. (Pcode 23536).



**Figure 185:** Pipes held by English Heritage from excavations at Wharram Percy. Scale 1:1.

**Collection Name:** Elkins Collection

**Collection Code:** 0077

**Contact Name:** Mr Peter Elkins

**Address:** Acton, London

**Description:**

Private collection recorded for the National Stamp Catalogue. NSC database searched for Yorkshire material and two pipes were selected for inclusion in the Yorkshire database.

**Collection Name:** North West Archaeological Trust (NWAT)

**Collection Code:** 0222

**Contact Name:** Mr P Davey

**Address:** Liverpool, Merseyside

**Description:**

Collection recorded for the National Stamp Catalogue. In the early 1990s the Trust folded and some of the collections formerly held by them passed on to other organisations such as the National Clay Tobacco Pipe Archive, Cheshire Museum Service and to Liverpool Museum services (National Museums and Galleries on Merseyside). Where the ultimate destination of the pipes from the NWAT is known a new collection code has been allocated, however if the current location of the pipe is not known it remains listed under the NWAT.

In total 71 seventeenth- and early eighteenth-century pipes were selected from the NSC for inclusion in the Yorkshire Database. The majority date from the first half of the seventeenth century.

186.01 Heel type bowl dating from c1620-1640 from Scarborough Barbican (Acc No. SGAE); rim bottered and fully milled; bore 7/64". (Pcode 03495).

186.02 Heel type bowl dating from c1620-1640 from Scarborough Barbican (Acc No. SGAH); rim bottered and fully milled; bore 6/64". (Pcode 03503).

186.03 Heel type bowl dating from c1630-1660 from Scarborough Barbican (Acc No. SGAD); finely burnished; bore 7/64". Marked with what appears to be the lettering 4S on the heel. Possibly Dutch. (Pcode 01985).

186.04 Heel type bowl dating from c1630-1660 from Scarborough Barbican (Acc No. SGAH); bore 7/64". (Pcode 03500).

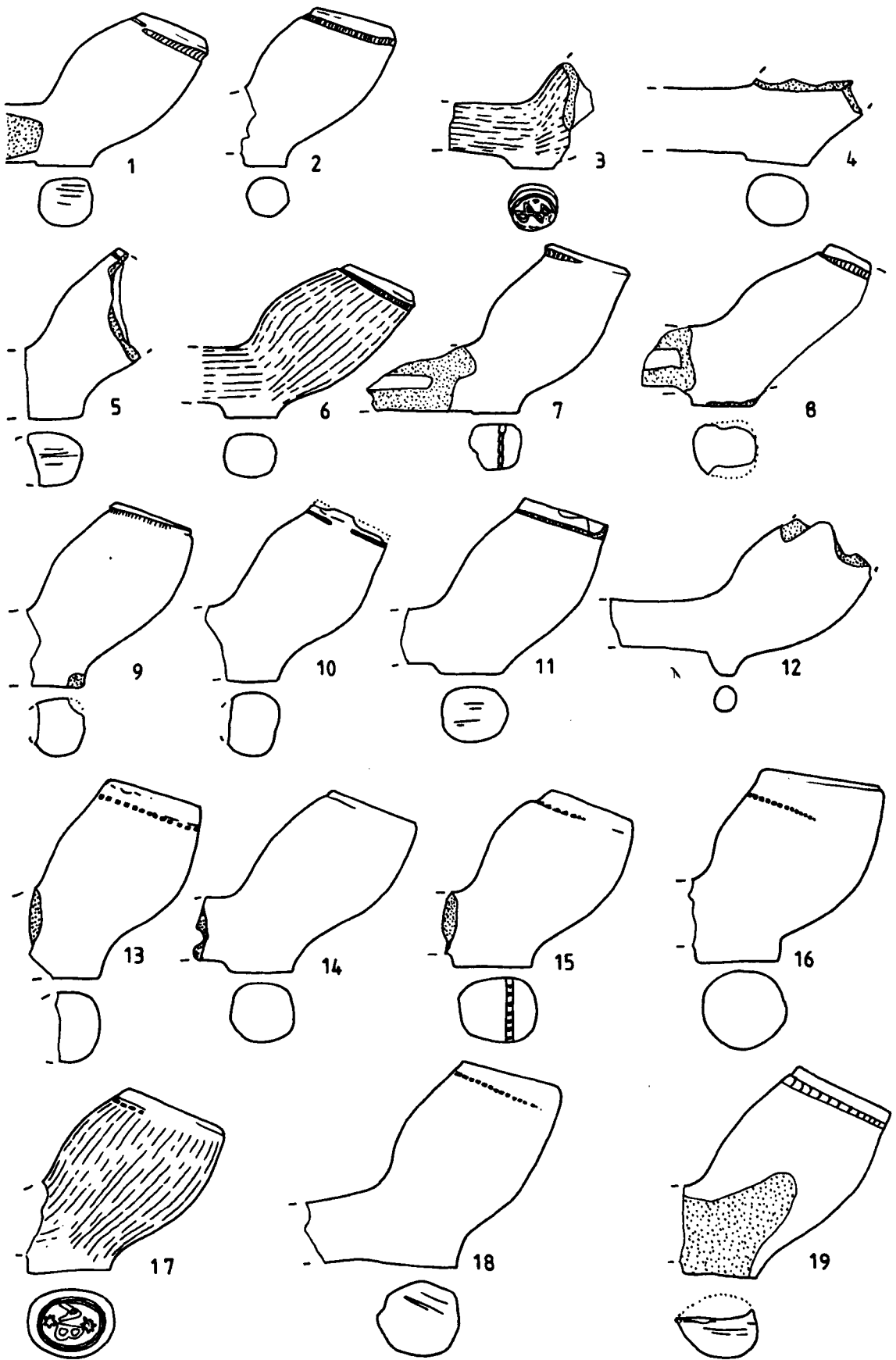
186.05 Heel type bowl dating from c1640-1660 from Scarborough Barbican (Acc No. SGAB); rim bottered but not milled; bore 7/64". (Pcode 03486).

186.06 Heel type bowl dating from c1640-1660 from Scarborough Barbican (Acc No. SGAT); finely burnished; rim bottered and three quarters milled; bore 7/64". Very smooth surface but not burnished; possibly Dutch. (Pcode 03516).

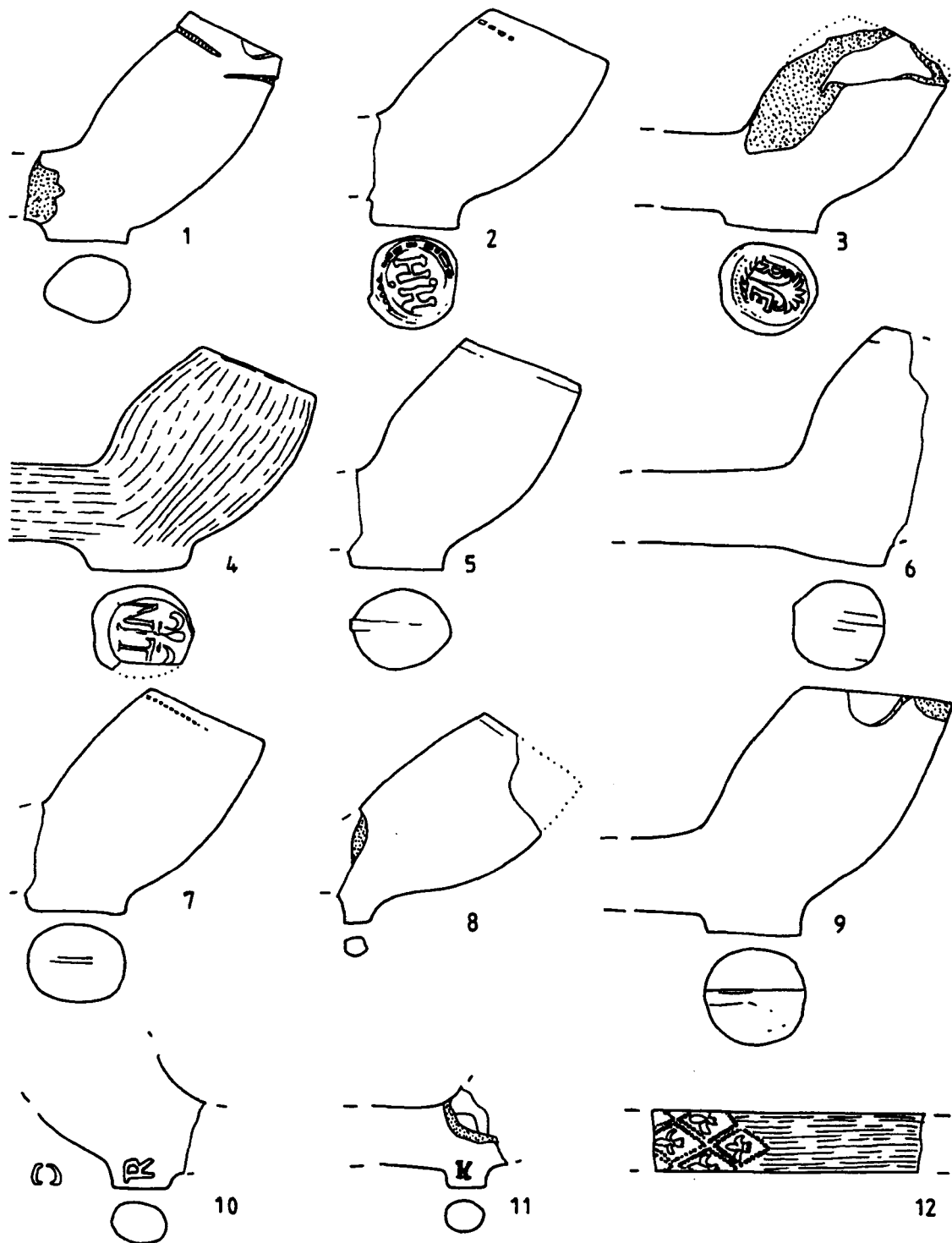


- 186.07 Heel type bowl dating from c1640-1660 from Scarborough Barbican (Acc No. SGBE); rim bottered and one quarter milled; bore 7/64". Milled heel. (Pcode 01987).
- 186.08 Heel type bowl dating from c1640-1660 from Scarborough Barbican (Acc No. SGAB); rim bottered; milled around all of the surviving rim; bore 6/64". (Pcode 03485).
- 186.09 Heel type bowl dating from c1640-1660 from Scarborough Barbican (Acc No. SGBB); rim bottered and fully milled; bore 7/64". (Pcode 03518).
- 186.10 Heel type bowl dating from c1640-1660 from Scarborough Barbican (Acc No. SGAH); rim bottered and fully milled; bore 6/64". (Pcode 03501).
- 186.11 Heel type bowl dating from c1640-1670 from Scarborough Barbican (Acc No. SGBF); rim bottered and fully milled; bore 7/64". Very smooth surface but not burnished. (Pcode 03525).
- 186.12 Spur type bowl dating from c1650-1699 from Scarborough Barbican (Acc No. SGAH); bore 6/64". Spur type. (Pcode 03499).
- 186.13 Heel type bowl dating from c1650-1670 from Scarborough Barbican (Acc No. SGAH); rim bottered and three quarters milled; bore 6/64". Very smooth surface but not burnished. (Pcode 03498).
- 186.14 Heel type bowl dating from c1650-1670 from Scarborough Barbican (Acc No. SGAH); rim bottered but not milled; bore 7/64". (Pcode 03502).
- 186.15 Heel type bowl dating from c1650-1670 from Scarborough Barbican (Acc No. SGBE); very smooth but not burnished; rim bottered and one quarter milled; bore 6/64". Milled heel. (Pcode 01988).
- 186.16 Heel type bowl dating from c1660-1680 from Scarborough Barbican (Acc No. SGBF); rim bottered and half milled; bore 6/64". (Pcode 03524).
- 186.17 Heel type bowl dating from c1650-1670 from Scarborough Barbican (Acc No. SGBL); finely burnished; rim bottered and half milled; bore 7/64". Marked with the initials AB on the heel. (Pcode 01998).
- 186.18 Heel type bowl dating from c1660-1680 from Scarborough Barbican (Acc No. SGAO); rim wiped; rim three quarters milled; bore 7/64". (Pcode 03514).
- 186.19 Heel type bowl dating from c1660-1680 from Scarborough Barbican (Acc No. SGBL); rim bottered and three quarters milled; bore 6/64". (Pcode 03530).

- 187.01 Heel type bowl dating from c1670-1680 from Scarborough Barbican (Acc No. SGAI); rim internally trimmed and bottered and fully milled; bore 6/64". Very smooth surface but not burnished. (Pcode 03507).
- 187.02 Heel type bowl dating from c1660-1680 from Scarborough Barbican (Acc No. SGAA); rim bottered and half milled; bore 6/64". Marked with the initials HH on the heel. (Pcode 01989).
- 187.03 Heel type bowl dating from c1660-1680 from Scarborough Barbican (Acc No. SGAB); rim bottered; bore 6/64". Marked with the initials RF on the heel. (Pcode 01991).
- 187.04 Heel type bowl dating from c1660-1690 from Scarborough Barbican (Acc No. SGBL); average burnish; rim wiped; rim not milled; bore 6/64". Marked with the initials NT on the heel. (Pcode 01997).
- 187.05 Heel type bowl dating from c1660-1680 from Scarborough Barbican (Acc No. SGBL); rim bottered but not milled; bore 6/64". (Pcode 03529).
- 187.06 Heel type bowl dating from c1660-1690 from Scarborough Barbican (Acc No. SGAN); rim bottered but not milled; bore 6/64". (Pcode 03511).
- 187.07 Heel type bowl dating from c1660-1680 from Scarborough Barbican (Acc No. SGAN); rim wiped; rim half milled; bore 6/64". (Pcode 03512).
- 187.08 Spur type bowl dating from c1660-1680 from Scarborough Barbican (Acc No. SGBL); rim bottered but not milled; bore 6/64". (Pcode 03531).
- 187.09 Heel type bowl dating from c1660-1690 from Scarborough Barbican (Acc No. SGAB); rim cut but not milled; bore 5/64". Same mould as Pcode 25216. (Pcode 03484).
- 187.10 Heel type bowl dating from c1680-1710 from Scarborough Barbican (Acc No. SGAT); rim bottered but not milled; bore 4/64". Marked with the initials RC on the sides of the heel. (Pcode 03515).
- 187.11 Heel type bowl dating from c1700-1740 from Scarborough Barbican (Acc No. SGAA); no rim surviving; bore 6/64". Marked with the initials ?H on the sides of the heel. (Pcode 03478).
- 187.12 Dutch stem fragment dating from c1620-1700 from Scarborough Barbican (Acc No. SGAX); finely burnished; bore 7/64". Marked with fleur-de-lys in a lozenge. (Pcode 03517).



**Figure 186:** Pipes recorded by the author on behalf of the North West Archaeological Trust (NWAT) from excavations at Scarborough Barbican. Scale 1:1.



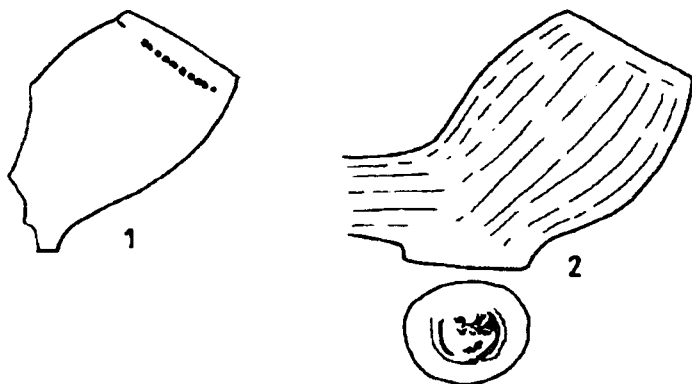
**Figure 187:** Pipes recorded by the author on behalf of the North West Archaeological Trust (NWAT) from excavations at Scarborough Barbican. Scale 1:1.

**Collection Name:** Dagnall Collection  
**Collection Code:** 0161  
**Contact Name:** Mr Ron Dagnall  
**Address:** Rainford, Merseyside  
**Description:**

Private collection recorded for the National Stamp Catalogue. NSC database searched for Yorkshire material and two pipes were selected for inclusion in the Yorkshire database.

188.01 Heel type bowl dating from c1650-1670 from Stocks Reservoir; rim bottered and one quarter milled. (Pcode 08511).

188.02 Heel type bowl dating from c1660-1690 from Stocks Reservoir; poorly burnished; rim bottered but not milled. Marked with the initials ?H on the heel. (Pcode 08510).



*Figure 188: Pipes from the Dagnall Collection, Rainford. Scale 1:1.*

**Collection Name:** Jennings Collection  
**Collection Code:** 0165  
**Contact Name:** Sarah Jennings  
**Address:** York, North Yorkshire  
**Description:**

Collection recorded for the National Stamp Catalogue. A single bowl dating from c1660-1680 was selected for inclusion in the Yorkshire database.

**Collection Name:** York Excavation Group  
**Collection Code:** 0164  
**Contact Name:** Mrs A E Screeton

**Collection Name:** York Excavation Group  
**Collection Code:** 0164  
**Contact Name:** Mrs A E Screeton  
**Address:** York, North Yorkshire

**Description:**

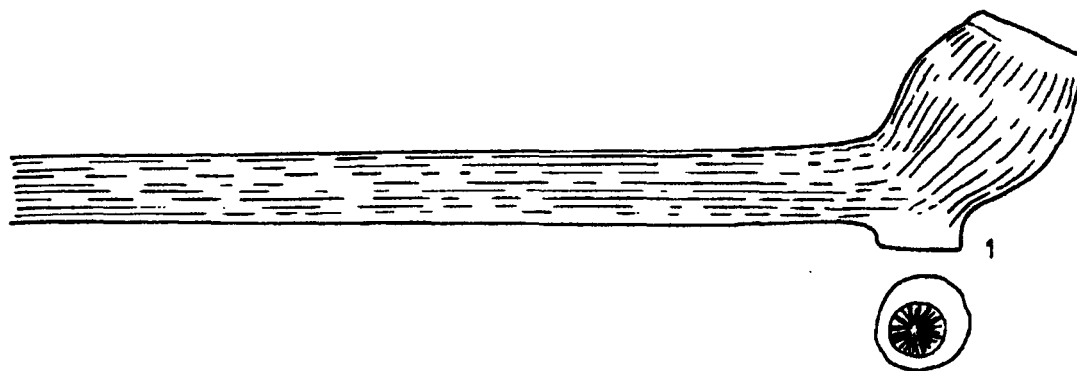
Collection recorded for the National Stamp Catalogue. A total of 21 pipes were selected for inclusion in the Yorkshire database.

**Collection Name:** Newark Museum  
**Collection Code:** 0122  
**Contact Name:** Miss M J Hall (Museum Assistant)  
**Address:** Newark, Nottinghamshire

**Description:**

Collection recorded for the National Stamp Catalogue. only one pipe, dating from c1660-1690, was selected from the NSC database for inclusion in the Yorkshire database.

189.01 Heel type bowl dating from c1660-1690, unprovenanced material in the Newark Museum (labelled 'found locally'). Good burnish; rim bottered; stem bore 8/64". Marked with a 17-spoked wheel on the heel. (Pcode 19491).



*Figure 189: Pipe from the collections of Newark Museum. Scale 1:1.*

**Collection Name:** The Bassetlaw Museum

**Collection Code:** 0207

**Contact Name:**

**Address:** Retford, Nottinghamshire

**Description:**

Collection recorded for the National Stamp Catalogue. A total of 7 stamped pipes were selected for inclusion in the Yorkshire Database.

**Collection Name:** Somerset County Museum

**Collection Code:** 0061

**Contact Name:** Mr Stephen Minnett

**Address:** Taunton, Somerset

**Description:**

Collection recorded for the National Stamp Catalogue. A single stamped pipe dating from 1660-1690 was selected for inclusion in the Yorkshire Database.

**Collection Name:** Department of Archaeology, Sheffield

**Collection Code:** 0153

**Contact Name:** Mr Patrick Foster

**Address:** Sheffield, South Yorkshire

**Description:**

Collection recorded for the National Stamp Catalogue. NSC database searched for Yorkshire material and three pipes were selected for inclusion in the Yorkshire database.

**Collection Name:** University of Sheffield

**Collection Code:** 0212

**Contact Name:** Mr David Crossley

**Address:** Sheffield, South Yorkshire

**Description:**

Collection recorded for the National Stamp Catalogue. A total of 3 stamped pipes were selected for inclusion in the Yorkshire Database.

**Collection Name:** South Yorkshire Archaeology Unit

**Collection Code:** 0166

**Contact Name:**

**Address:** South Yorkshire

**Description:**

Collection recorded for the National Stamp Catalogue. A total of 22 stamped pipes were selected for inclusion in the Yorkshire Database.

**Collection Name:** Birmingham Museum & Art Gallery

**Collection Code:** 0027

**Contact Name:**

**Address:** Birmingham, West Midlands

**Description:**

Collection recorded for the National Stamp Catalogue. NSC database searched for Yorkshire material and three pipes were selected for inclusion in the Yorkshire database.

**Collection Name:** Akerhagen Collection

**Collection Code:** 0196

**Contact Name:** Arne Akerhagen

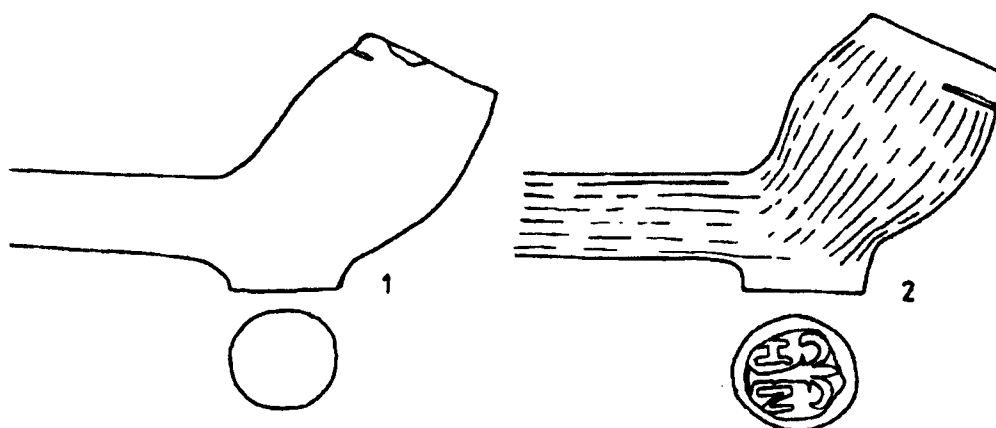
**Address:** Haninge, Sweden

**Description:**

Private collection. only two pipes were selected for inclusion in the Yorkshire database.

190.01 Heel type bowl dating from c1660-1690 from Stockholm Archipelago; rim bottered and one quarter milled; stem bore 8/64". (Pcode 08513).

190.02 Heel type bowl dating from c1660-1690 from Stockholm Archipelago; good burnish; rim bottered and three quarters milled; stem bore 8/64". Marked with the initials HN on the heel. (Pcode 08512).



**Figure 190:** Pipes from the Akerhagen Collection, Sweden. Scale 1:1.



**Collection Name:** Historic St Mary's City

**Collection Code:** 0245

**Contact Name:**

**Address:** Maryland, USA

**Description:**

Collection recorded for the National Stamp Catalogue. NSC database searched for Yorkshire material and a total of 7 pipes were selected for inclusion in the Yorkshire database.

191.01 Heel type bowl dating from c1660-1680 from Smiths Ordinary (18ST1-13) (Acc No. ST1-13 2494A/AA); rim bottered; stem bore 8/64". Recorded by D A Higgins; one of 12 similar bowls of this type recovered from same site, also 6 similar examples from Van Sweringen sites. (Pcode 25114).

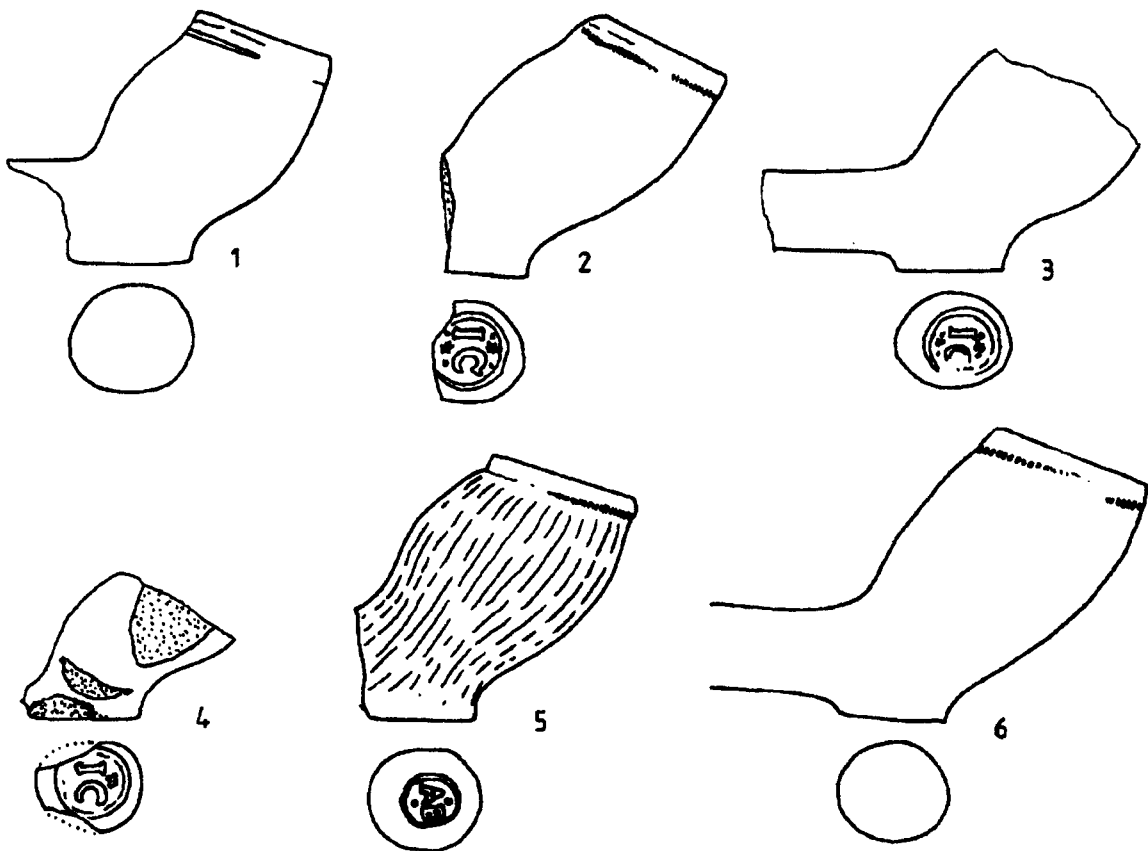
191.02 Heel type bowl dating from c1660-1680 from Countrys House ST 1-13 (Acc No. ST1-13 1649T/AA); rim bottered and fully milled; stem bore 7/64". Marked with the initials IC on the heel. Recorded by D A Higgins. (Pcode 21984).

191.03 Heel type bowl dating from c1660-1690 from Chancellors Point (18ST1-62) (Acc No. ST1-62-2/FS); stem bore 7/64". Marked with the initials IC on the heel. Recorded by D A Higgins. (Pcode 22174).

191.04 Heel type bowl dating from c1660-1680 from Chancellors Point (18ST1-62) (Acc No. 18 st 1-62-2/FT). Marked with the initials IC on the heel. Recorded by D A Higgins. (Pcode 22175).

191.05 Heel type bowl dating from c1660-1690 from John Hicks Site ST 1-22 (Acc No. ST 1-22 115); average burnish; rim bottered and three quarters milled. Marked with the initials AB on the heel. Recorded by D A Higgins. (Pcode 22185).

191.06 Heel type bowl dating from c1660-1690 from Smiths Townland ST 1-19 (Acc No. ST 1-19 394 P/AA); rim internally trimmed, bottered and three quarters milled; stem bore 7/64". Recorded by D A Higgins. In the publication of this site it was noted that 16% of the assemblage appeared to be Yorkshire 'bulbous' forms (Riordan 1991, 92).



**Figure 191:** Pipes from the collections of Historic St Mary's City, Maryland, USA. Scale 1:1.

**Collection Name:** Maryland Archaeological Conservation Laboratory

**Collection Code:** 0246

**Contact Name:**

**Address:** Maryland, USA

**Description:**

Collection recorded for the National Stamp Catalogue. only two pipes were selected for inclusion in the Yorkshire Database.

**Collection Name:** Association for the preservation of Virginia Antiquities

**Collection Code:** 0241

**Contact Name:**

**Address:** Jamestown, Virginia, USA

**Description:**

Collection recorded for the National Stamp Catalogue. NSC database searched and a total of 11 pipes selected for inclusion in the Yorkshire database.

192.01 Heel type bowl dating from c1660-1680 from Jamestown Rediscovery (Acc No. JR3E); rim bottered and half milled; stem bore 7/64". Marked with the initials RC on the heel. Recorded by D A Higgins. (Pcode 22196).



**Figure 192:** Pipe from the collections of the Association for the preservation of Virginia Antiquities, Virginia, USA. Scale 1:1.

**Collection Name:** Virginia Department of Historic Resources

**Collection Code:** 0238

**Contact Name:**

**Address:** Richmond, Virginia, U.S.A

**Description:**

Collection recorded for the National Stamp Catalogue. A total of 3 pipes were selected for inclusion in the Yorkshire Database.

**Collection Name:** Colonial Williamsburg

**Collection Code:** 0239

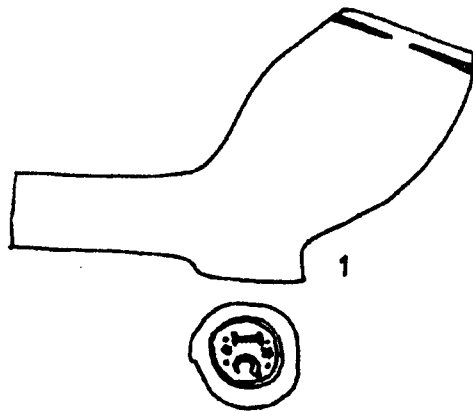
**Contact Name:**

**Address:** Williamsburg, Virginia, USA

**Description:**

Collection recorded for the National Stamp Catalogue. NSC database searched for Yorkshire material and two pipes were selected for inclusion in the Yorkshire database.

193.01 Heel type bowl dating from c1660-1690 from Pentran III (44HT44) (Acc No. F437.III SE); rim bottered and fully milled; stem bore 8/64". Marked with the initials IC on the heel. Recorded by D A Higgins. (Pcode 21498).



**Figure 193:** Pipe from the collections of Colonial Williamsburg, Williamsburg, Virginia, USA. Scale 1:1.

**Collection Name:** Flowerdew Hundred

**Collection Code:** 0243

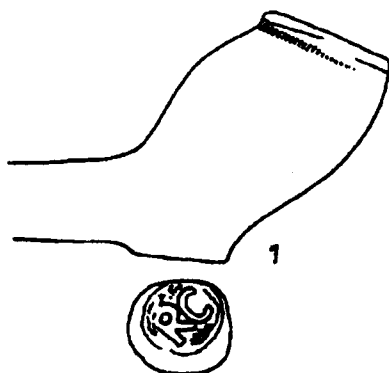
**Contact Name:**

**Address:** Virginia, USA

**Description:**

Collection recorded for the National Stamp Catalogue. NSC database searched for Yorkshire material and a single pipes was selected for inclusion in the Yorkshire database.

194.01 Heel type bowl dating from c1660-1680 from Site 44PG92 (Acc No. FHFA); rim bottered and fully milled; stem bore 9/64". Marked with the initials RC on the heel. Recorded by D A Higgins. (Pcode 21658).



**Figure 194:** *Pipe from the collections of Flowerdew Hundred, Virginia, USA. Scale 1:1.*

**Collection Name:** Virginia Foundation for Archaeological Research

**Collection Code:** 0244

**Contact Name:**

**Address:** Virginia, U.S.A.

**Description:**

Collection recorded for the National Stamp Catalogue. only one possible Yorkshire product was selected for inclusion in the Yorkshire Database.

## **Appendix 4: Draft guidelines for using the clay tobacco pipe record sheets**

**INTRODUCTION** This system has been designed to allow groups of pipes to be recorded in a standard manner. It has been conceived to deal primarily with excavated assemblages although it can easily be adapted for mixed or unstratified collections. The object has been to produce a flexible system, which includes all of the main categories of information commonly recorded by pipe researchers. Not all of these categories will necessarily be relevant to any given group but, when they are used, they allow quick and easy comparison of material both within and between sites.

An A3 format has been adopted for the recording sheets since this allows all the relevant data to be collected on one line. The information is, as far as possible, symbol coded in columns. There are three advantages to this. It is quick to compile, easy to scan for information and can be simply computerised. Three different types of sheet are used to build up the record for each site: -

- the group summary sheet
- the clay tobacco pipe record sheet
- the clay tobacco pipe summary sheet

These sheets are intended to provide a detailed catalogue of the individual fragments present from each site or collection for archive and research purposes. This record may be supplemented by additional notes and drawings, which collectively will form the basis for a synthesised written report. Each of these three types of sheet is described below, followed by an explanation of the categories of information collected and the codes used for recording.

**THE GROUP SUMMARY SHEET** Only one of these sheets is completed for each group. It acts as a guide to the record, which has been made and defines the way in which the record has been arrived at. The sheet sets out basic information about the material such as who has commissioned the work, where the material is from and exactly what the record consists of. It also gives details of how the record was compiled and by whom. Most of the categories are self-explanatory and do not need further clarification. The main thing to note is that flexibility to the recording system has been built in by allowing specific recording elements to be defined. For example, the bowl form typology or fabric types can be set on this sheet to define the codes used on the recording forms. The 'notes' section allows free text, which can be used to further define way in which the material has been studied and recorded.

**THE CLAY TOBACCO PIPE RECORD SHEET** The second sheet is used to list, in context order, the individual fragments making up each group. The site and total number of sheets completed is recorded at the top of the sheet. Each line is used to record an individual fragment or a group of fragments if their attributes are all the same. For each different context the bowls, stems and mouthpieces should be listed, in that order, with marked or decorated pieces coming before the plain examples within each category. The symbols /, 0 or - are used to mean 'yes', 'no' or 'can't tell' respectively. The following classes of information can then be recorded: -

**Identification** The context number and any individual small find or bag number for the piece(s) are recorded in the first two columns. Normally all the numbers actually written on each pipe are included here.

**Fab** This column is used for recording fabric differences, where these can be seen. This might simply differentiate coarse, gritty, 'local' fabrics (L) from fine 'imported' clays (I). Where more detailed divisions can be made the codes used should be defined on the Group Summary Sheet.

**B S M** The number of bowl (B), stem (S) and mouthpiece (M) fragments recovered from each context is entered in these three columns. As entries on the right hand side of the sheet must relate to all of the fragments entered in these first columns, a number of different lines are usually required to build up a complete record of each context group.

The numbers of fragments entered are the numbers as excavated. Two or more joining pieces which have clearly damaged during recovery or handling are counted as one piece. Reconstructed fragments, which were damaged before deposition, are counted individually, being listed in their appropriate columns but on the same line. A note of any such joins or of other cross context joins should be placed in the final column.

If an unbroken pipe is recovered it is counted under the bowl column and an arrow (->) drawn across the stem and mouthpiece columns. The fact that the pipe is complete noted in the 'comments' column where details of the stem length, mouthpiece form and finish can be given. In this way details of the pipe can still be found on the form without distorting the count of fragments recorded in the columns.

**Bowls (B)** A bowl fragment is defined as any fragment with part of the base of the heel or spur surviving or with enough of the bowl to show its thickness (i.e., with any part of the internal bowl cavity surviving). The length of any surviving stem is irrelevant and is not counted separately in the stem column. This does not apply to re-assembled fragments of stem, which have been joined to a bowl fragment. These should be counted under the stem column on the same line.

**Stems (S)** A stem is any fragment with neither bowl nor mouthpiece surviving.

**Mouthpieces (M)** A mouthpiece is any piece with some or all the mouthpiece surviving.

**MN** Minimum number. The minimum number of pipes represented. Where this column is completed the methodology used should be stated on the group summary sheet.

**B/64** This records the stem bore(s) of the fragments listed on each line in 64ths of an inch, '7', for example, representing a fragment with a bore of 7/64". The means by which the bore has been measured should be stated on the Group Summary Sheet (e.g. ruler, butt end of imperial drill bit, travelling microscope). Where the stem bore at either end of a fragment varies only the smaller measurement should be recorded. For

mouthpieces only the broken end is be measured.

**BUR** Records burnishing on the fragments(s). This can either be a yes tick (/) where burnishing is present or it can be further graded as fine (F), good (G), average (A) or poor (P). A fine (F) burnish is when the polishing lines are so closely spaced and even that there are no gaps between and a fine very glossy surface is created. A good (G) burnish is well applied with close, even strokes. An average (A) burnish will have gaps of roughly equal width to the burnish lines and may be light and uneven. A poor (P) burnish is very scrappy and irregularly applied. Burnishing on the stem is usually less well applied than that on the bowl and can often only be noted as being present rather than being graded. Great care must be taken on the identification of burnishing, especially where naturally glossy fabrics are used. Burnished pipes exhibit the slight facets caused by polishing and, usually, an alternating surface of glossy and matt strips.

**TIP** These two columns describe the tip or mouthpiece of the pipe. They record the type of mouthpiece (T) and finish (F) applied to it.

**T** The types of mouthpiece are coded as follows: -

C = Cut; the mouthpiece is formed by a simple cut end to the stem and no other moulded shape is present.

R = Rounded: the mouthpiece is formed in the mould as a simple rounded end.

N = Nipple: a circular sectioned stem, which terminates with a moulded nipple.

D = Diamond shaped: the stem ends with a diamond shaped cross section but without a nipple.

DN = Diamond nipple: where the stem takes on lozenge or sharply oval section in shape directly before the nipple.

FO = Flattened Oval: the stem takes on a flat, oval, section at the tip, without a nipple.

**F** The types of finish are coded as follows: -

0 = No visible finish

RW = Red Wax

GW = Green Wax

GG = Green Glazed; often thin and light in colour

YG = Yellow Glaze

CG = Clear Glaze

\* = Other; specify under 'comments'

**BOWL** Four columns deal with various attributes of the bowl. These are: -

**X** Internal bowl crosses. The most common marks found on the internal base of a bowl are crosses. When viewed with the stem pointing down these can either appear as '+' or 'x'. These symbols should be used to indicate which type is present. If some other symbol or letter is found enter \* and describe it in the comments section.

**M/4** Milling. The amount of milling around the rim is estimated to the nearest quarter of a complete circumference so, for example, a half milled pipe is entered as 2. If no milling is present a 0 is entered, if milling is present but the



rim damaged a / is entered, if no rim survives a - is entered.

**RIM** Rim finish. The way in which the rim has been treated is coded: -

C = Cut: the rim is formed by just a single horizontal knife cut.

B = Bottered: the rim has been smoothed with a bottering tool giving a rounded profile.

I = Internal knife cut: a knife has been used to cut clay from the inside of the bowl to make a thinner, finer rim.

W = Wiped: the rim has been wiped or smoothed (as opposed to being bottered).

These codes may be used together. Thus CW is a rim that has been cut and wiped or IB is a rim that had been internally knife cut and bottered. These last two techniques are often very difficult to distinguish where they occur together and any results should be regarded cautiously looking for general trends rather than exact figures. As a general rule bottering produces a smooth, rounded and 'wiped' appearance near the rim as apposed to knife trimming which produces less even and deeper marks within the bowl with a fresher 'scraped' appearance to the surface.

**FORM** The type number of the bowl form from a recognised typology, which should be entered on the status sheet. If the bowl falls between two forms these should both be entered (e.g. 25/27) and if the bowl is not a very good match it should be noted as a 'variant' of the basic form using the letter 'v' (e.g. 25v).

**MARK** The next five columns deal with any maker's mark. A sketch or transcription of the mark is written under MARK.

**CAT NO** = The National Catalogue number of any stamped mark. This is intended to relate specifically to the National Stamp Catalogue, which is being compiled at the University of Liverpool. Any alternative numbering system should be defined on the Group Summary Sheet.

**POS** = Position the position/style of mark. The codes are: -

H: On the base of the heel.

SP: On the base of the spur.

BB: Beneath the bowl where a pipe has neither heel nor spur.

SH: On the sides of the heel.

SS: On the sides of the spur.

BF: On the bowl facing the smoker.

BL: On the bowl, on the left hand side as smoked.

BR: On the bowl, on the right hand side as smoked.

BA: On the bowl facing away from the smoker.

BS: On the bowl sides.

SX: On the top of the stem, reading across it.

SL: On the stem, reading along it.

SM: Multiple individual stamps right around the stem, as a band or pattern.

RS: Roll stamped stem, a continuous band or zone around the stem. This may be plain

or decorated but does not include milled decoration.

SP: Spiral stem stamp (one line mark applied on a spiral).

ST: Stem twist, a specific form of roll stamp forming a spiral of shallow grooves around the stem.

**TYPE** The type of mark is recorded: -

I: The primary pattern or motif is incuse.

R: The primary pattern or motif is in relief.

A: Applied mark formed of some medium other than clay such as a rubber stamp, transfer print or hand written mark.

**METHOD** The method by which the mark was formed: -

M: Moulded mark.

S: Stamped mark.

I: Ink stamp (rubber stamp).

TP: Transfer printed mark.

HW: Hand written mark.

\*: Other, specify the exact type under comments.

**DECORATION** Describe or sketch any decorative treatment of the pipe.

**DATE** The date range for the piece(s) recorded. This is an estimate of the likely period during which the pieces were made.

**DR** Drawing. Any letter or numeric code used to identify drawn examples. If both record sketches and full publication drawings are made these should be differentiated.

**COMMENTS** Any comments or notes on the pipe(s) recorded. Particular note should be made to expand any column where \* or an arrow has been entered and to note features such as cross context joins.

**CONTEXT SUMMARY SHEET** The third sheet is the context summary sheet that tabulates the cumulative information from the record sheets. It acts as an index as well as a summary and is of particular value for the excavator or finds assistant since it shows the overall date range for each context and the number of fragments upon which that date is based.

**CONTEXT** The context number.

**PHASE** the site phase or period to which the context belongs.

**B S M** Totals of Bowl, Stem and Mouthpiece recovered from that context.

**TOT** The total number of fragments from that context.

**DATE RANGE** The overall date range of all the fragments recovered. If a more precise date for deposition can be suggested, for example where some material is likely to be either residual or intrusive, the date can be asterisked and further details given in

the comments section.

**BURNISH** The total number of burnished bowl, stem and mouthpiece fragments is entered in the first column and then the ratio of burnished pieces, expressed as a percentage, in the second. This provides an indication of the 'quality' of the deposit since burnishing increased the price of a pipe.

**MILLING INDEX** The milling index is calculated by adding the figures for each complete rim in a context, which will range from 0-4, and dividing by the sum of the number recorded. This gives the average quantity of milling, measured in units of 1/4 of the circumference of the rim, for the pipes in that deposit. Since it cost more for fully milled pipes the closer the average approaches 4.0 the higher the 'quality' of the pipes.

**STAMPED** The total number of stamped marks.

**MOULDED MARKS** The total number of moulded marks.

**DECORATED** The total number of decorated pipes.

**ILLUSTRATIONS** The drawing numbers of all drawn pieces.

**KILN** The total number of pieces considered to be kiln wasters is entered. This will often represent only the minimum number present since actual damage or discolouration occurs on a small percentage of all kiln waste.

**COMMENTS** Brief comments on pieces of particular importance or the group as a whole.

D A Higgins & P J Davey  
Department of Archaeology, University of Liverpool

November 1994

## **Appendix 5:**

### **A CATALOGUE OF THE CLAY TOBACCO PIPE STAMPS FOUND IN ENGLAND**

*D A Higgins*

#### **Notes on the Recording System (last updated 4.10.00)**

**INTRODUCTION** The Clay Tobacco Pipe Stamp Catalogue was started in 1988 with three principal aims:-

- to compile as complete a catalogue as possible of all the stamped clay tobacco pipes which have been found in England
- to identify and define each individual die type represented in the catalogue
- to make the catalogue available as a standard reference work for the identification of pipe stamps and for other research

In order to achieve these aims, a rapid field recording system has been evolved whereby permanent and detailed impressions of each mark can be collected and stored for comparison and reference. A detailed twice life-size drawing of each individual die is made from the impressions and logged with the accompanying description. Wherever possible, these die types are then be linked to documented makers, thus providing an accurate dating and provenance for each mark.

The full catalogue holds details of the provenance, date and holding institution for each marked pipe as well as a classification of the type of mark, its location on the pipe, etc. The value of the catalogue as a research tool goes well beyond the simple identification of pipe stamps since all of this information is held on a relational database that can be accessed and interrogated in a variety of ways. The database can be used, for example, to look at the range of marks used by one maker, the stylistic development of marks by period or by region, or the evolution of trade and marketing patterns.

The large number of pipes that are available for study has made it necessary to limit the range and complexity of the data recorded for each pipe. A recording system has, therefore, been designed to collect certain selected categories of information in the most efficient manner. It is this recording system, which is described in Section 1 below. The processing of the collected data is described in Section 2 and the archive storage and database in Section 3.

Since its inception, the Catalogue has also taken in pipe stamps from places outside the main collection area, for example, from Wales, Scotland, Italy, the Netherlands, the

**1 : PRIMARY DATA COLLECTION** The primary data collection for this catalogue comprises a direct impression of each individual mark entered plus supporting details which are logged on a paper record sheet. From the impressions of each mark exact facsimiles can be created to form a permanent reference archive of all of the marks studied. The pipe stamps are impressed on standard sized blocks of plasticine, dusted with talcum powder as a releasing agent. For security, each mark is impressed twice and, on average, each plasticine block of 12.5cm x 20.5cm can record about 30-40 different pipes. When the block is full two permanent reference copies are made using a fine casting plaster. These casts provide an exact three-dimensional copy of each mark and allow examples from widely separated collections to be directly compared.

The data concerning each marked pipe is collected on a simple recording form in the same order that the impressions are made. The categories of information recorded on the form are entered into columns. Each line is used to record details of an individual stamp impression on a pipe, or, occasionally, for a group of identical impressions on the same part of a pipe. The categories of information recorded are as follows;

**COLL - Collection Name** The common name of the collection or storage place of the pipes being examined is entered at the top of each recording sheet. This may be a museum name, archaeological unit or store, or the name of an individual who has a private collection of pipes. If the storage place is different from body responsible for the pipes (for example a separate storage building used by a museum) this should be made clear in the 'text' (see below). Private collections are generally entered by surname only (for example, 'Thursfield Collection').

**PRI - Private?** The code Y (yes) or N (no) is entered to indicate whether the collection is privately owned or not.

**CONT - Contact** The name of the person contacted or responsible for the collection is entered here. This is to provide a record of the contact or person dealing with the collection should further information / visits be required.

**TEL - Telephone** The telephone number of the contact is entered. If this is at a different address to that given below (for example a home number for the curator of a museum which has no phone) this should be noted in the text section (see below).

**ADR/TOWN/CCOUNTY/POSTCODE** The postal address of the collection is entered. The town, county (coded as CCOUNTY) and postcode are given separate sections to enable computer sorting of the addresses. The computer will only sort on the town given so, if an address has two place names in it, for example, '...Rainford, St Helens...', both should be entered under 'town' so that the more specific place (i.e., Rainford) can be sorted by the computer.

**CTEXT - Collection text** Notes regarding any of the above sections about the

collection can be entered. In addition to commenting on any of the above entries it is also useful to note things which are likely to happen where known, for example, the retirement of a curator or the deposition of the finds elsewhere.

**COUNTY/PARISH/SITE** The County, Parish and common name of the site where each fragment of pipe was found is recorded here. Present counties should be used. If only a general location or county for the find is known, this should still be entered in the appropriate column.

**SCOD/CREF/DCOD/PCOD/CCOD** These columns are for computerisation codes and are left blank during primary recording (see section 2 below).

**ACC** Any museum accession number, words or other symbols written on the pipe to record or identify it are entered here.

**MARK** A sketch of the form of the mark is made. This need not be particularly detailed or accurate since it is only to facilitate data location within the recording system. If a pipe has more than one variety of mark stamped on it, each different mark should be placed on a separate line and the lines bracketed together in the PCOD column to indicate that they occur on the same piece. The same mark should be repeated, likewise bracketed, only if it occurs on different parts of the pipe (see POS below).

**POS** The position of each mark is recorded. Usually each pipe has only one stamp on it and the following codes are used to indicate the position of it;

- H - On the base of the heel.
- SH - On the sides of the heel.
- SS - On the sides of the spur.
- SP - On the base of the spur.
- BB - Beneath the bowl where a pipe has neither heel nor spur.
- BF - On the bowl, facing the smoker.
- BL - On the bowl, on the left hand side as smoked.
- BR - On the bowl, on the right hand side as smoked.
- BA - On the bowl, facing away from the smoker.
- BS - On the sides of the bowl.
- RS - Roll stamped stem, a continuous band or zone around the stem. This may be plain or decorated but does not include milled decoration.
- SX - On the top of the stem, reading across it.
- SL - On the stem, reading along it.
- SP - Long, thin mark applied as a spiral around the stem.
- SM - Multiple individual stamps right around the stem, as a band or pattern.
- ST - Stem twist, a specific form of roll stamp forming a spiral of shallow grooves around the stem.

These codes may be used where a group of identical marks occur in one position, for example a pattern of marks on the bowl facing the smoker. In such a case the number of individual marks is listed in EX (below). Where the same mark appears on several

parts of the pipe each area should be listed on a separate line with the appropriate code and the lines bracketed together (in the PCOD column) to indicate that they occur on the same pipe.

**EX** The number of examples of an individual die in a particular position on the pipe are recorded. For example, five identical impressions of a mark on the bowl facing the smoker would be entered here as '5'.

**DR** This column is used to identify those pipes used for, or contributing to, a type drawing. It is consequently filled in after the primary recording (see section 2 below).

**DATE** An assessment of the date of the piece is entered. Any date entered is not to be considered as sacrosanct since it is dependent on the dating evidence available and the experience of the recorder. It records what is currently considered to be the most likely date of the pipe.

**P11/P12/P13 etc** Where a pipe is known to have been previously published a reference is entered here. The form allows for the recording of three previous publications (P1, P2, P3) of any particular pipe. The three columns are used to code the publication (column 1, as a numerical code), page number (column 2) and illustration number, if there is one (column 3). If a pipe is known to have been illustrated in a publication the code for which is not known, the page and figure numbers can still be added and the full title of the article noted in the PTEXT column. The code can then be added later.

**TEXT** Any notes, comments or particular observations about the pipe or mark can be entered here.

**RECORDED BY/COMPLETED** Finally, the name of the compiler and date the collection was recorded are entered on the side of the recording sheet.

**2 : DATA SORTING** Once the plaster casts of the marks in each collection have been made up a second phase of recording must take place before the information can be added to the main database on the computer. This second phase consists primarily of adding codes to complete the recording sheets described above, and filling in die record sheets for new marks. In order to do this a number of sub-sections of the main recording system must be consulted. The full form of the database and all its sub-sections are described in section 3 below. The following codes must be added to the primary data collection sheets.

**SCOD** This is the site code; a unique number allocated to each different site from which pipes are recorded.

**CREF** This is the cast reference number; the individual number allocated to the pair of impressions of each individual die on each part of the pipe. One individual pipe may, therefore, have more than one CREF if stamped marks occur on more than one part of it. For example, two different stem borders applied to the same stem will each

be allocated their own CREF. On the other hand, if there is more than one example of the same mark on the same part of the pipe then they can both be allocated the same CREF number. When a record sheet is being completed the plaster block is allocated the next number in a running sequence and each impression becomes a sub-division of that number. Thus a block with thirty-five impressions recorded on it may be the one hundred and twenty-third block in the system. The impressions on this block will therefore be identified as 123.1 to 123.35.

**DCOD/DR** DCOD is the die code; the reference number of the specific die which created the impression(s) recorded on each line of data. Each die impression is compared with the type series of drawings held on a card index. If it is the same as one already illustrated the reference number can be inserted at once. If it adds detail to a mark previously illustrated it may be used to enhance the existing type drawing. If this is the case it must be checked against the original type specimen to confirm that it is the same die type and a T must be entered in the DR column to indicate that it has been used as part of a type drawing. If it completely replaces an existing type drawing a T should still be entered and the old one deleted, but in this case all other marks attributed to this die number should be checked against the new type specimen. If the die is previously un-recorded a T is likewise entered, a new die number allocated and a type drawing is made for inclusion in the card index. In addition details of the die are entered on a die record sheet (see 2.1 below).

**PCOD** This is the pipe code; a unique reference number which must be allocated to each pipe entered on the record sheet. This number is not actually recorded on the pipe, it is just an open ended sequence used to label the data in the recording system.

**CCOD** This is the collection code; a unique number allocated to each different collection of pipes recorded.

**P1 etc** The reference code is added for any publications which do not already have one (see above).

**2.1 THE DIE RECORD SHEET** When a new die variant is identified details of the mark are entered onto a separate sheet. This is used to compile a sub-section of the database holding information about the different marks, the type drawings of which are held on a card index. The information recorded is as follows;

**DCOD** A unique die code is allocated to each new type defined.

**MARK** A sketch of the mark is made to provide easy access to the data rows.

**CREF** The cast reference number of the type example is entered. More than one reference may be entered where more than one impression has been used to define the type drawing.

**FR** A frame code is used to identify the shape of the outer border of the die. This breaks the dies into more manageable groups and is used to facilitate computer sorting



of the marks. These are intended only as general classifications, and each form may include various sub-forms or types with decorated edges, for example spikes, trefoils or serrations. They have been kept as broad as possible in an attempt to avoid confusion between indistinct or overlapping forms. The codes used are;

- 1 Un-bordered lettering, any arrangement
- 2 Circular or sub circular
- 3 Upright oval
- 4 Intersecting ovals
- 5 Horizontal oval
- 6 Crescent
- 7 Four lobes
- 8 Multi-lobed, various forms
- 9 Heart-shaped (indented top)
- 10 Heart/shield intermediate forms
- 11 Shield shaped
- 12 Other symmetrical form
- 13 Irregular border, or one following design / lettering
- 30 Octagonal
- 31 Square or squat rectangular
- 32 Long rectangular
- 33 Stepped rectangular
- 34 Lozenge
- 35 Concave-sided lozenge
- 50 Roll-stamp (all forms, narrow or broad)
- 70 Stem twists / spiral decoration
- 99 Uncertain / indeterminate form

**I/R** I or R is entered to signify whether the primary lettering or motif of a mark is formed of an incuse or relief design.

**CHRIS/SUR/PLACE/SLO** The actual design of the mark is broken down into a number of elements. Any lettering or numbering is taken as the primary motif any used as key to indexing the mark. Four categories of written information may be defined; Christian name, surname, place name and any slogan or other information. The information depicted on the mark is broken into the appropriate columns. Thus, the initials 'WS' would be placed with the W in the Christian name column and the S in the surname column, while the mark 'W.SOUTHORN & Co / BROSELEY 19' has the W in the Christian name column, the Southorn in the surname column, Broseley in the place column and the '& Co' and '19' in the slogan/other column. This last column takes any details not included in the first three. In cases where the manufacturer and place are tied up in a complex mark with other information it may be necessary to extract some information for other columns, but to include the whole mark again under slogan. This does not matter too much since the purpose of this section is to enable sorting and extraction of information primarily by makers name and place, and only then by any other information. To avoid confusion where other names occur on the mark, these too should be placed in the Christian name / surname columns. This means that initials such as AR, which sometimes occur with a crown for Queen Anne

(Anne Regina), or the name of a tobacconist may be placed in these columns even though they are not the initials or name of a pipemaker. An explanatory note should be added in the text column. This enables marks with names and initials to be found even when a user may be unsure of their exact meaning. Single letter marks are placed in the surname column and, once again, an explanatory note added to the text column if they do not in fact represent a surname. The place column is only used for towns or villages, street names etc being placed as slogans. Finally there are some marks which have no lettering or numbering on them. These are classified by the principal motif represented on the mark, which is entered in the symbol (SYM) column.

**SYM** The symbol column is used for those marks without either lettering or numbering on them. In order to break down the diverse range of types they have been divided into ten broad categories, each of which may be further sub-divided to cater for the commonest groups encountered. This enables searching or comparison of symbol marks to be confined to as small a group as possible. The groups defined are;

**Group 1 - Simple geometric patterns.**

- 1.1 Cross motif and variants
- 1.2 Radiating spokes
- 1.3 Spokes with dots between
- 1.4 Spokes with spikes between
- 1.5 Spokes with dots and spikes or other motifs
- 1.6 Star motif
- 1.7
- 1.8
- 1.9 Any other simple motif or other abstract pattern

**Group 2 - Simple symbols (not falling within 3-9 below).**

- 2.1 Heart
- 2.2 Crown
- 2.3 Crescent
- 2.4 Castle
- 2.5 Portcullis
- 2.6 Fleur-de-lys
- 2.7
- 2.8
- 2.9 Any other simple symbol

**Group 3 - Plant motifs.**

- 3.1 Pellet flower
- 3.2 Simple flower
- 3.3 Tudor rose
- 3.4 Crowned rose
- 3.5 Acorn
- 3.6 Leaf
- 3.7
- 3.8
- 3.9 Any other plant motif

**Group 4 - Animal motifs (including crests where animals occur).**

- 4.1 Fish
- 4.2 Bird
- 4.3 Lion
- 4.4 Fox
- 4.5 Mythical/fantastic animal
- 4.6 Dog
- 4.7
- 4.8
- 4.9 Any other animal

**Group 5 - People (including crests where people occur).**

- 5.1 Hand / gauntlet (no clear thumb)
- 5.2 Hand / gauntlet (thumb facing left)
- 5.3 Hand / gauntlet (thumb facing right)
- 5.4 Arms / legs
- 5.5 Bust
- 5.6 Full figure
- 5.7 Legendary / Mythical figures
- 5.8
- 5.9 Any other part of the body

**Group 6 - Coats of Arms (for simple crests see 4/5 above).**

- 6.1 London arms.
- 6.2 Chester arms.
- 6.3
- 6.4
- 6.5
- 6.6
- 6.7
- 6.8
- 6.9 Misc. & Unidentified arms

**Group 7 - Misc. Representational Objects (all).**

**Group 8 - All roll stamps (without lettering).**

- 8.1 Simple narrow borders (all)
- 8.2 Geometric designs
- 8.3 Zoomorphic / tulip / tendril / leaf types
- 8.4 Heart, star or fleur-de-lys types
- 8.5 Midlands type hatched oval borders
- 8.6
- 8.7
- 8.8
- 8.9 Any other border

**Group 9 - All stem twists and spiral roll stamps.**

- 9.1 Plain stem twists (all, not die sorted)

## 9.2 Decorated stem twists

Group 10 - Unclassified / illegible marks.

**DATE** This is the estimated date range during which the particular die was likely to have been used. A number of factors are taken into account in determining this date, for example, any known documentary dates for the maker and the typological and stylistic period to which the bowl and mark belong. Clearly this can only be a current estimate based on the available evidence. Further research or detailed local studies may well lead to modification of these dates.

**USER** This is the pipemaker who is thought to have used the die. The attribution of marks is often difficult, and to a degree dependent on the amount of documentary research which has been carried out in a particular area. A maker may be entered here when there is good reason to think he used a particular die, but it must be remembered that subsequent research may alter this attribution.

**CO** This is the county in which a die is thought to have been used, or the country if the mark is foreign.

**PL** This is the place in which a die is thought to have been used.

**TEXT** Any notes concerning the die or its attribution.

**3 : ARCHIVE STORAGE AND THE DATABASE** The data collection and sorting generates four main sets of data; the plaster casts of the marks, the primary record sheets, the card index of type drawings and the die record sheets recording details of these marks. In addition three other lists have to be maintained as part of the paper archive, i.e., details of collections, sites and publications. All of this information, with the exception of the type drawings, is held, ordered and interrogated through a computer database. The system has been designed with unique codes for each field of data so that the information can be used on a Structured Query Language system.

The computer database contains a number of tables into which each category of information is fitted. There are tables, which just hold information about the sites, or the collections, or the casts. By using the various codes listed above it is possible to cross-refer to information held in different tables. Thus, the PCOD, DCOD, SCOD, CCOD and CREF (pipe code, die code, site code, collection code and cast reference) give access to information about a particular pipe, the mark on it with associated details, the site on which it was found, the collection in which it was stored and the reference number of the copy which has been made of it

At present, inputting forms mirroring all the paper records have been designed using Access. Susie White from the Department of Archaeology at the University of Liverpool is currently carrying out a 'field trial' by using the system to record some 2,200 stamped pipes from collections in Yorkshire. This is intended to iron out any teething problems with the system. For the time being, the twice life size images of the

pipes are still held on card index but, ultimately, it is intended that digital images will be included as part of the database.

To date, some 14,000 different stamped pipes have been impressed for the catalogue and some 2,000 different die types identified on the card index. The catalogue has recorded all the stamped pipes in more than half of the museum collections and archaeological stores in England. In addition, some foreign material has been added, including nearly 1,000 pipes from colonial sites in Maryland and Virginia. It is intended that the final version of the catalogue will be disseminated in digital format. Copies of all the plaster reference blocks are being deposited with the National Clay Tobacco Pipe Archive, which is housed at the University of Liverpool.

David Higgins  
Third draft, October 2000.

**Contact Details:-**

Dr D A Higgins,  
3 Clarendon Road  
Wallasey  
Merseyside  
CH44 8EH  
U.K.

## **Appendix 6: Clay tobacco pipes from excavations at Sandal Castle.**

In 1983 a brief note was published on the clay tobacco pipes from Sandal Castle (Lawrence 1983, 285). A total of 1,551 clay tobacco pipe fragments were recovered from the excavations producing one of the finest Civil War assemblages from England and yet was summarised by Lawrence in a single paragraph. Many of the attribution given by Lawrence are incorrect and the illustrations have been poorly executed and reproduced at half life-size making them difficult to use. Even by the standards of the day, this report was totally inadequate particularly given the importance of such an assemblage.

As part of this present research arrangements were made to record and study the Sandal pipes in accordance with the draft guidelines, which had been proposed for the processing of excavated material (Higgins and Davey 1994). Details of this recording system used can be found in Appendix 4.

The details of each pipe fragment have been logged on an Excel spreadsheet, a copy of which is presented in this appendix at the end of this summary, noting whether it is a bowl (B), stem (S) or mouthpiece (M). For each fragment a date range has been given followed by details of the bore in 64" (B64); the quality of burnishing if present (Bur); the presence or absence of an internal bowl cross (BX); the amount of milling where relevant (M4); the rim finish (Rim); and the tip type (TT) and tip finish (TF) of any mouthpiece fragments. In addition, when marked the Christian name or initial is noted (Cname) together with the surname or initial (Sname). The position (P), type (T) and method of application (M) of that mark is noted. Where relevant the pipe code reference (Pcode), which cross-refers to the Yorkshire database, is also noted together with any comments.

In the following note a brief introduction to the Civil War activity at the castle is given. This is followed by a summary of the pipe analysis. A full discussion of the mould flaws identified can be found in Chapter 9. Sixty-five pipe fragments were selected for illustration and drawings prepared at a scale of 1:1. These can be found in Appendix 3 Figures 163 to 166.

Although it has not been possible to prepare a full report on the clay tobacco pipes from Sandal it is hoped that the following summary and detailed catalogue will highlight the importance of this quite outstanding assemblage. The clay tobacco pipes from Sandal Castle clearly warrant further, more detailed, analysis.

### **Introduction**

Sandal Castle lies approximately 3 miles south of Wakefield (SE 433418). Extensive excavations were carried out on the site between 1964 and 1973 during which time most of the castle was excavated down to natural. Amongst the many thousands of objects recovered from these excavations were 1,551 clay tobacco pipe fragments.

On 20th July 1645 the Parliamentarians, encouraged by the surrender of Pontefract, made a formal request for the surrender of Sandal, but this request was turned down. Early in September 1645 the Parliamentarian troops under the leadership of General Poyntz surrounded the castle and began the bombardment of the castle with four

'great guns', which had been brought in from Hull. At this point Sandal was well provisioned and garrisoned by a force of about 100 officers and men. Several days of firing had resulted in the breaching in the walls and on 30<sup>th</sup> September preparations were made to storm the castle. After lengthy discussions, however, the defenders agreed to leave on favourable terms and the castle surrendered at 10am on 1<sup>st</sup> October 1645 (Mayes & Butler 1983).

In 1646, on the orders of Parliament, the castle was stripped of its defences and made untenable. Although these destructions left Sandal with little economic potential, the earthworks and stonework continued to attract the interest of local, regional and even national antiquarians (*ibid*).

### **The pipes**

A total of 1,551 fragments comprising 310 bowls, 1,200 stems, and 41 mouthpieces were recovered during the excavations. Of these, 1,464 fragments or 94% of the whole assemblage date from the Civil War activity at the castle making this one of the largest and most closely dated Civil War groups in the country, comparable with the group from Pontefract castle (Davey & White 2002).

In order to give an indication of the temporal dispersion of pipes from the site the number of occurrences, per decade, of the dateable bowls were plotted on a bar chart (Figure 1). In order to do this each pipe bowl was examined and a bar entered for each decade of its conventional date range. For example, if a pipe bowl was dated from 1640 to 1660 the decades 1640 and 1650 were marked once. This method has the effect of smoothing out the curve created by the graph since it spreads the information over each decade rather than creating marked steps and plateaux, as is the case when broad typological groups are used, for example 1610 to 1640, 1640 to 1660 etc. The result is a more realistic picture of the main periods of activity on the site. The graph clearly shows that there was very little activity immediately before the Civil War period. There is a marked peak in the number of pipes deposited on the site during the Civil War, which then falls away sharply immediately after the war. From 1660 onwards there are very few pipes deposited on the site and may be nothing more than the result of rubbish left behind by the casual visitor.

At the time of writing this summary none of the original site notes from the excavation was available. The majority of the site codes assigned to the pipes, however, are the same as the site location codes allocated to the pottery (Mayes and Butler 1983, 205-206). Using these codes an attempt has been made to plot, as closely as possible, the find spots of the individual pipes (Figure 2) to give an indication of the activity within the castle itself. It should be noted that it has not been possible to identify finds spots for all the pipes.

It is interesting to note that the majority of the clay tobacco pipes were recovered from those areas under attack, namely along the west curtain wall and the keep. There was also a marked concentration of pipes around the forge, which was heavily used during the siege for the maintenance and repair of the defenders' weapons.

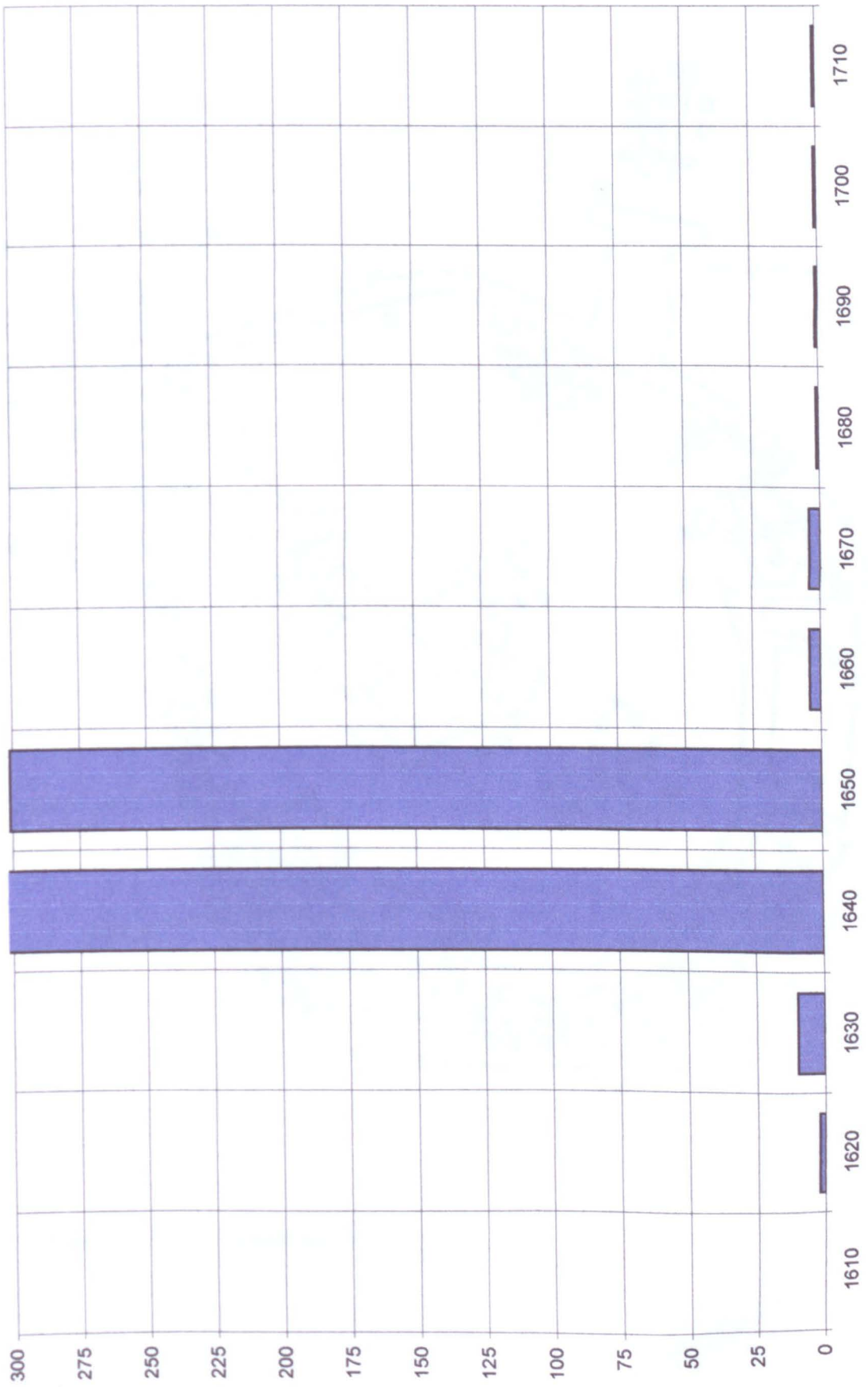
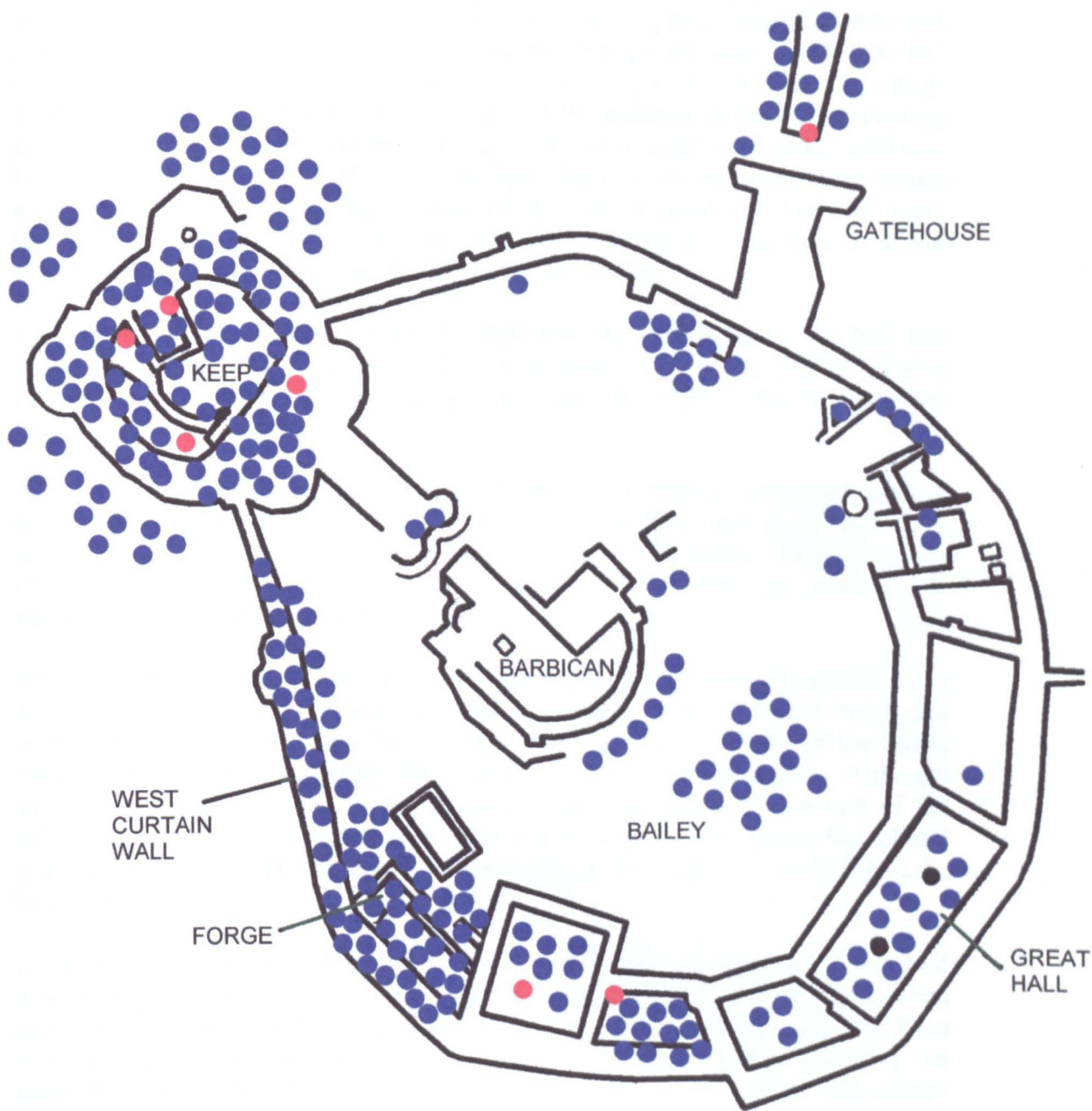


Figure 1: Bowl date chart for Sandal Castle





**Figure 2:** Approximate find spots of the clay tobacco pipes from Sandal Castle. Each coloured dot represents a pipe. The red dots denote the marked fragments.

A total of 13 marked fragments were recovered. These include one bowl fragment with an illegible heel stamp, the first initials possibly reads For E, dating from 1640-1660; two bowl fragments with a GW stamp on the heel dating from 1620-1640 and attributed to Gabriel Westaby of York; one bowl fragment with the initials BC stamped on the heel also dating from 1620-1640 and possibly a London product. There were a total of five bowls with the initials RW stamped on the heel and dating from 1630-1660. These can be attributed to Roger Wilkins a Dutch maker who was born in York around 1607. All these RW pipes were produced in the same mould and stamped with the same die. These are the only examples of this RW mark recorded in the whole of Yorkshire and may, therefore, constitute a single consignment for use by the Officers stationed at the castle.

Of slightly later date was one bowl stamped with the initials IG on the heel and dating from 1660-1680. In addition, there were three stems dating 1690-1730 also marked IG were recovered. All of these fragments may be attributed to one of the Gill's of Wakefield.

Analysis of the Civil War period bowls identified 13 individual mould groups, that is bowls that have tiny flaws on them indicating that they were produced in the same mould (See Chapter 9 for discussion). Interestingly Sandal Castle's Mould Group 1, comprising 14 bowls, matched with 16 examples from the same mould that were recorded at Pontefract.

Thirty-six of the Civil War bowls from Sandal have some bands of milling on or near the heel - 22 across the heel, 12 immediately behind the heel and two bowls with milling at the base of the heel on the front of the bowl. Some of the bowls from Pontefract castle also had this distinctive milling near the heel. Although milling on bowls and stems is known from other British sites, the nature of the milling and its close association with specific bowl types found around Sandal and Pontefract is unique. This could be the mark of a specific maker or workshop in the local area.

As with assemblage from Pontefract Castle, Sandal produced a small number of modified stems, 16 in total together with four modified bowls. One of the stems showed tooth wear; 13 stem fragments had faceted or ground ends and may have been used for graffiti; and one stem and four bowls, which appeared to have the ends of the stem ground for re-use. With the exception of one nineteenth-century stem with ground ends, all the modified stems and bowl fragments date from the Civil War period.

There was clearly links between Sandal and Pontefract – not just in terms of the troops serving at both castles but in the fact that it can be demonstrated through mould flaw analysis that bowls from the same workshop were being supplied to both castles.

The clay tobacco pipes from the excavations at Sandal Castle are now in the care of Wakefield Museum and Art Gallery.

Table 1: Excel catalogue of the pipes from Sandal Castle

Poode	Acc No	SF No	B	S	M	Date	H/S	B64	Bur	BX	M4	Rim	TT	TF	Cname	Sname	Other	P	T	M	Comments	
07629	1983.10.001	SC73 CWV1	1			1660-1690	H	6	G	0	4	B	-	-	I	G		H	R	S		
23302	1983.10.002	MGC3	1			1640-1660	H	7	G	0	4	B	-	-	R	W		H	R	S	Dutch; same as 1296; Mould Group 14	
07649	1983.10.003	SC K1	1			1630-1660	H	7	G	0	4	B	-	-	B	C		H	R	S		
07650	1983.10.004	SC73 AD1	1			1620-1640	H	7	G	0	4	B	-	-	G	W		H	R	S	Gabriel Westby of York	
07651	1983.10.005	SC W1 66		1		1660-1720	-	5	G	-	-	-	-	-	I	G		SX	R	S	Stem	
07653	1983.10.006	SC72 MDX	1			1660-1710	H	5	G	0	-	-	-	-	I	G		SX	R	S	Heel only	
07654	1983.10.007	SC W1 66	1			1620-1640	H	7	G	0	4	B	-	-	G	W		H	R	S	Gabriel Westby of York	
07655	1983.10.009	SC89 MG2	1			1630-1660	H	7	G	0	-	-	-	-	R	W		H	R	S	Same as 1296; no rim; Mould Group 14	
07656	1983.10.009	SC89 MG2 612	1			1630-1660	H	-	G	0	4	B	-	-	R	W		H	R	S	Dutch; Mould Group 14	
07630	1983.10.010	BDX+376	1			1630-1660	H	7	G	0	-	-	-	-	R	W		H	R	S	Same as 1296; no rim; Mould Group 14	
23265	1983.10.011	SC65 1	1			1630-1650	H	6	0	0	4	IB	-	-								HT:25.7; WD:17.1
23263	1983.10.011	SC65 1	1			1640-1660	H	7	0	0	4	IB	-	-								HT:29.9; WD:19.5
23264	1983.10.011	SC65 1	1			1640-1660	H	7	0	0	4	IB	-	-								HT:29.2; WD:18.3; Mould Group 3
23266	1983.10.011	SC65 1	1			1640-1660	-	-	0	-	4	B	-	-								Heel missing; similar to 1971; WD:18.4
23267	1983.10.011	SC65 1	1			1640-1660	H	7	0	0	/	B	-	-								Similar to 1295; WD: 18.0
23273	1983.10.012	C 1 66	1			1640-1660	H	7	0	0	-	-	-	-			Milled	BA				Rim missing; appears to be the same mould as Poode 23271; HT: -; WD: -; Mould Group 1 (Same as Pontefract Mould Group 1)
23270	1983.10.012	C 1 66	1			1640-1660	H	7	0	0	4	B	-	-			Milled	H				HT:27.7; WD:18.2
23271	1983.10.012	C 1 66	1			1640-1660	H	7	0	-	/	B	-	-			Milled	BH				Milled at bowl/stem junction behind the heel; HT: 28.1; WD: 19.3; Mould Group 1 (Same as Pontefract Mould Group 1)
23268	1983.10.012	C 1 66	1			1640-1660	H	7	0	0	4	IB	-	-								Similar to 1289; HT:28.1; WD: 18.7
23269	1983.10.012	C 1 66	1			1640-1660	H	7	0	-	4	B	-	-								Similar to 1294; HT: 27.5; WD: 17.7
23272	1983.10.012	C 1 66	1			1640-1660	H	6	0	0	4	B	-	-								Very small heel; HT: 29.4; WD: 19.1; Mould Group 13
23274	1983.10.013	K 1 66	1			1640-1660	H	7	0	0	4	B	-	-			Milled	H				Similar to 1288; HT: 28.8; WD: 17.7
23275	1983.10.013	K 1 66	1			1640-1660	H	7	0	0	/	B	-	-								Similar to 1290; HT: -; WD: 18.0
23276	1983.10.013	K 1 66	1			1640-1660	H	7	0	0	/	B	-	-								HT: 30.5; WD: 18.2
23277	1983.10.013	K 1 66	1			1660-1680	H	6	0	0	4	B	-	-								
23260	1983.10.014	SC K3	1			1630-1650	H	7	0	0	/	B	-	-								WD: 18.7
23278	1983.10.014	SC K3	1			1640-1660	H	7	0	0	4	IB	-	-								Similar to 2009; HT 29.9; WD 19.2; Mould Group 8
23279	1983.10.014	SC K3	1			1640-1660	H	6	0	0	4	B	-	-								Similar to 1970; WD:19.2
23281	1983.10.014	SC K3	1			1640-1660	H	7	0	0	-	-	-	-								Heel fragment only
23282	1983.10.015	SC K12	1			1640-1660	H	7	0	0	4	B	-	-								Quite forward leaning; HT: 28.2; WD: 18.1
23283	1983.10.015	SC K12	1			1640-1660	H	8	0	-	/	B	-	-								Possibly same mould as Poode 7631; HT: 27.4; WD: 17.8
23284	1983.10.015	SC K12	1			1640-1660	H	7	0	0	/	B	-	-								Similar to 1290; HT: 28.4; WD: 18.1
23285	1983.10.015	SC K12	1			1640-1660	H	7	0	0	4	B	-	-								Similar to 1288; HT: 26.9; WD: 18.1
23286	1983.10.015	SC K12	1			1640-1660	H	7	0	0	4	IB	-	-								Similar to 1289; HT: 27.6; WD: 18.3



Table 1 (contd.): Excel catalogue of the pipes from Sandal Castle.

Poode	Acc No	SF No	B	S	M	Date	H/S	B64	Bur	BX	MM	Rim	TT	TF	Cname	Sname	Other	P	T	M	Comments	
24574	1983.10.025	MSC67 E1	1			1640-1660	-	-	-	0	/	B	-	-								Small bowl fragment
23314	1983.10.026	MSC 67 G1	1			1640-1660	H	7	-	-	/	B	-	-								Similar to 1980; HT: 27.3; WD: 17.1
23312	1983.10.026	MSC 67 G1	1			1640-1660	H	6	0	0	-	-	-	-			Milled	BH				Heel fragment only; milled at bowlstem junction behind the heel
23310	1983.10.026	MSC 67 G1	1			1640-1660	H	6	0	0	4	B	-	-								Similar to 1288; HT: 27.7; WD: 18.3
23311	1983.10.026	MSC 67 G1	1			1640-1660	-	-	0	-	4	B	-	-								No heel; similar to 1974; too fragmentary to take accurate measurements of the height and width
23313	1983.10.026	MSC 67 G1	1			1640-1660	H	7	0	0	4	IB	-	-								HT: 28.7; WD:18.7
23315	1983.10.026	MSC 67 G1	1			1640-1660	H	6	0	-	-	-	-	-								Heel fragment only
23316	1983.10.026	MSC 67 G1	1			1640-1660	H	6	0	-	-	-	-	-								Heel fragment only
23317	1983.10.026	MSC 67 G1	1			1640-1660	H	7	0	-	-	-	-	-								Heel fragment only
	1983.10.026	MSC67 G1			1	1630-1670		8	0					C	0							
	1983.10.026	MSC67 G1		2		1630-1670		8	0													1 with ground end
	1983.10.026	MSC67 G1		8		1630-1670		7	0													
	1983.10.026	MSC67 G1		4		1630-1670		6	0													
07644	1983.10.027	MSC67 F1	1			1640-1660	H	7	-	0	/	-	-	-								Similar to 1289; HT: -; WD: 17.5
07635	1983.10.027	MSC67 F1	1			1640-1660	H	7	0	-	4	IB	-	-								HT: 27.6; WD: 17.7
07636	1983.10.027	MSC67 F1	1			1640-1660	H	7	0	0	4	IB	-	-								HT: 24.8; WD: 17.8
07637	1983.10.027	MSC67 F1	1			1640-1660	H	7	0	0	4	IB	-	-								Similar to 1289; HT: 27.3; WD: 18.1
07638	1983.10.027	MSC67 F1	1			1640-1660	H	7	0	0	/	IB	-	-								Similar to 1289; HT: 24.5; WD: 18.1
07639	1983.10.027	MSC67 F1	1			1640-1660	H	7	0	0	/	IB	-	-								Similar to 1289; HT: 27.5; WD: -
07640	1983.10.027	MSC67 F1	1			1640-1660	H	7	0	-	/	B	-	-								Similar to 1289; shiny surface; HT: -; WD: 18.2; Mould Group 4
07641	1983.10.027	MSC67 F1	1			1640-1660	H	7	0	0	4	IB	-	-								Similar to 1289; HT: 27.4; WD: 17.7
07642	1983.10.027	MSC67 F1	1			1640-1660	H	6	0	0	/	IB	-	-								Similar to 1289; HT: -; WD: 17.9
07643	1983.10.027	MSC67 F1	1			1640-1660	H	6	0	0	4	IB	-	-								Similar to 1289; HT: 27.8; WD: 17.4
07645	1983.10.027	MSC67 F1	1			1640-1660	H	7	0	0	-	-	-	-								Similar to 1289; no rim
07646	1983.10.027	MSC67 F1	1			1640-1660	H	6	0	0	-	-	-	-								Similar to 1289; no rim
07647	1983.10.027	MSC67 F1	1			1640-1660	H	7	0	0	4	B	-	-								Similar to 1288; HT: 27.3; WD: 18.5
07648	1983.10.027	MSC67 F1	1			1640-1660	H	7	0	0	4	B	-	-								Similar to 1288; HT: 25.4; WD: 17.5
23399	1983.10.027	MSC67 F1	1			1640-1660	H	7	0	-	-	-	-	-								Heel fragment only
23400	1983.10.027	MSC67 F1	1			1640-1660	H	7	0	-	-	-	-	-								Heel fragment only
23401	1983.10.027	MSC67 F1	1			1640-1660	H	6	0	-	-	-	-	-								Heel fragment only
23402	1983.10.027	MSC67 F1	1			1640-1660	H	7	0	-	-	-	-	-								Heel fragment only
23403	1983.10.027	MSC67 F1	1			1640-1660	H	7	0	-	-	-	-	-								Heel fragment only
23404	1983.10.027	MSC67 F1	1			1640-1660	H	7	0	-	-	-	-	-								Heel fragment only
23405	1983.10.027	MSC67 F1	1			1640-1660	H	7	0	-	-	-	-	-								Heel fragment only
23406	1983.10.027	MSC67 F1	1			1640-1660	H	6	0	-	-	-	-	-								Heart shaped heel fragment only
23407	1983.10.027	MSC67 F1	1			1640-1660	H	7	0	-	-	-	-	-								Heart shaped heel fragment only

Table 1 (contd.): Excel catalogue of the pipes from Sandal Castle.

Poode	Acc No	SF No	B	S	M	Date	H/S	B64	Bur	BX	M4	Rim	TT	TF	Cname	Sname	Other	P	T	M	Comments	
23408	1983.10.027	MSC67 F1	1			1640-1660	H	7	0	-	/	B	-	-								Joining bowl and heel fragment; not enough surviving to take accurate measurements
	1983.10.027	SC67 F1		26	1	1630-1670		6	0				C	0								
	1983.10.027	SC67 F1		4		1630-1670		8	0													
	1983.10.027	SC67 F1		53		1630-1670		7	0													
	1983.10.027	SC67 F1		1		1630-1670		6	0													Oval in section
	1983.10.027	SC67 F1		8		1630-1670		7	0													Oval in section
	1983.10.027	SC67 F1		24	1	1630-1670		7	0				C	0								Two with ground ends
	1983.10.027	SC67 F1		1		17th/18th C		-	0													
	1983.10.027	SC67 F1		3		18th C		4	0													
24575	1983.10.027	SC67 F1	1			1640-1660	-	-	-	0	/	B	-	-								Small bowl fragment
24576	1983.10.027	SC67 F1	1			1640-1660	-	-	-	0	/	IB	-	-								Small bowl fragment
24614	1983.10.027	SC67 F1	1			1640-1660	-	-	-	0	/	B	-	-								Small bowl fragment
24615	1983.10.027	SC67 F1	1			1640-1660	-	-	-	0	/	IB	-	-								Small bowl fragment
24616	1983.10.027	SC67 F1	1			1640-1660	-	-	-	0	/	IB	-	-								Small bowl fragment
	1983.10.027	SC67 F1		2		1630-1670		7	A													
23318	1983.10.028	MSC 67 H1	1			1640-1660	H	6	0	0	4	B	-	-								Similar to 1288; HT: 29.2; WD: 18.6
23319	1983.10.028	MSC 67 H1	1			1640-1660	H	7	0	0	4	B	-	-								Similar to 1982; HT: 27.6; WD: 18.4
23321	1983.10.028	MSC 67 H1	1			1640-1660	H	7	0	-	-	-	-	-								Heel fragment only; shiny surface but no obvious burnishing lines visible
23322	1983.10.028	MSC 67 H1	1			1640-1660	H	7	0	-	-	-	-	-								Heel fragment only; heel trimmed flush to the stem
23323	1983.10.028	MSC 67 H1	1			1640-1660	H	6	0	0	4	B	-	-								Similar to 1970; HT: 28.4; WD: 18.7
23324	1983.10.028	MSC 67 H1	1			1640-1660	H	6	0	0	4	B	-	-								Similar to 1976; HT: 28.3; WD: 17.7
23325	1983.10.028	MSC 67 H1	1			1640-1660	H	5	0	0	4	B	-	-								Similar to 1971; HT: 27.8; WD: 18.1
23320	1983.10.028	MSC 67 W6	1			1640-1660	H	6	0	-	-	-	-	-								Heel fragment only
	1983.10.028	MSC67 H1		2		1630-1670		8	0													
	1983.10.028	MSC67 H1		11		1630-1670		7	0													
	1983.10.028	MSC67 H1		18		1630-1670		6	0													
	1983.10.028	MSC67 H1		1		1630-1670		-	0													
24577	1983.10.028	MSC67 H1	1			1640-1660	-	-	-	0	/	B	-	-								Small bowl fragment
	1983.10.028	MSC67 H1		5		18th/19th C		4	0													
	1983.10.028	MSC67 H1		1		19th C		3	0													
23326	1983.10.029	MSC 67 I1	1			1640-1660	H	7	0	0	4	B	-	-								Similar to 1971; HT: 27.9; WD: 17.5; Mould Group 10
	1983.10.029	MSC67 I1		1		1630-1670		7	0													
	1983.10.029	MSC67 I1		1		1630-1670		6	0													
23327	1983.10.030	MSC 67 W6	1			1640-1660	H	7	0	0	-	-	-	-			Milled	BH				Heel fragment only; milled at bowl/stem junction behind the heel; Mould Group 1 (Same as Pontefract Mould Group 1)
23328	1983.10.030	MSC 67 W6	1			1640-1660	H	7	0	-	-	-	-	-								Heel fragment only
23329	1983.10.030	MSC 67 W6	1			1640-1660	H	6	0	-	-	-	-	-								Heel fragment only

Table 1 (contd.): Excel catalogue of the pipes from Sandal Castle.

Pcode	Acc No	SF No	B	S	M	Date	H/S	B64	Bur	BX	MM	Rim	TT	TF	Cname	Sname	Other	P	T	M	Comments	
23330	1983.10.030	MSC 67 W6	1			1640-1660	H	6	0	0	-	-	-	-								Heel fragment only; stem ground for reuse
23331	1983.10.030	MSC 67 W6	1			1640-1660	H	6	0	0	4	B	-	-								Same mould as 1292 but no milling on the heel; HT: 30.9; WD: 18.8; Mould Group 6
23332	1983.10.030	MSC 67 W6	1			1640-1660	H	7	0	0	4	IB	-	-								Same as 1288; HT: 27.8; WD: 18.3
23333	1983.10.030	MSC 67 W6	1			1640-1660	H	6	0	0	4	B	-	-								HT: 28.7; WD: 19.4; Mould Group 1 (Same as Pontefract Mould Group 1)
23334	1983.10.030	MSC 67 W6	1			1640-1660	H	6	0	0	4	B	-	-								Similar to 1965; HT: 28.7; WD: 19.2
	1983.10.030	MSC67 W6			1	1630-1670		7	0					C	0							
	1983.10.030	MSC67 W6		1		1630-1670		9	0													
	1983.10.030	MSC67 W6		17		1630-1670		7	0													
	1983.10.030	MSC67 W6		7		1630-1670		6	0													
	1983.10.030	MSC67 W6		2		1630-1670		6	0													
	1983.10.030	MSC67 W6		1		1630-1670		6	G													
	1983.10.030	MSC67 W6		7		18th/19th C		5	0													
	1983.10.030	MSC67 W6		3		18th/19th C		4	0													
	1983.10.030	MSC67 W6			2	19th C		4	0					C	YG							Glazed mouthpieces
	1983.10.031	SC68 MMF 196		1		1630-1670		7	0													
23335	1983.10.032	M1 303	1			1640-1660	H	7	0	-	-	-	-	-								Heel fragment only
	1983.10.032	M1 305		2		1630-1670		7	0													
	1983.10.032	M1 305		1		1630-1670		-	0													
23336	1983.10.032	M1 305	1			1640-1660	H	6	0	0	-	-	-	-								Heel fragment only
23337	1983.10.032	M1 308	1			1640-1660	H	7	0	0	4	B	-	-								HT: 29.9; WD: 19.1; Mould Group 1 (Same as Pontefract Mould Group 1)
	1983.10.032	M1 318		1		1630-1670		7	0													
	1983.10.032	M1 445		1		1630-1670		7	0													
	1983.10.033	M3 447		1		1630-1670		7	0													
23340	1983.10.033	M3 447	1			1640-1660	H	7	0	-	-	-	-	-			Milled	BH				Heel fragment only, milled at the bowl/stem junction behind the heel.
23338	1983.10.033	M3 447	1			1640-1660	H	7	0	0	4	B	-	-								HT: 28.6; WD: 18.6; Mould Group 13
23339	1983.10.033	M3 447	1			1640-1660	H	7	0	0	4	B	-	-								Heart shaped heel; HT: 29.9; WD: 18.7; Mould Group 11
	1983.10.034	M5 459		2		1630-1670		7	0													
	1983.10.034	M5 459		2		1630-1670		6	0													
	1983.10.035	M9 424		1		1630-1670		7	0													
	1983.10.036	MF2 141		2		1630-1670		8	0													
	1983.10.036	MF2 141		4		1630-1670		-	0													
	1983.10.036	MF2 141		39	1	1630-1670		6	0					C	0							
	1983.10.036	MF2 141		139	3	1630-1670		7	0					C	0							One of the mouthpieces joins three of the stem fragments
24583	1983.10.036	MF2 141	1			1640-1660	-	-	-	0	-	-	-	-								Small bowl fragment
24584	1983.10.036	MF2 141	1			1640-1660	-	-	-	0	-	-	-	-								Small bowl fragment





*Table 1 (contd.): Excel catalogue of the pipes from Sandal Castle.*

Poode	Acc No	SF No	B	S	M	Date	H/S	B64	Bur	BX	M4	Rim	TT	TF	Cname	Sname	Other	P	T	M	Comments	
	1983.10.040	MIN1 307		2		1630-1670		6	0													
23342	1983.10.040	MIN1 307	1			1640-1660	H	7	0	0	/	IB	-	-								Similar to 1269; HT: 26.8; WD: 17.4
23343	1983.10.040	MIN1 307	1			1640-1660	H	7	0	-	-	-	-	-								Heel fragment only
	1983.10.041	MIN2 189		1		1630-1670		7	0													
	1983.10.042	MO1 397		11		1630-1670		7	0													One stem ground for reuse
	1983.10.042	MO1 397		5		1630-1670		6	0													
23344	1983.10.042	MO1 397	1			1640-1660	H	7	0	-	-	-	-	-								Heel fragment only
	1983.10.043	NE1 222			1	1630-1670		7	0					C	0							
	1983.10.044	MD2 620		1		1630-1670		7	0													
23345	1983.10.044	MD2 620	1			1640-1660	H	7	0	0	4	IB	-	-								Similar to 1290; HT: 27.5; WD: 18.5
	1983.10.045	MF1			2	1630-1670		7	0					C	0							One has oval section
	1983.10.045	MF1		4		1630-1670		8	0													
	1983.10.045	MF1		41		1630-1670		7	0													
	1983.10.045	MF1		21		1630-1670		6	0													
	1983.10.045	MF1		1		1630-1670		-	0													
24585	1983.10.045	MF1	1			1640-1660	-	-	-	0	/	B	-	-								Small bowl fragment
23347	1983.10.045	MF1 679	1			1640-1660	H	7	0	-	4	B	-	-								Similar to 1269; HT: 27.4; WD: 17.5
23348	1983.10.045	MF1 679	1			1640-1660	H	6	0	-	4	B	-	-								Similar to 1269; HT: 27.5; WD: 17.4
23349	1983.10.045	MF1 682	1			1640-1660	H	6	0	-	/	B	-	-								Similar to 1973; HT: 26.2; WD: 17.8
23346	1983.10.045	MF1 689	1			1640-1660	H	7	0	-	4	B	-	-								Similar to 1269; HT: 28.3; WD: 17.4
23350	1983.10.045	MF1 689	1			1640-1660	H	6	0	-	-	-	-	-								Heel fragment only
24586	1983.10.046	MG1	1			1640-1660	-	7	-	0	-	-	-	-								Small bowl fragment
	1983.10.046	MG1		3	1	1630-1670		8	0					C	0							
	1983.10.046	MG1		1		1630-1670		9	0													
	1983.10.046	MG1		12		1630-1670		7	0													
23352	1983.10.046	MG1 611	1			1640-1660	H	7	0	-	/	B	-	-								Similar to 1971; HT: -; WD: 18.6
23354	1983.10.046	MG1 611	1			1640-1660	H	-	0	-	/	B	-	-								Bowl fragment only
23355	1983.10.046	MG1 611	1			1660-1680	H	7	0	-	3	B	-	-								
23353	1983.10.046	MG1 625	1			1640-1660	H	7	0	-	-	-	-	-								Heel fragment only
23351	1983.10.046	MH1 611	1			1640-1660	H	7	0	-	4	B	-	-								Similar to 1968; HT: 28.4; WD: 18.4
	1983.10.047	MG2		4	1	1630-1670		8	0					C	0							
	1983.10.047	MG2		7		1630-1670		7	0													
	1983.10.047	MG2		4		1630-1670		6	0													
	1983.10.047	MG2		1		1630-1670		6	P													
23356	1983.10.047	MG2 612	1			1640-1660	H	7	0	-	-	-	-	-								Heel fragment only; possibly part of a heart shaped heel
23360	1983.10.047	MG2 612	1			1640-1660	H	6	0	0	4	B	-	-								Similar to 1985; HT: 27.1; WD: 18.9
23357	1983.10.047	MG2 614	1			1640-1660	H	7	0	-	-	-	-	-								Heel fragment only
23359	1983.10.047	MG2 614	1			1640-1660	H	7	0	0	4	B	-	-								Similar to 1990; HT: 29.1; WD: 18.9; Mould Group 11
23361	1983.10.047	MG2 614	1			1640-1660	H	7	0	0	4	B	-	-								Similar to 1971; HT: 27.7; WD: 18.6

Table 1 (contd.): Excel catalogue of the pipes from Sandal Castle.

Pcode	Acc No	SF No	B	S	M	Date	H/S	B64	Bur	BX	M4	Rim	TT	TF	Cname	Sname	Other	P	T	M	Comments
23358	1983.10.047	MG2 637	1			1640-1660	H	6	0	-	-	-	-	-			Milled	H			Heel fragment only
23362	1983.10.048	MG17 636	1			1640-1660	H	7	0	0	4	B	-	-							Similar to 1971; HT: 26.7; WD: 17.4; Mould Group 10
	1983.10.048	MG4		3		1630-1670		7	0												
24587	1983.10.048	MG4	1			1640-1660	H	-	-	0	-	-	-	-							
24588	1983.10.048	MG4	1			1640-1660	-	-	-	0	4	B	-	-							
	1983.10.048	MG4		1		1630-1670		8	G												
23363	1983.10.048	MG4 662	1			1640-1660	H	7	0	0	4	B	-	-							HT: 27.9; WD: 18.8; Same mould a Pontefract Mould Group 4
	1983.10.049	ID 819		1		1630-1670		7	0												
23364	1983.10.049	ID 819	1			1640-1660	H	7	0	0	4	B	-	-							Similar to 1982; HT: 27.3; WD: 17.7
23365	1983.10.049	ID 819	1			1640-1660	H	7	0	0	/	B	-	-							Similar to 1982; HT: 27.7; WD: 17.7; Mould Group 4
23366	1983.10.049	ID 819	1			1640-1660	H	6	0	-	-	-	-	-							Heel fragment only
	1983.10.050	ID2 856		1		1630-1670		6	0												
	1983.10.051	M 815		1		18th C		6	0												
	1983.10.052	MD 816		1		18th C		6	0												
	1983.10.053	MK 818		2		1630-1670		7	0												
	1983.10.054	WC 805		28	1	1630-1670		7	0					C	0						
	1983.10.054	WC 805		11	3	1630-1670		6	0					C	0						
	1983.10.054	WC 805		4		18th C		5	0												
23374	1983.10.054	WC 805	1			1640-1660	H	6	0	0	4	B	-	-			Milled	H			HT: 30.1; WD: 18.05
23367	1983.10.054	WC 805	1			1640-1660	-	-	0	-	4	B	-	-							Rim fragment only
23368	1983.10.054	WC 805	1			1640-1660	-	-	0	-	4	B	-	-							Rim fragment only
23369	1983.10.054	WC 805	1			1640-1660	H	6	0	0	-	-	-	-							Heel fragment only
23370	1983.10.054	WC 805	1			1640-1660	H	7	0	0	-	-	-	-							Similar to 1985; HT: -, WD: 18.7
23371	1983.10.054	WC 805	1			1640-1660	H	-	0	0	/	B	-	-							Small bowl fragment
23372	1983.10.054	WC 805	1			1640-1660	H	6	0	0	/	B	-	-							Similar to 1982; HT: 28.8; WD: 18.4
23373	1983.10.054	WC 805	1			1640-1660	H	7	0	0	1	B	-	-							HT: 28.8; WD: 18.8
	1983.10.054	WC 805			2	19th C		4	-					C	YG						
	1983.10.055	WC1 808		4		1630-1670		7	0								Milled	S			One broken just behind heel and band of milling visible
	1983.10.055	WC1 808		1		1630-1670		9	0												
	1983.10.055	WC1 808		3		1630-1670		8	0												
	1983.10.055	WC1 808		2		1630-1670		6	0												
24589	1983.10.055	WC1 808	1			1640-1660	-	-	-	0	4	B	-	-							
23377	1983.10.055	WC1 808	1			1640-1660	H	7	0	0	4	B	-	-			Milled	BH			Milled at bowl/stem junction behind the heel; HT: 31.3; WD: 18.9
23375	1983.10.055	WC1 808	1			1640-1660	H	6	0	-	-	-	-	-							Heel fragment only
23376	1983.10.055	WC1 808	1			1640-1660	H	7	0	-	-	-	-	-							Heel fragment only
23380	1983.10.056	MWC 830	1			1640-1660	H	6	0	0	-	-	-	-			Milled	BH			Heel fragment only; milled at bowl/stem junction behind the heel
23378	1983.10.056	MWC 830	1			1640-1660	H	7	0	-	-	-	-	-							Heel fragment only
23381	1983.10.056	MWC 830	1			1640-1660	H	7	0	0	4	B	-	-							HT: 27.2; WD: 18.3

Table 1 (contd.): Excel catalogue of the pipes from Sandal Castle.

Pcode	Acc No	SF No	B	S	M	Date	H/S	B64	Bur	BX	M4	Rim	TT	TF	Cname	Sname	Other	P	T	M	Comments	
	1983.10.056	MWC 842		7	1	1630-1670		7	0													
	1983.10.056	MWC 842		2		17th/18th C		6	0													
	1983.10.056	MWC 842		1		17th/18th C		5	0													
23379	1983.10.056	MWC 842	1			1640-1660	H	7	0	0	-	-	-	-			Milled	BH				Heel fragment only; milled at bowl/stem junction behind the heel
	1983.10.056	MWC 842		2		17th/18th C		6	G													
	1983.10.056	MWC 842		1	1	19th C		4	-					-	YG							
	1983.10.057	BB/B		8	1	1630-1670		7	0					C	0							
	1983.10.057	BB/B		2		1630-1670		6	0													
	1983.10.058	BB1		1		1630-1670		8	0													
	1983.10.058	BB1		1		1630-1670		7	0													
	1983.10.058	BB1		1		1630-1670		6	0													
23382	1983.10.058	BB1	1			1640-1660	H	7	0	-	-	-	-	-								Heel fragment only
23383	1983.10.058	BB1	1			1640-1660	H	7	0	0	/	B	-	-								HT: 26.9; WD: 17.05
	1983.10.059	BCA+		1		17th/18th C		6	0													Oval in section
	1983.10.060	BDA1		1		1630-1670		8	0													
	1983.10.060	BDA1		3		1630-1670		7	0													
23384	1983.10.060	BDA2	1			1640-1660	H	7	0	-	/	B	-	-								Similar to 1970; HT: 29.6; WD: 18.7
23385	1983.10.060	BDA2	1			1640-1660	H	7	0	-	/	B	-	-								Similar to 1989; HT: 29.2; WD: 19.6; cut mark on heel running from front to back
23386	1983.10.060	BDA2	1			1660-1680	H	7	0	0	4	B	-	-								Does not appear to be a Yorkshire form
	1983.10.061	BDA2		1		1630-1670		7	0													
	1983.10.061	BDA2		2		1630-1670		6	0													
	1983.10.062	KB2		1		1630-1670		8	0													
	1983.10.062	KB2		12		1630-1670		7	0													One stem ground for reuse; one stem faceted
	1983.10.062	KB2		6		1630-1670		6	0													
24590	1983.10.062	KB2	1			1640-1660	-	-	-	0	/	B	-	-								
23387	1983.10.062	KB2	1			1640-1660	H	7	0	-	-	-	-	-								Heel fragment only
23388	1983.10.062	KB2	1			1640-1660	H	7	0	-	-	-	-	-								Heel fragment only; broken stem appears to have been ground, unclear if this was for reuse or if fragment was used as a piece of chalk
	1983.10.063	MDX1		6	1	1630-1670		6	0					C	0							
	1983.10.063	MDX1		6		1630-1670		7	0													
	1983.10.063	MDX1		1		1630-1670		9	0													
23389	1983.10.063	MDX1	1			1640-1660	H	7	0	0	4	B	-	-								HT: 25.7; WD: 17.9
	1983.10.063	MDX1		1		18th/19th C		4	0													
	1983.10.063	MDX1		1		19th C		3	0													Mould decoration, possibly part of a claw bowl



Table 1 (contd.): Excel catalogue of the pipes from Sandal Castle.

Pcode	Acc No	SF No	B	S	M	Date	H/S	B64	Bur	BX	M4	Rim	TT	TF	Cname	Sname	Other	P	T	M	Comments	
	1983.10.071	SC72 94		5		1630-1670		7	0													
	1983.10.071	SC72 94		1		1630-1670		-	0													
23410	1983.10.071	SC72 94	1			1640-1660	H	7	0	-	-	-	-	-								Heel fragment only, quite distinctive mould flew on RHS of heel
23409	1983.10.071	SC72 96	1			1640-1660	H	7	0	0	4	B	-	-								Similar to 1970: HT: 28.4; WD: 18.2
	1983.10.072	SC72 538		2		1630-1670		8	0													
24591	1983.10.072	SC72 538	1			1640-1660	-	-	-	0	/	IB	-	-								
	1983.10.073	BDD-25			1	19th C		4	0				N	0								Both ends of fragment ground
	1983.10.074	SC72 759		1		1630-1670		7	0													
23411	1983.10.074	SC72 759	1			1640-1660	H	7	0	0	4	B	-	-								Similar to 1985; HT: 28.8; WD: 18.6; Mould Group 2
	1983.10.075	BDD-1 506		1		1630-1670		7	0													
	1983.10.075	BDD-1 506		1		1630-1670		8	0													
23412	1983.10.075	SC72 BDD-1	1			1640-1660	H	-	0	-	4	B	-	-								HT: 28.8; WD: 18.7
	1983.10.076	BDD/E-1 179		6		1630-1670		7	0													Includes three joining pieces
	1983.10.076	BDD/E-1 179		2		1630-1670		8	0													
	1983.10.076	BDD/E-1 179		1		18th C		5	0													
23413	1983.10.076	SC72 179	1			1640-1660	H	7	0	0	4	B	-	-								HT: 29.6; WD: 18.7
	1983.10.077	SC72 107		1		1630-1670		8	0													
	1983.10.077	SC72 107		1		1630-1670		7	0													
	1983.10.077	SC72 107		1		1630-1670		6	0													
	1983.10.077	SC72 87		1		1630-1670		7	0													
	1983.10.077	SC72 87		1		1630-1670		8	0													
	1983.10.078	SC72 128		1		1630-1670		8	0													
	1983.10.078	SC72 128		1		1630-1670		6	0													
	1983.10.079	SC72 108		4		1630-1670		7	0													
	1983.10.081	SC72 348		1		1630-1670		7	0													
23414	1983.10.082	SC72 116	1			1640-1660	H	7	0	-	-	-	-	-								Heel fragment only
	1983.10.082	SC72 14		1		1630-1670		6	0													
23416	1983.10.082	SC72 14	1			1640-1660	H	7	0	-	-	-	-	-								Heel fragment only
	1983.10.082	SC72 485		1		1630-1670		8	0													
	1983.10.082	SC72 485		1		1630-1670		6	0													
	1983.10.082	SC72 485			1	1630-1670		7	0				C	0								
	1983.10.082	SC72 52		1		1630-1670		7	0													
23415	1983.10.082	SC72 542	1			1640-1660	H	6	0	0	/	B	-	-								Similar to 1982; HT: 28.3; WD: 18.1
	1983.10.083	SC72 157		1		1630-1670		7	0													
23417	1983.10.084	SC72 466	1			1640-1660	H	7	0	-	-	-	-	-			Milled	H				Heel fragment only

Table 1 (contd.): Excel catalogue of the pipes from Sandal Castle.

Pcode	Acc No	SF No	B	S	M	Date	H/S	B64	Bur	BX	MM	Rim	TT	TF	Cname	Sname	Other	P	T	M	Comments	
	1983.10.085	BDP1 541		1		1630-1670		6	0													
	1983.10.086	BDX+ 376		2		1630-1670		7	0													
23418	1983.10.086	BDX+ 376	1			1640-1660	H	7	0	-	-	-	-	-			Milled	BH				Heel fragment only, milled at bowl/stem junction behind the heel
	1983.10.086	SC72 308		2		1630-1670		7	0													
	1983.10.086	SC72 308		3		1630-1670		6	0													
	1983.10.087	BDX1 539		1		1630-1670		7	0													
23419	1983.10.087	BDX1 539	1			1640-1660	H	7	0	-	-	-	-	-								Heel fragment only
	1983.10.087	SC72 281		1		1630-1670		7	0													
23421	1983.10.087	SC72 281	1			1640-1660	H	7	0	-	4	B	-	-			Milled	H				Similar to 2009; HT: 32.3; WD: 19.1; Mould Group 8
23422	1983.10.087	SC72 281	1			1640-1660	H	7	0	0	4	B	-	-								Similar to 1982; HT: -; WD: 17.8
	1983.10.087	SC72 351		2		1630-1670		7	0													
	1983.10.087	SC72 351		1		1630-1670		6	0													
23420	1983.10.087	SC72 351	1			1640-1660	S	7	0	-	-	-	-	-								Spur fragment only
	1983.10.088	SC72 71		3		1630-1670		7	0													
24592	1983.10.088	SC72 71	1			1640-1660	-	-	-	0	-	-	-	-								Very small bowl fragment
23423	1983.10.089	B2+ 473	1			1640-1660	H	7	0	0	3	IB	-	-			Milled	BH				Similar to 1988; milled at bowl/stem junction behind the heel; HT: -; WD: 19.1
	1983.10.089	SC72 407		1		1630-1670		8	0													
	1983.10.089	SC72 407		6		1630-1670		7	0													
	1983.10.090	SC72 487		1		1630-1670		7	0													
	1983.10.091	MDX+ 180		1		1630-1670		7	0													
23424	1983.10.091	MDX+ 180	1			1640-1660	H	7	0	0	4	B	-	-								Similar to 1289; HT: 27.05; WD: 17.9
	1983.10.091	MDX+ 40		2		1630-1670		6	0													
	1983.10.091	MDX+ 760		2		17th/18th C		6	0													
	1983.10.091	MDX+ 760		1		17th/18th C		5	0													
	1983.10.091	MDX+ 85		8		1630-1670		7	0													
	1983.10.091	MDX+ 85		1		1630-1670		6	0													
	1983.10.092	MDX1 1056		2		1630-1670		6	0													
	1983.10.092	MDX1 1056		1		1630-1670		7	0													
	1983.10.092	MDX1 142		2		1630-1670		7	0													
23431	1983.10.092	MDX1 142	1			1640-1660	H	8	0	0	-	-	-	-								Heel fragment only
	1983.10.092	MDX1 154		1		1630-1670		8	0													
	1983.10.092	MDX1 154		1		1630-1670		6	0													
	1983.10.092	MDX1 154		5		1630-1670		7	0													
24593	1983.10.092	MDX1 154	1			1640-1660	-	-	-	0	-	-	-	-								Small bowl fragment
07659	1983.10.092	MDX1 154	1			1640-1660	H	7	0	0	4	B	-	-								Same as 1288; HT: 28.05; WD: 18.7



Table 1 (contd.): Excel catalogue of the pipes from Sandal Castle.

Poode	Acc No	SF No	B	S	M	Date	H/S	B64	Bur	BX	M4	Rim	TT	TF	Cname	Sname	Other	P	T	M	Comments		
	1983.10.092	MSDX1 508		1		18th/19th C		4	0														
07658	1983.10.092	SC72MDX 1	1			1640-1660	H	-	0	0	4	B	-	-								HT: 29.1; WD: 18.7	
	1983.10.093	MDX2 988		1	1	1630-1670		7	0				C	0									
	1983.10.093	MDX2+544		7	1	1630-1670		7	0				C	0									
23435	1983.10.093	MDX2+544	1			1640-1660	H	6	0	-	-	-	-	-								Heel fragment only; shows that stem was broken and repaired before firing	
23436	1983.10.093	MDX2+544	1			1640-1660	H	8	0	0	4	B	-	-								Similar to 1970; HT: 29.1; WD: 19.4	
23437	1983.10.093	MDX2+544	1			1640-1660	H	7	0	0	4	B	-	-								Similar to 1976; HT: 29.6; WD: 17.05	
	1983.10.093	MDX2+763		1		1630-1670		6	0														
	1983.10.093	MDX2+763		12		1630-1670		7	0													One has a ground end	
24595	1983.10.093	MDX2+763	1			1640-1660	-	-	-	0	/	B	-	-								Small bowl fragment	
23433	1983.10.093	MDX2+763	1			1640-1660	H	6	0	0	/	B	-	-			Milled		H			Same mould as Poode 23429; Mould Group 7; HT: 27.7; WD: 17.4	
23434	1983.10.093	MDX2+763	1			1640-1660	H	7	0	-	-	-	-	-								Heel fragment only	
07664	1983.10.094	BDD/E+1 179	1			1630-1660	H	7	G	0	4	B	-	-	.R	W				H	R	S	Same as 1296; Mould Group 14
	1983.10.095	AA1 BAG 65		6	1	1630-1670		8	0														
	1983.10.095	AA1 BAG 65		9		1630-1670		6	0														
	1983.10.095	AA1 BAG 65		24		1630-1670		7	0													One stem faceted at both ends	
	1983.10.095	AA1 BAG 65		1		17th/18th C		-	0														
24596	1983.10.095	AA1 BAG 65	1			1640-1660	-	-	-	0	4	B	-	-								Bowl fragment	
24597	1983.10.095	AA1 BAG 65	1			1640-1660	H	-	-	0	-	-	-	-								Small bowl fragment	
23441	1983.10.095	AA1 BAG 65	1			1640-1660	H	6	0	-	4	B	-	-			Milled		H			Similar to 1989; HT: 31.1; WD: 19.05; Mould Group 1 (Same as Pontefract Mould Group 1)	
23446	1983.10.095	AA1 BAG 65	1			1640-1660	H	8	0	-	4	B	-	-			Milled		H			HT: 30.4; WD: 18.7	
23438	1983.10.095	AA1 BAG 65	1			1640-1660	H	6	0	-	-	-	-	-								Heel fragment only	
23439	1983.10.095	AA1 BAG 65	1			1640-1660	H	7	0	-	-	-	-	-								Heel fragment only; very distinctive mould flaws on both sides of the stem	
23440	1983.10.095	AA1 BAG 65	1			1640-1660	H	7	0	0	/	B	-	-								Same mould as 1292; HT: 31.1; WD: 18.7; Mould Group 6	



Table 1 (contd.): Excel catalogue of the pipes from Sandal Castle.

Poode	Acc No	SF No	B	S	M	Date	H/S	B64	Bur	BX	M4	Rim	TT	TF	Cname	Sname	Other	P	T	M	Comments	
23442	1983.10.095	AA1 BAG 65	1			1640-1660	H	6	0	-	/	B	-	-								Similar to 1290; HT: 27.2; WD: 18.7
23443	1983.10.095	AA1 BAG 65	1			1640-1660	H	5	0	0	4	B	-	-								Similar to 2005; HT: 26.6; WD: 19.7
23444	1983.10.095	AA1 BAG 65	1			1640-1660	H	7	0	0	/	-	-	-								Same mould as Poode 23294; Mould Group 5; HT: -; WD: -
23445	1983.10.095	AA1 BAG 65	1			1640-1660	H	8	0	-	-	-	-	-								Heart shaped heel fragment
	1983.10.095	AA1 BAG 65		1		18th/19th C		4	0													
	1983.10.096	AB1 BAG 69		2		1630-1670		8	0													
	1983.10.096	AB1 BAG 69			2	1630-1670		9	0				C	0								
	1983.10.096	AB1 BAG 69		6		1630-1670		6	0													
	1983.10.096	AB1 BAG 69		12	1	1630-1670		7	0				C	0								
23450	1983.10.096	AB1 BAG 69	1			1640-1660	H	6	0	-	-	-	-	-			Milled	H				Heel fragment only
23447	1983.10.096	AB1 BAG 69	1			1640-1660	H	7	0	-	-	-	-	-								Heel fragment only
23448	1983.10.096	AB1 BAG 69	1			1640-1660	H	7	0	-	-	-	-	-								Heel fragment only; broken stem ground possibly for reuse
23449	1983.10.096	AB1 BAG 69	1			1640-1660	H	7	0	-	-	-	-	-								Heel fragment only
23451	1983.10.096	AB1 BAG 69	1			1640-1660	H	7	0	-	-	-	-	-								Heel fragment only
23452	1983.10.096	AB1 BAG 69	1			1640-1660	-	7	0	-	-	-	-	-								Bowl fragment only
23453	1983.10.096	AB1 BAG 69	1			1640-1660	H	6	0	0	/	B	-	-								Similar to 1989; HT: 29.8; WD: 19.05; Mould Group 1 (Same as Pontefract Mould Group 1)
23454	1983.10.096	AB1 BAG 69	1			1640-1660	H	6	0	0	4	IB	-	-								Similar to 1982; HT: 28.3; WD: 18.2
	1983.10.097	AC2 BAG 100		1		1630-1670		7	0													
	1983.10.098	SC73 AD1		5		1630-1670		8	0													
	1983.10.098	SC73 AD1		3		1630-1670		-	0													
	1983.10.098	SC73 AD1		12		1630-1670		6	0													
	1983.10.098	SC73 AD1		40	1	1630-1670		7	0				C	0								One stem has a faceted end



Table 1 (contd.): Excel catalogue of the pipes from Sandal Castle.

Pcode	Acc No	SF No	B	S	M	Date	H/S	B64	Bur	BX	M4	Rim	TT	TF	Cname	Sname	Other	P	T	M	Comments	
	1983.10.107	AK5 BAG 610		1		1630-1670		8	0													
	1983.10.107	AK5 BAG 610		1		1630-1670		7	0													
	1983.10.108	AK6 BAG 635		1		17th/18th C		8	G													
23465	1983.10.109	CW/P1	1			1640-1660	H	6	0	0	4	B	-	-								HT: 27.3; WD: 17.9
23466	1983.10.109	CW/P1	1			1640-1660	H	7	0	-	-	-	-	-								Heel fragment only
	1983.10.109	SC73 CW/P1		6		1630-1670		7	0													
23467	1983.10.110	CW/PQ	1			1640-1660	H	7	0	-	/	B	-	-			Milled	H				Similar to 1989 but with a smaller, rounder heel; HT: -; WD: 18.8; Mould Group 9
23468	1983.10.110	CW/PQ	1			1640-1660	H	7	0	-	-	-	-	-								Heel fragment only
	1983.10.110	SC73 CW/PQ		4		1630-1670		7	0								Milled	S				One broken just behind heel and band of milling visible
	1983.10.110	SC73 CW/PQ		1		1630-1670		8	0													
	1983.10.110	SC73 CW/PQ		3		1630-1670		6	0													
	1983.10.111	CW/X/T1		2		1630-1670		7	0													
	1983.10.111	CW/X/T1		1		18th C		5	0													
23469	1983.10.111	CW/X/T1	1			1640-1660	H	6	0	0	4	B	-	-								Similar to 1290; HT: 26.5; WD: 17.9; deeply incised V shape scratched on heel
	1983.10.112	DBS1 BAG 300		1		1630-1670		7	0													
	1983.10.112	DBS1 BAG 300		1		17th/18th C		5	G													
	1983.10.113	SC73 F522		17		1630-1670		7	0													
	1983.10.113	SC73 F522		3		1630-1670		6	0													
	1983.10.113	SC73 F522		1		1630-1670		-	0													
23470	1983.10.113	SC73 F522	1			1640-1660	H	7	0	-	-	-	-	-			Milled	H				Heel fragment only
	1983.10.114	SC73 P1		1		1630-1670		6	0													
	1983.10.114	SC73 P1		5		1630-1670		7	0													
23471	1983.10.114	SC73 P1	1			1640-1660	H	6	0	-	-	-	-	-								Heart shaped heel fragment only
23472	1983.10.114	SC73 P1	1			1640-1660	H	7	0	0	4	B	-	-								Similar to 2000; HT: 27.4; WD: 18.4
	1983.10.115	Q1 BAG 51		5		1630-1670		7	0													
23473	1983.10.115	Q1 BAG 51	1			1640-1660	H	7	0	0	4	B	-	-								HT: 30.3; WD: 18.5; Mould Group 2
	1983.10.116	SC73 R1		1		1630-1670		6	0													
	1983.10.116	SC73 R1		1		1630-1670		8	0													
	1983.10.116	SC73 R1		4		1630-1670		7	0													
	1983.10.117	T1 2015		4		1630-1670		7	0													
	1983.10.117	T1 2015		2		1630-1670		6	0													

Table 1 (contd.): Excel catalogue of the pipes from Sandal Castle.

Poode	Acc No	SF No	B	S	M	Date	H/S	B64	Bur	BX	M4	Rim	TT	TF	Cname	Sname	Other	P	T	M	Comments	
	1983.10.118	T4 BAG 32		1		1630-1670		7	0													
	1983.10.118	T4 BAG 32		1		1630-1670		8	0													
	1983.10.119	TW1 BAG 79		1		1630-1670		7	0													
24573	1983.10.120	V1 BAG 38	1			1640-1660	-	-	-	0	/	B	-	-								Small bowl fragment
	1983.10.120	V1 BAG 38		2		17th/18th C		6	G													Two joining stem fragments
	1983.10.121	CY/Y1		4		1630-1670		7	0													
	1983.10.122	SC73 YY1		1		1630-1670		6	0													
	1983.10.122	SC73 YY1		3		1630-1670		7	0													
	1983.10.122	SC73 YY1		1		1630-1670		8	0													
23474	1983.10.122	SC73 YY1	1			1640-1660	H	7	0	-	-	-	-	-								Heel fragment only
23475	1983.10.122	SC73 YY1	1			1640-1660	H	7	0	0	4	B	-	-								Similar to 1989; HT: 29.8; WD: 19.5; Mould Group 1 (Same as Pontefract Mould Group 1)
	1983.10.123	SC73 YY2		3		1630-1670		8	0													
	1983.10.123	SC73 YY2		8		1630-1670		6	0													
	1983.10.123	SC73 YY2		12		1630-1670		7	0													One fragment shows possible tooth wear
	1983.10.123	SC73 YY2		5		18th C		5	0													Includes two joining stem fragments
07632	1983.10.123	SC73 YY2	1			1640-1660	H	7	0	0	4	B	-	-			Milled		H			Similar to 1288; HT: 29.1; WD: 18.1; Mould Group 3
23459	1983.10.123	SC73 YY2	1			1640-1660	H	7	0	-	-	-	-	-			Milled		BH			Heel fragment only; milled at bowl/stem junction behind the heel
07631	1983.10.123	SC73 YY2	1			1640-1660	H	7	0	0	4	B	-	-								HT: 28.1; WD: 18.2
07633	1983.10.123	SC73 YY2	1			1640-1660	H	7	0	0	4	B	-	-								Same as 1288; HT: 27.9; WD: 18.1
07634	1983.10.123	SC73 YY2	1			1640-1660	H	7	0	-	4	B	-	-								Similar to 1288; HT: 28.3; WD: 18.4
23457	1983.10.123	SC73 YY2	1			1640-1660	H	6	0	-	-	-	-	-								Heel fragment only
23458	1983.10.123	SC73 YY2	1			1640-1660	H	7	0	-	-	-	-	-								Heel fragment only
23460	1983.10.123	SC73 YY2	1			1640-1660	H	7	0	-	-	-	-	-								Heel fragment only
	1983.10.124	YY3 BAG 153		4		1630-1670		7	0													
	1983.10.125	YZ1 BAG 111		2		1630-1670		8	0													
	1983.10.125	YZ1 BAG 111		1		1630-1670		7	0													
	1983.10.125	YZ1 BAG 111		1		1630-1670		6	0													
	1983.10.126	Z1 BAG 62		1		1630-1670		8	0													
	1983.10.126	Z1 BAG 62		1		1630-1670		6	0													
	1983.10.126	Z1 BAG 62		12		1630-1670		7	0													
23476	1983.10.126	Z1 BAG 62	1			1640-1660	H	7	0	0	4	B	-	-			Milled		BH			One stem has ground face's at both ends Milled at bowl/stem junction behind the heel; HT: 29.7; WD: 19.7; Mould Group 1 (Same as Pontefract Mould Group 1)

*Table 1 (contd.): Excel catalogue of the pipes from Sandal Castle.*

Pcode	Acc No	SF No	B	S	M	Date	H/S	B64	Bur	BX	M4	Rim	TT	TF	Cname	Sname	Other	P	T	M	Comments
23477	1983.10.126	Z1 BAG 62	1			1640-1660	H	7	0	0	4	IB	-	-							HT: 28.6; WD: 18.6
	1983.10.126	Z1 BAG 62		1		18th/19th C		5	0												
	1983.10.126	Z1 BAG 62		1		19th C		4	0												Part of a curled pipe stem
	1983.10.127	Z1+ BAG 151		2		1630-1670		7	0												
	1983.10.127	Z1+ BAG 151		1		1630-1670		6	0												
		Totals:	310	1200	41																

## **Appendix 7: Data summaries by geographical sub-division and period**

The summary of the data collected for each of the six geographical sub-divisions of the county of Yorkshire is presented in the following tables. These tables comprise of the following for each area: -

**Table 1.** All fragments. This table records a count of each of the following attributes; number of bowls and stems; bowl types, i.e. heel, spur or unidentifiable (bowls only); types of bowl and stem mark; grades of burnishing; stem bore; degree of milling (bowls only) and presence or absence and type of bowl cross (bowls only)

The table is arranged to give a breakdown of each count in to those fragments that are unpublished (unpub), published (pub) or are fragments that have been imported (imp), for each of the seven chronological periods.

**Table 2.** Yorkshire products. As above but counts are given only of those fragments that are measurable and that have been identified as Yorkshire products, i.e. all obvious imports have been excluded.

The table presents a count, which includes published and unpublished fragments followed by a percentage (%) that count represents for each of the seven chronological periods.

**Table 3.** Sites. Count of the fragments recorded from each site for each of the seven chronological periods. This table includes a simple running number sequence in the far left-hand column

**Table 4.** Collections. Count of the fragments recorded from each collection for each of the seven chronological periods. This table includes a simple running number sequence in the far left-hand column.

**Table 5.** Imports. Count of the fragments recorded for each of the seven chronological periods and their suggested place of origin.

In addition to the above there are also a series of tables presenting figures for fragments of Yorkshire products found outside the county as Tables 1 to 4 above. In place of the Imports table (Table 5) there is a list of Yorkshire products found outside the county, details of which have been taken from Oswald's Pipe Index (1991).

**TABLE 1 – All fragments from West Yorkshire**

West Yorkshire	c1500-1610			c1610-1640			c1640-1660			c1660-1690			c1690-1720			c1700-1750		
	Unpub	Pub	Imp	Unpub	Pub	Imp	Unpub	Pub	Imp	Unpub	Pub	Imp	Unpub	Pub	Imp	Unpub	Pub	Imp
<b>Count: Bowls &amp; stems</b>																		
Bowls	2			129	32	5	1002	53	5	291	13	5	55		2	48	2	2
Stems				4		1	4						6			38		
<b>Totals:</b>	<b>2</b>	<b>0</b>	<b>0</b>	<b>133</b>	<b>32</b>	<b>6</b>	<b>1006</b>	<b>53</b>	<b>5</b>	<b>291</b>	<b>13</b>	<b>5</b>	<b>61</b>	<b>0</b>	<b>2</b>	<b>86</b>	<b>2</b>	<b>2</b>
<b>Bowl Types: Bowls only</b>																		
Heel bowls	2			80	32	5	860	50	1	247	13	2	39			21		
Spur bowls				3			18	3	4	15		3	10		2	12		2
Unidentified bowls				46			124			29			6			15		2
<b>Totals:</b>	<b>2</b>	<b>0</b>	<b>0</b>	<b>129</b>	<b>32</b>	<b>5</b>	<b>1002</b>	<b>53</b>	<b>5</b>	<b>291</b>	<b>13</b>	<b>5</b>	<b>55</b>	<b>0</b>	<b>2</b>	<b>48</b>	<b>2</b>	<b>2</b>
<b>Bowl Marks</b>																		
Stamped heel mark				12	1	5	43	3		79	11	1	7					
Moulded heel mark																10		
Moulded spur mark																		
Stamped bowl mark							4	4		3		3						
Moulded bowl mark																		
Unmarked bowls	2			117	31		955	50	1	208	2	1	42		1	33	2	2
<b>Totals:</b>	<b>2</b>	<b>0</b>	<b>0</b>	<b>129</b>	<b>32</b>	<b>5</b>	<b>1002</b>	<b>53</b>	<b>5</b>	<b>290</b>	<b>13</b>	<b>5</b>	<b>49</b>	<b>0</b>	<b>1</b>	<b>43</b>	<b>2</b>	<b>2</b>
<b>Stem Marks</b>																		
Stamped stem mark				1		1	3			1			12		1	43		
Stem twist																		
Unmarked stems				3			1											
<b>Totals:</b>	<b>0</b>	<b>0</b>	<b>0</b>	<b>4</b>	<b>0</b>	<b>1</b>	<b>4</b>	<b>0</b>	<b>0</b>	<b>1</b>	<b>0</b>	<b>0</b>	<b>12</b>	<b>0</b>	<b>1</b>	<b>43</b>	<b>0</b>	<b>0</b>
<b>Burnishing: Bowls &amp; stems</b>																		
No burnishing				107	29		855	37	2	169	4	2	13		1	46	1	2
Poor													2		1			
Average				1		1	11		1	30	1		12			2		
Good	2			17	2	5	47	16	1	55		3	26			32		
Fine							2			2			4					
Can't tell				8	1		91		1	35	8		4			6	1	
<b>Totals:</b>	<b>2</b>	<b>0</b>	<b>0</b>	<b>133</b>	<b>32</b>	<b>6</b>	<b>1006</b>	<b>53</b>	<b>5</b>	<b>291</b>	<b>13</b>	<b>5</b>	<b>61</b>	<b>0</b>	<b>2</b>	<b>86</b>	<b>2</b>	<b>2</b>
<b>Stem bore: Bowls &amp; stems</b>																		
Bore 3/64																1		
Bore 4/64													1			22	2	
Bore 5/64				1			35			25	1		21			43		
Bore 6/64				14	8		270	12	1	82	2	2	15		1	5		2
Bore 7/64	1			68	13	5	533	30	1	118		3	11			2		
Bore 8/64	1			10	6		31	5		4								
Bore 9/64				1			1											
Unmeasurable				39	5	1	136	6	3	62	10		13		1	13		
<b>Totals:</b>	<b>2</b>	<b>0</b>	<b>0</b>	<b>133</b>	<b>32</b>	<b>6</b>	<b>1006</b>	<b>53</b>	<b>5</b>	<b>291</b>	<b>13</b>	<b>5</b>	<b>61</b>	<b>0</b>	<b>2</b>	<b>86</b>	<b>2</b>	<b>2</b>
<b>Milling: Bowls only</b>																		
M4				59	22	3	428	28	1	32	3	2						
M3				4			28	9		12			1					
M2				1	1		33	3	1	26			5					
M1				1	1		12			8		1	4		1			
M0	1			4			54	5		115	3	1	23		1	23	1	1
Milling on all surviving rim				25	6		172	6	3	32	1		4			3		1
Unmeasurable	1			35	2	2	277	2		66	6	1	18			22	1	
<b>Totals:</b>	<b>2</b>	<b>0</b>	<b>0</b>	<b>129</b>	<b>32</b>	<b>5</b>	<b>1002</b>	<b>53</b>	<b>5</b>	<b>291</b>	<b>13</b>	<b>5</b>	<b>55</b>	<b>0</b>	<b>2</b>	<b>48</b>	<b>2</b>	<b>2</b>
<b>Bowl Crosses: Bowls only</b>																		
Type X																2		
Type +																		
No bowl cross	1			56	1	5	567	3	4	215	5	5	34		2	23	1	2
Can't tell	1			73	31		435	50	1	76	8		21			23	1	
<b>Totals:</b>	<b>2</b>	<b>0</b>	<b>0</b>	<b>129</b>	<b>32</b>	<b>5</b>	<b>1002</b>	<b>53</b>	<b>5</b>	<b>291</b>	<b>13</b>	<b>5</b>	<b>55</b>	<b>0</b>	<b>2</b>	<b>48</b>	<b>2</b>	<b>2</b>

(Table 1 continued)

West Yorkshire	c1750-1800			Totals:			TOTALS
	Unpub	Pub	Imp	Unpub	Pub	Imp	
<b>Count: Bowls &amp; stems</b>							
Bowls	5			1532	100	19	1632
Stems	3			55	0	1	55
<b>Totals:</b>	<b>8</b>	<b>0</b>	<b>0</b>	<b>1587</b>	<b>100</b>	<b>20</b>	<b>1687</b>
<b>Bowl Types: Bowls only</b>							
Heel bowls	0			1249	95	8	1344
Spur bowls	4			62	5	9	67
Unidentified bowls	1			221	0	2	221
<b>Totals:</b>	<b>4</b>	<b>0</b>	<b>0</b>	<b>1532</b>	<b>100</b>	<b>19</b>	<b>1632</b>
<b>Bowl Marks</b>							
Stamped heel mark				141	15	6	156
Moulded heel mark				10	0	0	10
Moulded spur mark				0	0	0	0
Stamped bowl mark				7	0	7	7
Moulded bowl mark	1			1	0	0	1
Unmarked bowls	3			1360	85	5	1445
<b>Totals:</b>	<b>4</b>	<b>0</b>	<b>0</b>	<b>1519</b>	<b>100</b>	<b>18</b>	<b>1619</b>
<b>Stem Marks</b>							
Stamped stem mark	4			64	0	2	64
Stem twist				0	0	0	0
Unmarked stems				4	0	0	4
<b>Totals:</b>	<b>4</b>	<b>0</b>	<b>0</b>	<b>68</b>	<b>0</b>	<b>2</b>	<b>68</b>
<b>Burnishing: Bowls &amp; stems</b>							
No burnishing	7			1197	71	7	1268
Poor				2	0	1	2
Average				56	1	2	57
Good	1			180	18	9	198
Fine				8	0	0	8
Can't tell				144	10	1	154
<b>Totals:</b>	<b>8</b>	<b>0</b>	<b>0</b>	<b>1587</b>	<b>100</b>	<b>20</b>	<b>1687</b>
<b>Stem bore: Bowls &amp; stems</b>							
Bore 3/64				1	0	0	1
Bore 4/64	1			24	2	0	26
Bore 5/64	3			128	1	0	129
Bore 6/64				386	22	6	408
Bore 7/64				733	43	9	776
Bore 8/64				46	11	0	57
Bore 9/64				2	0	0	2
Unmeasurable	4			267	21	5	288
<b>Totals:</b>	<b>8</b>	<b>0</b>	<b>0</b>	<b>1587</b>	<b>100</b>	<b>20</b>	<b>1687</b>
<b>Milling: Bowls only</b>							
M4				517	53	6	570
M3				45	9	0	54
M2				65	4	1	69
M1				25	1	2	26
M0	4			224	9	3	233
Milling on all surviving rim				236	13	4	249
Unmeasurable	1			420	11	3	431
<b>Totals:</b>	<b>5</b>	<b>0</b>	<b>0</b>	<b>1532</b>	<b>100</b>	<b>19</b>	<b>1632</b>
<b>Bowl Crosses: Bowls only</b>							
Type X				2	0	0	2
Type +				0	0	0	0
No bowl cross	5			901	10	18	911
Can't tell				629	90	1	719
<b>Totals:</b>	<b>5</b>	<b>0</b>	<b>0</b>	<b>1532</b>	<b>100</b>	<b>19</b>	<b>1632</b>



**TABLE 2 – Yorkshire products from West Yorkshire**

West Yorkshire Pipes	c1580-1610		c1610-1640		c1640-1660		c1660-1690		c1690-1720		c1700-1750		c1750-1800		TOTAL	
	Total	%	Total	%	Total	%	Total	%	Total	%	Total	%	Total	%	Total	%
<b>Count: All Bowls &amp; stems</b>																
Bowls	2	100	156	98	1050	100	299	100	53	90	48	56	5	63	1613	97
Stems			3	2	4	0			6	10	38	44	3	38	54	3
<b>Totals:</b>	<b>2</b>	<b>100</b>	<b>159</b>	<b>100</b>	<b>1054</b>	<b>100</b>	<b>299</b>	<b>100</b>	<b>59</b>	<b>100</b>	<b>86</b>	<b>100</b>	<b>8</b>	<b>100</b>	<b>1667</b>	<b>100</b>
<b>Bowl Types: Bowls only</b>																
Heel bowls	2	100	107	97	909	98	258	98	39	83	21	60			1336	96
Spur bowls			3	3	17	2	12	4	8	17	14	40	4	100	58	4
<b>Totals:</b>	<b>2</b>	<b>100</b>	<b>110</b>	<b>100</b>	<b>926</b>	<b>100</b>	<b>270</b>	<b>100</b>	<b>47</b>	<b>100</b>	<b>35</b>	<b>100</b>	<b>4</b>	<b>100</b>	<b>1394</b>	<b>100</b>
<b>All Marks</b>																
Stamped Heels			8	5	46	4	90	30	7	12					151	9
Moulded Heels											10	12			10	1
Moulded Spurs																
Stamped Bowl marks																
Moulded Bowl marks													1	13	1	0
Stamped Stems					3	0	1	0	11	19	43	50	4	50	62	4
Stem Twists																
Unmarked fragments	2	100	151	95	1005	95	208	70	41	69	33	38	3	38	1443	87
<b>Totals:</b>	<b>2</b>	<b>100</b>	<b>159</b>	<b>100</b>	<b>1054</b>	<b>100</b>	<b>299</b>	<b>100</b>	<b>59</b>	<b>100</b>	<b>88</b>	<b>100</b>	<b>8</b>	<b>100</b>	<b>1667</b>	<b>100</b>
<b>Marks: Heel Bowls</b>																
Stamped heel mark			8	7	46	5	89	34	7	18					150	11
Moulded heel mark											10	48			10	1
Stamped bowl mark																
Moulded bowl mark																
Unmarked bowls	2	100	99	93	863	95	169	66	32	82	11	52	0		1176	88
<b>Totals:</b>	<b>2</b>	<b>100</b>	<b>107</b>	<b>100</b>	<b>909</b>	<b>100</b>	<b>258</b>	<b>100</b>	<b>39</b>	<b>100</b>	<b>21</b>	<b>100</b>	<b>0</b>	<b>0</b>	<b>1336</b>	<b>100</b>
<b>Marks: Spur Bowls</b>																
Moulded spur mark																
Stamped bowl mark																
Moulded bowl mark													1	25	1	2
Unmarked bowls			3	100	17	100	12	100	8	100	14	100	3	75	57	98
<b>Totals:</b>	<b>0</b>	<b>0</b>	<b>3</b>	<b>100</b>	<b>17</b>	<b>100</b>	<b>12</b>	<b>100</b>	<b>8</b>	<b>100</b>	<b>14</b>	<b>100</b>	<b>4</b>	<b>100</b>	<b>58</b>	<b>100</b>
<b>Marks: Unidentified Bowls</b>																
Stamped bowl mark																
Moulded bowl mark																
Unmarked bowls			46	100	124	100	29	100	6	100	13	100	1	100	219	100
<b>Totals:</b>	<b>0</b>	<b>0</b>	<b>46</b>	<b>100</b>	<b>124</b>	<b>100</b>	<b>29</b>	<b>100</b>	<b>6</b>	<b>100</b>	<b>13</b>	<b>100</b>	<b>1</b>	<b>100</b>	<b>219</b>	<b>100</b>
<b>Marks: Stems</b>																
Stamped stem mark					3		1		11		43		4		62	
Stem twist																
Unmarked stems			3		1										4	
<b>Totals:</b>	<b>0</b>	<b>N/A</b>	<b>3</b>	<b>N/A</b>	<b>4</b>	<b>N/A</b>	<b>1</b>	<b>N/A</b>	<b>11</b>	<b>N/A</b>	<b>43</b>	<b>N/A</b>	<b>4</b>	<b>N/A</b>	<b>66</b>	<b>N/A</b>
<b>Burnishing: Bowls &amp; stems</b>																
No burnishing			136	91	890	92	171	67	12	22	45	57	7	88	1261	83
Poor									1	2					1	0
Average					10	1	31	12	12	22	2	3			55	4
Good	2	100	14	9	62	6	52	20	26	47	32	41	1	13	189	12
Fine					2	0	2	1	4	7					8	1
<b>Totals:</b>	<b>2</b>	<b>100</b>	<b>150</b>	<b>100</b>	<b>964</b>	<b>100</b>	<b>256</b>	<b>100</b>	<b>55</b>	<b>100</b>	<b>79</b>	<b>100</b>	<b>8</b>	<b>100</b>	<b>1514</b>	<b>100</b>
<b>Stem bore: Bowls &amp; stems</b>																
Bore 3/64											1	1			1	0
Bore 4/64									1	2	24	33	1	28	26	2
Bore 5/64			1	1	35	4	26	11	21	45	43	69	3	75	129	9
Bore 6/64			22	19	281	31	82	36	14	30	3	4			402	29
Bore 7/64	1	50	76	66	562	61	115	51	11	23	2	3			767	55
Bore 8/64	1	50	16	14	36	4	4	2							57	4
Bore 9/64			1	1	1	0									2	0
<b>Totals:</b>	<b>2</b>	<b>100</b>	<b>116</b>	<b>100</b>	<b>915</b>	<b>100</b>	<b>227</b>	<b>100</b>	<b>47</b>	<b>100</b>	<b>73</b>	<b>100</b>	<b>4</b>	<b>100</b>	<b>1384</b>	<b>100</b>

(Table 2 continued)

<b>Milling: Bowls only</b>																
M4			78	87	453	78	33	17						564	80	
M3			4	4	37	6	12	6	1	3				54	6	
M2			2	2	35	6	26	13	5	16				68	7	
M1			2	2	12	2	7	4	3	10				24	3	
M0	1	100	4	4	59	10	117	80	22	71	23	100	4	100	230	24
<b>Totals:</b>	<b>1</b>	<b>100</b>	<b>90</b>	<b>100</b>	<b>596</b>	<b>100</b>	<b>195</b>	<b>100</b>	<b>31</b>	<b>100</b>	<b>23</b>	<b>100</b>	<b>4</b>	<b>100</b>	<b>940</b>	<b>100</b>
<b>Bowl Crosses: Bowls only</b>																
Type X											2	8			2	0
Type +																
No bowl cross	1	100	52	100	566	100	215	100	32	100	22	82	5	100	893	100
<b>Totals:</b>	<b>1</b>	<b>100</b>	<b>52</b>	<b>100</b>	<b>566</b>	<b>100</b>	<b>215</b>	<b>100</b>	<b>32</b>	<b>100</b>	<b>24</b>	<b>100</b>	<b>5</b>	<b>100</b>	<b>895</b>	<b>100</b>

**TABLE 3 – Sites for West Yorkshire**

			1500-1610	1610-1640	1640-1660	1660-1690	1690-1720	1720-1750	1750-1800	Totals
County	Parish	Site name								
1	W. Yorkshire				4	1				5
2	W. Yorkshire	Almondbury			1					1
3	W. Yorkshire	Attercliffe			1					1
4	W. Yorkshire	Baildon	1		1		1			3
5	W. Yorkshire	Bingley						1		1
6	W. Yorkshire	Bingley			1					1
7	W. Yorkshire	Bingley						1		1
8	W. Yorkshire	Bingley					1			1
9	W. Yorkshire	Birstal			1		2			3
10	W. Yorkshire	Blubberhouses		1	2					3
11	W. Yorkshire	Boulton					1			1
12	W. Yorkshire	Bradford			1					1
13	W. Yorkshire	Castleford			1					1
14	W. Yorkshire	Dewsbury		1		1	3		2	7
15	W. Yorkshire	Dewsbury		1	2	1				4
16	W. Yorkshire	Emley					1			1
17	W. Yorkshire	Ewden Reservoir			3		1			4
18	W. Yorkshire	Fartown				2				2
19	W. Yorkshire	Halifax					4			4
20	W. Yorkshire	Halifax			1	5	7	3	1	17
21	W. Yorkshire	Halifax					1			1
22	W. Yorkshire	Halifax				3				3
23	W. Yorkshire	Huddersfield		1	9	8	3			21
24	W. Yorkshire	Ilkley					1			1
25	W. Yorkshire	Ilkley				2	3		1	6
26	W. Yorkshire	Kirkhamgate				1				1
27	W. Yorkshire	Leeds						1		1
28	W. Yorkshire	Leeds					1			1
29	W. Yorkshire	Leeds					2			2
30	W. Yorkshire	Leeds				2	3	2	1	8
31	W. Yorkshire	Leeds				10	20	2	1	34
32	W. Yorkshire	Leeds				1				1
33	W. Yorkshire	Lepton					1			1
34	W. Yorkshire	New Mill				1				1
35	W. Yorkshire	Nr. Cridding Stubbs	1	39	102	60	16	48	2	268
36	W. Yorkshire	Nr Huddersfield					1			1
37	W. Yorkshire	Nr Huddersfield				4				4
38	W. Yorkshire	Nr Huddersfield					1			1

(Table 3 continued)

	County	Parish	Site name	1500-1610	1610-1640	1640-1660	1660-1690	1690-1720	1700-1750	1750-1800	Totals
39	W. Yorkshire	Nr. Huddersfield	Cleck, field east of Methodist Sunday School				1				1
40	W. Yorkshire	Otley	Manor House		1						1
41	W. Yorkshire	Pontefract	Horsefair						1		1
42	W. Yorkshire	Pontefract	Old Hall Farm				2		1		3
43	W. Yorkshire	Pontefract	Pontefract Castle		61	427	25	9	15	2	539
44	W. Yorkshire	Pontefract	Tanners Lane (TAN 1985-79)		1	1			1		3
45	W. Yorkshire	Pontefract	Unprovenanced material from Pontefract		3	27	54	5	11		100
46	W. Yorkshire	Rishworth	Dog Hill, Rishworth Moor				1				1
47	W. Yorkshire	Rishworth	Pike Farm Fields			2	4				6
48	W. Yorkshire	Rishworth	Rishworth Moor				1				1
49	W. Yorkshire	Saddleworth	Bills o Jacks				2				2
50	W. Yorkshire	Saddleworth	Saddleworth Moor			1					1
51	W. Yorkshire	Skipton	High Bradley				1				1
52	W. Yorkshire	Slaihwate	Moors				1				1
53	W. Yorkshire	Sowerby	Sowerby Castle			1					1
54	W. Yorkshire	Totley	Dore New Road				1				1
55	W. Yorkshire	Wakefield	105, Wrenthorpe Road, Potovens			3	2				5
56	W. Yorkshire	Wakefield	75 Brandy Carr Road, Kirkhamgate				1				1
57	W. Yorkshire	Wakefield	Clarke Hall				2				2
58	W. Yorkshire	Wakefield	John Bunny's House					2			2
59	W. Yorkshire	Wakefield	Material from Social History Collection			1					1
60	W. Yorkshire	Wakefield	Potovens		1	12	41	1	1		56
61	W. Yorkshire	Wakefield	Radcliffe Piece			20		2			22
62	W. Yorkshire	Wakefield	Sandal Castle		10	295	4	2	1		312
63	W. Yorkshire	Wakefield	Unprovenanced but probably from Wakefield		13	31	19	3	2		68
64	W. Yorkshire	Wakefield	Wrenthorpe		29	54	1				84
65	W. Yorkshire	Wakefield	St John's Square							1	1
66	W. Yorkshire	West Ardsley	Woodkirk, near Batley					1			1
67	W. Yorkshire	Wrenthorpe	10 Jerry Clay Lane			17	15	1			33
68	W. Yorkshire	Wrenthorpe	Kiln 1			4					4
69	W. Yorkshire	Wrenthorpe	Rodger Lane		2	2	3		1		8
70	W. Yorkshire	Wrenthorpe	Fields on side of A650 Bradford-Wakefield Rd, 2m outside Wakefield				2				2
71	W. Yorkshire		Brushes Moor				2				2
72	W. Yorkshire		Haselden Hall				1				1
73	W. Yorkshire		Site code SMT90			1					1
Totals:				2	165	1059	304	61	88	8	1687

**TABLE 4 – Collections for West Yorkshire**

Collection Name	1500-1610	1610-1640	1640-1660	1660-1690	1690-1720	1700-1750	1750-1800	Totals
1 Abbey House Museum, Leeds			10	20	2	1	1	34
2 Denham Collection				1				1
3 Higgins Collection				1				1
4 Kelham Island Industrial Museum			4	1	1			6
5 Manor House Museum, Ilkley	1	1	6	6	2	1		17
6 Mayfield Collection			17	15	1			33
7 NCTPA		1	1			1		3
8 Not known		2	3	10	3	2	2	22
9 Pontefract Museum		3	27	54	5	12		101
10 Richardson Collection				2				2
11 Sheffield City Museum			1					1
12 Stocks Collection				1	1			2
13 Toleon Memorial Museum, Huddersfield		3	40	35	9	1		88
14 Wakefield Museum & Art Gallery		26	347	67	8	3		451
15 West Yorkshire Archaeological Services		90	500	30	13	19	2	654
16 Wood Hall Archaeological Trust	1	39	102	60	16	48	2	268
17 York Castle Museum			1	1				2
18 Unknown							1	1
Totals:	2	165	1059	304	61	88	8	1687

**TABLE 5 – Imports for West Yorkshire**

Place of origin	1500-1610	1610-1640	1640-1660	1660-1690	1690-1720	1700-1750	1750-1800	Totals
?Tyne-side						2		2
Gateshead					1			1
Rainford			1	2	1			4
South Lancashire			3	1				4
Staffordshire				1				1
Unknown, but not a Yorkshire product				1				1
The Netherlands		6	1					7
Totals	0	6	5	5	2	2	0	20

**TABLE 1 – All fragments for East Yorkshire**

East Yorkshire	c1580-1610			c1610-1640			c1640-1660			c1660-1690			c1690-1720			c1720
	Unpub	Pub	Imp	Unpub	Pub	Imp	Unpub	Pub	Imp	Unpub	Pub	Imp	Unpub	Pub	Imp	
<b>Count: Bowls &amp; stems</b>																
Bowls	2			85	2	20	612	13	6	1179	38	2	335	22	4	459
Stems				25	2	9	43	1	1	1		1	50		20	112
<b>Totals:</b>	<b>2</b>	<b>0</b>	<b>0</b>	<b>110</b>	<b>4</b>	<b>29</b>	<b>655</b>	<b>14</b>	<b>7</b>	<b>1180</b>	<b>38</b>	<b>3</b>	<b>385</b>	<b>22</b>	<b>24</b>	<b>571</b>
<b>Bowl Types: Bowls only</b>																
Heel bowls	2			73	2	19	561	13	5	918	37	1	309	21	4	393
Spur bowls				7		1	19		1	202	1		1	1		7
Unidentified bowls				5			32			59		1	25			59
<b>Totals:</b>	<b>2</b>	<b>0</b>	<b>0</b>	<b>85</b>	<b>2</b>	<b>20</b>	<b>612</b>	<b>13</b>	<b>6</b>	<b>1179</b>	<b>38</b>	<b>2</b>	<b>335</b>	<b>22</b>	<b>4</b>	<b>459</b>
<b>Bowl Marks: Bowls only</b>																
Stamped heel mark				36	2	17	397	10	3	294	36		73	19		1
Moulded heel mark													76	2		355
Moulded spur mark							1		1	1						
Stamped bowl mark							1			1	1	1	8			2
Moulded bowl mark													1	1		2
Unmarked bowls	2			49		3	213	3	2	863	1	1	177		4	99
<b>Totals:</b>	<b>2</b>	<b>0</b>	<b>0</b>	<b>85</b>	<b>2</b>	<b>20</b>	<b>612</b>	<b>13</b>	<b>6</b>	<b>1179</b>	<b>38</b>	<b>2</b>	<b>335</b>	<b>22</b>	<b>4</b>	<b>459</b>
<b>Stem Marks: Bowl &amp; stem fragments</b>																
Stamped stem mark				9	2	5	20	1	1	16		1	84		21	94
Stem twist																
Unmarked stems				17		4	38						2			19
<b>Totals:</b>	<b>0</b>	<b>0</b>	<b>0</b>	<b>26</b>	<b>2</b>	<b>9</b>	<b>58</b>	<b>1</b>	<b>1</b>	<b>16</b>	<b>0</b>	<b>1</b>	<b>86</b>	<b>0</b>	<b>21</b>	<b>113</b>
<b>Burnishing: Bowls &amp; stems</b>																
No burnishing	1			67		6	466	1	4	967	1	2	215	2	17	469
Poor				1			1			3			6			
Average							5			46	8		18	2		6
Good	1			22		18	11	1	1	45		1	28		1	8
Fine				2		1	2		1	2			6		6	
Can't tell				18	4	4	170	12	1	117	29		112	18		88
<b>Totals:</b>	<b>2</b>	<b>0</b>	<b>0</b>	<b>110</b>	<b>4</b>	<b>29</b>	<b>655</b>	<b>14</b>	<b>7</b>	<b>1180</b>	<b>38</b>	<b>3</b>	<b>385</b>	<b>22</b>	<b>24</b>	<b>571</b>
<b>Stem bore: Bowls &amp; stems</b>																
Bore 3/64																2
Bore 4/64										1	1		6		2	43
Bore 5/64				1			3	1		27	2		67	1	8	350
Bore 6/64				11		3	50	1		227			178	3	9	107
Bore 7/64				51		18	503	2		587	7		109		4	8
Bore 8/64	1			34		4	64	1		202	1		4			
Bore 9/64	1			1			6			19	1					
Unmeasurable				12	4	4	29	13	3	117	29		21	18	1	61
<b>Totals:</b>	<b>2</b>	<b>0</b>	<b>0</b>	<b>110</b>	<b>4</b>	<b>29</b>	<b>655</b>	<b>14</b>	<b>7</b>	<b>1181</b>	<b>38</b>	<b>3</b>	<b>385</b>	<b>22</b>	<b>24</b>	<b>571</b>
<b>Milling: Bowls only</b>																
M4	1			38		17	71		1	40	1	1	4		1	
M3				2			20	1		49			1			
M2				9			12		1	87	2		15		2	1
M1							12		1	65	1		16			1
M0				18		2	340		2	717	3	1	167	2	1	277
Milling on all surviving rim				9			20			34	2		14			3
Unmeasurable	1			9	2	1	137	12	1	187	29		118	20		177
<b>Totals:</b>	<b>2</b>	<b>0</b>	<b>0</b>	<b>85</b>	<b>2</b>	<b>20</b>	<b>612</b>	<b>13</b>	<b>6</b>	<b>1179</b>	<b>38</b>	<b>2</b>	<b>335</b>	<b>22</b>	<b>4</b>	<b>459</b>
<b>Bowl Crosses: Bowls only</b>																
Type X																
Type +																1
No bowl cross	1			67		18	571	1	5	1042	6	2	307	2	4	437
Can't tell	1			18	2	2	41	12	1	137	32		28	20		21
<b>Totals:</b>	<b>2</b>	<b>0</b>	<b>0</b>	<b>85</b>	<b>2</b>	<b>20</b>	<b>612</b>	<b>13</b>	<b>6</b>	<b>1179</b>	<b>38</b>	<b>2</b>	<b>335</b>	<b>22</b>	<b>4</b>	<b>459</b>

(Table 1 continued)

East Yorkshire	c1750		c1750-1800		Totals:		TOTALS		
	Pub	Imp	Unpub	Pub	Imp	Unpub	Pub	Imp	
<b>Count: Bowls &amp; stems</b>									
Bowls	21	1	60			2732	96	33	2828
Stems			3	17	2	248	3	36	251
<b>Totals:</b>	<b>21</b>	<b>4</b>	<b>77</b>	<b>0</b>	<b>2</b>	<b>2900</b>	<b>99</b>	<b>69</b>	<b>3079</b>
<b>Bowl Types: Bowls only</b>									
Heel bowls	17	1	5			2261	90	30	2351
Spur bowls	4		50			266	6	2	292
Unidentified bowls			5			185	0	1	185
<b>Totals:</b>	<b>21</b>	<b>1</b>	<b>60</b>	<b>0</b>	<b>0</b>	<b>2732</b>	<b>96</b>	<b>33</b>	<b>2828</b>
<b>Bowl Marks: Bowls only</b>									
Stamped heel mark	2					801	69	20	870
Moulded heel mark	15	1	4			435	17	1	452
Moulded spur mark	4		47			49	4	1	53
Stamped bowl mark			4			16	1	1	17
Moulded bowl mark						3	1	0	4
Unmarked bowls			5			1428	4	10	1432
<b>Totals:</b>	<b>21</b>	<b>1</b>	<b>60</b>	<b>0</b>	<b>0</b>	<b>2732</b>	<b>96</b>	<b>33</b>	<b>2828</b>
<b>Stem Marks: Bowl &amp; stem fragments</b>									
Stamped stem mark			3	17	2	240	3	33	243
Stem twist									
Unmarked stems						76		4	76
<b>Totals:</b>	<b>0</b>	<b>3</b>	<b>17</b>	<b>0</b>	<b>2</b>	<b>316</b>	<b>3</b>	<b>37</b>	<b>319</b>
<b>Burnishing: Bowls &amp; stems</b>									
No burnishing	3	4	56			2241	7	33	2248
Poor						11		0	11
Average						75	10	0	85
Good						115	1	21	116
Fine						12		9	12
Can't tell	18		21		2	526	81	7	607
<b>Totals:</b>	<b>21</b>	<b>4</b>	<b>77</b>	<b>0</b>	<b>2</b>	<b>2900</b>	<b>99</b>	<b>70</b>	<b>3079</b>
<b>Stem bore: Bowls &amp; stems</b>									
Bore 3/64			1			3		0	3
Bore 4/64			44			94		3	94
Bore 5/64	3	3	11			459	4	14	463
Bore 6/64		1				573	4	13	577
Bore 7/64						1258	7	24	1265
Bore 8/64						305	1	5	306
Bore 9/64						27	1	0	28
Unmeasurable	18		21		2	261	82	10	343
<b>Totals:</b>	<b>21</b>	<b>4</b>	<b>77</b>	<b>0</b>	<b>2</b>	<b>2900</b>	<b>99</b>	<b>69</b>	<b>3079</b>
<b>Milling: Bowls only</b>									
M4						154	1	20	155
M3						72	1	0	73
M2						124	2	3	126
M1						94	1	1	95
M0	2	1	32			1551	7	7	1558
Milling on all surviving rim						80	2	0	82
Unmeasurable	19		28			657	82	2	739
<b>Totals:</b>	<b>21</b>	<b>1</b>	<b>60</b>	<b>0</b>	<b>0</b>	<b>2732</b>	<b>96</b>	<b>33</b>	<b>2828</b>
<b>Bowl Crosses: Bowls only</b>									
Type X								0	
Type +						1		0	1
No bowl cross	3	1	56			2481	12	30	2493
Can't tell	18		4			250	84	3	334
<b>Totals:</b>	<b>21</b>	<b>1</b>	<b>60</b>	<b>0</b>	<b>0</b>	<b>2732</b>	<b>96</b>	<b>33</b>	<b>2828</b>

**TABLE 2 - Yorkshire products for East Yorkshire**

East Yorkshire	c1580-1610		c1610-1640		c1640-1660		c1660-1690		c1690-1720		c1700-1750		c1750-1800		TOTAL	
	Total	%	Total	%	Total	%	Total	%	Total	%	Total	%	Total	%	Total	%
<b>Count: All Bowls &amp; stems</b>																
Bowls (all fragments)	2	100	67	79	619	94	1215	100	353	92	479	81	60	80	2795	93
Stems			18	21	43	6			30	8	109	19	15	20	215	7
<b>Totals:</b>	<b>2</b>	<b>100</b>	<b>85</b>	<b>100</b>	<b>662</b>	<b>100</b>	<b>1215</b>	<b>100</b>	<b>383</b>	<b>100</b>	<b>588</b>	<b>100</b>	<b>75</b>	<b>100</b>	<b>3010</b>	<b>100</b>
<b>Bowl Types: Bowls only</b>																
Heel bowls	2	100	56	90	569	97	953	82	326	99	376	97	5	9	2287	89
Spur bowls			6	10	18	3	204	18	2	1	11	3	50	91	291	11
<b>Totals:</b>	<b>2</b>	<b>100</b>	<b>62</b>	<b>100</b>	<b>587</b>	<b>100</b>	<b>1157</b>	<b>100</b>	<b>328</b>	<b>100</b>	<b>387</b>	<b>100</b>	<b>55</b>	<b>100</b>	<b>2578</b>	<b>100</b>
<b>All Marks</b>																
Stamped heels			21	25	404	61	330	27	92	24	3	1			850	28
Moulded heels									78	20	369	63	4	5	451	15
Moulded spurs							1	0			4	1	47	63	52	2
Stamped bowl marks					1	0	1	0	8	2	2	0	4	5	16	1
Moulded bowl marks									2	1	2	0			4	0
Stamped stems			6	7	21	3	15	1	63	16	91	15	15	20	211	7
Stem twists																
Unmarked fragments	2	100	58	68	236	36	869	71	140	37	117	20	5	7	1427	47
<b>Totals:</b>	<b>2</b>	<b>100</b>	<b>85</b>	<b>100</b>	<b>662</b>	<b>100</b>	<b>1216</b>	<b>100</b>	<b>383</b>	<b>100</b>	<b>588</b>	<b>100</b>	<b>75</b>	<b>100</b>	<b>3011</b>	<b>100</b>
<b>Marks: Heel Bowls</b>																
Stamped heel mark			21	38	404	71	331	35	92	28	3	1			851	37
Moulded heel mark									78	24	369	90	4	80	451	19
Stamped bowl mark									6	2					6	0
Moulded bowl mark											2	0			2	0
Unmarked bowls	2	100	35	63	166	29	622	65	150	46	35	9	1	20	1011	44
<b>Totals:</b>	<b>2</b>	<b>100</b>	<b>56</b>	<b>100</b>	<b>570</b>	<b>100</b>	<b>953</b>	<b>100</b>	<b>326</b>	<b>100</b>	<b>409</b>	<b>100</b>	<b>5</b>	<b>100</b>	<b>2321</b>	<b>100</b>
<b>Marks: Spur Bowls</b>																
Moulded spur mark							1	0			4	36	47	94	52	18
Stamped bowl mark					1	6	1	0			2	18	3	6	7	2
Moulded bowl mark									1	50					1	0
Unmarked bowls			6	100	17	94	202	99	1	50	5	45			0	231
<b>Totals:</b>	<b>0</b>	<b>0</b>	<b>6</b>	<b>100</b>	<b>18</b>	<b>100</b>	<b>204</b>	<b>100</b>	<b>2</b>	<b>100</b>	<b>11</b>	<b>100</b>	<b>50</b>	<b>100</b>	<b>291</b>	<b>100</b>
<b>Marks: Unidentified bowls</b>																
Stamped bowl mark									2	8			1	20	3	2
Moulded bowl mark									1	4					1	1
Unmarked bowls			5	100	32	100	58	100	22	88	59	100	4	80	180	98
<b>Totals:</b>	<b>0</b>	<b>0</b>	<b>5</b>	<b>100</b>	<b>32</b>	<b>100</b>	<b>58</b>	<b>100</b>	<b>25</b>	<b>100</b>	<b>59</b>	<b>100</b>	<b>5</b>	<b>100</b>	<b>184</b>	<b>100</b>
<b>Marks: Stems</b>																
Stamped stem mark			6		20		15		63		91		15		210	
Stem twist																
Unmarked stems			13		38				2		19				72	
<b>Totals:</b>	<b>0</b>	<b>N/A</b>	<b>19</b>	<b>N/A</b>	<b>58</b>	<b>N/A</b>	<b>15</b>	<b>N/A</b>	<b>65</b>	<b>N/A</b>	<b>110</b>	<b>N/A</b>	<b>15</b>	<b>N/A</b>	<b>282</b>	<b>N/A</b>
<b>Burnishing: Bowls &amp; stems</b>																
No burnishing	1	50	61	91	463	96	965	90	200	79	468	97	56	100	2214	92
Poor			1	1	1	0	3	0	6	2					11	0
Average					5	1	54	5	20	8	6	1			85	4
Good	1	50	4	6	11	2	45	4	27	11	8	2			96	4
Fine			1	1	1	0	2	0							4	0
<b>Totals:</b>	<b>2</b>	<b>100</b>	<b>67</b>	<b>100</b>	<b>481</b>	<b>100</b>	<b>1069</b>	<b>100</b>	<b>253</b>	<b>100</b>	<b>482</b>	<b>100</b>	<b>56</b>	<b>100</b>	<b>2410</b>	<b>100</b>
<b>Stem bore: Bowls &amp; stems</b>																
Bore 3/64											2	0	1	2	3	1
Bore 4/64									4	1	43	8	44	79	91	3
Bore 5/64			1	1	2	0	25	2	60	17	350	69	11	20	449	17
Bore 6/64			8	12	51	8	228	21	172	50	106	21			565	21
Bore 7/64			30	43	501	80	593	55	105	30	8	2			1237	46
Bore 8/64	1	50	29	42	63	10	203	19	4	1					300	11
Bore 9/64	1	50	1	1	6	1	20	2							28	1
<b>Totals:</b>	<b>2</b>	<b>100</b>	<b>69</b>	<b>100</b>	<b>623</b>	<b>100</b>	<b>1069</b>	<b>100</b>	<b>345</b>	<b>100</b>	<b>509</b>	<b>100</b>	<b>56</b>	<b>100</b>	<b>2673</b>	<b>100</b>



(Table 2 continued)

Milling: Bowls only																
M4	1	100	21	44	70	16	40	4	3	1					135	7
M3			2	4	21	5	49	5	1	0					73	4
M2			9	19	11	2	89	9	13	6	1	0			123	6
M1					11	2	66	7	16	8	1	0			94	5
M0			16	33	338	75	719	75	168	84	278	99	32	100	1551	78
Totals:	1	100	48	100	451	100	963	100	201	100	280	100	32	100	1976	100
Bowl Crosses: Bowls only																
Type X																
Type +											1	0			1	0
No bowl cross	1	100	49	100	567	100	1046	100	305	100	439	100	56	100	2463	100
Totals:	1	100	49	100	567	100	1046	100	305	100	440	100	56	100	2464	100

**TABLE 3 – Sites for East Yorkshire**

	County	Parish	Site name	1500-1610	1610-1649	1650-1699	1700-1729	1730-1759	1760-1899	Totals	
1	City of Kingston on Hull	Hull	Beverley Gate		3	27	93	12	12	1	148
2	City of Kingston on Hull	Hull	Blackfriargate, Old Town					1			1
3	City of Kingston on Hull	Hull	Citadel		5	14	297	4			320
4	City of Kingston on Hull	Hull	Curtain Wall								1
5	City of Kingston on Hull	Hull	Fordyke		1	4	9				14
6	City of Kingston on Hull	Hull	George Yark								1
7	City of Kingston on Hull	Hull	Gibraltar Farm								2
8	City of Kingston on Hull	Hull	High Street		3	1		3	7	1	15
9	City of Kingston on Hull	Hull	Humber Street		1						2
10	City of Kingston on Hull	Hull	Iveson Close			1			1		2
11	City of Kingston on Hull	Hull	King Edward Street								4
12	City of Kingston on Hull	Hull	King Edward Street					2			2
13	City of Kingston on Hull	Hull	King's Head, High Street		20						20
14	City of Kingston on Hull	Hull	Kingswood		1	4	12	1			18
15	City of Kingston on Hull	Hull	Landrees Lane						2		2
16	City of Kingston on Hull	Hull	Malmo Road								2
17	City of Kingston on Hull	Hull	New Dock Offices			1					1
18	City of Kingston on Hull	Hull	New Dock Walls								2
19	City of Kingston on Hull	Hull	Old Town		4		9	11	3		27
20	City of Kingston on Hull	Hull	Posterngate, Old Town						4		4
21	City of Kingston on Hull	Hull	Prince Street, Old Town					1			1
22	City of Kingston on Hull	Hull	Provincial Bank, Lowgate		1	1					2
23	City of Kingston on Hull	Hull	Queen Street		2	7	48	3	4	3	67
24	City of Kingston on Hull	Hull	Sammy's Point		1	7	35	4			47
25	City of Kingston on Hull	Hull	Stakie Casino, Castle Street			8	6		2		16
26	City of Kingston on Hull	Hull	Temples Entry, Old Town					1	2	1	4
27	City of Kingston on Hull	Hull	Tower Street		2	1	20				23
28	City of Kingston on Hull	Hull	Trinity Court, Old Town			1	1	2	8		12
29	City of Kingston on Hull	Hull	Unprovenanced but probably from Hull			33	89	10	11		143
30	City of Kingston on Hull	Hull	White Hart Hotel, Silver Street		1						1
31	City of Kingston on Hull	Hull	World's End					1	1		2
32	City of Kingston on Hull	Hull	Wyton, Old Town			1		1	1		3
33	East Riding of Yorkshire	Bempton	Spring Bank Lane								1
34	East Riding of Yorkshire	Beverley	Dyer's Lane					2	1		3
35	East Riding of Yorkshire	Beverley	Fieldwalking from around the town	2	62	544	535	340	527	72	2082
36	East Riding of Yorkshire	Beverley	Holme Church Lane								1
37	East Riding of Yorkshire	Beverley	North Beckside								5
38	East Riding of Yorkshire	Beverley	site of Knights Hospitallers preceptory			1					1
39	East Riding of Yorkshire	Beverley	St Mary's Manor		1				7	1	9
40	East Riding of Yorkshire	Beverley	Unprovenanced material from Beverley			7	10				17
41	East Riding of Yorkshire	Beverley	Wyllie Road		1	2	3	2	1		9
42	East Riding of Yorkshire	Bridlington	Chapel Street								1
43	East Riding of Yorkshire	Bridlington	Eastern Road Allotments								2

(Table 3 continued)

	County	Parish	Site name	1500-1610	1610-1640	1640-1680	1680-1690	1690-1720	1720-1750	1750-1800	Totals
44	East Riding of Yorkshire	Bridlington	Kirkgate			1	2	2	6		11
45	East Riding of Yorkshire	Bridlington	Old Town				1				1
46	East Riding of Yorkshire	Howden	Bishop's Manor House		5	1	13	4	1		24
47	East Riding of Yorkshire	Market Weighton					1				1
48	East Riding of Yorkshire	Newport				1					1
49	East Riding of Yorkshire	Nr Bridlington	Sewerby Road, opposite the priory			1					1
			Totals:	2	114	669	1218	407	592	77	3079

TABLE 4 – Collections for East Yorkshire

	Collection Name	1500-1610	1610-1640	1640-1680	1680-1690	1690-1720	1720-1750	1750-1800	Totals
1	Dorman Museum, Middlesborough			1					1
2	Elkins Collection						1		1
3	Humber Archaeology Partnership		19	62	260	30	30	4	405
4	NCTPA			2	10	2	3		17
5	Newark Houses Museum				1				1
6	Not known		4	13	28	18	16		79
7	Rayner Collection	2	87	558	831	344	526	72	2420
8	Royal Albert Memorial Museum				3				3
9	Scarborough Borough Council							1	1
10	Sewerby Hall			5	13	2	6		26
11	Stothard Collection		4		7	10	3		24
12	Wilberforce House Museum			27	65	1	7		100
13	York Castle Museum			1					1
	Totals:	2	114	669	1218	407	582	77	3079

**TABLE 5 – Imports for East Yorkshire**

Place of Origin	1580-1610	1610-1640	1640-1660	1660-1690	1690-1720	1700-1750	1750-1800	Totals
?Lincoln					1			1
?Nottingham				1				1
Central/Southern England			2					2
Chester					9	3	2	14
Gateshead					1			1
South Lancashire				1				1
Unknown, but not a Yorkshire product					1			1
The Netherlands		29	5	1	12	1		48
Totals:	0	29	7	3	24	4	2	69

**TABLE 1 – All fragments for South Yorkshire**

South Yorkshire	c1580-1610			c1610-1640			c1640-1660			c1660-1690			c1690-1720			c1700-1750		
	Unpub	Pub	Imp	Unpub	Pub	Imp	Unpub	Pub	Imp	Unpub	Pub	Imp	Unpub	Pub	Imp	Unpub	Pub	Imp
<b>Count: Bowls &amp; stems</b>																		
Bowls	1			26			126	3	4	164	2	2	46	2	3	40	3	1
Stems							1			1			2			32		
<b>Totals:</b>	<b>1</b>	<b>0</b>	<b>0</b>	<b>26</b>	<b>0</b>	<b>0</b>	<b>127</b>	<b>3</b>	<b>4</b>	<b>165</b>	<b>2</b>	<b>2</b>	<b>48</b>	<b>2</b>	<b>3</b>	<b>72</b>	<b>3</b>	<b>1</b>
<b>Bowl Types: Bowls only</b>																		
Heel bowls	1			22			115	3	2	134	2	1	33	2	2	6	1	1
Spur bowls				1			6		2	20		1	7		1	23		2
Unidentified bowls				3			5			10			6			11		
<b>Totals:</b>	<b>1</b>	<b>0</b>	<b>0</b>	<b>26</b>	<b>0</b>	<b>0</b>	<b>126</b>	<b>3</b>	<b>4</b>	<b>164</b>	<b>2</b>	<b>2</b>	<b>46</b>	<b>2</b>	<b>3</b>	<b>40</b>	<b>3</b>	<b>1</b>
<b>Bowl Marks</b>																		
Stamped heel mark	1			8			8		2	48	2	1	12	1	2			
Moulded heel mark										1			1			3		
Moulded spur mark																2		
Stamped bowl mark										2			8			2	1	
Moulded bowl mark																		
Unmarked bowls				18			116	3	2	113		1	25	1	1	29	2	1
<b>Totals:</b>	<b>1</b>	<b>0</b>	<b>0</b>	<b>26</b>	<b>0</b>	<b>0</b>	<b>124</b>	<b>3</b>	<b>4</b>	<b>164</b>	<b>2</b>	<b>2</b>	<b>46</b>	<b>2</b>	<b>3</b>	<b>36</b>	<b>3</b>	<b>1</b>
<b>Stem Marks</b>																		
Stamped stem mark							3						3			36		
Stem twist																		
Unmarked stems										1			1					
<b>Totals:</b>	<b>0</b>	<b>0</b>	<b>0</b>	<b>0</b>	<b>0</b>	<b>0</b>	<b>3</b>	<b>0</b>	<b>0</b>	<b>1</b>	<b>0</b>	<b>0</b>	<b>4</b>	<b>0</b>	<b>0</b>	<b>36</b>	<b>0</b>	<b>0</b>
<b>Burnishing: Bowls &amp; stems</b>																		
No burnishing				8			97	3	3	71	1		18		1	45		1
Poor				1			1			6			2					
Average				3						23			10			8		
Good				2			6			19			12	1		13	1	
Fine										1			1			1		
Can't tell	1			12			23		1	45	1	2	6		2	5		2
<b>Totals:</b>	<b>1</b>	<b>0</b>	<b>0</b>	<b>26</b>	<b>0</b>	<b>0</b>	<b>127</b>	<b>3</b>	<b>4</b>	<b>165</b>	<b>2</b>	<b>2</b>	<b>48</b>	<b>2</b>	<b>3</b>	<b>72</b>	<b>3</b>	<b>1</b>
<b>Stem bore: Bowls &amp; stems</b>																		
Bore 3/64																		
Bore 4/64													1		1	28		
Bore 5/64				1			3			12			10	1		36	1	1
Bore 6/64				4			38		1	50	1		18			1		
Bore 7/64	1			9			59		2	70	1	2	4	1		1		
Bore 8/64				4			6	3					1					
Bore 9/64				2			1			8								
Unmeasurable				6			20		1	25			14		2	6	2	
<b>Totals:</b>	<b>1</b>	<b>0</b>	<b>0</b>	<b>26</b>	<b>0</b>	<b>0</b>	<b>127</b>	<b>3</b>	<b>4</b>	<b>165</b>	<b>2</b>	<b>2</b>	<b>48</b>	<b>2</b>	<b>3</b>	<b>72</b>	<b>3</b>	<b>1</b>
<b>Milling: Bowls only</b>																		
M4				18			51	1	1	26	1	1	3					
M3							25		1	27			2					
M2							11			32			5			1		
M1							4			5			4					
M0	1			1			7	2		39			19	1	1	29	1	1
Milling on all surviving rim				5			18			15			3					
Unmeasurable				2			10		2	20	1	1	10	1	2	10	2	
<b>Totals:</b>	<b>1</b>	<b>0</b>	<b>0</b>	<b>26</b>	<b>0</b>	<b>0</b>	<b>126</b>	<b>3</b>	<b>4</b>	<b>164</b>	<b>2</b>	<b>2</b>	<b>46</b>	<b>2</b>	<b>3</b>	<b>40</b>	<b>3</b>	<b>1</b>
<b>Bowl Crosses: Bowls only</b>																		
Type X																1		
Type +																9		
No bowl cross	1			18			94	3	2	130		1	37	1	1	20	1	1
Can't tell				7			32		2	34	2	1	9	1	2	10	2	
<b>Totals:</b>	<b>1</b>	<b>0</b>	<b>0</b>	<b>26</b>	<b>0</b>	<b>0</b>	<b>126</b>	<b>3</b>	<b>4</b>	<b>164</b>	<b>2</b>	<b>2</b>	<b>46</b>	<b>2</b>	<b>3</b>	<b>40</b>	<b>3</b>	<b>1</b>

(Table 1 continued)

South Yorkshire	c1750-1800			Totals:			TOTALS
	Unpub	Pub	Imp	Unpub	Pub	Imp	
<b>Count: Bowls &amp; stems</b>							
Bowls	115			518	10	10	528
Stems	96			132	0	0	132
<b>Totals:</b>	<b>211</b>	<b>0</b>	<b>0</b>	<b>650</b>	<b>10</b>	<b>10</b>	<b>660</b>
<b>Bowl Types: Bowls only</b>							
Heel bowls	43			354	8	6	362
Spur bowls	53			110	2	4	112
Unidentified bowls	19			54	0	0	54
<b>Totals:</b>	<b>115</b>	<b>0</b>	<b>0</b>	<b>518</b>	<b>10</b>	<b>10</b>	<b>528</b>
<b>Bowl Marks</b>							
Stamped heel mark				77	3	5	80
Moulded heel mark				5	0	0	5
Moulded spur mark	1			3	0	0	3
Stamped bowl mark				12	1	0	13
Moulded bowl mark	6			6	0	0	6
Unmarked bowls	107			408	6	5	414
<b>Totals:</b>	<b>114</b>	<b>0</b>	<b>0</b>	<b>511</b>	<b>10</b>	<b>10</b>	<b>521</b>
<b>Stem Marks</b>							
Stamped stem mark	88			130	0	0	130
Stem twist	1			1	0	0	1
Unmarked stems	8			10	0	0	10
<b>Totals:</b>	<b>97</b>	<b>0</b>	<b>0</b>	<b>141</b>	<b>0</b>	<b>0</b>	<b>141</b>
<b>Burnishing: Bowls &amp; stems</b>							
No burnishing	196			435	4	5	439
Poor	2			12	0	0	12
Average	1			45	0	0	45
Good	4			56	2	0	58
Fine				2	1	0	3
Can't tell	8			100	3	5	103
<b>Totals:</b>	<b>211</b>	<b>0</b>	<b>0</b>	<b>650</b>	<b>10</b>	<b>10</b>	<b>660</b>
<b>Stem bore: Bowls &amp; stems</b>							
Bore 3/64	1			1	0	0	1
Bore 4/64	56			85	0	1	83
Bore 5/64	72			134	2	1	136
Bore 6/64				111	1	1	112
Bore 7/64				144	2	4	146
Bore 8/64				11	3	0	14
Bore 9/64				11	0	0	11
Unmeasurable	82			153	2	3	155
<b>Totals:</b>	<b>211</b>	<b>0</b>	<b>0</b>	<b>650</b>	<b>10</b>	<b>10</b>	<b>660</b>
<b>Milling: Bowls only</b>							
M4				98	2	2	100
M3				54	0	1	54
M2				49	0	0	49
M1				13	0	0	13
M0	83			179	4	2	183
Milling on all surviving rim				41	0	0	41
Unmeasurable	32			84	4	5	88
<b>Totals:</b>	<b>115</b>	<b>0</b>	<b>0</b>	<b>518</b>	<b>10</b>	<b>10</b>	<b>528</b>
<b>Bowl Crosses: Bowls only</b>							
Type X				1	0	0	1
Type +				9	0	0	9
No bowl cross	112			413	5	5	418
Can't tell	3			95	5	5	100
<b>Totals:</b>	<b>115</b>	<b>0</b>	<b>0</b>	<b>518</b>	<b>10</b>	<b>10</b>	<b>528</b>

**TABLE 2 – Yorkshire products from South Yorkshire**

South Yorkshire	c1580-1610		c1610-1640		c1640-1660		c1660-1680		c1680-1720		c1700-1750		c1750-1800		TOTAL	
	Total	%	Total	%	Total	%	Total	%	Total	%	Total	%	Total	%	Total	%
<b>Count: Bowls &amp; stems</b>																
Bowls (all fragments)	1	100	26	100	125	89	164	89	45	86	42	57	115	55	518	89
Stems					1	1	1	1	2	4	32	43	96	45	132	20
<b>Totals:</b>	<b>1</b>	<b>100</b>	<b>26</b>	<b>100</b>	<b>126</b>	<b>100</b>	<b>165</b>	<b>100</b>	<b>47</b>	<b>100</b>	<b>74</b>	<b>100</b>	<b>211</b>	<b>100</b>	<b>650</b>	<b>100</b>
<b>Bowl Types: Bowls only</b>																
Heel bowls	1	100	22	98	116	97	135	88	33	85	6	19	43	45	356	77
Spur bowls			1	4	4	2	19	12	6	15	25	81	53	55	108	23
<b>Totals:</b>	<b>1</b>	<b>100</b>	<b>23</b>	<b>100</b>	<b>120</b>	<b>99</b>	<b>154</b>	<b>100</b>	<b>39</b>	<b>100</b>	<b>31</b>	<b>100</b>	<b>96</b>	<b>100</b>	<b>464</b>	<b>100</b>
<b>All Marks</b>																
Stamped heels	1	100	8	31	6	5	49	30	11	23					75	12
Moulded heels							1	1	1	2	3	4			5	1
Moulded spurs											2	3	1	0	3	0
Stamped bowl marks							2	1	8	17	3	4			13	2
Moulded bowl marks													6	3	6	1
Stamped stems					3	2			3	6	36	49	88	42	130	20
Stem twists													1	0	1	0
Unmarked fragments			18	69	117	93	113	68	24	51	30	41	115	55	417	64
<b>Totals:</b>	<b>1</b>	<b>100</b>	<b>26</b>	<b>100</b>	<b>126</b>	<b>100</b>	<b>165</b>	<b>100</b>	<b>47</b>	<b>100</b>	<b>74</b>	<b>100</b>	<b>211</b>	<b>100</b>	<b>650</b>	<b>100</b>
<b>Marks: Heel Bowls</b>																
Stamped heel mark	1	100	8	38	6	5	49	36	11	33					75	21
Moulded heel mark							1	1	1	3	3	50			5	1
Stamped bowl mark									4	12	1	17			5	1
Moulded bowl mark																
Unmarked bowls			14	64	110	95	85	63	17	52	2	33	43	100	271	76
<b>Totals:</b>	<b>1</b>	<b>100</b>	<b>22</b>	<b>100</b>	<b>116</b>	<b>100</b>	<b>135</b>	<b>100</b>	<b>33</b>	<b>100</b>	<b>6</b>	<b>100</b>	<b>43</b>	<b>100</b>	<b>356</b>	<b>100</b>
<b>Marks: Spur Bowls</b>																
Moulded spur mark											2	8	1	2	3	3
Stamped bowl mark							2	11	1	17					3	3
Moulded bowl mark													6	11	6	6
Unmarked bowls			1	100	4	100	17	89	5	83	23	92	46	87	96	89
<b>Totals:</b>	<b>0</b>	<b>0</b>	<b>1</b>	<b>100</b>	<b>4</b>	<b>100</b>	<b>19</b>	<b>100</b>	<b>6</b>	<b>100</b>	<b>25</b>	<b>100</b>	<b>53</b>	<b>100</b>	<b>108</b>	<b>100</b>
<b>Marks: Unidentified bowls</b>																
Stamped bowl mark									3	50	2	18			5	9
Moulded bowl mark																
Unmarked bowls			3	100	5	100	10	100	3	50	9	82	19	100	49	91
<b>Totals:</b>	<b>0</b>	<b>0</b>	<b>3</b>	<b>100</b>	<b>5</b>	<b>100</b>	<b>10</b>	<b>100</b>	<b>6</b>	<b>100</b>	<b>11</b>	<b>100</b>	<b>19</b>	<b>100</b>	<b>54</b>	<b>100</b>
<b>Stem Marks</b>																
Stamped stem mark					3				3		36		88		130	
Stem twist													1		1	
Unmarked stems							1		1				8		10	
<b>Totals:</b>	<b>0</b>	<b>N/A</b>	<b>0</b>	<b>N/A</b>	<b>3</b>	<b>N/A</b>	<b>1</b>	<b>N/A</b>	<b>4</b>	<b>N/A</b>	<b>36</b>	<b>N/A</b>	<b>97</b>	<b>N/A</b>	<b>141</b>	<b>N/A</b>
<b>Burnishing: Bowls &amp; stems</b>																
No burnishing	1	100	8	57	97	83	72	60	17	40	44	66	196	97	435	79
Poor			1	7	1	1	6	5	2	5			2	1	12	2
Average			3	21			23	19	10	23	8	12	1	0	45	8
Good			2		6	6	19	16	13	30	14	21	4	2	58	10
Fine							1	1	1	2	1	1			3	1
<b>Totals:</b>	<b>1</b>	<b>100</b>	<b>14</b>	<b>86</b>	<b>104</b>	<b>100</b>	<b>121</b>	<b>100</b>	<b>43</b>	<b>100</b>	<b>67</b>	<b>100</b>	<b>203</b>	<b>100</b>	<b>553</b>	<b>100</b>
<b>Stem bore: Bowls &amp; stems</b>																
Bore 3/64													1	1	1	0
Bore 4/64											28	42	56	43	84	17
Bore 5/64			1	5	3	3	12	9	11	31	38	55	72	56	135	27
Bore 6/64			4	20	37	35	51	36	18	51	1	2			111	22
Bore 7/64	1	100	9	45	57	53	69	49	5	14	1	2			142	29
Bore 8/64			4	20	9	8			1	3					14	3
Bore 9/64			2	10	1	1	8	6							11	2
<b>Totals:</b>	<b>1</b>	<b>100</b>	<b>20</b>	<b>100</b>	<b>107</b>	<b>100</b>	<b>140</b>	<b>100</b>	<b>35</b>	<b>100</b>	<b>66</b>	<b>100</b>	<b>129</b>	<b>100</b>	<b>498</b>	<b>100</b>

(Table 2 continued)

<b>Milling: Bowls only</b>																
M4			18	95	51	52	26	20	3	9					98	25
M3					24	24	27	21	2	6					53	13
M2					11	11	32	28	5	15	1	3			49	12
M1					4	4	5	3	4	12					13	3
M0	1	100	1	5	9	9	39	31	19	58	29	97	83	100	181	48
<b>Totals:</b>	1	100	19	100	99	100	129	101	33	100	30	100	83	100	394	100
<b>Bowl Crosses: Bowls only</b>																
Type X							71	1			1	3			2	0
Type +											9	30			9	2
No bowl cross	1	100	19	100	95	100	128	99	37	100	20	67	112	100	412	97
<b>Totals:</b>	1	100	19	100	95	100	129	100	37	100	30	100	112	100	423	100



**TABLE 3 – Sites for South Yorkshire**

	County	Parish	Site name	1500-1610	1610-1640	1640-1660	1660-1690	1690-1720	1720-1750	1750-1800	Totals
1	S. Yorkshire	Berby Dun	25 The Grove				1	1			2
2	S. Yorkshire	Barnsley	Rockley Smithies			3	2				5
3	S. Yorkshire	Bewtry	Church Street			6		1	1	1	9
4	S. Yorkshire	Castleford	Roman excavations						1		1
5	S. Yorkshire	Doncaster	Bextergate, Site DA			1		2		1	4
6	S. Yorkshire	Doncaster	Church Street, Site DC, DY, DX and DCH			1	4		32	182	219
7	S. Yorkshire	Doncaster	East of Sepulchre Gate, Site DEH					1		1	2
8	S. Yorkshire	Doncaster	East side of St George's Gate, Site DR		1	1				1	3
9	S. Yorkshire	Doncaster	Fishergate			36	1				37
10	S. Yorkshire	Doncaster	Hall Gate				3				3
11	S. Yorkshire	Doncaster	High Fishergate, Site DCW			1			1		2
12	S. Yorkshire	Doncaster	High Street, Site DJ				1		1		2
13	S. Yorkshire	Doncaster	Lord Street, Site DF				2	1	1	1	5
14	S. Yorkshire	Doncaster	Low Fishergate				3		3	1	7
15	S. Yorkshire	Doncaster	Market Place, Site DMP				3	1			4
16	S. Yorkshire	Doncaster	New Museum Site (1961), Site DK				3				3
17	S. Yorkshire	Doncaster	North side of Church Way (St. George's), Site DT		1	2	3	1	3	4	14
18	S. Yorkshire	Doncaster	North side of Church Way, Site DV					2			2
19	S. Yorkshire	Doncaster	Site DM		1		1	1			3
20	S. Yorkshire	Doncaster	South side of Church Way, Site DQ			2	3		1	5	11
21	S. Yorkshire	Doncaster	South side of High Street, Site DSR		1	5	7	1		1	15
22	S. Yorkshire	Doncaster	St George's Church Yard			1		2			3
23	S. Yorkshire	Doncaster	Thorne Peel Hill				4				4
24	S. Yorkshire	Doncaster	Unprovenanced but probably from Doncaster			7	11	1	3	2	24
25	S. Yorkshire	Doncaster	West side of St George's Gate, Site DS		1	10	10	2	1		24
26	S. Yorkshire	Helleby	Helleby Hall			4	9				13
27	S. Yorkshire	Maltby	Stone				2	4			6
28	S. Yorkshire	Nethergreen	7 Storth Lane		1	2	1				4
29	S. Yorkshire	Nr Doncaster	Roman Camp				1				1
30	S. Yorkshire	Nr Rotherham	Catcliffe					1			1
31	S. Yorkshire	Nr Sheffield	Temple Borough				1			1	2
32	S. Yorkshire	Nr Sheffield	Toreide Reservoir				1				1
33	S. Yorkshire	Nr Sheffield	Westfield			1					1
34	S. Yorkshire	Rookley	Rookley Furnaces					2	1		3
35	S. Yorkshire	Rotherham	15 Doncaster Place				2				2
36	S. Yorkshire	Rotherham	Alms Road				2	3			5
37	S. Yorkshire	Rotherham	Canklow				1	2			3
38	S. Yorkshire	Rotherham	Fenton Lane, Kimberworth Park					1			1
39	S. Yorkshire	Rotherham	High Hazels					1			1
40	S. Yorkshire	Rotherham	Ioklee Hall Farm			1					1
41	S. Yorkshire	Rotherham	Riley's Garage, Westgate Green						2		2

**(Table 3 continued)**

	County	Parish	Site name	1599-1610	1610-1649	1649-1689	1689-1699	1699-1729	1729-1799	1799-1899	Totals
42	S. Yorkshire	Rotherham	Treeton				1				1
43	S. Yorkshire	Rotherham	Uiley Church Yard						1		1
44	S. Yorkshire	Rotherham	Unprovenanced material			3	13	4	2		22
45	S. Yorkshire	Sheffield	Cherry Tree House, Cherry Tree Road, Nether Edge			2		1			3
46	S. Yorkshire	Sheffield	Midhope Reservoir					1			1
47	S. Yorkshire	Sheffield	Riverside Exchange				2	1	7	9	19
48	S. Yorkshire	Sheffield	Sheffield Castle		7	8	5	2	1		23
49	S. Yorkshire	Sheffield	Stone lined drain at allotments				1				1
50	S. Yorkshire	Sheffield	Totley Moor			1					1
51	S. Yorkshire	Sheffield	Unprovenanced but probably Sheffield		1	1	5	2		1	10
52	S. Yorkshire	Sheffield	Unprovenanced material in Kelham Island Museum, Sheffield		1	5	6	7			19
53	S. Yorkshire	Stockbridge	Bolesterstone Glasshouse						2		2
54	S. Yorkshire	Thorne	Thorne Area	1	10	22	50	8	11		102
			Totals:	1	26	130	167	50	75	211	660

**TABLE 4 – Collections for South Yorkshire**

	Collection Name	1599-1610	1610-1649	1649-1689	1689-1699	1699-1729	1729-1799	1799-1899	Totals
1	ARCUS				2	1	7	9	19
2	Birmingham Museum & Art Gallery				1	2			3
3	Brackenridge Collection			2		1			3
4	Doncaster Museum & Art Gallery		5	66	58	16	46	199	390
5	Kelham Island Industrial Museum		4	9	15	9			37
6	Not known			3	2		2		7
7	Rotherham Museum		1	8	23	9	5	1	47
8	Sheffield City Museum		6	9	5	1	1	1	23
9	South Yorkshire Archaeology Unit			10	9	1	1	1	22
10	University of Sheffield					2	1		3
11	Wakefield Museum & Art Gallery						1		1
12	White Collection	1	10	22	50	8	11		102
13	York Archaeological Trust			1	2				3
	Totals:	1	26	130	167	50	75	211	660

**TABLE 5 – Imports for South Yorkshire**

	1590-1619	1610-1640	1640-1660	1660-1690	1690-1720	1700-1750	1750-1800	Totals
<b>Place of Origin</b>								
Brosely				1	2			3
Chester						1		1
Rainford			1					1
South Lancashire				1				1
Unknown, but not a Yorkshire product			2		1			3
Netherlands			1					1
<b>Totals:</b>	0	0	4	2	3	1	0	10

**TABLE 1 – All fragments for North-west Yorkshire**

North-west Yorkshire	c1580-1610			c1610-1640			c1640-1660			c1660-1690			c1690-1720			c1700-1750		
	Unpub	Pub	Imp	Unpub	Pub	Imp	Unpub	Pub	Imp	Unpub	Pub	Imp	Unpub	Pub	Imp	Unpub	Pub	Imp
<b>Count: Bowls &amp; stems</b>																		
Bowls	2		1	20			142	18		124	1	6	44	1	4	23		6
Stems							2	2		3	3		16	9		14		1
<b>Totals:</b>	<b>2</b>	<b>0</b>	<b>1</b>	<b>20</b>	<b>0</b>	<b>0</b>	<b>144</b>	<b>0</b>	<b>20</b>	<b>127</b>	<b>1</b>	<b>9</b>	<b>60</b>	<b>1</b>	<b>13</b>	<b>37</b>	<b>0</b>	<b>7</b>
<b>Bowl Types: Bowls only</b>																		
Heel bowls	1			19			113	5		105	1	2	26		3	20		6
Spur bowls							15	12		6	3		8	1				
Unidentified bowls	1		1	1			14	1		13	1		10		1	3		
<b>Totals:</b>	<b>2</b>	<b>0</b>	<b>1</b>	<b>20</b>	<b>0</b>	<b>0</b>	<b>142</b>	<b>0</b>	<b>18</b>	<b>124</b>	<b>1</b>	<b>6</b>	<b>44</b>	<b>1</b>	<b>4</b>	<b>23</b>	<b>0</b>	<b>6</b>
<b>Bowl Marks</b>																		
Stamped heel mark				7			17	1		25			8					
Moulded heel mark													3		1	15		5
Moulded spur mark																		
Stamped bowl mark							3	3		1	1							
Moulded bowl mark							1	1		1	1							
Unmarked bowls	2		1	13			120	13		97	1	4	30	1	2	7		1
<b>Totals:</b>	<b>2</b>	<b>0</b>	<b>1</b>	<b>20</b>	<b>0</b>	<b>0</b>	<b>141</b>	<b>0</b>	<b>18</b>	<b>124</b>	<b>1</b>	<b>6</b>	<b>41</b>	<b>1</b>	<b>3</b>	<b>22</b>	<b>0</b>	<b>6</b>
<b>Stem Marks</b>																		
Stamped stem mark							3	2		3	3		19		10	15		1
Stem twist																		
Unmarked stems																		
<b>Totals:</b>	<b>0</b>	<b>0</b>	<b>0</b>	<b>0</b>	<b>0</b>	<b>0</b>	<b>3</b>	<b>0</b>	<b>2</b>	<b>3</b>	<b>0</b>	<b>3</b>	<b>19</b>	<b>0</b>	<b>10</b>	<b>15</b>	<b>0</b>	<b>1</b>
<b>Burnishing: All fragments</b>																		
No burnishing	1		1	12			126	19		89	8		39		11	24		6
Poor	1			1			1			5	1					1		
Average				2			3			5			10					
Good				1			1			4			4					
Fine													2		1			
Can't tell				4			13	1		24	1		5	1	1	12		1
<b>Totals:</b>	<b>2</b>	<b>0</b>	<b>1</b>	<b>20</b>	<b>0</b>	<b>0</b>	<b>144</b>	<b>0</b>	<b>20</b>	<b>127</b>	<b>1</b>	<b>9</b>	<b>60</b>	<b>1</b>	<b>13</b>	<b>37</b>	<b>0</b>	<b>7</b>
<b>Stem bore: All fragments</b>																		
Bore 3/64													1					
Bore 4/64																		
Bore 5/64				1			7	1		5			23		3	9		2
Bore 6/64				3			16	1		16	2		14		6	11		5
Bore 7/64				8			63	13		59	5		4		2	1		
Bore 8/64				2			17	3		12	2							
Bore 9/64				1														
Unmeasurable	2		1	5			41	2		35	1		18	1	2	16		
<b>Totals:</b>	<b>2</b>	<b>0</b>	<b>1</b>	<b>20</b>	<b>0</b>	<b>0</b>	<b>144</b>	<b>0</b>	<b>20</b>	<b>127</b>	<b>1</b>	<b>9</b>	<b>60</b>	<b>1</b>	<b>13</b>	<b>37</b>	<b>0</b>	<b>7</b>
<b>Milling: Bowls only</b>																		
M4				10			30	2		10	1							
M3							9	1		7	1							
M2							19	4		17	1		6		1			
M1							9	4		13						1		
M0	1			6			34	5		41			19		1	9		3
Milling on all surviving rim	1		1	1			10			13	3		4		1			
Unmeasurable				3			31	2		23	1		15	1	1	13		3
<b>Totals:</b>	<b>2</b>	<b>0</b>	<b>1</b>	<b>20</b>	<b>0</b>	<b>0</b>	<b>142</b>	<b>0</b>	<b>18</b>	<b>124</b>	<b>1</b>	<b>6</b>	<b>44</b>	<b>1</b>	<b>4</b>	<b>23</b>	<b>0</b>	<b>6</b>
<b>Bowl Crosses: Bowls only</b>																		
Type X																		
Type +																		
No bowl cross	1			13			124	16		110	4		33		2	19		5
Can't tell	1		1	7			18	2		14	1	2	11	1	2	4		1
<b>Totals:</b>	<b>2</b>	<b>0</b>	<b>1</b>	<b>20</b>	<b>0</b>	<b>0</b>	<b>142</b>	<b>0</b>	<b>18</b>	<b>124</b>	<b>1</b>	<b>6</b>	<b>44</b>	<b>1</b>	<b>4</b>	<b>23</b>	<b>0</b>	<b>6</b>

(Table 1 continued)

North-west Yorkshire	c1750-1800			Totals:			TOTALS
	Unpub	Pub	Imp	Unpub	Pub	Imp	
<b>Count: Bowls &amp; stems</b>							
Bowls				355	2	35	357
Stems	2			37	0	15	37
<b>Totals:</b>	<b>2</b>	<b>0</b>	<b>0</b>	<b>392</b>	<b>2</b>	<b>50</b>	<b>394</b>
<b>Bowl Types: Bowls only</b>							
Heel bowls				264	1	16	265
Spur bowls				29	1	15	30
Unidentified bowls				42	0	4	42
<b>Totals:</b>	<b>0</b>	<b>0</b>	<b>0</b>	<b>355</b>	<b>2</b>	<b>35</b>	<b>357</b>
<b>Bowl Marks</b>							
Stamped heel mark				57	0	1	57
Moulded heel mark				18	0	6	18
Moulded spur mark				0	0	0	0
Stamped bowl mark				4	0	4	4
Moulded bowl mark				2	0	2	2
Unmarked bowls				269	2	21	271
<b>Totals:</b>	<b>0</b>	<b>0</b>	<b>0</b>	<b>350</b>	<b>2</b>	<b>34</b>	<b>352</b>
<b>Stem Marks</b>							
Stamped stem mark	2			42	0	16	42
Stem twist				0	0	0	0
Unmarked stems				0	0	0	0
<b>Totals:</b>	<b>2</b>	<b>0</b>	<b>0</b>	<b>42</b>	<b>0</b>	<b>16</b>	<b>42</b>
<b>Burnishing: All fragments</b>							
No burnishing				291	0	45	291
Poor				9	0	1	9
Average				20	0	0	20
Good				10	0	0	10
Fine				2	0	1	2
Can't tell	2			60	2	3	62
<b>Totals:</b>	<b>2</b>	<b>0</b>	<b>0</b>	<b>392</b>	<b>2</b>	<b>50</b>	<b>394</b>
<b>Stem bore: All fragments</b>							
Bore 3/64				0	0	0	0
Bore 4/64				1	0	0	1
Bore 5/64				45	0	6	45
Bore 6/64				60	0	14	60
Bore 7/64				135	0	20	135
Bore 8/64				31	0	5	31
Bore 9/64				1	0	0	1
Unmeasurable	2			119	2	5	121
<b>Totals:</b>	<b>2</b>	<b>0</b>	<b>0</b>	<b>392</b>	<b>2</b>	<b>50</b>	<b>394</b>
<b>Milling: Bowls only</b>							
M4				50	0	3	50
M3				16	0	2	16
M2				42	0	6	42
M1				23	0	4	23
M0				110	0	9	110
Milling on all surviving rim				29	0	5	29
Unmeasurable				85	2	6	87
<b>Totals:</b>	<b>0</b>	<b>0</b>	<b>0</b>	<b>355</b>	<b>2</b>	<b>35</b>	<b>357</b>
<b>Bowl Crosses: Bowls only</b>							
Type X				0	0	0	0
Type +				0	0	0	0
No bowl cross				300	0	27	300
Can't tell				55	2	8	57
<b>Totals:</b>	<b>0</b>	<b>0</b>	<b>0</b>	<b>355</b>	<b>2</b>	<b>35</b>	<b>357</b>

**TABLE 2 – Yorkshire products from North-west Yorkshire**

North-west Yorkshire	c1580-1610		c1610-1640		c1640-1660		c1660-1690		c1690-1720		c1700-1750		c1750-1800		TOTAL	
	Total	%	Total	%	Total	%	Total	%	Total	%	Total	%	Total	%	Total	%
<b>Count: Bowls &amp; stems</b>																
Bowls (all fragments)	1	100	20	100	124	100	119	100	41	85	17	57			322	84
Stems									7	15	13	43	2	100	22	8
<b>Totals:</b>	<b>1</b>	<b>100</b>	<b>20</b>	<b>100</b>	<b>124</b>	<b>100</b>	<b>119</b>	<b>100</b>	<b>48</b>	<b>100</b>	<b>30</b>	<b>100</b>	<b>2</b>	<b>100</b>	<b>344</b>	<b>100</b>
<b>Bowl Types: Bowls only</b>																
Heel bowls	1	100	19	100	108	97	104	97	23	72	14	100			269	95
Spur bowls					3	3	3	3	9	28					15	5
<b>Totals:</b>	<b>1</b>	<b>100</b>	<b>19</b>	<b>100</b>	<b>111</b>	<b>100</b>	<b>107</b>	<b>100</b>	<b>32</b>	<b>100</b>	<b>14</b>	<b>100</b>	<b>0</b>	<b>0</b>	<b>284</b>	<b>100</b>
<b>All Marks</b>																
Stamped heels			7	35	16	13	25	21	8	17					56	18
Moulded heels									2	4	10	33			12	3
Moulded spurs																
Stamped bowl marks																
Moulded bowl marks																
Stamped stems					1				9	19	14	47	2	100	26	8
Stem twists																
Unmarked fragments	1	100	13	65	107	86	94	79	29	60	6	20			250	73
<b>Totals:</b>	<b>1</b>	<b>100</b>	<b>20</b>	<b>100</b>	<b>124</b>	<b>99</b>	<b>119</b>	<b>100</b>	<b>48</b>	<b>100</b>	<b>30</b>	<b>100</b>	<b>2</b>	<b>100</b>	<b>344</b>	<b>100</b>
<b>Marks: Heel Bowls</b>																
Stamped heel mark			7	37	16	15	25	24	8	35					56	21
Moulded heel mark									2	8	10	71			12	4
Stamped bowl mark																
Moulded bowl mark																
Unmarked bowls	1	100	12	63	92	85	79	76	13	57	4	29			201	75
<b>Totals:</b>	<b>1</b>	<b>100</b>	<b>19</b>	<b>100</b>	<b>108</b>	<b>100</b>	<b>104</b>	<b>100</b>	<b>23</b>	<b>100</b>	<b>14</b>	<b>100</b>	<b>0</b>	<b>0</b>	<b>269</b>	<b>100</b>
<b>Marks: Spur Bowls</b>																
Moulded spur mark																
Stamped bowl mark																
Moulded bowl mark																
Unmarked bowls					3	100	3	100	9	100					15	100
<b>Totals:</b>	<b>0</b>	<b>0</b>	<b>0</b>	<b>0</b>	<b>3</b>	<b>100</b>	<b>3</b>	<b>100</b>	<b>9</b>	<b>100</b>	<b>0</b>	<b>0</b>	<b>0</b>	<b>0</b>	<b>15</b>	<b>100</b>
<b>Marks: Unidentified bowls</b>																
Stamped bowl mark																
Moulded bowl mark																
Unmarked bowls			1		13	100	12	100	9	100	3	100			38	148
<b>Totals:</b>	<b>0</b>	<b>0</b>	<b>1</b>	<b>0</b>	<b>13</b>	<b>100</b>	<b>12</b>	<b>100</b>	<b>9</b>	<b>100</b>	<b>3</b>	<b>100</b>	<b>0</b>	<b>0</b>	<b>38</b>	<b>148.2</b>
<b>Marks: Stems</b>																
Stamped stem mark					1				9		14		2		26	
Stem twist																
Unmarked stems																
<b>Totals:</b>	<b>0</b>	<b>N/A</b>	<b>0</b>	<b>N/A</b>	<b>1</b>	<b>N/A</b>	<b>0</b>	<b>N/A</b>	<b>9</b>	<b>N/A</b>	<b>14</b>	<b>N/A</b>	<b>2</b>	<b>N/A</b>	<b>26</b>	<b>N/A</b>
<b>Burnishing: Bowls &amp; stems</b>																
No burnishing			12	75	107	96	81	86	28	65	18	95			246	86
Poor	1	100	1	6	1	1	4	4			1	5			8	3
Average			2	13	3	3	5	5	10	23					20	7
Good			1	6	1	1	4	4	4	9					10	4
Fine									1	2					1	0
<b>Totals:</b>	<b>1</b>	<b>100</b>	<b>16</b>	<b>100</b>	<b>112</b>	<b>100</b>	<b>94</b>	<b>100</b>	<b>43</b>	<b>100</b>	<b>19</b>	<b>100</b>	<b>0</b>	<b>0</b>	<b>285</b>	<b>100</b>
<b>Stem bore: Bowls &amp; stems</b>																
Bore 3/64																
Bore 4/64									1	3					1	0
Bore 5/64			1	7	6	7	5	6	20	65	7	50			39	17
Bore 6/64			3	20	15	18	14	17	8	26	6	43			46	20
Bore 7/64			8	53	50	59	54	65	2	6	1	7			115	50
Bore 8/64			2	13	14	16	10	12							26	11

(Table 2 continued)

Bore 9/64			1	7											1	0
Totals:	0	0	15	100	85	100	83	100	31	100	14	100	0	0	228	100
<b>Milling: Bowls only</b>																
M4			10	63	28	33	9	11							47	22
M3					8	9	6	7							14	6
M2					15	18	16	19	5	22					36	17
M1					5	6	13	15			1	14			19	9
M0	1	100	6	38	29	34	41	48	18	78	6	88			101	47
Totals:	1	0	16	100	85	100	85	100	23	100	7	100	0	0	217	100
<b>Bowl Crosses: Bowls only</b>																
Type X																
Type +																
No bowl cross	1	100	13	100	108	100	106	100	31	100	14	100			273	100
Totals:	1	0	13	100	108	100	106	100	31	100	14	100	0	0	273	100

**TABLE 3 – Sites for North-west Yorkshire**

	County	Parish	Site name	1590-1610	1610-1640	1640-1660	1660-1690	1690-1720	1720-1750	1750-1800	Totals
1	C. Durham	Barnard Castle	Barnard Castle Excavations		2	3		3	3		11
2	C. Durham	Barnard Castle	Inner Ward		2		3	6	2		13
3	C. Durham	Barnard Castle	Town Ward - Area 1			10					10
4	C. Durham	Barnard Castle	Town Ward - Area 2		1	4	2	5	6		18
5	C. Durham	Barnard Castle	Town Ward - Wet Moat		1	5	5		5		16
6	Lancashire	Staidburn	Stocks Reservoir			1	1				2
7	N. Yorkshire	Blubberhouses	Blubberhouses Moor			5	19	10			34
8	N. Yorkshire	Brownlow	Near Lime Kiln			1					1
9	N. Yorkshire	Burton in Lonsdale	Castle earthworks				1	1			2
10	N. Yorkshire	Caiton	Caiton Lodge		1						1
11	N. Yorkshire	Carleton	a field in Carleton			2					2
12	N. Yorkshire	Carleton					1				1
13	N. Yorkshire	Glusburn	Garden of Yew Cottage			2					2
14	N. Yorkshire	Grassington	Cove Pasture				1				1
15	N. Yorkshire	Grassington	Grassington Moor			1					1
16	N. Yorkshire	Grassington	Lea Green		1	2	1				4
17	N. Yorkshire	Greenhow Hill	Greenhow Mines				1				1
18	N. Yorkshire	Kildwick	Building site on south side of river		4	12	9	1			26
19	N. Yorkshire	Knaresborough	Knaresborough Castle		2	24	15	3	13		57
20	N. Yorkshire	Pierobridge	Bridge Head (abutment)				1				1
21	N. Yorkshire	Pierobridge	Pierobridge general		1	37	31	7	4	1	81
22	N. Yorkshire	Richmond	Richmond Castle	1							1
23	N. Yorkshire	Richmond	Unprovenanced but probably from Richmond	1	1	8	7	8	1		26
24	N. Yorkshire	Ripon	Bedern Bank			4	9	11	2		26
25	N. Yorkshire	Ripon	St Agneegate				2				2
26	N. Yorkshire	Settle			1	1					2
27	N. Yorkshire	Sharrow	Unprovenanced but probably from Sharrow				1				1
28	N. Yorkshire	Skipton	Canal Yard					4	1		5
29	N. Yorkshire	Skipton	Friends Meeting House			1					1
30	N. Yorkshire	Skipton	Oakley Road			1	1				2
31	N. Yorkshire	Skipton	Old Grammar School				1				1
32	N. Yorkshire	Skipton	Park Hill			1	1				2
33	N. Yorkshire	Skipton	Ryston			1					1
34	N. Yorkshire	Skipton	Skipton Castle			1	1				2
35	N. Yorkshire	Skipton	Unprovenanced material from Skipton area		1	1	1	1			4
36	N. Yorkshire	Skipton	Unspecified site in Skipton or Skipton area			1					1
37	N. Yorkshire	Skipton	Unprovenanced material in Craven Museum			6	5	1			12
38	N. Yorkshire	Unknown	Unprovenanced material in Dales Countryside Museum		1		2				3
39	N. Yorkshire	Unknown	Unprovenanced material in Richmondshire Museum							1	1
40	N. Yorkshire		Grimwith			2					2
41	N. Yorkshire		Grimwith Reservoir		1	5	5				11
42	N. Yorkshire		Lolly Soar Mine, Nidderdale			1					1





**TABLE 5 – Imports for North-west Yorkshire**

	1500-1610	1610-1640	1640-1660	1660-1690	1690-1720	1720-1750	1750-1800	Totals
<b>Place of origin</b>								
Gateshead			1	3	5	5		14
London					2			2
Newcastle			2			1		3
North-east					3			3
Rainford				1				1
South Lancashire			3					3
Tyneside			14	5	2			21
The Netherlands	1				1	1		3
<b>Totals</b>	<b>1</b>	<b>0</b>	<b>20</b>	<b>9</b>	<b>13</b>	<b>7</b>	<b>0</b>	<b>50</b>

**TABLE 1 – All fragments for North-east Yorkshire**

North-east Yorkshire	c1500-1610			c1610-1640			c1640-1660			c1660-1690			c1690-1720			c1700-1750		
	Unpub	Pub	Imp	Unpub	Pub	Imp	Unpub	Pub	Imp	Unpub	Pub	Imp	Unpub	Pub	Imp	Unpub	Pub	Imp
<b>Count: Bows &amp; stems</b>																		
Bows	1			43	1	2	174	5	13	142	12		37	2	1	43		6
Stems				3		2	10		8	7		6	13	1	13	8	1	3
Mouthpieces				2														
<b>Totals:</b>	<b>1</b>	<b>0</b>	<b>0</b>	<b>48</b>	<b>1</b>	<b>4</b>	<b>184</b>	<b>5</b>	<b>21</b>	<b>149</b>	<b>12</b>	<b>6</b>	<b>50</b>	<b>3</b>	<b>14</b>	<b>51</b>	<b>1</b>	<b>9</b>
<b>Bowl Types: Bows only</b>																		
Heel bows	1			27	1	1	111	5	6	107	12		21		1	19		
Spur bows				3			5			9			6	2		9		4
Unidentified bows				13		1	58		7	26			10			15		2
<b>Totals:</b>	<b>1</b>	<b>0</b>	<b>0</b>	<b>43</b>	<b>1</b>	<b>2</b>	<b>174</b>	<b>5</b>	<b>13</b>	<b>142</b>	<b>12</b>	<b>0</b>	<b>37</b>	<b>2</b>	<b>1</b>	<b>43</b>	<b>0</b>	<b>6</b>
<b>Bowl Marks</b>																		
Stamped heel mark				5		1	14	1	2	31	4		9			1		
Moulded heel mark													3		1	13		
Moulded spur mark													1			6		2
Stamped bowl mark																		
Moulded bowl mark							4		4									
Unmarked bows	1			38	1	1	156	4	7	111	8		24	2		23		4
<b>Totals:</b>	<b>1</b>	<b>0</b>	<b>0</b>	<b>43</b>	<b>1</b>	<b>2</b>	<b>174</b>	<b>5</b>	<b>13</b>	<b>142</b>	<b>12</b>	<b>0</b>	<b>37</b>	<b>2</b>	<b>1</b>	<b>43</b>	<b>0</b>	<b>6</b>
<b>Stem Marks</b>																		
Stamped stem mark				2		2	6		5	7		6	14		13	5	1	1
Stem twist																		
Unmarked stems				1			4		3							3		2
<b>Totals:</b>	<b>0</b>	<b>0</b>	<b>0</b>	<b>3</b>	<b>0</b>	<b>2</b>	<b>10</b>	<b>0</b>	<b>8</b>	<b>7</b>	<b>0</b>	<b>6</b>	<b>14</b>	<b>0</b>	<b>13</b>	<b>8</b>	<b>1</b>	<b>3</b>
<b>Burnishing: Bows &amp; Stems</b>																		
No burnishing	1			38		1	162	1	15	120	3	6	34	2	4	44		5
Poor				1			2			3								
Average				1			6		4	10			2		1			
Good							3			4			6		6	2		
Fine				5		3	2		1				1		1	1		1
Can't tell				3	1		9	4	1	12	9		7	1	2	4	1	3
<b>Totals:</b>	<b>1</b>	<b>0</b>	<b>0</b>	<b>48</b>	<b>1</b>	<b>4</b>	<b>184</b>	<b>5</b>	<b>21</b>	<b>149</b>	<b>12</b>	<b>6</b>	<b>50</b>	<b>3</b>	<b>14</b>	<b>51</b>	<b>1</b>	<b>9</b>
<b>Stem bore: Bows &amp; Stems</b>																		
Bore 3/64																1		
Bore 4/64							3		1				2		1	5		1
Bore 5/64				1			6		4	7		1	17		5	24	1	7
Bore 6/64				14			42		9	39	1		16	3	4	11		1
Bore 7/64	1			29	1	3	93	1	4	70	2	5	7		3			
Bore 8/64				3			23		2	14								
Bore 9/64																		
Unmeasurable				1		1	17	4	1	19	9		8		1	10		
<b>Totals:</b>	<b>1</b>	<b>0</b>	<b>0</b>	<b>48</b>	<b>1</b>	<b>4</b>	<b>184</b>	<b>5</b>	<b>21</b>	<b>149</b>	<b>12</b>	<b>6</b>	<b>50</b>	<b>3</b>	<b>14</b>	<b>51</b>	<b>1</b>	<b>9</b>
<b>Milling: Bows only</b>																		
M4				11		1	36			7								
M3							17		1	8								
M2				3			7			31			2					
M1				1			9		2	11			2					
M0	1						50	1	8	37			13	2	1	23		3
Milling on all surviving rim				6			27	1		11	1		5					
Unmeasurable				22	1	1	28	3	2	37	11		15			20		3
<b>Totals:</b>	<b>1</b>	<b>0</b>	<b>0</b>	<b>43</b>	<b>1</b>	<b>2</b>	<b>174</b>	<b>5</b>	<b>13</b>	<b>142</b>	<b>12</b>	<b>0</b>	<b>37</b>	<b>2</b>	<b>1</b>	<b>43</b>	<b>0</b>	<b>6</b>
<b>Bowl Crosses: Bows only</b>																		
Type X																		
Type +																		
No bowl cross	1			21			129	1	9	95	3		24	2	1	30		6
Can't tell				22	1	2	45	4	4	47	9		13			13		
<b>Totals:</b>	<b>1</b>	<b>0</b>	<b>0</b>	<b>43</b>	<b>1</b>	<b>2</b>	<b>174</b>	<b>5</b>	<b>13</b>	<b>142</b>	<b>12</b>	<b>0</b>	<b>37</b>	<b>2</b>	<b>1</b>	<b>43</b>	<b>0</b>	<b>6</b>

(Table 1 continued)

North-east Yorkshire	c1750-1800			Totals:			TOTALS
	Unpub	Pub	Imp	Unpub	Pub	Imp	
<b>Count: Bowls &amp; stems</b>							
Bowls	6			446	20	22	466
Stems	16	4	2	57	6	34	63
Mouthpieces				2	0	0	2
<b>Totals:</b>	<b>22</b>	<b>4</b>	<b>2</b>	<b>503</b>	<b>26</b>	<b>56</b>	<b>531</b>
<b>Bowl Types: Bowls only</b>							
Heel bowls	3			289	18	8	307
Spur bowls	1			33	2	4	35
Unidentified bowls	2			124	0	10	124
<b>Totals:</b>	<b>6</b>	<b>0</b>	<b>0</b>	<b>446</b>	<b>20</b>	<b>22</b>	<b>466</b>
<b>Bowl Marks</b>							
Stamped heel mark				60	5	3	65
Moulded heel mark	2			18	0	1	18
Moulded spur mark	1			8	0	2	8
Stamped bowl mark				0	0	0	0
Moulded bowl mark				4	0	4	4
Unmarked bowls	2			355	15	12	370
<b>Totals:</b>	<b>5</b>	<b>0</b>	<b>0</b>	<b>445</b>	<b>20</b>	<b>22</b>	<b>465</b>
<b>Stem Marks</b>							
Stamped stem mark	17	4	2	51	5	29	56
Stem twist				0	0	0	0
Unmarked stems				8	0	5	8
<b>Totals:</b>	<b>17</b>	<b>4</b>	<b>2</b>	<b>59</b>	<b>5</b>	<b>34</b>	<b>64</b>
<b>Burnishing: Bowls &amp; Stems</b>							
No burnishing	10		2	409	6	33	415
Poor				6	0	0	6
Average				19	0	5	19
Good	2			17	0	6	17
Fine				9	0	3	9
Can't tell	10	4		45	20	6	65
<b>Totals:</b>	<b>22</b>	<b>4</b>	<b>2</b>	<b>505</b>	<b>26</b>	<b>53</b>	<b>531</b>
<b>Stem bore: Bowls &amp; Stems</b>							
Bore 3/64	1		1	2	0	1	2
Bore 4/64	2	1	1	12	1	4	13
Bore 5/64	11	2		66	3	17	69
Bore 6/64				122	4	14	126
Bore 7/64				200	4	15	204
Bore 8/64				40	0	2	40
Bore 9/64				0	0	0	0
Unmeasurable	8	1		63	14	3	77
<b>Totals:</b>	<b>22</b>	<b>4</b>	<b>2</b>	<b>505</b>	<b>26</b>	<b>56</b>	<b>531</b>
<b>Milling: Bowls only</b>							
M4				54	0	1	54
M3				25	0	1	25
M2				43	0	0	43
M1				23	0	2	23
M0	4			128	3	12	131
Milling on all surviving rim				49	2	0	51
Unmeasurable	2			124	15	6	139
<b>Totals:</b>	<b>6</b>	<b>0</b>	<b>0</b>	<b>446</b>	<b>20</b>	<b>22</b>	<b>466</b>
<b>Bowl Crosses: Bowls only</b>							
Type X				0	0	0	0
Type +				0	0	0	0
No bowl cross	3			303	6	16	309
Can't tell	3			143	14	6	157
<b>Totals:</b>	<b>6</b>	<b>0</b>	<b>0</b>	<b>446</b>	<b>20</b>	<b>22</b>	<b>466</b>

**TABLE 2 – Yorkshire products from North-east Yorkshire**

North-east Yorkshire	c1580-1610		c1610-1640		c1640-1660		c1660-1690		c1690-1720		c1700-1750		c1750-1800		TOTAL	
	Total	%	Total	%	Total	%	Total	%	Total	%	Total	%	Total	%	Total	%
<b>Count: All fragments</b>																
Bowls (all fragments)	1	100	42	93	166	99	154	99	38	97	37	86	6	25	444	93
Stems			1	2	2	1	1	1	1	1	6	1	18	75	29	8
Mouthpieces			2	4											2	0
<b>Totals:</b>	<b>1</b>	<b>100</b>	<b>45</b>	<b>100</b>	<b>168</b>	<b>100</b>	<b>155</b>	<b>100</b>	<b>39</b>	<b>98</b>	<b>43</b>	<b>87</b>	<b>24</b>	<b>100</b>	<b>475</b>	<b>100</b>
<b>Bowl Types: Bowls only</b>																
Heel bowls	1	100	27	90	110	96	119	93	20	71	19	79	3	75	299	91
Spur bowls			3	10	5	4	9	7	8	29	5	21	1	25	31	9
<b>Totals:</b>	<b>1</b>	<b>100</b>	<b>30</b>	<b>100</b>	<b>115</b>	<b>100</b>	<b>128</b>	<b>100</b>	<b>28</b>	<b>100</b>	<b>24</b>	<b>100</b>	<b>4</b>	<b>100</b>	<b>330</b>	<b>100</b>
<b>All Marks</b>																
Stamped heels			4	9	13	8	35	23	9	23	1	2			62	13
Moulded heels									2	5	13	30	2	9	17	4
Moulded spurs									1	3	4	9	1	4	6	1
Stamped bowl marks																
Moulded bowl marks																
Stamped stems					1	1	1	1	1	3	5	12	18	78	26	5
Stem twists																
Unmarked fragments	1	100	41	91	154	92	119	77	26	67	20	47	2	9	363	77
<b>Totals:</b>	<b>1</b>	<b>100</b>	<b>45</b>	<b>100</b>	<b>168</b>	<b>100</b>	<b>155</b>	<b>100</b>	<b>39</b>	<b>100</b>	<b>43</b>	<b>100</b>	<b>23</b>	<b>100</b>	<b>474</b>	<b>100</b>
<b>Marks: Heel Bowls</b>																
Stamped heel mark			4	15	13	12	35	29	9	45	1	5			62	21
Moulded heel mark									2	10	13	68	3	100	18	8
Stamped bowl mark																
Moulded bowl mark																
Unmarked bowls	1	100	23	85	97	88	84	71	9	45	5	26			219	73
<b>Totals:</b>	<b>1</b>	<b>100</b>	<b>27</b>	<b>100</b>	<b>110</b>	<b>100</b>	<b>119</b>	<b>100</b>	<b>20</b>	<b>100</b>	<b>19</b>	<b>100</b>	<b>3</b>	<b>100</b>	<b>299</b>	<b>100</b>
<b>Marks: Spur Bowls</b>																
Moulded spur mark									1	13	4	80			5	18
Stamped bowl mark																
Moulded bowl mark																
Unmarked bowls			3	100	5	100	9	100	7	88	1	20	1	100	26	84
<b>Totals:</b>	<b>0</b>	<b>0</b>	<b>3</b>	<b>100</b>	<b>5</b>	<b>100</b>	<b>9</b>	<b>100</b>	<b>8</b>	<b>100</b>	<b>5</b>	<b>100</b>	<b>1</b>	<b>100</b>	<b>31</b>	<b>100</b>
<b>Marks: Unidentified Bowls</b>																
Stamped bowl marks																
Moulded bowl marks																
Unmarked bowls			12	100	51	100	26	100	10	100	13	100	2	100	114	100
<b>Totals:</b>	<b>0</b>	<b>0</b>	<b>12</b>	<b>100</b>	<b>51</b>	<b>100</b>	<b>26</b>	<b>100</b>	<b>10</b>	<b>100</b>	<b>13</b>	<b>100</b>	<b>2</b>	<b>100</b>	<b>114</b>	<b>100</b>
<b>Marks: Stems</b>																
Stamped stem mark					1	50	1	100			5	83	19	100	26	90
Stem twist																
Unmarked stems			1	100	1	50					1	17			3	10
<b>Totals:</b>	<b>0</b>	<b>0</b>	<b>1</b>	<b>100</b>	<b>2</b>	<b>100</b>	<b>1</b>	<b>100</b>	<b>0</b>	<b>0</b>	<b>6</b>	<b>100</b>	<b>19</b>	<b>100</b>	<b>29</b>	<b>100</b>
<b>Burnishing: Bowls &amp; stems</b>																
No burnishing	1	100	37	90	148	95	117	87	32	97	39	95	8	80	382	92
Poor			1	2	2	1	3	2							6	1
Average			1	2	2	1	10	7	1	3					14	3
Good					3	2	4	3			2	5	2	20	11	3
Fine			2	5	1	1									3	1
<b>Totals:</b>	<b>1</b>	<b>100</b>	<b>41</b>	<b>100</b>	<b>156</b>	<b>100</b>	<b>134</b>	<b>100</b>	<b>33</b>	<b>100</b>	<b>41</b>	<b>100</b>	<b>10</b>	<b>100</b>	<b>416</b>	<b>100</b>
<b>Stem bore: Bowls &amp; stems</b>																
Bore 3/64											1	3			1	0
Bore 4/64					2	1			1	3	4	12	2	13	9	2
Bore 5/64			1	2	2	1	6	5	12	38	18	55	13	87	52	13
Bore 6/64			14	31	33	22	40	31	15	47	10	30			112	28
Bore 7/64	1	100	27	80	90	61	67	53	4	13					189	47
Bore 8/64			3	7	21	14	14	11							38	9

**(Table 2 continued)**

<b>Bore 9/64</b>																	
<b>Totals:</b>	<b>1</b>	<b>100</b>	<b>45</b>	<b>100</b>	<b>148</b>	<b>100</b>	<b>127</b>	<b>100</b>	<b>32</b>	<b>100</b>	<b>33</b>	<b>100</b>	<b>15</b>	<b>100</b>	<b>401</b>	<b>100</b>	
<b>Milling: Bowls only</b>																	
<b>M4</b>			<b>10</b>	<b>71</b>	<b>36</b>	<b>33</b>	<b>7</b>	<b>7</b>							<b>53</b>	<b>20</b>	
<b>M3</b>					<b>16</b>	<b>16</b>	<b>8</b>	<b>9</b>							<b>24</b>	<b>9</b>	
<b>M2</b>			<b>3</b>	<b>21</b>	<b>7</b>	<b>6</b>	<b>31</b>	<b>33</b>	<b>2</b>	<b>11</b>					<b>43</b>	<b>17</b>	
<b>M1</b>			<b>1</b>	<b>7</b>	<b>7</b>	<b>6</b>	<b>11</b>	<b>12</b>	<b>2</b>	<b>11</b>					<b>21</b>	<b>8</b>	
<b>M0</b>	<b>1</b>	<b>100</b>			<b>43</b>	<b>39</b>	<b>37</b>	<b>39</b>	<b>14</b>	<b>78</b>	<b>20</b>	<b>100</b>	<b>4</b>	<b>100</b>	<b>119</b>	<b>46</b>	
<b>Totals:</b>	<b>1</b>	<b>100</b>	<b>14</b>	<b>100</b>	<b>109</b>	<b>100</b>	<b>94</b>	<b>100</b>	<b>18</b>	<b>100</b>	<b>20</b>	<b>100</b>	<b>4</b>	<b>100</b>	<b>260</b>	<b>100</b>	
<b>Bowl Crosses: Bowls only</b>																	
<b>Type X</b>																	
<b>Type +</b>																	
<b>No bowl cross</b>	<b>1</b>	<b>100</b>	<b>21</b>	<b>100</b>	<b>121</b>	<b>100</b>	<b>98</b>	<b>100</b>	<b>25</b>	<b>100</b>	<b>24</b>	<b>100</b>	<b>3</b>	<b>100</b>	<b>293</b>	<b>100</b>	
<b>Totals:</b>	<b>1</b>	<b>100</b>	<b>21</b>	<b>100</b>	<b>121</b>	<b>100</b>	<b>98</b>	<b>100</b>	<b>25</b>	<b>100</b>	<b>24</b>	<b>100</b>	<b>3</b>	<b>100</b>	<b>293</b>	<b>100</b>	

**TABLE 3 – Sites for North-east Yorkshire**

	County	Parish	Site name	1580-1610	1610-1640	1640-1660	1660-1690	1690-1720	1700-1750	1750-1800	Totals
1	Middlesborough	Tolleby	1972 excavations		1	3	1	2	2		9
2	N. Yorkshire	Brotton	Brotton Playing Field			1	8	4	1		14
3	N. Yorkshire	Cowlem				4	12				16
4	N. Yorkshire	Helmeley	Helmeley Castle		1	6	1	3	1		12
5	N. Yorkshire	Helmeley	Rievaulx Abbey		2		9	3			14
6	N. Yorkshire	Hutton le Hole	Unprovenanced material in Ryedale Museum			1	3	1		1	6
7	N. Yorkshire	Malton	St Leonard's Church			1	4	1			6
8	N. Yorkshire	Malton			1		2				3
9	N. Yorkshire	Marrick						3			3
10	N. Yorkshire	Nr Whitby	Meadowfields			1					1
11	N. Yorkshire	Nun Appletton?	Nun Appletton House			20	5	2			27
12	N. Yorkshire	Pickering	Unprovenanced material in Beck Isle Museum		3	4	5	1			13
13	N. Yorkshire	Rosedale	111-113 High Street			2					2
14	N. Yorkshire	Rosedale Abbey	Rosedale Abbey Excavations 1970			1					1
15	N. Yorkshire	Scarborough	119 Longwestgate			1			1		2
16	N. Yorkshire	Scarborough	18-22 Sepulchre Street		1	1	3		1		6
17	N. Yorkshire	Scarborough	24-26 The Bolts					1			1
18	N. Yorkshire	Scarborough	35 Castlegate				8	2			10
19	N. Yorkshire	Scarborough	4 North Street				1		2		3
20	N. Yorkshire	Scarborough	Auborough Street			3			2	5	10
21	N. Yorkshire	Scarborough	Castle Hill			56	3				59
22	N. Yorkshire	Scarborough	Cooks Row			1					1
23	N. Yorkshire	Scarborough	Cross Street				3				3
24	N. Yorkshire	Scarborough	Excavations at Scarborough Castle 1977		3	4	15	4	1	1	28
25	N. Yorkshire	Scarborough	Gardens near tram station				1				1
26	N. Yorkshire	Scarborough	Garfield Road				1				1
27	N. Yorkshire	Scarborough	Paradise Street				6	8	12	1	27
28	N. Yorkshire	Scarborough	Princess Street						2		2
29	N. Yorkshire	Scarborough	Scarborough Barbican		24	26	17	1	3		71
30	N. Yorkshire	Scarborough	Springfield					1	2	5	8
31	N. Yorkshire	Scarborough	Springfield, Quaker Mtg House			1	2		4		7
32	N. Yorkshire	Scarborough	St Thomas' Street				2	3	1		6
33	N. Yorkshire	Scarborough	Unprovenanced but probably from Scarborough			1					1
34	N. Yorkshire	Skelton	Orchard Field		3	11	4	2	1		21
35	N. Yorkshire	Thirsk	32 Topcliffe Road			1	1				2
36	N. Yorkshire	Thirsk	Mount Grace Priory		3	7	3				13
37	N. Yorkshire	Unknown	Unprovenanced material in Thirsk Museum				1		1		2
38	N. Yorkshire	Wharham	Wharham Percy	1	1	13	18	2	5	1	39
39	N. Yorkshire	Whitby	Grattdale Church			1					1
40	N. Yorkshire	Whitby	Pannett Park			1	2				3
41	N. Yorkshire	Whitby	Unprovenanced material in Whitby Museum		2	8	4	1		1	16
42	N. Yorkshire	Whitby	Whitby Abbey		1	2	7	1	1	1	13

(Table 3 continued)

County	Parish	Site name	1500-1610	1610-1640	1640-1660	1660-1690	1690-1720	1720-1750	1750-1800	Totals	
43	Redcar & Cleveland	Boulby	Old Boulby Manor	1			1	1	4	7	
44	Redcar & Cleveland	Guisborough	Westgate	1	2	3		1		7	
45	Redcar & Cleveland	Skelton	Boroughgate Excavation 1970			1				1	
46	Redcar & Cleveland	Skelton	Skelton general	1	1					2	
47	Stockton-on-Tees	Egglecliffe	Church Yard				1			1	
48	Stockton-on-Tees	Yarm	Garden of 6 Sefton Way			1				1	
49	Stockton-on-Tees	Yarm	Yarm general		3	6	2	7	6	24	
50	Stockton-on-Tees	Yarm	YHS83 excavations		1		2			3	
51	Stockton-on-Tees		Thorneby-Yarm gas pipeline				1			1	
			Totals:	1	49	189	161	53	52	26	531

TABLE 4 – Collections for North-east Yorkshire

Collection Name	1500-1610	1610-1640	1640-1660	1660-1690	1690-1720	1720-1750	1750-1800	Totals			
1 Beck Isle Museum of Rural Life		3	4	5	1			13			
2 Cleveland County Archeology Unit		1	4	1	4	2		12			
3 English Heritage	1	1	12	15	2	5	2	38			
4 English Heritage Archaeological Store		10	19	32	11	3	1	76			
5 Kelham Island Industrial Museum			1					1			
6 North West Archeological Trust		24	26	17	1	3		71			
7 Not known			5	13	3			21			
8 Ryedale Folk Museum		1	2	3	1		1	8			
9 Scarborough Borough Council		1	63	29	15	27	11	146			
10 Sewerby Hall				3				3			
11 Tees Archeology		2	9	18	7	10	9	55			
12 Thirsk Museum			1	2		1		4			
13 West Yorkshire Archeological Services			20	5	2			27			
14 Whitby Museum		2	11	7	1		1	22			
15 White Collection				1	1			2			
16 York Archeological Trust			1	4	2		1	8			
17 York Castle Museum		1		2				3			
18 York Excavation Group		3	11	4	2	1		21			
			Totals:	1	49	189	161	53	52	26	531



**TABLE 5 – Imports for North-east Yorkshire**

Place of origin	1500-1610	1610-1640	1640-1660	1660-1680	1680-1720	1720-1750	1750-1800	Totals
Gatehead				6	2			8
London						5		5
North-east England					2			2
Southampton					1			1
Sunderland							2	2
The Netherlands		4	21		9	4		38
Totals:	0	4	21	6	14	9	2	56

**TABLE 1 – All fragments for York and its environs**

York and its environs	c1580-1610			c1610-1640			c1640-1660			c1660-1690			c1690-1720			c1700-1750		
	Unpub	Pub	Imp	Unpub	Pub	Imp	Unpub	Pub	Imp	Unpub	Pub	Imp	Unpub	Pub	Imp	Unpub	Pub	Imp
<b>Count: Bowls &amp; stems</b>																		
Bowls	3			144	1	4	372	6	1	475	22	1	187	5	1	73	15	1
Stems							3	1	2	1		1	1		1	3	22	1
<b>Totals:</b>	<b>3</b>	<b>0</b>	<b>0</b>	<b>144</b>	<b>1</b>	<b>4</b>	<b>375</b>	<b>7</b>	<b>3</b>	<b>476</b>	<b>22</b>	<b>2</b>	<b>188</b>	<b>5</b>	<b>2</b>	<b>76</b>	<b>37</b>	<b>2</b>
<b>Bowl Types: Bowls only</b>																		
Heel bowls	3			132	1	4	326	6		448	22	1	174	5	1	68	15	1
Spur bowls				3			4		1	7			1			2		
Unidentified bowls				9			42			20			12			3		
<b>Totals:</b>	<b>3</b>	<b>0</b>	<b>0</b>	<b>144</b>	<b>1</b>	<b>4</b>	<b>372</b>	<b>6</b>	<b>1</b>	<b>475</b>	<b>22</b>	<b>1</b>	<b>187</b>	<b>5</b>	<b>1</b>	<b>73</b>	<b>15</b>	<b>1</b>
<b>Bowl Marks</b>																		
Stamped heel mark				91	1	3	59	6		229	22	1	126	4	1	5		1
Moulded heel mark													5			11		1
Moulded spur mark																2		
Stamped bowl mark							1		1							1		
Moulded bowl mark																		
Unmarked bowls	3			53		1	312			246			58	1		54	13	1
<b>Totals:</b>	<b>3</b>	<b>0</b>	<b>0</b>	<b>144</b>	<b>1</b>	<b>4</b>	<b>372</b>	<b>6</b>	<b>1</b>	<b>475</b>	<b>22</b>	<b>1</b>	<b>187</b>	<b>5</b>	<b>1</b>	<b>73</b>	<b>15</b>	<b>1</b>
<b>Stem Marks</b>																		
Stamped stem mark							2	1	2	2		1	1		1	3	22	1
Stem twist																		
Unmarked stems							1											
<b>Totals:</b>	<b>0</b>	<b>0</b>	<b>0</b>	<b>0</b>	<b>0</b>	<b>0</b>	<b>3</b>	<b>1</b>	<b>2</b>	<b>2</b>	<b>0</b>	<b>1</b>	<b>1</b>	<b>0</b>	<b>1</b>	<b>3</b>	<b>22</b>	<b>1</b>
<b>Burnishing: Bowls &amp; stems</b>																		
No burnishing	2			44		1	232			251			141	1		69	18	1
Poor				1			15			9								
Average				4			21			84			7			2		
Good				3		1	10		1	44			4			1		
Fine				73		2	21			16		1	10		2			
Can't tell	1			19	1		76	7	2	72	22	1	26	4		4	19	1
<b>Totals:</b>	<b>3</b>	<b>0</b>	<b>0</b>	<b>144</b>	<b>1</b>	<b>4</b>	<b>375</b>	<b>7</b>	<b>3</b>	<b>476</b>	<b>22</b>	<b>2</b>	<b>188</b>	<b>5</b>	<b>2</b>	<b>76</b>	<b>37</b>	<b>2</b>
<b>Stem bore: bowls &amp; stems</b>																		
Bore 3/64										1			7		1	10		
Bore 4/64																		
Bore 5/64							8			27			60			40		1
Bore 6/64				10			85		1	92		1	62		1	16		
Bore 7/64	3			40		4	138			214			31					
Bore 8/64				73			67			59			1					
Bore 9/64				1			6			7	1							
Unmeasurable				20	1		71	7	2	76	21	1	27	5		10	37	1
<b>Totals:</b>	<b>3</b>	<b>0</b>	<b>0</b>	<b>144</b>	<b>1</b>	<b>4</b>	<b>375</b>	<b>7</b>	<b>3</b>	<b>476</b>	<b>22</b>	<b>2</b>	<b>188</b>	<b>5</b>	<b>2</b>	<b>76</b>	<b>37</b>	<b>2</b>
<b>Milling: Bowls only</b>																		
M4				94		4	108		1	59			1					
M3				5			18			42		1	6					
M2				1			18			94			25					
M1				1			16			56			50		1			
M0	2			12			154			146			77	1		64	13	
Milling on all surviving rim				15			25	4		25	21		7	4		1		
Unmeasurable	1			16	1		33	2		53	1		21			8	2	1
<b>Totals:</b>	<b>3</b>	<b>0</b>	<b>0</b>	<b>144</b>	<b>1</b>	<b>4</b>	<b>372</b>	<b>6</b>	<b>1</b>	<b>475</b>	<b>22</b>	<b>1</b>	<b>187</b>	<b>5</b>	<b>1</b>	<b>73</b>	<b>15</b>	<b>1</b>
<b>Bowl Crosses: Bowls only</b>																		
Type X																		
Type +																		
No bowl cross	2			127		4	351		1	435		1	179		1	72		1
Can't tell	1			17	1		21	6		40	22		8	5		1	15	
<b>Totals:</b>	<b>3</b>	<b>0</b>	<b>0</b>	<b>144</b>	<b>1</b>	<b>4</b>	<b>372</b>	<b>6</b>	<b>1</b>	<b>475</b>	<b>22</b>	<b>1</b>	<b>187</b>	<b>5</b>	<b>1</b>	<b>73</b>	<b>15</b>	<b>1</b>

(Table 1 continued)

York and its environs	c1750-1800			Totals:			TOTALS
	Unpub	Pub	Imp	Unpub	Pub	Imp	
<b>Count: Bowls &amp; stems</b>							
Bowls	6			1280	49	8	1309
Stems	3		2	11	23	7	34
<b>Totals:</b>	<b>9</b>	<b>0</b>	<b>2</b>	<b>1271</b>	<b>72</b>	<b>15</b>	<b>1343</b>
<b>Bowl Types: Bowls only</b>							
Heel bowls				1151	49	7	1200
Spur bowls	5			22	0	1	22
Unidentified bowls	1			87	0	0	87
<b>Totals:</b>	<b>6</b>	<b>0</b>	<b>0</b>	<b>1260</b>	<b>49</b>	<b>8</b>	<b>1309</b>
<b>Bowl Marks</b>							
Stamped heel mark				510	34	5	544
Moulded heel mark				16	1	0	17
Moulded spur mark	1			3	0	0	3
Stamped bowl mark				2	0	1	2
Moulded bowl mark				0	0	0	0
Unmarked bowls	5			729	14	2	743
<b>Totals:</b>	<b>6</b>	<b>0</b>	<b>0</b>	<b>1260</b>	<b>49</b>	<b>8</b>	<b>1309</b>
<b>Stem Marks</b>							
Stamped stem mark	3		2	11	23	7	34
Stem twist				0	0	0	0
Unmarked stems				1	0	0	1
<b>Totals:</b>	<b>3</b>	<b>0</b>	<b>2</b>	<b>12</b>	<b>23</b>	<b>7</b>	<b>35</b>
<b>Burnishing: Bowls &amp; stems</b>							
No burnishing	6			745	19	2	764
Poor				25	0	0	25
Average				118	0	0	118
Good				62	0	2	62
Fine				120	0	5	120
Can't tell	3		2	201	53	6	254
<b>Totals:</b>	<b>9</b>	<b>0</b>	<b>2</b>	<b>1271</b>	<b>72</b>	<b>15</b>	<b>1343</b>
<b>Stem bore: bowls &amp; stems</b>							
Bore 3/64	1			1	0	0	1
Bore 4/64	1			19	0	1	19
Bore 5/64	2			137	0	1	137
Bore 6/64				265	0	3	265
Bore 7/64				426	0	4	426
Bore 8/64				200	0	0	200
Bore 9/64				14	1	0	15
Unmeasurable	5		2	209	71	6	280
<b>Totals:</b>	<b>9</b>	<b>0</b>	<b>2</b>	<b>1271</b>	<b>72</b>	<b>15</b>	<b>1343</b>
<b>Milling: Bowls only</b>							
M4				262	0	5	262
M3				71	0	1	71
M2				138	0	0	138
M1				123	0	1	123
M0	6			481	14	0	475
Milling on all surviving rim				73	29	0	102
Unmeasurable				132	6	1	138
<b>Totals:</b>	<b>6</b>	<b>0</b>	<b>0</b>	<b>1280</b>	<b>49</b>	<b>8</b>	<b>1309</b>
<b>Bowl Crosses: Bowls only</b>							
Type X				0	0	0	0
Type +				0	0	0	0
No bowl crosses	6			1172	0	8	1172
Can't tell				88	49	0	137
<b>Totals:</b>	<b>6</b>	<b>0</b>	<b>0</b>	<b>1260</b>	<b>49</b>	<b>8</b>	<b>1309</b>

**TABLE 2 – Yorkshire products from York and its environs**

York and environs	c1590-1610		c1610-1640		c1640-1660		c1660-1690		c1690-1720		c1700-1750		c1750-1800		TOTAL	
	Total	%	Total	%	Total	%	Total	%	Total	%	Total	%	Total	%	Total	%
<b>Count: All fragments</b>																
Bowls (all fragments)	3	100	141	100	377	99	496	100	191	100	87	78	6	88	1301	98
Stems					2	1	0				24	22	1	14	27	2
<b>Totals:</b>	<b>3</b>	<b>100</b>	<b>141</b>	<b>100</b>	<b>379</b>	<b>100</b>	<b>496</b>	<b>100</b>	<b>191</b>	<b>100</b>	<b>111</b>	<b>100</b>	<b>7</b>	<b>100</b>	<b>1328</b>	<b>100</b>
<b>Bowl Types: Bowls only</b>																
Heel bowls	3	100	129	98	332	99	469	99	178	99	82	98			1193	98
Spur bowls			3	2	3	1	7	1	1	1	2	2	5	100	21	2
<b>Totals:</b>	<b>3</b>	<b>100</b>	<b>132</b>	<b>100</b>	<b>335</b>	<b>100</b>	<b>476</b>	<b>100</b>	<b>179</b>	<b>100</b>	<b>84</b>	<b>100</b>	<b>5</b>	<b>100</b>	<b>1214</b>	<b>100</b>
<b>All Marks</b>																
Stamped heels			89	63	65	17	250	50	129	68	6	5			539	41
Moulded Heels									5	3	12	11			17	1
Moulded spurs											2	2	1	14	3	0
Stamped bowl marks											1	1			1	0
Moulded bowl marks																
Stamped stems					1		2						1		28	
Stem twists																
Unmarked fragments	3	100	52	37	313	83	245	49	57	30	66	59	5	71	741	58
<b>Totals:</b>	<b>3</b>	<b>100</b>	<b>141</b>	<b>100</b>	<b>379</b>	<b>100</b>	<b>497</b>	<b>100</b>	<b>191</b>	<b>100</b>	<b>111</b>	<b>78</b>	<b>7</b>	<b>88</b>	<b>1329</b>	<b>98</b>
<b>Marks: Heel Bowls</b>																
Stamped heel mark			89	89	65	20	250	53	129	72	6	7			539	45
Moulded heel mark									5	3	12	15			17	1
Stamped bowl mark											1	1			1	0
Moulded bowl mark																
Unmarked bowls	3	100	40	31	267	80	219	47	44	25	63	77			636	53
<b>Totals:</b>	<b>3</b>	<b>100</b>	<b>129</b>	<b>100</b>	<b>332</b>	<b>100</b>	<b>469</b>	<b>100</b>	<b>178</b>	<b>100</b>	<b>82</b>	<b>100</b>	<b>0</b>	<b>0</b>	<b>1193</b>	<b>100</b>
<b>Marks: Spur Bowls</b>																
Moulded spur mark											2	100	1	20	3	14
Stamped bowl mark																
Moulded bowl mark																
Unmarked bowls			3	100	3	100	7	100	1	100			4	80	18	85.7
<b>Totals:</b>	<b>0</b>	<b>0</b>	<b>3</b>	<b>100</b>	<b>3</b>	<b>100</b>	<b>7</b>	<b>100</b>	<b>1</b>	<b>100</b>	<b>2</b>	<b>100</b>	<b>5</b>	<b>100</b>	<b>21</b>	<b>100</b>
<b>Marks: Unidentified Bowls</b>																
Stamped bowl mark																
Moulded bowl mark																
Unmarked bowls			9	100	42	100	20	100	12	100	3	100	1	100	87	100
<b>Totals:</b>	<b>0</b>	<b>0</b>	<b>9</b>	<b>100</b>	<b>42</b>	<b>100</b>	<b>20</b>	<b>100</b>	<b>12</b>	<b>100</b>	<b>3</b>	<b>100</b>	<b>1</b>	<b>100</b>	<b>87</b>	<b>100</b>
<b>Marks: Stems</b>																
Stamped stem mark					1		1				24		1		27	
Stem twist																
Unmarked stems					1										1	
<b>Totals:</b>	<b>0</b>	<b>0</b>	<b>0</b>	<b>0</b>	<b>2</b>	<b>N/A</b>	<b>1</b>	<b>N/A</b>	<b>0</b>	<b>N/A</b>	<b>24</b>	<b>N/A</b>	<b>1</b>	<b>N/A</b>	<b>28</b>	<b>N/A</b>
<b>Burnishing: Bowls &amp; stems</b>																
No burnishing	2	100	43	38	232	78	251	62	142	88	86	97	6	100	762	71
Poor			1	1	15	5	9	2							25	2
Average			4	3	21	8	84	21	7	4	2	2			118	11
Good			2	2	9	3	44	11	4	3	1	1			60	6
Fine			71	58	21	6	15	4	8	5					115	5
<b>Totals:</b>	<b>2</b>	<b>100</b>	<b>121</b>	<b>100</b>	<b>298</b>	<b>100</b>	<b>403</b>	<b>100</b>	<b>161</b>	<b>100</b>	<b>89</b>	<b>100</b>	<b>6</b>	<b>100</b>	<b>1080</b>	<b>96</b>
<b>Stem bore: Bowls &amp; stems</b>																
Bore 3/64													1	25	1	0
Bore 4/64							1	0	6	4	10	15	1	25	18	2
Bore 5/64					8	3	27	7	60	38	39	60	2	50	136	13
Bore 6/64			10	8	84	28	91	23	61	38	16	25			262	25
Bore 7/64	3	100	36	30	138	46	214	54	31	19					422	40
Bore 8/64			73	61	67	22	59	15	1	0					200	19

(Table 2 continued)

Bore 9/64			1	1	6	2	8	2						15	1	
Totals:	3	100	120	100	303	100	400	100	159	100	65	100	4	100	1054	100
<b>Milling: Bows only</b>																
M4			90	83	107	34	59	15	1	1					257	24
M3			5	4	18	8	41	11	8	3					70	7
M2			1	1	18	8	94	24	25	18					138	13
M1			1	1	16	5	56	14	49	31					122	11
M0	2	100	12	11	154	49	146	36	78	49	77	100	6	100	475	45
Totals:	2	100	109	100	313	100	396	100	159	100	77	100	6	100	1062	100
<b>Bowl Crosses: Bows only</b>																
Type X																
Type +																
No bowl cross	2	100	123	100	350	100	435	100	178	100	71	100	5	100	1164	100
Totals:	2	100	123	100	350	100	435	100	178	100	71	100	5	100	1164	100

**TABLE 3 – Sites for York and its environs**

	County	Parish	Site name	1500-1610	1610-1640	1640-1660	1660-1680	1680-1720	1720-1750	1750-1800	Totals
1	North Yorkshire	Acaster Malbis	Local fields		14	79	130	90	28	2	343
2	North Yorkshire	Acaster Malbis	Post Office flower bed			1					1
3	North Yorkshire	Earswick					2				2
4	North Yorkshire	Easrick	Unprovenanced material from Easrick			2	1	1			4
5	North Yorkshire	Heslington	Sand & gravel pit		1	2		1			4
6	North Yorkshire	New Earswick						1			1
7	Unknown	Unknown	U/P material held by the YAT			1	2	1		1	5
8	York	York	115 Stokton Lane			1	2	1			4
9	York	York	118-126 Walmgate		4	1					5
10	York	York	1-2 Tower Street (Castle Garage)		3	25	16	10	4	1	59
11	York	York	12-18 Swinegate		1	3	1				5
12	York	York	125 Stokton Lane			1	1				2
13	York	York	13-17 Coney Street			1	4	8	3		16
14	York	York	14 Little Stonegate		1	2					3
15	York	York	14-20 Blossom Street			4	7		1		12
16	York	York	16-20 Blossom Street			1					1
17	York	York	1-9 Bridge Street				4	1			5
18	York	York	2 Coffee Yard			1	5	2	2		10
19	York	York	21-33 Aldwark		2	14	52	2	1		71
20	York	York	23 Clifford Street		1	7	2	2		1	13
21	York	York	29-31 Skeldergate			1	2				3
22	York	York	37 Bishophill Senior		2	7	2				11
23	York	York	5 Rougier Street		1	2					3
24	York	York	50 Piccadilly				1				1
25	York	York	57 Bootham		2	5	6	1	1		15
26	York	York	58-59 Skeldergate			5	2	5			12
27	York	York	6-28/21-7 Union Terrace		5		2		1		8
28	York	York	84 Piccadilly				1				1
29	York	York	9 Blake Street		1	4	4	1			10
30	York	York	Albion Wharf	1	2	12	16	5	7		43
31	York	York	Albion Wharf, 23-28 Skeldergate						3	1	4
32	York	York	Allotments				1				1
33	York	York	Assize Court	1	1	8	9				19
34	York	York	Barbican carpark			1					1
35	York	York	Bedern Chapel		1	2					3
36	York	York	Bishophorpe					1			1
37	York	York	Blossom Street				1				1
38	York	York	Castlegate						1		1
39	York	York	Coffee Yard			21	3	1		2	27
40	York	York	County Hospital, Monkgate			1	2	5			8
41	York	York	Crown Court, York Castle			3	11	2	1		17
42	York	York	East side of the city wall			2	1				3

(Table 3 continued)

	County	Parish	Site name	1500-1610	1610-1640	1640-1660	1660-1690	1690-1720	1720-1750	1750-1800	Totals
43	York	York	Falcon Street					1			1
44	York	York	Hungate		1	5	21	4			31
45	York	York	Ideal Laundry, Trinity Lane			2					2
46	York	York	Judges Lodging, Lendal	1	82	72	33	14	1		203
47	York	York	Merchant Taylor's Hall			1		3	2		6
48	York	York	Museum Gardens		1	1					2
49	York	York	Museum Street, Lendal		1	1					2
50	York	York	NER Station				1				1
51	York	York	Peasholme Green			4	2				6
52	York	York	Purey Cust Nuffield Hospital			1					1
53	York	York	Rear of 13-19 Grape Lane				1				1
54	York	York	Skeldergate, City Mills			3	10	15	15		43
55	York	York	South Corner Tower, Roman Fortress					1	37		38
56	York	York	St Andrewgate/Spenn Lane		3	4	3			1	11
57	York	York	St Andrews Church			1	5		1		7
58	York	York	St Georges Field car park		1	1	3	2			7
59	York	York	St Helens Square			1					1
60	York	York	St Mary Castlegate				1				1
61	York	York	St Saviours Church						1		1
62	York	York	St Savioursgate		1	4	4				9
63	York	York	Stakis Hotel site (Leedhams)			2	1				3
64	York	York	Swinegate sewer		1	1	2				4
65	York	York	The Bedern, south-west		2	9	14	1			26
66	York	York	Unprovenanced but probably from York		5	31	58	8	3		105
67	York	York	Unprovenanced from Yorkshire Museum, York		5	17	41	3			66
68	York	York	Walmgate Bar				1				1
69	York	York	York Castle			1					1
70	York	York	York Castle Car park				4				4
			Totals:	3	145	382	498	193	113	9	1343

**TABLE 4 – Collections for York and its environs**

Collection Name	1500-1610	1610-1640	1640-1660	1660-1680	1680-1720	1700-1750	1750-1800	Totals
1 Devey Collection			1					1
2 Jennings Collection				1				1
3 Kelham Island Industrial Museum		1		1				2
4 Not known		1	9	25	6	37		78
5 Raines Collection		14	79	130	90	28	2	343
6 Whitby Museum		1	2					3
7 York Archaeological Trust	2	118	232	228	81	44	7	712
8 York Castle Museum	1	10	59	113	16	4		203
<b>Totals:</b>	<b>3</b>	<b>145</b>	<b>382</b>	<b>498</b>	<b>193</b>	<b>113</b>	<b>9</b>	<b>1343</b>

**TABLE 5 – Imports for York and its environs**

Piece of Origin	1500-1610	1610-1640	1640-1660	1660-1680	1680-1720	1700-1750	1750-1800	Totals
Chester				1		2		3
?Cambridge		1						1
Rainford			1					1
Unknown, but not a Yorkshire form				1				1
The Netherlands		3	2		2		2	9
<b>Totals:</b>	<b>0</b>	<b>4</b>	<b>3</b>	<b>2</b>	<b>2</b>	<b>2</b>	<b>2</b>	<b>15</b>



**TABLE 1 – All fragments of Yorkshire products found outside the county**

Yorkshire Products	c1580-1610		c1610-1640		c1640-1660		c1660-1690		c1690-1720		c1700-1750	
	Unpub	Pub	Unpub	Pub	Unpub	Pub	Unpub	Pub	Unpub	Pub	Unpub	Pub
<b>Count: Bowls &amp; stems</b>												
Bowls			2		20		70	16	6		12	
Stems							8		1		10	1
<b>Totals:</b>	<b>0</b>	<b>0</b>	<b>2</b>	<b>0</b>	<b>20</b>	<b>0</b>	<b>78</b>	<b>16</b>	<b>7</b>	<b>0</b>	<b>22</b>	<b>1</b>
<b>Bowl Types: Bowls only</b>												
Heel bowls			2		19		70	16	5		8	
Spur bowls												
Unidentified bowls					1				1		4	
<b>Totals:</b>	<b>0</b>	<b>0</b>	<b>2</b>	<b>0</b>	<b>20</b>	<b>0</b>	<b>70</b>	<b>16</b>	<b>6</b>		<b>12</b>	<b>0</b>
<b>Bowl and stem marks</b>												
Stamped heel mark			2		18		36	4	2			
Moulded heel mark									1		10	
Moulded spur mark												
Stamped bowl mark												
Moulded bowl mark												
Unmarked bowls					2		30	11	3		2	
Stamped stem mark							12	1	1		10	1
Stem twist												
Unmarked stems												
<b>Totals:</b>	<b>0</b>	<b>0</b>	<b>2</b>	<b>0</b>	<b>20</b>	<b>0</b>	<b>78</b>	<b>16</b>	<b>7</b>	<b>0</b>	<b>22</b>	<b>1</b>
<b>Burnishing: Bowls &amp; stems</b>												
No burnishing					4		21		4		11	
Poor												
Average							2					
Good							2		1			
Fine												
Very fine												
Can't tell			2		16		53	16	2		11	1
<b>Totals:</b>	<b>0</b>	<b>0</b>	<b>2</b>	<b>0</b>	<b>20</b>	<b>0</b>	<b>78</b>	<b>16</b>	<b>7</b>	<b>0</b>	<b>22</b>	<b>1</b>
<b>Stem bore: Bowls &amp; stems</b>												
Bore 3/64												
Bore 4/64												
Bore 5/64					1		8				11	
Bore 6/64									3		2	
Bore 7/64					1		8	2	2		1	
Bore 8/64					1		6	8				
Bore 9/64					1		1					
Unmeasurable			2		16		55	6	2		8	1
<b>Totals:</b>	<b>0</b>		<b>2</b>		<b>20</b>	<b>0</b>	<b>78</b>	<b>16</b>	<b>7</b>	<b>0</b>	<b>22</b>	<b>1</b>
<b>Milling: Bowls only</b>												
M4					1		4					
M3								2				
M2					1		1					
M1								1				
M0					1		4		1		4	
Milling on all surviving rim					1		20	2				
Unmeasurable			2		16		38	14	5		8	
<b>Totals:</b>	<b>0</b>	<b>0</b>	<b>2</b>	<b>0</b>	<b>20</b>	<b>0</b>	<b>70</b>	<b>16</b>	<b>6</b>	<b>0</b>	<b>12</b>	<b>0</b>
<b>Bowl Crosse: Bowls only</b>												
Type X												
Type +												
No bowl cross					2		17		3		7	
Can't tell			2		18		53	16	3		5	
<b>Totals:</b>	<b>0</b>		<b>2</b>	<b>0</b>	<b>20</b>	<b>0</b>	<b>70</b>	<b>16</b>	<b>6</b>	<b>0</b>	<b>12</b>	<b>0</b>

(Table 1 continued)

Yorkshire Products	c1750-1800		Totals:		TOTALS
	Unpub	Pub	Unpub	Pub	
<b>Count: Bows &amp; stems</b>					
Bows			110	16	126
Stems	1		20	1	21
<b>Totals:</b>	<b>1</b>	<b>0</b>	<b>130</b>	<b>17</b>	<b>147</b>
<b>Bowl Types: Bows only</b>					
Heel bows			104	16	120
Spur bows			0	0	0
Unidentified bows			6	0	6
<b>Totals:</b>	<b>0</b>	<b>0</b>	<b>110</b>	<b>16</b>	<b>126</b>
<b>Bowl and stem marks</b>					
Stamped heel mark			58	4	62
Moulded heel mark			11	0	11
Moulded spur mark			0	0	0
Stamped bowl mark			0	0	0
Moulded bowl mark			0	0	0
Unmarked bows			37	11	48
Stamped stem mark	1		24	2	26
Stem twist			0	0	0
Unmarked stems			0	0	0
<b>Totals:</b>	<b>1</b>	<b>0</b>	<b>130</b>	<b>17</b>	<b>147</b>
<b>Burnishing: Bows &amp; stems</b>					
No burnishing			40	0	40
Poor			0	0	0
Average			2	0	2
Good			3	0	3
Fine			0	0	0
Very fine			0	0	0
Can't tell	1		85	17	102
<b>Totals:</b>	<b>1</b>		<b>130</b>	<b>17</b>	<b>147</b>
<b>Stem bore: Bows &amp; stems</b>					
Bore 3/64			0	0	0
Bore 4/64			0	0	0
Bore 5/64	1		21	0	21
Bore 6/64			5	0	5
Bore 7/64			12	2	14
Bore 8/64			7	8	15
Bore 9/64			2	0	2
Unmeasurable			83	7	90
<b>Totals:</b>	<b>1</b>		<b>130</b>	<b>17</b>	<b>147</b>
<b>Milling: Bows only</b>					
M4			5	0	5
M3			2	0	2
M2			2	0	2
M1			1	0	1
M0			10	0	10
Milling on all surviving rim			21	2	23
Unmeasurable			69	14	83
<b>Totals:</b>	<b>0</b>	<b>0</b>	<b>110</b>	<b>16</b>	<b>126</b>
<b>Bowl Crosses: Bows only</b>					
Type X			0	0	0
Type +			0	0	0
No bowl cross			29	0	29
Can't tell			81	16	97
<b>Totals:</b>	<b>0</b>	<b>0</b>	<b>110</b>	<b>16</b>	<b>126</b>

**TABLE 2 – Measurable Yorkshire products found outside the county**

Yorkshire Products	c1580-1610		c1610-1640		c1640-1660		c1660-1690		c1690-1720		c1700-1750		c1750-1800		TOTAL	
	Total	%	Total	%	Total	%	Total	%	Total	%	Total	%	Total	%	Total	%
<b>Count: All Bows &amp; stems</b>																
Bows			2	100	20	100	86	91	6	88	12	52			126	86
Stems							8	9	1	14	11	48	1	100	21	14
<b>Totals:</b>	<b>0</b>	<b>0</b>	<b>2</b>	<b>100</b>	<b>20</b>	<b>100</b>	<b>94</b>	<b>100</b>	<b>7</b>	<b>100</b>	<b>23</b>	<b>100</b>	<b>1</b>	<b>100</b>	<b>147</b>	<b>100</b>
<b>Bowl Types: Bows only</b>																
Heel bows			2	100	19	100	86	100	4	100	8	100			119	100
Spur bows																
<b>Totals:</b>	<b>0</b>	<b>0</b>	<b>2</b>	<b>100</b>	<b>19</b>	<b>100</b>	<b>86</b>	<b>100</b>	<b>4</b>	<b>100</b>	<b>8</b>	<b>100</b>	<b>0</b>	<b>0</b>	<b>119</b>	<b>100</b>
<b>Marks: Bows</b>																
Stamped heel mark			2	100	18	90	40	43	2	29					62	42
Moulded heel mark									1	14	10	43			11	7
Moulded spur mark																
Stamped bowl mark																
Moulded bowl mark																
Unmarked bows					2	10	41	44	3	43	2	9	1	100	49	33
Stamped stem mark							13	14	1	14	11	48			25	17
Stem twist																
Unmarked stems																
<b>Totals:</b>	<b>0</b>	<b>0</b>	<b>2</b>	<b>100</b>	<b>20</b>	<b>100</b>	<b>94</b>	<b>100</b>	<b>7</b>	<b>100</b>	<b>23</b>	<b>100</b>	<b>1</b>	<b>100</b>	<b>147</b>	<b>100</b>
<b>Burnishing: Bows &amp; stems</b>																
No burnishing					4	100	21	84	4	100	11	100			40	91
Poor							2	8							2	5
Average							2	8							2	5
Good							2	8								
Fine																
Very fine															0	0
<b>Totals:</b>	<b>0</b>	<b>0</b>	<b>0</b>	<b>0</b>	<b>4</b>	<b>100</b>	<b>25</b>	<b>100</b>	<b>4</b>	<b>100</b>	<b>11</b>	<b>100</b>	<b>0</b>	<b>0</b>	<b>44</b>	<b>100</b>
<b>Stem bore: Bows &amp; stems</b>																
Bore 3/64																
Bore 4/64																
Bore 5/64					1	25	8	28			11	79	1	100	21	38
Bore 6/64									3	60	2	14			5	9
Bore 7/64					1	25	8	28	2	40	1	7			12	22
Bore 8/64					1	25	14	45							15	27
Bore 9/64					1	25	1	3							2	4
<b>Totals:</b>	<b>0</b>	<b>0</b>	<b>0</b>	<b>0</b>	<b>4</b>	<b>100</b>	<b>31</b>	<b>100</b>	<b>5</b>	<b>100</b>	<b>14</b>	<b>100</b>	<b>1</b>	<b>100</b>	<b>55</b>	<b>100</b>
<b>Milling: Bows only</b>																
M4					1	33	4	36							5	26
M3						0	2	18							2	11
M2					1	33	1	9							2	11
M1							1	9							1	5
M0					1	33	3	27	1	100	4	100			9	47
<b>Totals:</b>	<b>0</b>	<b>0</b>	<b>0</b>	<b>0</b>	<b>3</b>	<b>100</b>	<b>11</b>	<b>100</b>	<b>1</b>	<b>100</b>	<b>4</b>	<b>100</b>	<b>0</b>	<b>0</b>	<b>19</b>	<b>100</b>
<b>Bowl Crosses: Bows only</b>																
Type X																
Type +																
No bowl cross					1	100	17	100	3	100	7	100			28	100
<b>Totals:</b>	<b>0</b>	<b>0</b>	<b>0</b>	<b>0</b>	<b>1</b>	<b>100</b>	<b>17</b>	<b>100</b>	<b>3</b>	<b>100</b>	<b>7</b>	<b>100</b>	<b>0</b>	<b>0</b>	<b>28</b>	<b>100</b>

**TABLE 3 – Sites for Yorkshire products found outside the county**

	Country	County	Parish	Site name	c1580-1610	c1610-1640	c1640-1660	c1660-1690	c1690-1720	c1700-1750	c1750-1800	Totals
1	England	Cheshire	Chester	Hamilton Place				1				1
2	England	City of Bristol	Bristol	Clifton					1			1
3	England	County Durham	Chester-le-Street	Middle Chare				1	3	1		5
4	England	County Durham	Durham	Unprovenanced but probably from Durham area				1				1
5	England	Cumbria	Carlisle	Unprovenanced but probably from Carlisle area			1	3	2			6
6	England	Cumbria	Kendal	UP but probably from Kendal Area					11			11
7	England	Cumbria	Penrith	Clifton Hall					2			2
8	England	Derbyshire	Boleover	Boleover Church						3		3
9	England	Derbyshire	Castleton	Odin's Mine				2				2
10	England	Derbyshire	Middleton						1			1
11	England	Greater London	London	Finds from the river					1			1
12	England	Greater London	London	River Thames, Queenhithe Dock						2		2
13	England	Hertlepool	Hertlepool	Church Walk Excavation 1972						1		1
14	England	Lincolnshire	South Kelsey	Winghale Priory					7			7
15	England	Merseyside	Rainford	Church Field				1				1
16	England	Norfolk	Norwich	Norwich Castle						1		1
17	England	North Lincolnshire	Alkborough	Walcot Westcroft					1	2		3
18	England	North Lincolnshire	Brigg	Morley's Yard						1		1
19	England	North Lincolnshire	Scawby	Horse Paddocks					4	1	6	11
20	England	North Lincolnshire	South Ferryby							1		1
21	England	Northumberland	Lindisfame	Unprovenanced material			1					1
22	England	Nottinghamshire	Newark area	Unprovenanced					1			1
23	England	Stockton-on-Tees	Stockton	Unprovenanced but probably from Stockton on Tees area							1	1
24	England	Unknown	Unknown	Unprovenanced but probably from London				1			1	2
25	England	Unknown	Unknown	Unprovenanced material in Salford Museum				1	3			4
26	England	West Midlands	Nottinghamshire	River Idle dredgings, 1988						7		7
27	Sweden	Unknown	Fakun						1			1
28	Sweden	Unknown	Hullestad	Wreck of the Kronen on E coast of Oland					25			25
29	Sweden	Unknown	Jonkoping						1			1
30	Sweden	Unknown	Stockholm	Music Academy cellar					1			1
31	Sweden	Unknown	Stockholm	Stockholm Archipelago					2			2
32	Sweden	Unknown	Tyreso						2			2
33	USA	Maryland	Calvert County	Smith Site (18CV92)						1		1
34	USA	Maryland	Jamestown	Jamestown Rediscovery				10	1			11

(Table 3 – continued)

	Country	County	Parish	Site name	c1580-1610	c1610-1640	c1640-1660	c1660-1690	c1690-1720	c1700-1750	c1750-1800	Totals
35	USA	Maryland	St Mary's City	Chancellors Point (18ST1-62)				2				2
36	USA	Maryland	St Mary's City	Countrys House ST 1-13				3				3
37	USA	Maryland	St Mary's City	John Hicks Site ST 1-22				1				1
38	USA	Maryland	St Mary's City	Smiths Ordinary (18ST1-13)				1				1
39	USA	Maryland	St Mary's City	Smith's Townland site				9				9
40	USA	Maryland	St Mary's County	Mattapeny (18ST390)				1				1
41	USA	Virginia	Hampton	Pentran III (44HT44)					2			2
42	USA	Virginia	James City	Green Spring Plantation (44JC9)					1			1
43	USA	Virginia	Prince George County	Site 44PG92					1			1
44	USA	Virginia	Westmoreland	Nominy Plantation (44WM12)					4			4
				Totals:	0	2	20	94	7	23	1	147

**TABLE 4 – Collections for Yorkshire products found outside the county**

Collection Name	c1580-1610	c1610-1640	c1640-1660	c1660-1690	c1690-1720	c1700-1750	c1750-1800	Totals
1 Abbot Hall Art Gallery & Museum				11				11
2 Akerhagen Collection				2				2
3 Assoc for the preservation of Virginia Antiquities			10	1				11
4 Bowes Museum				1	3	1		5
5 Carlisle Archaeological Unit			4	1				5
6 Carlisle Museum & Art Gallery		1		1				2
7 Colonial Williamsburg				2				2
8 Department of Archaeology, Sheffield						3		3
9 Elkins Collection					2			2
10 Flowerdeew Hundred				1				1
11 Fox Collection				1				1
12 Grosvenor Museum			1					1
13 Historic St Mary's City				7				7
14 Kelfham Island Industrial Museum				1				1
15 Maryland Archaeological Conservation Laboratory				2				2
16 NCTPA			1					1
17 Newark Museum				1				1
18 Not known				42		1	1	44
19 Oswald Collection		1						1
20 Salford Museum & Art Gallery			1	3				4
21 Scaunthorpe Museum & Art Gallery				12	1	10		23
22 Sheffield City Museum			2					2
23 Tees Archaeology					1			1
24 The Bassettlaw Museum						7		7
25 Virginia Department of Historic Resources				3				3
26 Virginia Foundation for Archaeological Research				1				1
27 Wilberforce House Museum			1			1		2
28 York Castle Museum				1				1
<b>Totals:</b>	<b>0</b>	<b>2</b>	<b>20</b>	<b>94</b>	<b>7</b>	<b>23</b>	<b>1</b>	<b>147</b>

**TABLE 5 – Possible Yorkshire products from Oswald’s stamp index (1991)**

Ref	Page	Country	Site/Location	Date	Mark	Comments
H1	8	England	Richmond, Hubbard Coll	1650-1670	?H	Possible IH with fleur-de-lys in lozenge
AB2	3b	England	Marston Moor	1660-1680	AB	
AB2	6	England	Rainford	1660-1680	AB	BAR VII
AB2	10b	England	Richmond, Hubbard Coll	1650-1670	AB	
AB2	11b	England	Richmond, Hubbard Coll	1680-1710	AB	
AB2	1	England	Ripon Museum	1660-1680	AB	
AB2	1	England	Tuile House Museum, Carlisle	1660-1680	AB	
HR9	3	England	Richmond, Hubbard Coll	1660-1680	HR	
HS8	1a	England	Binfield Coll, Exeter Museum	1660-1680	HS	
IC11a	9	England	Binfield Coll, Exeter Museum	1660-1680	IC	
IC11a	8	England	Bragge Coll, British Museum	1650-1670	IC	
IC11a	9	England	Bragge Coll, British Museum	1660-1680	IC	
IC11a	10	England	Bragge Coll, British Museum	1660-1680	IC	
IC11a	8	England	Moorfields	1650-1670	IC	
IT9a	2a	England	Ripon Museum	1640-1660	IT	Crowned
IT9a	2c	England	Ripon Museum	1660-1680	IT	
IW10b	7i	England	Richmond, Hubbard Coll	1650-1670	IW	
IW10b	7a	England	Trowden, East Lincs	1660-1690	IW	
RB24	6a	England	Binfield Album, Exeter Mus	1650-1720	RB	
RB24	10	England	Kettleby Thorpe, Lincs	1680-1720	RB	
RF12	4c	England	Leicester Museum	1660-1680	RF	
RF12	1b	England	Meols, Cheshire	1660-1680	RF	
RF12	2	England	Middleton Moor, Yorkshire, B Smith Coll	1660-1680	RF	Spur pipe with bowl mark
WW26a	4	England	Newark Excavations	1774	WW	Will Wild
AB2	7	Jamaica	Port Royal	1660-1690	AB	
AB2	9a	Jamaica	Port Royal	1650-1670	AB	
IW10b	7d	USA	Colonial Williamsburg	1660-1690	IW	
RB24	1a	USA	Bennett's Point, Maryland	1680-1720	RB	

# Appendix 8: Results from the bowl height and width ANOVA tests

## One-way ANOVA

### Results for: 1640-1660 bowl width

#### Analysis of Variance

Source	DF	SS	MS	F	P
Factor	5	16.40	3.28	3.18	0.009
Error	199	204.91	1.03		
Total	204	221.30			

#### Individual 95% CIs For Mean Based on Pooled StDev

Level	N	Mean	StDev
West	34	18.809	0.769
East	37	19.081	0.917
South	33	19.455	1.182
NW	18	19.472	1.334
NE	49	19.592	1.049
York	34	19.103	0.911

Pooled StDev = 1.015

### Results for: 1660-1690 bowl width

#### Analysis of Variance

Source	DF	SS	MS	F	P
Factor	5	104.70	20.94	6.39	0.000
Error	331	1084.39	3.28		
Total	336	1189.09			

#### Individual 95% CIs For Mean Based on Pooled StDev

Level	N	Mean	StDev
West	57	22.439	1.570
East	65	22.438	1.946
South	62	21.960	1.876
NW	44	22.500	1.536
NE	66	23.409	2.262
York	43	23.500	1.150

Pooled StDev = 1.810

### Results for: 1690-1720 bowl width

#### Analysis of Variance

Source	DF	SS	MS	F	P
Factor	5	21.48	4.30	3.97	0.003
Error	95	102.78	1.08		
Total	100	124.26			

#### Individual 95% CIs For Mean Based on Pooled StDev

Level	N	Mean	StDev
West	21	21.224	1.119
East	19	21.816	1.030
South	18	20.778	0.732
NW	12	20.750	1.340
NE	9	21.833	1.225
York	22	21.818	0.920

Pooled StDev = 1.040



# One-way ANOVA

## Results for: 1640-1660 bowl height

### Analysis of Variance

Source	DF	SS	MS	F	P
Factor	5	70.24	14.05	3.37	0.006
Error	200	834.62	4.17		
Total	205	904.86			

### Individual 95% CIs For Mean Based on Pooled StDev

Level	N	Mean	StDev
West	34	31.456	1.860
East	37	32.022	2.511
South	33	33.197	2.239
NW	19	32.526	2.366
NE	49	32.459	1.773
York	34	31.603	1.570

Pooled StDev = 2.043

## Results for: 1660-1690 bowl height

### Analysis of Variance

Source	DF	SS	MS	F	P
Factor	5	218.15	43.63	9.14	0.000
Error	330	1575.92	4.78		
Total	335	1794.06			

### Individual 95% CIs For Mean Based on Pooled StDev

Level	N	Mean	StDev
West	57	35.133	1.836
East	65	36.900	2.346
South	62	35.758	2.324
NW	43	35.151	2.240
NE	66	37.091	2.340
York	43	35.523	1.819

Pooled StDev = 2.185

## Results for: 1690-1720 bowl height

### Analysis of Variance

Source	DF	SS	MS	F	P
Factor	5	260.0	52.0	3.58	0.005
Error	95	1379.0	14.5		
Total	100	1639.0			

### Individual 95% CIs For Mean Based on Pooled StDev

Level	N	Mean	StDev
West	21	44.476	3.265
East	19	48.263	4.733
South	18	43.889	4.006
NW	12	43.750	4.003
NE	9	46.167	4.265
York	22	46.000	2.828

Pooled StDev = 3.810